



OcNOS®
**Open Compute
Network Operating System
for Service Providers
Version 6.6.0**

Layer 2 Guide
February 2025

© 2025 IP Infusion Inc. All Rights Reserved.

This documentation is subject to change without notice. The software described in this document and this documentation are furnished under a license agreement or nondisclosure agreement. The software and documentation may be used or copied only in accordance with the terms of the applicable agreement. No part of this publication may be reproduced, stored in a retrieval system, or transmitted in any form or any means electronic or mechanical, including photocopying and recording for any purpose other than the purchaser's internal use without the written permission of IP Infusion Inc.

IP Infusion Inc.
3979 Freedom Circle
Suite 900
Santa Clara, California 95054
<http://www.ipinfusion.com/>

For support, questions, or comments via E-mail, contact:

support@ipinfusion.com

Trademarks:

IP Infusion and OcNOS are trademarks or registered trademarks of IP Infusion. All other trademarks, service marks, registered trademarks, or registered service marks are the property of their respective owners.

Use of certain software included in this equipment is subject to the IP Infusion, Inc. End User License Agreement at <http://www.ipinfusion.com/license>. By using the equipment, you accept the terms of the End User License Agreement.

Contents

Preface	14
IP Maestro Support	14
Audience	14
Conventions	14
Chapter Organization	14
Related Documentation	14
Feature Availability	15
Migration Guide	15
Support	15
Comments	15
Command Line Interface	16
Overview	16
Command Line Interface Help	16
Command Completion	17
Command Abbreviations	17
Command Line Errors	17
Command Negation	18
Syntax Conventions	18
Variable Placeholders	19
Command Description Format	20
Keyboard Operations	20
Show Command Modifiers	21
String Parameters	24
Command Modes	24
Transaction-based Command-line Interface	26
Layer 2 Configuration Guide	27
CHAPTER 1 Link Layer Discovery Protocol Configuration	28
Topology	28
Interface Mode TLV	28
Global Mode TLV	38
LLDP-MED	40
LLDP Over SVI, LAG, and Sub-Interface	45
CHAPTER 2 Provider Bridging Configuration	53
Single Provider Bridge Configuration	53
Two Provider Bridge Configuration	56
Layer 2 Protocol Tunneling (L2PT/L2CP Tunneling)	61
Provider Bridging with VLAN Translation	63
Provider Bridging QoS Configuration	74
Provider Bridging Untagged-pep Configuration	83
CHAPTER 3 Provider Bridging Configuration (SVLAN)	87
Customer-Network Port (CNP)	87

STAG-based Interface	87
Port-based Interface	87
Topology	88
Configuration	88
Validation	90
CHAPTER 4 Spanning Tree Protocol Configuration	91
Configurations	91
CHAPTER 5 RSTP Configuration	102
Configuration	102
CHAPTER 6 MSTP Configuration	112
Configuration	112
CHAPTER 7 Disable Spanning Tree Configuration	128
Disabling MSTP Configuration	128
STP Configuration	133
RSTP Configuration	136
CHAPTER 8 VLAN Configuration	140
Configuring VLAN Tags	140
CHAPTER 9 Disabling Native VLAN Configuration	147
Topology	147
Configuration	147
Configuring acceptable-frame-type vlan-tagged on ingress interface	149
CHAPTER 10 Disabling Native VLAN Configuration on Trunk mode	151
Topology	151
Configuration	151
Configuring Disable-Native-VLAN on Trunk mode	153
CHAPTER 11 802.1X Configuration	155
Switch Configuration	155
CHAPTER 12 Link Aggregation Configuration	157
Topology	157
Dynamic LAG Configuration	157
Static LAG Configuration	160
Static LAG Minimum Link Configuration	162
Static-LAG Minimum Bandwidth Configuration	165
Dynamic-LAG Minimum Link Configuration	168
Dynamic LAG Minimum Bandwidth Configuration	171
LACP Minimum-Link, Minimum-Bandwidth on Dynamic and Static Channel-Groups with MLAG	175
LACP Force-Up	188
Port-Channel Weight	193
CHAPTER 13 LACP Aggregator Force-up	200
Overview	200
LACP Aggregator Force-up for Dynamic LAG Configuration	200

LACP Aggregator Force-up for MLAG Configuration	202
Implementation Examples.	206
CLI Commands.	207
Glossary.	208
CHAPTER 14 MLAG Configuration	209
Overview	209
MLAG Active-Active Dynamic Configuration	220
Static Configuration	229
ARP ACL Configuration.	237
CHAPTER 15 PW Redundancy with MLAG Configuration	244
Topology	244
Uplink Interface and OSPF Configuration.	245
RSVP Global Configuration	248
RSVP-LSP Configuration	250
T-LDP Configuration	252
MLAG Configuration	253
VPWS PW Redundancy Configuration	255
CHAPTER 16 Traffic Mirroring Configuration	262
SPAN Overview	262
Port Mirroring Configuration	263
Port Mirroring Configuration	267
CHAPTER 17 Port Security Configuration	272
Secured MACs Learned Dynamically	272
Secured MAC Addresses Learned Statically	275
Static Mode	276
CHAPTER 18 Private VLAN Configuration	279
Topology	279
Configure PVLAN Trunk and Promiscuous Trunk Port.	279
Configure PVLAN Trunk and Promiscuous Access Port	282
CHAPTER 19 Layer 2 Subinterface Configuration.	287
Topology	287
CHAPTER 20 Layer 2 EPL and EVPL Configuration	293
Topology	293
Configure L2 EVPL	296
Topology	296
CHAPTER 21 Bridging Support Over Layer2 Sub Interface	301
Topology	301
CHAPTER 22 Layer 2 Control Protocols Tunneling	306
Overview	306
L2CP Tunneling for Provider Bridging.	306
L2CP Tunneling for VPLS/VPWS/Hybrid (Bridge+VPWS).	307
L2CP Tunneling for VXLAN	307
L2CP Behavior	308

Default L2CP configuration	309
Operational Concepts and Scenarios	310
CHAPTER 23 ErrDisable for Link-Flapping Configuration	313
Topology	313
Automatic Recovery	313
Log Message	314
Manual Recovery	315
Errdisable at the Interface Level	316
CHAPTER 24 Unidirectional Link Detection Configuration	317
Topology	317
S1	317
S2	318
Validation	318
CHAPTER 25 MAC Authentication Bypass	322
CHAPTER 26 Traffic Segmentation-Protected Port	325
Topology	325
Isolated-Promiscuous Configuration	325
Validation	326
Isolated-Isolated Configuration	329
Validation	329
CHAPTER 27 MLAG with Provider Bridging Configuration	333
L2CP with MLAG-Provider Bridging Configuring	347
CHAPTER 28 Support IGMP Snooping for Provider Bridge	351
Overview	351
Prerequisites	351
Configuration	352
Abbreviations	360
Layer 2 Command Reference	361
CHAPTER 1 Link Layer Discovery Protocol v2 Commands	362
clear lldp counters	363
lldp-agent	364
debug lldp	365
lldp run	366
lldp tlv basic-mgmt	367
lldp tlv med	368
lldp tlv ieee-8021-org-specific	369
lldp tlv ieee-8023-org-specific	370
lldp tlv-select basic-mgmt	371
lldp tlv-select ieee-8021-org-specific	372
lldp tlv-select ieee-8023-org-specific	373
set lldp agt-circuit-id	374
set lldp chassis-id-tlv	375
set lldp chassis locally-assigned	376

set lldp disable	377
set lldp enable	378
set lldp locally-assigned	379
set lldp management-address-tlv	380
set lldp med-devtype	381
set lldp msg-tx-hold	382
set lldp port-id-tlv	383
set lldp timer	384
set lldp too-many-neighbors	386
set lldp tx-fast-init	388
set lldp tx-max-credit	389
show debugging lldp	390
show lldp neighbors	391
show lldp interface	394
snmp restart lldp	396
CHAPTER 2 Provider Bridging Commands	397
bridge protocol provider-mstp	398
bridge protocol provider-rstp	399
cvlan registration table	400
cvlan svlan	401
dot1ad ethertype	403
show cvlan registration table	404
switchport customer-edge	405
switchport customer-edge hybrid	406
switchport customer-edge trunk	407
switchport customer-edge vlan registration	408
switchport customer-network allowed vlan	409
switchport customer-network vlan	410
switchport mode	411
switchport mode customer-edge	412
switchport mode customer-edge hybrid acceptable-frame-type	413
switchport provider-network	414
switchport provider-network isolated-vlan	415
switchport provider-network vlan translation	416
vlan type	418
vlan type customer	419
CHAPTER 3 Bridge Commands	420
bridge acquire	421
bridge address	422
bridge ageing	424
bridge encapsulation dot1q	425
bridge forward-time	426
bridge hello-time	427
bridge max-age	428
bridge max-hops	429
bridge priority	430

bridge shutdown	431
bridge transmit-holdcount	432
bridge-group	433
bridge-group path-cost	434
bridge-group priority	435
clear allowed-ethertype	436
clear mac address-table	437
show allowed-ethertype	439
show bridge	440
show interface switchport	441
show mac address-table count bridge	443
show mac address-table bridge	445
switchport	447
switchport allowed ethertype	448
CHAPTER 4 Spanning Tree Protocol Commands	449
bridge cisco-interoperability	451
bridge instance	452
bridge instance priority	453
bridge instance vlan	454
bridge multiple-spanning-tree	456
bridge protocol ieee	457
bridge protocol mstp	458
bridge protocol rstp	459
bridge rapid-spanning-tree	460
bridge region	461
bridge revision	462
bridge spanning-tree	463
bridge spanning-tree errdisable-timeout	464
bridge spanning-tree force-version	465
bridge spanning-tree pathcost	466
bridge spanning-tree portfast	467
bridge te-msti	469
bridge te-msti vlan	470
bridge-group instance	471
bridge-group instance path-cost	472
bridge-group instance priority	473
bridge-group path-cost	474
bridge-group priority	475
bridge-group spanning-tree	476
clear spanning-tree detected protocols	477
clear spanning-tree statistics	478
customer-spanning-tree customer-edge path-cost	479
customer-spanning-tree customer-edge priority	480
customer-spanning-tree forward-time	481
customer-spanning-tree hello-time	482
customer-spanning-tree max-age	483

customer-spanning-tree priority	484
customer-spanning-tree provider-edge path-cost	485
customer-spanning-tree provider-edge priority	486
customer-spanning-tree transmit-holdcount	487
debug mstp	488
show debugging mstp	490
show spanning-tree	491
show spanning-tree mst	495
show spanning-tree statistics	497
spanning-tree autoedge	500
spanning-tree edgeport	501
spanning-tree guard	502
spanning-tree instance restricted-role	503
spanning-tree instance restricted-tcn	504
spanning-tree link-type	505
spanning-tree mst configuration	506
spanning-tree bpdu-filter	507
spanning-tree bpdu-guard	508
spanning-tree restricted-domain-role	509
spanning-tree restricted-role	510
spanning-tree restricted-tcn	511
spanning-tree te-msti configuration	512
storm-control	513
CHAPTER 5 Link Aggregation Commands	515
channel-group mode	516
clear lacp	518
debug lacp	519
interface po	520
interface sa	521
lacp destination-mac	522
lacp force-up	523
lacp port-priority	524
lacp system-priority	525
lacp timeout	526
port-channel min-links	527
port-channel weight	528
show debugging lacp	530
show etherchannel	531
show lacp sys-id	534
show lacp-counter	535
show port etherchannel	536
show static-channel-group	539
show static-channel load-balance	540
snmp restart lacp	541
static-channel-group	542

CHAPTER 6	Multi-chassis Link Aggregation Commands	544
	clear mcec statistics	545
	domain-address	546
	debug mcec	547
	domain hello timeout	548
	domain priority	549
	domain-system-number	550
	intra-domain-link	551
	intra-domain-peer	552
	mcec domain configuration	553
	mlag	554
	mode	555
	show mcec statistics	556
	show mlag detail	557
	show mlag domain	559
	show mlag stp-synchronization status	562
	show spanning-tree mlag operational-config	563
	show spanning-tree mlag sync-detail	564
	switchover type	565
CHAPTER 7	Traffic Mirroring Commands	566
	monitor session	567
	monitor session shut	568
	source interface	569
	source vlan	570
	destination interface	571
	no shut	572
	shut	573
	filter	574
	description	576
	remote destination	577
	show monitor	578
	show monitor session	579
	show filter	581
	show monitor running configuration	582
CHAPTER 8	VLAN and Private VLAN Commands	583
	global-bridge-vlan-check enable	584
	private-vlan association	585
	private-vlan community	586
	private-vlan isolated	587
	private-vlan primary	588
	show vlan	589
	show vlan brief	591
	show vlan classifier	592
	switchport access	594
	switchport hybrid	595
	switchport mode	596

switchport mode hybrid acceptable-frame-type	597
switchport trunk allowed	598
switchport mode trunk disable-native-vlan	600
switchport trunk native	601
switchport mode private-vlan	602
switchport private-vlan association-trunk	603
switchport private-vlan host-association	604
switchport private-vlan mapping	605
feature vlan classifier	606
vlan classifier activate	607
vlan classifier group	608
vlan classifier rule ipv4	609
vlan classifier rule mac	610
vlan classifier rule proto	611
vlan database	613
vlan VLAN_RANGE bridge	614
vlan VLAN_RANGE type customer	615
vlan VLAN_RANGE type service	616
CHAPTER 9 802.1x Commands	618
auth-mac	619
auth-mac mode	620
auth-mac system-auth-ctrl	621
auth-port	622
debug dot1x	623
dot1x mac-auth-bypass	624
dot1x port-control	625
dot1x protocol-version	626
dot1x quiet-period	627
dot1x reauthentication	628
dot1x reauthMax	629
dot1x system-auth-ctrl	630
dot1x timeout re-authperiod	631
dot1x timeout server-timeout	632
dot1x timeout supp-timeout	633
dot1x timeout tx-period	634
ip radius source-interface	635
key-string	636
key-string encrypted	637
radius-server dot1x host	638
retransmit	639
show debugging dot1x	640
show dot1x	641
show mab all	645
timeout	646
CHAPTER 10 Layer 2 Subinterface Commands	647
bridge-domain	648

cross-connect	649
dot1ad ethertype	650
encapsulation	651
interface switchport	654
no subinterfaces	655
rewrite	656
show bridge-domain	658
show cross-connect	659
CHAPTER 11 Port Security Commands	660
port-security	661
show port-security	662
switchport port-security	663
switchport port-security logging	664
switchport port-security mac-address	665
switchport port-security maximum	667
CHAPTER 12 Layer 2 Control Protocols Tunneling Commands	668
clear l2protocol interface counters	669
l2protocol	670
l2protocol encapsulation dest-mac	671
show l2protocol interface counters	672
show l2protocol processing interface	673
CHAPTER 13 Errdisable Commands	674
errdisable cause	675
errdisable link-flap-setting	676
errdisable storm-control	677
errdisable mac-move-limit	678
errdisable timeout	679
link-flap errdisable	680
show errdisable details	681
show interface errdisable status	682
CHAPTER 14 Unidirectional Link Detection Commands	683
udld	684
udld message-time	685
udld mode	686
udld state	687
show udld	688
show udld interface	689
CHAPTER 15 Link Layer Discovery Protocol Commands	690
lldp debug	691
lldp (disable enable) default-agent	692
lldp ip	693
lldp tlv	694
set lldp chassis-id-tlv	695
set lldp disable	696
set lldp enable	697

set lldp locally-assigned	698
set lldp management-address-tlv	699
set lldp msg-tx-hold	700
set lldp system-description	701
set lldp system-name	702
set lldp timer	703
set lldp too-many-neighbors	704
show lldp	705
snmp restart lldp	706
Index	707

Preface

This guide describes how to configure OcNOS.

IP Maestro Support

Monitor devices running OcNOS Release 6.3.4-70 and above using IP Maestro software.

Audience

This guide is intended for network administrators and other engineering professionals who configure OcNOS.

Conventions

[Table 1](#) on page 14 shows the conventions used in this guide.

Table 1: Conventions

Convention	Description
Italics	Emphasized terms; titles of books
Note:	Special instructions, suggestions, or warnings
<code>monospaced type</code>	Code elements such as commands, parameters, files, and directories

Chapter Organization

The chapters in command references are organized as described in [Command Description Format](#).

The chapters in configuration guides are organized into these major sections:

- An overview that explains a configuration in words
- Topology with a diagram that shows the devices and connections used in the configuration
- Configuration steps in a table for each device where the left-hand side shows the commands you enter and the right-hand side explains the actions that the commands perform
- Validation which shows commands and their output that verify the configuration

Related Documentation

For information about installing OcNOS, see the *Installation Guide* for your platform.

Feature Availability

The features described in this document that are available depend upon the OcnOS SKU that you purchased. See the *Feature Matrix* for a description of the OcnOS SKUs.

Migration Guide

Check the *Migration Guide* for configuration changes to make when migrating from one version of OcnOS to another.

Support

For support-related questions, contact support@ipinfusion.com.

Comments

If you have comments, or need to report a problem with the content, contact techpubs@ipinfusion.com.

Command Line Interface

This chapter introduces the OcNOS Command Line Interface (CLI) and how to use its features.

Overview

You use the CLI to configure, monitor, and maintain OcNOS devices. The CLI is text-based and each command is usually associated with a specific task.

You can give the commands described in this manual locally from the console of a device running OcNOS or remotely from a terminal emulator such as `putty` or `xterm`. You can also use the commands in scripts to automate configuration tasks.

Command Line Interface Help

You access the CLI help by entering a full or partial command string and a question mark “?”. The CLI displays the command keywords or parameters along with a short description. For example, at the CLI command prompt, type:

```
> show ?
```

The CLI displays this keyword list with short descriptions for each keyword:

```
show ?
  application-priority      Application Priority
  arp                      Internet Protocol (IP)
  bfd                      Bidirectional Forwarding Detection (BFD)
  bgp                      Border Gateway Protocol (BGP)
  bi-lsp                   Bi-directional lsp status and configuration
  bridge                   Bridge group commands
  ce-vlan                  COS Preservation for Customer Edge VLAN
  class-map                Class map entry
  cli                      Show CLI tree of current mode
  clns                    Connectionless-Mode Network Service (CLNS)
  control-adjacency        Control Adjacency status and configuration
  control-channel          Control Channel status and configuration
  cspf                    CSPF Information
  customer                Display Customer spanning-tree
  cvlan                   Display CVLAN information
  debugging                Debugging functions
  etherchannel            LACP etherchannel
  ethernet                Layer-2
  ...
```

If you type the ? in the middle of a keyword, the CLI displays help for that keyword only.

```
> show de?
debugging  Debugging functions
```

If you type the ? in the middle of a keyword, but the incomplete keyword matches several other keywords, OcNOS displays help for all matching keywords.

```
> show i? (CLI does not display the question mark).
interface  Interface status and configuration
ip         IP information
isis      ISIS information
```

Command Completion

The CLI can complete the spelling of a command or a parameter. Begin typing the command or parameter and then press the tab key. For example, at the CLI command prompt type `sh`:

```
> sh
```

Press the tab key. The CLI displays:

```
> show
```

If the spelling of a command or parameter is ambiguous, the CLI displays the choices that match the abbreviation. Type `show i` and press the tab key. The CLI displays:

```
> show i
  interface  ip          ipv6          isis
> show i
```

The CLI displays the `interface` and `ip` keywords. Type `n` to select `interface` and press the tab key. The CLI displays:

```
> show in
> show interface
```

Type `?` and the CLI displays the list of parameters for the `show interface` command.

```
> show interface
  IFNAME  Interface name
  |       Output modifiers
  >      Output redirection
<cr>
```

The CLI displays the only parameter associated with this command, the `IFNAME` parameter.

Command Abbreviations

The CLI accepts abbreviations that uniquely identify a keyword in commands. For example:

```
> sh int xe0
```

is an abbreviation for:

```
> show interface xe0
```

Command Line Errors

Any unknown spelling causes the CLI to display the error `Unrecognized command` in response to the `?`. The CLI displays the command again as last entered.

```
> show dd?
% Unrecognized command
> show dd
```

When you press the Enter key after typing an invalid command, the CLI displays:

```
(config)#router ospf here
                        ^
% Invalid input detected at '^' marker.
```

where the `^` points to the first character in error in the command.

If a command is incomplete, the CLI displays the following message:

```
> show
% Incomplete command.
```

Some commands are too long for the display line and can wrap mid-parameter or mid-keyword, as shown below. This does *not* cause an error and the command performs as expected:

```
area 10.10.0.18 virtual-link 10.10.0.19 authent
ication-key 57393
```

Command Negation

Many commands have a `no` form that resets a feature to its default value or disables the feature. For example:

- The `ip address` command assigns an IPv4 address to an interface
- The `no ip address` command removes an IPv4 address from an interface

Syntax Conventions

[Table 2](#) on page 18 describes the conventions used to represent command syntax in this reference.

Table 2: Syntax conventions

Convention	Description	Example
monospaced font	Command strings entered on a command line	<code>show ip ospf</code>
lowercase	Keywords that you enter exactly as shown in the command syntax.	<code>show ip ospf</code>
UPPERCASE	See Variable Placeholders	<code>IFNAME</code>
()	Optional parameters, from which you must select one. Vertical bars delimit the selections. Do not enter the parentheses or vertical bars as part of the command.	<code>(A.B.C.D <0-4294967295>)</code>
()	Optional parameters, from which you select one or none. Vertical bars delimit the selections. Do not enter the parentheses or vertical bars as part of the command.	<code>(A.B.C.D <0-4294967295>)</code>
()	Optional parameter which you can specify or omit. Do not enter the parentheses or vertical bar as part of the command.	<code>(IFNAME)</code>
{ }	Optional parameters, from which you must select one or more. Vertical bars delimit the selections. Do not enter the braces or vertical bars as part of the command.	<code>{intra-area <1-255> inter-area <1-255> external <1-255>}</code>

Table 2: Syntax conventions (Continued)

Convention	Description	Example
[]	Optional parameters, from which you select zero or more. Vertical bars delimit the selections. Do not enter the brackets or vertical bars as part of the command.	[<1-65535> AA:NN internet local-AS no-advertise no-export]
?	Nonrepeatable parameter. The parameter that follows a question mark can only appear once in a command string. Do not enter the question mark as part of the command.	?route-map WORD
.	Repeatable parameter. The parameter that follows a period can be repeated more than once. Do not enter the period as part of the command.	set as-path prepend .<1-65535>

Variable Placeholders

Table 3 on page 19 shows the tokens used in command syntax use to represent variables for which you supply a value.

Table 3: Variable placeholders

Token	Description
WORD	A contiguous text string (excluding spaces)
LINE	A text string, including spaces; no other parameters can follow this parameter
IFNAME	Interface name whose format varies depending on the platform; examples are: eth0, Ethernet0, ethernet0, xe0
A.B.C.D	IPv4 address
A.B.C.D/M	IPv4 address and mask/prefix
X:X::X:X	IPv6 address
X:X::X:X/M	IPv6 address and mask/prefix
HH:MM:SS	Time format
AA:NN	BGP community value
XX:XX:XX:XX:XX:XX	MAC address
<1-5> <1-65535> <0-2147483647> <0-4294967295>	Numeric range

Command Description Format

[Table 4](#) on page 20 explains the sections used to describe each command in this reference.

Table 4: Command descriptions

Section	Description
Command Name	The name of the command, followed by what the command does and when should it be used
Command Syntax	The syntax of the command
Parameters	Parameters and options for the command
Default	The state before the command is executed
Command Mode	The mode in which the command runs; see Command Modes
Example	An example of the command being executed

Keyboard Operations

[Table 5](#) on page 20 lists the operations you can perform from the keyboard.

Table 5: Keyboard operations

Key combination	Operation
Left arrow or Ctrl+b	Moves one character to the left. When a command extends beyond a single line, you can press left arrow or Ctrl+b repeatedly to scroll toward the beginning of the line, or you can press Ctrl+a to go directly to the beginning of the line.
Right arrow or Ctrl-f	Moves one character to the right. When a command extends beyond a single line, you can press right arrow or Ctrl+f repeatedly to scroll toward the end of the line, or you can press Ctrl+e to go directly to the end of the line.
Esc, b	Moves back one word
Esc, f	Moves forward one word
Ctrl+e	Moves to end of the line
Ctrl+a	Moves to the beginning of the line
Ctrl+u	Deletes the line
Ctrl+w	Deletes from the cursor to the previous whitespace
Alt+d	Deletes the current word
Ctrl+k	Deletes from the cursor to the end of line
Ctrl+y	Pastes text previously deleted with Ctrl+k, Alt+d, Ctrl+w, or Ctrl+u at the cursor

Table 5: Keyboard operations (Continued)

Key combination	Operation
Ctrl+t	Transposes the current character with the previous character
Ctrl+c	Ignores the current line and redisplay the command prompt
Ctrl+z	Ends configuration mode and returns to exec mode
Ctrl+l	Clears the screen
Up Arrow or Ctrl+p	Scroll backward through command history
Down Arrow or Ctrl+n	Scroll forward through command history

Show Command Modifiers

You can use two tokens to modify the output of a `show` command. Enter a question mark to display these tokens:

```
# show users ?
  | Output modifiers
  > Output redirection
```

You can type the | (vertical bar character) to use output modifiers. For example:

```
> show rsvp | ?
begin      Begin with the line that matches
exclude    Exclude lines that match
include    Include lines that match
last       Last few lines
redirect   Redirect output
```

Begin Modifier

The `begin` modifier displays the output beginning with the first line that contains the input string (everything typed after the `begin` keyword). For example:

```
# show running-config | begin xe1
...skipping
interface xe1
  ipv6 address fe80::204:75ff:fee6:5393/64
!
interface xe2
  ipv6 address fe80::20d:56ff:fe96:725a/64
!
line con 0
  login
!
end
```

You can specify a regular expression after the `begin` keyword. This example begins the output at a line with either “xe2” or “xe4”:

```
# show running-config | begin xe[2-4]
...skipping
```

```

interface xe2
 shutdown
 !
interface xe4
 shutdown
 !
interface svlan0.1
 no shutdown
 !
route-map myroute permit 2
 !
route-map mymap1 permit 10
 !
route-map rmap1 permit 2
 !
line con 0
 login
line vty 0 4
 login
 !
end

```

Include Modifier

The `include` modifier includes only those lines of output that contain the input string. In the output below, all lines containing the word “input” are included:

```

# show interface xe1 | include input
input packets 80434552, bytes 2147483647, dropped 0, multicast packets 0
input errors 0, length 0, overrun 0, CRC 0, frame 0, fifo 1, missed 0

```

You can specify a regular expression after the `include` keyword. This examples includes all lines with “input” or “output”:

```

#show interface xe0 | include (in|out)put
input packets 597058, bytes 338081476, dropped 0, multicast packets 0
input errors 0, length 0, overrun 0, CRC 0, frame 0, fifo 0, missed 0
output packets 613147, bytes 126055987, dropped 0
output errors 0, aborted 0, carrier 0, fifo 0, heartbeat 0, window 0

```

Exclude Modifier

The `exclude` modifier excludes all lines of output that contain the input string. In the following output example, all lines containing the word “input” are excluded:

```

# show interface xe1 | exclude input
Interface xe1
Scope: both
Hardware is Ethernet, address is 0004.75e6.5393
index 3 metric 1 mtu 1500 <UP,BROADCAST,RUNNING,MULTICAST>
VRF Binding: Not bound
Administrative Group(s): None
DSTE Bandwidth Constraint Mode is MAM
inet6 fe80::204:75ff:fee6:5393/64
output packets 4438, bytes 394940, dropped 0
output errors 0, aborted 0, carrier 0, fifo 0, heartbeat 0, window 0
collisions 0

```

You can specify a regular expression after the `exclude` keyword. This example excludes lines with “output” or “input”:

```
# show interface xe0 | exclude (in|out)put
Interface xe0
Scope: both
Hardware is Ethernet   Current HW addr: 001b.2139.6c4a
Physical:001b.2139.6c4a Logical:(not set)
index 2 metric 1 mtu 1500 duplex-full arp ageing timeout 3000
<UP,BROADCAST,RUNNING,MULTICAST>
VRF Binding: Not bound
Bandwidth 100m
DHCP client is disabled.
inet 10.1.2.173/24 broadcast 10.1.2.255
VRRP Master of : VRRP is not configured on this interface.
inet6 fe80::21b:21ff:fe39:6c4a/64
collisions 0
```

Redirect Modifier

The `redirect` modifier writes the output into a file. The output is not displayed.

```
# show cli history | redirect /var/frame.txt
```

The output redirection token (`>`) does the same thing:

```
# show cli history >/var/frame.txt
```

Last Modifier

The `last` modifier displays the output of last few number of lines (As per the user input). The last number ranges from 1 to 9999.

For example:

```
#show running-config | last 10
```

String Parameters

The restrictions in [Table 6](#) on page 24 apply for all string parameters used in OcNOS commands, unless some other restrictions are noted for a particular command.

Table 6: String parameter restrictions

Restriction	Description
Input length	1965 characters or less
Restricted special characters	“?”, “,”, “>”, “ ”, and “=” The “ ” character is allowed only for the <code>description</code> command in interface mode.

Command Modes

Commands are grouped into modes arranged in a hierarchy. Each mode has its own set of commands. [Table P-7](#) lists the command modes common to all protocols.

Table 7: Common command modes

Name	Description
Executive mode	Also called <i>view</i> mode, this is the first mode to appear after you start the CLI. It is a base mode from where you can perform basic commands such as <code>show</code> , <code>exit</code> , <code>quit</code> , <code>help</code> , and <code>enable</code> .
Privileged executive mode	Also called <i>enable</i> mode, in this mode you can run additional basic commands such as <code>debug</code> , <code>write</code> , and <code>show</code> .
Configure mode	Also called <i>configure terminal</i> mode, in this mode you can run configuration commands and go into other modes such as <code>interface</code> , <code>router</code> , <code>route map</code> , <code>key chain</code> , and <code>address family</code> . Configure mode is single user. Only one user at a time can be in configure mode.
Interface mode	In this mode you can configure protocol-specific settings for a particular interface. Any setting you configure in this mode overrides a setting configured in router mode.
Router mode	This mode is used to configure router-specific settings for a protocol such as BGP or OSPF.

Command Mode Tree

The diagram below shows the common command mode hierarchy.

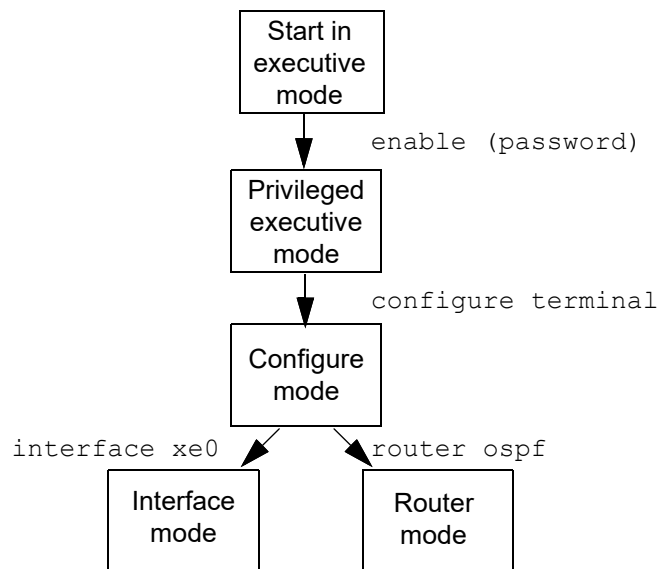

Figure P-1: Common command modes

To change modes:

1. Enter privileged executive mode by entering `enable` in Executive mode.
2. Enter configure mode by entering `configure terminal` in Privileged Executive mode.

The example below shows moving from executive mode to privileged executive mode to configure mode and finally to router mode:

```
> enable mypassword
# configure terminal
Enter configuration commands, one per line. End with CNTL/Z.
(config)# router ospf
(config-router)#
```

Note: Each protocol can have modes in addition to the common command modes. See the command reference for the respective protocol for details.

Transaction-based Command-line Interface

The OcNOS command line interface is transaction based:

- Any changes done in configure mode are stored in a separate *candidate* configuration that you can view with the `show transaction current` command.
- When a configuration is complete, apply the candidate configuration to the running configuration with the `commit` command.
- If a `commit` fails, no configuration is applied as the entire transaction is considered failed. You can continue to change the candidate configuration and then retry the `commit`.
- Discard the candidate configuration with the `abort transaction` command.
- Check the last aborted transaction with the `show transaction last-aborted` command.
- Multiple configurations cannot be removed with a single `commit`. You must remove each configuration followed by a `commit`.

Note: All commands MUST be executed only in the default CML shell (`cmlsh`). If you log in as root and start `imish`, then the system configurations will go out of sync. The `imish` shell is not supported and should not be started manually.

Layer 2 Configuration Guide

CHAPTER 1 Link Layer Discovery Protocol Configuration

This chapter contains a complete sample Link Layer Discovery Protocol (LLDP) configuration.

LLDP is a neighbor discovery protocol that defines a method for network access devices using Ethernet connectivity to advertise themselves to other devices on the same physical LAN, and then to store information about the network. It allows a device to learn higher-layer management reachability and connection endpoint information from adjacent devices. Using LLDP, a network device is able to advertise its identity, its capabilities and its media-specific configuration, as well as learn the same information from other connected devices.

Note: The `lldp-agent` command is not supported for SVLAN, VLAN, and loop-back interfaces.

Topology

Figure 1-1 displays a sample LLDP topology.

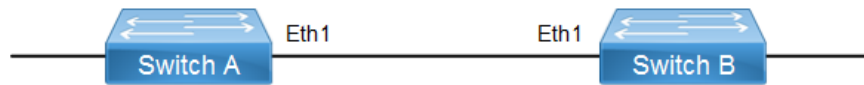

Figure 1-1: LLDP Topology

Interface Mode TLV

Default Agent

All configuration commands in the table below should be followed for each switch.

<code>#configure terminal</code>	Enter configure mode.
<code>(config)#bridge 1 protocol ieee vlan-bridge</code>	Configure an IEEE VLAN-aware bridge.
<code>(config)#vlan database</code>	Enter VLAN configure mode.
<code>(config-vlan)#vlan 2 bridge 1 state enable</code>	Configure a VLAN and add it to the bridge.
<code>(config-vlan)#exit</code>	Exit the VLAN configuration mode.
<code>(config)#interface eth1</code>	Enter interface mode.
<code>(config-if)#switchport</code>	Set switching characteristics on the port.
<code>(config-if)#bridge-group 1</code>	Associate the interface to the bridge.
<code>(config-if)#lldp-agent</code>	Enter into the default agent
<code>(if-lldp-agent)#set lldp enable txrx</code>	Enable an LLDP agent on the port.
<code>(if-lldp-agent)#set lldp chassis-id-tlv ip-address</code>	Configure the subtype for chassis-id TLV
<code>(if-lldp-agent)#set lldp port-id-tlv mac-address</code>	Configure the subtype for port-id TLV
<code>(if-lldp-agent)#lldp tlv basic-mgmt port-description select</code>	Enable the port-description TLV to be transmitted on the port
<code>(if-lldp-agent)#lldp tlv basic-mgmt system-name select</code>	Enable the system-name TLV to be transmitted on the port

<code>(if-lldp-agent)#lldp tlv basic-mgmt system-capabilities select</code>	Enable the system-capabilities TLV to be transmitted on the port
<code>(if-lldp-agent)#lldp tlv basic-mgmt system-description select</code>	Enable the system-description TLV to be transmitted on the port
<code>(if-lldp-agent)#lldp tlv basic-mgmt management-address select</code>	Enable the management-address TLV to be transmitted on the port
<code>(if-lldp-agent)#lldp tlv ieee-8021-org-specific port-vlanid select</code>	Enable the VLAN-id TLV to be transmitted on the port
<code>(if-lldp-agent)#lldp tlv ieee-8021-org-specific vlan-name select</code>	Enable the VLAN-NAME TLV to be transmitted on the port
<code>(if-lldp-agent)#lldp tlv ieee-8021-org-specific port-ptcl-vlanid select</code>	Enable the Port and Protocol VLAN id TLV to be transmitted on the port
<code>(if-lldp-agent)#lldp tlv ieee-8021-org-specific ptcl-identity select</code>	Enable the Protocol Identity TLV to be transmitted on the port
<code>(if-lldp-agent)#lldp tlv ieee-8021-org-specific vid-digest select</code>	Enable the VID Usage Digest TLV to be transmitted on the port
<code>(if-lldp-agent)#lldp tlv ieee-8021-org-specific mgmt-vid select</code>	Enable the Management VID TLV to be transmitted on the port
<code>(if-lldp-agent)#lldp tlv ieee-8021-org-specific link-agg select</code>	Enable the Link Aggregation TLV to be transmitted on the port
<code>(if-lldp-agent)#lldp tlv ieee-8023-org-specific mac-phy select</code>	Enable the MAC/PHY Configuration/Status TLV to be transmitted on the port
<code>(if-lldp-agent)#lldp tlv ieee-8023-org-specific max-mtu-size select</code>	Enable the Maximum Frame Size TLV to be transmitted on the port
<code>(if-lldp-agent)#set lldp timer msg-fast-tx 5</code>	Defines the time interval during fast transmission periods
<code>(if-lldp-agent)#set lldp tx-fast-init 6</code>	Defines the number of LLDPDUs that are transmitted during a fast transmission period
<code>(if-lldp-agent)#exit</code>	Exit the lldp agent mode
<code>(config-if)#commit</code>	Commit the candidate configuration to the running configuration.
<code>(config-if)#exit</code>	Exit interface mode.

Validation

1. Verify the LLDP configurations in the local switch

```
#show running-config lldp
!
interface eth1
lldp-agent
  set lldp enable txrx
  set lldp chassis-id-tlv ip-address
  set lldp port-id-tlv mac-address
  lldp tlv basic-mgmt port-description select
  lldp tlv basic-mgmt system-name select
  lldp tlv basic-mgmt system-description select
  lldp tlv basic-mgmt system-capabilities select
  lldp tlv basic-mgmt management-address select
  lldp tlv ieee-8021-org-specific port-vlanid select
  lldp tlv ieee-8021-org-specific port-ptcl-vlanid select
  lldp tlv ieee-8021-org-specific vlan-name select
```

```

lldp tlv ieee-8021-org-specific ptcl-identity select
lldp tlv ieee-8021-org-specific vid-digest select
lldp tlv ieee-8021-org-specific mgmt-vid select
lldp tlv ieee-8021-org-specific link-agg select
lldp tlv ieee-8023-org-specific mac-phy select
lldp tlv ieee-8023-org-specific max-mtu-size select
set lldp timer msg-fast-tx 5
set lldp tx-fast-init 6
!
```

2. Verify the LLDP port statistics

```
#show lldp interface eth1 nearest-bridge
```

```

Agent Mode                : Nearest bridge
Enable (tx/rx)            : Y/Y
Message fast transmit time : 5
Message transmit interval : 30
Reinitialisation delay    : 2
MED Enabled                : N
Device Type               : Not Defined
Traffic statistics        :
Total frames transmitted   : 4
Total entries aged         : 0
Total frames received     : 3
Total error frames received: 0
Total frames discarded    : 0
Total discarded TLVs      : 0
Total unrecognised TLVs   : 0
```

Customer Bridge

All configuration commands in the table below should be followed for each switch.

#configure terminal	Enter configure mode.
(config)#bridge 1 protocol ieee vlan-bridge	Configure an IEEE VLAN-aware bridge.
(config)#vlan database	Enter VLAN configure mode.
(config-vlan)#vlan 2 bridge 1 state enable	Configure a VLAN and add it to the bridge.
(config-vlan)#exit	Exit the VLAN configuration mode.
(config)#interface eth1	Enter interface mode.
(config-if)#switchport	Set switching characteristics on the port.
(config-if)#bridge-group 1	Associate the interface to the bridge.
(config-if)#lldp-agent customer-bridge	Enter into the Customer Bridge agent
(if-lldp-agent)#set lldp enable txrx	Enable an LLDP agent on the port.
(if-lldp-agent)#set lldp chassis-id-tlv ip-address	Configure the subtype for chassis-id TLV
(if-lldp-agent)#set lldp port-id-tlv mac-address	Configure the subtype for port-id TLV
(if-lldp-agent)#lldp tlv basic-mgmt port-description select	Enable the port-description TLV to be transmitted on the port.

(if-lldp-agent)#lldp tlv basic-mgmt system-name select	Enable the system-name TLV to be transmitted on the port.
(if-lldp-agent)#lldp tlv basic-mgmt system-capabilities select	Enable the system-capabilities TLV to be transmitted on the port.
(if-lldp-agent)#lldp tlv basic-mgmt system-description select	Enable the system-description TLV to be transmitted on the port.
(if-lldp-agent)#lldp tlv basic-mgmt management-address select	Enable the management-address TLV to be transmitted on the port.
(if-lldp-agent)#lldp tlv ieee-8021-org-specific port-vlanid select	Enable the VLAN-id TLV to be transmitted on the port.
(if-lldp-agent)#lldp tlv ieee-8021-org-specific vlan-name select	Enable the VLAN-NAME TLV to be transmitted on the port.
(if-lldp-agent)#lldp tlv ieee-8021-org-specific port-ptcl-vlanid select	Enable the Port and Protocol VLAN id TLV to be transmitted on the port.
(if-lldp-agent)#lldp tlv ieee-8021-org-specific ptcl-identity select	Enable the Protocol Identity TLV to be transmitted on the port.
(if-lldp-agent)#lldp tlv ieee-8021-org-specific vid-digest select	Enable the VID Usage Digest TLV to be transmitted on the port.
(if-lldp-agent)#lldp tlv ieee-8021-org-specific mgmt-vid select	Enable the Management VID TLV to be transmitted on the port.
(if-lldp-agent)#lldp tlv ieee-8021-org-specific link-agg select	Enable the Link Aggregation TLV to be transmitted on the port.
(if-lldp-agent)#lldp tlv ieee-8023-org-specific mac-phy select	Enable the MAC/PHY Configuration/Status TLV to be transmitted on the port.
(if-lldp-agent)#lldp tlv ieee-8023-org-specific max-mtu-size select	Enable the Maximum Frame Size TLV to be transmitted on the port.
(if-lldp-agent)#set lldp timer msg-fast-tx 5	Defines the time interval during fast transmission periods.
(if-lldp-agent)#set lldp tx-fast-init 6	Defines the number of LLD PDUs that are transmitted during a fast transmission period.
(if-lldp-agent)#exit	Exit the lldp agent mode
(config-if)#commit	Commit the candidate configuration to the running configuration.
(config-if)#exit	Exit interface mode.

Validation

1. Verify the LLDP configurations in the local switch:

```
#show #show running-config lldp
!
interface eth1
lldp-agent customer-bridge
set lldp enable txrx
set lldp chassis-id-tlv ip-address
set lldp port-id-tlv mac-address
lldp tlv basic-mgmt port-description select
lldp tlv basic-mgmt system-name select
lldp tlv basic-mgmt system-description select
lldp tlv basic-mgmt system-capabilities select
lldp tlv basic-mgmt management-address select
lldp tlv ieee-8021-org-specific port-vlanid select
```

```

lldp tlv ieee-8021-org-specific port-ptcl-vlanid select
lldp tlv ieee-8021-org-specific vlan-name select
lldp tlv ieee-8021-org-specific ptcl-identity select
lldp tlv ieee-8021-org-specific vid-digest select
lldp tlv ieee-8021-org-specific mgmt-vid select
lldp tlv ieee-8021-org-specific link-agg select
lldp tlv ieee-8023-org-specific mac-phy select
lldp tlv ieee-8023-org-specific max-mtu-size select
set lldp timer msg-fast-tx 5
set lldp tx-fast-init 6
!
```

2. Verify the LLDP port statistics

```

#show lldp interface eth1 customer-bridge

Agent Mode                : Customer-bridge
Enable (tx/rx)            : Y/Y
Message fast transmit time : 5
Message transmit interval : 30
Reinitialisation delay    : 2
MED Enabled               : N
Device Type               : Not Defined
Traffic statistics        :
Total frames transmitted   : 8
Total entries aged        : 0
Total frames received     : 7
Total error frames received : 0
Total frames discarded    : 0
Total discarded TLVs      : 0
Total unrecognised TLVs  : 0
```

Non-Tpmr-Bridge

The below configurations should be followed for each switch.

#configure terminal	Enter configure mode.
(config)#bridge 1 protocol ieee vlan-bridge	Configure an IEEE VLAN-aware bridge.
(config)#vlan database	Enter VLAN configure mode.
(config-vlan)#vlan 2 bridge 1 state enable	Configure a VLAN and add it to the bridge.
(config-vlan)#exit	Exit the VLAN configuration mode.
(config)#interface eth1	Enter interface mode.
(config-if)#switchport	Set switching characteristics on the port.
(config-if)#bridge-group 1	Associate the interface to the bridge.
(config-if)#lldp-agent non-tpmr-bridge	Enter into the Non tpmr Bridge agent
(if-lldp-agent)#set lldp enable txrx	Enable an LLDP agent on the port.
(if-lldp-agent)#set lldp chassis-id-tlv ip-address	Configure the subtype for chassis-id TLV
(if-lldp-agent)#set lldp port-id-tlv mac-address	Configure the subtype for port-id TLV

<code>(if-lldp-agent)#lldp tlv basic-mgmt port-description select</code>	Enable the port-description TLV to be transmitted on the port
<code>(if-lldp-agent)#lldp tlv basic-mgmt system-name select</code>	Enable the system-name TLV to be transmitted on the port
<code>(if-lldp-agent)#lldp tlv basic-mgmt system-capabilities select</code>	Enable the system-capabilities TLV to be transmitted on the port
<code>(if-lldp-agent)#lldp tlv basic-mgmt system-description select</code>	Enable the system-description TLV to be transmitted on the port
<code>(if-lldp-agent)#lldp tlv basic-mgmt management-address select</code>	Enable the management-address TLV to be transmitted on the port
<code>(if-lldp-agent)#lldp tlv ieee-8021-org-specific port-vlanid select</code>	Enable the VLAN-id TLV to be transmitted on the port
<code>(if-lldp-agent)#lldp tlv ieee-8021-org-specific vlan-name select</code>	Enable the VLAN-NAME TLV to be transmitted on the port
<code>(if-lldp-agent)#lldp tlv ieee-8021-org-specific port-ptcl-vlanid select</code>	Enable the Port and Protocol VLAN id TLV to be transmitted on the port
<code>(if-lldp-agent)#lldp tlv ieee-8021-org-specific ptcl-identity select</code>	Enable the Protocol Identity TLV to be transmitted on the port
<code>(if-lldp-agent)#lldp tlv ieee-8021-org-specific vid-digest select</code>	Enable the VID Usage Digest TLV to be transmitted on the port
<code>(if-lldp-agent)#lldp tlv ieee-8021-org-specific mgmt-vid select</code>	Enable the Management VID TLV to be transmitted on the port
<code>(if-lldp-agent)#lldp tlv ieee-8021-org-specific link-agg select</code>	Enable the Link Aggregation TLV to be transmitted on the port
<code>(if-lldp-agent)#lldp tlv ieee-8023-org-specific mac-phy select</code>	Enable the MAC/PHY Configuration/Status TLV to be transmitted on the port
<code>(if-lldp-agent)#lldp tlv ieee-8023-org-specific max-mtu-size select</code>	Enable the Maximum Frame Size TLV to be transmitted on the port
<code>(if-lldp-agent)#set lldp timer msg-fast-tx 5</code>	Defines the time interval during fast transmission periods
<code>(if-lldp-agent)#set lldp tx-fast-init 6</code>	Defines the number of LLD PDUs that are transmitted during a fast transmission period
<code>(if-lldp-agent)#exit</code>	Exit the lldp agent mode
<code>(config-if)#commit</code>	Commit the candidate configuration to the running configuration.
<code>(config-if)#exit</code>	Exit interface mode.

Validation

1. Verify the LLDP configurations in the local switch:

```
#show running-config lldp
lldp-agent non-tpmr-bridge
  set lldp enable txrx
  set lldp chassis-id-tlv ip-address
  set lldp port-id-tlv mac-address
  lldp tlv basic-mgmt port-description select
  lldp tlv basic-mgmt system-name select
  lldp tlv basic-mgmt system-description select
  lldp tlv basic-mgmt system-capabilities select
  lldp tlv basic-mgmt management-address select
  lldp tlv ieee-8021-org-specific port-vlanid select
```

```

lldp tlv ieee-8021-org-specific port-ptcl-vlanid select
lldp tlv ieee-8021-org-specific vlan-name select
lldp tlv ieee-8021-org-specific ptcl-identity select
lldp tlv ieee-8021-org-specific vid-digest select
lldp tlv ieee-8021-org-specific mgmt-vid select
lldp tlv ieee-8021-org-specific link-agg select
lldp tlv ieee-8023-org-specific mac-phy select
lldp tlv ieee-8023-org-specific max-mtu-size select
set lldp timer msg-fast-tx 5
set lldp tx-fast-init 6

```

!

2. Verify the LLDP port statistics

```
#show lldp interface eth1 non-tpmr-bridge
```

```

Agent Mode                : Non-TPMR-bridge
Enable (tx/rx)            : Y/Y
Message fast transmit time : 5
Message transmit interval : 30
Reinitialisation delay    : 2
MED Enabled               : Y
Device Type               : Not Defined
Traffic statistics        :
Total frames transmitted   : 17
Total entries aged        : 0
Total frames received     : 6
Total error frames received: 0
Total frames discarded    : 0
Total discarded TLVs      : 0
Total unrecognised TLVs   : 0

```

Media Endpoint Devices TLV

Switch A

(config)#interface eth1	Enter interface mode.
(config-if)#lldp-agent	Enter the default agent.
(if-lldp-agent)#set lldp enable txrx	Set the admin status of the LLDP agent.
(if-lldp-agent)#exit	Exit agent mode.
(config-if)#lldp-agent customer-bridge	Enter the customer-bridge agent.
(if-lldp-agent)#set lldp enable txrx	Set the admin status of the LLDP agent.
(if-lldp-agent)#exit	Exit agent mode.
(config-if)#lldp-agent non-tpmr-bridge	Enter the non-tpmr-bridge agent.
(if-lldp-agent)#set lldp enable txrx	Set the admin status of the LLDP agent.
(if-lldp-agent)#exit	Exit agent mode.
(config-if)#set lldp med-devtype net-connect	Enter the med-devtype agent and set the device type to network connectivity.

(config-if)#exit	Exit agent mode.
(config-if)#commit	Commit the candidate configuration to the running configuration.

Validation

```
#show run lldp
!
!
interface eth1
 lldp-agent
  set lldp enable txrx
 set lldp med-devtype net-connect
lldp-agent non-tpmr-bridge
  set lldp enable txrx
lldp-agent customer-bridge
  set lldp enable txrx
!
#

#show lldp interface eth1
Agent Mode                : Customer-bridge
  Enable (tx/rx)          : Y/Y
  Message fast transmit time : 1
  Message transmit interval : 30
  Reinitialisation delay   : 2
  MED Enabled              : Y
  Device Type              : Network Connectivity
  Traffic statistics       :
    Total frames transmitted : 97
    Total entries aged       : 1
    Total frames received    : 92
    Total error frames received: 0
    Total frames discarded   : 0
    Total discarded TLVs     : 0
    Total unrecognised TLVs  : 0
Agent Mode                : Non-TPMR-bridge
  Enable (tx/rx)          : Y/Y
  Message fast transmit time : 1
  Message transmit interval : 30
  Reinitialisation delay   : 2
  MED Enabled              : N
  Device Type              : Network Connectivity
  Traffic statistics       :
    Total frames transmitted : 89
    Total entries aged       : 0
    Total frames received    : 0
    Total error frames received: 0
    Total frames discarded   : 0
    Total discarded TLVs     : 0
    Total unrecognised TLVs  : 0
```

```

Agent Mode                : Nearest bridge
  Enable (tx/rx)          : Y/Y
  Message fast transmit time : 1
  Message transmit interval : 30
  Reinitialisation delay   : 2
  MED Enabled             : N
  Device Type             : Network Connectivity
Traffic statistics        :
  Total frames transmitted : 90
  Total entries aged       : 0
  Total frames received    : 0
  Total error frames received: 0
  Total frames discarded   : 0
  Total discarded TLVs    : 0
  Total unrecognised TLVs : 0

```

#

Switch B

(config)#interface eth1	Enter interface mode.
(config-if)#lldp-agent	Enter the default agent.
(if-lldp-agent)#set lldp enable txrx	Set the admin status of the LLDP agent.
(if-lldp-agent)#exit	Exit agent mode.
(config-if)#lldp-agent customer-bridge	Enter the customer-bridge agent.
(if-lldp-agent)#set lldp enable txrx	Set the admin status of the LLDP agent.
(if-lldp-agent)#exit	Exit agent mode.
(config-if)#lldp-agent non-tpmr-bridge	Enter the non-tpmr-bridge agent.
(if-lldp-agent)#set lldp enable txrx	Set the admin status of the LLDP agent.
(if-lldp-agent)#exit	Exit agent mode.
(config-if)#set lldp med-devtype ep-class3	Enter the med-devtype agent and set the device type to endpoint class 3.
(config-if)#exit	Exit agent mode.
(config-if)#commit	Commit the candidate configuration to the running configuration.

Validation

```

#show running-config lldp
!
!
interface eth1
  lldp-agent
    set lldp enable txrx
    set lldp chassis-id-tlv ip-address
  set lldp med-devtype ep-class3
  lldp-agent non-tpmr-bridge
    set lldp enable txrx
    set lldp chassis-id-tlv ip-address
  lldp-agent customer-bridge

```

```
set lldp enable txrx
set lldp chassis-id-tlv ip-address
!
#

#show lldp interface eth1
Agent Mode                : Customer-bridge
  Enable (tx/rx)          : Y/Y
  Message fast transmit time : 1
  Message transmit interval : 30
  Reinitialisation delay   : 2
  MED Enabled              : Y
  Device Type              : End Point Class-3
Traffic statistics        :
  Total frames transmitted  : 11
  Total entries aged       : 0
  Total frames received    : 12
  Total error frames received: 0
  Total frames discarded   : 0
  Total discarded TLVs     : 0
  Total unrecognised TLVs  : 0
Agent Mode                : Non-TPMR-bridge
  Enable (tx/rx)          : Y/Y
  Message fast transmit time : 1
  Message transmit interval : 30
  Reinitialisation delay   : 2
  MED Enabled              : Y
  Device Type              : End Point Class-3
Traffic statistics        :
  Total frames transmitted  : 7
  Total entries aged       : 0
  Total frames received    : 0
  Total error frames received: 0
  Total frames discarded   : 0
  Total discarded TLVs     : 0
  Total unrecognised TLVs  : 0
Agent Mode                : Nearest bridge
  Enable (tx/rx)          : Y/Y
  Message fast transmit time : 1
  Message transmit interval : 30
  Reinitialisation delay   : 2
  MED Enabled              : Y
  Device Type              : End Point Class-3
Traffic statistics        :
  Total frames transmitted  : 8
  Total entries aged       : 0
  Total frames received    : 0
  Total error frames received: 0
  Total frames discarded   : 0
  Total discarded TLVs     : 0
```

```
Total unrecognised TLVs      : 0
#
```

Global Mode TLV

LLDPv2 TLVs can be configured globally, making it applicable for all interfaces where LLDP is enabled.

Topology

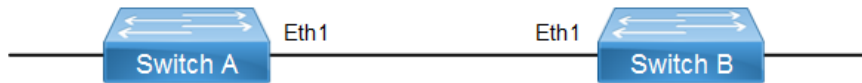

Figure 1-2: LLDP topology

SW1

SW1#configure terminal	Enter Configure mode
SW1(config)#lldp tlv-select basic-mgmt port-description	Enable LLDP port description TLV in global mode
SW1(config)#lldp tlv-select basic-mgmt system-name	Enable LLDP system name TLV in global mode
SW1(config)#lldp tlv-select basic-mgmt system-capabilities	Enable LLDP system capabilities TLV in global mode
SW1(config)#lldp tlv-select basic-mgmt system-description	Enable LLDP system description TLV in global mode
SW1(config)#lldp tlv-select basic-mgmt management-address	Enable LLDP management address TLV in global mode
SW1(config)#interface eth1	Enter interface mode
SW1(config-if)#lldp-agent	Enter LLDP interface mode
SW1(if-lldp-agent)#set lldp enable txrx	Enable LLDP TLV transmit and receive for the nearest bridge
SW1(if-lldp-agent)#exit	Exit LLDP mode
SW1(config-if)#commit	Commit the candidate configuration to the running configuration.
SW1(config-if)#exit	Exit interface mode
SW1(config)#end	Exit the configure mode

SW2

SW2#configure terminal	Enter Configure mode
SW2(config)#lldp tlv-select basic-mgmt port-description	Enable LLDP port description TLV in global mode
SW2(config)#lldp tlv-select basic-mgmt system-name	Enable LLDP system name TLV in global mode
SW2(config)#lldp tlv-select basic-mgmt system-capabilities	Enable LLDP system capabilities TLV in global mode
SW2(config)#lldp tlv-select basic-mgmt system-description	Enable LLDP system description TLV in global mode

SW2(config)#lldp tlv-select basic-mgmt management-address	Enable LLDP management address TLV in global mode
SW2(config)#interface eth1	Enter interface mode
SW2(config-if)#lldp-agent	Enter LLDP interface mode
SW2(if-lldp-agent)#set lldp enable txrx	Enable LLDP TLV transmit and receive for the nearest bridge
SW2(if-lldp-agent)#exit	Exit LLDP mode
SW2(config-if)#commit	Commit the candidate configuration to the running configuration.
SW2(config-if)#exit	Exit interface mode
SW2(config)#end	Exit the configure mode

Validation

```
SW1#show running-config lldp
!
lldp tlv-select basic-mgmt port-description
lldp tlv-select basic-mgmt system-name
lldp tlv-select basic-mgmt system-capabilities
lldp tlv-select basic-mgmt system-description
lldp tlv-select basic-mgmt management-address
!
interface eth1
  lldp-agent
  set lldp enable txrx
```

```
SW1#show lldp neighbors
```

Loc PortID	Rem Host Name	Rem Chassis Id	Rem Port Id	Agent Mode
Eth1	OcNOS	cc37.ab56.6d80	cc37.abbb.ed81	Nearest bridge

```
SW1#show lldp neighbors detail
```

```
-----
Nearest bridge Neighbors
Interface Name           : eth1
Mandatory TLVs
Chassis id type         : MAC address [cc37.ab56.6d80]
Port id type            : MAC address [cc37.abbb.ed81]
Time to live            : 121
Basic Management TLVs
System Name             : SW2
System Description      : Hardware Model:EC_AS4610-54, Software version: Oc
NOS,1.3.6.241a
Port Description        : eth1
```

```

Remote System Capabilities : Bridge
                             Router
Capabilities Enabled       : Router
Management Address        : MAC Address [cc37.abbb.ed81]
Interface Number subtype  : ifindex
Interface Number          : 10046
OID Number                 : 0
802.1 Org specific TLVs
Port vlan id              : 0
Port & Protocol vlan id   : 0
Remote Configured VLANs   : None
Remote Protocols Advertised: None
Remote VID Usage Digest   : 0
Remote Management Vlan    : 0
Link Aggregation Capability: not capable of being aggregated
Link Aggregation Status   : not currently in aggregation
Link Aggregation Port ID  :
802.3 Org specific TLVs
AutoNego Support          : Not-Supported
AutoNego Status           : Disabled
AutoNego Capability       : 0
Operational MAU Type      : 0 [unknown]
Max Frame Size            :
SW1#

```

LLDP-MED

LLDP extensions and behavior requirements are described specifically in the areas of network Configuration and policy, device location (including for Emergency Call Service / E911), Power over Ethernet management, and inventory management.

Based on the device type, different TLVs are advertised by the Station.

LLDP-MED Network Connectivity Device

LLDP-MED Network Connectivity Devices, as defined in this Standard, provide access to the IEEE 802 based LAN infrastructure for LLDP-MED Endpoint Devices. An LLDP-MED Network Connectivity Device is a LAN access device based on any of the following technologies:

- LAN Switch/Router
- IEEE 802.1 Bridge
- IEEE 802.3 Repeater (included for historical reasons)
- IEEE 802.11 Wireless Access Point
- Any device that supports the IEEE 802.1AB and MED extensions defined by this Standard and can relay IEEE 802 frames via any method.

Configuration Command

```
set lldp med-devtype net-connect
```

LLDP-MED Generic Endpoint (Class 1)

The LLDP-MED Generic Endpoint (Class I) definition is applicable to all endpoint products that require the base LLDP discovery services, however do not support IP media or act as an end-user communication appliance. Such devices may include (but are not limited to) IP Communication Controllers, other communication related servers, or any device requiring basic services.

Configuration command:

```
set lldp med-devtype ep-class1
```

LLDP-MED Generic Endpoint (Class 2)

The LLDP-MED Media Endpoint (Class II) definition is applicable to all endpoint products that have IP media capabilities however may or may not be associated with a particular end user. Capabilities include all of the capabilities defined for the previous Generic Endpoint Class (Class I), and are extended to include aspects related to media streaming. Example product categories expected to adhere to this class include (but are not limited to) Voice / Media Gateways, Conference Bridges, Media Servers, and similar

Configuration command:

```
set lldp med-devtype ep-class2
```

LLDP-MED Generic Endpoint (Class 3)

The LLDP-MED Communication Endpoint (Class III) definition is applicable to all endpoint products that act as end user communication appliances supporting IP media. Capabilities include all of the capabilities defined for the previous Generic Endpoint (Class I) and Media Endpoint (Class II) classes, and are extended to include aspects related to end user devices. Example product categories expected to adhere to this class include (but are not limited to) end user communication appliances, such as IP Phones, PC-based softphones, or other communication appliances that directly support the end user.

Configuration command:

```
set lldp med-devtype ep-class3
```

Switch A

#configure terminal	Enter configure mode.
(config)#bridge 1 protocol ieee vlan-bridge	Configure an IEEE VLAN-aware bridge.
(config)#vlan database	Enter VLAN configure mode.
(config-vlan)#vlan 2 bridge 1 state enable	Configure a VLAN and add it to the bridge.
(config-vlan)#exit	Exit the VLAN configuration mode.
(config)#interface eth1	Enter interface mode.
(config-if)#switchport	Set switching characteristics on the port.
(config-if)#bridge-group 1	Associate the interface to the bridge.
(config-if)#lldp-agent	Enter into the default agent

(if-lldp-agent)#set lldp enable txrx	Enable an LLDP agent on the port.
(if-lldp-agent)#exit	Exit the lldp agent mode
(if-config-if)#lldp-agent customer-bridge	Enter into the customer-bridge agent.
(if-lldp-agent)#set lldp enable txrx	Enable an LLDP agent on the port.
(if-lldp-agent)#exit	Exit the lldp agent mode
(config-if)#lldp-agent non-tpmr-bridge	Enter into the non-tpmr-bridge agent
(if-lldp-agent)#set lldp enable txrx	Enable an LLDP agent on the port.
(if-lldp-agent)#exit	Exit the lldp agent mode
(config-if)#set lldp med-devtype net-connect	Configure the med device type
(config-if)#exit	Exit interface mode.
(config-if)#commit	Commit the candidate configuration to the running configuration.

Switch B

#configure terminal	Enter configure mode.
(config)#bridge 1 protocol ieee vlan-bridge	Configure an IEEE VLAN-aware bridge.
(config)#vlan database	Enter VLAN configure mode.
(config-vlan)#vlan 2 bridge 1 state enable	Configure a VLAN and add it to the bridge.
(config-vlan)#exit	Exit the VLAN configuration mode.
(config)#interface eth1	Enter interface mode.
(config-if)#switchport	Set switching characteristics on the port.
(config-if)#bridge-group 1	Associate the interface to the bridge.
(config-if)#lldp-agent	Enter into the default agent
(if-lldp-agent)#set lldp enable txrx	Enable an LLDP agent on the port.
(if-lldp-agent)#exit	Exit the lldp agent mode
(config-if)#lldp-agent customer-bridge	Enter into the customer-bridge agent
(if-lldp-agent)#set lldp enable txrx	Enable an LLDP agent on the port.
(if-lldp-agent)#exit	Exit the lldp agent mode
(config-if)#lldp-agent non-tpmr-bridge	Enter into the non-tpmr-bridge agent
(if-lldp-agent)#set lldp enable txrx	Enable an LLDP agent on the port.
(if-lldp-agent)#exit	Exit the lldp agent mode
(config-if)#set lldp med-devtype ep-class3	Configure the med device type
(config-if)#exit	Exit interface mode.
(config-if)#commit	Commit the candidate configuration to the running configuration.

Validation

1. Verify the LLDP configurations on Switch A:

```
#show running-config lldp
!
!
interface eth1
 lldp-agent
  set lldp enable txrx
  set lldp med-devtype net-connect
 lldp-agent non-tpmr-bridge
  set lldp enable txrx
 lldp-agent customer-bridge
  set lldp enable txrx
!
```

2. Verify the LLDP port statistics on Switch A:

```
#show lldp interface eth1
Agent Mode                : Customer-bridge
  Enable (tx/rx)          : Y/Y
  Message fast transmit time : 1
  Message transmit interval : 30
  Reinitialisation delay   : 2
  MED Enabled              : Y
  Device Type               : Network Connectivity
  Traffic statistics       :
    Total frames transmitted : 11
    Total entries aged       : 0
    Total frames received    : 10
    Total error frames received: 0
    Total frames discarded   : 0
    Total discarded TLVs     : 0
    Total unrecognised TLVs  : 0
Agent Mode                : Non-TPMR-bridge
  Enable (tx/rx)          : Y/Y
  Message fast transmit time : 1
  Message transmit interval : 30
  Reinitialisation delay   : 2
  MED Enabled              : N
  Device Type               : Network Connectivity
  Traffic statistics       :
    Total frames transmitted : 7
    Total entries aged       : 0
    Total frames received    : 0
    Total error frames received: 0
    Total frames discarded   : 0
    Total discarded TLVs     : 0
    Total unrecognised TLVs  : 0
Agent Mode                : Nearest bridge
  Enable (tx/rx)          : Y/Y
  Message fast transmit time : 1
  Message transmit interval : 30
  Reinitialisation delay   : 2
  MED Enabled              : N
  Device Type               : Network Connectivity
  Traffic statistics       :
```

```

Total frames transmitted : 7
Total entries aged       : 0
Total frames received    : 0
Total error frames received: 0
Total frames discarded   : 0
Total discarded TLVs     : 0
Total unrecognised TLVs : 0

```

```

#show lldp interface eth1 non-tpmr-bridge
Agent Mode                : Non-TPMR-bridge
Enable (tx/rx)           : Y/Y
Message fast transmit time : 5
Message transmit interval : 30
Reinitialisation delay   : 2
MED Enabled               : N
Device Type               : Not Defined
Traffic statistics       :
Total frames transmitted  : 4
Total entries aged       : 0
Total frames received    : 0
Total error frames received: 0
Total frames discarded   : 0
Total discarded TLVs     : 0
Total unrecognised TLVs : 0

```

3. Verify the LLDP configurations for end device ep-class3 on Switch B:

```

#show running-config lldp
!
interface eth1
 set lldp med-devtype ep-class3
 lldp-agent
  set lldp enable txrx
  lldp tlv med network-policy select
lldp-agent non-TPMR-bridge
 set lldp enable txrx
  lldp tlv med network-policy select
lldp-agent customer-bridge
 set lldp enable txrx
  lldp tlv med network-policy select
!

```

4. Verify the LLDP port statistics on Switch B:

```

#show lldp interface eth1
Agent Mode                : Customer-bridge
Enable (tx/rx)           : Y/Y
Message fast transmit time : 1
Message transmit interval : 30
Reinitialisation delay   : 2
MED Enabled               : Y
Device Type               : End Point Class-3
Traffic statistics       :
Total frames transmitted  : 124
Total entries aged       : 0
Total frames received    : 125
Total error frames received: 0
Total frames discarded   : 0

```

```

    Total discarded TLVs      : 0
    Total unrecognised TLVs  : 0
Agent Mode                   : Non-TPMR-bridge
  Enable (tx/rx)             : Y/Y
  Message fast transmit time : 1
  Message transmit interval  : 30
  Reinitialisation delay    : 2
  MED Enabled                : Y
  Device Type                : End Point Class-3
  Traffic statistics         :
    Total frames transmitted  : 120
    Total entries aged       : 0
    Total frames received    : 0
    Total error frames received: 0
    Total frames discarded   : 0
    Total discarded TLVs    : 0
    Total unrecognised TLVs  : 0
Agent Mode                   : Nearest bridge
  Enable (tx/rx)             : Y/Y
  Message fast transmit time : 1
  Message transmit interval  : 30
  Reinitialisation delay    : 2
  MED Enabled                : Y
  Device Type                : End Point Class-3
  Traffic statistics         :
    Total frames transmitted  : 120
    Total entries aged       : 0
    Total frames received    : 0
    Total error frames received: 0
    Total frames discarded   : 0
    Total discarded TLVs    : 0
    Total unrecognised TLVs  : 0
#

```

LLDP Over SVI, LAG, and Sub-Interface

Overview

Link Layer Discovery Protocol (LLDP) is an open-source Layer 2 protocol that runs on the data link layer. It is a neighbor discovery protocol that defines a method for network access devices using Ethernet connectivity to advertise themselves to other devices on the same physical LAN and then store information about the network. It allows a device to learn higher-layer management reachability and connection endpoint information from adjacent devices. Using LLDP, a network device can advertise its identity, capabilities, and media-specific configuration and learn the same information.

LLDP supports a set of defined attributes used to find neighboring devices including:

- T- type
- L- length
- V- value descriptions

The information is transmitted and/or received by neighbor devices through each of their LLDP-enabled interfaces, which send Ethernet frames at regular intervals. The Management Address TLV in LLDP identifies an address (MAC or Layer3 IP) associated with the local LLDP agent used to reach higher-layer entities to assist discovery by network

management. This TLV also provides room for the inclusion of the system interface number and an object identifier (OID) associated with this management address.

Feature Characteristics

LLDP enabled devices are capable of:

- Discovering neighboring devices.
- Using as an open standard protocol.
- Sharing details about their layer-2 configurations with neighboring devices.

Benefits

- LLDP neighbor are used for SVI,LAG, and Sub Interface.
- LLDP is easy for devices to broadcast and identify information across networks.

Prerequisites

- Upon logging into the OcnOS environment enable LLDP run command on global mode.
- The enabled device should support the LLDP sub-interface configuration.

Note: Before configuring the SVI interface, ensure the physical connection between the switches is active, and ports are in the trunk mode.

Topology

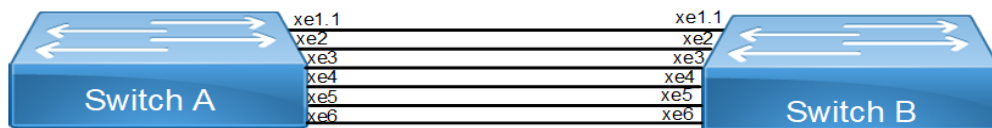

Figure 1-3: LLDP topology

Configuration

Provide the following:

1. Enter the configuration mode and configure VLAN interface.

```
SW1(#config)terminal
SW1(config)#bridge 1 protocol ieee vlan-bridge
SW1(config)#vlan database
SW1(config-vlan)#vlan 2-200 bridge 1 state enable
SW1(config-vlan)#commit
SW1(config-if)#int xe7
SW1(config-if)#switchport
SW1(config-if)#bridge-group 1
SW1(config-if)#switchport mode trunk
SW1(config-if)#switchport trunk allowed vlan all
SW1(config-if)#commit

SW2(config)#bridge 1 protocol ieee vlan-bridge
SW2(config)#vlan database
```

```
SW2(config-vlan)#vlan 2-200 bridge 1 state enable
SW2(config-vlan)#commit
SW2(config)#int xe7
SW2(config-if)#switchport
SW2(config-if)#bridge-group 1
SW2(config-if)#switchport mode trunk
SW2(config-if)#switchport trunk allowed vlan all
SW2(config-if)#commit
```

2. Configure the SVLAN interface and assign the IP address to the interface.

```
SW1(config)#interface vlan1.20
SW1(config-if)#ip vrf forwarding management
SW1(config-if)#ip address 3.3.3.3/24
SW1(config-if)#commit
SW2(config)#interface vlan1.20
SW2(config-if)#ipvrf forwarding management
SW2(config-if)#ip address 3.3.3.2/24
SW2(config-if)#commit
```

3. Configure the port channel interface and assign the IP address. Connect the interfaces to the port channel.

```
SW1(config)#interface po10
SW1(config-if)#ip address 1.1.1.1/24
SW1(config-if)# ip vrf forwarding management
SW1(config-if)#commit Feature Name
SW1(config-if)#exit
```

```
SW1(config)#int xe2
SW1(config-if)#switchport
SW1(config-if)#no switchport
SW1(config-if)#channel-group 10 mode active
SW1(config-if)#commit
```

```
SW1(config)#int xe3
SW1(config-if)#switchport
SW1(config-if)#no switchport
SW1(config-if)#channel-group 10 mode active
SW1(config-if)#commit
```

```
SW1(config)#int xe4
SW1(config-if)#switchport
SW1(config-if)#no switchport
SW1(config-if)#channel-group 10 mode active
SW1(config-if)#commit
```

```
SW2(config)#interface po10
SW2(config-if)#ip address 1.1.1.2/24
SW2(config-if)# ip vrf forwarding management
SW2(config-if)#commit
SW2(config-if)#exit
```

```
SW2(config)#int xe2
SW2(config-if)#switchport
SW2(config-if)#no switchport
SW2(config-if)#channel-group 10 mode active
SW2(config-if)#commit
```

```
SW2(config)#int xe3
SW2(config-if)#switchport
SW2(config-if)#no switchport
SW2(config-if)#channel-group 10 mode active
SW2(config-if)#commit
```

```
SW2(config)#int xe4
SW2(config-if)#switchport
SW2(config-if)#no switchport
SW2(config-if)#channel-group 10 mode active
```

4. Configure sub interfaces on both SW1 and SW2, and assign the IP address to the interfaces.

```
SW1(config)#int xe6.10
SW1(config-if)#encapsulation dot1q 10
SW1(config-if)#ip address 2.2.2.3/24
SW1(config-if)#ip vrf forwarding management
SW1(config-if)#commit
```

```
SW2(config)#int xe6.10
SW2(config-if)#encapsulation dot1q 10
SW2(config-if)#ip address 2.2.2.2/24
SW2(config-if)#ip vrf forwarding management
SW2(config-if)#commit
```

5. Enable the LLDP agent mode and capabilities on both switch interfaces.

```
SW1(config)#int xe6
SW1(config-if)#lldp-agent customer-bridge
SW1(if-lldp-agent)#set lldp enable txrx
SW1(if-lldp-agent)#set lldp chassis-id-tlv ip-address
SW1(if-lldp-agent)#lldp tlv basic-mgmt management-address select
SW1(if-lldp-agent)#commit
```

```
SW2(config-if)#int xe6
SW2(config-if)# lldp-agent
SW2(if-lldp-agent)#set lldp enable txrx
SW2(if-lldp-agent)#set lldp management-address-tlv ip-address
SW2(if-lldp-agent)#lldp tlv basic-mgmt management-address select
SW2(if-lldp-agent)#commit
```

6. Verify the LLDP neighbors on the device.

```
SW1 show lldp int xe6 neighbor
```

```
Nearest bridge Neighbors
Interface Name : xe6
Mandatory TLVs
Chassis id type : MAC address [b86a.9782.1fba]
Port id type : MAC address [b86a.9782.1fc1]
Time to live : 121
Basic Management TLVs
System Name :
System Description :
Port Description :
Remote System Capabilities : None
Capabilities Enabled : None
Management Address : IP Address [10.12.181.117]
```

```
Interface Number subtype : ifindex
Interface Number : 3
OID Number : 0
Management Address : IP Address [2.2.2.2]
Interface Number subtype : ifindex
Interface Number : 327876618
OID Number : 0
Management Address : IP Address [3.3.3.2]
Interface Number subtype : ifindex
Interface Number : 25020
OID Number : 0
802.1 Org specific TLVs
Port vlan id : 0
Port & Protocol vlan id : 0
Remote Configured VLANs : None
Remote Protocols Advertised: None
Remote VID Usage Digest : 0
Remote Management Vlan : 0
Link Aggregation Capability: not capable of being aggregated
Link Aggregation Status : not currently in aggregation
Link Aggregation Port ID : 802.3 Org specific TLVs
AutoNego Support : Not-Supported
AutoNego Status : Disabled
AutoNego Capability : 0
Operational MAU Type : 0 [unknown]
SW2#sh lldp int xe7 neighbor
Nearest bridge Neighbors
Interface Name : xe7

Mandatory TLVs
Chassis id type : MAC address [5c07.5828.a775]
Port id type : MAC address [5c07.5828.a77d]
Time to live : 121

Basic Management TLVs
System Name : SW1
System Description : Hardware Model:UFI_S9510-30XC,
Software version: OcNOS,6.5.1.48
Port Description : xe7
Remote System Capabilities : Bridge Router
Capabilities Enabled : Bridge Router

Management Address : MAC Address [5c07.5828.a77d]
Interface Number subtype : ifindex
Interface Number : 5008
OID Number : 0
802.1 Org specific TLVs
Port vlan id : 1
Port & Protocol vlan id : 0
```

Remote Configured VLANs :

```
vlan-id: 1 vlan-name: default
vlan-id: 2 vlan-name: VLAN0002
vlan-id: 3 vlan-name: VLAN0003
vlan-id: 4 vlan-name: VLAN0004
vlan-id: 5 vlan-name: VLAN0005
vlan-id: 6 vlan-name: VLAN0006
vlan-id: 7 vlan-name: VLAN0007
vlan-id: 8 vlan-name: VLAN0008
vlan-id: 9 vlan-name: VLAN0009
vlan-id: 10 vlan-name: VLAN0010
vlan-id: 11 vlan-name: VLAN0011
vlan-id: 12 vlan-name: VLAN0012
vlan-id: 13 vlan-name: VLAN0013
vlan-id: 14 vlan-name: VLAN0014
vlan-id: 15 vlan-name: VLAN0015
vlan-id: 16 vlan-name: VLAN0016
vlan-id: 17 vlan-name: VLAN0017
vlan-id: 18 vlan-name: VLAN0018
vlan-id: 19 vlan-name: VLAN0019
vlan-id: 20 vlan-name: VLAN0020
vlan-id: 21 vlan-name: VLAN0021
vlan-id: 22 vlan-name: VLAN0022
vlan-id: 23 vlan-name: VLAN0023
vlan-id: 24 vlan-name: VLAN0024
vlan-id: 25 vlan-name: VLAN0025
vlan-id: 26 vlan-name: VLAN0026
vlan-id: 27 vlan-name: VLAN0027
vlan-id: 28 vlan-name: VLAN0028
vlan-id: 29 vlan-name: VLAN0029
vlan-id: 30 vlan-name: VLAN0030
vlan-id: 31 vlan-name: VLAN0031
vlan-id: 32 vlan-name: VLAN0032
vlan-id: 33 vlan-name: VLAN0033
vlan-id: 34 vlan-name: VLAN0034
vlan-id: 35 vlan-name: VLAN0035
vlan-id: 36 vlan-name: VLAN0036
vlan-id: 37 vlan-name: VLAN0037
vlan-id: 38 vlan-name: VLAN0038
vlan-id: 39 vlan-name: VLAN0039
vlan-id: 40 vlan-name: VLAN0040
vlan-id: 41 vlan-name: VLAN0041
vlan-id: 42 vlan-name: VLAN0042
vlan-id: 43 vlan-name: VLAN0043
vlan-id: 44 vlan-name: VLAN0044
vlan-id: 45 vlan-name: VLAN0045
vlan-id: 46 vlan-name: VLAN0046
vlan-id: 47 vlan-name: VLAN0047
vlan-id: 48 vlan-name: VLAN0048
vlan-id: 49 vlan-name: VLAN0049
```

```
vlan-id: 50 vlan-name: VLAN0050
vlan-id: 51 vlan-name: VLAN0051
vlan-id: 52 vlan-name: VLAN0052
vlan-id: 53 vlan-name: VLAN0053
vlan-id: 54 vlan-name: VLAN0054
vlan-id: 55 vlan-name: VLAN0055
vlan-id: 56 vlan-name: VLAN0056
vlan-id: 57 vlan-name: VLAN0057
vlan-id: 58 vlan-name: VLAN0058
vlan-id: 59 vlan-name: VLAN0059
vlan-id: 60 vlan-name: VLAN0060
vlan-id: 61 vlan-name: VLAN0061
vlan-id: 62 vlan-name: VLAN0062
vlan-id: 63 vlan-name: VLAN0063
vlan-id: 64 vlan-name: VLAN0064
vlan-id: 65 vlan-name: VLAN0065
vlan-id: 66 vlan-name: VLAN0066
vlan-id: 67 vlan-name: VLAN0067
vlan-id: 68 vlan-name: VLAN0068
vlan-id: 69 vlan-name: VLAN0069
vlan-id: 70 vlan-name: VLAN0070
vlan-id: 71 vlan-name: VLAN0071
vlan-id: 72 vlan-name: VLAN0072
vlan-id: 73 vlan-name: VLAN0073
vlan-id: 74 vlan-name: VLAN0074
vlan-id: 75 vlan-name: VLAN0075
Remote Protocols Advertised: Spanning Tree Protocol
Remote VID Usage Digest : 0
Remote Management Vlan : 0
Link Aggregation Capability: capable of being aggregated
Link Aggregation Status : not currently in aggregation
Link Aggregation Port ID : 802.3 Org specific TLVs
AutoNego Support : Supported
AutoNego Status : Disabled
AutoNego Capability : 16
Operational MAU Type : 54 [Four-pair Category 6A or better, full duplex mode only]
Max Frame Size : 1522
```

Implementation Examples

Enter configuration commands.

```
SW1(config)#lldp tlv-select basic-mgmt port-description
SW1(config)# lldp tlv-select basic-mgmt system-name
SW1(config)# lldp tlv-select basic-mgmt system-description
SW1(config)# lldp tlv-select basic-mgmt system-capabilities
SW1(config)# lldp tlv-select basic-mgmt management-address
SW1(config)#
SW1(config)#
SW1(config)# lldp tlv-select ieee-8021-org-specific port-vlanid
SW1(config)# lldp tlv-select ieee-8021-org-specific port-ptcl-vlanid
SW1(config)# lldp tlv-select ieee-8021-org-specific vlan-name
```

```
SW1(config)# lldp tlv-select ieee-8021-org-specific ptcl-identity
SW1(config)# lldp tlv-select ieee-8021-org-specific vid-digest
SW1(config)# lldp tlv-select ieee-8021-org-specific mgmt-vid
SW1(config)# lldp tlv-select ieee-8021-org-specific link-agg
SW1(config)#
SW1(config)# lldp tlv-select ieee-8023-org-specific mac-phy
SW1(config)# lldp tlv-select ieee-8023-org-specific max-mtu-size
SW1(config)#commit
SW1(config)#do sh lldp int xe6 neighbor

Nearest bridge Neighbors
Interface Name : xe6
Mandatory TLVs
Chassis id type : MAC address [b86a.9782.1fba]
Port id type : MAC address [b86a.9782.1fc1]
Time to live : 121
Basic Management TLVs
System Name : SW2
System Description : Hardware Model:EC_AS5912-54X, Software version:
OcnOS,6.5.1.49
Port Description : xe6
Remote System Capabilities : Bridge
Router
Capabilities Enabled : Bridge
Router
Management Address : IP Address [10.12.181.117]
Interface Number subtype : ifindex
Interface Number : 3
OID Number : 0
Management Address : IP Address [2.2.2.2]
Interface Number subtype : ifindex
Interface Number : 327876618
OID Number : 0
Management Address : IP Address [3.3.3.2]
Interface Number subtype : ifindex
Interface Number : 25020
OID Number : 0
802.1 Org specific TLVs
Port vlan id : 0
Port & Protocol vlan id : 0
Remote Configured VLANs : None
Remote Protocols Advertised: None
Remote VID Usage Digest : 0
Remote Management Vlan : 0 Feature Name
Link Aggregation Capability: capable of being aggregated
Link Aggregation Status : not currently in aggregation
Link Aggregation Port ID :
802.3 Org specific TLVs
AutoNego Support : Supported
AutoNego Status : Disabled
AutoNego Capability : 16
Operational MAU Type : 54 [Four-pair Category 6A or better, full duplex mode
only]
Max Frame Size : 1518
SW1(config)# end
```

CHAPTER 2 Provider Bridging Configuration

This chapter contains sample provider bridging configurations.

A provider bridged network is a virtual bridged Local Area Network that comprises provider bridges (SVLAN bridges and provider edge bridges) and attached LANs, under the administrative control of a single service provider. Provider bridges interconnect the separate MACs of the IEEE 802 LANs that compose a provider bridged network, relaying frames to provide connectivity between all the LANs that provide customer interfaces for each service instance.

Single Provider Bridge Configuration

Topology



Figure 2-4: Single provider bridge configuration

Configuration

SW1 (PEB)

SW1#configure terminal	Enter configuration mode
SW1(config)#bridge 1 protocol provider-rstp edge	Create bridge
SW1(config)#vlan database	Enter VLAN configuration mode
SW1(config-vlan)#vlan 2 type customer bridge 1 state enable	Create customer vlan VLAN 2
SW1(config-vlan)#vlan 200 type service point-point bridge 1 state enable	Create service vlan VLAN200
SW1(config-vlan)#exit	Exit VLAN configuration mode
SW1(config)#cvlan registration table map1 bridge 1	Create cvlan registration table map1
SW1(config-cvlan-registration)#cvlan 2 svlan 200	Map cvlan2 with svlan 200
SW1(config-cvlan-registration)#exit	Exit registration table
SW1(config)#interface eth1	Enter interface configuration mode for eth1
SW1(config-if)#switchport	Configure switchport
SW1(config-if)#bridge-group 1	Associate interface with bridge-group 1
SW1(config-if)#switchport mode customer-edge hybrid	Configure switchport mode customer edge
SW1(config-if)#switchport customer-edge access vlan 2	Associate customer vlan2 with interface

SW1(config-if)#switchport customer-edge vlan registration map1	Attach registration table map1 with interface
SW1(config-if)#exit	Exit interface mode
SW1(config-if)#interface eth2	Enter interface configuration mode for eth2
SW1(config-if)#switchport	Make interface as switchport
SW1(config-if)#bridge-group 1	Associate interface with bridge-group 1
SW1(config-if)#switchport mode provider-network	Configure switchport pnp port
SW1(config-if)#switchport provider-network allowed vlan all	Associate all svlan to the port
SW1(config-if)#commit	Commit the configuration.
SW1(config-if)#exit	Exit interface configuration mode

SW2 (PB)

SW2#configure terminal	Enter configuration mode
SW2(config)#bridge 1 protocol provider-rstp	Create provider bridge
SW2(config)#vlan database	Enter VLAN configuration mode
SW2(config-vlan)#vlan 200 type service point-point bridge 1 state enable	Create service vlan VLAN200
SW2(config-vlan)#exit	Exit VLAN configuration mode
SW2(config)#interface eth1	Enter interface configuration mode for eth1
SW2(config-if)#switchport	Make interface as switchport
SW2(config-if)#bridge-group 1	Associate interface with bridge-group 1
SW2(config-if)#switchport mode provider-network	Configure switchport pnp port
SW2(config-if)#switchport provider-network allowed vlan all	Associate all svlan to the port
SW2(config-if)#exit	Exit interface configuration mode
SW2(config-if)#interface eth2	Enter interface configuration mode for eth2
SW2(config-if)#switchport	Make interface as switchport
SW2(config-if)#bridge-group 1	Associate interface with bridge-group 1
SW2(config-if)#switchport mode provider-network	Configure switchport pnp port
SW2(config-if)#switchport provider-network allowed vlan all	Associate all svlan to the port
SW2(config-if)#commit	Commit the configuration.
SW2(config-if)#exit	Exit interface configuration mode

SW3 (PEB)

SW3#configure terminal	Enter configuration mode
SW3(config)#bridge 1 protocol provider-rstp edge	Create bridge
SW3(config)#vlan database	Enter VLAN configuration mode

SW3(config-vlan)#vlan 2 type customer bridge 1 state enable	Create customer vlan VLAN 2
SW3(config-vlan)#vlan 200 type service point-point bridge 1 state enable	Create service vlan VLAN200
SW3(config-vlan)#exit	Exit VLAN configuration mode
SW3(config)#cvlan registration table map1 bridge 1	Create cvlan registration table map1
SW3(config-cvlan-registration)#cvlan 2 svlan 200	Map cvlan2 with svlan 200
SW3(config-cvlan-registration)#exit	Exit registration table
SW3(config)#interface eth1	Enter interface configuration mode for eth1
SW3(config-if)#switchport	Configure switchport
SW3(config-if)#bridge-group 1	Associate interface with bridge-group 1
SW3(config-if)#switchport mode customer-edge hybrid	Configure switchport mode customer edge
SW3(config-if)#switchport customer-edge access vlan 2	Associate customer vlan2 with interface
SW3(config-if)#switchport customer-edge vlan registration map1	Attach registration table map1 with interface
SW3(config-if)#exit	Exit interface mode
SW3(config-if)#interface eth2	Enter interface configuration mode for eth2
SW3(config-if)#switchport	Make interface as switchport
SW3(config-if)#bridge-group 1	Associate interface with bridge-group 1
SW3(config-if)#switchport mode provider-network	Configure switchport pnp port
SW3(config-if)#switchport provider-network allowed vlan all	Associate all svlan to the port
SW3(config-if)#commit	Commit the configuration.
SW3(config-if)#exit	Exit interface configuration mode

Validation

```
SW3#sh br
bridge 1 is running on provider-rstp edge
Ageout time is global and if something is configured for vxlan then it will be affected here also
```

Bridge	CVLAN	SVLAN	BVLAN	Port	MAC Address	FWD	Time-out
1		200		eth1	0000.0000.0f00	1	300
1		200		eth2	0001.0000.0800	1	300

```
SW1#sh br
bridge 1 is running on provider-rstp edge
Ageout time is global and if something is configured for vxlan then it will be affected here also
```

Bridge	CVLAN	SVLAN	BVLAN	Port	MAC Address	FWD	Time-out
1		200		eth2	0000.0000.0f00	1	300

```
1          200          eth1          0001.0000.0800    1          300
```

```
SW1#sh cvlan registration table
```

```
Bridge      Table Name      Port List
=====
1           map1           eth1

CVLAN ID    SVLAN ID
=====
2           200
```

Two Provider Bridge Configuration

Topology

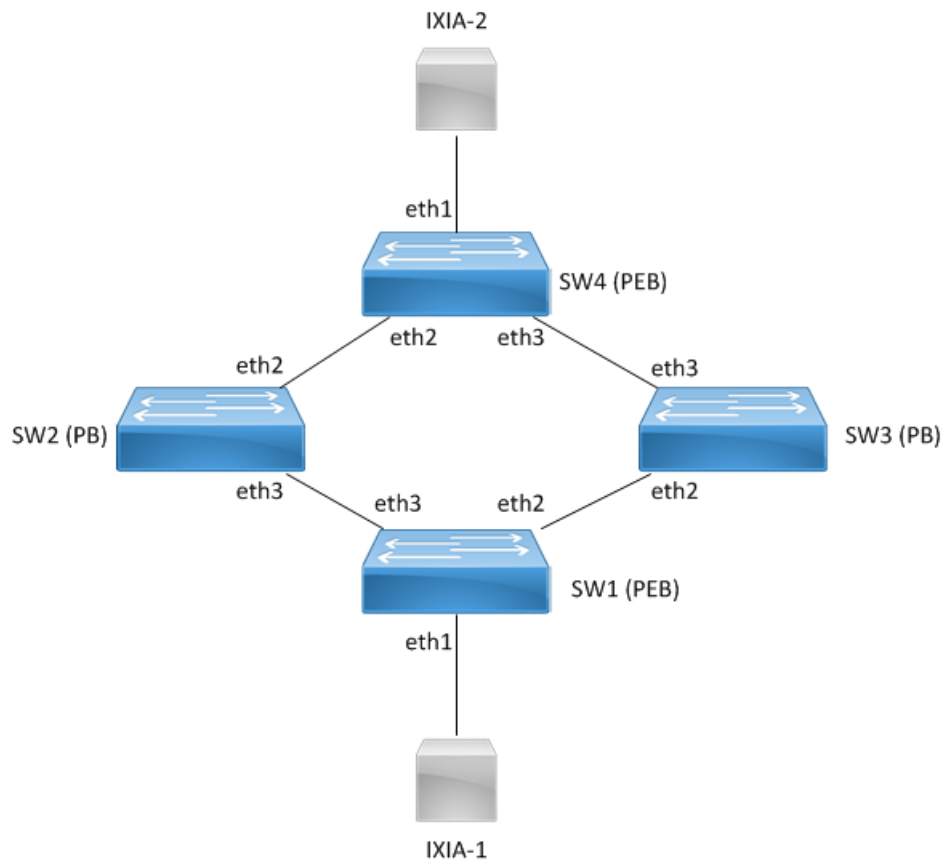

Figure 2-5: Two provider bridge configuration

Configuration

SW1 (PEB)

SW1#configure terminal	Enter configuration mode
SW1(config)#bridge 1 protocol provider-rstp edge	Create bridge
SW1(config)#vlan database	Enter VLAN configuration mode
SW1(config-vlan)#vlan 2 type customer bridge 1 state enable	Create customer vlan VLAN 2
SW1(config-vlan)#vlan 200 type service point-point bridge 1 state enable	Create service vlan VLAN200
SW1(config-vlan)#exit	Exit VLAN configuration mode
SW1(config)#cvlan registration table map1 bridge 1	Create cvlan registration table map1
SW1(config-cvlan-registration)#cvlan 2 svlan 200	Map cvlan2 with svlan 200
SW1(config-cvlan-registration)#exit	Exit registration table
SW1(config)#interface eth1	Enter interface configuration mode for eth1
SW1(config-if)#switchport	Configure switchport
SW1(config-if)#bridge-group 1	Associate interface with bridge-group 1
SW1(config-if)#switchport mode customer-edge hybrid	Configure switchport mode customer edge
SW1(config-if)#switchport customer-edge access vlan 2	Associate customer vlan2 with interface
SW1(config-if)#switchport customer-edge vlan registration map1	Attach registration table map1 with interface
SW1(config-if)#exit	Exit interface mode
SW1(config-if)#interface eth2	Enter interface configuration mode for eth2
SW1(config-if)#switchport	Make interface as switchport
SW1(config-if)#bridge-group 1	Associate interface with bridge-group 1
SW1(config-if)#switchport mode provider-network	Configure switchport pnp port
SW1(config-if)#switchport provider-network allowed vlan all	Associate all svlan to the port
SW1(config-if)#interface eth3	Enter interface configuration mode for eth2
SW1(config-if)#switchport	Make interface as switchport
SW1(config-if)#bridge-group 1	Associate interface with bridge-group 1
SW1(config-if)#switchport mode provider-network	Configure switchport pnp port
SW1(config-if)#switchport provider-network allowed vlan all	Associate all svlan to the port
SW1(config-if)#commit	Commit the configuration.
SW1(config-if)#exit	Exit interface configuration mode

SW2 (PB)

SW2#configure terminal	Enter configuration mode
SW2(config)#bridge 1 protocol provider-rstp	Create provider bridge
SW2(config)#vlan database	Enter VLAN configuration mode
SW2(config-vlan)#vlan 200 type service point-point bridge 1 state enable	Create service vlan VLAN200
SW2(config-vlan)#exit	Exit VLAN configuration mode
SW2(config)#interface eth3	Enter interface configuration mode for eth1
SW2(config-if)#switchport	Make interface as switchport
SW2(config-if)#bridge-group 1	Associate interface with bridge-group 1
SW2(config-if)#switchport mode provider-network	Configure switchport pnp port
SW2(config-if)#switchport provider-network allowed vlan all	Associate all svlan to the port
SW2(config-if)#exit	Exit interface configuration mode
SW2(config-if)#interface eth2	Enter interface configuration mode for eth2
SW2(config-if)#switchport	Make interface as switchport
SW2(config-if)#bridge-group 1	Associate interface with bridge-group 1
SW2(config-if)#switchport mode provider-network	Configure switchport pnp port
SW2(config-if)#switchport provider-network allowed vlan all	Associate all svlan to the port
SW2(config-if)#commit	Commit the configuration.
SW2(config-if)#exit	Exit interface configuration mode

SW3 (PB)

SW3#configure terminal	Enter configuration mode
SW3(config)#bridge 1 protocol provider-rstp	Create provider bridge
SW3(config)#vlan database	Enter VLAN configuration mode
SW3(config-vlan)#vlan 200 type service point-point bridge 1 state enable	Create service vlan VLAN200
SW3(config-vlan)#exit	Exit VLAN configuration mode
SW3(config)#interface eth3	Enter interface configuration mode for eth1
SW3(config-if)#switchport	Make interface as switchport
SW3(config-if)#bridge-group 1	Associate interface with bridge-group 1
SW3(config-if)#switchport mode provider-network	Configure switchport pnp port
SW3(config-if)#switchport provider-network allowed vlan all	Associate all svlan to the port
SW3(config-if)#exit	Exit interface configuration mode
SW3(config-if)#interface eth2	Enter interface configuration mode for eth2
SW3(config-if)#switchport	Make interface as switchport

SW3(config-if)#bridge-group 1	Associate interface with bridge-group 1
SW3(config-if)#switchport mode provider-network	Configure switchport pnp port
SW3(config-if)#switchport provider-network allowed vlan all	Associate all svlan to the port
SW3(config-if)#commit	Commit the configuration.
SW3(config-if)#exit	Exit interface configuration mode

SW4 (PEB)

SW4#configure terminal	Enter configuration mode
SW4(config)#bridge 1 protocol provider-rstp edge	Create bridge
SW4(config)#vlan database	Enter VLAN configuration mode
SW4(config-vlan)#vlan 2 type customer bridge 1 state enable	Create customer vlan VLAN 2
SW4(config-vlan)#vlan 200 type service point-point bridge 1 state enable	Create service vlan VLAN200
SW4(config-vlan)#exit	Exit VLAN configuration mode
SW4(config)#cvlan registration table map1 bridge 1	Create cvlan registration table map1
SW4(config-cvlan-registration)#cvlan 2 svlan 200	Map cvlan2 with svlan 200
SW4(config-cvlan-registration)#exit	Exit registration table
SW4(config)#interface eth1	Enter interface configuration mode for eth1
SW4(config-if)#switchport	Configure switchport
SW4(config-if)#bridge-group 1	Associate interface with bridge-group 1
SW4(config-if)#switchport mode customer-edge hybrid	Configure switchport mode customer edge
SW4(config-if)#switchport customer-edge access vlan 2	Associate customer vlan2 with interface
SW4(config-if)#switchport customer-edge vlan registration map1	Attach registration table map1 with interface
SW4(config-if)#exit	Exit interface mode
SW4(config-if)#interface eth2	Enter interface configuration mode for eth2
SW4(config-if)#switchport	Make interface as switchport
SW4(config-if)#bridge-group 1	Associate interface with bridge-group 1
SW4(config-if)#switchport mode provider-network	Configure switchport pnp port
SW4(config-if)#switchport provider-network allowed vlan all	Associate all svlan to the port
SW4(config-if)#interface eth3	Enter interface configuration mode for eth2
SW4(config-if)#switchport	Make interface as switchport
SW4(config-if)#bridge-group 1	Associate interface with bridge-group 1
SW4(config-if)#switchport mode provider-network	Configure switchport pnp port

SW4(config-if)#switchport provider-network allowed vlan all	Associate all svlan to the port
SW4(config-if)#commit	Commit the configuration.
SW4(config-if)#exit	Exit interface configuration mode

Validation

```
SW4#sh br
bridge 1 is running on provider-rstp edge
Ageout time is global and if something is configured for vxlan then it will be affected here also
```

Bridge	CVLAN	SVLAN	BVLAN	Port	MAC Address	FWD	Time-out
1		200		eth1	0000.0000.0a00	1	300
1		200		eth2	0001.0000.0b00	1	300

```
SW1#sh br
bridge 1 is running on provider-rstp edge
Ageout time is global and if something is configured for vxlan then it will be affected here also
```

Bridge	CVLAN	SVLAN	BVLAN	Port	MAC Address	FWD	Time-out
1		200		eth1	0000.0000.0b00	1	300
1		200		eth3	0001.0000.0a00	1	300

```
SW1#sh cvlan registration table
```

Bridge	Table Name	Port List
1	map1	eth1

CVLAN ID	SVLAN ID
2	200

Layer 2 Protocol Tunneling (L2PT/L2CP Tunneling)

L2CP tunneling provides support for tunneling Control plane frames between CE nodes.

When control frames received at CEP port of PE bridge, predefined multicast address (01-00-C2-CD-CD-D0) is used for tunneling the packets across service provider network. If control packets are customer vlan tagged or untagged, then PE bridge will append corresponding service vlan tag to the control packet as per registration table / vlan translation table mapped to the port and send it across the service provider as a data packet.

When tunneled control packet with multicast address (01-00-C2-CD-CD-D0) received on PNP port, the multicast address is replaced with corresponding control packet multicast address and cvlan/svlan removal or updating is done as per registration table / vlan translation table.

Topology

Figure 2-6 displays a sample Provider Bridged topology with customer equipment.

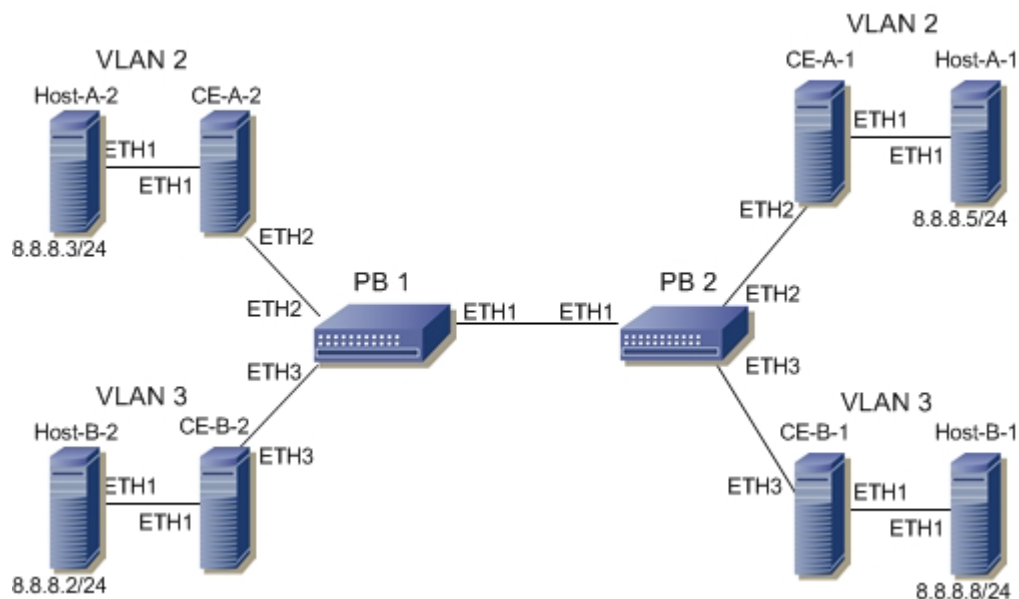

Figure 2-6: Provider Bridging with Customer Equipment Topology

Configuring the L2PT Protocol on the Interface

The following L2PT protocols are supported:

- EFM: Ethernet first mile (Link OAM)
- ELMI: Ethernet Local Management Interface
- LACP: Link Aggregation Control Protocol
- LLDP: Link Layer Discovery Protocol
- STP: Spanning Tree Protocols

PB1

PB1#configure terminal	Enter Configure mode.
PB1(config)#interface eth2	Enter Interface mode
PB1(config-if)#l2protocol stp peer	Configure STP protocol as peer
PB1(config-if)#l2protocol elmi tunnel	Configure Elmi protocol as tunnel
PB1(config-if)#l2protocol lldp tunnel	Configure LLDP protocol as tunnel
PB1(config-if)#l2protocol lacp discard	Configure LACP protocol as discard
PB1(config-if)#l2protocol efm discard	Configure EFM protocol as discard
PB1(config-if)#commit	Commit the configuration.
PB1(config-if)#exit	Exit of the interface

Validation

```
PB1#show l2protocol processing interface eth2
Bridge      Interface Name      Protocol      Processing Status
=====
1           eth2                stp           Peer
1           eth2                gmrp         Peer
1           eth2                gvrp         Peer
1           eth2                mmrp         Peer
1           eth2                mvrp         Peer
1           eth2                lacp         Discard
1           eth2                lldp         Tunnel
1           eth2                efm          Discard
1           eth2                elmi         Tunnel
1           eth2                ptp          Peer
```

Provider Bridging with VLAN Translation

This is a sample configurations to verify functionality to support provider-bridging feature with extended SVLAN translation as below:

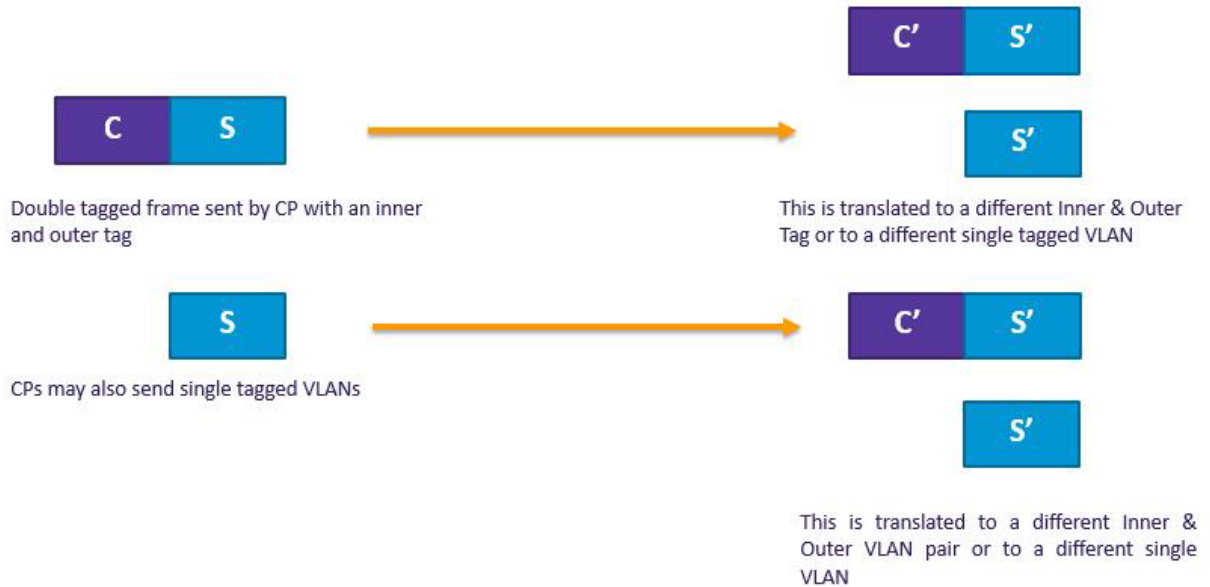

Topology

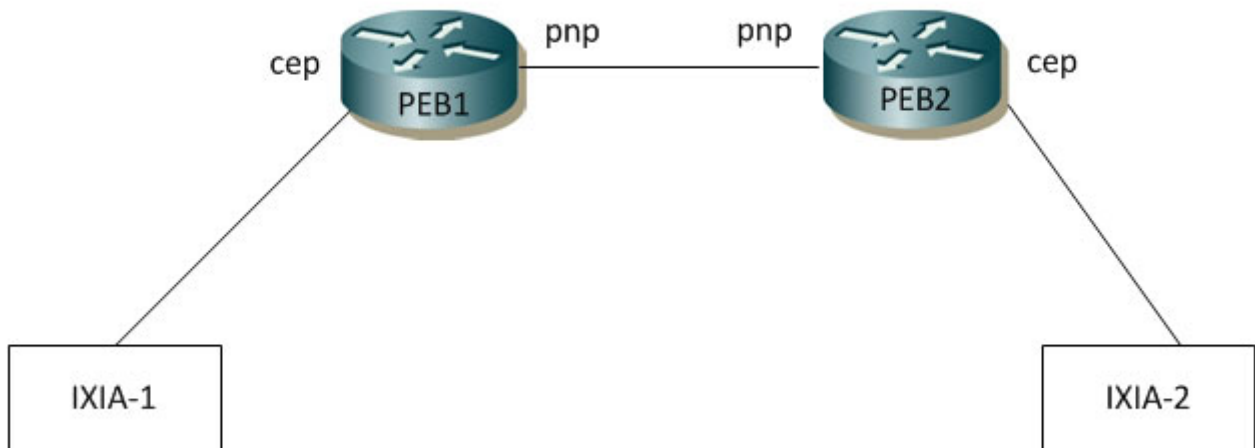

Figure 2-7: Provider Bridging with VLAN Translation Topology

PEB1

Bridge Configuration

#configure terminal	Enter configure mode.
(config)#bridge 1 protocol provider-rstp edge	Enter Configure bridge type as provider-RSTP edge bridge
(config)#commit	Commit the configuration.
(config)#exit	Exit configure mode.

VLAN Configuration

#configure terminal	Enter configure mode.
(config)#vlan database	Enter VLAN database
(config-vlan)# vlan 2-500 type customer bridge 1 state enable	Configure customer VLANs on bridge 1
(config-vlan)#vlan 501-1005 type service point-point bridge 1 state enable	Configure service VLANs on bridge 1
(config-vlan)#commit	Commit the configuration.
(config-vlan)#end	Exit VLAN database and configure mode.

CVLAN Registration Table Configuration

#configure terminal	Enter configure mode.
(config)#cvlan registration table map1 bridge 1	Configure CVLAN registration table as map1
(config-cvlan-registration)#cvlan 2 svlan 6	Map CVLAN to SVLAN
(config-cvlan-registration)#cvlan 3 svlan 7	Map CVLAN to SVLAN
(config-cvlan-registration)#commit	Commit the configuration.
(config-cvlan-registration)#end	End the CVLAN registration mode

CEP Port Configuration

#configure terminal	Enter configure mode.
(config)#interface ge3	Enter the interface mode
(config-if)#switchport	Configure switchport
(config-if)#bridge-group 1	Attach port to bridge
(config-if)#switchport mode customer-edge hybrid	Configure port as customer-edge hybrid port
(config-if)#switchport customer-edge hybrid allowed vlan all	Add all VLANs configured above to this CEP port
(config-if)#switchport customer-edge vlan registration map1	Attach the Map1 to CEP port
(config-if)#commit	Commit the configuration.
(config-if)#end	Exit interface and configure mode.

PNP Port Configuration

#configure terminal	Enter configure mode.
(config)#interface ge9	Enter the interface mode
(config-if)#switchport	Configure switchport
(config-if)#bridge-group 1	Attach port to bridge
(config-if)#switchport mode provider-network	Configure port as Provider Network Port (PNP)
(config-if)#switchport provider-network allowed vlan all	Add all VLANs configured above to this PNP port
(config-if)#commit	Commit the configuration.
(config-if)#end	Exit interface and configure mode.

PEB2

Bridge Configuration

#configure terminal	Enter configure mode.
(config)# bridge 1 protocol provider-rstp edge	Enter configure bridge type as provider-RSTP edge bridge
(config-if)#commit	Commit the configuration.
(config)#exit	Exit configure mode.

VLAN Configuration

#configure terminal	Enter configure mode.
(config)#vlan database	Enter VLAN database
(config-vlan)#vlan 2-500 type customer bridge 1 state enable	Configure customer VLANs on bridge 1
(config-vlan)#vlan 501-1005 type service point-point bridge 1 state enable	Configure service VLANs on bridge 1
(config-if)#commit	Commit the configuration.
(config-vlan)#end	Exit VLAN database and configure mode.

CVLAN Registration Table Configuration

#configure terminal	Enter configure mode.
(config)#cvlan registration table map1 bridge 1	Configure CVLAN registration table as map1
(config-cvlan-registration)#cvlan 2 svlan 6	Map CVLAN to SVLAN
(config-cvlan-registration)#cvlan 3 svlan 7	Map CVLAN to SVLAN
(config-cvlan-registration)#commit	Commit the configuration.
(config-cvlan-registration)#end	End the CVLAN registration mode

CEP Port Configuration

#configure terminal	Enter configure mode.
(config)#interface ge3	Enter the interface mode
(config-if)#switchport	Configure switchport
(config-if)#bridge-group 1	Attach port to bridge
(config-if)#switchport mode customer-edge hybrid	Configure port as customer-edge hybrid port
(config-if)#switchport customer-edge hybrid allowed vlan all	Add all VLANs configured above to this CEP port
(config-if)#switchport customer-edge vlan registration map1	Attach the Map1 to CEP port
(config-if)#commit	Commit the configuration.
(config-if)#end	Exit interface and configure mode.

PNP Port Configuration

#configure terminal	Enter configure mode.
(config)#interface ge9	Enter the interface mode
(config-if)#switchport	Configure switchport
(config-if)#bridge-group 1	Attach port to bridge
(config-if)#switchport mode provider-network	Configure port as Provider Network Port (PNP)
(config-if)#switchport provider-network allowed vlan all	Add all VLANs configured above to this PNP port
(config-if)#commit	Commit the configuration.
(config-if)#end	Exit interface and configure mode.

Translation Cases

Case1 - (C S - C' S')

Configuration on PEB2

#configure terminal	Enter configure mode.
(config)#interface ge9	Enter the interface mode
(config-if)#switchport provider-network vlan translation cvlan 2 svlan 6 cvlan 3 svlan 7	Translate CVLAN and SVLAN to new CVLAN and new SVLAN on PNP port

Validation for Case 1

When tagged traffic with CVLAN 2 is sent from IXIA-1 to IXIA-2 with both CTAG and STAG entering provider network and gets translated to new CVLAN and SVLAN as per Case1.

```
PEB2#show bridge
Bridge      CVLAN  SVLAN  BVLAN  Port          MAC Address      FWD      Time-out
-----+-----+-----+-----+-----+-----+-----+-----+

```

1	1	ge27	1402.ec1c.3144	1	300
1	6	ge9	6400.6a1e.d9a5	1	300
1	7	ge9	0000.0500.0400	1	300
1	7	ge9	6400.6a1e.d9a5	1	300

New SVLAN 7 is observed on PEB2 after translation. Also, captured packets on CEP show new CVLAN 3.

When tagged traffic for CVLAN 3 is sent from IXIA-2 to IXIA-1

```
PEB1#show bridge
```

Bridge	CVLAN	SVLAN	BVLAN	Port	MAC Address	FWD	Time-out
1	1	1		ge9	74e6.e2af.598b	1	300
1	6	6		ge3	0000.0500.0400	1	300
1	6	6		ge9	0000.0500.0700	1	300

When traffic is reversed and traffic has both new CVLAN 3 and SVLAN 7 on provider network from IXIA-2, translation to old CVLAN 2 and SVLAN 6 happens. Also, captured packets have CVLAN as 2.

Case2 - (C S - S')

Configuration on PEB2

CVLAN Registration Table Configuration

#configure terminal	Enter configure mode.
(config)#cvlan registration table map1 bridge 1	Configure CVLAN registration table as map1
(config-cvlan-registration)#cvlan 2 svlan 6	Map CVLAN to SVLAN
(config-cvlan-registration)#cvlan 3 svlan 7 untagged-pep	Map CVLAN to SVLAN
(config-cvlan-registration)#commit	Commit the configuration.
(config-cvlan-registration)#end	End the CVLAN registration mode

CEP Port Configuration

#configure terminal	Enter configure mode.
(config)#interface ge3	Enter the interface mode
(config-if)#switchport customer-edge hybrid vlan 3	Allow access VLAN 3 configured above to this CEP port
(config-if)#switchport customer-edge hybrid allowed vlan add 2-3	Allow other VLANs configured to this CEP port
(config-if)#switchport customer-edge vlan registration map1	Attach the Map1 to CEP port
(config-if)#commit	Commit the configuration.
(config-if)#end	Exit interface and configure mode.

PNP Port Configuration

#configure terminal	Enter configure mode.
(config)#interface ge9	Enter the interface mode

(config-if)#no switchport provider-network vlan translation cvlan 2 svlan 6	Unconfigure Translation Case1 from PNP port
(config-if)#switchport provider-network vlan translation cvlan 2 svlan 6 svlan 7	Configure Translation Case2 on PNP port
(config-if)#commit	Commit the configuration.
(config-if)#end	Exit interface and configure mode.

Validation for Case 2

When tagged traffic with CVLAN 2 is sent from IXIA-1 to IXIA-2 with both CTAG and STAG entering provider network and translated to new SVLAN as per Case2.

```
PEB2#show bridge
```

Bridge	CVLAN	SVLAN	BVLAN	Port	MAC Address	FWD	Time-out
1		1		ge27	1402.ec1c.3144	1	300
1		7		ge9	0000.0500.0400	1	300

New SVLAN 7 is observed on PEB2 after translation. At CEP port connected to IXIA-2, untagged traffic should be received.

When tagged traffic for CVLAN 3 is sent from IXIA-2 to IXIA-1.

```
PEB1#show bridge
```

Bridge	CVLAN	SVLAN	BVLAN	Port	MAC Address	FWD	Time-out
1		1		ge9	74e6.e2af.598b	1	300
1		6		ge3	0000.0500.0400	1	300
1		6		ge9	0000.0500.0700	1	300

When traffic is reversed and traffic has both new CVLAN 3 and SVLAN 7 from IXIA-2, translation to old CVLAN 2 and SVLAN 6 happens. Also, captured packets have CVLAN as 2.

Case3 - (S - S')

Configuration on PEB1

CVLAN Registration Table Configuration

#configure terminal	Enter configure mode.
(config)#cvlan registration table map1 bridge 1	Configure CVLAN registration table as map1
(config-cvlan-registration)#cvlan 2 svlan 6	Map CVLAN to SVLAN
(config-cvlan-registration)#cvlan 3 svlan 7	Map CVLAN to SVLAN
(config-cvlan-registration)#commit	Commit the configuration.
(config-cvlan-registration)#end	End the CVLAN registration mode

CEP Port Configuration

#configure terminal	Enter configure mode.
(config)#interface ge3	Enter the interface mode

(config-if)#switchport customer-edge hybrid vlan 2	Allow access VLAN 2 configured above to this CEP port
(config-if)#switchport customer-edge hybrid allowed vlan add 2-3	Allow other VLANs configured to this CEP port
(config-if)#switchport customer-edge vlan registration map1	Attach the Map1 to CEP port
(config-if)#commit	Commit the configuration.
(config-if)#end	Exit interface and configure mode.

Configuration on PEB2

CEP Port Configuration (should be configured as PNP in this case)

#configure terminal	Enter configure mode.
(config)#interface ge3	Enter the interface mode
(config-if)#switchport	Configure switchport
(config-if)#switchport mode provider-network	Configure port as Provider Network Port (PNP)
(config-if)#switchport provider-network allowed vlan all	Add all VLANs configured above to this PNP port
(config-if)#commit	Commit the configuration.
(config-if)#end	Exit interface and configure mode.

PNP Port Configuration

#configure terminal	Enter configure mode.
(config)#interface ge9	Enter the interface mode
(config-if)#no switchport provider-network vlan translation cvlan 2 svlan 6	Unconfigure Translation Case2 from PNP port
(config-if)#switchport provider-network vlan translation svlan 6 svlan 7	Configure Translation Case3 on PNP port
(config-if)#commit	Commit the configuration.
(config-if)#end	Exit interface and configure mode.

Validation for Case 3

When tagged traffic with CVLAN 2 is sent from IXIA-1 to IXIA-2 with only STAG entering provider network and translation happens to new SVLAN as per Case3.

```
PEB2#show bridge
```

Bridge	CVLAN	SVLAN	BVLAN	Port	MAC Address	FWD	Time-out
1	1			ge27	1402.ec1c.3144	1	300
1		6		ge9	0000.0500.0400	1	300
1		6		ge9	6400.6a1e.d9a5	1	300

New SVLAN 7 is observed on PEB2 At PNP port connected to IXIA-2.

When double tagged traffic of CVLAN 2 and SVLAN 7 is sent from IXIA-2 to IXIA-1:

```
PEB1#show bridge
```

Bridge	CVLAN	SVLAN	BVLAN	Port	MAC Address	FWD	Time-out
1		1		ge9	74e6.e2af.598b	1	300
1		7		ge3	0000.0500.0400	1	300
1		6		ge9	0000.0500.0700	1	300

Here we get a tagged traffic of CVLAN 2 when the captured at IXIA-1.

Case4 - (S - C' S')

Configuration on PEB1

CVLAN Registration Table Configuration

#configure terminal	Enter configure mode.
(config)#cvlan registration table map1 bridge 1	Configure CVLAN registration table as map1
(config-cvlan-registration)#cvlan 2 svlan 6 untagged-pep	Map CVLAN to SVLAN
(config-cvlan-registration)#cvlan 3 svlan 7	Map CVLAN to SVLAN
(config-cvlan-registration)#commit	Commit the configuration.
(config-cvlan-registration)#end	End the CVLAN registration mode

CEP Port Configuration

#configure terminal	Enter configure mode.
(config)#interface ge3	Enter the interface mode
(config-if)#switchport customer-edge hybrid vlan 2	Allow access VLAN 2 configured above to this CEP port
(config-if)#switchport customer-edge hybrid allowed vlan add 2-3	Allow other VLANs configured to this CEP port
(config-if)#switchport customer-edge vlan registration map1	Attach the Map1 to CEP port
(config-if)#commit	Commit the configuration.
(config-if)#end	Exit interface and configure mode.

Configuration on PEB2

CEP Port Configuration (should be configured as PNP in this case)

#configure terminal	Enter configure mode.
(config)#interface ge3	Enter the interface mode
(config-if)#switchport	Configure switchport
(config-if)#bridge-group 1	Attach port to bridge
(config-if)#switchport mode provider-network	Configure port as Provider Network Port (PNP)
(config-if)#switchport provider-network allowed vlan all	Add all VLANs configured above to this PNP port

(config-if)#commit	Commit the configuration.
(config-if)#end	Exit interface and configure mode.

PNP Port Configuration

#configure terminal	Enter configure mode.
(config)#interface ge9	Enter the interface mode
(config-if)#no switchport provider-network vlan translation svlan 6 svlan 7	Unconfigure Translation Case2 from PNP port
(config-if)#switchport provider-network vlan translation svlan 6 cvlan 3 svlan 7	Configure Translation Case3 on PNP port
(config-if)#commit	Commit the configuration.
(config-if)#end	Exit interface and configure mode.

Validation for Case 4

When tagged traffic with CVLAN 2 is sent from IXIA-1 to IXIA-2 enters provider network and translation happens to new CVLAN and new SVLAN as per Case4.

```
PEB2#show bridge
```

Bridge	CVLAN	SVLAN	BVLAN	Port	MAC Address	FWD	Time-out
1		1		ge27	1402.ec1c.3144	1	300
1		6		ge9	0000.0500.0400	1	300
1		6		ge9	6400.6a1e.d9a5	1	300

When you observe the traffic received in IXIA-2, you can observe that new CVLAN 3 and SVLAN 7 tags can be seen. Here the VLAN 2 will be a data packet.

When tagged traffic for CVLAN 3 and SVLAN 7 is sent from IXIA-2 to IXIA-1:

```
PEB1#show bridge
```

Bridge	CVLAN	SVLAN	BVLAN	Port	MAC Address	FWD	Time-out
1		6		ge3	0000.0500.0400	1	300
1		7		ge9	0000.0500.0700	1	300

When you observe, in PEB1 the packets will be dropped at the CEP port since only a single S tagged packets is obtained in the PNP.

Case5 - (C - C' S')

Configuration on PEB1

CVLAN Registration Table Configuration

#configure terminal	Enter configure mode.
(config)#cvlan registration table map1 bridge 1	Configure CVLAN registration table as map1
(config-cvlan-registration)#cvlan 2 cvlan3 svlan 4	Map CVLAN to C'VLAN and SVLAN
(config-cvlan-registration)#cvlan 5 cvlan 6 svlan 7	Map CVLAN to C'VLAN and SVLAN

(config-cvlan-registration)#commit	Commit the configuration.
(config-cvlan-registration)#end	End the CVLAN registration mode

CEP Port Configuration

#configure terminal	Enter configure mode.
(config)#interface ge3	Enter the interface mode
(config-if)#switchport	Configure switchport
(config-if)#bridge-group 1	Attach port to bridge
(config-if)#switchport mode customer-edge hybrid	Configure port as customer-edge hybrid port
(config-if)#switchport customer-edge hybrid allowed vlan all	Allow other VLANs configured to this CEP port
(config-if)#switchport customer-edge vlan registration map1	Attach the Map1 to CEP port
(config-if)#commit	Commit the configuration.
(config-if)#end	Exit interface and configure mode.

Configuration on PEB2

CEP Port Configuration (should be configured as PNP in this case)

#configure terminal	Enter configure mode.
(config)#interface ge3	Enter the interface mode
(config-if)#switchport	Configure switchport
(config-if)#bridge-group 1	Attach port to bridge
(config-if)#switchport mode provider-network	Configure port as Provider Network Port (PNP)
(config-if)#switchport provider-network allowed vlan all	Add all VLANs configured above to this PNP port
(config-if)#commit	Commit the configuration.
(config-if)#end	Exit interface and configure mode.

PNP Port Configuration

#configure terminal	Enter configure mode.
(config)#interface ge9	Enter the interface mode
(config-if)#switchport	Configure switchport
(config-if)#bridge-group 1	Attach port to bridge
(config-if)#switchport mode provider-network	Configure port as Provider Network Port (PNP)
(config-if)#switchport provider-network allowed vlan all	Add all VLANs configured above to this PNP port
(config-if)#commit	Commit the configuration.
(config-if)#end	Exit interface and configure mode.

Validation for Case 5

When tagged traffic with CVLAN 2 is sent from IXIA-1 to IXIA-2 with both CTAG and STAG entering provider network and gets translated to new CVLAN and SVLAN as per Case1.

```
PEB2#show bridge
Bridge      CVLAN  SVLAN  BVLAN  Port      MAC Address      FWD  Time-out
-----+-----+-----+-----+-----+-----+-----+-----+
1           1      1      ge27   1402.ec1c.3144  1     300
1           6      6      ge9    0000.0500.0400  1     300
1           6      6      ge9    6400.6a1e.d9a5  1     300
```

When the packet is captured at PNP port of PEB2 CVLAN of 3 and SVLAN of 4 is seen.

When tagged traffic for CVLAN 6 and SVLAN 7 is sent from IXIA-2 to IXIA-1:

```
PEB1#show bridge
Bridge      CVLAN  SVLAN  BVLAN  Port      MAC Address      FWD  Time-out
-----+-----+-----+-----+-----+-----+-----+-----+
1           1      1      ge9    74e6.e2af.598b  1     300
1           4      4      ge3    0000.0500.0400  1     300
1           7      7      ge9    0000.0500.0700  1     300
```

When traffic is reversed and traffic has both new CVLAN 6 and SVLAN 7 on provider network from IXIA-2, translation to CVLAN 5 and SVLAN 7 happens. Also, captured packets have CVLAN as 2 based on the entry in the cvlan registration table.

Switchport ethertype

Bridge Configuration (for 0x88a8)

Configuration on PEB1

CVLAN Registration Table Configuration

#configure terminal	Enter configure mode.
(config)#cvlan registration table map1 bridge 1	Configure CVLAN registration table as map1
(config-cvlan-registration)#cvlan 2 svlan 4	Map CVLAN to SVLAN
(config-cvlan-registration)#cvlan 3 svlan 6	Map CVLAN to SVLAN
(config-cvlan-registration)#commit	Commit the configuration.
(config-cvlan-registration)#end	End the CVLAN registration mode

Configuration on PEB2

CEP Port Configuration (should be configured as PNP in this case)

CEP Port Configuration

#configure terminal	Enter configure mode.
(config)#interface ge3	Enter the interface mode
(config-if)#switchport	Configure switchport

(config-if)#bridge-group 1	Attach port to bridge
(config-if)#switchport mode provider-network	Configure port as Provider Network Port (PNP)
(config-if)#switchport provider-network allowed vlan all	Add all VLANs configured above to this PNP port
(config-if)#commit	Commit the configuration.
(config-if)#end	Exit interface and configure mode.

PNP Port Configuration

#configure terminal	Enter configure mode.
(config)#interface ge9	Enter the interface mode
(config-if)#switchport	Configure switchport
(config-if)#bridge-group 1	Attach port to bridge
(config-if)#switchport mode provider-network	Configure port as Provider Network Port (PNP)
(config-if)#switchport provider-network allowed vlan all	Add all VLANs configured above to this PNP port
(config-if)#dot1ad ethertype 0x88a8	Change the TPID of the SVLAN to 0x88a8
(config-if)#commit	Commit the configuration.
(config-if)#end	Exit interface and configure mode.

Validation for Switchport ethertype

To validate, send tagged traffic of VLAN 2 from IXIA-1.

Now at eth9 of PB2, capture the packets through IXIA-2 and verify that the traffic is received with double tag.

If the 2 tags CVLAN tag 2 will have the TPID of 0x8100 and SVLAN tag 4 will have a TPID of 0x88a8.

Provider Bridging QoS Configuration

This chapter contains sample provider bridging configurations for QoS.

Scenario: 1 Traffic flow from CEP to PNP

Topology



Figure 2-8: Provider Bridging with QoS Topology

Bridge Configuration

#configure terminal	Enter configure mode.
(config)# bridge 1 protocol provider-rstp edge	Enter configure bridge type as provider-RSTP edge bridge
(config)#commit	Commit the configuration.
(config)#exit	Exit configure mode.

VLAN Configuration

#configure terminal	Enter configure mode.
(config)#vlan database	Enter VLAN database
(config-vlan)#vlan 2-500 type customer bridge 1 state enable	Configure customer VLANs on bridge 1
(config-vlan)#vlan 501-1005 type service point-point bridge 1 state enable	Configure service VLANs on bridge 1
(config-vlan)#commit	Commit the configuration.
(config-vlan)#end	Exit VLAN database and configure mode.

CVLAN Registration Table Configuration

#configure terminal	Enter configure mode.
(config)#cvlan registration table map1 bridge 1	Configure CVLAN registration table as map1
(config-cvlan-registration)#cvlan 2 svlan 501	Map CVLAN to SVLAN
(config-cvlan-registration)#commit	Commit the configuration.
(config-cvlan-registration)#end	End the CVLAN registration mode

CEP Port Configuration

#configure terminal	Enter configure mode.
(config)#interface xe2	Enter the interface mode
(config-if)#switchport	Configure switchport
(config-if)#bridge-group 1	Attach port to bridge
(config-if)#switchport mode customer-edge hybrid	Configure port as customer-edge hybrid port
(config-if)#switchport customer-edge hybrid allowed vlan all	Add all VLANs configured above to this CEP port
(config-if)#switchport customer-edge vlan registration map1	Attach the Map1 to CEP port
(config-if)#commit	Commit the configuration.
(config-if)#end	Exit interface and configure mode.

PNP Port Configuration

#configure terminal	Enter configure mode.
(config)#interface xe3	Enter the interface mode
(config-if)#switchport	Configure switchport
(config-if)#bridge-group 1	Attach port to bridge
(config-if)#switchport mode provider-network	Configure port as Provider Network Port (PNP)
(config-if)#switchport provider-network allowed vlan add 501	Add all VLANs configured above to this PNP port
(config-if)#commit	Commit the configuration.
(config-if)#end	Exit interface and configure mode.

QoS Configurations

#configure terminal	Enter configure mode.
(config)#hardware-profile filter qos-ext enable	Enabling Ingress extended QoS group for QoS support with statistics
(config-if)#qos enable	Enabling QoS
(config-if)#qos statistics	Enabling QoS statistics
(config-if)#qos profile cos-to-queue cosq-cust1	Configure QoS map profile
config-ingress-cos-map)#cos 0 queue 1	Configuring the cos value to be mapped to queue
(config-ingress-cos-map)#exit	Exit configure mode.
(config)#qos profile queue-color-to-cos cosq-service1	Configuring profile for queue color to cos map
(config-egress-cos-map)#queue 1 cos 3	Configuring the queue value to be cos remarked.
(config-egress-cos-map)#exit	Exit configure mode
(config)#cvlan registration table map1bridge 1	Enter CVLAN registration mode

(config-cvlan-registration)#cvlan 2 svlan 501 cos-to-queue cosq-cust1	Map CVLAN to SVLAN with QoS map profile. Eg: when vlan 2 customer traffic with cos 0 value is received, queue will be assigned to 1 based on mapping.
(config-cvlan-registration)#end	End the CVLAN registration mode
(config)#interface xe3	Enter the interface mode
(config-if)#qos map-profile queue-color-to-cos cosq-servicel	Map the profile to the PNP port. Eg: when traffic goes out of queue 1, cos value on service vlan header will be modified to 3 as remarking is enabled on the interface.
(config-if)#qos remark cos enable	Enabling Cos Remark on the Network Interface.
(config-if)#commit	Commit the configuration.
(config-if)#end	Exit interface and configure mode.

Validation for Scenario 1

```
#show cvlan registration table map1
Bridge          Table Name      Port List
=====
1               map1            xe2

CVLAN ID        T-CVLAN ID      SVLAN ID        Profile Name     Egress remark-
Cos
=====
2               -                501             cosq-cust1       No
```

```
#show qos-profile interface xe2
profile name: default
profile type: cos-to-queue (Ingress)
mapping:
-----+-----+-----+-----+-----+-----+-----+-----+
      INPUT |      OUTPUT |      INPUT |      OUTPUT |
-----+-----+-----+-----+-----+-----+-----+-----+
      COS  |  DEI  | Queue |  Color |      COS  |  DEI  | Queue |  Color |
-----+-----+-----+-----+-----+-----+-----+-----+
0         |  0    |  0    | green |  0         |  1    |  0    | yellow |
1         |  0    |  1    | green |  1         |  1    |  1    | yellow |
2         |  0    |  2    | green |  2         |  1    |  2    | yellow |
3         |  0    |  3    | green |  3         |  1    |  3    | yellow |
4         |  0    |  4    | green |  4         |  1    |  4    | yellow |
5         |  0    |  5    | green |  5         |  1    |  5    | yellow |
6         |  0    |  6    | green |  6         |  1    |  6    | yellow |
7         |  0    |  7    | green |  7         |  1    |  7    | yellow |
```

```
profile name: default
profile type: queue-color-to-cos (Egress)
Status: Inactive
mapping:
-----+-----+-----+-----+-----+-----+-----+-----+
      INPUT |      OUTPUT |      INPUT |      OUTPUT |      INPUT |
-----+-----+-----+-----+-----+-----+-----+-----+
      Queue |  Color  |  COS    |  Queue |  Color  |  COS    |  Queue |  Color  |  COS
```

```

-----+-----+----- | -----+-----+----- | -----+-----+-----
0      green  0      | 0      yellow  0      | 0      red    0
1      green  1      | 1      yellow  1      | 1      red    1
2      green  2      | 2      yellow  2      | 2      red    2
3      green  3      | 3      yellow  3      | 3      red    3
4      green  4      | 4      yellow  4      | 4      red    4
5      green  5      | 5      yellow  5      | 5      red    5
6      green  6      | 6      yellow  6      | 6      red    6
7      green  7      | 7      yellow  7      | 7      red    7

```

```

#show qos-profile interface xe3
profile name: default
profile type: cos-to-queue (Ingress)
mapping:

```

```

-----+-----+----- | -----+-----+-----
      INPUT |      OUTPUT |      INPUT |      OUTPUT
-----+-----+----- | -----+-----+-----
  COS | DEI | Queue | Color |  COS | DEI | Queue | Color
-----+-----+----- | -----+-----+-----
0     0 |  0  |   0    | green |  0   |  1  |   0    | yellow
1     0 |  1  |   1    | green |  1   |  1  |   1    | yellow
2     0 |  2  |   2    | green |  2   |  1  |   2    | yellow
3     0 |  3  |   3    | green |  3   |  1  |   3    | yellow
4     0 |  4  |   4    | green |  4   |  1  |   4    | yellow
5     0 |  5  |   5    | green |  5   |  1  |   5    | yellow
6     0 |  6  |   6    | green |  6   |  1  |   6    | yellow
7     0 |  7  |   7    | green |  7   |  1  |   7    | yellow

```

```

profile name: cosq-servicel
profile type: queue-color-to-cos (Egress)
Status: Active
mapping:

```

```

-----+-----+----- | -----+-----+----- | -----+-----+-----
      INPUT |      OUTPUT |      INPUT |      OUTPUT |      INPUT |
OUTPUT
-----+-----+----- | -----+-----+----- | -----+-----+-----
  Queue | Color | COS |  Queue | Color | COS |  Queue | Color | COS
-----+-----+----- | -----+-----+----- | -----+-----+-----
0     green  0      | 0     yellow  0      | 0     red    0
1     green  3      | 1     yellow  3      | 1     red    3
2     green  2      | 2     yellow  2      | 2     red    2
3     green  3      | 3     yellow  3      | 3     red    3
4     green  4      | 4     yellow  4      | 4     red    4
5     green  5      | 5     yellow  5      | 5     red    5
6     green  6      | 6     yellow  6      | 6     red    6
7     green  7      | 7     yellow  7      | 7     red    7

```

Scenario: 2 Traffic flow from PNP to CEP

Topology



Figure 2-9: Provider Bridging with QoS Topology

Bridge Configuration

#configure terminal	Enter configure mode.
(config)# bridge 1 protocol provider-rstp edge	Enter configure bridge type as provider-RSTP edge bridge
(config)#commit	Commit the configuration.
(config)#exit	Exit configure mode.

VLAN Configuration

#configure terminal	Enter configure mode.
(config)#vlan database	Enter VLAN database
(config-vlan)#vlan 2-500 type customer bridge 1 state enable	Configure customer VLANs on bridge 1
(config-vlan)#vlan 501-1005 type service point-point bridge 1 state enable	Configure service VLANs on bridge 1
(config-vlan)#commit	Commit the configuration.
(config-vlan)#end	Exit VLAN database and configure mode.

CVLAN Registration Table Configuration

#configure terminal	Enter configure mode.
(config)#cvlan registration table map1 bridge 1	Configure CVLAN registration table as map1
(config-cvlan-registration)#commit	Commit the configuration.
(config-cvlan-registration)#end	End the CVLAN registration mode

CEP Port Configuration

#configure terminal	Enter configure mode.
(config)#interface xe2	Enter the interface mode
(config-if)#switchport	Configure switchport
(config-if)#bridge-group 1	Attach port to bridge
(config-if)#switchport mode customer-edge hybrid	Configure port as customer-edge hybrid port
(config-if)#switchport customer-edge hybrid allowed vlan all	Add all VLANs configured above to this CEP port
(config-if)#switchport customer-edge vlan registration map1	Attach the Map1 to CEP port
(config-if)#commit	Commit the configuration.
(config-if)#end	Exit interface and configure mode.

PNP Port Configuration

#configure terminal	Enter configure mode.
(config)#interface xe3	Enter the interface mode
(config-if)#switchport	Configure switchport
(config-if)#bridge-group 1	Attach port to bridge
(config-if)#switchport mode provider-network	Configure port as Provider Network Port (PNP)
(config-if)#switchport provider-network allowed vlan add 501	Add all VLANs configured above to this PNP port
(config-if)#commit	Commit the configuration.
(config-if)#end	Exit interface and configure mode.

QoS Configurations

#configure terminal	Enter configure mode.
(config)#hardware-profile filter qos-ext enable	Enabling Ingress extended QoS group for QoS support with statistics
(config-if)#qos enable	Enabling QoS
(config-if)#qos statistics	Enabling QoS statistics
(config-if)#qos profile cos-to-queue cosq-cust1	Configure QoS map profile
config-ingress-cos-map)#cos 2 queue 5	Configuring the cos value to be mapped to queue. Eg: when double tagged traffic with cos 2 for outer vlan is received, queue will be assigned to 5 based on mapping.
(config-ingress-cos-map)#exit	Exit configure mode.
(config)#cvlan registration table map1bridge 1	Enter CVLAN registration mode
(config-cvlan-registration)#cvlan 2 svlan 501 remark-cos	Map CVLAN to SVLAN with remark cos enabled. Eg: when double tagged traffic with cos 2 for outer vlan is received, queue will be assigned to 5 based on mapping and cos value will be changed to 5 when it goes out of cep port since remark cos is enabled.

(config-cvlan-registration)#cvlan 3 svlan 501 remark-cos	Map CVLAN to SVLAN without remark cos. Eg: when double tagged traffic with cos 2 for outer vlan is received, and cos value will be forwarded as it is when it goes out of cep port since remark cos is not enabled for customer2.
(config-cvlan-registration)#end	End the CVLAN registration mode
(config)#configure terminal	Enter configure mode
(config)#interface xe3	Enter the interface mode
(config-if)#qos map-profile cos-to-queue cosq-service	Map the profile to the PNP port
(config-if)#commit	Commit the configuration.
(config-if)#end	Exit interface and configure mode

Validation for Scenario 2

```
#show cvlan registration table map1
Bridge          Table Name      Port List
=====
1               map1           xe2

CVLAN ID        T-CVLAN ID      SVLAN ID        Profile Name     Egress remark-
Cos
=====
2               -               501             N/A             Yes
3               -               501             N/A             No
```

```
#show qos-profile interface xe2
profile name: default
profile type: cos-to-queue (Ingress)
mapping:
```

INPUT				OUTPUT			
COS	DEI	Queue	Color	COS	DEI	Queue	Color
0	0	0	green	0	1	0	yellow
1	0	1	green	1	1	1	yellow
2	0	2	green	2	1	2	yellow
3	0	3	green	3	1	3	yellow
4	0	4	green	4	1	4	yellow
5	0	5	green	5	1	5	yellow
6	0	6	green	6	1	6	yellow
7	0	7	green	7	1	7	yellow

```
profile name: default
profile type: queue-color-to-cos (Egress)
Status: Inactive
mapping:
```

INPUT			OUTPUT		
Queue	Color	COS	Queue	Color	COS
0	green	0	0	yellow	1
1	green	1	1	yellow	1
2	green	2	2	yellow	1
3	green	3	3	yellow	1
4	green	4	4	yellow	1
5	green	5	5	yellow	1
6	green	6	6	yellow	1
7	green	7	7	yellow	1

-----+-----+-----			-----+-----+-----			-----+-----+-----				
0	green	0		0	yellow	0		0	red	0
1	green	1		1	yellow	1		1	red	1
2	green	2		2	yellow	2		2	red	2
3	green	3		3	yellow	3		3	red	3
4	green	4		4	yellow	4		4	red	4
5	green	5		5	yellow	5		5	red	5
6	green	6		6	yellow	6		6	red	6
7	green	7		7	yellow	7		7	red	7

```
#show qos-profile interface xe3
profile name: cosq-service
profile type: cos-to-queue (Ingress)
mapping:
```

-----+-----+-----				-----+-----+-----			
INPUT		OUTPUT		INPUT		OUTPUT	
COS	DEI	Queue	Color	COS	DEI	Queue	Color
0	0	0	green	0	1	0	yellow
1	0	1	green	1	1	1	yellow
2	0	5	green	2	1	5	yellow
3	0	3	green	3	1	3	yellow
4	0	4	green	4	1	4	yellow
5	0	5	green	5	1	5	yellow
6	0	6	green	6	1	6	yellow
7	0	7	green	7	1	7	yellow

```
profile name: default
profile type: queue-color-to-cos (Egress)
Status: Inactive
mapping:
```

-----+-----+-----			-----+-----+-----			-----+-----+-----				
INPUT		OUTPUT	INPUT		OUTPUT	INPUT		OUTPUT		
Queue	Color	COS	Queue	Color	COS	Queue	Color	COS		
0	green	0		0	yellow	0		0	red	0
1	green	1		1	yellow	1		1	red	1
2	green	2		2	yellow	2		2	red	2
3	green	3		3	yellow	3		3	red	3
4	green	4		4	yellow	4		4	red	4
5	green	5		5	yellow	5		5	red	5
6	green	6		6	yellow	6		6	red	6
7	green	7		7	yellow	7		7	red	7

Provider Bridging Untagged-pep Configuration

This is a sample configuration to verify functionality to support provider-bridging with untagged-pep feature.

For the below topology configuration,

1. While sending tagged traffic untagged-pep CVLAN 2, it should drop in provider edge bridge.
2. And while sending tagged traffic CVLAN 3 to the provider network, will egress with CVLAN 3 and SVLAN 12 tag and the same CVLAN and SVLAN tag from provider network, will egress with only CVLAN tag
3. And also for untagged traffic to the provider network, will egress with SVLAN 11 tag

Topology

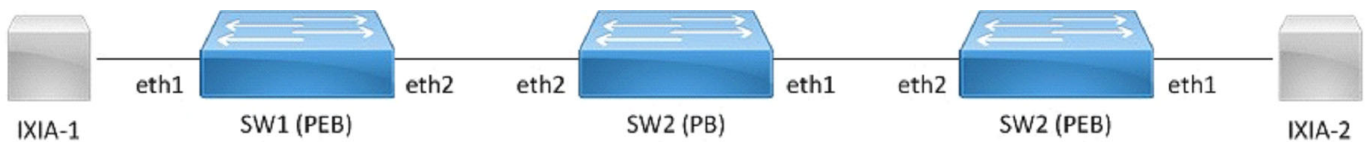

Figure 2-10: Provider bridging untagged-pep configuration

Configuration

SW1 (PEB)

SW1#configure terminal	Enter configuration mode
SW1(config)#bridge 1 protocol provider-rstp edge	Create bridge
SW1(config)#vlan database	Enter VLAN configuration mode
SW1(config-vlan)#vlan 2-10 type customer bridge 1 state enable	Create customer vlan VLAN 2-10
SW1(config-vlan)#vlan 11-15 type service point-point bridge 1 state enable	Create service vlan VLAN 11-15
SW1(config-vlan)#exit	Exit VLAN configuration mode
SW1(config)#cvlan registration table map1 bridge 1	Create cvlan registration table map1
SW1(config-cvlan-registration)#cvlan 2 svlan 11 untagged-pep	Map cvlan2 with svlan 11
SW1(config-cvlan-registration)#cvlan 3 svlan 12	Map cvlan3 with svlan 12
SW1(config-cvlan-registration)#cvlan 4 svlan 14	Map cvlan4 with svlan 14
SW1(config-cvlan-registration)#exit	Exit registration table
SW1(config)#interface eth1	Enter interface configuration mode for eth1
SW1(config-if)#switchport	Configure switchport
SW1(config-if)#bridge-group 1	Associate interface with bridge-group 1

SW1(config-if)#switchport mode customer-edge hybrid	Configure switchport mode customer edge
SW1(config-if)#switchport customer-edge hybrid vlan 2	Associate customer vlan2 with interface
SW1(config-if)#switchport customer-edge hybrid allowed vlan all	Associate all customer vlan with interface
SW1(config-if)#switchport customer-edge vlan registration map1	Attach registration table map1 with interface
SW1(config-if)#exit	Exit interface mode
SW1(config-if)#interface eth2	Enter interface configuration mode for eth2
SW1(config-if)#switchport	Make interface as switchport
SW1(config-if)#bridge-group 1	Associate interface with bridge-group 1
SW1(config-if)#switchport mode provider-network	Configure switchport pnp port
SW1(config-if)#switchport provider-network allowed vlan all	Associate all svlan to the port
SW1(config-if)#commit	Apply the commit
SW1(config-if)#exit	Exit interface configuration mode
SW1(config)#end	Exit configuration mode

SW2 (PB)

SW2#configure terminal	Enter configuration mode
SW2(config)#bridge 1 protocol provider-rstp	Create provider bridge
SW2(config)#vlan database	Enter VLAN configuration mode
SW2(config-vlan)# vlan 2-15 type service point-point bridge 1 state enable	Create service vlan VLAN2-15
SW2(config-vlan)#exit	Exit VLAN configuration mode
SW2(config)#interface eth1	Enter interface configuration mode for eth1
SW2(config-if)#switchport	Make interface as switchport
SW2(config-if)#bridge-group 1	Associate interface with bridge-group 1
SW2(config-if)#switchport mode provider-network	Configure switchport pnp port
SW2(config-if)#switchport provider-network allowed vlan all	Associate all svlan to the port
SW2(config-if)#exit	Exit interface configuration mode
SW2(config-if)#interface eth2	Enter interface configuration mode for eth2
SW2(config-if)#switchport	Make interface as switchport
SW2(config-if)#bridge-group 1	Associate interface with bridge-group 1
SW2(config-if)#switchport mode provider-network	Configure switchport pnp port
SW2(config-if)#switchport provider-network allowed vlan all	Associate all svlan to the port
SW2(config-if)#commit	Apply the commit

SW2(config-if)#exit	Exit interface configuration mode
SW2(config)#end	Exit configuration mode

SW3 (PEB)

SW3#configure terminal	Enter configuration mode
SW3(config)#bridge 1 protocol provider-rstp edge	Create bridge
SW3(config)#vlan database	Enter VLAN configuration mode
SW3(config-vlan)#vlan 2-10 type customer bridge 1 state enable	Create customer vlan VLAN 2-10
SW3(config-vlan)#vlan 11-15 type service point-point bridge 1 state enable	Create service vlan VLAN11-15
SW3(config-vlan)#exit	Exit VLAN configuration mode
SW3(config)#cvlan registration table map1 bridge 1	Create cvlan registration table map1
SW3(config-cvlan-registration)#cvlan 2 svlan 11 untagged-pep	Map cvlan2 with svlan 200
SW3(config-cvlan-registration)#cvlan 3 svlan 12	Map cvlan3 with svlan 12
SW3(config-cvlan-registration)#cvlan 4 svlan 14	Map cvlan4 with svlan 14
SW3(config-cvlan-registration)#exit	Exit registration table
SW3(config)#interface eth1	Enter interface configuration mode for eth1
SW3(config-if)#switchport	Configure switchport
SW3(config-if)#bridge-group 1	Associate interface with bridge-group 1
SW3(config-if)#switchport mode customer-edge hybrid	Configure switchport mode customer edge
SW3(config-if)#switchport customer-edge hybrid vlan 2	Associate customer vlan2 with interface
SW3(config-if)#switchport customer-edge hybrid allowed vlan all	Associate all customer vlan with interface
SW3(config-if)#switchport customer-edge vlan registration map1	Attach registration table map1 with interface
SW3(config-if)#exit	Exit interface mode
SW3(config-if)#interface eth2	Enter interface configuration mode for eth2
SW3(config-if)#switchport	Make interface as switchport
SW3(config-if)#bridge-group 1	Associate interface with bridge-group 1
SW3(config-if)#switchport mode provider-network	Configure switchport pnp port
SW3(config-if)#switchport provider-network allowed vlan all	Associate all svlan to the port
SW3(config-if)#commit	Apply the commit
SW3(config-if)#exit	Exit interface configuration mode
SW3(config)#end	Exit configuration mode

Validation

SW3#sh bridge

bridge 1 is running on provider-rstp edge

Ageout time is global and if something is configured for vxlan then it will be affected here also

Bridge	CVLAN	SVLAN	BVLAN	Port	MAC Address	FWD	Time-out
1	4	14		eth1	0000.0100.0007	1	300

SW1#sh bridge

bridge 1 is running on provider-rstp edge

Ageout time is global and if something is configured for vxlan then it will be affected here also

Bridge	CVLAN	SVLAN	BVLAN	Port	MAC Address	FWD	Time-out
1		14		eth1	0000.0100.0007	1	300

SW1#sh cvlan registration table map1

Bridge	Table Name	Port List
1	map1	eth2

=====

CVLAN ID	T-CVLAN ID	SVLAN ID	CCOS	SCOS	CCFI	SCFI
3	-	12				
2	-	11				
4	-	14				

=====

3

2

4

CHAPTER 3 Provider Bridging Configuration (SVLAN)

This chapter contains sample provider bridging configurations for Customer-Network Port (CNP).

A provider bridged network is a virtual bridged Local Area Network that comprises provider bridges (SVLAN bridges and provider edge bridges) and attached LANs, under the administrative control of a single service provider. Provider bridges interconnect the separate MACs of the IEEE 802 LANs that compose a provider bridged network, relaying frames to provide connectivity between all the LANs that provide customer interfaces for each service instance.

Customer-Network Port (CNP)

In Q-in-Q, the customer network port is similar to provider network port, which can be present in provider-edge bridge (PEB) or provider bridge core (PB), where it can be directly connected to a dedicated customer network. Only SVLAN ids are configurable on Customer network port and learning and forwarding occurs based on SVLAN.

Note: Customer-Network Port is not supported in Qumran1 series platforms.

STAG-based Interface

In this case, the customer will be sending traffic with SVLAN, which will be learned and forwarded via provider network.

In this example, the xe1 interface allows S-TAG 100-200 and 400 traffic from customer.

```
(config)#interface xe1
(config-if)#switchport
(config-if)#dot1ad ethertype 0x88a8
(config-if)#bridge-group 1
(config-if)#switchport mode customer-network
(config-if)#switchport customer-network allowed vlan add 100-200,400
```

Port-based Interface

In this case, the customer traffic with C-VLAN/untagged, received on interface will be stacked with a customer-network SVLAN ID and will be forwarded via provider network. While egressing out of customer-network port for the default SVLAN, the outer SVLAN id will be stripped and the packet will be sent as C-TAG or untagged to customer device.

In this example, the xe1 interface allows C-TAG/untagged traffic from customers, adding an SVLAN ID 100 before forwarding to the provider network. While egressing out, the SVLAN ID100 will be stripped.

```
(config)#interface xe1
(config-if)#switchport
(config-if)#dot1ad ethertype 0x88a8
(config-if)#bridge-group 1
(config-if)#switchport mode customer-network
(config-if)#switchport customer-network allowed vlan add 100
(config-if)#switchport customer-network vlan 100
```

Topology



Figure 3-11: Single provider bridge configuration

Configuration

SW1 (PEB)

SW1#configure terminal	Enter configuration mode
SW1(config)#bridge 1 protocol provider-rstp edge	Create bridge
SW1(config)#vlan database	Enter VLAN configuration mode
SW1(config-vlan)#vlan 100,200 type service point-point bridge 1 state enable	Create service vlan VLAN 100, 200
SW1(config-vlan)#exit	Exit VLAN configuration mode
SW1(config)#interface eth1	Enter interface configuration mode for eth1
SW1(config-if)#switchport	Configure switchport
SW1(config-if)#bridge-group 1	Associate interface with bridge-group 1
SW1(config-if)#dot1ad ethertype 0x88a8	Add Provider Bridging Service VLAN tag identifier
SW1(config-if)#switchport mode customer-network	Configure switchport mode for CNP(customer network port)
SW1(config-if)#switchport customer-network allowed vlan add 200	Associate vlan 200 with interface
SW1(config-if)#switchport customer-network vlan 200	Add vlan 200 as default SVLAN-ID for traffic with CVLAN/untagged
SW1(config-if)#exit	Exit interface mode
SW1(config-if)#interface eth2	Enter interface configuration mode for eth2
SW1(config-if)#switchport	Make interface as switchport
SW1(config-if)#bridge-group 1	Associate interface with bridge-group 1
SW1(config-if)#switchport mode provider-network	Configure switchport pnp port
SW1(config-if)#switchport provider-network allowed vlan all	Associate all svlan to the port
SW1(config-if)#commit	Commit the configuration.
SW1(config-if)#exit	Exit interface configuration mode

SW2 (PB)

SW2#configure terminal	Enter configuration mode
SW2(config)#bridge 1 protocol provider-rstp	Create provider bridge
SW2(config)#vlan database	Enter VLAN configuration mode
SW2(config-vlan)#vlan 200 type service point-point bridge 1 state enable	Create service vlan VLAN200
SW2(config-vlan)#exit	Exit VLAN configuration mode
SW2(config)#interface eth1	Enter interface configuration mode for eth1
SW2(config-if)#switchport	Make interface as switchport
SW2(config-if)#bridge-group 1	Associate interface with bridge-group 1
SW2(config-if)#switchport mode provider-network	Configure switchport pnp port
SW2(config-if)#switchport provider-network allowed vlan all	Associate all svlan to the port
SW2(config-if)#exit	Exit interface configuration mode
SW2(config-if)#interface eth2	Enter interface configuration mode for eth2
SW2(config-if)#switchport	Make interface as switchport
SW2(config-if)#bridge-group 1	Associate interface with bridge-group 1
SW2(config-if)#switchport mode provider-network	Configure switchport pnp port
SW2(config-if)#switchport provider-network allowed vlan all	Associate all svlan to the port
SW2(config-if)#commit	Commit the configuration.
SW2(config-if)#exit	Exit interface configuration mode

SW3 (PEB)

SW3#configure terminal	Enter configuration mode
SW3(config)#bridge 1 protocol provider-rstp edge	Create bridge
SW3(config)#vlan database	Enter VLAN configuration mode
SW3(config-vlan)#vlan 200 type service point-point bridge 1 state enable	Create service vlan VLAN200
SW3(config-vlan)#exit	Exit VLAN configuration mode
SW3(config)#interface eth1	Enter interface configuration mode for eth1
SW3(config-if)#switchport	Configure switchport
SW3(config-if)#dot1ad ethertype 0x88a8	Add Provider Bridging Service VLAN tag identifier
SW3(config-if)#bridge-group 1	Associate interface with bridge-group 1
SW3(config-if)#switchport mode customer-network	Configure switchport CNP port
SW3(config-if)#switchport customer-network allowed vlan add 200	Associate vlan 200 with interface
SW3(config-if)#switchport customer-network vlan 200	Add vlan 200 as default SVLAN-ID for traffic with CVLAN/untagged

SW3(config-if)#exit	Exit interface mode
SW3(config-if)#interface eth2	Enter interface configuration mode for eth2
SW3(config-if)#switchport	Make interface as switchport
SW3(config-if)#bridge-group 1	Associate interface with bridge-group 1
SW3(config-if)#switchport mode provider-network	Configure switchport pnp port
SW3(config-if)#switchport provider-network allowed vlan all	Associate all svlan to the port
SW3(config-if)#commit	Commit the configuration.
SW3(config-if)#exit	Exit interface configuration mode

Validation

```
SW3#show bridge
bridge 1 is running on provider-rstp edge
Ageout time is global and if something is configured for vxlan then it will be affected here also
```

Bridge	CVLAN	SVLAN	BVLAN	Port	MAC Address	FWD	Time-out
1		200		eth1	0000.0000.0f00	1	300
1	1	200		eth2	0001.0000.0800	1	300

```
SW1#show bridge
bridge 1 is running on provider-rstp edge
Ageout time is global and if something is configured for vxlan then it will be affected here also
```

Bridge	CVLAN	SVLAN	BVLAN	Port	MAC Address	FWD	Time-out
1		200		eth2	0000.0000.0f00	1	300
1	1	200		eth1	0001.0000.0800	1	300

CHAPTER 4 Spanning Tree Protocol Configuration

This chapter contains a complete sample Spanning Tree Protocol (STP) configuration.

Spanning Tree Protocol (STP) is a network protocol that ensures a loop-free topology for Ethernet networks. The basic function of STP is to prevent bridge loops. Spanning tree also allows a network design to include redundant links to provide automatic backup paths if an active link fails, thus, eliminating the need to manually enable or disable the backup links.

Topology

The following example is a simple multi-bridge topology.

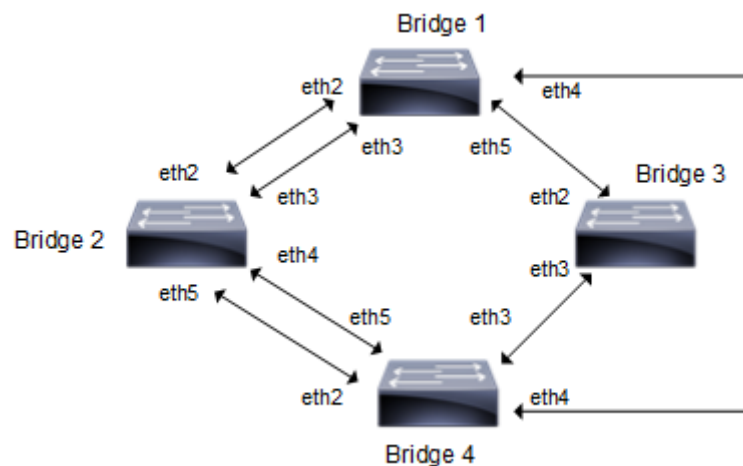

Figure 4-12: STP Topology

Note: Run the `switchport` command on each port to change to Layer-2 mode.

Configurations

Bridge 1

<code>Bridge1#configure terminal</code>	Enter configure mode.
<code>Bridge1(config)#bridge 1 protocol ieee</code>	Add a bridge (1) to the spanning tree table
<code>Bridge1(config)#interface eth2</code>	Enter interface mode.
<code>Bridge1(config-if)#switchport</code>	Configure interface as a layer 2 port.
<code>Bridge1(config-if)#bridge-group 1</code>	Associate the interface with bridge group 1.
<code>Bridge1(config-if)#commit</code>	Commit the candidate configuration to the running configuration.
<code>Bridge1(config-if)#exit</code>	Exit interface mode.
<code>Bridge1(config)#interface eth3</code>	Enter interface mode.
<code>Bridge1(config-if)#switchport</code>	Configure interface as a layer 2 port.
<code>Bridge1(config-if)#bridge-group 1</code>	Associate the interface with bridge group 1.

Bridge1(config-if)#commit	Commit the candidate configuration to the running configuration.
Bridge1(config-if)#exit	Exit interface mode.
Bridge1(config)#interface eth4	Enter interface mode.
Bridge1(config-if)#switchport	Configure interface as a layer 2 port.
Bridge1(config-if)#bridge-group 1	Associate the interface with bridge group 1.
Bridge1(config-if)#commit	Commit the candidate configuration to the running configuration.
Bridge1(config-if)#exit	Exit interface mode.
Bridge1(config)#interface eth5	Enter interface mode
Bridge1(config-if)#switchport	Configure interface as a layer 2 port.
Bridge1(config-if)#bridge-group 1	Associate the interface with bridge group 1.
Bridge1(config-if)#commit	Commit the candidate configuration to the running configuration.
Bridge1(config-if)#exit	Exit interface mode.

Bridge 2

Bridge2#configure terminal	Enter configure mode.
Bridge2(config)#bridge 2 protocol ieee	Add a bridge (2) to the spanning tree table
Bridge2(config)#interface eth2	Enter interface mode.
Bridge2(config-if)#switchport	Configure interface as a layer 2 port.
Bridge2(config-if)#bridge-group 2	Associate the interface with bridge group 2.
Bridge2(config-if)#commit	Commit the candidate configuration to the running configuration.
Bridge2(config-if)#exit	Exit interface mode.
Bridge2(config)#interface eth3	Enter interface mode.
Bridge2(config-if)#switchport	Configure interface as a layer 2 port.
Bridge2(config-if)#bridge-group 2	Associate the interface with bridge group 2.
Bridge2(config-if)#exit	Exit interface mode.
Bridge2(config)#interface eth4	Enter interface mode.
Bridge2(config-if)#switchport	Configure interface as a layer 2 port.
Bridge2(config-if)#bridge-group 2	Associate the interface with bridge group 2.
Bridge2(config-if)#commit	Commit the candidate configuration to the running configuration.
Bridge2(config-if)#exit	Exit interface mode.
Bridge2(config)#interface eth5	Enter interface mode
Bridge2(config-if)#switchport	Configure interface as a layer 2 port.
Bridge2(config-if)#bridge-group 2	Associate the interface with bridge group 2.
Bridge2(config-if)#commit	Commit the candidate configuration to the running configuration.
Bridge2(config-if)#exit	Exit interface mode.

Bridge 4

Bridge4#configure terminal	Enter configure mode.
Bridge4(config)#bridge 4 protocol ieee	Add a bridge (4) to the spanning tree table
Bridge4(config)#interface eth2	Enter interface mode.
Bridge4(config-if)#switchport	Configure interface as a layer 2 port.
Bridge4(config-if)#bridge-group 4	Associate the interface with bridge group 4.
Bridge4(config-if)#commit	Commit the candidate configuration to the running configuration.
Bridge4(config-if)#exit	Exit interface mode.
Bridge4(config)#interface eth3	Enter interface mode.
Bridge4(config-if)#switchport	Configure interface as a layer 2 port.
Bridge4(config-if)#bridge-group 4	Associate the interface with bridge group 4.
Bridge4(config-if)#commit	Commit the candidate configuration to the running configuration.
Bridge4(config-if)#exit	Exit interface mode.
Bridge4(config)#interface eth4	Enter interface mode.
Bridge4(config-if)#switchport	Configure interface as a layer 2 port.
Bridge4(config-if)#bridge-group 4	Associate the interface with bridge group 4.
Bridge4(config-if)#commit	Commit the candidate configuration to the running configuration.
Bridge4(config-if)#exit	Exit interface mode.
Bridge4(config)#interface eth5	Enter interface mode
Bridge4(config-if)#switchport	Configure interface as a layer 2 port.
Bridge4(config-if)#bridge-group 4	Associate the interface with bridge group 4.
Bridge4(config-if)#commit	Commit the candidate configuration to the running configuration.
Bridge4(config-if)#exit	Exit interface mode.

Bridge 3

Bridge3#configure terminal	Enter configure mode.
Bridge3(config)#bridge 3 protocol ieee	Add a bridge (3) to the spanning tree table
Bridge3(config)#interface eth2	Enter interface mode.
Bridge3(config-if)#switchport	Configure interface as a layer 2 port.
Bridge3(config-if)#bridge-group 3	Associate the interface with bridge group 3.
Bridge3(config-if)#commit	Commit the candidate configuration to the running configuration.
Bridge3(config-if)#exit	Exit interface mode.
Bridge3(config)#interface eth3	Enter interface mode.
Bridge3(config-if)#switchport	Configure interface as a layer 2 port.
Bridge3(config-if)#bridge-group 3	Associate the interface with bridge group 3.

Bridge3(config-if)#commit	Commit the candidate configuration to the running configuration.
Bridge3(config-if)#exit	Exit interface mode.

Validation

Bridge 1

```
#show spanning-tree
% 1: Bridge up - Spanning Tree Enabled
% 1: Root Path Cost 0 - Priority 32768
% 1: Forward Delay 15 - Hello Time 2 - Max Age 20 - Transmit Hold Count 6 - Root port 0
% 1: Root Id 80005254000be278
% 1: Bridge Id 80005254000be278
% 1: 15 topology changes - last topology change Sat Jul 10 09:44:56 2021
% 1: portfast bpdu-filter disabled
% 1: portfast bpdu-guard disabled
% eth1: Port Number 3 - Ifindex 3 - Port Id 0x8003 - path cost 250 - designated cost 0
% eth1: Designated Port Id 0x8003 - state Forwarding -Priority 128
% eth1: Designated root 80005254000be278
% eth1: Designated Bridge 80005254000be278
% eth1: Message Age 0 - Max Age 20
% eth1: Hello Time 2 - Forward Delay 15
% eth1: Forward Timer 0 - Msg Age Timer 0 - Hello Timer 0 - topo change timer 0
% eth1: forward-transitions 1
% eth1: Restricted-role OFF
% eth1: No portfast configured - Current portfast off
% eth1: bpdu-guard default - Current bpdu-guard off
% eth1: bpdu-filter default - Current bpdu-filter off
% eth1: no root guard configured - Current root guard off
%
% eth2: Port Number 4 - Ifindex 4 - Port Id 0x8004 - path cost 250 - designated cost 0
% eth2: Designated Port Id 0x8004 - state Forwarding -Priority 128
% eth2: Designated root 80005254000be278
% eth2: Designated Bridge 80005254000be278
% eth2: Message Age 0 - Max Age 20
% eth2: Hello Time 2 - Forward Delay 15
% eth2: Forward Timer 0 - Msg Age Timer 0 - Hello Timer 0 - topo change timer 0
% eth2: forward-transitions 1
% eth2: Restricted-role OFF
% eth2: No portfast configured - Current portfast off
% eth2: bpdu-guard default - Current bpdu-guard off
% eth2: bpdu-filter default - Current bpdu-filter off
% eth2: no root guard configured - Current root guard off
%
% eth3: Port Number 5 - Ifindex 5 - Port Id 0x8005 - path cost 250 - designated cost 0
% eth3: Designated Port Id 0x8005 - state Forwarding -Priority 128
% eth3: Designated root 80005254000be278
% eth3: Designated Bridge 80005254000be278
% eth3: Message Age 0 - Max Age 20
```

```
% eth3: Hello Time 2 - Forward Delay 15
% eth3: Forward Timer 0 - Msg Age Timer 0 - Hello Timer 0 - topo change timer 0
% eth3: forward-transitions 1
% eth3: Restricted-role OFF
% eth3: No portfast configured - Current portfast off
% eth3: bpdu-guard default - Current bpdu-guard off
% eth3: bpdu-filter default - Current bpdu-filter off
% eth3: no root guard configured - Current root guard off
%
% eth4: Port Number 6 - Ifindex 6 - Port Id 0x8006 - path cost 250 - designated cost 0
% eth4: Designated Port Id 0x8006 - state Forwarding -Priority 128
% eth4: Designated root 80005254000be278
% eth4: Designated Bridge 80005254000be278
% eth4: Message Age 0 - Max Age 20
% eth4: Hello Time 2 - Forward Delay 15
% eth4: Forward Timer 0 - Msg Age Timer 0 - Hello Timer 0 - topo change timer 0
% eth4: forward-transitions 1
% eth4: Restricted-role OFF
% eth4: No portfast configured - Current portfast off
% eth4: bpdu-guard default - Current bpdu-guard off
% eth4: bpdu-filter default - Current bpdu-filter off
% eth4: no root guard configured - Current root guard off
%
% Default: Bridge up - Spanning Tree Enabled
% Default: Root Path Cost 0 - Root Port 0 - Bridge Priority 32768
% Default: Forward Delay 15 - Hello Time 2 - Max Age 20 - Transmit Hold Count 6
% Default: Root Id 8000000000000000
% Default: Bridge Id 8000000000000000
% Default: last topology change Thu Jan 1 00:00:00 1970
% Default: 0 topology change(s) - last topology change Thu Jan 1 00:00:00 1970

% Default: portfast bpdu-filter disabled
% Default: portfast bpdu-guard disabled

#show spanning-tree interface eth1
% 1: Bridge up - Spanning Tree Enabled
% 1: Root Path Cost 0 - Priority 32768
% 1: Forward Delay 15 - Hello Time 2 - Max Age 20 - Transmit Hold Count 6 - Root port 0
% 1: Root Id 80005254000be278
% 1: Bridge Id 80005254000be278
% 1: 15 topology changes - last topology change Sat Jul 10 09:44:56 2021
% 1: portfast bpdu-filter disabled
% 1: portfast bpdu-guard disabled
% eth1: Port Number 3 - Ifindex 3 - Port Id 0x8003 - path cost 250 - designated cost 0
% eth1: Designated Port Id 0x8003 - state Forwarding -Priority 128
% eth1: Designated root 80005254000be278
% eth1: Designated Bridge 80005254000be278
% eth1: Message Age 0 - Max Age 20
% eth1: Hello Time 2 - Forward Delay 15
```

```
% eth1: Forward Timer 0 - Msg Age Timer 0 - Hello Timer 0 - topo change timer 0
% eth1: forward-transitions 1
% eth1: Restricted-role OFF
% eth1: No portfast configured - Current portfast off
% eth1: bpdu-guard default - Current bpdu-guard off
% eth1: bpdu-filter default - Current bpdu-filter off
% eth1: no root guard configured - Current root guard off
```

Bridge 2

```
#show spanning-tree
% 2: Bridge up - Spanning Tree Enabled
% 2: Root Path Cost 250 - Priority 32768
% 2: Forward Delay 15 - Hello Time 2 - Max Age 20 - Transmit Hold Count 6 - Root port 3
% 2: Root Id 80005254000be278
% 2: Bridge Id 8000525400b210cd
% 2: 5 topology changes - last topology change Sat Jul 10 09:44:30 2021
% 2: portfast bpdu-filter disabled
% 2: portfast bpdu-guard disabled
% eth1: Port Number 3 - Ifindex 3 - Port Id 0x8003 - path cost 250 - designated cost 0
% eth1: Designated Port Id 0x8003 - state Forwarding -Priority 128
% eth1: Designated root 80005254000be278
% eth1: Designated Bridge 80005254000be278
% eth1: Message Age 0 - Max Age 20
% eth1: Hello Time 2 - Forward Delay 15
% eth1: Forward Timer 0 - Msg Age Timer 18 - Hello Timer 0 - topo change timer 0
% eth1: forward-transitions 1
% eth1: Restricted-role OFF
% eth1: No portfast configured - Current portfast off
% eth1: bpdu-guard default - Current bpdu-guard off
% eth1: bpdu-filter default - Current bpdu-filter off
% eth1: no root guard configured - Current root guard off
%
% eth2: Port Number 4 - Ifindex 4 - Port Id 0x8004 - path cost 250 - designated cost 0
% eth2: Designated Port Id 0x8004 - state Blocked -Priority 128
% eth2: Designated root 80005254000be278
% eth2: Designated Bridge 80005254000be278
% eth2: Message Age 0 - Max Age 20
% eth2: Hello Time 2 - Forward Delay 15
% eth2: Forward Timer 0 - Msg Age Timer 17 - Hello Timer 0 - topo change timer 0
% eth2: forward-transitions 0
% eth2: Restricted-role OFF
% eth2: No portfast configured - Current portfast off
% eth2: bpdu-guard default - Current bpdu-guard off
% eth2: bpdu-filter default - Current bpdu-filter off
% eth2: no root guard configured - Current root guard off
%
% eth3: Port Number 5 - Ifindex 5 - Port Id 0x8005 - path cost 250 - designated cost
250
% eth3: Designated Port Id 0x8005 - state Blocked -Priority 128
% eth3: Designated root 80005254000be278
% eth3: Designated Bridge 800052540047dc01
```



```
% eth3: Message Age 3 - Max Age 20
% eth3: Hello Time 2 - Forward Delay 15
% eth3: Forward Timer 0 - Msg Age Timer 13 - Hello Timer 0 - topo change timer 0
% eth3: forward-transitions 1
% eth3: Restricted-role OFF
% eth3: No portfast configured - Current portfast off
% eth3: bpdu-guard default - Current bpdu-guard off
% eth3: bpdu-filter default - Current bpdu-filter off
% eth3: no root guard configured - Current root guard off
%
% eth4: Port Number 6 - Ifindex 6 - Port Id 0x8006 - path cost 250 - designated cost
250
% eth4: Designated Port Id 0x8006 - state Blocked -Priority 128
% eth4: Designated root 80005254000be278
% eth4: Designated Bridge 800052540047dc01
% eth4: Message Age 3 - Max Age 20
% eth4: Hello Time 2 - Forward Delay 15
% eth4: Forward Timer 0 - Msg Age Timer 13 - Hello Timer 0 - topo change timer 0
% eth4: forward-transitions 1
% eth4: Restricted-role OFF
% eth4: No portfast configured - Current portfast off
% eth4: bpdu-guard default - Current bpdu-guard off
% eth4: bpdu-filter default - Current bpdu-filter off
% eth4: no root guard configured - Current root guard off
%
% Default: Bridge up - Spanning Tree Enabled
% Default: Root Path Cost 0 - Root Port 0 - Bridge Priority 32768
% Default: Forward Delay 15 - Hello Time 2 - Max Age 20 - Transmit Hold Count 6
% Default: Root Id 8000000000000000
% Default: Bridge Id 8000000000000000
% Default: last topology change Thu Jan 1 00:00:00 1970
% Default: 0 topology change(s) - last topology change Thu Jan 1 00:00:00 1970

% Default: portfast bpdu-filter disabled
% Default: portfast bpdu-guard disabled

#show spanning-tree interface eth1
% 2: Bridge up - Spanning Tree Enabled
% 2: Root Path Cost 250 - Priority 32768
% 2: Forward Delay 15 - Hello Time 2 - Max Age 20 - Transmit Hold Count 6 - Root port 3
% 2: Root Id 80005254000be278
% 2: Bridge Id 8000525400b210cd
% 2: 5 topology changes - last topology change Sat Jul 10 09:44:30 2021
% 2: portfast bpdu-filter disabled
% 2: portfast bpdu-guard disabled
% eth1: Port Number 3 - Ifindex 3 - Port Id 0x8003 - path cost 250 - designated cost 0
% eth1: Designated Port Id 0x8003 - state Forwarding -Priority 128
% eth1: Designated root 80005254000be278
% eth1: Designated Bridge 80005254000be278
% eth1: Message Age 0 - Max Age 20
```

```
% eth1: Hello Time 2 - Forward Delay 15
% eth1: Forward Timer 0 - Msg Age Timer 17 - Hello Timer 0 - topo change timer 0
% eth1: forward-transitions 1
% eth1: Restricted-role OFF
% eth1: No portfast configured - Current portfast off
% eth1: bpdu-guard default - Current bpdu-guard off
% eth1: bpdu-filter default - Current bpdu-filter off
% eth1: no root guard configured - Current root guard off
```

Bridge 3

```
#sho spanning-tree
% 3: Bridge up - Spanning Tree Enabled
% 3: Root Path Cost 250 - Priority 32768
% 3: Forward Delay 15 - Hello Time 2 - Max Age 20 - Transmit Hold Count 6 - Root port 3
% 3: Root Id 80005254000be278
% 3: Bridge Id 8000525400686eb9
% 3: 2 topology changes - last topology change Sat Jul 10 09:37:36 2021
% 3: portfast bpdu-filter disabled
% 3: portfast bpdu-guard disabled
% eth1: Port Number 3 - Ifindex 3 - Port Id 0x8003 - path cost 250 - designated cost 0
% eth1: Designated Port Id 0x8005 - state Forwarding -Priority 128
% eth1: Designated root 80005254000be278
% eth1: Designated Bridge 80005254000be278
% eth1: Message Age 0 - Max Age 20
% eth1: Hello Time 2 - Forward Delay 15
% eth1: Forward Timer 0 - Msg Age Timer 18 - Hello Timer 0 - topo change timer 0
% eth1: forward-transitions 1
% eth1: Restricted-role OFF
% eth1: No portfast configured - Current portfast off
% eth1: bpdu-guard default - Current bpdu-guard off
% eth1: bpdu-filter default - Current bpdu-filter off
% eth1: no root guard configured - Current root guard off
%
% eth2: Port Number 4 - Ifindex 4 - Port Id 0x8004 - path cost 250 - designated cost
250
% eth2: Designated Port Id 0x8004 - state Forwarding -Priority 128
% eth2: Designated root 80005254000be278
% eth2: Designated Bridge 8000525400686eb9
% eth2: Message Age 1 - Max Age 20
% eth2: Hello Time 2 - Forward Delay 15
% eth2: Forward Timer 0 - Msg Age Timer 0 - Hello Timer 0 - topo change timer 0
% eth2: forward-transitions 1
% eth2: Restricted-role OFF
% eth2: No portfast configured - Current portfast off
% eth2: bpdu-guard default - Current bpdu-guard off
% eth2: bpdu-filter default - Current bpdu-filter off
% eth2: no root guard configured - Current root guard off
%
% Default: Bridge up - Spanning Tree Enabled - topology change detected
% Default: Root Path Cost 0 - Root Port 0 - Bridge Priority 32768
% Default: Forward Delay 15 - Hello Time 2 - Max Age 20 - Transmit Hold Count 6
```

```
% Default: Root Id 800000000000000000
% Default: Bridge Id 800000000000000000
% Default: last topology change Sat Jul 10 09:37:04 2021
% Default: 1 topology change(s) - last topology change Sat Jul 10 09:37:04 2021

% Default: portfast bpdu-filter disabled
% Default: portfast bpdu-guard disabled

# show spanning-tree interface eth1
% 3: Bridge up - Spanning Tree Enabled
% 3: Root Path Cost 250 - Priority 32768
% 3: Forward Delay 15 - Hello Time 2 - Max Age 20 - Transmit Hold Count 6 - Root port 3
% 3: Root Id 80005254000be278
% 3: Bridge Id 8000525400686eb9
% 3: 2 topology changes - last topology change Sat Jul 10 09:37:36 2021
% 3: portfast bpdu-filter disabled
% 3: portfast bpdu-guard disabled
% eth1: Port Number 3 - Ifindex 3 - Port Id 0x8003 - path cost 250 - designated cost 0
% eth1: Designated Port Id 0x8005 - state Forwarding -Priority 128
% eth1: Designated root 80005254000be278
% eth1: Designated Bridge 80005254000be278
% eth1: Message Age 0 - Max Age 20
% eth1: Hello Time 2 - Forward Delay 15
% eth1: Forward Timer 0 - Msg Age Timer 17 - Hello Timer 0 - topo change timer 0
% eth1: forward-transitions 1
% eth1: Restricted-role OFF
% eth1: No portfast configured - Current portfast off
% eth1: bpdu-guard default - Current bpdu-guard off
% eth1: bpdu-filter default - Current bpdu-filter off
% eth1: no root guard configured - Current root guard off
```

Bridge 4

```
#show spanning-tree
% 4: Bridge up - Spanning Tree Enabled
% 4: Root Path Cost 250 - Priority 32768
% 4: Forward Delay 15 - Hello Time 2 - Max Age 20 - Transmit Hold Count 6 - Root port 3
% 4: Root Id 80005254000be278
% 4: Bridge Id 800052540047dc01
% 4: 4 topology changes - last topology change Sat Jul 10 09:44:56 2021
% 4: portfast bpdu-filter disabled
% 4: portfast bpdu-guard disabled
% eth1: Port Number 3 - Ifindex 3 - Port Id 0x8003 - path cost 250 - designated cost 0
% eth1: Designated Port Id 0x8006 - state Forwarding -Priority 128
% eth1: Designated root 80005254000be278
% eth1: Designated Bridge 80005254000be278
% eth1: Message Age 0 - Max Age 20
% eth1: Hello Time 2 - Forward Delay 15
% eth1: Forward Timer 0 - Msg Age Timer 17 - Hello Timer 0 - topo change timer 0
% eth1: forward-transitions 1
```

```
% eth1: Restricted-role OFF
% eth1: No portfast configured - Current portfast off
% eth1: bpdu-guard default - Current bpdu-guard off
% eth1: bpdu-filter default - Current bpdu-filter off
% eth1: no root guard configured - Current root guard off
%
% eth2: Port Number 4 - Ifindex 4 - Port Id 0x8004 - path cost 250 - designated cost
250
% eth2: Designated Port Id 0x8004 - state Forwarding -Priority 128
% eth2: Designated root 80005254000be278
% eth2: Designated Bridge 800052540047dc01
% eth2: Message Age 1 - Max Age 20
% eth2: Hello Time 2 - Forward Delay 15
% eth2: Forward Timer 0 - Msg Age Timer 0 - Hello Timer 0 - topo change timer 0
% eth2: forward-transitions 1
% eth2: Restricted-role OFF
% eth2: No portfast configured - Current portfast off
% eth2: bpdu-guard default - Current bpdu-guard off
% eth2: bpdu-filter default - Current bpdu-filter off
% eth2: no root guard configured - Current root guard off
%
% eth3: Port Number 5 - Ifindex 5 - Port Id 0x8005 - path cost 250 - designated cost
250
% eth3: Designated Port Id 0x8005 - state Forwarding -Priority 128
% eth3: Designated root 80005254000be278
% eth3: Designated Bridge 800052540047dc01
% eth3: Message Age 1 - Max Age 20
% eth3: Hello Time 2 - Forward Delay 15
% eth3: Forward Timer 0 - Msg Age Timer 0 - Hello Timer 0 - topo change timer 0
% eth3: forward-transitions 1
% eth3: Restricted-role OFF
% eth3: No portfast configured - Current portfast off
% eth3: bpdu-guard default - Current bpdu-guard off
% eth3: bpdu-filter default - Current bpdu-filter off
% eth3: no root guard configured - Current root guard off
%
% eth4: Port Number 6 - Ifindex 6 - Port Id 0x8006 - path cost 250 - designated cost
250
% eth4: Designated Port Id 0x8006 - state Forwarding -Priority 128
% eth4: Designated root 80005254000be278
% eth4: Designated Bridge 800052540047dc01
% eth4: Message Age 1 - Max Age 20
% eth4: Hello Time 2 - Forward Delay 15
% eth4: Forward Timer 0 - Msg Age Timer 0 - Hello Timer 0 - topo change timer 0
% eth4: forward-transitions 1
% eth4: Restricted-role OFF
% eth4: No portfast configured - Current portfast off
% eth4: bpdu-guard default - Current bpdu-guard off
% eth4: bpdu-filter default - Current bpdu-filter off
% eth4: no root guard configured - Current root guard off
%
```

```
# show spanning-tree interface eth1
% 4: Bridge up - Spanning Tree Enabled
% 4: Root Path Cost 250 - Priority 32768
% 4: Forward Delay 15 - Hello Time 2 - Max Age 20 - Transmit Hold Count 6 - Root port 3
% 4: Root Id 80005254000be278
% 4: Bridge Id 800052540047dc01
% 4: 4 topology changes - last topology change Sat Jul 10 09:44:56 2021
% 4: portfast bpdu-filter disabled
% 4: portfast bpdu-guard disabled
% eth1: Port Number 3 - Ifindex 3 - Port Id 0x8003 - path cost 250 - designated cost 0
% eth1: Designated Port Id 0x8006 - state Forwarding -Priority 128
% eth1: Designated root 80005254000be278
% eth1: Designated Bridge 80005254000be278
% eth1: Message Age 0 - Max Age 20
% eth1: Hello Time 2 - Forward Delay 15
% eth1: Forward Timer 0 - Msg Age Timer 18 - Hello Timer 0 - topo change timer 0
% eth1: forward-transitions 1
% eth1: Restricted-role OFF
% eth1: No portfast configured - Current portfast off
% eth1: bpdu-guard default - Current bpdu-guard off
% eth1: bpdu-filter default - Current bpdu-filter off
% eth1: no root guard configured - Current root guard off
%
%
```

CHAPTER 5 RSTP Configuration

This chapter contains a complete sample Rapid Spanning Tree Protocol (RSTP) configuration. RSTP provides rapid convergence of a spanning tree. It speeds up the reconfiguration of the tree after a change by using alternate ports.

Topology

The following example is a simple multi-bridge topology.

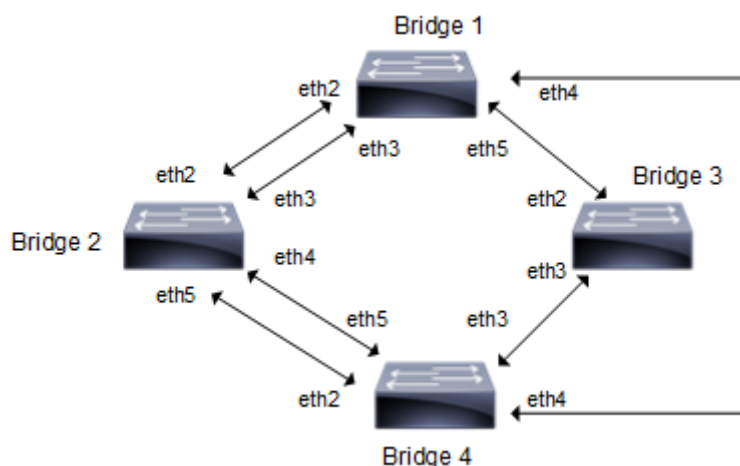

Figure 5-13: RSTP Topology

Note: Run the `switchport` command on each port to change to Layer-2 mode.

Configuration

Bridge 1

<code>Bridge1#configure terminal</code>	Enter configure mode.
<code>Bridge1(config)#bridge 1 protocol rstp</code>	Add a bridge (1) to the rapid spanning tree table
<code>Bridge1(config)#interface eth2</code>	Enter interface mode.
<code>Bridge1(config-if)#switchport</code>	Configure interface as a layer 2 port.
<code>Bridge1(config-if)#bridge-group 1</code>	Associate the interface with bridge group 1.
<code>Bridge1(config-if)#exit</code>	Exit interface mode.
<code>Bridge1(config)#interface eth3</code>	Enter interface mode.
<code>Bridge1(config-if)#switchport</code>	Configure interface as a layer 2 port.
<code>Bridge1(config-if)#bridge-group 1</code>	Associate the interface with bridge group 1.
<code>Bridge1(config-if)#exit</code>	Exit interface mode.
<code>Bridge1(config)#interface eth4</code>	Enter interface mode.
<code>Bridge1(config-if)#switchport</code>	Configure interface as a layer 2 port.
<code>Bridge1(config-if)#bridge-group 1</code>	Associate the interface with bridge group 1.
<code>Bridge1(config-if)#exit</code>	Exit interface mode.

Bridge1(config)#interface eth5	Enter interface mode
Bridge1(config-if)#switchport	Configure interface as a layer 2 port.
Bridge1(config-if)#bridge-group 1	Associate the interface with bridge group 1.
Bridge1(config-if)#commit	Commit the configure on the node.
Bridge1(config-if)#exit	Exit interface mode.

Bridge 2

Bridge2#configure terminal	Enter configure mode.
Bridge2(config)#bridge 2 protocol rstp	Add a bridge (2) to the rapid spanning tree table
Bridge2(config)#interface eth2	Enter interface mode.
Bridge2(config-if)#switchport	Configure interface as a layer 2 port.
Bridge2(config-if)#bridge-group 2	Associate the interface with bridge group 2.
Bridge2(config-if)#exit	Exit interface mode.
Bridge2(config)#interface eth3	Enter interface mode.
Bridge2(config-if)#switchport	Configure interface as a layer 2 port.
Bridge2(config-if)#bridge-group 2	Associate the interface with bridge group 2.
Bridge2(config-if)#exit	Exit interface mode.
Bridge2(config)#interface eth4	Enter interface mode.
Bridge2(config-if)#switchport	Configure interface as a layer 2 port.
Bridge2(config-if)#bridge-group 2	Associate the interface with bridge group 2.
Bridge2(config-if)#exit	Exit interface mode.
Bridge2(config)#interface eth5	Enter interface mode
Bridge2(config-if)#switchport	Configure interface as a layer 2 port.
Bridge2(config-if)#bridge-group 2	Associate the interface with bridge group 2.
Bridge2(config-if)#commit	Commit the configure on the node.
Bridge2(config-if)#exit	Exit interface mode.

Bridge 3

Bridge3#configure terminal	Enter configure mode.
Bridge3(config)#bridge 3 protocol rstp	Add a bridge (3) to the rapid spanning tree table
Bridge3(config)#interface eth2	Enter interface mode.
Bridge3(config-if)#switchport	Configure interface as a layer 2 port.
Bridge3(config-if)#bridge-group 3	Associate the interface with bridge group 3.
Bridge3(config-if)#exit	Exit interface mode.
Bridge3(config)#interface eth3	Enter interface mode.
Bridge3(config-if)#switchport	Configure interface as a layer 2 port.
Bridge3(config-if)#bridge-group 3	Associate the interface with bridge group 3.
Bridge3(config-if)#commit	Commit the configure on the node.
Bridge3(config-if)#exit	Exit interface mode.

Bridge 4

Bridge4#configure terminal	Enter configure mode.
Bridge4(config)#bridge 4 protocol rstp	Add a bridge (4) to the rapid spanning tree table
Bridge4(config)#interface eth2	Enter interface mode.
Bridge4(config-if)#switchport	Configure interface as a layer 2 port.
Bridge4(config-if)#bridge-group 4	Associate the interface with bridge group 4.
Bridge4(config-if)#exit	Exit interface mode.
Bridge4(config)#interface eth3	Enter interface mode.
Bridge4(config-if)#switchport	Configure interface as a layer 2 port.
Bridge4(config-if)#bridge-group 4	Associate the interface with bridge group 4.
Bridge4(config-if)#exit	Exit interface mode.
Bridge4(config)#interface eth4	Enter interface mode.
Bridge4(config-if)#switchport	Configure interface as a layer 2 port.
Bridge4(config-if)#bridge-group 4	Associate the interface with bridge group 4.
Bridge4(config-if)#exit	Exit interface mode.
Bridge4(config)#interface eth5	Enter interface mode
Bridge4(config-if)#switchport	Configure interface as a layer 2 port.
Bridge4(config-if)#bridge-group 4	Associate the interface with bridge group 4.
Bridge4(config-if)#commit	Commit the configure on the node.
Bridge4(config-if)#exit	Exit interface mode.

Validation

show spanning-tree, show spanning-tree interface <if-name>

Bridge 1

```
#show spanning-tree
% 1: Bridge up - Spanning Tree Enabled - topology change detected
% 1: Root Path Cost 200000 - Root Port 6 - Bridge Priority 32768
% 1: Forward Delay 15 - Hello Time 2 - Max Age 20 - Transmit Hold Count 6
% 1: Root Id 800052540046f549
% 1: Bridge Id 80005254009cb7e6
% 1: last topology change Tue Aug 11 02:25:01 2020
% 1: 30 topology change(s) - last topology change Tue Aug 11 02:25:01 2020

% 1: portfast bpdu-filter disabled
% 1: portfast bpdu-guard disabled
% eth2: Port Number 4 - Ifindex 4 - Port Id 0x8004 - Role Alternate - State Discarding
% eth2: Designated Path Cost 200000
% eth2: Configured Path Cost 200000 - Add type Explicit ref count 1
% eth2: Designated Port Id 0x8004 - Priority 128 -
% eth2: Root 800052540046f549
% eth2: Designated Bridge 8000525400751db5
% eth2: Message Age 1 - Max Age 20
% eth2: Hello Time 2 - Forward Delay 15
```



```
% eth2: Forward Timer 0 - Msg Age Timer 4 - Hello Timer 0 - topo change
timer 0
% eth2: forward-transitions 2
% eth2: Restricted-role OFF
% eth2: Version Rapid Spanning Tree Protocol - Receive RSTP - Send RSTP
% eth2: No portfast configured - Current portfast off
% eth2: bpdu-guard default - Current bpdu-guard off
% eth2: bpdu-filter default - Current bpdu-filter off
% eth2: no root guard configured - Current root guard off
% eth2: Configured Link Type point-to-point - Current point-to-point
% eth2: No auto-edge configured - Current port Auto Edge off
%
% eth3: Port Number 5 - Ifindex 5 - Port Id 0x8005 - Role Alternate - State
Discarding
% eth3: Designated Path Cost 200000
% eth3: Configured Path Cost 200000 - Add type Explicit ref count 1
% eth3: Designated Port Id 0x8005 - Priority 128 -
% eth3: Root 800052540046f549
% eth3: Designated Bridge 8000525400751db5
% eth3: Message Age 1 - Max Age 20
% eth3: Hello Time 2 - Forward Delay 15
% eth3: Forward Timer 0 - Msg Age Timer 3 - Hello Timer 0 - topo change
timer 0
% eth3: forward-transitions 3
% eth3: Restricted-role OFF
% eth3: Version Rapid Spanning Tree Protocol - Receive RSTP - Send RSTP
% eth3: No portfast configured - Current portfast off
% eth3: bpdu-guard default - Current bpdu-guard off
% eth3: bpdu-filter default - Current bpdu-filter off
% eth3: no root guard configured - Current root guard off
% eth3: Configured Link Type point-to-point - Current point-to-point
% eth3: No auto-edge configured - Current port Auto Edge off
%
% eth4: Port Number 6 - Ifindex 6 - Port Id 0x8006 - Role Rootport - State
Forwarding
% eth4: Designated Path Cost 0
% eth4: Configured Path Cost 200000 - Add type Explicit ref count 1
% eth4: Designated Port Id 0x8006 - Priority 128 -
% eth4: Root 800052540046f549
% eth4: Designated Bridge 800052540046f549
% eth4: Message Age 0 - Max Age 20
% eth4: Hello Time 2 - Forward Delay 15
% eth4: Forward Timer 0 - Msg Age Timer 3 - Hello Timer 0 - topo change
timer 0
% eth4: forward-transitions 6
% eth4: Restricted-role OFF
% eth4: Version Rapid Spanning Tree Protocol - Receive RSTP - Send RSTP
% eth4: No portfast configured - Current portfast off
% eth4: bpdu-guard default - Current bpdu-guard off
% eth4: bpdu-filter default - Current bpdu-filter off
% eth4: no root guard configured - Current root guard off
% eth4: Configured Link Type point-to-point - Current point-to-point
% eth4: No auto-edge configured - Current port Auto Edge off
%
% eth5: Port Number 7 - Ifindex 7 - Port Id 0x8007 - Role Alternate - State
Discarding
% eth5: Designated Path Cost 200000
% eth5: Configured Path Cost 200000 - Add type Explicit ref count 1
```

```
% eth5: Designated Port Id 0x8004 - Priority 128 -
% eth5: Root 800052540046f549
% eth5: Designated Bridge 800052540065fd8c
% eth5: Message Age 1 - Max Age 20
% eth5: Hello Time 2 - Forward Delay 15
% eth5: Forward Timer 0 - Msg Age Timer 3 - Hello Timer 0 - topo change
timer 0
% eth5: forward-transitions 4
% eth5: Restricted-role OFF
% eth5: Version Rapid Spanning Tree Protocol - Receive RSTP - Send RSTP
% eth5: No portfast configured - Current portfast off
% eth5: bpdu-guard default - Current bpdu-guard off
% eth5: bpdu-filter default - Current bpdu-filter off
% eth5: no root guard configured - Current root guard off
% eth5: Configured Link Type point-to-point - Current point-to-point
% eth5: No auto-edge configured - Current port Auto Edge off
%
% Default: Bridge up - Spanning Tree Enabled
% Default: Root Path Cost 0 - Root Port 0 - Bridge Priority 32768
% Default: Forward Delay 15 - Hello Time 2 - Max Age 20 - Transmit Hold Count
6
% Default: Root Id 8000000000000000
% Default: Bridge Id 8000000000000000
% Default: last topology change Thu Jan 1 00:00:00 1970
% Default: 0 topology change(s) - last topology change Thu Jan 1 00:00:00
1970

% Default: portfast bpdu-filter disabled
% Default: portfast bpdu-guard disabled
```

Bridge 2

```
#show spanning-tree
% 2: Bridge up - Spanning Tree Enabled - topology change detected
% 2: Root Path Cost 200000 - Root Port 7 - Bridge Priority 32768
% 2: Forward Delay 15 - Hello Time 2 - Max Age 20 - Transmit Hold Count 6
% 2: Root Id 800052540046f549
% 2: Bridge Id 8000525400751db5
% 2: last topology change Tue Aug 11 02:25:00 2020
% 2: 22 topology change(s) - last topology change Tue Aug 11 02:25:00 2020

% 2: portfast bpdu-filter disabled
% 2: portfast bpdu-guard disabled
% eth2: Port Number 4 - Ifindex 4 - Port Id 0x8004 - Role Designated - State
Forwarding
% eth2: Designated Path Cost 200000
% eth2: Configured Path Cost 200000 - Add type Explicit ref count 1
% eth2: Designated Port Id 0x8004 - Priority 128 -
% eth2: Root 800052540046f549
% eth2: Designated Bridge 8000525400751db5
% eth2: Message Age 1 - Max Age 20
% eth2: Hello Time 2 - Forward Delay 15
% eth2: Forward Timer 0 - Msg Age Timer 0 - Hello Timer 0 - topo change
timer 0
% eth2: forward-transitions 3
% eth2: Restricted-role OFF
% eth2: Version Rapid Spanning Tree Protocol - Receive RSTP - Send RSTP
```

```
% eth2: No portfast configured - Current portfast off
% eth2: bpdu-guard default - Current bpdu-guard off
% eth2: bpdu-filter default - Current bpdu-filter off
% eth2: no root guard configured - Current root guard off
% eth2: Configured Link Type point-to-point - Current point-to-point
% eth2: No auto-edge configured - Current port Auto Edge off
%
% eth3: Port Number 5 - Ifindex 5 - Port Id 0x8005 - Role Designated - State
Forwarding
% eth3: Designated Path Cost 200000
% eth3: Configured Path Cost 200000 - Add type Explicit ref count 1
% eth3: Designated Port Id 0x8005 - Priority 128 -
% eth3: Root 800052540046f549
% eth3: Designated Bridge 8000525400751db5
% eth3: Message Age 1 - Max Age 20
% eth3: Hello Time 2 - Forward Delay 15
% eth3: Forward Timer 0 - Msg Age Timer 0 - Hello Timer 0 - topo change
timer 0
% eth3: forward-transitions 3
% eth3: Restricted-role OFF
% eth3: Version Rapid Spanning Tree Protocol - Receive RSTP - Send RSTP
% eth3: No portfast configured - Current portfast off
% eth3: bpdu-guard default - Current bpdu-guard off
% eth3: bpdu-filter default - Current bpdu-filter off
% eth3: no root guard configured - Current root guard off
% eth3: Configured Link Type point-to-point - Current point-to-point
% eth3: No auto-edge configured - Current port Auto Edge off
%
% eth4: Port Number 6 - Ifindex 6 - Port Id 0x8006 - Role Alternate - State
Discarding
% eth4: Designated Path Cost 0
% eth4: Configured Path Cost 200000 - Add type Explicit ref count 1
% eth4: Designated Port Id 0x8007 - Priority 128 -
% eth4: Root 800052540046f549
% eth4: Designated Bridge 800052540046f549
% eth4: Message Age 0 - Max Age 20
% eth4: Hello Time 2 - Forward Delay 15
% eth4: Forward Timer 0 - Msg Age Timer 4 - Hello Timer 0 - topo change
timer 0
% eth4: forward-transitions 3
% eth4: Restricted-role OFF
% eth4: Version Rapid Spanning Tree Protocol - Receive RSTP - Send RSTP
% eth4: No portfast configured - Current portfast off
% eth4: bpdu-guard default - Current bpdu-guard off
% eth4: bpdu-filter default - Current bpdu-filter off
% eth4: no root guard configured - Current root guard off
% eth4: Configured Link Type point-to-point - Current point-to-point
% eth4: No auto-edge configured - Current port Auto Edge off
%
% eth5: Port Number 7 - Ifindex 7 - Port Id 0x8007 - Role Rootport - State
Forwarding
% eth5: Designated Path Cost 0
% eth5: Configured Path Cost 200000 - Add type Explicit ref count 1
% eth5: Designated Port Id 0x8004 - Priority 128 -
% eth5: Root 800052540046f549
% eth5: Designated Bridge 800052540046f549
% eth5: Message Age 0 - Max Age 20
% eth5: Hello Time 2 - Forward Delay 15
```

```

% eth5: Forward Timer 0 - Msg Age Timer 4 - Hello Timer 0 - topo change
timer 0
% eth5: forward-transitions 2
% eth5: Restricted-role OFF
% eth5: Version Rapid Spanning Tree Protocol - Receive RSTP - Send RSTP
% eth5: No portfast configured - Current portfast off
% eth5: bpdu-guard default - Current bpdu-guard off
% eth5: bpdu-filter default - Current bpdu-filter off
% eth5: no root guard configured - Current root guard off
% eth5: Configured Link Type point-to-point - Current point-to-point
% eth5: No auto-edge configured - Current port Auto Edge off
%
% Default: Bridge up - Spanning Tree Enabled
% Default: Root Path Cost 0 - Root Port 0 - Bridge Priority 32768
% Default: Forward Delay 15 - Hello Time 2 - Max Age 20 - Transmit Hold Count
6
% Default: Root Id 8000000000000000
% Default: Bridge Id 8000000000000000
% Default: last topology change Thu Jan 1 00:00:00 1970
% Default: 0 topology change(s) - last topology change Thu Jan 1 00:00:00
1970

% Default: portfast bpdu-filter disabled
% Default: portfast bpdu-guard disabled

```

Bridge 3

```

#show spanning-tree
% 3: Bridge up - Spanning Tree Enabled - topology change detected
% 3: Root Path Cost 200000 - Root Port 5 - Bridge Priority 32768
% 3: Forward Delay 15 - Hello Time 2 - Max Age 20 - Transmit Hold Count 6
% 3: Root Id 800052540046f549
% 3: Bridge Id 800052540065fd8c
% 3: last topology change Tue Aug 11 02:25:00 2020
% 3: 16 topology change(s) - last topology change Tue Aug 11 02:25:00 2020

% 3: portfast bpdu-filter disabled
% 3: portfast bpdu-guard disabled
% eth2: Port Number 4 - Ifindex 4 - Port Id 0x8004 - Role Designated - State
Forwarding
% eth2: Designated Path Cost 200000
% eth2: Configured Path Cost 200000 - Add type Explicit ref count 1
% eth2: Designated Port Id 0x8004 - Priority 128 -
% eth2: Root 800052540046f549
% eth2: Designated Bridge 800052540065fd8c
% eth2: Message Age 1 - Max Age 20
% eth2: Hello Time 2 - Forward Delay 15
% eth2: Forward Timer 0 - Msg Age Timer 0 - Hello Timer 1 - topo change
timer 0
% eth2: forward-transitions 2
% eth2: Restricted-role OFF
% eth2: Version Rapid Spanning Tree Protocol - Receive RSTP - Send RSTP
% eth2: No portfast configured - Current portfast off
% eth2: bpdu-guard default - Current bpdu-guard off
% eth2: bpdu-filter default - Current bpdu-filter off
% eth2: no root guard configured - Current root guard off
% eth2: Configured Link Type point-to-point - Current point-to-point
% eth2: No auto-edge configured - Current port Auto Edge off

```

```

%
% eth3: Port Number 5 - Ifindex 5 - Port Id 0x8005 - Role Rootport - State
Forwarding
% eth3: Designated Path Cost 0
% eth3: Configured Path Cost 200000 - Add type Explicit ref count 1
% eth3: Designated Port Id 0x8005 - Priority 128 -
% eth3: Root 800052540046f549
% eth3: Designated Bridge 800052540046f549
% eth3: Message Age 0 - Max Age 20
% eth3: Hello Time 2 - Forward Delay 15
% eth3: Forward Timer 0 - Msg Age Timer 3 - Hello Timer 0 - topo change
timer 0
% eth3: forward-transitions 2
% eth3: Restricted-role OFF
% eth3: Version Rapid Spanning Tree Protocol - Receive RSTP - Send RSTP
% eth3: No portfast configured - Current portfast off
% eth3: bpdu-guard default - Current bpdu-guard off
% eth3: bpdu-filter default - Current bpdu-filter off
% eth3: no root guard configured - Current root guard off
% eth3: Configured Link Type point-to-point - Current point-to-point
% eth3: No auto-edge configured - Current port Auto Edge off
% Default: Bridge up - Spanning Tree Enabled
% Default: Root Path Cost 0 - Root Port 0 - Bridge Priority 32768
% Default: Forward Delay 15 - Hello Time 2 - Max Age 20 - Transmit Hold Count
6
% Default: Root Id 8000000000000000
% Default: Bridge Id 8000000000000000
% Default: last topology change Thu Jan 1 00:00:00 1970
% Default: 0 topology change(s) - last topology change Thu Jan 1 00:00:00
1970

% Default: portfast bpdu-filter disabled
% Default: portfast bpdu-guard disabled

```

Bridge 4

```

#show spanning-tree
% 4: Bridge up - Spanning Tree Enabled - topology change detected
% 4: Root Path Cost 0 - Root Port 0 - Bridge Priority 32768
% 4: Forward Delay 15 - Hello Time 2 - Max Age 20 - Transmit Hold Count 6
% 4: Root Id 800052540046f549
% 4: Bridge Id 800052540046f549
% 4: last topology change Tue Aug 11 02:24:58 2020
% 4: 6 topology change(s) - last topology change Tue Aug 11 02:24:58 2020

% 4: portfast bpdu-filter disabled
% 4: portfast bpdu-guard disabled
% eth2: Port Number 4 - Ifindex 4 - Port Id 0x8004 - Role Designated - State
Forwarding
% eth2: Designated Path Cost 0
% eth2: Configured Path Cost 200000 - Add type Explicit ref count 1
% eth2: Designated Port Id 0x8004 - Priority 128 -
% eth2: Root 800052540046f549
% eth2: Designated Bridge 800052540046f549
% eth2: Message Age 0 - Max Age 20
% eth2: Hello Time 2 - Forward Delay 15
% eth2: Forward Timer 0 - Msg Age Timer 0 - Hello Timer 0 - topo change
timer 0
% eth2: forward-transitions 1

```

```
% eth2: Restricted-role OFF
% eth2: Version Rapid Spanning Tree Protocol - Receive None - Send RSTP
% eth2: No portfast configured - Current portfast off
% eth2: bpdu-guard default - Current bpdu-guard off
% eth2: bpdu-filter default - Current bpdu-filter off
% eth2: no root guard configured - Current root guard off
% eth2: Configured Link Type point-to-point - Current point-to-point
% eth2: No auto-edge configured - Current port Auto Edge off
%
% eth3: Port Number 5 - Ifindex 5 - Port Id 0x8005 - Role Designated - State
Forwarding
% eth3: Designated Path Cost 0
% eth3: Configured Path Cost 200000 - Add type Explicit ref count 1
% eth3: Designated Port Id 0x8005 - Priority 128 -
% eth3: Root 800052540046f549
% eth3: Designated Bridge 800052540046f549
% eth3: Message Age 0 - Max Age 20
% eth3: Hello Time 2 - Forward Delay 15
% eth3: Forward Timer 0 - Msg Age Timer 0 - Hello Timer 0 - topo change
timer 0
% eth3: forward-transitions 1
% eth3: Restricted-role OFF
% eth3: Version Rapid Spanning Tree Protocol - Receive None - Send RSTP
% eth3: No portfast configured - Current portfast off
% eth3: bpdu-guard default - Current bpdu-guard off
% eth3: bpdu-filter default - Current bpdu-filter off
% eth3: no root guard configured - Current root guard off
% eth3: Configured Link Type point-to-point - Current point-to-point
% eth3: No auto-edge configured - Current port Auto Edge off
%
% eth4: Port Number 6 - Ifindex 6 - Port Id 0x8006 - Role Designated - State
Forwarding
% eth4: Designated Path Cost 0
% eth4: Configured Path Cost 200000 - Add type Explicit ref count 1
% eth4: Designated Port Id 0x8006 - Priority 128 -
% eth4: Root 800052540046f549
% eth4: Designated Bridge 800052540046f549
% eth4: Message Age 0 - Max Age 20
% eth4: Hello Time 2 - Forward Delay 15
% eth4: Forward Timer 0 - Msg Age Timer 0 - Hello Timer 0 - topo change
timer 0
% eth4: forward-transitions 1
% eth4: Restricted-role OFF
% eth4: Version Rapid Spanning Tree Protocol - Receive None - Send RSTP
% eth4: No portfast configured - Current portfast off
% eth4: bpdu-guard default - Current bpdu-guard off
% eth4: bpdu-filter default - Current bpdu-filter off
% eth4: no root guard configured - Current root guard off
% eth4: Configured Link Type point-to-point - Current point-to-point
% eth4: No auto-edge configured - Current port Auto Edge off
%
% eth5: Port Number 7 - Ifindex 7 - Port Id 0x8007 - Role Designated - State
Forwarding
% eth5: Designated Path Cost 0
% eth5: Configured Path Cost 200000 - Add type Explicit ref count 1
% eth5: Designated Port Id 0x8007 - Priority 128 -
% eth5: Root 800052540046f549
% eth5: Designated Bridge 800052540046f549
```

```
% eth5: Message Age 0 - Max Age 20
% eth5: Hello Time 2 - Forward Delay 15
% eth5: Forward Timer 0 - Msg Age Timer 0 - Hello Timer 0 - topo change
timer 0
% eth5: forward-transitions 1
% eth5: Restricted-role OFF
% eth5: Version Rapid Spanning Tree Protocol - Receive None - Send RSTP
% eth5: No portfast configured - Current portfast off
% eth5: bpdu-guard default - Current bpdu-guard off
% eth5: bpdu-filter default - Current bpdu-filter off
% eth5: no root guard configured - Current root guard off
% eth5: Configured Link Type point-to-point - Current point-to-point
% eth5: No auto-edge configured - Current port Auto Edge off
%
% Default: Bridge up - Spanning Tree Enabled
% Default: Root Path Cost 0 - Root Port 0 - Bridge Priority 32768
% Default: Forward Delay 15 - Hello Time 2 - Max Age 20 - Transmit Hold Count
6
% Default: Root Id 8000000000000000
% Default: Bridge Id 8000000000000000
% Default: last topology change Thu Jan 1 00:00:00 1970
% Default: 0 topology change(s) - last topology change Thu Jan 1 00:00:00
1970

% Default: portfast bpdu-filter disabled
% Default: portfast bpdu-guard disabled
```

CHAPTER 6 MSTP Configuration

This chapter contains a complete sample Multiple Spanning Tree Protocol (MSTP) configuration. MSTP allows multiple VLANs to be grouped into one spanning-tree instance. Every MST instance has a spanning-tree that is independent of other spanning-tree instances providing multiple forwarding paths for data traffic.

Topology

This example gives a simple multi-bridge topology and its configuration.

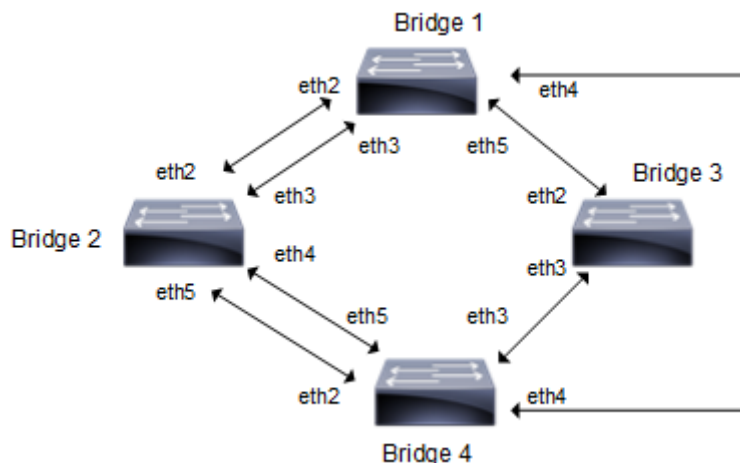

Figure 6-14: MSTP Topology

Note: Run the `switchport` command on each port to change to Layer-2 mode.

Configuration

Bridge 1

<code>Bridge1#configure terminal</code>	Enter configure mode.
<code>Bridge1(config)#bridge 1 protocol mstp</code>	Add a bridge (1) to the multiple spanning tree table.
<code>Bridge1(config)#vlan database</code>	Enter the VLAN configuration mode.
<code>Bridge1(config-vlan)#vlan 2 bridge 1 state enable</code>	Enable the state of VLAN 2 on bridge 1. Specifying an enable state allows forwarding of frames over VLAN 2 on bridge 1.
<code>Bridge1(config-vlan)#vlan 3 bridge 1 state enable</code>	Enable the state of VLAN 3 on bridge 1. Specifying an enable state allows forwarding of frames over VLAN 3 on bridge 1.
<code>Bridge1(config-vlan)#vlan 4 bridge 1 state enable</code>	Enable the state of VLAN 4 on bridge 1. Specifying an enable state allows forwarding of frames over VLAN 4 on bridge 1.
<code>Bridge1(config-vlan)#vlan 5 bridge 1 state enable</code>	Enable the state of VLAN 5 on bridge 1. Specifying an enable state allows forwarding of frames over VLAN 5 on bridge 1.
<code>Bridge1(config-vlan)#commit</code>	Commit the candidate configuration to the running configuration.
<code>Bridge1(config-vlan)#exit</code>	Exit the VLAN configuration mode.
<code>Bridge1(config)#spanning-tree mst configuration</code>	Enter the Multiple Spanning Tree

Bridgel (config-mst)#bridge 1 instance 2 vlan 2	Create an instance of VLAN. The VLANs must be created before being associating with an MST instance (MSTI). If the VLAN range is not specified the MSTI will not be created.
Bridgel (config-mst)#bridge 1 instance 3 vlan 3	Create another instance of VLAN. The VLANs must be created before being associating with an MST instance (MSTI). If the VLAN range is not specified the MSTI will not be created.
Bridgel (config-mst)#bridge 1 instance 4 vlan 4	Create another instance of VLAN. The VLANs must be created before being associating with an MST instance (MSTI). If the VLAN range is not specified the MSTI will not be created.
Bridgel (config-mst)#bridge 1 instance 5 vlan 5	Create another instance of VLAN. The VLANs must be created before being associating with an MST instance (MSTI). If the VLAN range is not specified the MSTI will not be created.
Bridgel (config-mst)#commit	Commit the candidate configuration to the running configuration.
Bridgel (config-mst)#exit	Exit MST Configuration mode.
Bridgel (config)#interface eth2	Enter interface mode for eth2
Bridgel (config-if)#switchport	Configure interface as a layer 2 port.
Bridgel (config-if)#bridge-group 1	Associating the interface to bridge-group 1
Bridgel (config-if)#bridge-group 1 instance 2	Assigning bridge-group 1 to this instance
Bridgel (config-if)#bridge-group 1 instance 3	Assigning bridge-group 1 to this instance
Bridgel (config-if)#bridge-group 1 instance 4	Assigning bridge-group 1 to this instance
Bridgel (config-if)#bridge-group 1 instance 5	Assigning bridge-group 1 to this instance
Bridgel (config-if)#commit	Commit the candidate configuration to the running configuration.
Bridgel (config-if)#exit	Exit interface mode.
Bridgel (config)#interface eth3	Enter interface mode for eth3.
Bridgel (config-if)#switchport	Configure interface as a layer 2 port.
Bridgel (config-if)#bridge-group 1	Associating the interface to bridge-group 1
Bridgel (config-if)#bridge-group 1 instance 2	Assigning bridge-group 1 to this instance
Bridgel (config-if)#bridge-group 1 instance 3	Assigning bridge-group 1 to this instance
Bridgel (config-if)#bridge-group 1 instance 4	Assigning bridge-group 1 to this instance
Bridgel (config-if)#bridge-group 1 instance 5	Assigning bridge-group 1 to this instance
Bridgel (config-if)#commit	Commit the candidate configuration to the running configuration.
Bridgel (config-if)#exit	Exit interface mode.
Bridgel (config)#interface eth4	Enter interface mode for eth4.
Bridgel (config-if)#switchport	Configure interface as a layer 2 port.
Bridgel (config-if)#bridge-group 1	Associating the interface to bridge-group 1
Bridgel (config-if)#bridge-group 1 instance 2	Assigning bridge-group 1 to this instance

Bridgel (config-if) #bridge-group 1 instance 3	Assigning bridge-group 1 to this instance
Bridgel (config-if) #bridge-group 1 instance 4	Assigning bridge-group 1 to this instance
Bridgel (config-if) #bridge-group 1 instance 5	Assigning bridge-group 1 to this instance
Bridgel (config-if) #commit	Commit the candidate configuration to the running configuration.
Bridgel (config-if) #exit	Exit interface mode.
Bridgel (config) #interface eth5	Enter interface mode for eth5.
Bridgel (config-if) #switchport	Configure interface as a layer 2 port.
Bridgel (config-if) #bridge-group 1	Associating the interface to bridge-group 1
Bridgel (config-if) #bridge-group 1 instance 2	Assigning bridge-group 1 to this instance
Bridgel (config-if) #bridge-group 1 instance 3	Assigning bridge-group 1 to this instance
Bridgel (config-if) #bridge-group 1 instance 4	Assigning bridge-group 1 to this instance
Bridgel (config-if) #bridge-group 1 instance 5	Assigning bridge-group 1 to this instance
Bridgel (config-if) #commit	Commit the candidate configuration to the running configuration.
Bridgel (config-if) #exit	Exit interface mode.

Bridge 2

Bridge2#configure terminal	Enter configure mode.
Bridge2 (config) #bridge 2 protocol mstp	Add a bridge (2) to the multiple spanning
Bridge2 (config) #bridge 2 priority 4096	Assign priority to this bridge.
Bridge2 (config) #vlan database	Enter the VLAN configuration mode.
Bridge2 (config-vlan) #vlan 2 bridge 2 state enable	Enable the state of VLAN 2 on bridge 2. Specifying an enable state allows forwarding of frames over VLAN 2 on bridge 2.
Bridge2 (config-vlan) #vlan 3 bridge 2 state enable	Enable the state of VLAN 3 on bridge 2. Specifying an enable state allows forwarding of frames over VLAN 3 on bridge 2
Bridge2 (config-vlan) #vlan 4 bridge 2 state enable	Enable the state of VLAN 4 on bridge 2. Specifying an enable state allows forwarding of frames over VLAN 4 on bridge 2
Bridge2 (config-vlan) #vlan 5 bridge 2 state enable	Enable the state of VLAN 5 on bridge 2. Specifying an enable state allows forwarding of frames over VLAN 5 on bridge 2
Bridge2 (config-vlan) #commit	Commit the candidate configuration to the running configuration.
Bridge2 (config-vlan) #exit	Exit the VLAN configuration mode.
Bridge2 (config) #spanning-tree mst configuration	Enter the Multiple Spanning Tree configuration mode
Bridge2 (config-mst) #bridge 2 instance 2 vlan 2	Create an instance of VLAN. The VLANs must be created before being associating with an MST instance (MSTI). If the VLAN range is not specified the MSTI will not be created.

Bridge2(config-mst)#bridge 2 instance 3 vlan 3	Create an instance of VLAN. The VLANs must be created before being associating with an MST instance (MSTI). If the VLAN range is not specified the MSTI will not be created.
Bridge2(config-mst)#bridge 2 instance 4 vlan 4	Create an instance of VLAN. The VLANs must be created before being associating with an MST instance (MSTI). If the VLAN range is not specified the MSTI will not be created.
Bridge2(config-mst)#bridge 2 instance 5 vlan 5	Create an instance of VLAN. The VLANs must be created before being associating with an MST instance (MSTI). If the VLAN range is not specified the MSTI will not be created.
Bridge2(config-mst)#commit	Commit the candidate configuration to the running configuration.
Bridge2(config-mst)#exit	Exit MST Configuration mode.
Bridge2(config)#interface eth2	Enter interface mode for eth2
Bridge2(config-if)#switchport	Configure interface as a layer 2 port.
Bridge2(config-if)#bridge-group 2	Associating the interface to bridge-group 2
Bridge2(config-if)#bridge-group 2 instance 2	Assigning bridge-group 2 to this instance
Bridge2(config-if)#bridge-group 2 instance 3	Assigning bridge-group 2 to this instance
Bridge2(config-if)#bridge-group 2 instance 4	Assigning bridge-group 2 to this instance
Bridge2(config-if)#bridge-group 2 instance 5	Assigning bridge-group 2 to this instance
Bridge2(config-if)#commit	Commit the candidate configuration to the running configuration.
Bridge2(config-if)#exit	Exit interface mode.
Bridge2(config)#interface eth3	Enter interface mode for eth3
Bridge2(config-if)#switchport	Configure interface as a layer 2 port.
Bridge2(config-if)#bridge-group 2	Associating the interface to bridge-group 2
Bridge2(config-if)#bridge-group 2 instance 2	Assigning bridge-group 2 to this instance
Bridge2(config-if)#bridge-group 2 instance 3	Assigning bridge-group 2 to this instance
Bridge2(config-if)#bridge-group 2 instance 3 priority 16	Assign bridge-group 2 to this instance and set a port priority in order of 16 for it. MSTP uses port priority as a tiebreaker to determine which port should forward frames for a particular instance on a LAN, or which port should be the root port for an instance. A lower value implies better priority.
Bridge2(config-if)#bridge-group 2 instance 4	Assigning bridge-group 2 to this instance
Bridge2(config-if)#bridge-group 2 instance 4 priority 16	Assign bridge-group 2 to this instance and set a port priority in order of 16 for it. MSTP uses port priority as a tiebreaker to determine which port should forward frames for a particular instance on a LAN, or which port should be the root port for an instance. A lower value implies better priority
Bridge2(config-if)#bridge-group 2 instance 5	Assigning bridge-group 2 to this instance
Bridge2(config-if)#commit	Commit the candidate configuration to the running configuration.

Bridge2 (config-if) #exit	Exit interface mode
Bridge2 (config) #interface eth4	Enter interface mode for eth4
Bridge2 (config-if) #switchport	Configure interface as a layer 2 port.
Bridge2 (config-if) #bridge-group 2	Associating the interface to bridge-group 2
Bridge2 (config-if) #bridge-group 2 instance 2	Assigning bridge-group 2 to this instance
Bridge2 (config-if) #bridge-group 2 instance 3	Assigning bridge-group 2 to this instance
Bridge2 (config-if) #bridge-group 2 instance 4	Assigning bridge-group 2 to this instance
Bridge2 (config-if) #bridge-group 2 instance 5	Assigning bridge-group 2 to this instance
Bridge2 (config-if) #commit	Commit the candidate configuration to the running configuration.
Bridge2 (config-if) #exit	Exit interface mode.
Bridge2 (config) #interface eth5	Enter interface mode for eth5
Bridge2 (config-if) #switchport	Configure interface as a layer 2 port.
Bridge2 (config-if) #bridge-group 2	Associating the interface to bridge-group 2
Bridge2 (config-if) #bridge-group 2 instance 2	Assigning bridge-group 2 to this instance
Bridge2 (config-if) #bridge-group 2 instance 3	Assigning bridge-group 2 to this instance
Bridge2 (config-if) #bridge-group 2 instance 4	Assigning bridge-group 2 to this instance
Bridge2 (config-if) #bridge-group 2 instance 5	Assigning bridge-group 2 to this instance
Bridge2 (config-if) #commit	Commit the candidate configuration to the running configuration.
Bridge2 (config-if) #exit	Exit interface mode.

Bridge 3

Bridge3#configure terminal	Enter configure mode.
Bridge3 (config) #bridge 3 protocol mstp	Add a bridge (3) to the multiple spanning tree table
Bridge3 (config) #vlan database	Enter the VLAN configuration mode.
Bridge3 (config-vlan) #vlan 2 bridge 3 state enable	Enable the state of VLAN 2 on bridge 3. Specifying an enable state allows forwarding of frames over VLAN 2 on bridge 3.
Bridge3 (config-vlan) #vlan 3 bridge 3 state enable	Enable the state of VLAN 3 on bridge 3. Specifying an enable state allows forwarding of frames over VLAN 3 on bridge 3.
Bridge3 (config-vlan) #vlan 4 bridge 3 state enable	Enable the state of VLAN 4 on bridge 3. Specifying an enable state allows forwarding of frames over VLAN 4 on bridge 3.

Bridge3(config-vlan)#vlan 5 bridge 3 state enable	Enable the state of VLAN 5 on bridge 3. Specifying an enable state allows forwarding of frames over VLAN 5 on bridge 3.
Bridge3(config-vlan)#commit	Commit the candidate configuration to the running configuration.
Bridge3(config-vlan)#exit	Exit the VLAN configuration mode.
Bridge3(config)#spanning-tree mst configuration	Enter the Multiple Spanning Tree Configuration mode.
Bridge3(config-mst)#bridge 3 instance 2 vlan 2	Create an instance of VLAN. The VLANs must be created before being associating with an MST instance (MSTI). If the VLAN range is not specified the MSTI will not be created.
Bridge3(config-mst)#bridge 3 instance 3 vlan 3	Create an instance of VLAN. The VLANs must be created before being associating with an MST instance (MSTI). If the VLAN range is not specified the MSTI will not be created.
Bridge3(config-mst)#bridge 3 instance 4 vlan 4	Create an instance of VLAN. The VLANs must be created before being associating with an MST instance (MSTI). If the VLAN range is not specified the MSTI will not be created.
Bridge3(config-mst)#bridge 3 instance 5 vlan 5	Create an instance of VLAN. The VLANs must be created before being associating with an MST instance (MSTI). If the VLAN range is not specified the MSTI will not be created.
Bridge3(config-mst)#commit	Commit the candidate configuration to the running configuration.
Bridge3(config-mst)#exit	Exit MST Configuration mode.
Bridge3(config)#interface eth2	Enter interface mode for eth2
Bridge3(config-if)#switchport	Configure interface as a layer 2 port.
Bridge3(config-if)#bridge-group 3	Associating the interface to bridge-group 3
Bridge3(config-if)#bridge-group 3 instance 2	Assigning bridge-group 3 to this instance
Bridge3(config-if)#bridge-group 3 instance 3	Assigning bridge-group 3 to this instance
Bridge3(config-if)#bridge-group 3 instance 4	Assigning bridge-group 3 to this instance
Bridge3(config-if)#bridge-group 3 instance 5	Assigning bridge-group 3 to this instance
Bridge3(config-if)#commit	Commit the candidate configuration to the running configuration.
Bridge3(config-if)#exit	Exit interface mode.
Bridge3(config)#interface eth3	Enter interface mode for eth3
Bridge3(config-if)#switchport	Configure interface as a layer 2 port.
Bridge3(config-if)#bridge-group 3	Associating the interface to bridge-group 3
Bridge3(config-if)#bridge-group 3 instance 2	Assigning bridge-group 3 to this instance
Bridge3(config-if)#bridge-group 3 instance 3	Assigning bridge-group 3 to this instance
Bridge3(config-if)#bridge-group 3 instance 4	Assigning bridge-group 3 to this instance

Bridge3(config-if)#bridge-group 3 instance 5	Assigning bridge-group 3 to this instance
Bridge3(config-if)#commit	Commit the candidate configuration to the running configuration.
Bridge3(config-if)#exit	Exit interface mode.

Bridge 4

Bridge4#configure terminal	Enter configure mode.
Bridge4(config)#bridge 4 protocol mstp	Add a bridge (4) to the multiple spanning tree table
Bridge4(config)#vlan database	Enter the VLAN configuration mode.
Bridge4(config-vlan)#vlan 2 bridge 4 state enable	Enable the state of VLAN 2 on bridge 4. Specifying an enable state allows forwarding of frames over VLAN 2 on bridge 4.
Bridge4(config-vlan)#vlan 3 bridge 4 state enable	Enable the state of VLAN 3 on bridge 4. Specifying an enable state allows forwarding of frames over VLAN 3 on bridge 4.
Bridge4(config-vlan)#vlan 4 bridge 4 state enable	Enable the state of VLAN 4 on bridge 4. Specifying an enable state allows forwarding of frames over VLAN 4 on bridge 4.
Bridge4(config-vlan)#vlan 5 bridge 4 state enable	Enable the state of VLAN 5 on bridge 4. Specifying an enable state allows forwarding of frames over VLAN 5 on bridge 4.
Bridge4(config-vlan)#commit	Commit the candidate configuration to the running configuration.
Bridge4(config-vlan)#exit	Exit the VLAN configuration mode.
Bridge4(config)#spanning-tree mst configuration	Enter the Multiple Spanning Tree Configuration mode.
Bridge4(config-mst)#bridge 4 instance 2 vlan 2	Create an instance of VLAN. The VLANs must be created before being associating with an MST instance (MSTI). If the VLAN range is not specified the MSTI will not be created.
Bridge4(config-mst)#bridge 4 instance 3 vlan 3	Create an instance of VLAN. The VLANs must be created before being associating with an MST instance (MSTI). If the VLAN range is not specified the MSTI will not be created.
Bridge4(config-mst)#bridge 4 instance 4 vlan 4	Create an instance of VLAN. The VLANs must be created before being associating with an MST instance (MSTI). If the VLAN range is not specified the MSTI will not be created.
Bridge4(config-mst)#bridge 4 instance 5 vlan 5	Create an instance of VLAN. The VLANs must be created before being associating with an MST instance (MSTI). If the VLAN range is not specified the MSTI will not be created.
Bridge4(config-mst)#commit	Commit the candidate configuration to the running configuration.
Bridge4(config-mst)#exit	Exit MST Configuration mode.
Bridge4(config)#interface eth2	Enter interface mode for eth2
Bridge4(config-if)#switchport	Configure interface as a layer 2 port.
Bridge4(config-if)#bridge-group 4	Associating the interface to bridge-group 4
Bridge4(config-if)#bridge-group 4 instance 2	Assigning bridge-group 4 to this instance
Bridge4(config-if)#bridge-group 4 instance 3	Assigning bridge-group 4 to this instance
Bridge4(config-if)#bridge-group 4 instance 4	Assigning bridge-group 4 to this instance
Bridge4(config-if)#bridge-group 4 instance 5	Assigning bridge-group 4 to this instance

Bridge4 (config-if) #commit	Commit the candidate configuration to the running configuration.
Bridge4 (config-if) #exit	Exit interface mode.
Bridge4 (config) #interface eth3	Enter interface mode for eth3
Bridge4 (config-if) #switchport	Configure interface as a layer 2 port.
Bridge4 (config-if) #bridge-group 4	Associating the interface to bridge-group 4
Bridge4 (config-if) #bridge-group 4 instance 2	Assigning bridge-group 4 to this instance
Bridge4 (config-if) #bridge-group 4 instance 3	Assigning bridge-group 4 to this instance
Bridge4 (config-if) #bridge-group 4 instance 4	Assigning bridge-group 4 to this instance
Bridge4 (config-if) #bridge-group 4 instance 5	Assigning bridge-group 4 to this instance
Bridge4 (config-if) #commit	Commit the candidate configuration to the running configuration.
Bridge4 (config-if) #exit	Exit interface mode.
Bridge4 (config) #interface eth4	Enter interface mode for eth4
Bridge4 (config-if) #switchport	Configure interface as a layer 2 port.
Bridge4 (config-if) #bridge-group 4	Associating the interface to bridge-group 4
Bridge4 (config-if) #bridge-group 4 instance 2	Assigning bridge-group 4 to this instance
Bridge4 (config-if) #bridge-group 4 instance 3	Assigning bridge-group 4 to this instance
Bridge4 (config-if) #bridge-group 4 instance 4	Assigning bridge-group 4 to this instance
Bridge4 (config-if) #bridge-group 4 instance 5	Assigning bridge-group 4 to this instance
Bridge4 (config-if) #commit	Commit the candidate configuration to the running configuration.
Bridge4 (config-if) #exit	Exit interface mode.
Bridge4 (config) #interface eth5	Enter interface mode for eth5
Bridge4 (config-if) #switchport	Configure interface as a layer 2 port.
Bridge4 (config-if) #bridge-group 4	Associating the interface to bridge-group 4
Bridge4 (config-if) #bridge-group 4 instance 2	Assigning bridge-group 4 to this instance
Bridge4 (config-if) #bridge-group 4 instance 3	Assigning bridge-group 4 to this instance
Bridge4 (config-if) #bridge-group 4 instance 4	Assigning bridge-group 4 to this instance
Bridge4 (config-if) #bridge-group 4 instance 5	Assigning bridge-group 4 to this instance
Bridge4 (config-if) #commit	Commit the candidate configuration to the running configuration.
Bridge4 (config-if) #exit	Exit interface mode.

Validation

```
show spanning-tree, show spanning-tree mst detail
# show spanning-tree mst detail
```

```
% 1: Bridge up - Spanning Tree Enabled - topology change detected
% 1: CIST Root Path Cost 0 - CIST Root Port 4 - CIST Bridge Priority 32768
% 1: Forward Delay 15 - Hello Time 2 - Max Age 20 - Transmit Hold Count 6 -
Max-hops 20
% 1: CIST Root Id 1000525400751db5
% 1: CIST Reg Root Id 1000525400751db5
% 1: CIST Bridge Id 80005254009cb7e6
% 1: 32 topology change(s) - last topology change Mon Aug 17 10:45:25 2020

% 1: portfast bpdu-filter disabled
% 1: portfast bpdu-guard disabled
% eth2: Port Number 4 - Ifindex 4 - Port Id 0x8004 - Role Rootport - State
Forwarding
% eth2: Designated External Path Cost 0 -Internal Path Cost 200000
% eth2: Configured Path Cost 200000 - Add type Explicit ref count 5
% eth2: Designated Port Id 0x8004 - CIST Priority 128 -
% eth2: CIST Root 1000525400751db5
% eth2: Regional Root 1000525400751db5
% eth2: Designated Bridge 1000525400751db5
% eth2: Message Age 0 - Max Age 20
% eth2: CIST Hello Time 2 - Forward Delay 15
% eth2: CIST Forward Timer 0 - Msg Age Timer 5 - Hello Timer 0 - topo change
timer 0
% eth2: forward-transitions 1
% eth2: Restricted-role OFF
% eth2: Version Multiple Spanning Tree Protocol - Receive MSTP - Send MSTP
% eth2: No portfast configured - Current portfast off
% eth2: bpdu-guard default - Current bpdu-guard off
% eth2: bpdu-filter default - Current bpdu-filter off
% eth2: no root guard configured - Current root guard off
% eth2: Configured Link Type point-to-point - Current point-to-point
% eth2: No auto-edge configured - Current port Auto Edge off
%
% eth3: Port Number 5 - Ifindex 5 - Port Id 0x8005 - Role Alternate - State
Discarding
% eth3: Designated External Path Cost 0 -Internal Path Cost 200000
% eth3: Configured Path Cost 200000 - Add type Explicit ref count 5
% eth3: Designated Port Id 0x8005 - CIST Priority 128 -
% eth3: CIST Root 1000525400751db5
% eth3: Regional Root 1000525400751db5
% eth3: Designated Bridge 1000525400751db5
% eth3: Message Age 0 - Max Age 20
% eth3: CIST Hello Time 2 - Forward Delay 15
% eth3: CIST Forward Timer 0 - Msg Age Timer 5 - Hello Timer 0 - topo change
timer 0
% eth3: forward-transitions 2
% eth3: Restricted-role OFF
% eth3: Version Multiple Spanning Tree Protocol - Receive MSTP - Send MSTP
% eth3: No portfast configured - Current portfast off
% eth3: bpdu-guard default - Current bpdu-guard off
% eth3: bpdu-filter default - Current bpdu-filter off
% eth3: no root guard configured - Current root guard off
% eth3: Configured Link Type point-to-point - Current point-to-point
% eth3: No auto-edge configured - Current port Auto Edge off
%
% eth4: Port Number 6 - Ifindex 6 - Port Id 0x8006 - Role Alternate - State
Discarding
% eth4: Designated External Path Cost 0 -Internal Path Cost 200000
```

```
% eth4: Configured Path Cost 200000 - Add type Explicit ref count 5
% eth4: Designated Port Id 0x8006 - CIST Priority 128 -
% eth4: CIST Root 1000525400751db5
% eth4: Regional Root 1000525400751db5
% eth4: Designated Bridge 800052540046f549
% eth4: Message Age 0 - Max Age 20
% eth4: CIST Hello Time 2 - Forward Delay 15
% eth4: CIST Forward Timer 0 - Msg Age Timer 4 - Hello Timer 1 - topo change
timer 0
% eth4: forward-transitions 3
% eth4: Restricted-role OFF
% eth4: Version Multiple Spanning Tree Protocol - Receive MSTP - Send MSTP
% eth4: No portfast configured - Current portfast off
% eth4: bpdu-guard default - Current bpdu-guard off
% eth4: bpdu-filter default - Current bpdu-filter off
% eth4: no root guard configured - Current root guard off
% eth4: Configured Link Type point-to-point - Current point-to-point
% eth4: No auto-edge configured - Current port Auto Edge off
%
% eth5: Port Number 7 - Ifindex 7 - Port Id 0x8007 - Role Designated - State
Forwarding
% eth5: Designated External Path Cost 0 -Internal Path Cost 200000
% eth5: Configured Path Cost 200000 - Add type Explicit ref count 5
% eth5: Designated Port Id 0x8007 - CIST Priority 128 -
% eth5: CIST Root 1000525400751db5
% eth5: Regional Root 1000525400751db5
% eth5: Designated Bridge 80005254009cb7e6
% eth5: Message Age 0 - Max Age 20
% eth5: CIST Hello Time 2 - Forward Delay 15
% eth5: CIST Forward Timer 0 - Msg Age Timer 0 - Hello Timer 1 - topo change
timer 0
% eth5: forward-transitions 4
% eth5: Restricted-role OFF
% eth5: Version Multiple Spanning Tree Protocol - Receive MSTP - Send MSTP
% eth5: No portfast configured - Current portfast off
% eth5: bpdu-guard default - Current bpdu-guard off
% eth5: bpdu-filter default - Current bpdu-filter off
% eth5: no root guard configured - Current root guard off
% eth5: Configured Link Type point-to-point - Current point-to-point
% eth5: No auto-edge configured - Current port Auto Edge off
%
% Instance 2: Vlans: 2
% 1: MSTI Root Path Cost 200000 -MSTI Root Port 6 - MSTI Bridge Priority 32768
% 1: MSTI Root Id 800252540046f549
% 1: MSTI Bridge Id 80025254009cb7e6
% eth2: Port Number 4 - Ifindex 4 - Port Id 0x8004 - Role Alternate - State
Discarding
% eth2: Designated Internal Path Cost 200000 - Designated Port Id 0x8004
% eth2: Configured Internal Path Cost 200000
% eth2: Configured CST External Path cost 200000
% eth2: CST Priority 128 - MSTI Priority 128
% eth2: Designated Root 800252540046f549
% eth2: Designated Bridge 80025254009cb7e6
% eth2: Message Age 0
% eth2: Hello Time 2 - Forward Delay 15
```

```
% eth2: Forward Timer 0 - Msg Age Timer 5 - Hello Timer 0

% eth3: Port Number 5 - Ifindex 5 - Port Id 0x8005 - Role Alternate - State
Discarding
% eth3: Designated Internal Path Cost 200000 - Designated Port Id 0x8005
% eth3: Configured Internal Path Cost 200000
% eth3: Configured CST External Path cost 200000
% eth3: CST Priority 128 - MSTI Priority 128
% eth3: Designated Root 800252540046f549
% eth3: Designated Bridge 80025254009cb7e6
% eth3: Message Age 0
% eth3: Hello Time 2 - Forward Delay 15
% eth3: Forward Timer 0 - Msg Age Timer 5 - Hello Timer 0

% eth4: Port Number 6 - Ifindex 6 - Port Id 0x8006 - Role Rootport - State
Forwarding
% eth4: Designated Internal Path Cost 0 - Designated Port Id 0x8006
% eth4: Configured Internal Path Cost 200000
% eth4: Configured CST External Path cost 200000
% eth4: CST Priority 128 - MSTI Priority 128
% eth4: Designated Root 800252540046f549
% eth4: Designated Bridge 80025254009cb7e6
% eth4: Message Age 0
% eth4: Hello Time 2 - Forward Delay 15
% eth4: Forward Timer 0 - Msg Age Timer 4 - Hello Timer 1

% eth5: Port Number 7 - Ifindex 7 - Port Id 0x8007 - Role Alternate - State
Discarding
% eth5: Designated Internal Path Cost 200000 - Designated Port Id 0x8004
% eth5: Configured Internal Path Cost 200000
% eth5: Configured CST External Path cost 200000
% eth5: CST Priority 128 - MSTI Priority 128
% eth5: Designated Root 800252540046f549
% eth5: Designated Bridge 80025254009cb7e6
% eth5: Message Age 0
% eth5: Hello Time 2 - Forward Delay 15
% eth5: Forward Timer 0 - Msg Age Timer 4 - Hello Timer 1

% Instance 3: Vlans: 3

% 1: MSTI Root Path Cost 200000 -MSTI Root Port 6 - MSTI Bridge Priority 32768
% 1: MSTI Root Id 800352540046f549
% 1: MSTI Bridge Id 80035254009cb7e6
% eth2: Port Number 4 - Ifindex 4 - Port Id 0x8004 - Role Alternate - State
Discarding
% eth2: Designated Internal Path Cost 200000 - Designated Port Id 0x8004
% eth2: Configured Internal Path Cost 200000
% eth2: Configured CST External Path cost 200000
% eth2: CST Priority 128 - MSTI Priority 128
% eth2: Designated Root 800352540046f549
% eth2: Designated Bridge 80035254009cb7e6
% eth2: Message Age 0
% eth2: Hello Time 2 - Forward Delay 15
% eth2: Forward Timer 0 - Msg Age Timer 5 - Hello Timer 0

% eth3: Port Number 5 - Ifindex 5 - Port Id 0x8005 - Role Alternate - State
Discarding
```

```
% eth3: Designated Internal Path Cost 200000 - Designated Port Id 0x1005
% eth3: Configured Internal Path Cost 200000
% eth3: Configured CST External Path cost 200000
% eth3: CST Priority 128 - MSTI Priority 128
% eth3: Designated Root 800352540046f549
% eth3: Designated Bridge 80035254009cb7e6
% eth3: Message Age 0
% eth3: Hello Time 2 - Forward Delay 15
% eth3: Forward Timer 0 - Msg Age Timer 5 - Hello Timer 0

% eth4: Port Number 6 - Ifindex 6 - Port Id 0x8006 - Role Rootport - State
Forwarding
% eth4: Designated Internal Path Cost 0 - Designated Port Id 0x8006
% eth4: Configured Internal Path Cost 200000
% eth4: Configured CST External Path cost 200000
% eth4: CST Priority 128 - MSTI Priority 128
% eth4: Designated Root 800352540046f549
% eth4: Designated Bridge 80035254009cb7e6
% eth4: Message Age 0
% eth4: Hello Time 2 - Forward Delay 15
% eth4: Forward Timer 0 - Msg Age Timer 4 - Hello Timer 1

% eth5: Port Number 7 - Ifindex 7 - Port Id 0x8007 - Role Alternate - State
Discarding
% eth5: Designated Internal Path Cost 200000 - Designated Port Id 0x8004
% eth5: Configured Internal Path Cost 200000
% eth5: Configured CST External Path cost 200000
% eth5: CST Priority 128 - MSTI Priority 128
% eth5: Designated Root 800352540046f549
% eth5: Designated Bridge 80035254009cb7e6
% eth5: Message Age 0
% eth5: Hello Time 2 - Forward Delay 15
% eth5: Forward Timer 0 - Msg Age Timer 4 - Hello Timer 1

% Instance 4: Vlans: 4

% 1: MSTI Root Path Cost 200000 -MSTI Root Port 6 - MSTI Bridge Priority 32768
% 1: MSTI Root Id 800452540046f549
% 1: MSTI Bridge Id 80045254009cb7e6
% eth2: Port Number 4 - Ifindex 4 - Port Id 0x8004 - Role Alternate - State
Discarding
% eth2: Designated Internal Path Cost 200000 - Designated Port Id 0x8004
% eth2: Configured Internal Path Cost 200000
% eth2: Configured CST External Path cost 200000
% eth2: CST Priority 128 - MSTI Priority 128
% eth2: Designated Root 800452540046f549
% eth2: Designated Bridge 80045254009cb7e6
% eth2: Message Age 0
% eth2: Hello Time 2 - Forward Delay 15
% eth2: Forward Timer 0 - Msg Age Timer 5 - Hello Timer 0

% eth3: Port Number 5 - Ifindex 5 - Port Id 0x8005 - Role Alternate - State
Discarding
% eth3: Designated Internal Path Cost 200000 - Designated Port Id 0x1005
% eth3: Configured Internal Path Cost 200000
% eth3: Configured CST External Path cost 200000
```

```
% eth3: CST Priority 128 - MSTI Priority 128
% eth3: Designated Root 800452540046f549
% eth3: Designated Bridge 80045254009cb7e6
% eth3: Message Age 0
% eth3: Hello Time 2 - Forward Delay 15
% eth3: Forward Timer 0 - Msg Age Timer 5 - Hello Timer 0

% eth4: Port Number 6 - Ifindex 6 - Port Id 0x8006 - Role Rootport - State
Forwarding
% eth4: Designated Internal Path Cost 0 - Designated Port Id 0x8006
% eth4: Configured Internal Path Cost 200000
% eth4: Configured CST External Path cost 200000
% eth4: CST Priority 128 - MSTI Priority 128
% eth4: Designated Root 800452540046f549
% eth4: Designated Bridge 80045254009cb7e6
% eth4: Message Age 0
% eth4: Hello Time 2 - Forward Delay 15
% eth4: Forward Timer 0 - Msg Age Timer 4 - Hello Timer 1

% eth5: Port Number 7 - Ifindex 7 - Port Id 0x8007 - Role Alternate - State
Discarding
% eth5: Designated Internal Path Cost 200000 - Designated Port Id 0x8004
% eth5: Configured Internal Path Cost 200000
% eth5: Configured CST External Path cost 200000
% eth5: CST Priority 128 - MSTI Priority 128
% eth5: Designated Root 800452540046f549
% eth5: Designated Bridge 80045254009cb7e6
% eth5: Message Age 0
% eth5: Hello Time 2 - Forward Delay 15
% eth5: Forward Timer 0 - Msg Age Timer 4 - Hello Timer 1

% Instance 5: Vlans: 5

% 1: MSTI Root Path Cost 200000 -MSTI Root Port 6 - MSTI Bridge Priority 32768
% 1: MSTI Root Id 800552540046f549
% 1: MSTI Bridge Id 80055254009cb7e6
% eth2: Port Number 4 - Ifindex 4 - Port Id 0x8004 - Role Alternate - State
Discarding
% eth2: Designated Internal Path Cost 200000 - Designated Port Id 0x8004
% eth2: Configured Internal Path Cost 200000
% eth2: Configured CST External Path cost 200000
% eth2: CST Priority 128 - MSTI Priority 128
% eth2: Designated Root 800552540046f549
% eth2: Designated Bridge 80055254009cb7e6
% eth2: Message Age 0
% eth2: Hello Time 2 - Forward Delay 15
% eth2: Forward Timer 0 - Msg Age Timer 5 - Hello Timer 0

% eth3: Port Number 5 - Ifindex 5 - Port Id 0x8005 - Role Alternate - State
Discarding
% eth3: Designated Internal Path Cost 200000 - Designated Port Id 0x8005
% eth3: Configured Internal Path Cost 200000
% eth3: Configured CST External Path cost 200000
% eth3: CST Priority 128 - MSTI Priority 128
% eth3: Designated Root 800552540046f549
% eth3: Designated Bridge 80055254009cb7e6
```

```
% eth3: Message Age 0
% eth3: Hello Time 2 - Forward Delay 15
% eth3: Forward Timer 0 - Msg Age Timer 5 - Hello Timer 0

% eth4: Port Number 6 - Ifindex 6 - Port Id 0x8006 - Role Rootport - State
Forwarding
% eth4: Designated Internal Path Cost 0 - Designated Port Id 0x8006
% eth4: Configured Internal Path Cost 200000
% eth4: Configured CST External Path cost 200000
% eth4: CST Priority 128 - MSTI Priority 128
% eth4: Designated Root 800552540046f549
% eth4: Designated Bridge 80055254009cb7e6
% eth4: Message Age 0
% eth4: Hello Time 2 - Forward Delay 15
% eth4: Forward Timer 0 - Msg Age Timer 4 - Hello Timer 1

% eth5: Port Number 7 - Ifindex 7 - Port Id 0x8007 - Role Alternate - State
Discarding
% eth5: Designated Internal Path Cost 200000 - Designated Port Id 0x8004
% eth5: Configured Internal Path Cost 200000
% eth5: Configured CST External Path cost 200000
% eth5: CST Priority 128 - MSTI Priority 128
% eth5: Designated Root 800552540046f549
% eth5: Designated Bridge 80055254009cb7e6
% eth5: Message Age 0
% eth5: Hello Time 2 - Forward Delay 15
% eth5: Forward Timer 0 - Msg Age Timer 4 - Hello Timer 1

#show spanning-tree
% 1: Bridge up - Spanning Tree Enabled - topology change detected
% 1: CIST Root Path Cost 0 - CIST Root Port 4 - CIST Bridge Priority 32768
% 1: Forward Delay 15 - Hello Time 2 - Max Age 20 - Transmit Hold Count 6 -
Max-hops 20
% 1: CIST Root Id 1000525400751db5
% 1: CIST Reg Root Id 1000525400751db5
% 1: CIST Bridge Id 80005254009cb7e6
% 1: 32 topology change(s) - last topology change Mon Aug 17 10:45:25 2020

% 1: portfast bpdu-filter disabled
% 1: portfast bpdu-guard disabled
% eth2: Port Number 4 - Ifindex 4 - Port Id 0x8004 - Role Rootport - State
Forwarding
% eth2: Designated External Path Cost 0 -Internal Path Cost 200000
% eth2: Configured Path Cost 200000 - Add type Explicit ref count 5
% eth2: Designated Port Id 0x8004 - CIST Priority 128 -
% eth2: CIST Root 1000525400751db5
% eth2: Regional Root 1000525400751db5
% eth2: Designated Bridge 1000525400751db5
% eth2: Message Age 0 - Max Age 20
% eth2: CIST Hello Time 2 - Forward Delay 15
% eth2: CIST Forward Timer 0 - Msg Age Timer 4 - Hello Timer 1 - topo change
timer 0
% eth2: forward-transitions 1
% eth2: Restricted-role OFF
% eth2: Version Multiple Spanning Tree Protocol - Receive MSTP - Send MSTP
% eth2: No portfast configured - Current portfast off
% eth2: bpdu-guard default - Current bpdu-guard off
% eth2: bpdu-filter default - Current bpdu-filter off
```

```
% eth2: no root guard configured - Current root guard off
% eth2: Configured Link Type point-to-point - Current point-to-point
% eth2: No auto-edge configured - Current port Auto Edge off
%
% eth3: Port Number 5 - Ifindex 5 - Port Id 0x8005 - Role Alternate - State
Discarding
% eth3: Designated External Path Cost 0 -Internal Path Cost 200000
% eth3: Configured Path Cost 200000 - Add type Explicit ref count 5
% eth3: Designated Port Id 0x8005 - CIST Priority 128 -
% eth3: CIST Root 1000525400751db5
% eth3: Regional Root 1000525400751db5
% eth3: Designated Bridge 1000525400751db5
% eth3: Message Age 0 - Max Age 20
% eth3: CIST Hello Time 2 - Forward Delay 15
% eth3: CIST Forward Timer 0 - Msg Age Timer 4 - Hello Timer 1 - topo change
timer 0
% eth3: forward-transitions 2
% eth3: Restricted-role OFF
% eth3: Version Multiple Spanning Tree Protocol - Receive MSTP - Send MSTP
% eth3: No portfast configured - Current portfast off
% eth3: bpdu-guard default - Current bpdu-guard off
% eth3: bpdu-filter default - Current bpdu-filter off
% eth3: no root guard configured - Current root guard off
% eth3: Configured Link Type point-to-point - Current point-to-point
% eth3: No auto-edge configured - Current port Auto Edge off
%
% eth4: Port Number 6 - Ifindex 6 - Port Id 0x8006 - Role Alternate - State
Discarding
% eth4: Designated External Path Cost 0 -Internal Path Cost 200000
% eth4: Configured Path Cost 200000 - Add type Explicit ref count 5
% eth4: Designated Port Id 0x8006 - CIST Priority 128 -
% eth4: CIST Root 1000525400751db5
% eth4: Regional Root 1000525400751db5
% eth4: Designated Bridge 800052540046f549
% eth4: Message Age 0 - Max Age 20
% eth4: CIST Hello Time 2 - Forward Delay 15
% eth4: CIST Forward Timer 0 - Msg Age Timer 3 - Hello Timer 0 - topo change
timer 0
% eth4: forward-transitions 3
% eth4: Restricted-role OFF
% eth4: Version Multiple Spanning Tree Protocol - Receive MSTP - Send MSTP
% eth4: No portfast configured - Current portfast off
% eth4: bpdu-guard default - Current bpdu-guard off
% eth4: bpdu-filter default - Current bpdu-filter off
% eth4: no root guard configured - Current root guard off
% eth4: Configured Link Type point-to-point - Current point-to-point
% eth4: No auto-edge configured - Current port Auto Edge off
%
% eth5: Port Number 7 - Ifindex 7 - Port Id 0x8007 - Role Designated - State
Forwarding
% eth5: Designated External Path Cost 0 -Internal Path Cost 200000
% eth5: Configured Path Cost 200000 - Add type Explicit ref count 5
% eth5: Designated Port Id 0x8007 - CIST Priority 128 -
% eth5: CIST Root 1000525400751db5
% eth5: Regional Root 1000525400751db5
% eth5: Designated Bridge 80005254009cb7e6
% eth5: Message Age 0 - Max Age 20
% eth5: CIST Hello Time 2 - Forward Delay 15
```

```
% eth5: CIST Forward Timer 0 - Msg Age Timer 0 - Hello Timer 0 - topo change
timer 0
% eth5: forward-transitions 4
% eth5: Restricted-role OFF
% eth5: Version Multiple Spanning Tree Protocol - Receive MSTP - Send MSTP
% eth5: No portfast configured - Current portfast off
% eth5: bpdu-guard default - Current bpdu-guard off
% eth5: bpdu-filter default - Current bpdu-filter off
% eth5: no root guard configured - Current root guard off
% eth5: Configured Link Type point-to-point - Current point-to-point
% eth5: No auto-edge configured - Current port Auto Edge off
```

CHAPTER 7 Disable Spanning Tree Configuration

This chapter describes disabling spanning tree operation on a per Multiple Spanning Tree Instance (MSTI) basis.

Topology

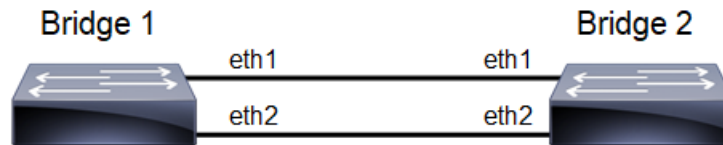

Figure 7-15: Disable Spanning Tree Topology

Note: Run the `switchport` command on each port to change to Layer-2 mode.

Disabling MSTP Configuration

Bridge 1

Disabling MSTP per instance

<code>Bridge1(config-mst)#no bridge 1 instance 2</code>	Disable spanning tree for MSTP on instance 2
<code>Bridge1(config-mst)#no bridge 1 instance 3</code>	Disable spanning tree for MSTP on instance 3
<code>Bridge1(config-mst)#commit</code>	Commit the configure on the node.

Disabling MSTP globally

<code>Bridge1(config)#no bridge 1 multiple-spanning-tree enable bridge-forward</code>	Disable spanning tree globally for MSTP and keeping the ports in forwarding state.
<code>Bridge1(config)#commit</code>	Commit the configure on the node.

Disabling MSTP per port

<code>Bridge1(config)#interface ge2</code>	Enter interface mode for ge2.
<code>Bridge1(config-if)#bridge-group 1 spanning-tree disable</code>	Disable spanning tree per port for MSTP and put port on forwarding state. This command disables any type of STP on the port.
<code>Bridge1(config-if)#commit</code>	Commit the configure on the node.

Bridge 2

Disabling MSTP per instance

<code>Bridge2(config-mst)#no bridge 1 instance 2</code>	Disable spanning tree for MSTP on instance 2
<code>Bridge2(config-mst)#no bridge 1 instance 3</code>	Disable spanning tree for MSTP on instance 3
<code>Bridge2(config-mst)#commit</code>	Commit the configure on the node.

Disabling MSTP globally

Bridge2(config)#no bridge 1 multiple-spanning-tree enable bridge-forward	Disable spanning tree globally for MSTP.
Bridge2(config)#commit	Commit the configure on the node.

Disabling MSTP per port

Bridge2(config)#interface xe2	Enter interface mode for xe2.
Bridge2(config-if)#bridge-group 1 spanning-tree disable	Disable spanning tree per port for MSTP and put port on forwarding state. This command disables any type of STP on the port.
Bridge2(config-if)#commit	Commit the configure on the node.

Validation

Bridge 1

Verify MSTP details with the show spanning-tree mst detail command.

```
#show spanning-tree mst detail
% 1: Bridge up - Spanning Tree Enabled - topology change detected
% 1: CIST Root Path Cost 0 - CIST Root Port 905 - CIST Bridge Priority 32768
% 1: Forward Delay 15 - Hello Time 2 - Max Age 20 - Transmit Hold Count 6 -
Max-hops 20
% 1: CIST Root Id 80003417ebfbe9c4
% 1: CIST Reg Root Id 80003417ebfbe9c4
% 1: CIST Bridge Id 800064006ac779a0
% 1: 9 topology change(s) - last topology change Thu Nov 17 15:06:17 2016
% 1: portfast bpdu-filter disabled
% 1: portfast bpdu-guard disabled
% 1: portfast errdisable timeout disabled
% 1: portfast errdisable timeout interval 300 sec
% ge2: Port Number 905 - Ifindex 5001 - Port Id 0x8389 - Role Rootport -
State Forwarding
% ge2: Designated External Path Cost 0 -Internal Path Cost 20000
% ge2: Configured Path Cost 20000 - Add type Explicit ref count 2
% ge2: Designated Port Id 0x838a - CIST Priority 128 -
% ge2: CIST Root 80003417ebfbe9c4
% ge2: Regional Root 80003417ebfbe9c4
% ge2: Designated Bridge 80003417ebfbe9c4
% ge2: Message Age 0 - Max Age 20
% ge2: CIST Hello Time 2 - Forward Delay 15
% ge2: CIST Forward Timer 0 - Msg Age Timer 4 - Hello Timer 0 - topo change
timer 0
% ge2: forward-transitions 1
% ge2: Version Multiple Spanning Tree Protocol - Received MSTP - Send MSTP
% ge2: No portfast configured - Current portfast off
% ge2: bpdu-guard default - Current bpdu-guard off
% ge2: bpdu-filter default - Current bpdu-filter off
% ge2: no root guard configured - Current root guard off
% ge2: Configured Link Type point-to-point - Current point-to-point
% ge2: No auto-edge configured - Current port Auto Edge off
%
```

```
% ge3: Port Number 908 - Ifindex 5004 - Port Id 0x838c - Role Alternate -
State Discarding
% ge3: Designated External Path Cost 0 -Internal Path Cost 20000
% ge3: Configured Path Cost 20000 - Add type Explicit ref count 2
% ge3: Designated Port Id 0x838b - CIST Priority 128 -
% ge3: CIST Root 80003417ebfbe9c4
% ge3: Regional Root 80003417ebfbe9c4
% ge3: Designated Bridge 80003417ebfbe9c4
% ge3: Message Age 0 - Max Age 20
% ge3: CIST Hello Time 2 - Forward Delay 15
% ge3: CIST Forward Timer 0 - Msg Age Timer 5 - Hello Timer 1 - topo change
timer 0
% ge3: forward-transitions 2
% ge3: Version Multiple Spanning Tree Protocol - Received MSTP - Send MSTP
% ge3: No portfast configured - Current portfast off
% ge3: bpdu-guard default - Current bpdu-guard off
% ge3: bpdu-filter default - Current bpdu-filter off
% ge3: no root guard configured - Current root guard off
% ge3: Configured Link Type point-to-point - Current point-to-point
% ge3: No auto-edge configured - Current port Auto Edge off

% Instance 2: Vlans: 2

% 1: MSTI Root Path Cost 20000 -MSTI Root Port 5001 - MSTI Bridge Priority
32768
% 1: MSTI Root Id 80023417ebfbe9c4
% 1: MSTI Bridge Id 800264006ac779a0
% ge2: Port Number 905 - Ifindex 5001 - Port Id 0x8389 - Role Rootport -
State Forwarding
% ge2: Designated Internal Path Cost 0 - Designated Port Id 0x838a
% ge2: Configured Internal Path Cost 20000
% ge2: Configured CST External Path cost 20000
% ge2: CST Priority 128 - MSTI Priority 128
% ge2: Designated Root 80023417ebfbe9c4
% ge2: Designated Bridge 800264006ac779a0
% ge2: Message Age 0
% ge2: Hello Time 2 - Forward Delay 15
% ge2: Forward Timer 0 - Msg Age Timer 4 - Hello Timer 0

% Instance 3: Vlans: 3

% 1: MSTI Root Path Cost 0 -MSTI Root Port 0 - MSTI Bridge Priority 32768
% 1: MSTI Root Id 800364006ac779a0
% 1: MSTI Bridge Id 800364006ac779a0
% ge3: Port Number 908 - Ifindex 5004 - Port Id 0x838c - Role Designated -
State Forwarding
% ge3: Designated Internal Path Cost 0 - Designated Port Id 0x838c
% ge3: Configured Internal Path Cost 20000
% ge3: Configured CST External Path cost 20000
% ge3: CST Priority 128 - MSTI Priority 128
% ge3: Designated Root 800364006ac779a0
% ge3: Designated Bridge 800364006ac779a0
% ge3: Message Age 0
% ge3: Hello Time 2 - Forward Delay 15
% ge3: Forward Timer 0 - Msg Age Timer 0 - Hello Timer 1
```

Verify MSTP configurations when MSTP is enabled globally.

```
#show running-config
```

```
!
bridge 1 protocol mstp
!
```

Verify MSTP configurations when MSTP is disabled globally.

```
#show running-config
!
bridge 1 protocol mstp
no bridge 1 multiple-spanning-tree enable bridge-forward
!
```

Verify MSTP configurations when MSTP instance 2 and 3 is enabled.

```
#show running-config spanning-tree
!
spanning-tree mst configuration
bridge 1 instance 2
bridge 1 instance 2 vlan 2
bridge 1 instance 3
bridge 1 instance 3 vlan 3
!
interface xe2
bridge-group 1 instance 2
!
interface xe3
bridge-group 1 instance 3
!
```

- Verify MSTP configurations when MSTP instance 2 is disabled

```
#show running-config spanning-tree
!
spanning-tree mst configuration
bridge 1 instance 3
bridge 1 instance 3 vlan 3
!
interface ge3
bridge-group 1 instance 3
!
```

Verify MSTP configurations when spanning-tree is enabled on interface.

```
#show running-config interface ge2
!
interface ge2
switchport
bridge-group 1
switchport mode access
switchport access vlan 2
bridge-group 1 instance 2
!
```

Verify MSTP configurations when spanning-tree is disabled on interface.

```
#show running-config interface ge2
!
interface ge2
switchport
bridge-group 1 spanning-tree disable
switchport mode access
switchport access vlan 2
bridge-group 1 instance 2
```

Verify MSTP details after disabling spanning-tree on interface ge2 with the show spanning-tree mst details command.

```
#show spanning-tree mst detail
% 1: Bridge up - Spanning Tree Enabled - topology change detected
% 1: CIST Root Path Cost 0 - CIST Root Port 908 - CIST Bridge Priority 32768
% 1: Forward Delay 15 - Hello Time 2 - Max Age 20 - Transmit Hold Count 6 -
Max-hops 20
% 1: CIST Root Id 80003417ebfbe9c4
% 1: CIST Reg Root Id 80003417ebfbe9c4
% 1: CIST Bridge Id 800064006ac779a0
% 1: 10 topology change(s) - last topology change Fri Nov 25 21:21:05 2016

% 1: portfast bpdu-filter disabled
% 1: portfast bpdu-guard disabled
% 1: portfast errdisable timeout disabled
% 1: portfast errdisable timeout interval 300 sec
% ge2: Port Number 905 - Ifindex 5001 - Port Id 0x8389 - Role Disabled -
State Forwarding
% ge2: Designated External Path Cost 0 -Internal Path Cost 20000
% ge2: Configured Path Cost 20000 - Add type Explicit ref count 2
% ge2: Designated Port Id 0x838a - CIST Priority 128 -
% ge2: Message Age 0 - Max Age 20
% ge2: CIST Hello Time 2 - Forward Delay 15
% ge2: CIST Forward Timer 0 - Msg Age Timer 4 - Hello Timer 0 - topo change
timer 0
% ge2: forward-transitions 2
% ge2: Version Multiple Spanning Tree Protocol - Received MSTP - Send MSTP
% ge2: No portfast configured - Current portfast off
% ge2: bpdu-guard default - Current bpdu-guard off
% ge2: bpdu-filter default - Current bpdu-filter off
% ge2: no root guard configured - Current root guard off
% ge2: Configured Link Type point-to-point - Current point-to-point
% ge2: No auto-edge configured - Current port Auto Edge off
% ge3: Port Number 908 - Ifindex 5004 - Port Id 0x838c - Role Rootport -
State Forwarding
% ge3: Designated External Path Cost 0 -Internal Path Cost 20000
% ge3: Configured Path Cost 20000 - Add type Explicit ref count 2
% ge3: Designated Port Id 0x838b - CIST Priority 128 -
% ge3: CIST Root 80003417ebfbe9c4
% ge3: Regional Root 80003417ebfbe9c4
% ge3: Designated Bridge 80003417ebfbe9c4
% ge3: Message Age 0 - Max Age 20
% ge3: CIST Hello Time 2 - Forward Delay 15
% ge3: CIST Forward Timer 0 - Msg Age Timer 4 - Hello Timer 1 - topo change
timer 0
% ge3: forward-transitions 3
% ge3: Version Multiple Spanning Tree Protocol - Received MSTP - Send MSTP
% ge3: No portfast configured - Current portfast off
% ge3: bpdu-guard default - Current bpdu-guard off
% ge3: bpdu-filter default - Current bpdu-filter off
% ge3: no root guard configured - Current root guard off
% ge3: Configured Link Type point-to-point - Current point-to-point
% ge3: No auto-edge configured - Current port Auto Edge off

% Instance 2: Vlans: 2
```

```

% 1: MSTI Root Path Cost 0 -MSTI Root Port 0 - MSTI Bridge Priority 32768
% 1: MSTI Root Id 800264006ac779a0
% 1: MSTI Bridge Id 800264006ac779a0
%   ge2: Port Number 905 - Ifindex 5001 - Port Id 0x8389 - Role Disabled -
State Discarding
%   ge2: Designated Internal Path Cost 0 - Designated Port Id 0x8389
%   ge2: Configured Internal Path Cost 20000
%   ge2: Configured CST External Path cost 20000
%   ge2: CST Priority 128 - MSTI Priority 128
%   ge2: Designated Root 800264006ac779a0
%   ge2: Designated Bridge 800264006ac779a0
%   ge2: Message Age 0
%   ge2: Hello Time 2 - Forward Delay 15
%   ge2: Forward Timer 0 - Msg Age Timer 0 - Hello Timer 0

% Instance 3: Vlans: 3

% 1: MSTI Root Path Cost 20000 -MSTI Root Port 5004 - MSTI Bridge Priority
32768
% 1: MSTI Root Id 80033417ebfbe9c4
% 1: MSTI Bridge Id 800364006ac779a0
%   ge3: Port Number 908 - Ifindex 5004 - Port Id 0x838c - Role Rootport -
State Forwarding
%   ge3: Designated Internal Path Cost 0 - Designated Port Id 0x838b
%   ge3: Configured Internal Path Cost 20000
%   ge3: Configured CST External Path cost 20000
%   ge3: CST Priority 128 - MSTI Priority 128
%   ge3: Designated Root 80033417ebfbe9c4
%   ge3: Designated Bridge 800364006ac779a0
%   ge3: Message Age 0
%   ge3: Hello Time 2 - Forward Delay 15
%   ge3: Forward Timer 0 - Msg Age Timer 4 - Hello Timer 1

```

STP Configuration

Bridge 1

Disabling STP globally

Bridgel(config)#no bridge 1 spanning-tree enable bridge-forward	Disable spanning tree globally for STP.
Bridgel(config)#commit	Commit the configure on the node.

Disabling STP per port

Bridgel(config)#interface ge2	Enter interface mode for ge2.
Bridgel(config-if)#bridge-group 1 spanning- tree disable	Disable spanning tree per port for STP and put port on forwarding state. This command disables any type of STP on the port.
Bridgel(config-if)#commit	Commit the configure on the node.

Bridge 2

Disabling STP globally

Bridge2(config)#no bridge 1 spanning-tree enable bridge-forward	Disable spanning tree globally for STP.
Bridge2(config)#commit	Commit the configure on the node.

Disabling STP per port

Bridge2(config)#interface xe2	Enter interface mode for xe2.
Bridge2(config-if)#bridge-group 1 spanning-tree disable	Disable spanning tree per port for STP and put port on forwarding state. This command disables any type of STP on the port.
Bridge2(config-if)#commit	Commit the configure on the node.

Validation

Bridge 1

Verify STP details when stp is enabled globally and ge2 and ge3 are part of the bridge using the show spanning-tree command.

```
#show spanning-tree
% 1: Bridge up - Spanning Tree Enabled - topology change
% 1: Root Path Cost 4 - Priority 32768
% 1: Forward Delay 15 - Hello Time 2 - Max Age 20 - Transmit Hold Count 6 -
Root port 905
% 1: Root Id 80003417ebfbe9c4
% 1: Bridge Id 800064006ac779a0
% 1: 3 topology changes - last topology change Tue Nov 15 21:33:53 2016
% 1: portfast bpdu-filter disabled
% 1: portfast bpdu-guard disabled
% 1: portfast errdisable timeout disabled
% 1: portfast errdisable timeout interval 300 sec

%ge2: Port Number 905 - Ifindex 5001 - Port Id 0x8389 - path cost 4 -
designated cost 0
%ge2: Designated Port Id 0x838a - state Forwarding -Priority 128
%ge2: Designated root 80003417ebfbe9c4
%ge2: Designated Bridge 80003417ebfbe9c4
%ge2: Message Age 0 - Max Age 20
%ge2: Hello Time 2 - Forward Delay 15
%ge2: Forward Timer 0 - Msg Age Timer 18 - Hello Timer 1 - topo change timer0
%ge2: forward-transitions 1
%ge2: No portfast configured - Current portfast
%ge2: bpdu-guard default- Current bpdu-guard off
%ge2: bpdu-filter default- Current bpdu-filter off
%ge2: no root guard configured- Current root guard off
%ge3: Port Number 908 - Ifindex 5004 - Port Id 0x838c - path cost 4 -
designated cost 0
%ge3: Designated Port Id 0x838b - state Blocked -Priority 128
%ge3: Designated root 80003417ebfbe9c4
%ge3: Designated Bridge 80003417ebfbe9c4
%ge3: Message Age 0 - Max Age 20
```

```
%ge3: Hello Time 2 - Forward Delay 15
%ge3: Forward Timer 0 - Msg Age Timer 19 - Hello Timer 1 - topo change timer0
%ge3: forward-transitions 0
%ge3: No portfast configured - Currentportfast off
%ge3: bpdu-guarddefault- Current bpdu-guard off
%ge3: bpdu-filter default- Current bpdu-filter off
%ge3: no root guard configured- Current root guard off
%
```

Verify STP configurations when STP is enabled globally.

```
#show running-config
!
bridge 1 protocol ieee vlan-bridge
!
```

Verify STP configurations when STP is disabled globally.

```
#show running-config
!
bridge 1 protocol ieee vlan-bridge
no bridge 1 spanning-tree enable bridge-forward
!
```

Verify STP configurations when spanning-tree is enabled on interface.

```
#show running-config interface ge2
!
interface ge2
switchport
bridge-group 1
switchport mode trunk
switchport trunk allowed vlan all
!
```

Verify STP configurations when spanning-tree is disabled on interface.

```
#show running-config interface ge2
!
interface ge2
switchport
bridge-group 1 spanning-tree disable
switchport mode trunk
switchport trunk allowed vlan all
!
```

Verify STP details after disabling spanning-tree on interface ge2 with the show spanning-tree command.

```
#show spanning-tree
% 1: Bridge up - Spanning Tree Enabled
% 1: Root Path Cost 4 - Priority 32768
% 1: Forward Delay 15 - Hello Time 2 - Max Age 20 - Transmit Hold Count 6 -
Root port 908
% 1: Root Id 80003417ebfbe9c4
% 1: Bridge Id 800064006ac779a0
% 1: 5 topology changes - last topology change Fri Nov 25 21:15:35 2016
% 1: portfast bpdu-filter disabled
% 1: portfast bpdu-guard disabled
% 1: portfast errdisable timeout disabled
% 1: portfast errdisable timeout interval 300 sec
% ge2: Port Number 905 - Ifindex 5001 - Port Id 0x8389 - path cost 4 -
designated cost 0
% ge2: Designated Port Id 0x838a - state Disabled -Priority 128
```

```

% ge2: Message Age 0 - Max Age 20
% ge2: Hello Time 2 - Forward Delay 15
% ge2: Forward Timer 0 - Msg Age Timer 18 - Hello Timer 0 - topo change
timer 23
% ge2: forward-transitions 2
% ge2: No portfast configured - Current portfast off
% ge2: bpdu-guard default - Current bpdu-guard off
% ge2: bpdu-filter default - Current bpdu-filter off
% ge2: no root guard configured - Current root guard off
%
% ge3: Port Number 908 - Ifindex 5004 - Port Id 0x838c - path cost 4 -
designated cost 0
% ge3: Designated Port Id 0x838b - state Forwarding -Priority 128
% ge3: Designated root 80003417ebfbe9c4
% ge3: Designated Bridge 80003417ebfbe9c4
% ge3: Message Age 0 - Max Age 20
% ge3: Hello Time 2 - Forward Delay 15
% ge3: Forward Timer 0 - Msg Age Timer 19 - Hello Timer 1 - topo change
timer 23
% ge3: forward-transitions 2
% ge3: No portfast configured - Current portfast off
% ge3: bpdu-guard default - Current bpdu-guard off
% ge3: bpdu-filter default - Current bpdu-filter off
% ge3: no root guard configured - Current root guard off

```

RSTP Configuration

Bridge 1

Disabling RSTP globally

Bridge1(config)#no bridge 1 rapid-spanning-tree enable bridge-forward	Disable spanning tree globally for RSTP.
Bridge1(config)#commit	Commit the configure on the node.

Disabling RSTP per port

Bridge1(config)#interface ge2	Enter interface mode for ge2.
Bridge1(config-if)#bridge-group 1 spanning-tree disable	Disable spanning tree per port for RSTP and put port on forwarding state. This command disables any type of STP on the port.
Bridge1(config-if)#commit	Commit the configure on the node.

Bridge 2

Disabling RSTP globally

Bridge2(config)#no bridge 1 rapid-spanning-tree enable bridge-forward	Disable spanning tree globally for RSTP.
Bridge2(config)#commit	Commit the configure on the node.

Disabling RSTP per port

Bridge2(config)#interface xe2	Enter interface mode for xe2.
Bridge2(config-if)#bridge-group 1 spanning-tree disable	Disable spanning tree per port for RSTP and put port on forwarding state. This command disables any type of STP on the port.
Bridge2(config-if)#commit	Commit the configure on the node.

Validation

Bridge 1

Verify RSTP details when rstp is enabled globally and ge2 and ge3 are part of the bridge using the `show spanning-tree` command.

```
#show spanning-tree
% 1: Bridge up - Spanning Tree Enabled- topology change detected
% 1: Root Path Cost 20000 - Root Port 905 -Bridge Priority 32768
% 1: Forward Delay 15 - Hello Time 2 - Max Age 20 - Transmit Hold Count 6
% 1: Root Id 80003417ebfbe9c4
% 1: Bridge Id 800064006ac779a0
% 1: last topology change Tue Nov 15 21:44:31 2016
% 1: 7 topology change(s)- last topology change Tue Nov 15 21:44:31 2016
% 1: portfast bpdu-filter disabled
% 1: portfast bpdu-guard disabled
% 1: portfast errdisable timeout disabled
% 1: portfast errdisable timeout interval 300 sec
% ge2: Port Number 905 - Ifindex 5001 - Port Id 0x8389 - Role Rootport - State Forwarding
% ge2: Designated Path Cost 0
% ge2: Configured Path Cost 20000- Add type Explicit ref count 1
% ge2: Designated Port Id 0x838a - Priority 128-
% ge2: Root 80003417ebfbe9c4
% ge2: Designated Bridge 80003417ebfbe9c4
% ge2: Message Age 0 - Max Age 20
% ge2: Hello Time 2 - Forward Delay 15
% ge2: Forward Timer 0 - Msg Age Timer 4 - Hello Timer 1 - topo change timer 0
% ge2: forward-transitions 1
% ge2: Version Rapid Spanning Tree Protocol - Received RSTP - Send RSTP
% ge2: No portfast configured - Currentportfast off
% ge2: bpdu-guarddefault- Current bpdu-guard off
% ge2: bpdu-filter default- Current bpdu-filter off
% ge2: no root guard configured- Current root guard off
% ge2: Configured Link Type point-to-point - Current point-to-point
% ge2: No auto-edge configured - Current port Auto Edge off
% ge3: Port Number 908 - Ifindex 5004 - Port Id 0x838c - Role Alternate - State Discarding
% ge3: Designated Path Cost 0
% ge3: Configured Path Cost 20000- Add type Explicit ref count 1
% ge3: Designated Port Id 0x838b - Priority 128-
% ge3: Root 80003417ebfbe9c4
% ge3: Designated Bridge 80003417ebfbe9c4
% ge3: Message Age 0 - Max Age 20
% ge3: Hello Time 2 - Forward Delay 15
```

```

% ge3: Forward Timer 0 - Msg Age Timer 5 - Hello Timer 0 - topo change timer
0
% ge3: forward-transitions 2
% ge3: Version Rapid Spanning Tree Protocol - Received RSTP - Send RSTP
% ge3: No portfast configured - Currentportfast off
% ge3: bpdu-guarddefault- Current bpdu-guard off
% ge3: bpdu-filter default- Current bpdu-filter off
% ge3: no root guard configured- Current root guard off
% ge3: Configured Link Type point-to-point - Current point-to-point
% ge3: No auto-edge configured - Current port Auto Edge off
%

```

Verify RSTP configurations when RSTP is enabled globally.

```

#show running-config
!
bridge 1 protocol rstp vlan-bridge
!

```

- Verify RSTP configurations when RSTP is disabled globally

```

#show running-config
!
bridge 1 protocol rstp vlan-bridge
no bridge 1 rapid-spanning-tree enable bridge-forward
!

```

Verify RSTP configurations when spanning-tree is enabled on interface.

```

#show running-config interface ge2
!
interface ge2
switchport
bridge-group 1
switchport mode trunk
switchport trunk allowed vlan all
!

```

Verify RSTP configurations when spanning-tree is disabled on interface.

```

#show running-config interface ge2
!
interface ge2
switchport
bridge-group 1 spanning-tree disable
switchport mode trunk
switchport trunk allowed vlan all

```

Verify RSTP details after disabling spanning-tree on interface ge2 with the show spanning-tree command.

```

#sh spanning-tree
% 1: Bridge up - Spanning Tree Enabled - topology change detected
% 1: Root Path Cost 20000 - Root Port 908 - Bridge Priority 32768
% 1: Forward Delay 15 - Hello Time 2 - Max Age 20 - Transmit Hold Count 6
% 1: Root Id 80003417ebfbe9c4
% 1: Bridge Id 800064006ac779a0
% 1: last topology change Fri Nov 25 21:08:56 2016
% 1: 11 topology change(s) - last topology change Fri Nov 25 21:08:56 2016
% 1: portfast bpdu-filter disabled
% 1: portfast bpdu-guard disabled
% 1: portfast errdisable timeout disabled
% 1: portfast errdisable timeout interval 300 sec

```

```

% ge2: Port Number 905 - Ifindex 5001 - Port Id 0x8389 - Role Disabled -
State Forwarding
% ge2: Designated Path Cost 0
% ge2: Configured Path Cost 20000 - Add type Explicit ref count 1
% ge2: Designated Port Id 0x838a - Priority 128 -
% ge2: Message Age 0 - Max Age 20
% ge2: Hello Time 2 - Forward Delay 15
% ge2: Forward Timer 0 - Msg Age Timer 5 - Hello Timer 0 - topo change timer
0
% ge2: forward-transitions 2
% ge2: Version Rapid Spanning Tree Protocol - Received RSTP - Send RSTP
% ge2: No portfast configured - Current portfast off
% ge2: bpdu-guard default - Current bpdu-guard off
% ge2: bpdu-filter default - Current bpdu-filter off
% ge2: no root guard configured - Current root guard off
% ge2: Configured Link Type point-to-point - Current point-to-point
% ge2: No auto-edge configured - Current port Auto Edge off
%
% ge3: Port Number 908 - Ifindex 5004 - Port Id 0x838c - Role Rootport -
State Forwarding
% ge3: Designated Path Cost 0
% ge3: Configured Path Cost 20000 - Add type Explicit ref count 1
% ge3: Designated Port Id 0x838b - Priority 128 -
% ge3: Root 80003417ebfbe9c4
% ge3: Designated Bridge 80003417ebfbe9c4
% ge3: Message Age 0 - Max Age 20
% ge3: Hello Time 2 - Forward Delay 15
% ge3: Forward Timer 0 - Msg Age Timer 5 - Hello Timer 1 - topo change timer
0
% ge3: forward-transitions 3
% ge3: Version Rapid Spanning Tree Protocol - Received RSTP - Send RSTP
% ge3: No portfast configured - Current portfast off
% ge3: bpdu-guard default - Current bpdu-guard off
% ge3: bpdu-filter default - Current bpdu-filter off
% ge3: no root guard configured - Current root guard off
% ge3: Configured Link Type point-to-point - Current point-to-point
% ge3: No auto-edge configured - Current port Auto Edge off

```

CHAPTER 8 VLAN Configuration

This chapter contains an example for VLAN configuration on trunk port.

Configuring VLAN Tags

Topology

This shows configuring a VLAN bridge with VLAN tags on forwarding frames. Link between Bridge 2 and Bridge 3 is configured with VLAN 5 and VLAN 10. Link between Bridge 2 and Bridge 1 is configured as VLAN 5 and link between Bridge 3 and Bridge 1 is configured as VLAN 10.

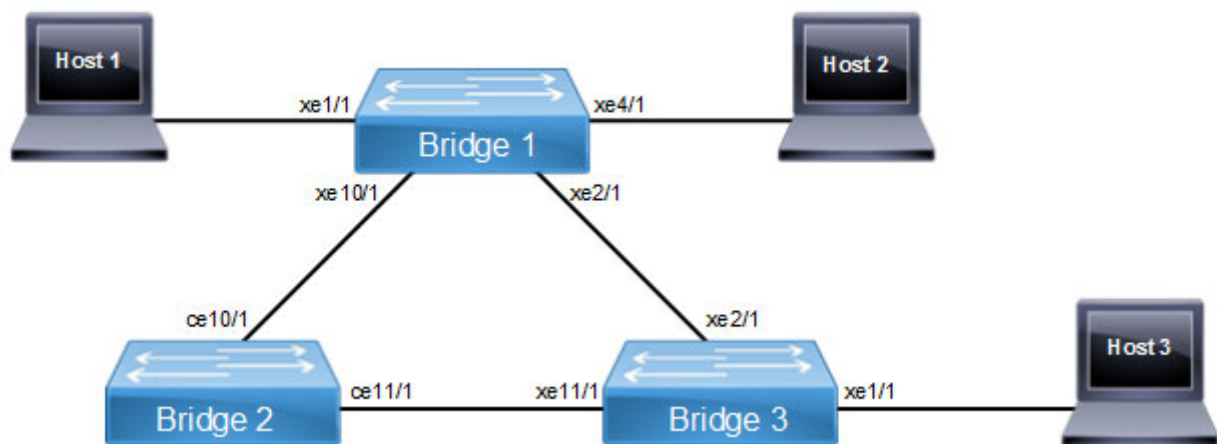

Figure 8-16: VLAN Topology

Note: Run the `switchport` command on each port to change to Layer-2 mode.

Bridge 1

<code>Bridge1#configure terminal</code>	Enter configuration mode
<code>Bridge1(config)#bridge 1 protocol ieee vlan-bridge</code>	Specify VLAN for bridge 1.
<code>Bridge1(config)#vlan database</code>	Enter the VLAN configuration mode.
<code>Bridge1(config-vlan)#vlan 5 bridge 1 state enable</code>	Enable VLAN (5) on bridge 1. Specifying the enable state allows forwarding of frames on this VLAN-aware bridge.
<code>Bridge1(config-vlan)#vlan 10 bridge 1 state enable</code>	Enable VLAN (10) on bridge 1. Specifying the enable state allows forwarding of frames on this VLAN-aware bridge.
<code>Bridge1(config-vlan)#commit</code>	Commit the candidate configuration to the running configuration.
<code>Bridge1(config-vlan)#exit</code>	Exit the VLAN configuration mode.
<code>Bridge1(config)#interface xe1/1</code>	Enter interface mode.
<code>Bridge1(config-if)#switchport</code>	Configure port as L2.
<code>Bridge1(config-if)#bridge-group 1</code>	Associate the interface with bridge group 1.

<code>Bridgel(config-if)#switchport mode access</code>	Set the switching characteristics of this interface to access mode.
<code>Bridgel(config-if)#switchport access vlan 5</code>	Enable VLAN ID 5 on this port.
<code>Bridgel(config-if)#commit</code>	Commit the candidate configuration to the running configuration.
<code>Bridgel(config-if)#exit</code>	Exit from the interface mode and go config mode.
<code>Bridgel(config)#interface xe2/1</code>	Enter interface mode.
<code>Bridgel(config-if)#switchport</code>	Configure port as L2.
<code>Bridgel(config-if)#bridge-group 1</code>	Associate the interface with bridge group 1.
<code>Bridgel(config-if)#switchport mode trunk</code>	Set the switching characteristics of this interface to trunk mode.
<code>Bridgel(config-if)#switchport trunk allowed vlan add 10</code>	Enable VLAN ID 10 on this port.
<code>Bridgel(config-if)#commit</code>	Commit the candidate configuration to the running configuration.
<code>Bridgel(config-if)#exit</code>	Exit from the interface mode and go config mode.
<code>Bridgel(config)#interface xe4/1</code>	Enter interface mode.
<code>Bridgel(config-if)#switchport</code>	Configure port as L2.
<code>Bridgel(config-if)#bridge-group 1</code>	Associate the interface with bridge group 1.
<code>Bridgel(config-if)#switchport mode access</code>	Set the switching characteristics of this interface to access mode.
<code>Bridgel(config-if)#switchport access vlan 10</code>	Enable VLAN ID 10 on this port.
<code>Bridgel(config-if)#commit</code>	Commit the candidate configuration to the running configuration.
<code>Bridgel(config-if)#exit</code>	Exit from the interface mode and go config mode.
<code>Bridgel(config)#interface xe10/1</code>	Enter interface mode.
<code>Bridgel(config-if)#switchport</code>	Configure port as L2.
<code>Bridgel(config-if)#bridge-group 1</code>	Associate the interface with bridge group 1.
<code>Bridgel(config-if)#switchport mode trunk</code>	Set the switching characteristics of this interface to trunk mode.
<code>Bridgel(config-if)#switchport trunk allowed vlan add 5</code>	Enable VLAN ID 5 on this port.
<code>Bridgel(config-if)#commit</code>	Commit the candidate configuration to the running configuration.
<code>Bridgel(config-if)#exit</code>	Exit from the interface mode and go config mode.

Bridge 2

<code>Bridge2#configure terminal</code>	Enter configure mode.
<code>Bridge2(config)#bridge 2 protocol ieee vlan-bridge</code>	Specify VLAN for bridge 2.
<code>Bridge2(config)#vlan database</code>	Enter the VLAN configuration mode.
<code>Bridge2(config-vlan)#vlan 5 bridge 2 state enable</code>	Enable VLAN (5) on bridge 2. Specifying the enable state allows forwarding of frames on this VLAN-aware bridge.
<code>Bridge2(config-vlan)#vlan 10 bridge 2 state enable</code>	Specifying the enable state allows forwarding of frames on this VLAN-aware bridge.

Bridge2(config-vlan)#commit	Commit the candidate configuration to the running configuration.
Bridge2(config-vlan)#exit	Exit the VLAN configuration mode.
Bridge2(config)#interface ce10/1	Enter interface mode.
Bridge2(config-if)#switchport	Configure port as L2.
Bridge2(config-if)#bridge-group 2	Associate the interface with bridge group 2.
Bridge2(config-if)#switchport mode trunk	Set the switching characteristics of this interface to trunk mode.
Bridge2(config-if)#switchport trunk allowed vlan add 5	Enable VLAN ID 5 on this port.
Bridge2(config-if)#switchport trunk allowed vlan add 10	Enable VLAN ID 10 on this port.
Bridge2(config-if)#commit	Commit the candidate configuration to the running configuration.
Bridge2(config-if)#exit	Exit from the interface mode and go config mode.
Bridge2(config)#interface ce11/1	Enter interface mode.
Bridge2(config-if)#switchport	Configure port as L2.
Bridge2(config-if)#bridge-group 2	Associate the interface with bridge group 2.
Bridge2(config-if)#switchport mode trunk	Set the switching characteristics of this interface to trunk mode.
Bridge2(config-if)#switchport trunk allowed vlan add 5	Enable VLAN ID 5 on this port.
Bridge2(config-if)#switchport trunk allowed vlan add 10	Enable VLAN ID 10 on this port.
Bridge2(config-if)#commit	Commit the candidate configuration to the running configuration.
Bridge2(config-if)#exit	Exit from the interface mode and go config mode.

Bridge 3

Bridge3#configure terminal	Enter configure mode.
Bridge3(config)#bridge 3 protocol ieee vlan-bridge	Specify VLAN for bridge 3.
Bridge3(config)#vlan database	Enter the VLAN configuration mode.
Bridge3(config-vlan)#vlan 5 bridge 3 state enable	Enable VLAN (5) on bridge 3. Specifying the enable state allows forwarding of frames on this VLAN-aware bridge.
Bridge3(config-vlan)#vlan 10 bridge 3 state enable	Enable VLAN (10) on bridge 3. Specifying the enable state allows forwarding of frames on this VLAN-aware bridge.
Bridge3(config-vlan)#commit	Commit the candidate configuration to the running configuration.
Bridge3(config-vlan)#exit	Exit the VLAN configuration mode.
Bridge3(config)#interface xe1/1	Enter interface mode.
Bridge3(config-if)#switchport	Configure port as L2.
Bridge3(config-if)#bridge-group 3	Associate the interface with bridge group 3.
Bridge3(config-if)#switchport mode access	Set the switching characteristics of this interface to access mode.

Bridge3(config-if)#switchport access vlan 10	Enable VLAN ID 10 on this port.
Bridge3(config-if)#commit	Commit the candidate configuration to the running configuration.
Bridge3(config-if)#exit	Exit from the interface mode and go config mode.
Bridge3(config)#interface xe2/1	Enter interface mode.
Bridge3(config-if)#switchport	Configure port as L2.
Bridge3(config-if)#bridge-group 3	Associate the interface with bridge group 3.
Bridge3(config-if)#switchport mode trunk	Set the switching characteristics of this interface to trunk mode.
Bridge3(config-if)#switchport trunk allowed vlan add 10	Enable VLAN ID 10 on this port.
Bridge3(config-if)#commit	Commit the candidate configuration to the running configuration.
Bridge3(config-if)#exit	Exit from the interface mode and go config mode.
Bridge3(config)#interface xe11/1	Enter interface mode.
Bridge3(config-if)#switchport	Configure port as L2.
Bridge3(config-if)#bridge-group 3	Associate the interface with bridge group 3.
Bridge3(config-if)#switchport mode trunk	Set the switching characteristics of this interface to trunk mode.
Bridge3(config-if)#switchport trunk allowed vlan add 5	Enable VLAN ID 5 on this port.
Bridge3(config-if)#commit	Commit the candidate configuration to the running configuration.
Bridge3(config-if)#exit	Exit from the interface mode and go config mode.

Validation

Bridge 1

```

Bridge1#show spanning-tree
% 1: Bridge up - Spanning Tree Enabled
% 1: Root Path Cost 1 - Priority 32768
% 1: Forward Delay 15 - Hello Time 2 - Max Age 20 - Transmit Hold Count 6 - Root port 909
% 1: Root Id 8000001823304db6
% 1: Bridge Id 8000001823305244
% 1: 6 topology changes - last topology change Fri Apr 19 12:32:26 2019
% 1: portfast bpdu-filter disabled
% 1: portfast bpdu-guard disabled
% 1: portfast errdisable timeout disabled
% 1: portfast errdisable timeout interval 300 sec
% xe1/1: Port Number 905 - Ifindex 5001 - Port Id 0x8389 - path cost 4 - designated cost 1
% xe1/1: Designated Port Id 0x8389 - state Forwarding -Priority 128
% xe1/1: Designated root 8000001823304db6
% xe1/1: Designated Bridge 8000001823305244
% xe1/1: Message Age 1 - Max Age 20
% xe1/1: Hello Time 2 - Forward Delay 15
% xe1/1: Forward Timer 0 - Msg Age Timer 0 - Hello Timer 0 - topo change timer 0

```

```
% xe1/1: forward-transitions 1
% xe1/1: No portfast configured - Current portfast off
% xe1/1: bpdu-guard default - Current bpdu-guard off
% xe1/1: bpdu-filter default - Current bpdu-filter off
% xe1/1: no root guard configured - Current root guard off
%
% xe2/1: Port Number 909 - Ifindex 5005 - Port Id 0x838d - path cost 1 - designated
cost 0
% xe2/1: Designated Port Id 0x838d - state Forwarding -Priority 128
% xe2/1: Designated root 8000001823304db6
% xe2/1: Designated Bridge 8000001823304db6
% xe2/1: Message Age 0 - Max Age 20
% xe2/1: Hello Time 2 - Forward Delay 15
% xe2/1: Forward Timer 0 - Msg Age Timer 19 - Hello Timer 0 - topo change timer 0
% xe2/1: forward-transitions 2
% xe2/1: No portfast configured - Current portfast off
% xe2/1: bpdu-guard default - Current bpdu-guard off
% xe2/1: bpdu-filter default - Current bpdu-filter off
% xe2/1: no root guard configured - Current root guard off
%
% xe4/1: Port Number 917 - Ifindex 5013 - Port Id 0x8395 - path cost 4 - designated
cost 1
% xe4/1: Designated Port Id 0x8395 - state Forwarding -Priority 128
% xe4/1: Designated root 8000001823304db6
% xe4/1: Designated Bridge 8000001823305244
% xe4/1: Message Age 1 - Max Age 20
% xe4/1: Hello Time 2 - Forward Delay 15
% xe4/1: Forward Timer 0 - Msg Age Timer 0 - Hello Timer 1 - topo change timer 0
% xe4/1: forward-transitions 1
% xe4/1: No portfast configured - Current portfast off
% xe4/1: bpdu-guard default - Current bpdu-guard off
% xe4/1: bpdu-filter default - Current bpdu-filter off
% xe4/1: no root guard configured - Current root guard off
%
% xe10/1: Port Number 941 - Ifindex 5037 - Port Id 0x83ad - path cost 2 - designated
cost 1
% xe10/1: Designated Port Id 0x83ad - state Forwarding -Priority 128
% xe10/1: Designated root 8000001823304db6
% xe10/1: Designated Bridge 8000001823305244
% xe10/1: Message Age 1 - Max Age 20
% xe10/1: Hello Time 2 - Forward Delay 15
% xe10/1: Forward Timer 0 - Msg Age Timer 0 - Hello Timer 0 - topo change timer 0
% xe10/1: forward-transitions 2
% xe10/1: No portfast configured - Current portfast off
% xe10/1: bpdu-guard default - Current bpdu-guard off
% xe10/1: bpdu-filter default - Current bpdu-filter off
% xe10/1: no root guard configured - Current root guard off
%
```

B1#show bridge

Ageout time is global and if something is configured for vxlan then it will be affected here also

```

Bridge      CVLAN  SVLAN  BVLAN  Port          MAC Address      FWD  Time-out
-----+-----+-----+-----+-----+-----+-----+-----+
1           1      1      xe2/1   0018.23cb.fbbc  1     300
1           1      1      xe10/1  cc37.ab97.37d8  1     300
1           5      1      xe1/1   0000.11bc.5dec  1     300
1           10     1      xe4/1   0000.2d50.205c  1     300

```

Bridgel#

Bridgel#show vlan all bridge 1

```

Bridge  VLAN ID      Name          State  H/W Status      Member ports
      (u)-Untagged, (t)-Tagged
=====
1       1       default      ACTIVE  Success      xe10/1(u) xe2/1(u)
1       5       VLAN0005    ACTIVE  Success      xe1/1(u)  xe10/1(t)
1       10      VLAN0010    ACTIVE  Success      xe4/1(u) xe2/1(t)

```

Bridgel#show bridge

Ageout time is global and if something is configured for vxlan then it will be affected here also

```

Bridge      CVLAN  SVLAN  BVLAN  Port          MAC Address      FWD  Time-out
-----+-----+-----+-----+-----+-----+-----+
1           1      1      xe2/1   0018.23cb.fbbc  1     300
1           1      1      xe10/1  cc37.ab97.37d8  1     300
1           5      1      xe1/1   0000.11bc.5dec  1     300
1           10     1      xe4/1   0000.2d50.205c  1     300

```

Bridgel#

Bridge 2

Bridge2#show bridge

Ageout time is global and if something is configured for vxlan then it will be affected here also

```

Bridge      CVLAN  SVLAN  BVLAN  Port          MAC Address      FWD  Time-out
-----+-----+-----+-----+-----+-----+-----+
2           1      1      ce10/1  0018.2326.166a  1     300
2           1      1      ce11/1  0018.23cb.fbe0  1     300
2           1      1      ce11/1  cc37.ab97.37d8  1     300
2           5      1      ce10/1  0000.11bc.5dec  1     300

```

Bridge2#show vlan all bridge 2

```

Bridge  VLAN ID      Name          State  H/W Status      Member ports
      (u)-Untagged, (t)-Tagged
=====
2       1       default      ACTIVE  Success      ce10/1(u) ce11/1(u)
2       5       VLAN0005    ACTIVE  Success      ce10/1(t) ce11/1(t)
2       10      VLAN0010    ACTIVE  Success      ce10/1(t) ce11/1(t)

```

Bridge2#show bridge

Ageout time is global and if something is configured for vxlan then it will be affected here also

Bridge	CVLAN	SVLAN	BVLAN	Port	MAC Address	FWD	Time-out
2	1			ce10/1	0018.2326.166a	1	300
2	1			ce11/1	0018.23cb.fbe0	1	300
2	1			ce11/1	cc37.ab97.37d8	1	300
2	5			ce10/1	0000.11bc.5dec	1	300

Bridge 3

Bridge3# show bridge

Ageout time is global and if something is configured for vxlan then it will be affected here also

Bridge	CVLAN	SVLAN	BVLAN	Port	MAC Address	FWD	Time-out
3	1			xe2/1	cc37.ab97.37d8	1	300
3	5			xe11/1	0000.11bc.5dec	1	300
3	10			xe2/1	0000.2d50.205c	1	300

Bridge3#show vlan all bridge 3

Bridge	VLAN ID	Name	State	H/W Status	Member ports (u)-Untagged, (t)-Tagged
3	1	default	ACTIVE	Success	xe11/1(u) xe2/1(u)
3	5	VLAN0005	ACTIVE	Success	xe11/1(t)
3	10	VLAN0010	ACTIVE	Success	xe1/1(u) xe2/1(t)

CHAPTER 9 Disabling Native VLAN Configuration

This chapter contains sample configurations to check the functionality to drop the untagged traffic by disabling the native vlan by configuring acceptable-frame-type vlan-tagged.

Topology



Figure 9-17: Native VLAN Topology

Configuration

SW1

SW1#configure terminal	Enter configuration mode
SW1(config)# bridge 1 protocol rstp vlan-bridge	Create bridge
SW1(config)#vlan database	Enter VLAN configuration mode
SW1(config-vlan)#vlan 2-10 bridge 1 state enable	Create 2-10 vlans
SW1(config-vlan)#exit	Exit VLAN configuration mode
SW1(config)#interface xe6	Enter interface configuration mode for xe6
SW1(config-if)#switchport	Configure switchport
SW1(config-if)#bridge-group 1	Associate interface with bridge-group 1
SW1(config-if)#switchport mode hybrid	Configure port mode as hybrid
SW1(config-if)# switchport hybrid allowed vlan all	Allow all the vlans on the xe6 port
SW1(config-if)#exit	Exit from interface mode
SW1(config)#interface xe21	Enter interface configuration mode for xe21
SW1(config-if)#switchport	Configure switchport
SW1(config-if)#bridge-group 1	Associate interface with bridge-group 1
SW1(config-if)#switchport mode hybrid	Configure port mode as hybrid
SW1(config-if)# switchport hybrid allowed vlan all	Allow all the vlans on the xe21 port
SW1(config-if)#exit	Exit from interface mode
SW1(config)#commit	Commit the candidate configuration to the running configuration

SW2

SW2#configure terminal	Enter configuration mode
SW2(config)# bridge 1 protocol rstp vlan-bridge	Create bridge
SW2(config)#vlan database	Enter VLAN configuration mode
SW2(config-vlan)#vlan 2-10 bridge 1 state enable	Create 2-10 vlans
SW2(config-vlan)#exit	Exit VLAN configuration mode
SW2(config)#interface xe6	Enter interface configuration mode for xe6
SW2(config-if)#switchport	Configure switchport
SW2(config-if)#bridge-group 1	Associate interface with bridge-group 1
SW2(config-if)#switchport mode hybrid	Configure port mode as hybrid
SW2(config-if)# switchport hybrid allowed vlan all	Allow all the vlans on the xe6 port
SW2(config-if)#exit	Exit from interface mode
SW2(config)#interface xe13	Enter interface configuration mode for xe13
SW2(config-if)#switchport	Configure switchport
SW2(config-if)#bridge-group 1	Associate interface with bridge-group 1
SW2(config-if)#switchport mode hybrid	Configure port mode as hybrid
SW2(config-if)# switchport hybrid allowed vlan all	Allow all the vlans on the xe13 port
SW2(config-if)#exit	Exit from interface mode
SW2(config)#commit	Commit the candidate configuration to the running configuration

Validation

Sending untagged, vlan-5 and vlan-6 traffic from ixia-1 to ixia-2. In the show bridge o/p we can see all the mac entries learnt for all the traffics.

In the show vlan brief output for default vlan interface xe21 is having port type as untagged (u).

```
SW1#show bridge
```

```
bridge 1 is running on rstp vlan-bridge
```

Ageout time is global and if something is configured for vxlan then it will be affected here also

Bridge	CVLAN	SVLAN	BVLAN	Port	MAC Address	FWD	Time-out
1	1			xe21	0000.0000.0003	1	300
1	5			xe21	0000.0000.0005	1	300
1	6			xe21	0000.0000.0006	1	300

```
SW1#sh int counters rate mbps
```

Interface	Rx mbps	Rx pps	Tx mbps	Tx pps
ce53	0.00	0	0.00	0

```

xe6          0.00          0          2960.63      246719
xe8          0.00          0          0.00         0
xe9          0.00          0          0.00         0
xe21        2960.63      246719     0.00         0

```

```
SW1#sh vlan brief
```

```

Bridge  VLAN ID   Name           State  H/W Status  Member ports
                               (u)-Untagged, (t)-Tagged
=====
1       1       default       ACTIVE Success  xe6(u) xe21(u)
1       2       VLAN0002     ACTIVE Success  xe6(t) xe21(t)
1       3       VLAN0003     ACTIVE Success  xe6(t) xe21(t)
1       4       VLAN0004     ACTIVE Success  xe6(t) xe21(t)
1       5       VLAN0005     ACTIVE Success  xe6(t) xe21(t)
1       6       VLAN0006     ACTIVE Success  xe6(t) xe21(t)
1       7       VLAN0007     ACTIVE Success  xe6(t) xe21(t)
1       8       VLAN0008     ACTIVE Success  xe6(t) xe21(t)
1       9       VLAN0009     ACTIVE Success  xe6(t) xe21(t)
1      10       VLAN0010     ACTIVE Success  xe6(t) xe21(t)

```

Configuring acceptable-frame-type vlan-tagged on ingress interface

SW1

SW1(config)#interface xe21	Enter interface configuration mode for xe21
SW1(config-if)# switchport mode hybrid acceptable-frame-type vlan-tagged	Configure acceptable-frame-type vlan-tagged
SW1(config-if)#exit	Exit from interface mode
SW1(config)#commit	Commit the candidate configuration to the running configuration

Validation

After configuring acceptable-frame-type vlan-tagged, In the show bridge o/p we can see that un-tagged traffic is dropped (.0003 mac entry is not present), and traffic also getting dropped for that specific stream.

Now on show vlan brief output we can see that xe21 interface is having port type as tagged (t).

```
SW1#sh show bridge
```

```
bridge 1 is running on rstp vlan-bridge
```

Ageout time is global and if something is configured for vxlan then it will be affected here also

```

Bridge  CVLAN  SVLAN  BVLAN  Port          MAC Address      FWD  Time-out
-----+-----+-----+-----+-----+-----+-----+-----+
1       5       5       5       xe21          0010.9400.0003   1    300
1       6       6       6       xe21          0010.9400.0004   1    300

```

```
SW1#sh int counters rate mbps
```

```

+-----+-----+-----+-----+-----+
| Interface | Rx mbps | Rx pps | Tx mbps | Tx pps |
+-----+-----+-----+-----+-----+
ce53        0.00      0        0.00      0
xe6         0.00      0        1971.13   164480
xe8         0.00      0        0.00      0
xe9         0.00      0        0.00      0
xe21       2960.64  246720   0.00      0
  
```

SW1#sh vlan brief

```

Bridge  VLAN ID   Name                State  H/W Status  Member ports
              (u)-Untagged, (t)-Tagged
=====
1        1      default            ACTIVE Success  xe6(u) xe21(t)
1        2      VLAN0002          ACTIVE Success  xe6(t) xe21(t)
1        3      VLAN0003          ACTIVE Success  xe6(t) xe21(t)
1        4      VLAN0004          ACTIVE Success  xe6(t) xe21(t)
1        5      VLAN0005          ACTIVE Success  xe6(t) xe21(t)
1        6      VLAN0006          ACTIVE Success  xe6(t) xe21(t)
1        7      VLAN0007          ACTIVE Success  xe6(t) xe21(t)
1        8      VLAN0008          ACTIVE Success  xe6(t) xe21(t)
1        9      VLAN0009          ACTIVE Success  xe6(t) xe21(t)
1       10      VLAN0010          ACTIVE Success  xe6(t) xe21(t)
  
```

CHAPTER 10 Disabling Native VLAN Configuration on Trunk mode

This chapter contains sample configurations to check the functionality to drop the untagged traffic by disabling the native VLAN by configuring disable-native-VLAN.

Topology



Figure 10-18: Native VLAN Topology

Configuration

SW1

SW1#configure terminal	Enter configuration mode
SW1(config)#bridge 1 protocol mstp	Create bridge
SW1(config)#vlan database	Enter VLAN configuration mode
SW1(config-vlan)#vlan 2-10 bridge 1 state enable	Create 2-10 vlans
SW1(config-vlan)#exit	Exit VLAN configuration mode
SW1(config)#interface xe21	Enter interface configuration mode for xe21
SW1(config-if)#switchport	Configure switchport
SW1(config-if)#bridge-group 1	Associate interface with bridge-group 1
SW1(config-if)#switchport mode trunk	Configure port mode as trunk
SW1(config-if)#switchport trunk allowed vlan all	Allow all the VLANs on the xe21 port
SW1(config-if)#exit	Exit from interface mode
SW1(config)#interface xe6	Enter interface configuration mode for xe6
SW1(config-if)#switchport	Configure switchport
SW1(config-if)#bridge-group 1	Associate interface with bridge-group 1
SW1(config-if)#switchport mode trunk	Configure port mode as trunk
SW1(config-if)#switchport trunk allowed vlan all	Allow all the VLANs on the xe6 port
SW1(config-if)#exit	Exit from interface mode
SW1(config)#commit	Commit the candidate configuration to the running configuration

SW2

SW2#configure terminal	Enter configuration mode
SW2(config)#bridge 1 protocol rstp vlan-bridge	Create bridge
SW2(config)#vlan database	Enter VLAN configuration mode
SW2(config-vlan)#vlan 2-10 bridge 1 state enable	Create 2-10 vlans
SW2(config-vlan)#exit	Exit VLAN configuration mode
SW2(config)#interface xe6	Enter interface configuration mode for xe6
SW2(config-if)#switchport	Configure switchport
SW2(config-if)#bridge-group 1	Associate interface with bridge-group 1
SW2(config-if)#switchport mode trunk	Configure port mode as trunk
SW2(config-if)#switchport trunk allowed vlan all	Allow all the VLANs on the xe6 port
SW2(config-if)#exit	Exit from interface mode
SW2(config)#interface xe13	Enter interface configuration mode for xe13
SW2(config-if)#switchport	Configure switchport
SW2(config-if)#bridge-group 1	Associate interface with bridge-group 1
SW2(config-if)#switchport mode trunk	Configure port mode as trunk
SW2(config-if)#switchport trunk allowed vlan all	Allow all the VLANs on the xe13 port
SW2(config-if)#exit	Exit from interface mode
SW2(config)#commit	Commit the candidate configuration to the running configuration

Validation

Sending untagged, VLAN-5 and VLAN-6 traffic from IXIA-1 to IXIA-2. In the show bridge output we can see all the MAC entries learnt for all the traffics.

In the show vlan brief output for default VLAN interface xe21 is having port type as untagged (u).

```
SW1#show bridge
```

```
bridge 1 is running on mstp
```

Ageout time is global and if something is configured for vxlan then it will be affected here also

```
Bridge      CVLAN  SVLAN  BVLAN  Port          MAC Address      FWD  Time-out
-----+-----+-----+-----+-----+-----+-----+-----+
1           1              xe21          0010.9400.0001  1       300
```

```
SW1#show interface counters rate mbps
```

```
+-----+-----+-----+-----+-----+-----+
| Interface | Rx mbps | Rx pps | Tx mbps | Tx pps |
+-----+-----+-----+-----+-----+
xe21        621.21  606650  0.00     0
xe6         0.00    0       621.21  606651
```



```
SW1#show vlan brief
```

Bridge	VLAN ID	Name	State	H/W Status	Member ports (u)-Untagged, (t)-Tagged
1	1	default	ACTIVE	Success	xe21 (u) xe6 (u)
1	2	VLAN0002	ACTIVE	Success	xe21 (t) xe6 (t)
1	3	VLAN0003	ACTIVE	Success	xe21 (t) xe6 (t)
1	4	VLAN0004	ACTIVE	Success	xe21 (t) xe6 (t)
1	5	VLAN0005	ACTIVE	Success	xe21 (t) xe6 (t)
1	6	VLAN0006	ACTIVE	Success	xe21 (t) xe6 (t)
1	7	VLAN0007	ACTIVE	Success	xe21 (t) xe6 (t)
1	8	VLAN0008	ACTIVE	Success	xe21 (t) xe6 (t)
1	9	VLAN0009	ACTIVE	Success	xe21 (t) xe6 (t)
1	10	VLAN0010	ACTIVE	Success	xe21 (t) xe6 (t)

Configuring Disable-Native-VLAN on Trunk mode

SW1

SW1(config)#interface xe21	Enter interface configuration mode for xe21
SW1(config-if)#switchport mode trunk disable-native-vlan	Configure disable native VLAN on trunk mode
SW1(config-if)#exit	Exit from interface mode
SW1(config)#commit	Commit the candidate configuration to the running configuration

Validation

After configuring disable-native-vlan, show vlan brief output we can see that xe21 interface is having port type as tagged (t).

```
SW1#show bridge
```

```
bridge 1 is running on mstp
```

Ageout time is global and if something is configured for vxlan then it will be affected here also

Bridge	CVLAN	SVLAN	BVLAN	Port	MAC Address	FWD	Time-out
1	1			xe21	0010.9400.0001	1	300

```
SW1SW1#show vlan brief
```

Bridge	VLAN ID	Name	State	H/W Status	Member ports (u)-Untagged, (t)-Tagged
1	1	default	ACTIVE	Success	xe21 (t) xe6 (u)
1	2	VLAN0002	ACTIVE	Success	xe21 (t) xe6 (t)
1	3	VLAN0003	ACTIVE	Success	xe21 (t) xe6 (t)
1	4	VLAN0004	ACTIVE	Success	xe21 (t) xe6 (t)
1	5	VLAN0005	ACTIVE	Success	xe21 (t) xe6 (t)

```

1      6      VLAN0006      ACTIVE  Success  xe21(t) xe6(t)
1      7      VLAN0007      ACTIVE  Success  xe21(t) xe6(t)
1      8      VLAN0008      ACTIVE  Success  xe21(t) xe6(t)
1      9      VLAN0009      ACTIVE  Success  xe21(t) xe6(t)
1     10     VLAN0010      ACTIVE  Success  xe21(t) xe6(t)

```

SW1#show interface counters rate mbps

```

+-----+-----+-----+-----+
| Interface | Rx mbps | Rx pps | Tx mbps | Tx pps |
+-----+-----+-----+-----+
Xe21      864.88  844613  0.00     0
Xe6       0.00    0       0.00     0

```

SW1#show interface counters drop-stats

Interface xe21

Rx Policy Discards: 454522965

Rx EGR Port Unavail: 454522967

CHAPTER 11 802.1X Configuration

IEEE 802.1x restricts unauthenticated devices from connecting to a switch. Only after authentication is successful, traffic is allowed through the switch.

Topology

In this example, a radius server keeps the client information, validating the identity of the client and updating the switch about the authentication status of the client. The switch is the physical access between the two clients and the server. It requests information from the client, relays information to the server and then back to the client. To configure 802.1x authentication, enable authentication on ports eth1 and eth2 and specify the radius server IP address and port.

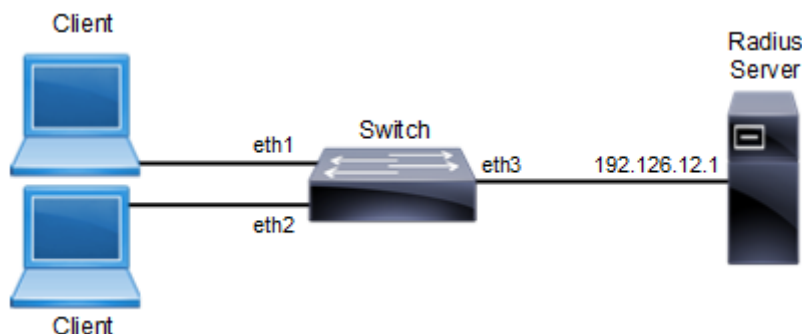

Figure 11-19: 802.1x Topology

Switch Configuration

Switch#configure terminal	Enter configure mode.
Switch(config)#port-security disable	Disable the port-security.
Switch(config)#dot1x system-auth-ctrl	Enable authentication globally.
Switch(config)#interface eth2	Enter interface mode.
Switch(config-if)#switchport	Enable switch port on interface.
Switch(config-if)#dot1x port-control auto	Enable authentication (via Radius) on port (eth2).
Switch(config-if)#exit	Exit interface mode.
Switch(config)#interface eth1	Enter interface mode.
Switch(config-if)#switchport	Enable switch port on interface.
Switch(config-if)#dot1x port-control auto	Enable authentication (via Radius) on port (eth1).
Switch(config-if)#exit	Exit interface mode.
Switch(config)#radius-server dot1x key-string testing123	Specify key with string name between radius server and client
Switch(config)#radius-server dot1x host 192.126.12.1	Specify the Radius Server address (192.126.12.1)
Switch(config-radius-server)#exit	Exit from radius server mode.
Switch(config)#interface eth3	Enter interface mode.
Switch(config-if)#ip address 192.126.12.2/24	Set the IP address on interface eth3.
Switch(config-if)#commit	Commit the transaction.
Switch(config-if)#exit	Exit interface mode.

Validation

show dot1x, show dot1x all

```
#show dot1x all
802.1X Port-Based Authentication Enabled
  RADIUS server address: 192.126.12.1:1812
  Next radius message id: 0
  RADIUS client address: not configured

802.1X info for interface gel
  Supplicant address: 0000.0000.0000
  portEnabled: true - portControl: Auto
  portStatus: Unauthorized - currentId: 1
  protocol version: 2
  reAuthenticate: disabled
  reAuthPeriod: 3600
  abort:F fail:F start:F timeout:F success:F
  PAE: state: Connected - portMode: Auto
  PAE: reAuthCount: 0 - rxRespId: 0
  PAE: quietPeriod: 60 - reauthMax: 2 - txPeriod: 30
  BE: state: Invalid - reqCount: 0 - idFromServer: 0
  BE: suppTimeout: 30 - serverTimeout: 30
  CD: adminControlledDirections: in - operControlledDirections: in
  CD: bridgeDetected: false
  KR: rxKey: false
  KT: keyAvailable: false - keyTxEnabled: false

#show dot1x
802.1X Port-Based Authentication Enabled
  RADIUS server address: 192.126.12.1:1812
  Next radius message id: 0
  RADIUS client address: not configured
```

CHAPTER 12 Link Aggregation Configuration

This chapter contains a complete sample Link Aggregation Group configuration.

LACP is based on the 802.3ad IEEE specification. It allows bundling of several physical interfaces to form a single logical channel providing enhanced performance and redundancy. The aggregated interface is viewed as a single link to each switch. The spanning tree views it as one interface and not as two or three interfaces. When there is a failure in one physical interface, the other interfaces stay up and there is no disruption. Traffic can be load balanced within an LACP trunk group in a controlled manner using the hashing algorithm.

The maximum number of physical Ethernet links in a single logical channel depends upon the hardware support. [Table 12-1](#) lists the number of LAG groups per device and number of port settings per LAG group for the QMX, QUX, and QAX hardware.

Table 12-1: Number of LAGs and ports supported

Hardware	Number of LAG groups per device	Number of port settings per LAG group
QMX	256	64
QUX	32	64
QAX	256	64

Note:

- Physical interfaces inherit the properties of LAG port once it is attached to be part of LAG, irrespective of the configuration present on the physical interface.
- In case of dynamic LAG and static LAG, member ports could be moved from one LAG to another LAG, without unconfiguring the member port.
- LAG port should be configured as a switch or router port, before adding member ports into it.

Topology

In [Figure 12-20](#), 3 links are configured between the two switches SW1 and SW2. These three links are assigned the same administrative key (1) so that they aggregate to form a single channel 1. They are viewed by the STP as one interface.

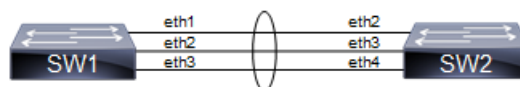

Figure 12-20: LACP topology

Dynamic LAG Configuration

SW1

SW1#configure terminal	Enter configure mode.
SW1(config)# bridge 1 protocol mstp	Configure bridge 1 as MSTP bridge

SW1(config)# vlan database	Enter VLAN database mode.
SW1(config-vlan)# vlan 2-10 bridge 1 state enable	Configure a VLAN and add it to the bridge.
SW1(config-vlan)# commit	Commit the candidate configuration to the running Configuration.
SW1(config-vlan)# exit	Exit the VLAN configuration mode.
SW1(config)#lacp system-priority 20000	Set the system priority of this switch. This priority is used for determining the system that is responsible for resolving conflicts in the choice of aggregation groups. A lower numerical value has a higher priority.
SW1(config)#interface po10	Enter into port channel interface po10.
SW1(config-if)#switchport	Configure po10 as a layer 2 port.
SW1(config-if)#bridge-group 1	Associate bridge to an interface.
SW1(config-if)#switchport mode trunk	Configure port as a trunk.
SW1(config-if)#switchport trunk allowed vlan all	Allow all the VLANs on the po10 interface.
SW1(config-if)#commit	Commit the candidate configuration to the running Configuration.
SW1(config-if)#exit	Exit interface mode.
SW1(config)#interface eth1	Enter interface mode.
SW1(config-if)#channel-group 10 mode active	Add this interface to channel group 10 and enable link aggregation so that it can be selected for aggregation by the local system.
SW1(config-if)#commit	Commit the candidate configuration to the running Configuration.
SW1(config-if)#exit	Exit interface mode.
SW1(config)#interface eth2	Enter interface mode.
SW1(config-if)#channel-group 10 mode active	Add this interface to channel group 10 and enable link aggregation so that it can be selected for aggregation by the local system.
SW1(config-if)#commit	Commit the candidate configuration to the running Configuration.
SW1(config-if)#exit	Exit interface mode.
SW1(config)#interface eth3	Enter interface mode.
SW1(config-if)#channel-group 10 mode active	Add this interface to channel group 10 and enable link aggregation so that it can be selected for aggregation by the local system.
SW1(config-if)#commit	Commit the candidate configuration to the running Configuration.
SW1(config-if)#exit	Exit interface mode.

SW2

SW2#configure terminal	Enter configure mode.
SW2(config)# bridge 1 protocol mstp	Configure bridge 1 as MSTP bridge
SW2(config)# vlan database	Enter VLAN database mode.

SW2(config-vlan)# vlan 2-10 bridge 1 state enable	Configure a VLAN and add it to the bridge.
SW2(config-vlan)# commit	Commit the candidate configuration to the running Configuration.
SW2(config-vlan)# exit	Exit the VLAN configuration mode.
SW2(config)#lacp system-priority 20000	Set the system priority of this switch. This priority is used for determining the system that is responsible for resolving conflicts in the choice of aggregation groups. A lower numerical value has a higher priority.
SW2(config)#interface po10	Enter into port channel interface po10.
SW2(config-if)#switchport	Configure po10 as a layer 2 port.
SW2(config-if)#bridge-group 1	Associate bridge to an interface.
SW2(config-if)#switchport mode trunk	Configure port as a trunk.
SW2(config-if)#switchport trunk allowed vlan all	Allow all the VLANs on the po10 interface.
SW2(config-if)#commit	Commit the candidate configuration to the running Configuration.
SW2(config-if)#exit	Exit interface mode.
SW2(config)#interface eth2	Enter interface mode.
SW2(config-if)#channel-group 10 mode active	Add this interface to channel group 10 and enable link aggregation so that it can be selected for aggregation by the local system.
SW2(config-if)#commit	Commit the candidate configuration to the running Configuration.
SW2(config-if)#exit	Exit interface mode.
SW2(config)#interface eth3	Enter interface mode.
SW2(config-if)#channel-group 10 mode active	Add this interface to channel group 10 and enable link aggregation so that it can be selected for aggregation by the local system.
SW2(config-if)#commit	Commit the candidate configuration to the running Configuration.
SW2(config-if)#exit	Exit interface mode.
SW2(config)#interface eth4	Enter interface mode.
SW2(config-if)#channel-group 10 mode active	Add this interface to channel group 10 and enable link aggregation so that it can be selected for aggregation by the local system.
SW2(config-if)#commit	Commit the candidate configuration to the running Configuration.
SW2(config-if)#exit	Exit interface mode.

Validation

show etherchannel detail, show etherchannel summary, show running-config interface po10, show running-config interface eth1

```
#show etherchannel detail
% Aggregator po10 7
% Aggregator Type: Layer2
% Mac address: 08:00:27:50:6a:9b
```

```
% Admin Key: 0010 - Oper Key 0010
% Actor LAG ID- 0x4e20,08-00-27-ab-ea-38,0x000a
% Receive link count: 3 - Transmit link count: 3
% Individual: 0 - Ready: 1
% Partner LAG ID- 0x4e20,08-00-27-f8-3c-30,0x000a
% Link: eth1 (3) sync: 1
% Link: eth2 (4) sync: 1
% Link: eth3 (5) sync: 1
% Collector max delay: 5
```

```
#show etherchannel summary
% Aggregator po10 7
% Aggregator Type: Layer2
% Admin Key: 0010 - Oper Key 0010
% Aggregator Type: Layer2
% Link: eth1 (3) sync: 1
% Link: eth2 (4) sync: 1
% Link: eth3 (5) sync: 1
```

```
#show running-config interface po10
!
interface po10
 switchport
 bridge-group 1
 switchport mode trunk
 switchport trunk allowed vlan all
```

```
#show running-config interface eth1
!
interface eth1
 channel-group 10 mode active
```

Static LAG Configuration

SW1

SW1#configure terminal	Enter configure mode.
SW1(config)# bridge 1 protocol mstp	Configure bridge 1 as MSTP bridge
SW1(config)# vlan database	Enter VLAN database mode.
SW1(config-vlan)# vlan 2-10 bridge 1 state enable	Configure a VLAN and add it to the bridge.
SW1(config-vlan)# commit	Commit the candidate configuration to the running Configuration.
SW1(config-vlan)# exit	Exit the VLAN configuration mode.
SW1(config)#lacp system-priority 20000	Set the system priority of this switch. This priority is used for determining the system that is responsible for resolving conflicts in the choice of aggregation groups. A lower numerical value has a higher priority.
SW1(config)#interface sa10	Enter into port channel interface sa10.
SW1(config-if)#switchport	Configure sa10 as a layer 2 port.
SW1(config-if)#bridge-group 1	Associate bridge to an interface.

SW1(config-if)#switchport mode trunk	Configure port as a trunk.
SW1(config-if)#switchport trunk allowed vlan all	Allow all the VLANs on the po10 interface.
SW1(config-if)#commit	Commit the candidate configuration to the running Configuration.
SW1(config-if)#exit	Exit interface mode.
SW1(config)#interface eth1	Enter interface mode.
SW1(config-if)#static-channel-group 10	Add this interface to channel group 10 and enable link aggregation so that it can be selected for aggregation by the local system.
SW1(config-if)#commit	Commit the candidate configuration to the running Configuration.
SW1(config-if)#exit	Exit interface mode.
SW1(config)#interface eth2	Enter interface mode.
SW1(config-if)#static-channel-group 10	Add this interface to channel group 10 and enable link aggregation so that it can be selected for aggregation by the local system.
SW1(config-if)#commit	Commit the candidate configuration to the running Configuration.
SW1(config-if)#exit	Exit interface mode.
SW1(config)#interface eth3	Enter interface mode.
SW1(config-if)#static-channel-group 10	Add this interface to channel group 10 and enable link aggregation so that it can be selected for aggregation by the local system.
SW1(config-if)#commit	Commit the candidate configuration to the running Configuration.
SW1(config-if)#exit	Exit interface mode.

SW2

SW2#configure terminal	Enter configure mode.
SW2(config)# bridge 1 protocol mstp	Configure bridge 1 as MSTP bridge
SW2(config)# vlan database	Enter VLAN database mode.
SW2(config-vlan)# vlan 2-10 bridge 1 state enable	Configure a VLAN and add it to the bridge.
SW2(config-vlan)# commit	Commit the candidate configuration to the running Configuration.
SW2(config-vlan)# exit	Exit the VLAN configuration mode.
SW2(config)#interface sa10	Enter into port channel interface sa10.
SW2(config-if)#switchport	Configure sa10 as a layer 2 port.
SW2(config-if)#bridge-group 1	Associate bridge to an interface.
SW2(config-if)#switchport mode trunk	Configure port as a trunk.
SW2(config-if)#switchport trunk allowed vlan all	Allow all the VLANs on the po10 interface.
SW2(config-if)#commit	Commit the candidate configuration to the running Configuration.
SW2(config-if)#exit	Exit interface mode.

SW2 (config)#interface eth2	Enter interface mode.
SW2 (config-if)#static-channel-group 10	Add this interface to channel group 10 and enable link aggregation so that it can be selected for aggregation by the local system.
SW2 (config-if)#commit	Commit the candidate configuration to the running Configuration.
SW2 (config-if)#exit	Exit interface mode.
SW2 (config)#interface eth3	Enter interface mode.
SW2 (config-if)#static-channel-group 10	Add this interface to channel group 10 and enable link aggregation so that it can be selected for aggregation by the local system.
SW2 (config-if)#exit	Exit interface mode.
SW2 (config)#interface eth4	Enter interface mode.
SW2 (config-if)#static-channel-group 10	Add this interface to channel group 10 and enable link aggregation so that it can be selected for aggregation by the local system.
SW2 (config-if)#commit	Commit the candidate configuration to the running Configuration.
SW2 (config-if)#exit	Exit interface mode.

Validation

```
#show static-channel-group
% Static Aggregator: sa10
% Member status:
  eth1    up
  eth2    up
  eth3    up

#show running-config interface sa10
!
interface sa10
  switchport
  bridge-group 1
  switchport mode trunk
  switchport trunk allowed vlan all

#show running-config interface eth1
!
interface eth1
  static-channel-group 10
```

Static LAG Minimum Link Configuration

Configure the minimum number of ports that must be linked up and bundled in the LACP port channel. We can configure the minimum links range from 2 to 32. If the number of ports aggregated to the port channel is less than the minimum number of links configured, then the port channel enters the Protocol Down because of the minimum link state.

Note: Minimum links should be configured the same on both sides for optimal performance.

Topology

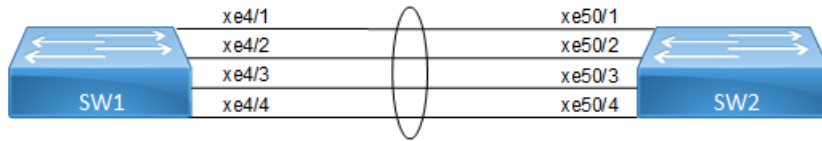

Figure 12-21: LAG minimum link

SW1

#configure terminal	Enter configure mode.
(config)#interface sa10	Creating interface static-lag sa10
(config-if)#port-channel min-links 4	Configuring port channel minimum links as 4(range is 2-32)
(config-if)#commit	Commit the candidate configuration to the running Configuration.
(config-if)#exit	Exit the configure mode

Validation

SW1

```
#show static-channel-group 10
% Static Aggregator: sa10
% Minimum-Links 4
% Member status:
    xe4/1      up
    xe4/2      up
    xe4/3      up
    xe4/4      up
```

```
#show running-config interface sa10
!
interface sa10
  switchport
  bridge-group 1
  switchport mode trunk
  switchport trunk allowed vlan all
  port-channel min-links 4
```

SW2

#configure terminal	Enter configure mode.
(config)#interface sa10	Creating interface port-channel sa10
(config-if)#port-channel min-links 4	Configuring port channel minimum links as 4 (range is 2-32)
(config-if)#commit	Commit the candidate configuration to the running Configuration.
(config-if)#exit	Exit the configure mode

Validation

SW2

```
#show running-config interface sa10
!
interface sa10
  switchport
  bridge-group 1
  switchport mode trunk
  switchport trunk allowed vlan all
  port-channel min-links 4
!

#show static-channel-group 10
% Static Aggregator: sa10
% Minimum-Links 4
% Member status:
      Xe50/1      up
      Xe50/2      up
      Xe50/3      up
      Xe50/4      up
```

Note: When a sa goes down due to the minimum links configured (number of minimum links is greater than the links aggregated to the sa).

SW1:

=====

```
#sh int brief sa10
```

```
Codes: ETH - Ethernet, LB - Loopback, AGG - Aggregate, MLAG - MLAG Aggregate
       FR - Frame Relay, TUN -Tunnel, PBB - PBB Logical Port, VP - Virtual
Port
Unknown CVP - Channelised Virtual Port, METH - Management Ethernet, UNK-
        ED - ErrDisabled, PD - Protocol Down, AD - Admin Down,
        IA - InActive
        PD(Min L/B) - Protocol Down Min-Links/Bandwidth
        DV - DDM Violation, NA - Not Applicable
        NOM - No operational members, PVID - Port Vlan-id
        Ctl - Control Port (Br-Breakout/Bu-Bundle)
        HD - ESI Hold Timer Down
```

```
-----
--
Port-channel  Type  PVID  Mode                Status  Reason  Speed
Interface
-----
--
sa10          AGG   1     trunk              down    PD(Min L/B)  0
#
```

SW2:

=====

```
#sh int brief sa10
```

```
Codes: ETH - Ethernet, LB - Loopback, AGG - Aggregate, MLAG - MLAG Aggregate
       FR - Frame Relay, TUN -Tunnel, PBB - PBB Logical Port, VP - Virtual
Port
       CVP - Channelised Virtual Port, METH - Management Ethernet, UNK-
Unknown
       ED - ErrDisabled, PD - Protocol Down, AD - Admin Down,
       IA - InActive
       PD(Min L/B) - Protocol Down Min-Links/Bandwidth
       DV - DDM Violation, NA - Not Applicable
       NOM - No operational members, PVID - Port Vlan-id
       Ctl - Control Port (Br-Breakout/Bu-Bundle)
       HD - ESI Hold Timer Down
```

```
-----
--
Port-channel  Type  PVID  Mode                Status  Reason  Speed
Interface
-----
--
sa10          AGG   1     trunk               down    PD(Min L/B)  0
#
```

Static-LAG Minimum Bandwidth Configuration

Configure the minimum bandwidth allowed for ports that must be linked up and bundled in the LACP port channel. We can configure the minimum bandwidth range from `BANDWIDTH <1-999>k|m` for 1 to 999 kilo bits or mega bits `<1-1000>g` for 1 to 1000 giga bits. If the Total bandwidth of ports aggregated to the port channel is less than the minimum Bandwidth value configured, then the port channel enters the Protocol Down because of the minimum Bandwidth state.

Note: Minimum Bandwidth should be configured the same on both sides for optimal performance.

Topology

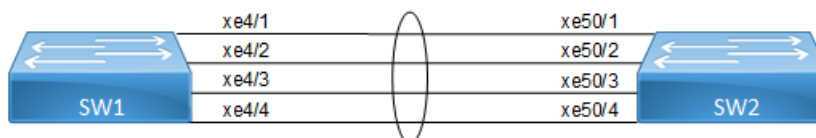

Figure 12-22: LAG minimum bandwidth

SW1

#configure terminal	Enter configure mode.
(config)#interface sa10	Creating interface static-lag sa10
(config-if)#port-channel min-bandwidth 40g	Configuring port channel minimum bandwidth as 40g (range from BANDWIDTH <1-999>k m for 1 to 999 kilo bits or mega bits <1-1000>g for 1 to 1000 giga bits.)
(config-if)#commit	Commit the candidate configuration to the running Configuration.
(config-if)#exit	Exit the configure mode

Validation

SW1

```
#show static-channel-group 10
% Static Aggregator: sa10
% Minimum- 4
% Member status:
    xe4/1      up
    xe4/2      up
    xe4/3      up
    xe4/4      up

#show running-config interface sa10
!
interface sa10
  switchport
  bridge-group 1
  switchport mode trunk
  switchport trunk allowed vlan all
  port-channel min-links 40g
```

SW2

#configure terminal	Enter configure mode.
(config)#interface sa10	Creating interface port-channel sa10
(config-if)#port-channel min-bandwidth 40g	Configuring port channel minimum bandwidth as 40g (range from BANDWIDTH <1-999>k m for 1 to 999 kilo bits or mega bits <1-1000>g for 1 to 1000 giga bits.)
(config-if)#commit	Commit the candidate configuration to the running Configuration.
(config-if)#exit	Exit the configure mode

Validation

SW2

```
#show running-config interface sa10
!
interface sa10
  switchport
  bridge-group 1
  switchport mode trunk
  switchport trunk allowed vlan all
  port-channel min-bandwidth 40g
!

#show static-channel-group 10
% Static Aggregator: sa10
% Minimum-bandwidth 40g
```

```
% Member status:
    Xe50/1      up
    Xe50/2      up
    Xe50/3      up
    Xe50/4      up
```

Note: When sa goes down due to [Total Bandwidth of sa] < [Minimum Bandwidth value Configured]

SW1:

=====

```
#sh int brief sa10
```

```
Codes: ETH - Ethernet, LB - Loopback, AGG - Aggregate, MLAG - MLAG Aggregate
       FR - Frame Relay, TUN -Tunnel, PBB - PBB Logical Port, VP - Virtual
Port
       CVP - Channelised Virtual Port, METH - Management Ethernet, UNK-
Unknown
       ED - ErrDisabled, PD - Protocol Down, AD - Admin Down,
       IA - InActive
       PD(Min L/B) - Protocol Down Min-Links/Bandwidth
       DV - DDM Violation, NA - Not Applicable
       NOM - No operational members, PVID - Port Vlan-id
       Ctl - Control Port (Br-Breakout/Bu-Bundle)
       HD - ESI Hold Timer Down
```

```
-----
--
Port-channel Type PVID Mode           Status   Reason Speed
Interface
-----
--
sa10          AGG    1    trunk           down    PD(Min L/B)  0
#
```

SW2:

=====

```
#sh int brief sa10
```

```
Codes: ETH - Ethernet, LB - Loopback, AGG - Aggregate, MLAG - MLAG Aggregate
       FR - Frame Relay, TUN -Tunnel, PBB - PBB Logical Port, VP - Virtual
Port
       CVP - Channelised Virtual Port, METH - Management Ethernet, UNK-
Unknown
       ED - ErrDisabled, PD - Protocol Down, AD - Admin Down,
       IA - InActive
       PD(Min L/B) - Protocol Down Min-Links/Bandwidth
       DV - DDM Violation, NA - Not Applicable
       NOM - No operational members, PVID - Port Vlan-id
       Ctl - Control Port (Br-Breakout/Bu-Bundle)
       HD - ESI Hold Timer Down
```

```
-----
--
```

```

Port-channel  Type  PVID  Mode                Status  Reason  Speed
Interface
-----
--
sa10          AGG   1     trunk              down   PD (Min L/B)  0
#

```

Dynamic-LAG Minimum Link Configuration

Configure the minimum number of ports that must be linked up and bundled in the LACP port channel. We can configure the minimum links range from 2 to 32. If the number of ports aggregated to the port channel is less than the minimum number of links configured, then the port channel enters the Protocol Down because of the minimum link state.

Note: Minimum links should be configured the same on both sides for optimal performance.

Topology

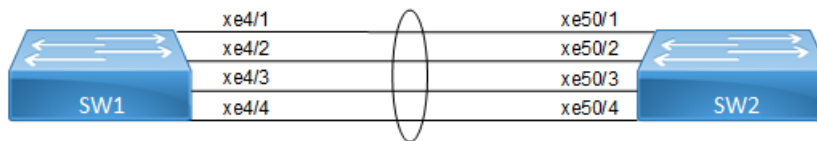

Figure 12-23: LAG minimum link

SW1

#configure terminal	Enter configure mode.
(config)#interface po10	Creating interface port-channel po10
(config-if)#port-channel min-links 4	Configuring port channel minimum links as 4 (range is 2-32)
(config-if)#commit	Commit the candidate configuration to the running Configuration.
(config-if)#exit	Exit the configure mode

Validation

SW1

```

#sh running-config interface po10

interface po10
 switchport
 bridge-group 1
 switchport mode trunk
 switchport trunk allowed vlan all
 port-channel min-links 4
 !
 !

```



```
#show etherchannel
-----
% LACP Aggregator: po10
% Min-links : 4
% Member:
  xe4/1
  xe4/2
  xe4/3
  xe4/4
-----

#show etherchannel summary

% Aggregator po10 100010
% Aggregator Type: Layer2
% Admin Key: 0010 - Oper Key 0010
% Link: xe4/4 (10072) sync: 1
% Link: xe4/1 (10069) sync: 1
% Link: xe4/2 (10070) sync: 1
% Link: xe4/3 (10071) sync: 1
-----
```

SW2

#configure terminal	Enter configure mode.
(config)#interface po10	Creating interface port-channel po10
(config-if)#port-channel min-links 4	Configuring port channel minimum links as 4 (range is 2-32)
(config-if)#commit	Commit the candidate configuration to the running Configuration.
(config-if)#exit	Exit the configure mode

Validation

SW2

```
#show running-config interface po10
!
interface po10
  switchport
  bridge-group 1
  switchport mode trunk
  switchport trunk allowed vlan all
  port-channel min-links 4
!

#show etherchannel

% Aggregator Type: Layer2
% LACP Aggregator: po10
% Min-links: 4
% Member:
  xe50/1
```

```
xe50/2
xe50/3
xe50/4
```

```
#show etherchannel summary
```

```
% Aggregator po10 100010
% Aggregator Type: Layer2
% Admin Key: 0010 - Oper Key 0010
% Link: xe50/4 (10072) sync: 1
% Link: xe50/1 (10069) sync: 1
% Link: xe50/2 (10070) sync: 1
% Link: xe50/3 (10071) sync: 1
```

Note: When a PO goes down due to the minimum links configured (number of minimum links is greater than the links aggregated to the PO).

```
SW1:
```

```
#sh int brief po10
```

```
Codes: ETH - Ethernet, LB - Loopback, AGG - Aggregate, MLAG - MLAG Aggregate
FR - Frame Relay, TUN -Tunnel, PBB - PBB Logical Port, VP - Virtual
```

```
Port
```

```
Unknown CVP - Channelised Virtual Port, METH - Management Ethernet, UNK-
```

```
ED - ErrDisabled, PD - Protocol Down, AD - Admin Down,
```

```
IA - InActive
```

```
PD(Min L/B) - Protocol Down Min-Links/Bandwidth
```

```
DV - DDM Violation, NA - Not Applicable
```

```
NOM - No operational members, PVID - Port Vlan-id
```

```
Ctl - Control Port (Br-Breakout/Bu-Bundle)
```

```
HD - ESI Hold Timer Down
```

```
-----
--
Port-channel Type PVID Mode Status Reason Speed
Interface
-----
--
po10 AGG 1 trunk down PD(Min L/B) 0
#
```

```
#sh etherchannel
```

```
% LACP Aggregator: po10
```

```
% Min-links: 4
```

```
% Protocol Down (Min L/B): True
```

```
% Member:
```

```
xe4/1
```

```
xe4/2
```

```
xe4/3
```

```
xe4/4
```

```
SW2:
```

```
#sh etherchannel
% LACP Aggregator: po10
% Min-links: 4
% Protocol Down (Min L/B): True
% Member:
  Xe50/1
  Xe50/2
  Xe50/3
  xe50/4

#sh int brief po100

Codes: ETH - Ethernet, LB - Loopback, AGG - Aggregate, MLAG - MLAG Aggregate
Port   FR - Frame Relay, TUN -Tunnel, PBB - PBB Logical Port, VP - Virtual
Unknown CVP - Channelised Virtual Port, METH - Management Ethernet, UNK-
Unknown ED - ErrDisabled, PD - Protocol Down, AD - Admin Down,
IA - InActive
PD(Min L/B) - Protocol Down Min-Links/Bandwidth
DV - DDM Violation, NA - Not Applicable
NOM - No operational members, PVID - Port Vlan-id
Ctl - Control Port (Br-Breakout/Bu-Bundle)
HD - ESI Hold Timer Down

-----
--
Port-channel  Type  PVID  Mode                Status  Reason  Speed
Interface
-----
--
po10          AGG   1     trunk                down    PD(Min L/B)  0
#
```

Dynamic LAG Minimum Bandwidth Configuration

Configure the minimum bandwidth allowed for ports that must be linked up and bundled in the LACP port channel. We can configure the minimum bandwidth range from `BANDWIDTH <1-999>k|m` for 1 to 999 kilo bits or mega bits `<1-1000>g` for 1 to 1000 giga bits. If the Total bandwidth of ports aggregated to the port channel is less than the minimum Bandwidth value configured, then the port channel enters the Protocol Down because of the minimum Bandwidth state.

Note: Minimum Bandwidth should be configured the same on both sides for optimal performance.

Topology

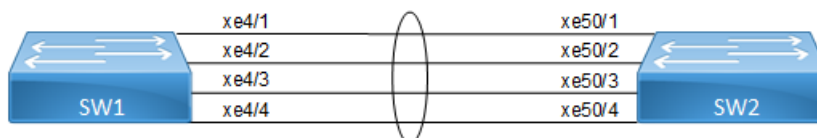

Figure 12-24: LAG minimum bandwidth

SW1

#configure terminal	Enter configure mode.
(config)#interface po10	Creating interface port-channel po10
(config-if)#port-channel min-bandwidth 40g	Configuring port channel minimum bandwidth as 40g (range from BANDWIDTH <1-999>k m for 1 to 999 kilo bits or mega bits <1-1000>g for 1 to 1000 giga bits.)
(config-if)#commit	Commit the candidate configuration to the running Configuration.
(config-if)#exit	Exit the configure mode

Validation**SW1**

```
#sh running-config interface po10

interface po10
  switchport
  bridge-group 1
  switchport mode trunk
  switchport trunk allowed vlan all
port-channel min-bandwidth 40g
!
!

#show etherchannel
-----
% LACP Aggregator: po10
% Min-Bandwidth : 40g
% Member:
  xe4/1
  xe4/2
  xe4/3
  xe4/4
-----

#show etherchannel summary

% Aggregator po10 100010
% Aggregator Type: Layer3
% Admin Key: 0010 - Oper Key 0010
%   Link: xe4/4 (10072) sync: 1
%   Link: xe4/1 (10069) sync: 1
%   Link: xe4/2 (10070) sync: 1
%   Link: xe4/3 (10071) sync: 1
-----
```

SW2

#configure terminal	Enter configure mode.
(config)#interface po10	Creating interface port-channel po10
(config-if)#port-channel min-bandwidth 40g	Configuring port channel minimum bandwidth as 40g (range from BANDWIDTH <1-999>k m for 1 to 999 kilo bits or mega bits <1-1000>g for 1 to 1000 giga bits.)
(config-if)#commit	Commit the candidate configuration to the running Configuration.
(config-if)#exit	Exit the configure mode

Validation**SW2**

```
#show running-config interface po10
!
interface po10
  switchport
  bridge-group 1
  switchport mode trunk
  switchport trunk allowed vlan all
  port-channel min-bandwidth 40g
!
```

```
#show etherchannel
```

```
% LACP Aggregator: po10
% Min-Bandwidth : 40g
% Member:
  xe50/1
  xe50/2
  xe50/3
  xe50/4
```

```
#show etherchannel summary
```

```
% Aggregator po10 100010
% Aggregator Type: Layer2
% Admin Key: 0010 - Oper Key 0010
% Link: xe50/4 (10072) sync: 1
% Link: xe50/1 (10069) sync: 1
% Link: xe50/2 (10070) sync: 1
% Link: xe50/3 (10071) sync: 1
```

Note: When a PO goes down due to the [Total bandwidth] < [minimum bandwidth configured]

```
SW1:
```

```
=====
```

```
#sh int brief po10
```

```
Codes: ETH - Ethernet, LB - Loopback, AGG - Aggregate, MLAG - MLAG Aggregate
```

Port FR - Frame Relay, TUN -Tunnel, PBB - PBB Logical Port, VP - Virtual
 Unknown CVP - Channelised Virtual Port, METH - Management Ethernet, UNK-
 ED - ErrDisabled, PD - Protocol Down, AD - Admin Down,
 IA - InActive
 PD(Min L/B) - Protocol Down Min-Links/Bandwidth
 DV - DDM Violation, NA - Not Applicable
 NOM - No operational members, PVID - Port Vlan-id
 Ctl - Control Port (Br-Breakout/Bu-Bundle)
 HD - ESI Hold Timer Down

```
-----
--
Port-channel Type PVID Mode Status Reason Speed
Interface
-----
--
po10 AGG 1 trunk down PD(Min L/B) 0
#
```

```
#sh etherchannel
% LACP Aggregator: po10
% Min-Bandwidth : 40g
% Protocol Down (Min L/B): True
% Member:
  xe4/1
  xe4/2
  xe4/3
  xe4/4
```

```
SW2:
=====
#sh etherchannel
% LACP Aggregator: po10
% Min-Bandwidth : 40g
% Protocol Down (Min L/B): True
% Member:
  Xe50/1
  Xe50/2
  Xe50/3
  xe50/4
```

```
#sh int brief po10
```

Codes: ETH - Ethernet, LB - Loopback, AGG - Aggregate, MLAG - MLAG Aggregate
 Port FR - Frame Relay, TUN -Tunnel, PBB - PBB Logical Port, VP - Virtual
 Unknown CVP - Channelised Virtual Port, METH - Management Ethernet, UNK-
 ED - ErrDisabled, PD - Protocol Down, AD - Admin Down,
 IA - InActive
 PD(Min L/B) - Protocol Down Min-Links/Bandwidth
 DV - DDM Violation, NA - Not Applicable
 NOM - No operational members, PVID - Port Vlan-id

Ctl - Control Port (Br-Breakout/Bu-Bundle)
 HD - ESI Hold Timer Down

```

-----
--
Port-channel  Type  PVID  Mode                Status  Reason  Speed
Interface
-----
--
po10          AGG   1     trunk              down   PD (Min L/B)  0
#

```

LACP Minimum-Link, Minimum-Bandwidth on Dynamic and Static Channel-Groups with MLAG

Overview

OcNOS allows the configuration of minimum number of the LAG members per LAG group. Both these configurations are meaningful in case the LAG is used for incremental-BW mode. The minimum configuration controls the minimum number of members /bandwidth that must be operationally up / bandwidth available to declare their LAG as operationally UP.

When static/dynamic LAG interface configured with minimum links / minimum bandwidth, the following conditions are to be met:

- Ports which are admin and operational up are considered for min-link.
- The specified minimum number of links should be up.
- Min-link and min-bandwidth cannot co-exist.
- When ports are down due to min-link/min-bandwidth, in show interface brief command output, port down with the corresponding reason code for the failure due to min-link/min-bandwidth.

Minimum Active Members/Bandwidth

The user can specify the minimum number of members that must be operationally up to declare their LAG as operationally UP. Note that this parameter applies to static/dynamic LAG.

```
port-channel min-links <2 - 32>
```

The minimum active member configuration will be allowed to be modified to be greater than the current number of active members. In such configuration, the LAG operational status will become operationally down.

The user can specify the minimum bandwidth, based on the configured value and the ports that satisfy the conditions LAG will be operationally UP. This parameter is applied for static/dynamic LAG.

```
port-channel min-bandwidth BANDWIDTH
```

BANDWIDTH <1-999>k|m for 1 to 999 kilo bits or mega bits <1-1000>g for 1 to 1000 giga bits.

When condition fails, the operational state changes to DOWN.

Note: Do not configure minimum-link, Minimum Bandwidth both on TORs and Switches at the same time to avoid flaps of MLAG.

Topology

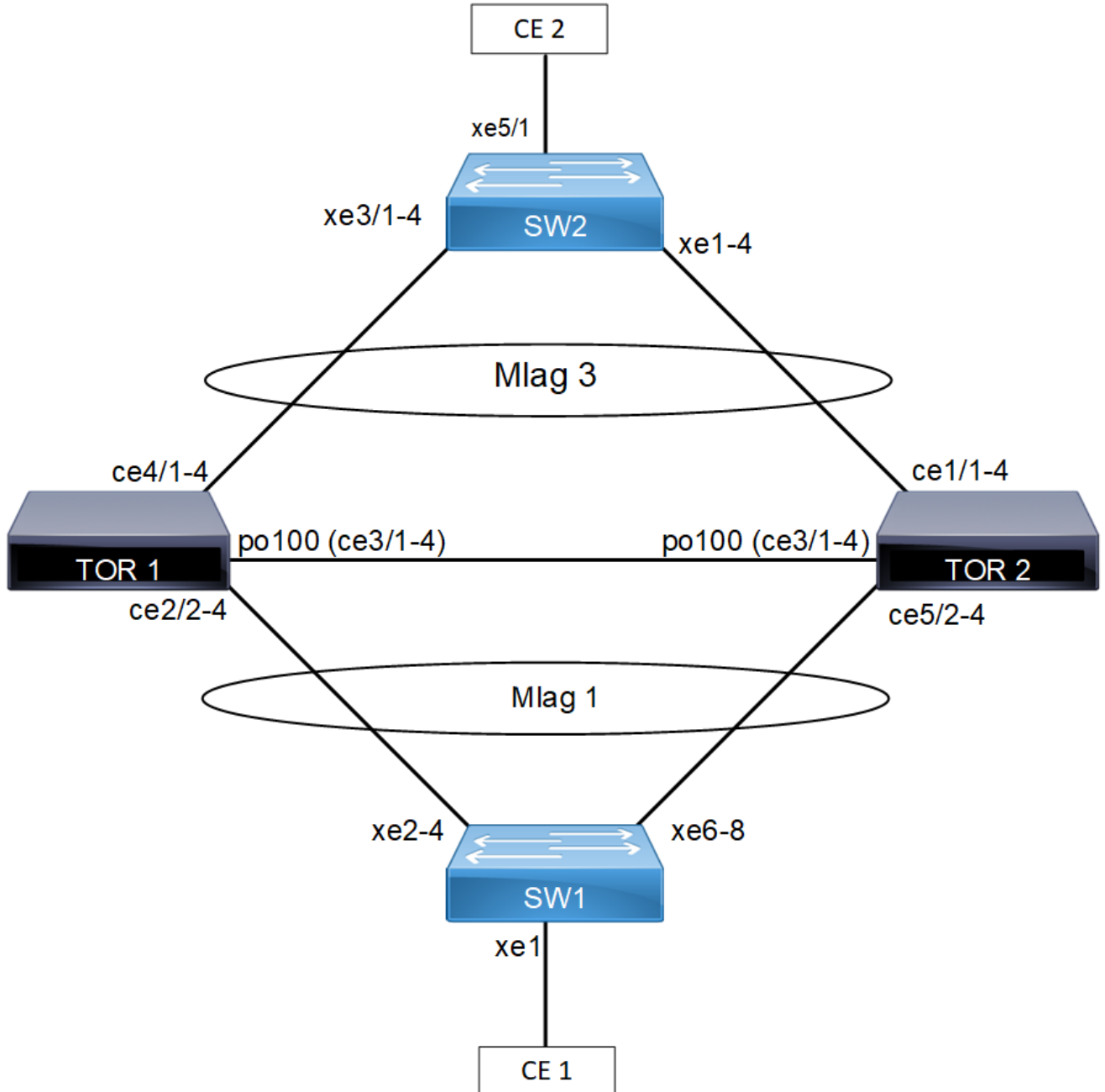

Figure 12-25: MLAG topology

Configuration

TOR1

#configure terminal	Enter configure mode.
(config)# bridge 1 protocol rstp vlan-bridge	Configure bridge type

(config)# vlan database	Enter vlan database
(config-vlan)# vlan 600,601,502 bridge 1 state enable	Configure vlans
(config-vlan)#commit	Commit the candidate configuration to the running Configuration.
(config-vlan)#exit	Exit the configure mode.
(config)#interface mlag1	Enter Interface mode
(config-if)# switchport	Make mlag as layer2 port
(config-if)# bridge-group 1	Attach interface to bridge
(config-if)# switchport mode trunk	Configure trunk port
(config-if)# switchport trunk allowed vlan add 600,601,502	Add interface to vlans
(config-if)# spanning-tree edgeport	Configure port as edge port to avoid loops
(config-if)# spanning-tree bpdu-filter enable	Enable bpdu filter to avoid loops
(config-if)# mtu 9216	Configure mtu.
(config-if)#commit	Commit the candidate configuration to the running Configuration.
(config-if)#exit	Exit the configure mode.
(config)#interface mlag3	Enter Interface mode
(config-if)# switchport	Make mlag as layer2 port
(config-if)# bridge-group 1	Attach interface to bridge
(config-if)# switchport mode trunk	Configure trunk port
(config-if)# switchport trunk allowed vlan add 600,502	Add interface to vlans
(config-if)# spanning-tree edgeport	Configure port as edge port to avoid loops
(config-if)# spanning-tree bpdu-filter enable	Enable bpdu filter to avoid loops
(config-if)# mtu 9216	Configure mtu.
(config-if)#commit	Commit the candidate configuration to the running Configuration.
(config-if)#exit	Exit the configure mode.
(config)#interface po100	Enter Interface mode
(config-if)# switchport	Make po as layer2 port
(config-if)#commit	Commit the candidate configuration to the running Configuration.
(config-if)#exit	Exit the configure mode.
(config)#interface sa1	Enter Interface mode
(config-if)# switchport	Make sa1 as layer2 port
(config-if)#commit	Commit the candidate configuration to the running Configuration.
(config-if)#exit	Exit the configure mode.
(config)# interface sa3	Enter interface mode.
(config-if)# switchport	Make sa3 as layer2 port.
(config-if)#commit	Commit the candidate configuration to the running Configuration.

(config-if)#exit	Exit the configure mode.
(config)#interface ce2/1	Enter Interface mode
(config-if)#port breakout enable	Port breakout enabled
(config-if)#commit	Commit the candidate configuration to the running Configuration.
(config-if)#exit	Exit the configure mode.
(config)#interface ce2/2	Enter Interface mode
(config-if)# static-channel-group 1	Add interface to sa1
(config-if)#commit	Commit the candidate configuration to the running Configuration.
(config-if)#exit	Exit the configure mode.
(config)#interface ce2/3	Enter Interface mode
(config-if)# static-channel-group 1	Add interface to sa1
(config-if)#commit	Commit the candidate configuration to the running Configuration.
(config-if)#exit	Exit the configure mode.
(config)#interface ce2/4	Enter Interface mode
(config-if)# static-channel-group 1	Add interface to sa1
(config-if)#commit	Commit the candidate configuration to the running Configuration.
(config-if)#exit	Exit the configure mode.
(config)#interface ce3/1	Enter Interface mode
(config-if)#port breakout enable	Port breakout enabled
(config-if)# channel-group 100 mode active	Add interface to po100
(config-if)#commit	Commit the candidate configuration to the running Configuration.
(config-if)#exit	Exit the configure mode.
(config)#interface ce3/2	Enter Interface mode
(config-if)# channel-group 100 mode active	Add interface to po100
(config-if)#commit	Commit the candidate configuration to the running Configuration.
(config-if)#exit	Exit the configure mode.
(config)#interface ce3/3	Enter Interface mode
(config-if)# channel-group 100 mode active	Add interface to po100
(config-if)#commit	Commit the candidate configuration to the running Configuration.
(config-if)#exit	Exit the configure mode.
(config)#interface ce3/4	Enter Interface mode
(config-if)# channel-group 100 mode active	Add interface to po100
(config-if)#commit	Commit the candidate configuration to the running Configuration.
(config-if)#exit	Exit the configure mode.
(config)#interface ce4/1	Enter Interface mode
(config-if)#port breakout enable	Port breakout enabled

(config-if)# static-channel-group 3	Add interface to sa3
(config-if)#commit	Commit the candidate configuration to the running Configuration.
(config-if)#exit	Exit the configure mode.
(config)#interface ce4/2	Enter Interface mode
(config-if)# static-channel-group 3	Add interface to sa3
(config-if)#commit	Commit the candidate configuration to the running Configuration.
(config-if)#exit	Exit the configure mode.
(config)#interface ce4/3	Enter Interface mode
(config-if)# static-channel-group 3	Add interface to sa3
(config-if)#commit	Commit the candidate configuration to the running Configuration.
(config-if)#exit	Exit the configure mode.
(config)#mcec domain configuration	Enter Multichasis Etherchannel domain configuration mode.
(config-mcec-domain)# domain-address 1111.2222.3333	Configure the domain address.
(config-mcec-domain)# domain-system-number 1	Configure the domain system number
(config-mcec-domain)# intra-domain-link po100	Specify the intra domain link for MLAG communication
(config-mcec-domain)#commit	Commit the candidate configuration to the running Configuration.
(config-mcec-domain)#exit	Exit the configure mode.
(config)#interface sa1	Enter Interface mode
(config-if)#mlag 1	Map sa1 to mlag1
(config-if)#commit	Commit the candidate configuration to the running Configuration.
(config-if)#exit	Exit the configure mode.
(config)#int mlag1	Enter Interface mode
(config-if)#mode active-standby	Configure mlag mode for mlag1
(config-if)#switchover type revertive 10	Configure revertive timer
(config-if)#commit	Commit the candidate configuration to the running Configuration.
(config-if)#exit	Exit the configure mode.
(config)#interface sa3	Enter Interface mode
(config-if)#mlag 3	Map sa3 to mlag3
(config-if)#commit	Commit the candidate configuration to the running Configuration.
(config-if)#exit	Exit the configure mode.
(config)#int mlag3	Enter Interface mode
(config-if)#mode active-standby	Configure mlag mode for mlag3
(config-if)#switchover type revertive 10	Configure revertive timer
(config-if)#commit	Commit the candidate configuration to the running Configuration.
(config-if)#exit	Exit the configure mode.

(config-if)# interface sa1	Enter sa interface mode
(config-if)#port-channel min-links 3	Configure min-link value on sa interface
(config-if)#commit	Commit the candidate configuration to the running Configuration.
(config-if)#exit	Exit the configure mode.
(config)#interface sa3	Enter sa Interface mode
(config-if)#port-channel min-bandwidth 30g	Configure min-bandwidth value on sa/po interface
(config-if)#commit	Commit the candidate configuration to the running Configuration.
(config-if)#exit	Exit the configure mode.

TOR2

#configure terminal	Enter configure mode.
(config)# bridge 1 protocol rstp vlan-bridge	Configure bridge type
(config)# vlan database	Enter vlan database
(config-vlan)# vlan 600,601,502 bridge 1 state enable	Configure vlans
(config-vlan)#commit	Commit the candidate configuration to the running Configuration.
(config-vlan)#exit	Exit the configure mode.
(config)#interface mlag1	Enter Interface mode
(config-if)# switchport	Make mlag as layer2 port
(config-if)# bridge-group 1	Attach interface to bridge
(config-if)# switchport mode trunk	Configure trunk port
(config-if)# switchport trunk allowed vlan add 600,601,502	Add interface to vlans
(config-if)# spanning-tree edgeport	Configure port as edge port to avoid loops
(config-if)# spanning-tree bpdu-filter enable	Enable bpdu filter to avoid loops
(config-if)# mtu 9216	Configure mtu.
(config-if)#commit	Commit the candidate configuration to the running Configuration.
(config-if)#exit	Exit the configure mode.
(config)#interface mlag3	Enter Interface mode
(config-if)# switchport	Make mlag as layer2 port
(config-if)# bridge-group 1	Attach interface to bridge
(config-if)# switchport mode trunk	Configure trunk port
(config-if)# switchport trunk allowed vlan add 600,502	Add interface to vlans
(config-if)# spanning-tree edgeport	Configure port as edge port to avoid loops
(config-if)# spanning-tree bpdu-filter enable	Enable bpdu filter to avoid loops
(config-if)# mtu 9216	Configure mtu.
(config-if)#commit	Commit the candidate configuration to the running Configuration.

(config-if)#exit	Exit the configure mode.
(config)#interface po100	Enter Interface mode
(config-if)# switchport	Make po(IDL) as layer2 port
(config-if)#commit	Commit the candidate configuration to the running Configuration.
(config-if)#exit	Exit the configure mode.
(config)#interface sa1	Enter Interface mode
(config-if)# switchport	Make sa1 as layer2 port
(config-if)#commit	Commit the candidate configuration to the running Configuration.
(config-if)#exit	Exit the configure mode.
(config)#interface sa3	Enter Interface mode
(config-if)# switchport	Make sa3 as layer2 port
(config-if)#commit	Commit the candidate configuration to the running Configuration.
(config-if)#exit	Exit the configure mode.
(config)#interface cel/1	Enter Interface mode
(config-if)# static-channel-group 3	Add interface to sa3
(config-if)#commit	Commit the candidate configuration to the running Configuration.
(config-if)#exit	Exit the configure mode.
(config)#interface cel/2	Enter Interface mode
(config-if)# static-channel-group 3	Add interface to sa3
(config-if)#commit	Commit the candidate configuration to the running Configuration.
(config-if)#exit	Exit the configure mode.
(config)#interface cel/3	Enter Interface mode
(config-if)# static-channel-group 3	Add interface to sa3
(config-if)#commit	Commit the candidate configuration to the running Configuration.
(config-if)#exit	Exit the configure mode.
(config)#interface ce3/1	Enter Interface mode
(config-if)# channel-group 100 mode active	Add interface to po100
(config-if)#commit	Commit the candidate configuration to the running Configuration.
(config-if)#exit	Exit the configure mode.
(config)#interface ce3/2	Enter Interface mode
(config-if)# channel-group 100 mode active	Add interface to po100
(config-if)#commit	Commit the candidate configuration to the running Configuration.
(config-if)#exit	Exit the configure mode.
(config)#interface ce3/3	Enter Interface mode
(config-if)# channel-group 100 mode active	Add interface to po100

(config-if)#commit	Commit the candidate configuration to the running Configuration.
(config-if)#exit	Exit the configure mode.
(config)#interface ce3/4	Enter Interface mode
(config-if)# channel-group 100 mode active	Add interface to po100
(config-if)#commit	Commit the candidate configuration to the running Configuration.
(config-if)#exit	Exit the configure mode.
(config)#interface ce5/1	Enter Interface mode
(config-if)# port breakout enable	Port breakout enabled
(config-if)#commit	Commit the candidate configuration to the running Configuration.
(config-if)#exit	Exit the configure mode.
(config)#interface ce5/2	Enter Interface mode
(config-if)# static-channel-group 1	Add interface to sa1
(config-if)#commit	Commit the candidate configuration to the running Configuration.
(config-if)#exit	Exit the configure mode.
(config)#interface ce5/3	Enter Interface mode
(config-if)# static-channel-group 1	Add interface to sa1
(config-if)#commit	Commit the candidate configuration to the running Configuration.
(config-if)#exit	Exit the configure mode.
(config)#interface ce5/4	Enter Interface mode
(config-if)# static-channel-group 1	Add interface to sa1
(config-if)#commit	Commit the candidate configuration to the running Configuration.
(config-if)#exit	Exit the configure mode.
(config-mcec-domain)# intra-domain-link po100	Specify the intra domain link for MLAG communication
(config-mcec-domain)#commit	Commit the candidate configuration to the running Configuration.
(config-mcec-domain)#exit	Exit the configure mode.
(config)#interface sa1	Enter Interface mode
(config-if)#mlag 1	Map sa1 to mlag1
(config-if)#commit	Commit the candidate configuration to the running Configuration.
(config-if)#exit	Exit the configure mode.
(config)#int mlag1	Enter Interface mode
(config-if)#mode active-standby	Configure mlag mode for mlag1
(config-if)#switchover type revertive 10	Configure revertive timer
(config-if)#commit	Commit the candidate configuration to the running Configuration.
(config-if)#exit	Exit the configure mode.
(config)#interface sa3	Enter Interface mode

(config-if)#mlag 3	Map sa3 to mlag3
(config-if)#commit	Commit the candidate configuration to the running Configuration.
(config-if)#exit	Exit the configure mode.
(config)#int mlag3	Enter Interface mode
(config-if)#mode active-standby	Configure mlag mode for mlag3
(config-if)#switchover type revertive 10	Configure revertive timer
(config-if)#commit	Commit the candidate configuration to the running Configuration.
(config-if)#exit	Exit the configure mode.
(config-if)# interface sa1	Enter sa interface mode
(config-if)#port-channel min-links 3	Configure min-link value on sa interface
(config)#interface sa3	Enter sa Interface mode
(config-if)#port-channel min-bandwidth 30g	Configure min-bandwidth value on sa interface.
(config-if)#commit	Commit the candidate configuration to the running Configuration.
(config-if)#exit	Exit the configure mode.

SW1

configure terminal	Enter Configure mode.
(config)#bridge 1 protocol rstp vlan-bridge	Configure bridge type
(config)#vlan database	Create vlan database
(config-vlan)#vlan 600,601,502,101,100,300,401,402 bridge 1 state enable	Create Vlans
(config-vlan)#commit	Commit the candidate configuration to the running Configuration.
(config-vlan)#exit	Exit the configure mode.
(config)#interface xe1	Enter Interface mode
(config-if)# switchport	Make xe1 as layer2 port
(config-if)# bridge-group 1	Associate the interface with bridge group 1.
(config-if)# switchport mode trunk	Set the switching characteristics of this interface to trunk mode.
(config-if)# switchport trunk allowed vlan all	Enable all VLAN identifiers on this interface.
(config-if)#spanning-tree edgeport	Configure port as edgeport
(config-if)#spanning-tree bpdu-filter enable	Enable spanning tree bpdu filter
(config-if)# mtu 9216	Configure mtu
(config-if)#commit	Commit the candidate configuration to the running Configuration.
(config-if)#exit	Exit the configure mode.
(config)#interface sa1	Enter Interface mode
(config-if)# switchport	Make xe1 as layer2 port
(config-if)# bridge-group 1	Associate the interface with bridge group 1.

(config-if)# switchport mode trunk	Set the switching characteristics of this interface to trunk mode.
(config-if)# switchport trunk allowed vlan add 100,101,300,401,402,502	Enable all VLAN identifiers on this interface.
(config-if)#spanning-tree edgeport	Configure port as edgeport
(config-if)#spanning-tree bpdu-filter enable	Enable spanning tree bpdu filter
(config-if)# mtu 9216	Configure mtu
(config-if)#commit	Commit the candidate configuration to the running Configuration.
(config-if)#exit	Exit the configure mode.
(config)#interface xe2	Enter Interface mode
(config-if)# static-channel-group 1	Add interface to sa1
(config-if)#commit	Commit the candidate configuration to the running Configuration.
(config-if)#exit	Exit the configure mode.
(config)#interface xe3	Enter Interface mode
(config-if)# static-channel-group 1	Add interface to sa1
(config-if)#commit	Commit the candidate configuration to the running Configuration.
(config-if)#exit	Exit the configure mode.
(config)#interface xe4	Enter Interface mode
(config-if)# static-channel-group 1	Add interface to sa1
(config-if)#commit	Commit the candidate configuration to the running Configuration.
(config-if)#exit	Exit the configure mode.
(config)#interface xe6	Enter Interface mode
(config-if)# static-channel-group 1	Add interface to sa3
(config-if)#commit	Commit the candidate configuration to the running Configuration.
(config-if)#exit	Exit the configure mode.
(config)#interface xe7	Enter Interface mode
(config-if)# static-channel-group 1	Add interface to sa3
(config-if)#commit	Commit the candidate configuration to the running Configuration.
(config-if)#exit	Exit the configure mode.
(config)#interface xe8	Enter Interface mode
(config-if)# static-channel-group 1	Add interface to sa3
(config-if)#commit	Commit the candidate configuration to the running Configuration.
(config-if)#exit	Exit the configure mode.

SW2

configure terminal	Enter Configure mode.
(config)#bridge 1 protocol rstp vlan-bridge	Configure bridge type

(config)#vlan database	Create vlan database
(config-vlan)#vlan 600,601,502,101,100,401,402 bridge 1 state enable	Create vlans
(config-vlan)#commit	Commit the candidate configuration to the running Configuration.
(config-vlan)#exit	Exit the configure mode.
(config)#interface xe5/1	Enter Interface mode
(config-if)# switchport	Make xe1 as layer2 port
(config-if)# bridge-group 1	Associate the interface with bridge group 1.
(config-if)# switchport mode trunk	Set the switching characteristics of this interface to trunk mode.
(config-if)# switchport trunk allowed vlan all	Enable all VLAN identifiers on this interface.
(config-if)#spanning-tree edgeport	Configure port as edge port
(config-if)#spanning-tree bpdu-filter enable	Enable spanning tree bpdu filter
(config-if)# mtu 9216	Configure mtu
(config-if)#commit	Commit the candidate configuration to the running Configuration.
(config-if)#exit	Exit the configure mode.
(config)#interface sa3	Enter Interface mode
(config-if)# switchport	Make sa3 as layer2 port
(config-if)# bridge-group 1	Associate the interface with bridge group 1.
(config-if)# switchport mode trunk	Set the switching characteristics of this interface to trunk mode.
(config-if)# switchport trunk allowed vlan add 100,101,401,402,600,502	Enable all VLAN identifiers on this interface.
(config-if)#spanning-tree edgeport	Configure port as edge port
(config-if)#spanning-tree bpdu-filter enable	Enable spanning tree bpdu filter
(config-if)# mtu 9216	Configure mtu
(config-if)#commit	Commit the candidate configuration to the running Configuration.
(config-if)#exit	Exit the configure mode.
(config)#interface xe3/1	Enter Interface mode
(config-if)# static-channel-group 3	Add interface to sa3
(config-if)#commit	Commit the candidate configuration to the running Configuration.
#configure terminal	Enter Configure mode.
(config)#interface xe3/2	Enter Interface mode
(config-if)# static-channel-group 3	Add interface to sa3
(config-if)#commit	Commit the candidate configuration to the running Configuration.
(config-if)#exit	Exit the configure mode.
(config)#interface xe3/3	Enter Interface mode
(config-if)# static-channel-group 3	Add interface to sa3

(config-if)#commit	Commit the candidate configuration to the running Configuration.
(config-if)#exit	Exit the configure mode.
(config)#interface xe1/1	Enter Interface mode
(config-if)# static-channel-group 3	Add interface to sa3
(config-if)#commit	Commit the candidate configuration to the running Configuration.
(config-if)#exit	Exit the configure mode.
(config)#interface xe1/2	Enter Interface mode
(config-if)# static-channel-group 3	Add interface to sa3
(config-if)#commit	Commit the candidate configuration to the running Configuration.
(config-if)#exit	Exit the configure mode.
(config)#interface xe1/3	Enter Interface mode
(config-if)# static-channel-group 3	Add interface to sa3
(config-if)#commit	Commit the candidate configuration to the running Configuration.
(config-if)#exit	Exit the configure mode.

This configuration is applicable for the dynamic LAG with MLAG topology except dynamic LAG interface creations, which needs to be referred from the dynamic LAG configurations given above.

Validation

When sa or po goes down due to min-link or min-bandwidth not satisfied, below validations to be done:

TOR 1

```
#sh int brief sa1
Codes: ETH - Ethernet, LB - Loopback, AGG - Aggregate, MLAG - MLAG Aggregate
      FR - Frame Relay, TUN -Tunnel, PBB - PBB Logical Port, VP - Virtual
Port
      CVP - Channelised Virtual Port, METH - Management Ethernet, UNK-
Unknown
      ED - ErrDisabled, PD - Protocol Down, AD - Admin Down,
      IA - InActive
      PD(Min L/B) - Protocol Down Min-Links/Bandwidth
      DV - DDM Violation, NA - Not Applicable
      NOM - No operational members, PVID - Port Vlan-id
      Ctl - Control Port (Br-Breakout/Bu-Bundle)
      HD - ESI Hold Timer Down
```

```
-----
Port-channel Type  PVID  Mode                Status  Reason  Speed
Interface
-----
--
sa1                AGG    1      trunk          down    PD(Min L/B)  0
```

```
#
#sh int brief po100
```

Codes: ETH - Ethernet, LB - Loopback, AGG - Aggregate, MLAG - MLAG Aggregate
 FR - Frame Relay, TUN -Tunnel, PBB - PBB Logical Port, VP - Virtual
 Port
 CVP - Channelised Virtual Port, METH - Management Ethernet, UNK-
 Unknown
 ED - ErrDisabled, PD - Protocol Down, AD - Admin Down,
 IA - InActive
 PD(Min L/B) - Protocol Down Min-Links/Bandwidth
 DV - DDM Violation, NA - Not Applicable
 NOM - No operational members, PVID - Port Vlan-id
 Ctl - Control Port (Br-Breakout/Bu-Bundle)
 HD - ESI Hold Timer Down

```
-----
--
Port-channel  Type  PVID  Mode                Status  Reason  Speed
Interface
-----
--
po100          AGG   1     trunk                down    PD(Min L/B)  0

#
#sh etherchannel
% LACP Aggregator: po100
% Min-Bandwidth : 40g
% Protocol Down (Min L/B) : True
% Member:
  ce3/1
  ce3/2
  ce3/3
  ce3/4
-----
% LACP Aggregator: sa1
% Min-links : 3
% Protocol Down (Min L/B): True
% Member:
  ce2/2
  ce2/3
  ce2/4
-----
% LACP Aggregator: sa3
% Member:
  ce4/1
  ce4/2
  ce4/3

#
#sh running-config interface sa1
!
interface sa1
  switchport
  port-channel load-balance src-dst-mac
  port-channel min-links 3
  mlag 1
!
```

```

#sh static-channel-group 1
Static Aggregator: sa1
Minimum-Links 3
Member Status
ce2/2          down
ce2/3          down
ce2/4          down
#
#sh etherchannel summary
Aggregator po100 100100
Aggregator Type: Layer2
Admin Key: 0100 - Oper Key 0100
Link: ce3/1 (5057) sync: 0
Link: ce3/2 (5058) sync: 0
Link: ce3/3 (5059) sync: 0
Link: ce3/4 (5060) sync: 0
-----

```

LACP Force-Up

In an aggregated environment, there are some parameters that are set for member ports in lag. Whenever the parameters are set and conditions are satisfied, the port channel will be in SYNC. If force-up mode is enabled for the member port, the port channel will always be in SYNC even if the parameters are not set i.e. the traffic will not be affected and the port channel will never go down.

LACP Force-up with Dynamic LAG

Topology

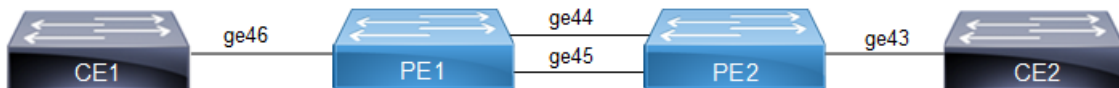

Figure 12-26: LACP force-up with dynamic LAG

CE1

#configure terminal	Enter configure mode.
(config)#hostname CE1	Configure host name
(config)#bridge 1 protocol rstp vlan-bridge	Create a RSTP VLAN bridge on customer side
(config)#vlan database	Enter VLAN database mode.
(config-vlan)#vlan 2-100 bridge 1 state enable	Configure VLAN for the bridge
(config-vlan)#commit	Commit the candidate configuration to the running Configuration.
(config-vlan)#exit	Exit the VLAN configure mode.
(config)#interface ge46	Enter interface mode
(config-if)#switchport	Make interface as Switchport
(config-if)#bridge-group 1	Associate the interface to bridge
(config-if)#switchport mode hybrid	Configure the mode as hybrid

(config-if)#switchport hybrid allowed vlan all	Configure allowed VLAN all on the interface
(config-if)#commit	Commit the candidate configuration to the running Configuration.
(config-if)#exit	Exit the configure mode.
(config)#interface po1	Enter the interface mode
(config-if)#switchport	Make the interface as switch port
(config-if)#bridge-group 1	Associate the interface to bridge
(config-if)#switchport mode hybrid	Configure the mode as hybrid
(config-if)#switchport hybrid allowed vlan all	Configure allowed vlan all for the hybrid mode
(config-if)#commit	Commit the candidate configuration to the running Configuration.
(config-if)#exit	Exit the configure mode.
(config)#interface ge44	Enter interface mode
(config-if)#channel-group 1 mode active	Adding interface to channel-group 1
(config-if)#exit	Exit interface mode.
(config)#interface ge45	Enter interface mode
(config-if)#channel-group 1 mode active	Adding interface to channel-group 1
(config-if)#commit	Commit the candidate configuration to the running Configuration.
(config-if)#exit	Exit the configure mode.

CE2

#configure terminal	Enter configure mode.
(config)#hostname CE2	Configure host name
(config)#bridge 1 protocol provider-rstp edge	Create provider rstp edge bridge
(config)#vlan database	Enter vlan database mode
(config-vlan)#vlan 2-100 type customer bridge 1 state enable	Configure customer VLAN for the bridge
(config-vlan)#vlan 100 type service point-point bridge 1 state enable	Configure service VLAN for the bridge
(config)#exit	Exit vlan database mode
(config)#cvlan registration table map1 bridge 1	Creating registration table
(config-cvlan-registration)#cvlan 2-100 svlan 100	Mapping cvlan to svlan
(config-cvlan-registration)#commit	Commit the candidate configuration to the running Configuration.
(config-cvlan-registration)#exit	Exit the cvlan registration mode.
(config)#interface ge43	Enter interface mode
(config-if)#switchport	Make interface as Switchport
(config-if)#bridge-group 1	Associate the interface to bridge
(config-if)#switchport mode provider-network	Configure the mode as provider-network

(config-if)# switchport provider-network allowed vlan all	Configure allowed VLAN all on the interface
(config-if)#commit	Commit the candidate configuration to the running Configuration.
(config-if)#exit	Exit the configure mode.
(config)#interface po1	Enter the interface mode
(config-if)#switchport	Make the interface as switch port
(config-if)#bridge-group 1	Associate the interface with bridge group 1
(config-if)#switchport mode customer-edge hybrid	Set the switching characteristics of this interface to customer-edge hybrid
(config-if)#switchport customer-edge hybrid allowed vlan all	Set the switching characteristics of this interface to customer-edge hybrid and allow vlan all
(config-if)#switchport customer-edge vlan registration map1	Configuring the registration table mapping on lag interface
(config-if)#commit	Commit the candidate configuration to the running Configuration.
(config-if)#exit	Exit the configure mode.
(config)#interface ge44	Enter interface mode
(config-if)#channel-group 1 mode active	Adding interface to channel-group 1
(config-if)#lacp force-up	Enable lacp force-up for the member port interface
(config-if)#commit	Commit the candidate configuration to the running Configuration.
(config-if)#exit	Exit the configure mode.
(config)#interface ge45	Enter interface mode
(config-if)#channel-group 1 mode active	Adding interface to channel-group 1
(config-if)#commit	Commit the candidate configuration to the running Configuration.
(config-if)#exit	Exit the configure mode.

Send L2 traffic with incremental source mac of 1000 and with VLAN 100 from CE1 and with incremental source mac of 1000 and with SVLAN 100(TPID 0x88a8), CVLAN 100 from CE2.

Validation

CE1

```
CE1#show mac address-table count bridge 1
MAC Entries for all vlans:
Dynamic Address Count: 2001
Static (User-defined) Unicast MAC Address Count: 0
Static (User-defined) Multicast MAC Address Count: 0
Total MAC Addresses in Use: 2001
```

```
CE1#show etherchannel summary
  Aggregator po1 100001
  Aggregator Type: Layer2
  Admin Key: 0001 - Oper Key 0001
    Link: ge44 (5043) sync: 1
```

Link: ge45 (5046) sync: 1

CE1#show interface counters rate mbps

Interface	Rx mbps	Rx pps	Tx mbps	Tx pps
ge44	363.65	710252	772.76	1420506
ge45	363.63	710222	0.00	0
ge46	772.77	1420525	727.31	1420526
po1	728.56	1422971	774.09	1422966

CE2#show mac address-table count bridge 1

MAC Entries for all vlans:

Dynamic Address Count: 2001

Static (User-defined) Unicast MAC Address Count: 0

Static (User-defined) Multicast MAC Address Count: 0

Total MAC Addresses in Use: 2001

CE2#show interface counters rate mbps

Interface	Rx mbps	Rx pps	Tx mbps	Tx pps
ge43	774.26	1423267	784.17	1361411
ge44	774.26	1423268	364.36	711634
ge45	0.00	0	364.36	711634
po1	774.26	1423267	728.71	1423267

CE2#show etherchannel summary

Aggregator po1 100001

Aggregator Type: Layer2

Admin Key: 0001 - Oper Key 0001

Link: ge44 (5020) sync: 1

Link: ge45 (5022) sync: 1

On server side (PE1) to make LAG down you can unconfigure the channel-group 1 configurations and verify force-up is getting enabled in PE2.

To simulate the force-up:

PE1(config)#interface ge44	Enter interface mode.
PE1(config-if)#no channel-group	Removing channel-group configurations from interface.
PE1(config-if)#commit	Commit the candidate configuration to the running Configuration.
PE1(config)#interface ge45	Enter interface mode.
PE1(config-if)#no channel-group	Removing channel-group configurations from interface.
PE1(config-if)#commit	Commit the candidate configuration to the running Configuration.
PE1(config-if)#exit	Exit interface mode.

PE2

```
PE2#show interface brief | include pol
pol          AGG  1      customer-edge  up      none  1g
```

```
PE2#show etherchannel summary
Aggregator pol 100001
Aggregator Type: Layer2
Admin Key: 0001 - Oper Key 0001
  Link: ge44 (5020) sync: 0 (force-up)
  Link: ge45 (5022) sync: 0
```

```
PE2#show etherchannel detail
Aggregator pol 100001
Aggregator Type: Layer2
Mac address: b8:6a:97:4d:65:d5
Admin Key: 0001 - Oper Key 0001
  Actor LAG ID- 0x8000,b8-6a-97-28-a5-c0,0x0001
  Receive link count: 0 - Transmit link count: 0
  Individual: 0 - Ready: 1
  Partner LAG ID- 0x0000,00-00-00-00-00-00,0x0000
  Link: ge44 (5020) sync: 0 (force-up)
  Link: ge45 (5022) sync: 0
Collector max delay: 5
```

To forward traffic from ge44 of PE1:

PE1(config)#interface ge44	Enter interface mode.
PE1(config-if)#switchport	Make the interface as switch port.
PE1(config-if)#bridge-group 1	Associate the interface to bridge.
PE1(config-if)#switchport mode hybrid	Configure the mode as hybrid.
PE1(config-if)#switchport hybrid allowed vlan all	Configure allowed vlan all for the hybrid mode.
PE1(config-if)#commit	Commit the candidate configuration to the running Configuration.
PE1(config-if)#exit	Exit the configure mode.

```
PE2#show interface counters rate mbps
+-----+-----+-----+-----+-----+
| Interface | Rx mbps | Rx pps | Tx mbps | Tx pps |
+-----+-----+-----+-----+-----+
ge43       774.25  1423257  784.17  1361400
ge44       774.25  1423258  728.71  1423257
ge45        0.00    0        0.00    0
pol        774.25  1423247  728.70  1423245
PE2#
```

```
PE1#show interface counters rate mbps
+-----+-----+-----+-----+-----+
| Interface | Rx mbps | Rx pps | Tx mbps | Tx pps |
+-----+-----+-----+-----+-----+
```

ge44	657.67	1284505	640.77	1177884
ge45	0.00	0	0.00	0
ge46	772.71	1420426	603.08	1177886

Port-Channel Weight

Use the `port-channel weight` command to configure weighted load balancing on port-channel member links. As per the weights configured, traffic distribution will be happening across the member interfaces.

Consider if ports xe1 and xe2 associated with the L2 lag, having default load-balance as `src-dst-mac` and by default, best traffic distribution can happen up to 50% on each link (by varying source and destination MACs). After weight configured as 2 on interface xe1, the best traffic distribution can happen as 66.66% and 33.33% on xe1 and xe2 respectively.

Port-Channel Weight with Dynamic LAG

Topology

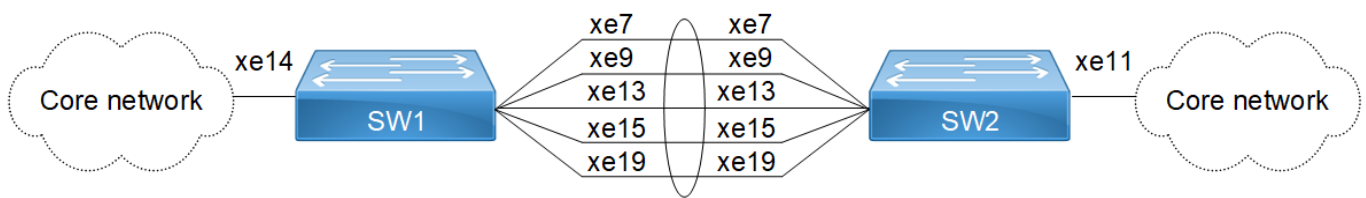

Figure 12-27: Port-Channel weight with dynamic LAG

SW1

<code>#configure terminal</code>	Enter configure mode.
<code>(config)#hostname SW1</code>	Configure host name
<code>(config)#bridge 1 protocol rstp vlan-bridge</code>	Create a RSTP VLAN bridge on customer side
<code>(config-vlan)#vlan database</code>	Enter VLAN database mode.
<code>(config-vlan)#vlan 2-100 bridge 1 state enable</code>	Configure VLAN for the bridge
<code>(config-vlan)#commit</code>	Commit the candidate configuration to the running configuration.
<code>(config-vlan)#exit</code>	Exit the VLAN configure mode.
<code>(config)#interface xe14</code>	Enter interface mode
<code>(config-if)#switchport</code>	Make interface as Switchport
<code>(config-if)#bridge-group 1</code>	Associate the interface to bridge
<code>(config-if)#switchport mode hybrid</code>	Configure the mode as hybrid
<code>(config-if)#switchport hybrid allowed vlan all</code>	Configure allowed VLAN all on the interface
<code>(config-if)#commit</code>	Commit the candidate configuration to the running configuration.
<code>(config-if)#exit</code>	Exit the configure mode.

(config)#interface po1	Enter the interface mode
(config-if)#switchport	Make the interface as switch port
(config-if)#bridge-group 1	Associate the interface to bridge
(config-if)#switchport mode hybrid	Configure the mode as hybrid
(config-if)#switchport hybrid allowed vlan all	Configure allowed vlan all for the hybrid mode
(config-if)#commit	Commit the candidate configuration to the running configuration.
(config-if)#exit	Exit the configure mode.
(config)#interface xe7	Enter interface mode
(config-if)#channel-group 1 mode active	Adding interface to channel-group 1
(config-if)#port-channel weight 10	Configuring port-channel weight
(config-if)#exit	Exit interface mode.
(config)#interface xe9	Enter interface mode
(config-if)#channel-group 1 mode active	Adding interface to channel-group 1
(config-if)#port-channel weight 2	Configuring port-channel weight
(config-if)#exit	Exit interface mode.
(config)#interface xe13	Enter interface mode
(config-if)#channel-group 1 mode active	Adding interface to channel-group 1
(config-if)#port-channel weight 16	Configuring port-channel weight
(config-if)#exit	Exit interface mode.
(config)#interface xe15	Enter interface mode
(config-if)#channel-group 1 mode active	Adding interface to channel-group 1
(config-if)#port-channel weight 5	Configuring port-channel weight
(config-if)#exit	Exit interface mode.
(config)#interface xe19	Enter interface mode
(config-if)#channel-group 1 mode active	Adding interface to channel-group 1
(config-if)#port-channel weight 13	Configuring port-channel weight
(config-if)#commit	Commit the candidate configuration to the running configuration.
(config-if)#exit	Exit the configure mode.

SW2

#configure terminal	Enter configure mode.
(config)#hostname SW2	Configure host name
(config)#bridge 1 protocol rstp vlan-bridge	Create a RSTP VLAN bridge on customer side
(config)#vlan database	Enter the VLAN database mode.
(config-vlan)#vlan 2-100 bridge 1 state enable	Configure VLAN for the bridge
(config-vlan)#commit	Commit the candidate configuration to the running configuration.
(config-vlan)#exit	Exit the VLAN configure mode.

(config)#interface xe11	Enter interface mode
(config-if)#switchport	Make interface as Switchport
(config-if)#bridge-group 1	Associate the interface to bridge
(config-if)#switchport mode hybrid	Configure the mode as hybrid
(config-if)#switchport hybrid allowed vlan all	Configure allowed VLAN all on the interface
(config-if)#commit	Commit the candidate configuration to the running configuration.
(config-if)#exit	Exit the configure mode.
(config)#interface po1	Enter the interface mode
(config-if)#switchport	Make the interface as switch port
(config-if)#bridge-group 1	Associate the interface to bridge
(config-if)#switchport mode hybrid	Configure the mode as hybrid
(config-if)#switchport hybrid allowed vlan all	Configure allowed vlan all for the hybrid mode
(config-if)#commit	Commit the candidate configuration to the running configuration.
(config-if)#exit	Exit the configure mode.
(config)#interface xe7	Enter interface mode
(config-if)#channel-group 1 mode active	Adding interface to channel-group 1
(config-if)#exit	Exit interface mode.
(config)#interface xe9	Enter interface mode
(config-if)#channel-group 1 mode active	Adding interface to channel-group 1
(config-if)#exit	Exit interface mode.
(config)#interface xe13	Enter interface mode
(config-if)#channel-group 1 mode active	Adding interface to channel-group 1
(config-if)#exit	Exit interface mode.
(config)#interface xe15	Enter interface mode
(config-if)#channel-group 1 mode active	Adding interface to channel-group 1
(config-if)#exit	Exit interface mode.
(config)#interface xe19	Enter interface mode
(config-if)#channel-group 1 mode active	Adding interface to channel-group 1
(config-if)#commit	Commit the candidate configuration to the running configuration.
(config-if)#exit	Exit the configure mode.

Validation

As per the weights configured, traffic distribution will be happening across the member interfaces.

```
SW1#show etherchannel summary
  Aggregator po1 100001
  Aggregator Type: Layer2
  Admin Key: 0001 - Oper Key 0001
    Link: xe7 (5008) weight: 10 sync: 1
    Link: xe9 (5010) weight: 2 sync: 1
```

```

Link: xe13 (5014) weight: 16 sync: 1
Link: xe15 (5016) weight: 5 sync: 1
Link: xe19 (5020) weight: 13 sync: 1
SW1#show int counters rate mbps

```

Interface	Rx mbps	Rx pps	Tx mbps	Tx pps
po1	0.00	0	280.03	50005
xe7	0.00	0	61.02	10896
xe8	0.00	0	0.00	0
xe9	0.00	0	12.18	2175
xe10	0.00	0	0.00	0
xe12	0.00	0	0.00	0
xe13	0.00	0	97.23	17361
xe14	280.03	50004	0.00	0
xe15	0.00	0	30.27	5405
xe16	0.00	0	0.00	0
xe18	0.00	0	0.00	0
xe19	0.00	0	79.33	14166

SW1#

Port-Channel Weight with Static LAG

Topology

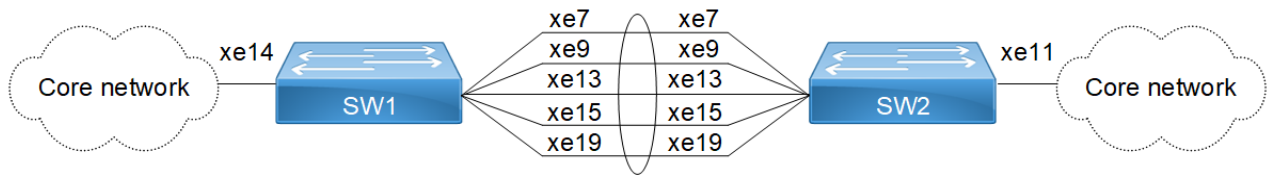

Figure 12-28: Figure 9-78: Port-channel weight with static LAG

SW1

#configure terminal	Enter configure mode.
(config)#hostname SW1	Configure host name
(config)#bridge 1 protocol rstp vlan-bridge	Create a RSTP VLAN bridge on customer side
(config)#vlan database	Enter VLAN database mode.
(config-vlan)#vlan 2-100 bridge 1 state enable	Configure VLAN for the bridge
(config-vlan)#commit	Commit the candidate configuration to the running configuration.
(config-vlan)#exit	Exit the VLAN configure mode.
(config)#interface xe14	Enter interface mode
(config-if)#switchport	Make interface as Switchport
(config-if)#bridge-group 1	Associate the interface to bridge
(config-if)#switchport mode hybrid	Configure the mode as hybrid

(config-if)#switchport hybrid allowed vlan all	Configure allowed VLAN all on the interface
(config-if)#commit	Commit the candidate configuration to the running configuration.
(config-if)#exit	Exit the configure mode.
(config)#interface sa1	Enter the interface mode
(config-if)#switchport	Make the interface as switch port
(config-if)#bridge-group 1	Associate the interface to bridge
(config-if)#switchport mode hybrid	Configure the mode as hybrid
(config-if)#switchport hybrid allowed vlan all	Configure allowed vlan all for the hybrid mode
(config-if)#commit	Commit the candidate configuration to the running configuration.
(config-if)#exit	Exit the configure mode.
(config)#interface xe7	Enter interface mode
(config-if)#static-channel-group 1	Adding interface to static channel-group 1
(config-if)#port-channel weight 16	Configuring port-channel weight
(config-if)#exit	Exit interface mode.
(config)#interface xe9	Enter interface mode
(config-if)#static-channel-group 1	Adding interface to static channel-group 1
(config-if)#port-channel weight 14	Configuring port-channel weight
(config-if)#exit	Exit interface mode.
(config)#interface xe13	Enter interface mode
(config-if)#static-channel-group 1	Adding interface to static channel-group 1
(config-if)#port-channel weight 10	Configuring port-channel weight
(config-if)#exit	Exit interface mode.
(config)#interface xe15	Enter interface mode
(config-if)#static-channel-group 1	Adding interface to static channel-group 1
(config-if)#port-channel weight 8	Configuring port-channel weight
(config-if)#exit	Exit interface mode.
(config)#interface xe19	Enter interface mode
(config-if)#static-channel-group 1	Adding interface to static channel-group 1
(config-if)#port-channel weight 16	Configuring port-channel weight
(config-if)#commit	Commit the candidate configuration to the running configuration.
(config-if)#exit	Exit the configure mode.

SW2

#configure terminal	Enter configure mode.
(config)#hostname SW2	Configure host name
(config)#bridge 1 protocol rstp vlan-bridge	Create a RSTP VLAN bridge on customer side
(config)#vlan database	Enter VLAN database mode.

(config-vlan)#vlan 2-100 bridge 1 state enable	Configure VLAN for the bridge
(config-vlan)#commit	Commit the candidate configuration to the running configuration.
(config-vlan)#exit	Exit the VLAN configure mode.
(config)#interface xe11	Enter interface mode
(config-if)#switchport	Make interface as Switchport
(config-if)#bridge-group 1	Associate the interface to bridge
(config-if)#switchport mode hybrid	Configure the mode as hybrid
(config-if)#switchport hybrid allowed vlan all	Configure allowed VLAN all on the interface
(config-if)#commit	Commit the candidate configuration to the running configuration.
(config-if)#exit	Exit the configure mode.
(config)#interface sa1	Enter the interface mode
(config-if)#switchport	Make the interface as switch port
(config-if)#bridge-group 1	Associate the interface to bridge
(config-if)#switchport mode hybrid	Configure the mode as hybrid
(config-if)#switchport hybrid allowed vlan all	Configure allowed vlan all for the hybrid mode
(config-if)#commit	Commit the candidate configuration to the running configuration.
(config-if)#exit	Exit the configure mode.
(config)#interface xe7	Enter interface mode
(config-if)#static-channel-group 1	Adding interface to static channel-group 1
(config-if)#exit	Exit interface mode.
(config)#interface xe9	Enter interface mode
(config-if)#static-channel-group 1	Adding interface to static channel-group 1
(config-if)#exit	Exit interface mode.
(config)#interface xe13	Enter interface mode
(config-if)#static-channel-group 1	Adding interface to static channel-group 1
(config-if)#exit	Exit interface mode.
(config)#interface xe15	Enter interface mode
(config-if)#static-channel-group 1	Adding interface to static channel-group 1
(config-if)#exit	Exit interface mode.
(config)#interface xe19	Enter interface mode
(config-if)#static-channel-group 1	Adding interface to static channel-group 1
(config-if)#commit	Commit the candidate configuration to the running configuration.
(config-if)#exit	Exit the configure mode.

Validation

As per the weights configured, traffic distribution will be happening across the member interfaces.

SW1

```
SW1#show static-channel-group
```

```
Static Aggregator: sa1
```

```
Member Status weight
```

```
xe7 up 16
```

```
xe9 up 14
```

```
xe13 up 10
```

```
xe15 up 8
```

```
xe19 up 16
```

```
SW1#show int counters rate mbps
```

```
+-----+-----+-----+-----+-----+
| Interface | Rx mbps | Rx pps | Tx mbps | Tx pps |
+-----+-----+-----+-----+-----+
sa1          0.00      0      280.03   50005
xe7          0.00      0      70.01    12501
xe8          0.00      0      0.00     0
xe9          0.00      0      61.27    10941
xe10         0.00      0      0.00     0
xe12         0.00      0      0.00     0
xe13         0.00      0      43.80    7820
xe14        280.03   50004   0.00     0
xe15         0.00      0      34.95    6240
xe16         0.00      0      0.00     0
xe18         0.00      0      0.00     0
xe19         0.00      0      70.01    12501
```

```
SW1#
```

CHAPTER 13 LACP Aggregator Force-up

Overview

Link Aggregation Control Protocol (LACP) facilitates the bundling of multiple physical interfaces into a single logical link, enhancing bandwidth and providing redundancy. Aggregator Force-Up extends LACP functionality by enabling links to be forced into an active state without successful LACP negotiation. This is crucial in environments where connected devices, such as servers during boot stages, might not support LACP or have temporary configuration limitations.

Feature Characteristics

- Allows all interfaces within a Link Aggregation Group (LAG) or MLAG to be manually set to an active state without requiring successful LACP negotiation.
- In force-up state, each physical interface in a LAG or MLAG acts as an independent bridge-port, handling MAC learning and L2 traffic independently rather than as part of the aggregated link.
- LACP agg force-up can be enabled in LAG or MLAG interface not in physical interface.
- Interfaces automatically transition out of force-up state and resume normal LACP-based operations when LACP communication is successfully established on any of the links.

Benefits

- Keeps network traffic flowing even when there's a synchronization issue, preventing data loss and maintaining connectivity.
- Automatically switches the links to independent operation mode without manual intervention, simplifying network management.
- When synchronization is restored on any link, the LAG returns to its efficient, aggregated state.

LACP Aggregator Force-up for Dynamic LAG Configuration

Set up LACP Aggregator Force-Up to maintain network connectivity even when synchronization with the LACP partner is lost all member links in the LAG.

Topology

The provided topology diagram consists of a switch and a server (SW1 and server) connected to each other.

SW1: This the central switch in the topology. They are connected through two interfaces (xe1 and xe2).

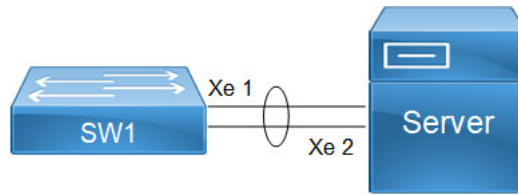

Figure 13-29: LACP Aggregator Force-up for Dynamic LAG

To configure LACP Aggregator Force-up for LAG on switch SW1 and Server, follow the steps:

1. Create VLANs and Bridge:

1. Establish a bridge instance (`bridge 1`) with RSTP as the spanning tree protocol for VLAN-based bridging.
2. Define VLANs 2 to 100 and associate it with (`bridge 1`) to enable the VLANs for bridging operations, and commit the changes.

```
SW1(config)# bridge 1 protocol rstp vlan-bridge
SW1(config)# vlan database
SW1(config-vlan)# vlan 2-100 bridge 1 state enable
SW1(config-vlan)# commit
SW1(config-vlan)# exit
```

2. Configure Port-channel Interface (`po1`) Aggregate Link between SW1 and Server:

1. Enter configuration mode for Port-channel interface 1 (`po1`).
2. Configure (`po1`) as a Layer 2 switchport.
3. Associate (`po1`) with `bridge group 1` so that it operates within the defined bridging context.
4. Set (`po1`) to trunk mode to carry traffic for multiple VLANs.
5. Configure (`po1`) to carry traffic for all VLANs, facilitating communication across different VLANs within the network.
6. Configure channel-group 1 for (`po1`) in active mode for LACP operation:

```
SW1(config)# interface po1
SW1(config-if)# switchport
SW1(config-if)# bridge-group 1
SW1(config-if)# switchport mode trunk
SW1(config-if)# switchport trunk allowed vlan all
SW1(config-if)# commit
SW1(config-if)# exit
```

3. Configure the Interfaces (`xe1` and `xe2`):

1. Enter configuration mode for each interface (`xe1` and `xe2`).
2. Assign (`xe1` and `xe2`) to channel-group 1 to participate in the LACP bundle formed by `po1`, ensuring load balancing and redundancy across member links.

Note: Follow similar steps for SW2, adjusting interface names and configurations accordingly to maintain consistency across the network.

```
SW1(config)# interface xe1
SW1(config-if)# channel-group 1 mode active
SW1(config-if)# exit
```

```

SW1(config)# interface xe2
SW1(config-if)# channel-group 1 mode active
SW1(config-if)# exit

```

4. Enable LACP Aggregator Force-Up on po1.

```

SW1(config)# interface po1
SW1(config-if)# lacp agg force-up
SW1(config-if)# commit
SW1(config-if)# exit

```

LACP Aggregator Force-up for MLAG Configuration

Set up LACP Aggregator Force-Up to maintain network connectivity even when synchronization with the LACP partner is lost on all member links in the MLAG.

Topology

This topology showcases a network setup designed to maximize redundancy, load balancing, and fault tolerance using MLAG and LACP with a Force-Up feature. The network is structured around top-of-rack switches (TOR1 and TOR2).

TOR1 and TOR2 operate as MLAG peers. This setup allows to appear as a single logical switch to connected device (Server).

Traffic can be distributed across the (TOR1 and TOR2), and if one switch fails, the other can handle the load without service interruption. The LACP Aggregator Force-Up feature is enabled to keep port channel member ports operationally up if all member links go down.

This ensures that the remains up, facilitating immediate traffic redirection and avoiding delays associated with LACP negotiation. Both TOR1 and TOR2 connect to server through multiple links, providing path redundancy. If any link or switch fails, the remaining links and switches maintain network connectivity and balance the load, thus avoiding single points of failure.

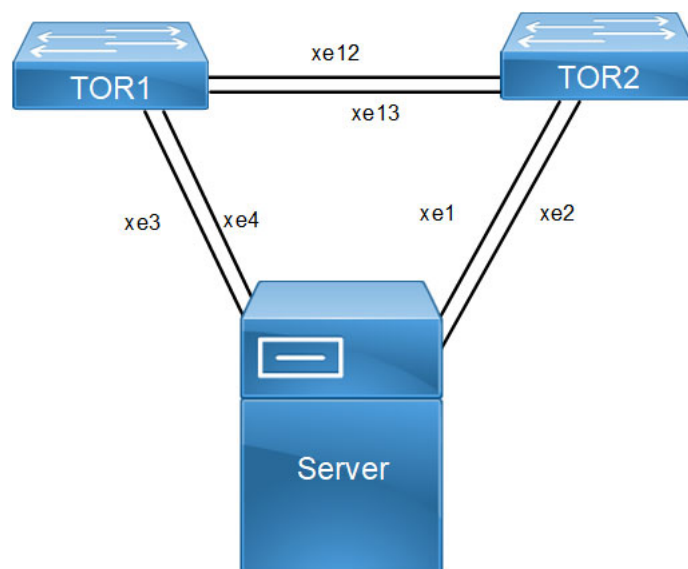

Figure 13-30: LACP Aggregator Force-up for MLAG

To configure LACP Aggregator Force-up for MLAG on switches TOR1, and TOR2, follow the steps:

1. Create VLANs and Bridge on TOR1, and TOR2:

1. Establish a bridge instance (`bridge 1`) with RSTP as the spanning tree protocol for VLAN-based bridging.
2. Define required vlans for example: VLANs 2 to 100 and associate it with (`bridge 1`) to enable the VLANs for bridging operations, and commit the changes.

```
TOR1(config)# bridge 1 protocol rstp vlan-bridge
TOR1(config)# vlan database
TOR1(config-vlan)# vlan 2-100 bridge 1 state enable
TOR1(config-vlan)# commit
TOR1(config-vlan)# exit
```

2. Configure Port Channels (`po`) as trunk ports allowing all VLANs, and commit the changes: For TORs: Configure interface `mlag1, po1, po3` as needed:

1. Enter configuration mode for (`mlag1`).
2. Configure (`mlag1`) as a Layer 2 switchport.
3. Associate (`mlag1`) with bridge group 1 so that it operates within the defined bridging context.
4. Set (`mlag1`) to trunk mode to carry traffic for multiple VLANs.

```
TOR1(config)#interface mlag1
TOR1(config-if)#switchport
TOR1(config-if)#bridge-group 1
TOR1(config-if)#switchport mode trunk
TOR1(config-if)#switchport trunk allowed vlan all
TOR1(config-if)#mode active-active
TOR1(config-if)#commit
TOR1(config-if)#exit
```

5. Configure `po1` and map to `mlag1`.

```
TOR1(config)#interface po1
TOR1(config-if)#switchport
TOR1(config-if)#mlag 1
TOR1(config-if)#commit
```

6. Configure `po3`.

```
TOR1(config)#interface po3
TOR1(config-if)#switchport
TOR1(config-if)#commit
```

3. Configure the Interfaces (For TOR1 `xe3, xe4, xe12, and xe13`, and For TOR2 `xe1, xe2, xe12, and xe13`):

1. Enter configuration mode for each interface.
2. Assign to channel-group 1 to participate in the LACP bundle formed by `po1`, ensuring load balancing and redundancy across member links.
3. Configure as a Layer 2 switchport with trunk mode and allow all VLANs to facilitate communication across different VLANs within the network.

```
TOR1(config)#interface xe3
TOR1(config-if)#channel-group 1 mode active
TOR1(config-if)#exit
TOR1(config)#interface xe4
```

```

TOR1(config-if)#channel-group 1 mode active
TOR1(config-if)#commit
TOR1(config-if)#exit
TOR1(config)#interface xe12
TOR1(config-if)#channel-group 3 mode active
TOR1(config-if)#exit
TOR1(config)#interface xe13
TOR1(config-if)#channel-group 3 mode active
TOR1(config-if)#commit
TOR1(config) Enable LACP Aggregator Force-up on MLAG interfaces in TOR1 and
TOR2:
TOR1(config)#interface mlag1
TOR1(config-if)#lacp agg force-up
TOR1(config-if)#commit
TOR1(config-if)#exit

```

Note: Similarly, follow the steps to configure `mlag1` for TOR2.

Configuration Snapshot

Dynamic LAG:

```

bridge 1 protocol rstp vlan-bridge
vlan database
vlan 2-4000 bridge 1 state enable
!
interface po1
switchport
bridge-group 1
switchport mode trunk
switchport trunk allowed vlan all
load-interval 30
port-channel load-balance rtag7
lacp agg force-up
!
interface xe1
channel-group 1 mode active
!
interface xe2
channel-group 1 mode active
!
exit

```

MLAG:

```

bridge 1 protocol rstp vlan-bridge
vlan database
vlan 2-4000 bridge 1 state enable
!
interface mlag1
switchport
bridge-group 1
switchport mode trunk
switchport trunk allowed vlan all
load-interval 30
lacp agg force-up
!
interface po1

```

```

port-channel load-balance rtag7
switchport
mlag 1
!
interface po3
switchport
port-channel load-balance rtag7
!
interface xe3
channel-group 1 mode active
!
interface xe4
channel-group 1 mode active
!
interface xe12
channel-group 3 mode active
!
interface xe13
channel-group 3 mode active
!
exit
!
mcec domain configuration
domain-address 1111.2222.3333
domain-system-number 1
intra-domain-link po3

```

Dynamic LAG Validation

- Verify agg force-up is enabled in SW1.

```

SW1#show etherchannel summary
Aggregator po1 100001
Port-channel Force-Up Mode : Activated
Aggregator Type: Layer2
Admin Key: 0001 - Oper Key 0001
Link: xe1 (5034) sync: 0 (agg-force-up)
Link: xe2 (5035) sync: 0 (agg-force-up)

```

MLAG Validation

- Verify agg force-up is enabled in TOR1.

```
TOR1#show mlag domain summary
```

```

-----
Domain Configuration
-----

```

```

Domain System Number      : 1
Domain Address             : 1111.2222.3333
Domain Priority            : 32768
Intra Domain Interface    : po3
Domain Adjacency          : UP

```

```

MCEC PDU local version      : 1
MCEC PDU peer version      : 1
Domain Sync via            : Intra-domain-interface
Peer SVI interface MAC Address : 5C.07.58.6F.83.5E

```

```

MLAG Configuration

```

```

MLAG-1

```

```

Mapped Aggregator          : po1
Physical properties Digest : 54 a9 3a 2a 2b 50 65 bb 3c bc 3d bd c2 43 d6 22
Total Bandwidth            : 0
Mlag Sync                  : IN_SYNC
Mode                       : Active-Active
Current Mlag state         : Standby
Aggregator Force-Up Mode  : Activated

```

```

TOR1#show etherchannel summary

```

```

Aggregator po1 100001
Mlag Force-Up Mode : Activated
Aggregator Type: Layer2
Parent Aggregator : Active mlag1
Admin Key: 16385 - Oper Key 16385
  Link: xe3 (5004) sync: 0 (agg-force-up) (Mlag-active-link)
  Link: xe4 (5008) sync: 0 (agg-force-up) (Mlag-active-link)

```

```

Aggregator po3 100003
Aggregator Type: Layer2
Admin Key: 0003 - Oper Key 0003
  Link: xe12 (5011) sync: 1
  Link: xe13 (5015) sync: 1

```

Implementation Examples

Dynamic Port-Channel configuration:

Both interfaces in the dynamic port-channel must support force-up to allow the server to boot using any connected link.

During the server's boot stage, the force-up feature ensures that any one of the connected interfaces can be used to initiate and complete the boot process, while the other interface remains inactive until LACP communication is established.

MLAG Configuration Requirement:

To support network booting, the MLAG domain is configured with LACP force-up. This allows at least one link to become active, ensuring the server can boot over the network.

Typically, all interfaces (xe1, xe2, xe3, xe4) need to be prepared to provide force-up capabilities to handle server booting flexibility.

Traffic Management:

When in force-up state, each interface operates as an individual bridge-port.

CLI Commands

The LACP aggregator force-up feature introduces the `lacp agg force-up` configuration command.

lacp agg force-up

Use this command to configure Aggregator Force-up on Dynamic LAG or Dynamic MLAG interface.

If this command is enabled and LACP Partner sync is not established on any of the member links in Aggregator then, all the member links will enter Aggregator Force-up state in which they will act like individual bridge ports with respect to Layer2 Learning, Flooding, or Forwarding. Once LACP Partner sync is established on atleast one member link, the members will exit Aggregator Force-up and become part of the LAG that is normal LAG functioning is retained.

Use `no lacp agg force-up` parameter of this command to disable the aggregator force-up state.

Command Syntax

```
lacp agg force-up
no lacp agg force-up
```

Parameters

None

Default

Disabled

Command Mode

Interface mode

Applicability

Introduced the `lacp agg force-up` parameter in the OcnOS version 6.5.2.

Example

The following sequence of commands is used to configure the LACP Aggregator Force-Up feature in MLAG:

```
#configure terminal
(config)#interface mlag1
(config-if)#lacp agg force-up
(config-if)#exit
```

The following sequence of commands is used to configure the LACP Aggregator Force-Up feature in Dynamic LAG:

```
#configure terminal
(config)#interface po1
(config-if)#lacp agg force-up
(config-if)#exit
```

Glossary

The following provides definitions for key terms or abbreviations and their meanings used throughout this document:

Key Terms/Acronym	Description
Link Aggregation Control Protocol (LACP)	A protocol provides a way to bundle several physical ports together to form a single logical channel for the purpose of increasing bandwidth and providing redundancy.
Aggregator	A group of physical interfaces that are combined into a single logical interface (known as a port channel or link aggregation group) for load balancing and redundancy.
Aggregator Force-Up	A feature that keeps the members of LACP aggregator (port channel) operationally up, even if all member links are down. This is typically used in scenarios where there is server boot up.
Multi-Chassis Link Aggregation Group (MLAG)	Creation of a single logical link aggregation group across two separate switches, providing redundancy and load balancing across multiple chassis.
Port Channel (Po)	A logical grouping of multiple physical network interfaces, combined to act as a single interface. This allows for increased bandwidth and redundancy.
Active Mode	In LACP, active mode means the device actively initiates LACP negotiations and participates in the formation of LACP port channels.
Passive Mode	In LACP, passive mode means the device only responds to LACP packets but does not initiate the formation of LACP port channels.

CHAPTER 14 MLAG Configuration

Overview

This chapter contains a complete example of Multi-Chassis Link Aggregation (MLAG) configuration.

MLAG expands the concept of link aggregation so that it provides node-level redundancy by allowing two or more nodes to share a common LAG endpoint. It emulates multiple nodes to represent as a single logical node to the remote node running Link aggregation. As a result, even if one of the nodes is down there exists a path to reach the destination through the other nodes.

Note:

- MLAG is only compatible with VPWS.
- MLAG is supported only in Active-Standby mode.
- All MLAG nodes must have the same MAC table size - as specified by each node's switching ASIC forwarding profile limit.
- For multi-ASIC boards, performing measurements (as either sender or reflector) on LAG interfaces requires all LAG members to be located on the same ASIC.

The MLAG primary and secondary physical devices synchronize with each other to create a single logical domain called Multi-Chassis Ether Channel (MCEC) domain. The exchange of information between MLAG primary and secondary devices to maintain this MCEC domain can be done with the use of IDL and IDP.

Intra-Domain-Link (IDL)

This link is used by MLAG primary and secondary devices to synchronize the states between each other via MCEC packets to create the illusion of a single control plane. The MLAG peers use the IDL to exchange control information and coordinate with each other to ensure that data traffic is forwarded properly. The IDL interface is capable of carrying data traffic:

1. If a MLAG interface to which data traffic is destined is operationally down, the data traffic will be sent to MLAG peer device via IDL to avoid any loss.
2. If data traffic received on a MLAG device is destined for a host that is reachable via peer MLAG device only, then, the data traffic is sent over IDL to the peer MLAG device..

Intra-Domain-Peer (IDP)

This is an alternative way to synchronize the states between MLAG primary and secondary devices. In particular, it provides a Layer 3 communication path to carry MCEC packets. No data traffic is carried over the IDP. Hence, data traffic loss is expected, in case of MLAG interface failure.

Following are the possible types of interconnections for the IDP:

1. The `eth0` out-of-band management interface
2. It can be routed in-band over an L3 infrastructure

Options to Configure Intra-Domain

With IDL only

The IDL uses either a single physical or an aggregated ethernet interface. However, if IDL fails, the states between MLAG devices can no longer be synchronized. Configuring the IDL along with backup IDP provides more robustness during network disruptions.

With IDP only

The IDP without IDL can be used in cases where data traffic transmission between the primary and secondary MLAG devices are not needed.

With IDL and IDP

When the IDL fails, the IDP (if configured) can be used as a backup mechanism to synchronize the states between MLAG peer devices. Also, it helps the MLAG switch to determine whether the IDL itself has failed or whether the peer MLAG device is operationally down. When both the IDL and IDP are configured, following are the behavior of the MLAG devices when the link/device fails:

Case-1: IDP Link failure

In this case, no impact on MLAG, therefore, no network downtime.

Case-2: IDL Link Failure

In this case, MCEC domain adjacency comes up via IDP. When the IDL link fails, MLAG Active-Active will be operational as MLAG Active-Standby (Safe Mode) to minimize network disruptions caused by Dual-Active (Split Brain) mode. It is expected that the traffic loss for hosts directly connected to the Standby device as data traffic cannot be carried over in the IDP.

Case-3: MLAG Peer Device Failure

When MLAG peer device reloads, MCEC domain adjacency goes down. The traffic is forwarded through the operational links in the Active MLAG device.

Case-4: Both IDL and IDP Failure

If both IDL and IDP link fails, Dual-Active (Split brain scenario) can be expected. There will be network instability/disruption as both MLAG nodes are operating as Active-Active with MCEC Domain Adjacency down.

Topology

In the below example TOR1 and TOR2 forms a MLAG domain.

As shown in [Figure 14-31](#), TOR1 and TOR2 forms a domain and thus provides the redundancy. Even if TOR1 or TOR2 is down, there exist a redundant path to forward the traffic.

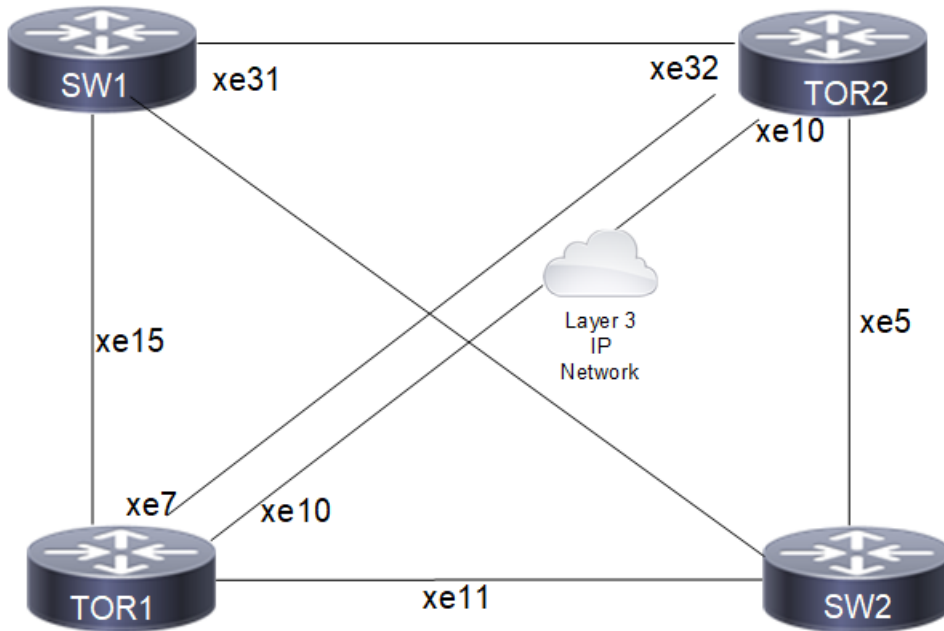

Figure 14-31: MLAG with IDL and IDP Topology

Configuration

Switch 1

SW1#configure terminal	Enter the config terminal.
(config)#hostname SW1	Assign the hostname for the router.
SW1(config)#bridge 1 protocol rstp vlan-bridge	Create bridge.
SW1(config)#vlan database	Enter the VLAN database.
SW1(config-vlan)#vlan 2-1002 bridge 1 state enable	Create the VLANs.
SW1(config-vlan)#exit	Exit the VLAN database.
SW1(config)#int po1	Enter the interface mode.
SW1(config-if)#switchport	Configure the interface as Layer 2.
SW1(config-if)#bridge-group 1	Assign the bridge to the interface.
SW1(config-if)#switchport mode trunk	Configure the interface as trunk mode.
SW1(config-if)#switchport trunk allowed vlan all	Configure the interface to allow all VLAN ids.
SW1(config-if)#exit	Exit the interface mode.
SW1(config)#int xe15	Enter the interface mode.
SW1(config-if)#channel-group 1 mode active	Add the interface as member of LAG interface.
SW1(config-if)#int xe31	Enter the interface mode.
SW1(config-if)#channel-group 1 mode active	Add the interface as member of LAG interface.

SW1 (config-if) #commit	Commit the configure on the node.
SW1 (config-if) #exit	Exit the interface mode.

TOR-1

TOR1#configure terminal	Enter the config terminal.
TOR1 (config) #hostname TOR1	Assign the hostname for the router.
TOR1 (config) #bridge 1 protocol rstp vlan-bridge	Create bridge.
TOR1 (config) #vlan database	Enter the VLAN database.
TOR1 (config-vlan) #vlan 2-1002 bridge 1 state enable	Create the VLANs.
TOR1 (config-vlan) #exit	Exit the VLAN database.
TOR1 (config) #int mlag1	Create the MLAG interface.
TOR1 (config-if) #switchport	Configure the interface as Layer 2.
TOR1 (config-if) #bridge-group 1	Assign the bridge to the interface.
TOR1 (config-if) #switchport mode trunk	Configure the interface as trunk mode.
TOR1 (config-if) #switchport trunk allowed vlan all	Configure the interface to allow all VLAN ids.
TOR1 (config-if) #exit	Exit the interface mode.
TOR1 (config) #int mlag2	Create the MLAG interface.
TOR1 (config-if) #switchport	Configure the interface as Layer 2.
TOR1 (config-if) #bridge-group 1	Assign the bridge to the interface.
TOR1 (config-if) #switchport mode trunk	Configure the interface as trunk mode.
TOR1 (config-if) #switchport trunk allowed vlan all	Configure the interface to allow all VLAN ids.
TOR1 (config-if) #exit	Exit the interface mode.
TOR1 (config) #int po1	Create the port channel interface.
TOR1 (config-if) #switchport	Configure the interface as Layer 2.
TOR1 (config-if) #mlag 1	Bind MLAG to the port channel.
TOR1 (config-if) #exit	Exit the interface mode.
TOR1 (config) #int po2	Create the port channel interface
TOR1 (config-if) #switchport	Configure the interface as Layer 2.
TOR1 (config-if) #mlag 2	Bind MLAG to the port channel.
TOR1 (config-if) #exit	Exit the interface mode.
TOR1 (config) #interface xe7	Configure xe7 interface mode only if the IDL is required.
TOR1 (config-if) #switchport	Configure the interface as Layer 2 only if the IDL is required.
TOR1 (config-if) #exit	Exit the interface mode.
TOR1 (config-if) #interface xe10	Configure xe10 interface mode only if the IDP is required..
TOR1 (config-if) #ip address 2.2.2.2/24	Configure source IP address for IDP only if the IDP is required.
TOR1 (config) #int xe15	Enter the interface mode.
TOR1 (config-if) #channel-group 1 mode active	Add the interface as member of LAG interface.

TOR1 (config-if) #exit	Exit the interface mode.
TOR1 (config) #int xe11	Enter the interface mode.
TOR1 (config-if) #channel-group 2 mode active	Add the interface as member of LAG interface.
TOR1 (config-if) #exit	Exit the interface mode.
TOR1 (config) #mcec domain configuration	Enter the MCEC mode.
TOR1 (config-mcec-domain) #domain-system-number 1	Assign the domain system number for MLAG interface.
TOR1 (config-mcec-domain) #domain-address 1111.2222.3333	Assign the domain address.
TOR1 (config-mcec-domain) #domain-hello-timeout short	Assign the domain hello timeout.
TOR1 (config-mcec-domain) #intra-domain-link xe7	Assign the interface as IDL only if the IDP is required.
TOR1 (config-mcec-domain) #intra-domain-peer 2.2.2.3 source-address 2.2.2.2	Configure source ip address for IDP only if the IDP is required.
TOR1 (config-mcec-domain) #exit	Exit the MCEC domain.
TOR1 (config-mcec-domain) #commit	Commit the configure on the node.
TOR1 (config) #exit	Exit the config terminal.

TOR-2

TOR2#configure terminal	Enter the config terminal.
TOR2 (config) #hostname TOR2	Assign the hostname for the router.
TOR2 (config) #bridge 1 protocol rstp vlan-bridge	Create bridge.
TOR2 (config) #vlan database	Enter the VLAN database.
TOR2 (config-vlan) #vlan 2-1002 bridge 1 state enable	Create the VLANs.
TOR2 (config-vlan) #exit	Exit the VLAN database.
TOR2 (config) #int mlag1	Create the MLAG interface.
TOR2 (config-if) #switchport	Configure the interface as Layer 2
TOR2 (config-if) #bridge-group 1	Assign the bridge to the interface.
TOR2 (config-if) #switchport mode trunk	Configure the interface as trunk mode.
TOR2 (config-if) #switchport trunk allowed vlan all	Configure the interface to allow all VLAN ids.
TOR2 (config-if) #exit	Exit the interface mode.
TOR2 (config) #int mlag2	Create the MLAG interface.
TOR2 (config-if) #switchport	Configure the interface as Layer 2.
TOR2 (config-if) #bridge-group 1	Assign the bridge to the interface.
TOR2 (config-if) #switchport mode trunk	Configure the interface as trunk mode.
TOR2 (config-if) #switchport trunk allowed vlan all	Configure the interface to allow all VLAN ids.
TOR2 (config-if) #exit	Exit the interface mode.
TOR2 (config) #int po1	Create the port channel interface
TOR2 (config-if) #switchport	Configure the interface as Layer 2

TOR2 (config-if) #mlag 1	Bind MLAG to the port channel.
TOR2 (config-if) #exit	Exit the interface mode.
TOR2 (config) #int po2	Create the port channel interface.
TOR2 (config-if) #switchport	Configure the interface as Layer 2.
TOR2 (config-if) #mlag 2	Bind MLAG to the port channel.
TOR2 (config-if) #exit	Exit the interface mode.
TOR2 (config) #interface xe7	Enter the interface mode
TOR2 (config-if) #switchport	Configure the interface as Layer 2.
TOR2 (config-if) #interface xe10	Enter the interface mode.
TOR2 (config-if) #ip address 2.2.2.3/24	Configure source ip address for IDP only if the IDP is required.
TOR2 (config-if) #exit	Exit the interface mode.
TOR2 (config) #int xe32	Enter the interface mode.
TOR2 (config-if) #channel-group 1 mode active	Add the interface as member of LAG interface.
TOR2 (config-if) #exit	Exit the interface mode.
TOR2 (config) #int xe5	Enter the interface mode
TOR2 (config-if) #channel-group 2 mode active	Add the interface as member of LAG interface.
TOR2 (config-if) #exit	Exit the interface mode.
TOR2 (config) #mcec domain configuration	Enter the MCEC mode.
TOR2 (config-mcec-domain) #domain-system-number 2	Assign the domain system number for MLAG interface.
TOR2 (config-mcec-domain) #domain-address 1111.2222.3333	Assign the domain address.
TOR2 (config-mcec-domain) #domain-hello-timeout short	Assign the domain hello timeout.
TOR2 (config-mcec-domain) #intra-domain-link xe7	Assign the interface as IDL only if the IDL is required.
TOR2 (config-mcec-domain) #)#intra-domain-peer 2.2.2.2 source-address 2.2.2.3	Configure source ip address for IDP only if the IDP is required.
TOR2 (config-mcec-domain) #exit	Exit the MCEC domain.
TOR2 (config-mcec-domain) #commit	Commit the configure on the node.
TOR2 (config) #exit	Exit the config terminal.

Switch 2

SW2#configure terminal	Enter the config terminal.
SW2 (config) #hostname SW2	Assign the hostname for the router.
SW2 (config) #bridge 1 protocol rstp vlan-bridge	Create bridge.
SW2 (config) #vlan database	Enter the VLAN database

SW2(config-vlan)#vlan 2-1002 bridge 1 state enable	Create the VLANs.
SW2(config-vlan)#exit	Exit the VLAN database
SW2(config)#int po2	Enter the interface mode
SW2(config-if)#switchport	Configure the interface as Layer 2
SW2(config-if)#bridge-group 1	Assign the bridge to the interface.
SW2(config-if)#switchport mode trunk	Configure the interface as trunk mode.
SW2(config-if)#switchport trunk allowed vlan all	Configure the interface to allow all VLAN ids.
SW2(config-if)#exit	Exit the interface mode.
SW2(config)#int xe11	Enter the interface mode.
SW2(config-if)#channel-group 2 mode active	Add the interface as member of LAG interface.
SW2(config-if)#int xe5	Enter the interface mode.
SW2(config-if)#channel-group 2 mode active	Add the interface as member of LAG interface.
SW2(config-if)#commit	Commit the configure on the node.
SW2(config-if)#exit	Exit the interface mode.

Validation

Switch 1

```
SW1#show etherchannel summary
  Aggregator po1 100001
  Aggregator Type: Layer2
  Admin Key: 0001 - Oper Key 0001
    Link: xe15 (5015) sync: 1
    Link: xe31 (5031) sync: 0
SW1#
```

```
SW1#show etherchannel detail
  Aggregator po1 100001
  Aggregator Type: Layer2
  Mac address: 34:17:eb:e4:af:10
  Admin Key: 0001 - Oper Key 0001
  Actor LAG ID- 0x8000,34-17-eb-4b-af-00,0x0001
  Receive link count: 1 - Transmit link count: 1
  Individual: 0 - Ready: 1
  Partner LAG ID- 0x8000,11-11-22-22-33-33,0x4001
    Link: xe15 (5015) sync: 1
    Link: xe31 (5031) sync: 0
  Collector max delay: 5
SW1#
```

TOR 1

```
TOR1#show etherchannel summary
  Aggregator po1 100001
  Aggregator Type: Layer2
  Admin Key: 16385 - Oper Key 16385
    Link: xe15 (5015) sync: 1 (Mlag-active-link)
-----
  Aggregator po2 100002
  Aggregator Type: Layer2
```

```
Admin Key: 16386 - Oper Key 16386
Link: xell (5011) sync: 1 (Mlag-active-link)
TOR1#
```

```
TOR1#show mlag domain summary
```

```
-----
Domain Configuration
-----
```

```
Domain System Number      : 1
Domain Address            : 1111.2222.3333
Domain Priority           : 32768
Intra Domain Interface    : xe7
Source Address            : 2.2.2.2
Intra-domain-peer        : 2.2.2.3
Domain Adjacency         : UP
MCEC PDU local version   : 1
MCEC PDU peer version    : 1
Domain Sync via          : Intra-domain-interface
Peer SVI interface MAC Address : E8.C5.7A.69.4C.B3
```

```
-----
MLAG Configuration
-----
```

```
MLAG-1
```

```
Mapped Aggregator        : po1
Physical properties Digest : 54 a9 3a 2a 2b 50 65 bb 3c bc 3d bd c2 43 d6
22
```

```
Total Bandwidth         : 10g
Mlag Sync                 : IN_SYNC
Mode                     : Active-Standby
Current Mlag state       : Active
Switchover-mode          : Revertive
```

```
MLAG-2
```

```
Mapped Aggregator        : po2
Physical properties Digest : 54 a9 3a 2a 2b 50 65 bb 3c bc 3d bd c2 43 d6
22
```

```
Total Bandwidth         : 10g
Mlag Sync                 : IN_SYNC
Mode                     : Active-Standby
Current Mlag state       : Active
Switchover-mode          : Revertive
```

```
TOR1#
```

```
TOR1#show etherchannel detail
```

```
Aggregator po1 100001
Aggregator Type: Layer2
Mac address: 3c:2c:99:1a:da:89
Admin Key: 16385 - Oper Key 16385
Actor LAG ID- 0x8000,11-11-22-22-33-33,0x4001
```



```

Receive link count: 1 - Transmit link count: 1
Individual: 0 - Ready: 1
Partner LAG ID- 0x8000,34-17-eb-4b-af-00,0x0001
Link: xe15 (5015) sync: 1 (Mlag-active-link)
Collector max delay: 5

```

```

-----
Aggregator po2 100002
Aggregator Type: Layer2
Mac address: 3c:2c:99:1a:da:85
Admin Key: 16386 - Oper Key 16386
Actor LAG ID- 0x8000,11-11-22-22-33-33,0x4002
Receive link count: 1 - Transmit link count: 1
Individual: 0 - Ready: 1
Partner LAG ID- 0x8000,3c-2c-99-c0-9f-79,0x0002
Link: xe11 (5011) sync: 1 (Mlag-active-link)
Collector max delay: 5

```

TOR1#

TOR1#show mcec statistics

```

Unknown MCCPDU received on the system          : 0

```

```

-----
IDP                      : xe7
-----

```

```

Valid RX Hello PDUs          : 4054
Valid TX Hello PDUs          : 4191
Valid RX Info PDUs           : 66
Valid TX Info PDUs           : 16

Valid RX Mac Sync PDUs       : 53
Valid TX Mac Sync PDUs       : 61

```

MLAG 1

```

Valid RX Info PDUs          : 9
Valid TX Info PDUs          : 8

```

MLAG 2

```

Valid RX Info PDUs          : 12
Valid TX Info PDUs          : 8

```

TOR1#

TOR 2

TOR2#show etherchannel summary

```

Aggregator po1 100001
Aggregator Type: Layer2
Admin Key: 32769 - Oper Key 16385
Link: xe32 (5032) sync: 0 (Mlag-standby-link)

```

```

-----
Aggregator po2 100002
Aggregator Type: Layer2
Admin Key: 32770 - Oper Key 16386
Link: xe5 (5005) sync: 0 (Mlag-standby-link)

```

TOR2#

TOR2#show etherchannel detail

```

Aggregator po1 100001
Aggregator Type: Layer2
Mac address: 80:a2:35:c4:e9:73
Admin Key: 32769 - Oper Key 16385
Actor LAG ID- 0x8000,11-11-22-22-33-33,0x4001
Receive link count: 0 - Transmit link count: 0
Individual: 0 - Ready: 1
Partner LAG ID- 0x8000,34-17-eb-4b-af-00,0x0001
Link: xe32 (5032) sync: 0 (Mlag-standby-link)
Collector max delay: 5

```

```

-----
Aggregator po2 100002
Aggregator Type: Layer2
Mac address: 80:a2:35:c4:e9:58
Admin Key: 32770 - Oper Key 16386
Actor LAG ID- 0x8000,11-11-22-22-33-33,0x4002
Receive link count: 0 - Transmit link count: 0
Individual: 0 - Ready: 1
Partner LAG ID- 0x8000,3c-2c-99-c0-9f-79,0x0002
Link: xe5 (5005) sync: 0 (Mlag-standby-link)
Collector max delay: 5

```

```

TOR2#
TOR2#
TOR2#show mlag domain summary

```

```

-----
Domain Configuration
-----

```

```

Domain System Number          : 2
Domain Address                 : 1111.2222.3333
Domain Priority                 : 32768
Intra Domain Interface        : xe7
Source Address                 : 2.2.2.3
Intra-domain-peer             : 2.2.2.2
Domain Adjacency               : UP
MCEC PDU local version         : 1
MCEC PDU peer version         : 1
Domain Sync via                : Intra-domain-interface
Peer SVI interface MAC Address : 80.A2.35.3A.40.94

```

```

-----
MLAG Configuration
-----

```

```

MLAG-1
Mapped Aggregator              : po1
Physical properties Digest     : 54 a9 3a 2a 2b 50 65 bb 3c bc 3d bd c2 43 d6
22

Total Bandwidth                : 10g
Mlag Sync                      : IN_SYNC
Mode                           : Active-Standby
Current Mlag state             : Standby
Switchover-mode               : Revertive

```

```

MLAG-2
  Mapped Aggregator           : po2
  Physical properties Digest   : 54 a9 3a 2a 2b 50 65 bb 3c bc 3d bd c2 43 d6
22

  Total Bandwidth             : 10g
  Mlag Sync                   : IN_SYNC
  Mode                        : Active-Standby
  Current Mlag state          : Standby
  Switchover-mode             : Revertive

```

TOR2#

TOR2#show mcec statistics

Unknown MCPPDU received on the system : 0

```

-----
IDP                : xe7
-----

```

```

Valid RX Hello PDUs           : 4177
Valid TX Hello PDUs           : 4159
Valid RX Info PDUs            : 16
Valid TX Info PDUs            : 66

Valid RX Mac Sync PDUs        : 74
Valid TX Mac Sync PDUs        : 30

```

MLAG 1

```

Valid RX Info PDUs           : 8
Valid TX Info PDUs           : 27

```

MLAG 2

```

Valid RX Info PDUs           : 8
Valid TX Info PDUs           : 39

```

TOR2#

Switch 2

```

SW2#show etherchannel summary
  Aggregator po2 100002
  Aggregator Type: Layer2
  Admin Key: 0002 - Oper Key 0002
    Link: xe5 (5005) sync: 0
    Link: xe11 (5011) sync: 1

```

```

SW2#show etherchannel detail
  Aggregator po2 100002
  Aggregator Type: Layer2
  Mac address: 3c:2c:99:26:e6:7f
  Admin Key: 0002 - Oper Key 0002
  Actor LAG ID- 0x8000,3c-2c-99-c0-9f-79,0x0002
  Receive link count: 1 - Transmit link count: 1
  Individual: 0 - Ready: 1
  Partner LAG ID- 0x8000,11-11-22-22-33-33,0x4002

```

```

Link: xe5 (5005) sync: 0
Link: xe11 (5011) sync: 1
Collector max delay: 5
SW2#

```

MLAG Active-Active Dynamic Configuration

MLAG (also called DRNI, Distributed Resilient Network Interconnect) expands the concept of link aggregation so that it provides node-level redundancy by allowing two or more nodes to share a common LAG endpoint. MLAG emulates multiple nodes to represent as a single logical node to the remote node running link aggregation. As a result, even if one of the nodes is down there exists a path to reach the destination through the other nodes.

Note: MLAG is compatible only with a RSTP VLAN-aware bridge or a spanning tree disabled bridge.

Note: All MLAG nodes must have the same MAC table size as specified by each node's switching ASIC forwarding profile limit.

Topology

As shown in [Figure 14-32](#), TOR 1 and TOR 2 form an MLAG domain. TOR 1 and TOR 2 are a single logical switch to LEAF and LwSW. Even if either TOR 1 or TOR 2 is down, there exists a path to reach other destinations.

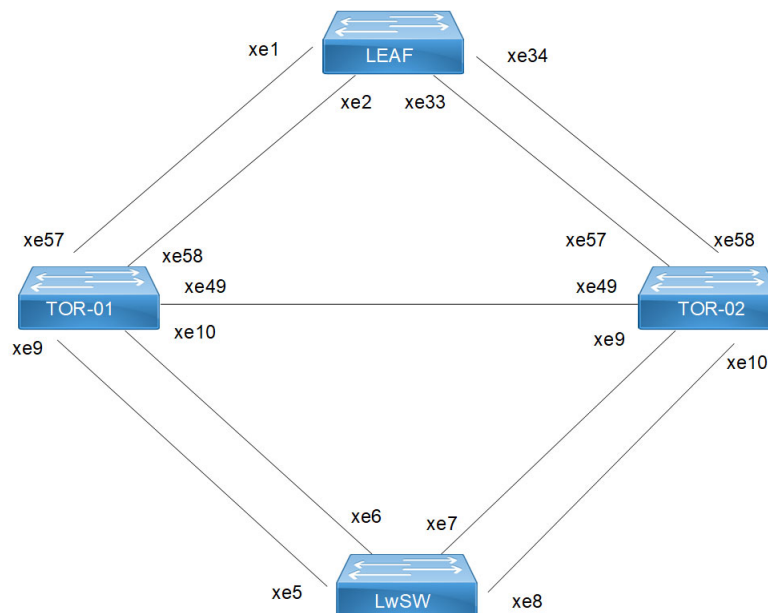

Figure 14-32: MLAG Active-Active Topology

LEAF

#configure terminal	Enter configure mode.
(config)#hardware-profile filter egress-l2 enable	Enable the hardware-profile filter
(config)#bridge 1 protocol rstp vlan-bridge	Create RSTP bridge 1.
(config)#vlan 2 bridge 1 state enable	Create VLAN 2.

<code>(config)#interface po2</code>	Enter interface mode.
<code>(config-if)#switchport</code>	Configure the interface as Layer 2
<code>(config-if)#bridge-group 1</code>	Associate the interface with bridge group 1.
<code>(config-if)#switchport mode trunk</code>	Set the switching characteristics of this interface to trunk mode.
<code>(config-if)#switchport trunk allowed vlan all</code>	Enable all VLAN identifiers on this interface.
<code>(config-if)#commit</code>	Commit the candidate configuration to the running configuration
<code>(config-if)#exit</code>	Exit interface mode.
<code>(config)#interface xe1</code>	Enter interface mode.
<code>(config-if)#channel-group 2 mode active</code>	Add this interface to channel group 2 and enable link aggregation so that it can be selected for aggregation by the local system.
<code>(config-if)#commit</code>	Commit the candidate configuration to the running configuration
<code>(config-if)#exit</code>	Exit interface mode.
<code>(config)#interface xe2</code>	Enter interface mode.
<code>(config-if)#channel-group 2 mode active</code>	Add this interface to channel group 2 and enable link aggregation so that it can be selected for aggregation by the local system.
<code>(config-if)#commit</code>	Commit the candidate configuration to the running configuration
<code>(config-if)#exit</code>	Exit interface mode.
<code>(config)#interface xe33</code>	Enter interface mode.
<code>(config-if)#channel-group 2 mode active</code>	Add this interface to channel group 2 and enable link aggregation so that it can be selected for aggregation by the local system.
<code>(config-if)#commit</code>	Commit the candidate configuration to the running configuration
<code>(config-if)#exit</code>	Exit interface mode.
<code>(config)#interface xe34</code>	Enter interface mode.
<code>(config-if)#channel-group 2 mode active</code>	Add this interface to channel group 2 and enable link aggregation so that it can be selected for aggregation by the local system.
<code>(config-if)#commit</code>	Commit the candidate configuration to the running configuration
<code>(config-if)#exit</code>	Exit interface mode.

LwSW

<code>#configure terminal</code>	Enter configure mode.
<code>(config)#hardware-profile filter egress-12 enable</code>	Enable the hardware-profile filter
<code>(config)#bridge 1 protocol rstp vlan-bridge</code>	Create RSTP bridge 1.
<code>(config)#vlan 2 bridge 1 state enable</code>	Create VLAN 2.
<code>(config)#interface po1</code>	Enter interface mode.

<code>(config-if)#switchport</code>	Configure the interface as Layer 2
<code>(config-if)#bridge-group 1</code>	Associate the interface with bridge group 1.
<code>(config-if)#switchport mode trunk</code>	Set the switching characteristics of this interface to trunk mode.
<code>(config-if)#switchport trunk allowed vlan all</code>	Enable all VLAN identifiers on this interface.
<code>(config-if)#commit</code>	Commit the candidate configuration to the running configuration
<code>(config-if)#exit</code>	Exit interface mode.
<code>(config)#interface xe5</code>	Enter interface mode.
<code>(config-if)#channel-group 1 mode active</code>	Add this interface to channel group 1 and enable link aggregation so that it can be selected for aggregation by the local system.
<code>(config-if)#commit</code>	Commit the candidate configuration to the running configuration
<code>(config-if)#exit</code>	Exit interface mode.
<code>(config)#interface xe6</code>	Enter interface mode.
<code>(config-if)#channel-group 1 mode active</code>	Add this interface to channel group 1 and enable link aggregation so that it can be selected for aggregation by the local system.
<code>(config-if)#commit</code>	Commit the candidate configuration to the running configuration
<code>(config-if)#exit</code>	Exit interface mode.
<code>(config)#interface xe7</code>	Enter interface mode.
<code>(config-if)#channel-group 1 mode active</code>	Add this interface to channel group 1 and enable link aggregation so that it can be selected for aggregation by the local system.
<code>(config-if)#exit</code>	Exit interface mode.
<code>(config)#interface xe8</code>	Enter interface mode.
<code>(config-if)#channel-group 1 mode active</code>	Add this interface to channel group 1 and enable link aggregation so that it can be selected for aggregation by the local system.
<code>(config-if)#commit</code>	Commit the candidate configuration to the running configuration
<code>(config-if)#exit</code>	Exit interface mode.

TOR-01

<code>#configure terminal</code>	Enter configure mode.
<code>(config)#hardware-profile filter egress-12 enable</code>	Enable the hardware-profile filter
<code>(config)#interface mlag1</code>	Enter interface mode.
<code>(config-if)#mode active-active</code>	Mode need to be configured as active-active
<code>(config-if)#commit</code>	Commit the candidate configuration to the running configuration
<code>(config-if)#exit</code>	Exit interface mode.
<code>(config)#interface mlag2</code>	Enable the hardware-profile filter

<code>(config-if)#mode active-active</code>	Mode need to be configured as active-active
<code>(config-if)#commit</code>	Commit the candidate configuration to the running configuration
<code>(config-if)#exit</code>	Exit interface mode.
<code>(config)#bridge 1 protocol rstp vlan-bridge</code>	Create RSTP bridge 1.
<code>(config)#vlan 2 bridge 1 state enable</code>	Create VLAN 2.
<code>(config)#interface mlag1</code>	Enter interface mode.
<code>(config-if)#switchport</code>	Configure the interface as Layer 2
<code>(config-if)#bridge-group 1 spanning-tree disable</code>	Disable the spanning-tree for the interface
<code>(config-if)#switchport mode trunk</code>	Set the switching characteristics of this interface to trunk mode.
<code>(config-if)#switchport trunk allowed vlan all</code>	Enable all VLAN identifiers on this interface.
<code>(config-if)#commit</code>	Commit the candidate configuration to the running configuration
<code>(config-if)#exit</code>	Exit interface mode.
<code>(config)#interface mlag2</code>	Enter interface mode.
<code>(config-if)#switchport</code>	Configure the interface as Layer 2
<code>(config-if)#bridge-group 1 spanning-tree disable</code>	Disable the spanning-tree for the interface
<code>(config-if)#switchport mode trunk</code>	Set the switching characteristics of this interface to trunk mode.
<code>(config-if)#switchport trunk allowed vlan all</code>	Enable all VLAN identifiers on this interface.
<code>(config-if)#commit</code>	Commit the candidate configuration to the running configuration
<code>(config-if)#exit</code>	Exit interface mode.
<code>(config)#interface po1</code>	Enter interface mode.
<code>(config-if)#switchport</code>	Configure the interface as Layer 2
<code>(config-if)#mlag 1</code>	Enabling MLAG group number
<code>(config-if)#commit</code>	Commit the candidate configuration to the running configuration
<code>(config-if)#exit</code>	Exit interface mode.
<code>(config)#interface po2</code>	Enter interface mode.
<code>(config-if)#switchport</code>	Configure the interface as Layer 2
<code>(config-if)#mlag 2</code>	enabling Mlag group number
<code>(config-if)#exit</code>	Exit interface mode.
<code>(config)#interface xe9</code>	Enter interface mode.
<code>(config-if)#channel-group 1 mode active</code>	Add this interface to channel group 1 and enable link aggregation so that it can be selected for aggregation by the local system.
<code>(config-if)#commit</code>	Commit the candidate configuration to the running configuration
<code>(config-if)#exit</code>	Exit interface mode.

(config)#interface xe57	Enter interface mode.
(config-if)#channel-group 2 mode active	Add this interface to channel group 2 and enable link aggregation so that it can be selected for aggregation by the local system.
(config-if)#commit	Commit the candidate configuration to the running configuration
(config-if)#exit	Exit interface mode.
(config)#interface xe58	Enter interface mode.
(config-if)#channel-group 2 mode active	Add this interface to channel group 2 and enable link aggregation so that it can be selected for aggregation by the local system.
(config-if)#commit	Commit the candidate configuration to the running configuration
(config-if)#exit	Exit interface mode.
(config)#interface xe10	Enter interface mode.
(config-if)#channel-group 1 mode active	Add this interface to channel group 1 and enable link aggregation so that it can be selected for aggregation by the local system.
(config-if)#commit	Commit the candidate configuration to the running configuration
(config-if)#exit	Exit interface mode.
(config)#interface xe49	Enter interface mode.
(config-if)#switchport	Configure the interface as Layer 2
(config-if)#exit	Exit interface mode.
(config)#mcec domain configuration	Entering MCEC mode
(config-mcec-domain)#domain-address 1111.2222.3333	Domain address for the mlag domain
(config-mcec-domain)#intra-domain link xe49	Intra domain line between mlag domain
(config-mcec-domain)#domain-system-number 1	Number to identify the node in a domain
(config-mcec-domain)#commit	Commit the candidate configuration to the running configuration
(config-mcec-domain)#exit	Exit MCEC mode

TOR-02

#configure terminal	Enter configure mode.
(config)#hardware-profile filter egress-l2 enable	Enable the hardware-profile filter
(config)#interface mlag1	Enter interface mode.
(config-if)#mode active-active	Mode need to be configured as active-active
(config-if)#commit	Commit the candidate configuration to the running configuration
(config-if)#exit	Exit interface mode
(config)#interface mlag2	Enable the hardware-profile filter
(config-if)#mode active-active	Mode need to be configured as active-active

<code>(config-if)#commit</code>	Commit the candidate configuration to the running configuration
<code>(config-if)#exit</code>	Exit interface mode
<code>(config)#bridge 1 protocol rstp vlan-bridge</code>	Create RSTP bridge 1.
<code>(config)#vlan 2 bridge 1 state enable</code>	Create VLAN 2.
<code>(config)#interface mlag1</code>	Enter interface mode.
<code>(config-if)#switchport</code>	Configure the interface as Layer 2
<code>(config-if)#bridge-group 1 spanning-tree disable</code>	Disable the spanning-tree for the interface
<code>(config-if)#switchport mode trunk</code>	Set the switching characteristics of this interface to trunk mode.
<code>(config-if)#switchport trunk allowed vlan all</code>	Enable all VLAN identifiers on this interface.
<code>(config-if)#commit</code>	Commit the candidate configuration to the running configuration
<code>(config-if)#exit</code>	Exit interface mode
<code>(config)#bridge 1 protocol rstp vlan-bridge</code>	Create RSTP bridge 1.
<code>(config)#vlan 2 bridge 1 state enable</code>	Create VLAN 2.
<code>(config)#interface mlag1</code>	Enter interface mode.
<code>(config-if)#switchport</code>	Configure the interface as Layer 2
<code>(config-if)#bridge-group 1 spanning-tree disable</code>	Disable the spanning-tree for the interface
<code>(config-if)#switchport mode trunk</code>	Set the switching characteristics of this interface to trunk mode.
<code>(config-if)#switchport trunk allowed vlan all</code>	Enable all VLAN identifiers on this interface.
<code>(config-if)#commit</code>	Commit the candidate configuration to the running configuration
<code>(config-if)#exit</code>	Exit interface mode.
<code>(config)#interface mlag2</code>	Enter interface mode.
<code>(config-if)#switchport</code>	Configure the interface as Layer 2
<code>(config-if)#bridge-group 1 spanning-tree disable</code>	Disable the spanning-tree for the interface
<code>(config-if)#switchport mode trunk</code>	Set the switching characteristics of this interface to trunk mode.
<code>(config-if)#switchport trunk allowed vlan all</code>	Enable all VLAN identifiers on this interface.
<code>(config-if)#commit</code>	Commit the candidate configuration to the running configuration
<code>(config-if)#exit</code>	Exit interface mode.
<code>(config)#interface po1</code>	Enter interface mode.
<code>(config-if)#switchport</code>	Configure the interface as Layer 2
<code>(config-if)#mlag 1</code>	Enabling Mlag group number
<code>(config-if)#commit</code>	Commit the candidate configuration to the running configuration

<code>(config-if)#exit</code>	Exit interface mode.
<code>(config)#interface po2</code>	Enter interface mode.
<code>(config-if)#switchport</code>	Configure the interface as Layer 2
<code>(config-if)#mlag 2</code>	enabling MLAG group number
<code>(config-if)#commit</code>	Commit the candidate configuration to the running configuration
<code>(config-if)#exit</code>	Exit interface mode.
<code>(config)#interface xe9</code>	Enter interface mode.
<code>(config-if)#channel-group 1 mode active</code>	Add this interface to channel group 1 and enable link aggregation so that it can be selected for aggregation by the local system.
<code>(config-if)#commit</code>	Commit the candidate configuration to the running configuration
<code>(config-if)#exit</code>	Exit interface mode.
<code>(config)#interface xe10</code>	Enter interface mode.
<code>(config-if)#channel-group 1 mode active</code>	Add this interface to channel group 1 and enable link aggregation so that it can be selected for aggregation by the local system.
<code>(config-if)#commit</code>	Commit the candidate configuration to the running configuration
<code>(config-if)#exit</code>	Exit interface mode.
<code>(config)#interface xe57</code>	Enter interface mode.
<code>(config-if)#channel-group 2 mode active</code>	Add this interface to channel group 2 and enable link aggregation so that it can be selected for aggregation by the local system.
<code>(config-if)#commit</code>	Commit the candidate configuration to the running configuration
<code>(config-if)#exit</code>	Exit interface mode.
<code>(config)#interface xe58</code>	Enter interface mode.
<code>(config-if)#channel-group 2 mode active</code>	Add this interface to channel group 2 and enable link aggregation so that it can be selected for aggregation by the local system.
<code>(config-if)#commit</code>	Commit the candidate configuration to the running configuration
<code>(config-if)#exit</code>	Exit interface mode.
<code>(config)#interface xe59</code>	Enter interface mode.
<code>(config-if)#switchport</code>	Configure the interface as Layer 2
<code>(config-if)#commit</code>	Commit the candidate configuration to the running configuration
<code>(config-if)#exit</code>	Exit interface mode.
<code>(config)#mcec domain configuration</code>	Entering MCEC mode
<code>(config-mcec-domain)#domain-address 1111.2222.3333</code>	Domain address for the Mlag domain
<code>(config-mcec-domain)#intra-domain link xe49</code>	Intra domain Link between Mlag domains
<code>(config-mcec-domain)#domain-system-number 2</code>	Number to identify the node in domain

(config-mcec-domain)#exit	Exit MCEC mode
(config-mcec-domain)#commit	Commit the candidate configuration to the running configuration

Validation

```
#sh mlag domain details
```

```
-----  
Domain Configuration  
-----
```

```
Domain System Number      : 1  
Domain Address            : 1111.2222.3333  
Domain Priority           : 1000  
Intra Domain Interface    : xe49
```

```
Hello RCV State           : Current  
Hello Periodic Timer State : Fast Periodic  
Domain Sync               : IN_SYNC  
Neigh Domain Sync        : IN_SYNC  
Domain Adjacency         : UP
```

```
-----  
MLAG Configuration  
-----
```

MLAG-1

```
Mapped Aggregator        : po1  
Admin Key                : 16385  
Oper Key                 : 16385  
Physical properties Digest : dd 9c f 76 dd b6 5f 2f eb a1 d3 bb 8d 96 fc 82  
  
Neigh Admin Key         : 32769  
Neigh Physical Digest   : dd 9c f 76 dd b6 5f 2f eb a1 d3 bb 8d 96 fc 82  
Info RCV State          : Current  
Info Periodic Time State : Standby  
Mlag Sync               : IN_SYNC  
Mode                    : Active-Active  
Current Mlag State      : Active
```

MLAG-2

```
Mapped Aggregator        : po2  
Admin Key                : 16386  
Oper Key                 : 16386  
Physical properties Digest : dd 9c f 76 dd b6 5f 2f eb a1 d3 bb 8d 96 fc 82  
  
Neigh Admin Key         : 32770  
Neigh Physical Digest   : dd 9c f 76 dd b6 5f 2f eb a1 d3 bb 8d 96 fc 82
```

```
Info RCV State           : Current
Info Periodic Time State : Standby
Mlag Sync                : IN_SYNC
Mode                     : Active-Active
Current Mlag State       : Active
```

#sh etherchannel summary

```
% Aggregator po1 0
% Aggregator Type: Layer2
% Admin Key: 16385 - Oper Key 16385
% Link: xe57 (5057) sync: 1 (Mlag-active-link)
% Link: xe58 (5058) sync: 1 (Mlag-active-link)
% Aggregator po2 0
% Aggregator Type: Layer2
% Admin Key: 16386 - Oper Key 16386
% Link: xe9 (5009) sync : 1 (Mlag-active-link)
% Link: xe10 (5010) sync: 1 (Mlag-active-link)
```

#sh mlag 1 detail

MLAG-1

```
Mapped Aggregator       : po1
Admin Key                : 16385
Oper Key                 : 16385
Physical properties Digest : dd 9c f 76 dd b6 5f 2f eb a1 d3 bb 8d 96 fc 82

Neigh Admin Key         : 32769
Neigh Physical Digest   : dd 9c f 76 dd b6 5f 2f eb a1 d3 bb 8d 96 fc 82
Info RCV State          : Current
Info Periodic Time State : Standby
Total Bandwidth         : 20g
Mlag Sync                : IN_SYNC
Mode                     : Active-Active
Current Mlag State       : Active
```

sh mcec statistics

```
Unknown MCCPDU received on the system : 0
```

IDP xe49

```
Valid RX Hello PDUs      : 398
Valid TX Hello PDUs      : 417
Valid RX Info PDUs       : 16
Valid TX Info PDUs       : 6

Valid RX Mac Sync PDUs   : 3
```

```
Valid TX Mac Sync PDUs          : 4

MLAG 1
Valid RX Info PDUs              : 8
Valid TX Info PDUs              : 3

MLAG 2
Valid RX Info PDUs              : 8
Valid TX Info PDUs              : 3
sh mlag domain summary
```

Domain Configuration

```
Domain System Number           : 1
Domain Address                  : 1111.2222.3333
Domain Priority                  : 1000
Intra Domain Interface         : xe49
Domain Adjacency                : UP
```

MLAG Configuration

MLAG-1

```
Mapped Aggregator              : po1
Physical properties Digest      : dd 9c f 76 dd b6 5f 2f eb a1 d3 bb 8d 96 fc 82
Total Bandwidth                 : 40g
Mlag Sync                       : IN_SYNC
Mode                            : Active-Active
Current Mlag State              : Active
```

MLAG-2

```
Mapped Aggregator              : po2
Physical properties Digest      : dd 9c f 76 dd b6 5f 2f eb a1 d3 bb 8d 96 fc 82
Total Bandwidth                 : 40g
Mlag Sync                       : IN_SYNC
Mode                            : Active-Active
Current Mlag State              : Active
```

Static Configuration

Static MLAG provides node-level redundancy by allowing two or more nodes in the network to share a common static-LAG endpoint. It emulates multiple nodes to represent as a single logical node to the remote node having static Link aggregation. As a result, even if one of the nodes is down there exists a path to reach the destination via other nodes.

Topology

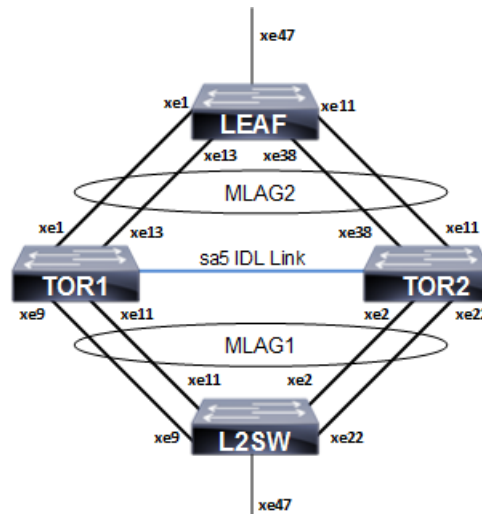

Figure 14-33: Static MLAG topology

L2SW

#configure terminal	Enter configure mode.
(config)#hostname L2SW	Configuring host name
(config)#bridge 1 protocol rstp vlan-bridge	Create a RSTP VLAN bridge on customer side
(config)#vlan 2 bridge 1 state enable	Configure VLAN for the bridge
(config)#interface sa1	Enter the interface mode
(config-if)#bridge-group 1 spanning-tree disable	Disable the spanning-tree for the interface
(config-if)#switchport mode hybrid	Configure the mode as hybrid
(config-if)#switchport hybrid allowed vlan all	Configure allowed VLAN all on the interface
(config-if)#exit	Exit the interface mode
(config)#interface xe2	Enter the interface mode
(config-if)#static-channel-group 1	Map static channel to the interface
(config-if)#exit	Exit the interface mode
(config)#interface xe9	Enter the interface mode
(config-if)#static-channel-group 1	Map static channel to the interface
(config-if)#exit	Exit the interface mode
(config)#interface xe11	Enter the interface mode
(config-if)#static-channel-group 1	Map static channel to the interface
(config-if)#exit	Exit the interface mode
(config)#interface xe22	Enter the interface mode
(config-if)#static-channel-group 1	Map static channel to the interface
(config-if)#exit	Exit the interface mode

(config)#interface xe47	Enter the interface mode
(config-if)#switchport	Make the interface as switch port
(config-if)#bridge-group 1 spanning-tree disable	Disable the spanning-tree for the interface
(config-if)#switchport mode hybrid	Configure the mode as hybrid
(config-if)#switchport hybrid allowed vlan all	Configure allowed VLAN all on the interface
(config-if)#exit	Exit the interface mode

TOR1

#configure terminal	Enter configure mode.
(config)#hostname TOR1	Configuring host name
(config)#bridge 1 protocol provider-rstp edge	Create a PROVIDER-RSTP EDGE bridge
(config)#vlan 2 bridge 1 state enable	Configure VLAN for the bridge
(config)#vlan 200 type service point-point bridge 1 state enable	Configure SVLAN for the bridge
(config)#cvlan registration table map1 bridge 1	Configure CVLAN-SVLAN mapping registration table for the bridge
(config-cvlan-registration)#cvlan 2 svlan 200	Map CVLAN to SVLAN
(config-cvlan-registration)#exit	Exit the config-cvlan-registration mode
(config)#interface mlag1	Enter the interface mode
(config-if)#switchport	Make the interface as switch port
(config-if)#bridge-group 1	Associate the interface to bridge
(config-if)#switchport mode customer-edge hybrid	Configure the mode as customer-edge hybrid
(config-if)#switchport customer-edge hybrid allowed vlan all	Configure allowed VLAN all on the interface
(config-if)#switchport customer-edge vlan registration map1	Map the CVLAN registration table into the MLAG interface
(config-if)#mode active-standby	Configuring MLAG mode
(config-if)#exit	Exit the interface mode
(config)#interface mlag2	Enter the interface mode
(config-if)#switchport	Make the interface as switch port
(config-if)#bridge-group 1	Associate the interface to bridge
(config-if)#switchport mode provider-network	Configure the mode as provider-network
(config-if)#switchport provider-network allowed vlan all	Configure allowed VLAN all on the interface
(config-if)#mode active-standby	Configuring MLAG mode
(config-if)#exit	Exit the interface mode
(config)#interface sa1	Enter the interface mode

(config-if)#switchport	Make the interface as switch port
(config-if)#mlag 1	Map MLAG on SA interface
(config-if)#exit	Exit the interface mode
(config)#interface sa2	Enter the interface mode
(config-if)#switchport	Make the interface as switch port
(config-if)#mlag 2	Map MLAG on SA interface
(config-if)#exit	Exit the interface mode
(config)#interface xe1	Enter the interface mode
(config-if)#static-channel-group 2	Map static channel-group to the interface
(config-if)#exit	Exit the interface mode
(config)#interface xe13	Enter the interface mode
(config-if)#static-channel-group 2	Map static channel-group to the interface
(config-if)#exit	Exit the interface mode
(config)#interface xe9	Enter the interface mode
(config-if)#static-channel-group 1	Map static channel-group to the interface
(config-if)#exit	Exit the interface mode
(config)#interface xe11	Enter the interface mode
(config-if)#static-channel-group 1	Map static channel to the interface
(config-if)#exit	Exit the interface mode
(config)#interface sa5	Enter the interface mode
(config-if)#switchport	Make the interface as switch port
(config-if)#exit	Exit the interface mode
(config)#interface xe3	Enter the interface mode
(config-if)#static-channel-group 5	Map static channel-group to the interface
(config)#interface xe5	Enter the interface mode
(config-if)#static-channel-group 5	Map static channel-group to the interface
(config-if)#exit	Exit the interface mode
(config)#mcec domain configuration	Enter the MLAG domain configuration mode
(config-mcec-domain)#domain-address 1111.2222.3333	Configure the MLAG domain address
(config-mcec-domain)#domain-system-number 1	Configure MLAG domain system number
(config-mcec-domain)#intra-domain-link sa5	Configure the intra domain link

TOR2

#configure terminal	Enter configure mode.
(config)#hostname TOR2	Configuring host name
(config)#bridge 1 protocol provider-rstp edge	Create a PROVIDER-RSTP EDGE bridge
(config)#vlan 2 bridge 1 state enable	Configure VLAN for the bridge
(config)#vlan 200 type service point-point bridge 1 state enable	Configure SVLAN for the bridge

(config)#cvlan registration table map1 bridge 1	Configure CVLAN-SVLAN mapping registration table for the bridge
(config-cvlan-registration)#cvlan 2 svlan 200	Map CVLAN to SVLAN
(config-cvlan-registration)#exit	Exit the config-CVLAN-registration mode
(config)#interface mlag1	Enter the interface mode
(config-if)#switchport	Make the interface as switch port
(config-if)#bridge-group 1	Associate the interface to bridge
(config-if)#switchport mode customer-edge hybrid	Configure the mode as customer-edge hybrid
(config-if)#switchport customer-edge hybrid allowed vlan all	Configure allowed VLAN all on the interface
(config-if)#switchport customer-edge vlan registration map1	Map the CVLAN registration table into the MLAG interface
(config-if)#mode active-standby	Configuring MLAG mode
(config-if)#exit	Exit the interface mode
(config)#interface mlag2	Enter the interface mode
(config-if)#switchport	Make the interface as switch port
(config-if)#bridge-group 1	Associate the interface to bridge
(config-if)#switchport mode provider- network	Configure the mode as provider-network
(config-if)#switchport provider-network allowed vlan all	Configure allowed VLAN all on the interface
(config-if)#mode active-standby	Configuring MLAG mode
(config-if)#exit	Exit the interface mode
(config)#interface sa1	Enter the interface mode
(config-if)#switchport	Make the interface as switch port
(config-if)#mlag 1	Map MLAG on SA interface
(config-if)#exit	Exit the interface mode
(config)#interface sa2	Enter the interface mode
(config-if)#switchport	Make the interface as switch port
(config-if)#mlag 2	Map MLAG on SA interface
(config-if)#exit	Exit the interface mode
(config)#interface xe11	Enter the interface mode
(config-if)#static-channel-group 2	Map static channel to the interface
(config-if)#exit	Exit the interface mode
(config)#interface xe38	Enter the interface mode
(config-if)#static-channel-group 2	Map static channel to the interface
(config-if)#exit	Exit the interface mode
(config)#interface xe2	Enter the interface mode
(config-if)#static-channel-group 1	Create static channel group
(config-if)#exit	Exit the interface mode

(config)#interface xe22	Enter the interface mode
(config-if)#static-channel-group 1	Create static channel group
(config-if)#exit	Exit the interface mode
(config)#interface sa5	Enter the interface mode
(config-if)#switchport	Make the interface as switch port
(config-if)#exit	Exit the interface mode
(config)#interface xe3	Enter the interface mode
(config-if)#static-channel-group 5	Map static channel-group to the interface
(config)#interface xe5	Enter the interface mode
(config-if)#static-channel-group 5	Enter the interface mode
(config-if)#exit	Exit the interface mode
(config)#mcec domain configuration	Enter the MLAG domain configuration mode
(config-mcec-domain)#domain-address 1111.2222.3333	Configure the MLAG domain address
(config-mcec-domain)#domain-system-number 2	Configure MLAG domain system number
(config-mcec-domain)#intra-domain-link sa5	Configure the intra domain link
(config-if)#exit	Exit the interface mode

LEAF

#configure terminal	Enter configure mode.
(config)#hostname LEAF	Configuring host name
(config)#bridge 1 protocol provider-rstp edge	Create a PROVIDER-RSTP EDGE bridge
(config)#vlan 2 bridge 1 state enable	Configure VLAN for the bridge
(config)#vlan 200 type service point-point bridge 1 state enable	Configure SVLAN for the bridge
(config)#cvlan registration table map1 bridge 1	Configure CVLAN-SVLAN mapping registration table for the bridge
(config-cvlan-registration)#cvlan 2 svlan 200	Map CVLAN to SVLAN
(config-cvlan-registration)#exit	Exit the config-CVLAN-registration mode
(config)#interface sa2	Enter the interface mode
(config-if)#switchport	Make the interface a switch port
(config-if)#bridge-group 1 spanning-tree disable	Disable the spanning-tree for the interface
(config-if)#switchport mode provider-network	Configure the mode as provider-network
(config-if)#)#switchport provider-network allowed vlan all	Configure allowed VLAN all on the interface
(config-if)#exit	Exit the interface mode
(config)#interface xe1	Enter the interface mode
(config-if)#static-channel-group 2	Map the interface to the static channel-group
(config-if)#exit	Exit the interface mode

(config)#interface xe13	Enter the interface mode
(config-if)#static-channel-group 2	Create static channel group
(config-if)#exit	Exit the interface mode
(config)#interface xe11	Enter the interface mode
(config-if)#static-channel-group 2	Map the interface to the static channel-group
(config-if)#exit	Exit the interface mode
(config)#interface xe38	Enter the interface mode
(config-if)#static-channel-group 2	Create static channel group
(config-if)#exit	Exit the interface mode
(config)#interface xe47	Enter the interface mode
(config-if)#switchport	Make the interface as switch port
(config-if)#bridge-group 1 spanning-tree disable	Disable the spanning-tree for the interface
(config-if)#switchport mode customer-edge hybrid	Configure the mode as customer-edge hybrid
(config-if)#switchport customer-edge hybrid allowed vlan all	Configure allowed VLAN all on the interface
(config-if)#switchport customer-edge vlan registration map1	Map the CVLAN registration table into the MLAG interface
(config-if)#exit	Exit the interface mode

Validation

```
TOR1#show mlag 1 detail
```

```
MLAG-1
```

```
Mapped Aggregator: sal
```

```
Admin Key: 16385
```

```
Oper Key: 16385
```

```
Physical properties Digest: d a6 26 2d fa 9a 5c 7b e6 15 79 c2 d5 9c 57 cc
```

```
Neigh Admin Key: 32769
```

```
Neigh Physical Digest: d a6 26 2d fa 9a 5c 7b e6 15 79 c2 d5 9c 57 cc Info RCV State: Current
```

```
Info Periodic Time State: Standby Total Bandwidth: 40g
```

```
Mlag Sync: IN_SYNC
```

```
Mode: Active-Standby
```

```
Current Mlag State: Active
```

Switchover-mode: Revertive TOR1#

```
TOR1#show mlag domain summary
```

```
DomainConfiguration
```

```
Domain
```

```
System Number:
```

```
1
```

```
DomainAddress:1111.2222.3333
```

DomainPriority:32768
Intra Domain Interface: sa5
Domain Adjacency: UP

MLAG Configuration

MLAG-1

Mapped Aggregator: sa1
Physical properties Digest: d a6 26 2d fa 9a 5c 7b e6 15 79 c2 d5 9c 57 cc Total
Bandwidth: 40g
Mlag Sync: IN_SYNC
Mode: Active-Standby
Current Mlag State: Active
Switchover-mode: Revertive

MLAG-2

Mapped Aggregator: sa2
Physical properties Digest: ae 56 a1 c5 b9 dc 46 a4 5d 97 dc 79 9c 6f a5 c8

Total Bandwidth: 40g
Mlag Sync: IN_SYNC
Mode: Active-Standby
Current Mlag State: Active
Switchover-mode: Revertive

TOR1#show mlag domain detail

Domain Configuration
DomainSystem Number:1
DomainAddress:1111.2222.3333
DomainPriority:32768
IntraDomain Interface:sa5

Hello RCV State: Current Hello Periodic Timer State: Slow Periodic Domain Sync: IN_SYNC
Neigh Domain Sync: IN_SYNC
Domain Adjacency: UP

MLAG Configuration

MLAG-1

Mapped Aggregator: sa1
Admin Key: 16385
Oper Key: 16385
Physical properties Digest: d a6 26 2d fa 9a 5c 7b e6 15 79 c2 d5 9c 57 cc

Neigh Admin Key: 32769
Neigh Physical Digest: d a6 26 2d fa 9a 5c 7b e6 15 79 c2 d5 9c 57 cc Info RCV State:
Current
Info Periodic Time State: Standby Total Bandwidth: 40g
Mlag Sync: IN_SYNC
Mode: Active-Standby

Current Mlag State: Active Switchover-mode: Revertive

MLAG-2

Mapped Aggregator: sa2

Admin Key: 16386

Oper Key: 16386

Physical properties Digest: ae 56 a1 c5 b9 dc 46 a4 5d 97 dc 79 9c 6f a5 c8

Neigh Admin Key: 32770

Neigh Physical Digest: ae 56 a1 c5 b9 dc 46 a4 5d 97 dc 79 9c 6f a5 c8

Info RCV State: Current Info Periodic Time State : Standby Total Bandwidth: 40g

Mlag Sync: IN_SYNC

Mode: Active-Standby

Current Mlag State: Active Switchover-mode: Revertive

ARP ACL Configuration

Topology

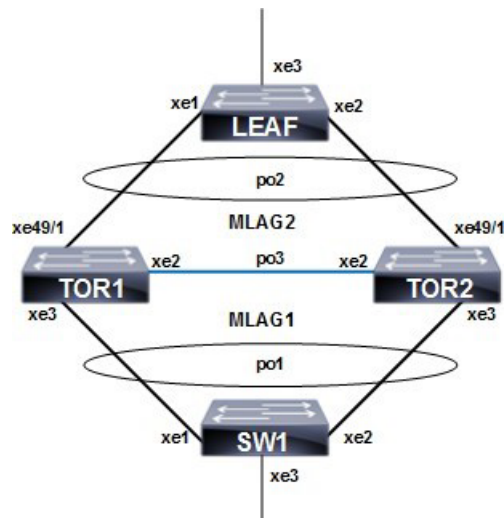

Figure 14-34: ARP ACL configuration with MC LAG

TOR1

#configure terminal	Enter configure mode.
TOR1(config)#bridge 1 protocol provider-rstp edge	Create provider RSTP bridge
TOR1(config)#vlan 2-3990 type customer bridge 1 state enable	Enable customer VLAN for bridge
TOR1(config)#vlan 2-3990 type service point-point bridge 1 state enable	Enable service VLAN for bridge

TOR1(config)#cvlan registration table map1 bridge 1	Create registration table
TOR1(config-cvlan-registration)#cvlan 2- 3990 svlan 3990	Map CVLAN to svlan
TOR1(config-cvlan-registration)#exit	Exit the CVLAN registration table mode
TOR1(config-if)#interface mlag1	Enter MLAG interface
TOR1(config-if)#switchport	Configure interface as switchport
TOR1(config-if)#exit	Exit the interface mode
TOR1(config)#interface mlag2	Enter MLAG interface
TOR1(config-if)#switchport	Configure interface as switchport
TOR1(config-if)#bridge-group 1	Associate the interface with bridge group 1
TOR1(config-if)#switchport mode provider- network	Set the switching characteristics of this interface to provider network
TOR1(config-if)#switchport provider-network allowed vlan all	Set the switching characteristics of this interface to provider network and allow all VLAN
TOR1(config-if)#exit	Exit the interface mode
TOR1(config)#interface po1	Enter dynamic LAG interface
TOR1(config-if)#switchport	Configure interface as switchport
TOR1(config-if)#mlag 1	Enable MLAG group number
TOR1(config-if)#exit	Exit the interface mode
TOR1(config-if)#interface po2	Enter dynamic LAG interface
TOR1(config-if)#switchport	Configure interface as switchport
TOR1(config-if)#mlag 2	Enable MLAG group number
TOR1(config-if)#exit	Exit the interface mode
TOR1(config)#interface po3	Enter dynamic LAG interface
TOR1(config-if)#switchport	Configure interface as switchport
TOR1(config-if)#exit	Exit the interface mode
TOR1(config)#interface xe2	Enter interface mode
TOR1(config-if)#channel-group 3 mode active	Make part of channel group 3
TOR1(config-if)#exit	Exit the interface mode
TOR1(config)#interface xe3	Enter interface mode
TOR1(config-if)#channel-group 1 mode active	Add this interface to channel group 1 and enable link aggregation so that it can be selected for aggregation by the local system
TOR1(config-if)#exit	Exit the interface mode
TOR1(config-if)#interface xe49/1	Enter interface mode
TOR1(config-if)#channel-group 2 mode active	Enable channel-group 2
TOR1(config-if)#exit	Exit the interface mode
TOR1(config)#mcec domain configuration	Enter MCEC mode
TOR1(config-mcec-domain)#domain-address 2222.3333.4444	Domain address for the MLAG domain
TOR1(config-mcec-domain)#domain-system- number 1	Number to identify the node in a domain

TOR1(config-mcec-domain)#intra-domain-link po3	Intra domain line between MLAG domain
TOR1(config)#hardware-profile filter ingress-arp enable	Enable globally hardware profile for ARP
TOR1(config)#arp access-list cep	Create access list with name as CEP
TOR1(config-arp-acl)#30 permit request ip any mac host 0000.2A6C.668D vlan 3990 inner-vlan 2	Create permit rule for particular ARP request
TOR1(config-arp-acl)#40 permit response ip any any mac host 0000.2A6C.668D host 0000.2A6C.7202 vlan 3990 inner-vlan 2	Create permit rule for particular ARP response
TOR1(config)#arp access-list pnp	Create access list with name as PNP
TOR1(config-arp-acl)#20 permit request ip any mac host 0000.2A6C.7202 vlan 3990 inner-vlan 2	Create permit rule for particular ARP request
TOR1(config-arp-acl)#30 permit response ip any any mac host 0000.2A6C.7202 host 0000.2A6C.668D vlan 3990 inner-vlan 2	Create permit rule for particular ARP response
TOR1(config-if)#interface mlag1	Enter mlag1 interface
TOR1(config-if)#arp access-group cep in	Attach rule with access-group CEP
TOR1(config-if)#interface mlag2	Enter mlag2 interface
TOR1(config-if)#arp access-group pnp in	Attach rule with access-group PNP

TOR2

#configure terminal	Enter configure mode.
TOR2(config)#bridge 1 protocol provider-rstp edge	Create provider RSTP bridge
TOR2(config)#vlan 2-3990 type customer bridge 1 state enable	Enable customer VLAN for bridge
TOR2(config)#vlan 2-3990 type service point-point bridge 1 state enable	Enable service VLAN for bridge
TOR2(config)#cvlan registration table map1 bridge 1	Create registration table
TOR2(config-cvlan-registration)#cvlan 2-3990 svlan 3990	Map CVLAN to svlan
TOR2(config-cvlan-registration)#exit	Exit the CVLAN registration table mode
TOR2(config)#interface mlag1	Enter MLAG interface
TOR2(config-if)#switchport	Configure interface as switchport
TOR2(config-if)#bridge-group 1 spanning-tree disable	Associate the interface with bridge group 1 and disabling spanning-tree
TOR2(config-if)#switchport mode customer-edge hybrid	Set the switching characteristics of this interface to customer-edge hybrid
TOR2(config-if)#switchport customer-edge hybrid allowed vlan all	Set the switching characteristics of this interface to customer-edge hybrid and allow VLAN all
TOR2(config-if)#switchport customer-edge vlan registration map1	Configure the registration table mapping on MLAG interface

TOR2 (config-if) #exit	Exit the interface mode
TOR2 (config) #interface mlag2	Enter MLAG interface
TOR2 (config-if) #switchport	Configure interface as switchport
TOR2 (config-if) #bridge-group 1	Associate the interface with bridge group 1
TOR2 (config-if) #switchport mode provider-network	Set the switching characteristics of this interface to provider network
TOR2 (config-if) #switchport provider-network allowed vlan all	Set the switching characteristics of this interface to provider network and allow all VLAN
TOR2 (config-if) #exit	Exit the interface mode
TOR2 (config) #interface po1	Enter dynamic LAG interface
TOR2 (config-if) #switchport	Configure interface as switchport
TOR2 (config-if) #mlag 1	Enable MLAG group number
TOR2 (config-if) #exit	Exit the interface mode
TOR2 (config) #interface po2	Enter dynamic LAG interface
TOR2 (config-if) #switchport	Configure interface as switchport
TOR2 (config-if) #mlag 2	Enable MLAG group number
TOR2 (config-if) #exit	Exit the interface mode
TOR2 (config) #interface po3	Enter dynamic LAG interface
TOR2 (config-if) #switchport	Configure interface as switchport
TOR2 (config-if) #exit	Exit the interface mode
TOR2 (config) #interface xe2	Enter interface mode
TOR2 (config-if) #channel-group 3 mode active	Make part of channel group 3
TOR2 (config-if) #interface xe3	Enter interface mode
TOR2 (config-if) #channel-group 1 mode active	Add this interface to channel group 1 and enable link aggregation so that it can be selected for aggregation by the local system
TOR2 (config-if) #exit	Exit the interface mode
TOR2 (config) #Interface xe49/1	Enter interface mode
TOR2 (config-if) #channel-group 2 mode active	Enable channel-group 2
TOR2 (config) #mcec domain configuration	Configure MCEC domain information
TOR2 (config-mcec-domain) #domain-address 2222.3333.4444	Domain address for the MLAG domain
TOR2 (config-mcec-domain) #domain-system-number 2	Number to identify the node in a domain
TOR2 (config-mcec-domain) #intra-domain-link po3	Intra domain line between MLAG domain
TOR2 (config) #hardware-profile filter ingress-arp enable	Enable globally hardware profile for ARP
TOR2 (config) #arp access-list cep	Create access list with name as CEP
TOR2 (config-arp-acl) #30 permit request ip any mac host 0000.2A6C.668D vlan 3990 inner-vlan 2	Create permit rule for particular ARP request
TOR2 (config-arp-acl) #40 permit response ip any any mac host 0000.2A6C.668D host 0000.2A6C.7202 vlan 3990 inner-vlan 2	Create permit rule for particular ARP response

TOR2(config)#arp access-list pnp	Create access list with name as PNP
TOR2(config-arp-acl)#20 permit request ip any any mac host 0000.2A6C.7202 vlan 3990 inner-vlan 2	Create permit rule for particular ARP request
TOR2(config-arp-acl)#30 permit response ip any any mac host 0000.2A6C.7202 host 0000.2A6C.668D vlan 3990 inner-vlan 2	Create permit rule for particular ARP response
TOR2(config-if)#interface mlag1	Enter mlag1 interface
TOR2(config-if)#arp access-group cep in	Attach rule with access-group CEP
TOR2(config-if)#interface mlag2	Enter mlag2 interface
TOR2(config-if)#arp access-group pnp in	Attach rule with access-group PNP

SW1

#configure terminal	Enter configure mode.
SW1(config)#bridge 1 protocol rstp vlan-bridge	Configure the RSTP VLAN bridge
SW1(config)#vlan 2-3990 type customer bridge 1 state enable	Enable customer VLAN for bridge
SW1(config-if)#interface po1	Enter dynamic LAG interface
SW1(config-if)#switchport	Configure interface as switchport
SW1(config-if)#bridge-group 1 spanning-tree disable	Associate the interface with bridge group 1 and disabling spanning-tree
SW1(config-if)#switchport mode hybrid	Set the switching characteristics of this interface hybrid
SW1(config-if)#switchport hybrid allowed vlan all	Set the switching characteristics of this interface hybrid and allowing all VLAN
SW1(config-if)#exit	Exit the interface mode
SW1(config)#interface xe1	Enter interface mode
SW1(config-if)#channel-group 1 mode active	Add this interface to channel group 1 and enable link aggregation so that it can be selected for aggregation by the local system.
SW1(config-if)#exit	Exit the interface mode
SW1(config)#interface xe2	Enter interface mode
SW1(config-if)#channel-group 1 mode active	Add this interface to channel group 1 and enable link aggregation so that it can be selected for aggregation by the local system.
SW1(config-if)#exit	Exit the interface mode
SW1(config)#interface xe3	Enter interface mode
SW1(config-if)#switchport	Configure interface as switchport
SW1(config-if)#bridge-group 1 spanning-tree disable	Associate the interface with bridge group 1 and disabling spanning-tree
SW1(config-if)#switchport mode hybrid	Set the switching characteristics of this interface hybrid
SW1(config-if)#switchport hybrid allowed vlan all	Set the switching characteristics of this interface hybrid and allowing all VLAN
SW1(config-if)#exit	Exit the interface mode

LEAF

#configure terminal	Enter configure mode.
Leaf(config)#bridge 1 protocol provider-rstp edge	Configure the RSTP VLAN bridge
Leaf(config)#vlan 2-3990 type customer bridge 1 state enable	Enable customer VLAN for bridge
Leaf(config)#vlan 2-3990 type service point-point bridge 1 state enable	Enable service VLAN for bridge
Leaf(config)#cvlan registration table map1 bridge 1	Create registration table
Leaf(config-cvlan-registration)#cvlan 2-3990 svlan 3990	Map CVLAN to SVLAN
Leaf(config-if)#exit	Exit the CVLAN registration table mode
Leaf(config)#interface po2	Enter interface mode
Leaf(config-if)#switchport	Configure interface as switchport
Leaf(config-if)#bridge-group 1 spanning-tree disable	Associate the interface with bridge group 1 and disabling spanning-tree
Leaf(config-if)#switchport mode provider-network	Set the switching characteristics of this interface provider network
Leaf(config-if)#switchport provider-network allowed vlan all	Set the switching characteristics of this interface provider and allowing all VLAN
Leaf(config-if)#exit	Exit the interface mode
Leaf(config)#interface xe1	Enter interface mode
Leaf(config-if)#channel-group 2 mode active	Add this interface to channel group 2 and enable link aggregation so that it can be selected for aggregation by the local system.
Leaf(config-if)#exit	Exit the interface mode
Leaf(config)#interface xe2	Enter interface mode
Leaf(config-if)#channel-group 2 mode active	Add this interface to channel group 2 and enable link aggregation so that it can be selected for aggregation by the local system.
Leaf(config-if)#exit	Exit the interface mode
Leaf(config)#Interface xe3	Enter interface mode
Leaf(config-if)#switchport	Configure interface as switchport
Leaf(config-if)#bridge-group 1 spanning-tree disable	Associate the interface with bridge group 1 and disabling spanning-tree
Leaf(config-if)#switchport mode customer-edge hybrid	Set the switching characteristics of this interface to customer-edge hybrid
Leaf(config-if)#switchport customer-edge hybrid allowed vlan all	Set the switching characteristics of this interface to customer-edge hybrid and allow vlan all
Leaf(config-if)#switchport customer-edge vlan registration map1	Configure the registration table mapping on mlag interface
Leaf(config-if)#exit	Exit the interface mode

Validation

```
TOR1#show access-lists
```

```
ARP access list cep
  30 permit request ip any mac host 0000.2A6C.668D vlan 3990 inner-vlan 2
  40 permit response ip any any mac host 0000.2A6C.668D host 0000.2A6C.7202 vlan
3990 inner-vlan 2
  default deny-all ARP access list pnp
  20 permit request ip any mac host 0000.2A6C.7202 vlan 3990 inner-vlan 2
[match=1]
  30 permit response ip any any mac host 0000.2A6C.7202 host 0000.2A6C.668D vlan
3990 inner-vlan 2 [match=1]
  default deny-all log
```

```
TOR2#show access-lists
ARP access list cep
  30 permit request ip any mac host 0000.2A6C.668D vlan 3990 inner-vlan 2
[match=1]
  40 permit response ip any any mac host 0000.2A6C.668D host 0000.2A6C.7202 vlan
3990 inner-vlan 2 [match=1]
  default deny-all log ARP access list pnp
  20 permit request ip any mac host 0000.2A6C.7202 vlan 3990 inner-vlan 2
  30 permit response ip any any mac host 0000.2A6C.7202 host 0000.2A6C.668D vlan
3990 inner-vlan 2
  default deny-all
```

CHAPTER 15 PW Redundancy with MLAG Configuration

This chapter contains configuration for Pseudowire Redundancy with MLAG (Active and Standby). It also provides an overview of Pseudowire concepts.

In a single-segment pseudowire (SS-PW) application, the Packet Switched Network (PSN) layer usually provides protection for the PW. One way is by using an RSVP LSP with Fast Reroute (FRR) backup; another way is an end-to-end backup LSP. However, there are some applications where the backup PW terminates on a different target PE node, so PSN protection methods cannot protect against failure of either the target Provider Edge (PE) node or a remote Access Circuit (AC). It is also important for an operator that a particular PW is preferred. For example, the one with the least latency.

PW redundancy supports Label Distribution Protocol (LDP) PW. In the case of PW applications, the PSN layer can provide the protection for PW. Occasionally, a TE LSP signaled by RSVP-TE can be used as a PSN tunnel for a PW. In this scenario, TE can provide FRR to protect the end-to-end LSP in the PSN layer.

FRR-based protection schemes cannot protect against failure of PE nodes and access circuits. However, PW redundancy can protect against these failures.

MLAG expands the concept of link aggregation so that it provides node-level redundancy by allowing two nodes to share a common LAG endpoint. This gives PE redundancy for CE node.

CE devices can be connected to two PE nodes for PE-node-level redundancy using MLAG.

End-to-End traffic flow decision will take by MLAG Active node not by PW-Redundancy node.

Topology

In the below example PE1 and PE2 forms a MLAG domain.

As shown in [Figure 15-35](#), PE1 and PE2 are a single logical switches to P3 and P4. Even if either PE1 or PE2 is down, there exists a path to reach other destinations.

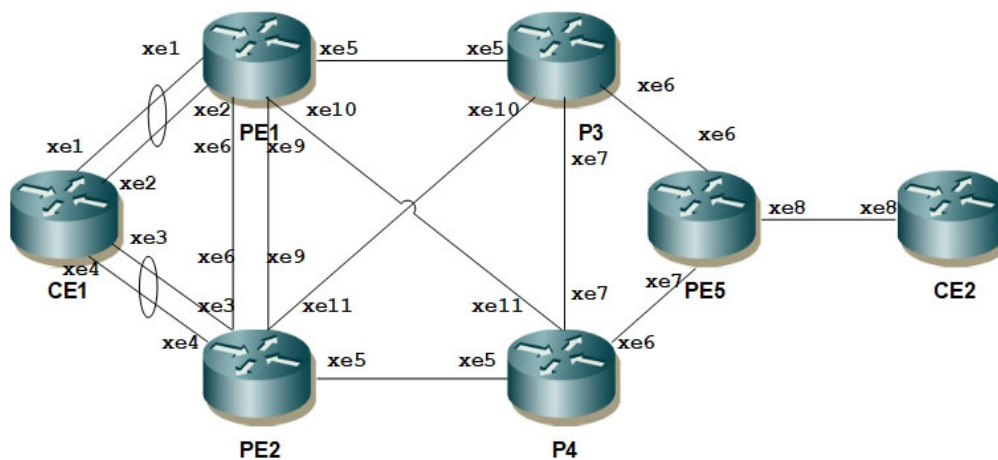

Figure 15-35: MLAG Topology

Uplink Interface and OSPF Configuration

PE1

#configure terminal	Enter configure mode.
(config)#interface lo	Configure the Loopback interface.
(config-if)# ip address 35.35.35.35/32 secondary	Set the IP address of the loopback interface.
(config-if)#exit	Exit interface mode.
(config)# interface xe5	Enter interface mode.
(config-if)# ip address 10.35.48.1/30	Set the IP address of the interface.
(config-if)#exit	Exit interface mode.
(config)# interface xe9	Enter interface mode.
(config-if)# ip address 10.35.33.1/30	Set the IP address of the interface.
(config-if)#exit	Exit interface mode.
(config)# interface xe10	Enter interface mode.
(config-if)# ip address 10.35.49.1/30	Set the IP address of the interface.
(config-if)#exit	Exit interface mode.
(config)#router ospf 100	Enter the Router mode for OSPF.
(config-router)#ospf router-id 35.35.35.35	Configure OSPF router ID.
(config-router)# bfd all-interfaces	Configure BFD on OSPF.
(config-router)#network 10.35.48.0/30 area 0.0.0.0	Define the Network on which OSPF runs and associate the area ID (area 0) with the interface.
(config-router)#network 10.35.49.0/30 area 0.0.0.0	Define the Network on which OSPF runs and associate the area ID (area 0) with the interface.
(config-router)#network 10.35.33.0/30 area 0.0.0.0	Define the Network on which OSPF runs and associate the area ID (area 0) with the interface.
(config-router)#exit	Exit router mode.

PE2

#configure terminal	Enter configure mode.
(config)#interface lo	Configure the Loopback interface.
(config-if)# ip address 33.33.33.33/32 secondary	Set the IP address of the loopback interface.
(config-if)#exit	Exit interface mode.
(config)# interface xe5	Enter interface mode.
(config-if)# ip address 10.33.49.1/30	Set the IP address of the interface.
(config-if)#exit	Exit interface mode.
(config)# interface xe9	Enter interface mode.
(config-if)# ip address 10.35.33.2/30	Set the IP address of the interface.
(config-if)#exit	Exit interface mode.
(config)# interface xe11	Enter interface mode.

(config-if)# ip address 10.33.48.1/30	Set the IP address of the interface.
(config-if)#exit	Exit interface mode.
(config)#router ospf 100	Enter the Router mode for OSPF.
(config-router)#ospf router-id 33.33.33.33	Configure OSPF router ID.
(config-router)# bfd all-interfaces	Configure BFD on OSPF.
(config-router)#network 10.33.48.0/30 area 0.0.0.0	Define the Network on which OSPF runs and associate the area ID (area 0) with the interface.
(config-router)#network 10.33.49.0/30 area 0.0.0.0	Define the Network on which OSPF runs and associate the area ID (area 0) with the interface.
(config-router)#network 10.35.33.0/30 area 0.0.0.0	Define the Network on which OSPF runs and associate the area ID (area 0) with the interface.
(config-router)#exit	Exit router mode

P3

#configure terminal	Enter configure mode.
(config)#interface lo	Configure the Loopback interface.
(config-if)# ip address 48.48.48.48/32 secondary	Set the IP address of the loopback interface.
(config-if)#exit	Exit interface mode.
(config)# interface xe5	Enter interface mode.
(config-if)# ip address 10.35.48.2/30	Set the IP address of the interface.
(config-if)#exit	Exit interface mode.
(config)# interface xe6	Enter interface mode.
(config-if)# ip address 10.48.32.1/30	Set the IP address of the interface
(config-if)#exit	Exit interface mode.
(config)# interface xe7	Enter interface mode.
(config-if)# ip address 10.48.49.1/30	Set the IP address of the interface.
(config-if)#exit	Exit interface mode.
(config)# interface xe11	Enter interface mode.
(config-if)# ip address 10.33.48.2/30	Set the IP address of the interface
(config-if)#exit	Exit interface mode.
(config)#router ospf 100	Enter the Router mode for OSPF.
(config-router)#ospf router-id 48.48.48.48	Configure OSPF router ID.
(config-router)# bfd all-interfaces	Configure BFD on OSPF.
(config-router)#network 10.35.48.0/30 area 0.0.0.0	Define the Network on which OSPF runs and associate the area ID (area 0) with the interface.
(config-router)#network 10.48.49.0/30 area 0.0.0.0	Define the Network on which OSPF runs and associate the area ID (area 0) with the interface.
(config-router)#network 10.48.32.0/30 area 0.0.0.0	Define the Network on which OSPF runs and associate the area ID (area 0) with the interface.
(config-router)#network 10.33.48.0/30 area 0.0.0.0	Define the Network on which OSPF runs and associate the area ID (area 0) with the interface.
(config-router)#exit	Exit router mode

P4

#configure terminal	Enter configure mode.
(config)#interface lo	Configure the Loopback interface.
(config-if)# ip address 49.49.49.49/32 secondary	Set the IP address of the loopback interface.
(config-if)#exit	Exit interface mode.
(config)# interface xe5	Enter interface mode.
(config-if)# ip address 10.33.49.2/30	Set the IP address of the interface.
(config-if)#exit	Exit interface mode.
(config)# interface xe6	Enter interface mode.
(config-if)# ip address 10.49.32.1/30	Set the IP address of the interface.
(config-if)#exit	Exit interface mode.
(config)# interface xe7	Enter interface mode.
(config-if)# ip address 10.48.49.2/30	Set the IP address of the interface.
(config-if)#exit	Exit interface mode.
(config)# interface xe10	Enter interface mode.
(config-if)# ip address 10.35.49.2/30	Set the IP address of the interface.
(config-if)#exit	Exit interface mode.
(config)#router ospf 100	Enter the Router mode for OSPF.
(config-router)#ospf router-id 49.49.49.49	Configure OSPF router ID.
(config-router)# bfd all-interfaces	Configure BFD on OSPF.
(config-router)#network 10.35.49.0/30 area 0.0.0.0	Define the Network on which OSPF runs and associate the area ID (area 0) with the interface.
(config-router)#network 10.48.49.0/30 area 0.0.0.0	Define the Network on which OSPF runs and associate the area ID (area 0) with the interface.
(config-router)#network 10.49.32.0/30 area 0.0.0.0	Define the Network on which OSPF runs and associate the area ID (area 0) with the interface.
(config-router)#network 10.33.49.0/30 area 0.0.0.0	Define the Network on which OSPF runs and associate the area ID (area 0) with the interface.
(config-if)#exit	Exit interface mode.

P5

#configure terminal	Enter configure mode.
(config)#interface lo	Configure the Loopback interface.
(config-if)# ip address 32.32.32.32/32 secondary	Set the IP address of the loopback interface.
(config-if)#exit	Exit interface mode.
(config)# interface xe6	Enter interface mode.
(config-if)# ip address 10.48.32.2/30	Set the IP address of the interface.
(config-if)#exit	Exit interface mode.

(config)# interface xe7	Enter interface mode.
(config-if)# ip address 10.49.32.1/30	Set the IP address of the interface.
(config-if)#exit	Exit interface mode.
(config)#router ospf 100	Enter the Router mode for OSPF.
(config-router)#ospf router-id 32.32.32.32	Configure OSPF router ID.
(config-router)# bfd all-interfaces	Configure BFD on OSPF.
(config-router)#network 10.48.32.0/30 area 0.0.0.0	Define the Network on which OSPF runs and associate the area ID (area 0) with the interface.
(config-router)#network 10.49.32.0/30 area 0.0.0.0	Define the Network on which OSPF runs and associate the area ID (area 0) with the interface.
(config-if)#exit	Exit interface mode.

RSVP Global Configuration

PE1

#configure terminal	Enter configure mode.
(config)#router rsvp	Enter the router mode for RSVP.
(config-router)# no php	Configure no PHP
(config-router)#exit	Exit router mode.
(config)# interface xe5	Enter interface mode.
(config-if)# label-switching	Enable label switching on the interface
(config-if)# enable-rsvp	Enable RSVP on the interface.
(config-if)#exit	Exit interface mode.
(config)# interface xe9	Enter interface mode.
(config-if)# label-switching	Enable label switching on the interface
(config-if)# enable-rsvp	Enable RSVP on the interface.
(config-if)#exit	Exit interface mode.
(config)# interface xe10	Enter interface mode.
(config-if)# label-switching	Enable label switching on the interface
(config-if)# enable-rsvp	Enable RSVP on the interface.
(config-if)#exit	Exit interface mode.

PE2

#configure terminal	Enter configure mode.
(config)#router rsvp	Enter the Router mode for RSVP.
(config-router)# no php	Configure no PHP
(config-router)#exit	Exit router mode.
(config)# interface xe5	Enter interface mode.
(config-if)# label-switching	Enable label switching on the interface

(config-if)# enable-rsvp	Enable RSVP on the interface.
(config-if)#exit	Exit interface mode.
(config)# interface xe9	Enter interface mode.
(config-if)# label-switching	Enable label switching on the interface.
(config-if)# enable-rsvp	Enable RSVP on the interface.
(config-if)#exit	Exit interface mode.
(config)# interface xel1	Enter interface mode.
(config-if)# label-switching	Enable label switching on the interface
(config-if)# enable-rsvp	Enable RSVP on the interface.
(config-if)#exit	Exit interface mode.

P3

#configure terminal	Enter configure mode.
(config)#router rsvp	Enter the Router mode for RSVP.
(config-router)# no php	Configure no PHP
(config-router)#exit	Exit router mode.
(config)# interface xe5	Enter interface mode.
(config-if)# label-switching	Enable label switching on the interface
(config-if)# enable-rsvp	Enable RSVP on the interface.
(config-if)#exit	Exit interface mode.
(config)# interface xe6	Enter interface mode.
(config-if)# label-switching	Enable label switching on the interface
(config-if)# enable-rsvp	Enable RSVP on the interface.
(config-if)#exit	Exit interface mode.
(config)# interface xe7	Enter interface mode.
(config-if)# label-switching	Enable label switching on the interface
(config-if)# enable-rsvp	Enable RSVP on the interface.
(config-if)#exit	Exit interface mode.
(config)# interface xel1	Enter interface mode.
(config-if)# label-switching	Enable label switching on the interface
(config-if)# enable-rsvp	Enable RSVP on the interface.
(config-if)#exit	Exit interface mode.

P4

#configure terminal	Enter configure mode.
(config)#router rsvp	Enter the Router mode for RSVP.
(config-router)# no php	Configure no PHP
(config-router)#exit	Exit router mode.

(config)# interface xe5	Enter interface mode.
(config-if)# label-switching	Enable label switching on the interface
(config-if)# enable-rsvp	Enable RSVP on the interface.
(config-if)#exit	Exit interface mode.
(config)# interface xe6	Enter interface mode.
(config-if)# label-switching	Enable label switching on the interface
(config-if)# enable-rsvp	Enable RSVP on the interface.
(config-if)#exit	Exit interface mode.
(config)# interface xe7	Enter interface mode.
(config-if)# label-switching	Enable label switching on the interface
(config-if)# enable-rsvp	Enable RSVP on the interface.
(config-if)#exit	Exit interface mode.
(config)# interface xe10	Enter interface mode.
(config-if)# label-switching	Enable label switching on the interface
(config-if)# enable-rsvp	Enable RSVP on the interface.
(config-if)#exit	Exit interface mode.

P5

#configure terminal	Enter configure mode.
(config)#router rsvp	Enter the Router mode for RSVP.
(config-router)# no php	Configure no PHP
(config-router)#exit	Exit router mode.
(config)# interface xe6	Enter interface mode.
(config-if)# label-switching	Enable label switching on the interface
(config-if)# enable-rsvp	Enable RSVP on the interface.
(config-if)#exit	Exit interface mode.
(config)# interface xe7	Enter interface mode.
(config-if)# label-switching	Enable label switching on the interface
(config-if)# enable-rsvp	Enable RSVP on the interface.
(config-if)#exit	Exit interface mode.

RSVP-LSP Configuration

PE1

#configure terminal	Enter configure mode.
(config)# rsvp-path 35-to-32 mpls	Configure RSVP-Path PE5
(config-path)# 10.35.48.2 strict	Configure Strict hop

(config-path)# 10.48.32.2 strict	Configure Strict hop
(config-path)#exit	Exit RSVP-Path mode
(config)#rsvp-trunk 35-to-32	Configure RSVP-Trunk to PE5
(config-trunk)# primary fast-reroute protection one-to-one	Set FRR one-to-one mode.
(config-trunk)# primary fast-reroute node-protection	Set FRR node protection
(config-trunk)# primary path 35-to-32	Set RSVP path.
(config-trunk)# to 32.32.32.32	Configure RSVP-LSP destination IP address
(config-trunk)#exit	Exit RSVP-Trunk mode

PE2

#configure terminal	Enter configure mode.
(config)# rsvp-path 33-to-32 mpls	Configure RSVP-Path to PE5
(config-path)# 10.33.49.2 strict	Configure Strict hop
(config-path)# 10.49.32.2 strict	Configure Strict hop
(config-path)#exit	Exit RSVP path mode
(config)#rsvp-trunk 33-to-32	Configure RSVP trunk to PE5.
(config-trunk)# primary fast-reroute protection one-to-one	Set FRR one-to-one mode.
(config-trunk)# primary fast-reroute node-protection	Set FRR node protection
(config-trunk)# primary path 33-to-32	Set RSVP path.
(config-trunk)# to 32.32.32.32	Configure RSVP LSP destination IP address.
(config-trunk)#exit	Exit RSVP-Trunk mode

PE5

#configure terminal	Enter configure mode.
(config)# rsvp-path 32-to-35 mpls	Configure RSVP path to PE1
(config-path)# 10.48.32.1 strict	Configure Strict hop
(config-path)# 10.35.48.1 strict	Configure Strict hop
(config-path)#exit	Exit RSVP path mode
(config)# rsvp-path 32-to-33 mpls	Configure RSVP path to PE2
(config-path)# 10.49.32.1 strict	Configure Strict hop
(config-path)# 10.33.49.1 strict	Configure Strict hop
(config-path)#exit	Exit RSVP path mode
(config)#rsvp-trunk 32-to-35	Configure RSVP trunk.to PE1.
(config-trunk)# primary fast-reroute protection one-to-one	Set FRR one-to-one mode.
(config-trunk)# primary fast-reroute node-protection	Set FRR node protection

(config-trunk)# primary path 32-to-35	Set RSVP path
(config-trunk)# to 33.33.33.33	Configure RSVP-LSP destination IP address.
(config-trunk)#exit	Exit RSVP trunk mode

T-LDP Configuration

PE1

#configure terminal	Enter configure mode.
(config)#router ldp	Enter the router mode for LDP.
(config-router)# router-id 35.35.35.35	Configure LDP router ID.
(config-router)# pw-status-tlv	Set PW status TLV
(config-router)# no multicast-hellos	Disable Multicast hellos
(config-router)# targeted-peer ipv4 32.32.32.32	Configure LDP targeted peer to PE5
(config-router-targeted-peer)# exit- targeted-peer-mode	Exit targeted peer mode.
(config-router)#exit	Exit router mode
(config)# interface xe5	Enter interface mode.
(config-if)# enable-ldp ipv4	Enable IPv4 LDP on the interface.
(config-if)#exit	Exit interface mode.
(config)# interface xe9	Enter interface mode.
(config-if)# enable-ldp ipv4	Enable IPv4 LDP on the interface.
(config-if)#exit	Exit interface mode.
(config)# interface xe10	Enter interface mode.
(config-if)# enable-ldp ipv4	Enable IPv4 LDP on the interface.
(config-if)#exit	Exit interface mode.

PE2

#configure terminal	Enter configure mode.
(config)#router ldp	Enter the router mode for LDP.
(config-router)# router-id 33.33.33.33	Configure LDP router ID
(config-router)# pw-status-tlv	Set PW status TLV.
(config-router)# no multicast-hellos	Disable multicast hellos
(config-router)# targeted-peer ipv4 32.32.32.32	Configure LDP targeted peer to PE5
(config-router-targeted-peer)# exit- targeted-peer-mode	Exit targeted peer mode.
(config-router)#exit	Exit router mode
(config)# interface xe5	Enter interface mode.

(config-if)# enable-ldp ipv4	Enable IPv4 LDP on the interface.
(config-if)#exit	Exit interface mode.
(config)# interface xe9	Enter interface mode.
(config-if)# enable-ldp ipv4	Enable IPv4 LDP on the interface.
(config-if)#exit	Exit interface mode.
(config)# interface xe11	Enter interface mode.
(config-if)# enable-ldp ipv4	Enable IPv4 LDP on the interface.
(config-if)#exit	Exit interface mode.

PE5

#configure terminal	Enter configure mode.
(config)#router ldp	Enter the router mode for LDP.
(config-router)# router-id 32.32.32.32	Configure LDP router ID
(config-router)# pw-status-tlv	Set PW status TLV
(config-router)# no multicast-hellos	Disable multicast hellos
(config-router)# targeted-peer ipv4	Configure LDP targeted peer to PE5
(config-router-targeted-peer)# exit-targeted-peer-mode	Exit targeted peer mode.
(config-router)# targeted-peer ipv4 33.33.33.33	Configure LDP targeted peer to PE5
(config-router-targeted-peer)# exit-targeted-peer-mode	Exit targeted peer mode.
(config-router)#exit	Exit router mode
(config)# interface xe6	Enter interface mode.
(config-if)# enable-ldp ipv4	Enable IPv4 LDP on the interface.
(config-if)#exit	Exit interface mode.
(config)# interface xe7	Enter interface mode.
(config-if)# enable-ldp ipv4	Enable IPv4 LDP on the interface.
(config-if)#exit	Exit interface mode.

MLAG Configuration

CE1

#configure terminal	Enter configure mode.
(config)#interface po1	Configure the LAG interface
(config-if)#switchport	Configure the interface as Layer 2
(config-if)#exit	Exit interface mode.
(config)#interface xe1	Enter interface mode.

(config-if)#channel-group 1 mode active	Add this interface to channel group 1 and enable link aggregation so that it can be selected for aggregation by
(config-if)#exit	Exit interface mode.
(config)#interface xe2	Enter interface mode.
(config-if)#channel-group 1 mode active	Add this interface to channel group 1 and enable link aggregation so that it can be selected for aggregation by
(config-if)#exit	Exit interface mode.
(config)#interface xe3	Enter interface mode.
(config-if)#channel-group 1 mode active	Add this interface to channel group 1 and enable link aggregation so that it can be selected for aggregation by
(config-if)#exit	Exit interface mode.
(config)#interface xe4	Enter interface mode.
(config-if)#channel-group 1 mode active	Add this interface to channel group 1 and enable link aggregation so that it can be selected for aggregation by
(config-if)#exit	Exit interface mode.

PE1

#configure terminal	Enter configure mode.
(config)#mcec domain configuration	Configure MLAG global.
(config-mcec-domain)# domain-address 1111.2222.3333	Configure the domain address.
(config-mcec-domain)# domain-system-number 1	Configure Domain System number.
(config-mcec-domain)# intra-domain-link xe6	Configure IDL link.
(config-mcec-domain)#exit	Exit MLAG global mode.
(config)#interface po1	Configure the LAG interface
(config-if)#switchport	Configure the interface as Layer 2
(config-if)#exit	Exit interface mode.
(config)#interface xe1	Enter interface mode.
(config-if)#channel-group 1 mode active	Add this interface to channel group 1 and enable link aggregation so that it can be selected for aggregation by the local system
(config-if)#exit	Exit interface mode.
(config)#interface xe2	Enter interface mode.
(config-if)#channel-group 1 mode active	Add this interface to channel group 1 and enable link aggregation so that it can be selected for aggregation by
(config-if)#exit	Exit interface mode.
(config)#interface po1	Configure the LAG interface
(config-if)# mlag 1	Configure MLAG domain to LAG interface
(config-if)#exit	Exit interface mode.

PE2

#configure terminal	Enter configure mode.
(config)#mcec domain configuration	Configure MLAG global
(config-mcec-domain)# domain-address 1111.2222.3333	Configure the Domain address
(config-mcec-domain)# domain-system-number 2	Configure Domain System number.
(config-mcec-domain)# intra-domain-link xe6	Configure IDL link.
(config-mcec-domain)#exit	Exit MLAG global mode.
(config)#interface po1	Configure the LAG interface
(config-if)#switchport	Configure the interface as Layer 2
(config-if)#exit	Exit interface mode.
(config)#interface xe3	Enter interface mode.
(config-if)#channel-group 1 mode active	Add this interface to channel group 1 and enable link aggregation so that it can be selected for aggregation by
(config-if)#exit	Exit interface mode.
(config)#interface xe4	Enter interface mode.
(config-if)#channel-group 1 mode active	Add this interface to channel group 1 and enable link aggregation so that it can be selected for aggregation by
(config-if)#exit	Exit interface mode.
(config)#interface po1	Configure the LAG interface
(config-if)# mlag 1	Configure MLAG domain to LAG interface
(config-if)#exit	Exit interface mode.

VPWS PW Redundancy Configuration**PE1**

#configure terminal	Enter configure mode.
(config)#service-template S-00-00-10	Configure service template (translate)
(config-svc)# match outer-vlan 10	Configure match
(config-svc)# rewrite ingress translate 20 outgoing-tpid dot1.q	Configure rewrite action
(config-svc)#exit	Exit service template
(config)# mpls l2-circuit VC1 1001 32.32.32.32	Configure VPWS to PE5
(config-pseudowire)#exit	Exit pseudowire config mode.
(config)#int po1	Enter interface mode
(config-if)#mpls-l2-circuit VC1 service- template S-00-00-10	Attach VPWS to AC interface.
(config-if)#exit	Exit interface

PE2

#configure terminal	Enter configure mode.
(config)#service-template S-00-00-10	Configure service template (translate)
(config-svc)# match outer-vlan 10	Configure match
(config-svc)# rewrite ingress translate 20 outgoing-tpid dot1.q	Configure rewrite action
(config-svc)#exit	Exit service template
(config)# mpls l2-circuit VC2 1002 32.32.32.32	Configure VPWS to PE5
(config-pseudowire)#exit	Exit pseudowire config mode.
(config)#int po1	Enter interface mode
(config-if)#mpls-l2-circuit VC2 service- template S-00-00-10	Attach VPWS to AC interface.
(config-if)#exit	Exit interface

PE5

#configure terminal	Enter configure mode.
(config)#service-template S-00-00-10	Configure service template (translate)
(config-svc)# match outer-vlan 10	Configure match
(config-svc)# rewrite ingress translate 20 outgoing-tpid dot1.q	Configure rewrite action
(config-svc)#exit	Exit service template
(config)# mpls l2-circuit VC1 1001	Configure VPWS to PE1
(config-pseudowire)#exit	Exit pseudowire config mode.
(config)# mpls l2-circuit VC2 1002 33.33.33.33	Configure VPWS to PE2
(config-pseudowire)#exit	Exit pseudowire config mode.
(config)#int xe8	Enter interface mode
(config-if)# switchport	Switch to Layer 2 mode.
(config-if)#mpls-l2-circuit VC1 service- template S-00-00-10	Attach Primary VPWS to AC interface.
(config-if)# mpls-l2-circuit VC2 service- template S-00-00-10 secondary	Attach Secondary VPWS to AC interface.
(config-if)#exit	Exit interface

Validation

To see detail information about the MLAG, use the following command:

MLAG Active node:

```
PE1#show mlag domain details
```



```
-----
Domain Configuration
-----
```

```
Domain System Number      : 1
Domain Address            : 1111.2222.3333
Domain Priority           : 32768
Intra Domain Interface    : xe12

Hello RCV State          : Current
Hello Periodic Timer State : Slow Periodic
Domain Sync              : IN_SYNC
Neigh Domain Sync        : IN_SYNC
Domain Adjacency         : UP
```

```
-----
MLAG Configuration
-----
```

```
MLAG-1
```

```
  Mapped Aggregator      : po1
  Admin Key              : 16385
  Oper Key               : 16385
  Physical properties Digest : 89 25 47 22 f1 47 6d 92 b8 71 9c ca 61 fb db
3a

  Neigh Admin Key        : 32769
  Neigh Physical Digest  : 89 25 47 22 f1 47 6d 92 b8 71 9c ca 61 fb db
3a

  Info RCV State         : Current
  Info Periodic Time State : Standby
  Mlag Sync              : IN_SYNC
  Mode                   : Active-Standby
  Current Mlag state     : Active
```

MLAG Standby node:

```
PE2#show mlag domain details
```

```
-----
Domain Configuration
-----
```

```
Domain System Number      : 2
Domain Address            : 1111.2222.3333
Domain Priority           : 32768
Intra Domain Interface    : xe12

Hello RCV State          : Current
Hello Periodic Timer State : Slow Periodic
Domain Sync              : IN_SYNC
Neigh Domain Sync        : IN_SYNC
Domain Adjacency         : UP
```

MLAG Configuration

MLAG-1

```

Mapped Aggregator           : po1
Admin Key                   : 32769
Oper Key                    : 32769
Physical properties Digest  : 89 25 47 22 f1 47 6d 92 b8 71 9c ca 61 fb db
3a
Neigh Admin Key             : 16385
Neigh Physical Digest      : 89 25 47 22 f1 47 6d 92 b8 71 9c ca 61 fb db
3a
Info RCV State              : Current
Info Periodic Time State   : Standby
Mlag Sync                   : IN_SYNC
Mode                        : Active-Standby
Current Mlag state         : Standby
    
```

To see summary information about the MLAG, use the following command:

MLAG active node:

```
PE1#show mlag domain summary
```

Domain Configuration

```

Domain System Number       : 2
Domain Address              : 1111.2222.3333
Domain Priority             : 32768
Intra Domain Interface     : xe12
Domain Adjacency           : UP
Domain Sync via            : Intra-domain-interface
    
```

MLAG Configuration

MLAG-1

```

Mapped Aggregator           : po1
Physical properties Digest  : 89 25 47 22 f1 47 6d 92 b8 71 9c ca 61 fb db
3a
Total Bandwidth            : 20g
Mlag Sync                   : IN_SYNC
Mode                        : Active-Standby
Current Mlag state         : Active
    
```

MLAG Standby node:

```
PE2#show mlag domain summary
```

Domain Configuration

```

Domain System Number       : 1
    
```

```

Domain Address           : 1111.2222.3333
Domain Priority          : 32768
Intra Domain Interface  : xe12
Domain Adjacency        : UP
Domain Sync via         : Intra-domain-interface

```

MLAG Configuration

```

MLAG-1
  Mapped Aggregator      : po1
  Physical properties Digest : 89 25 47 22 f1 47 6d 92 b8 71 9c ca 61 fb db
3a
  Total Bandwidth        : 20g
  Mlag Sync               : IN_SYNC
  Mode                    : Active-Standby
  Current Mlag state     : Standby

```

To see summary information about the Virtual Circuits, use the following command:

```

#show mpls vc-table
The samples below show summary information about the just-configured four
virtual circuits.
PE1#show mpls vc-table
VC-ID      Vlan-ID  Inner-Vlan-ID  Access-Intf  Network-Intf  Out Label
Tunnel-Label  Nexthop      Status
1001        N/A        N/A            po1          xe14          24960
24324       32.32.32.32  Active
PE1#

PE2#show mpls vc-table
VC-ID      Vlan-ID  Inner-Vlan-ID  Access-Intf  Network-Intf  Out Label
Tunnel-Label  Nexthop      Status
1002        N/A        N/A            po1          xe14          24961
24323       32.32.32.32  Inactive
PE2#

PE5#show mpls vc-table
VC-ID      Vlan-ID  Inner-Vlan-ID  Access-Intf  Network-Intf  Out Label
Tunnel-Label  Nexthop      Status
1001        N/A        N/A            xe23         xe12          24986
24322       35.35.35.35  Active
1002        N/A        N/A            xe23         xe12          24968
24320       33.33.33.33  Inactive
PE5#

```

To view detailed configuration information about the L2 Virtual Circuits, including LDP PW status, use the following command:

```

PE1#show ldp mpls-l2-circuit 1001 detail
vcid: 1001 type: vlan, local groupid: 0, remote groupid: 0 (vc is up)
destination: 32.32.32.32, Peer LDP Ident: 32.32.32.32
Local label: 24986, remote label: 24960
Access IF: po1, Network IF: xe13
Local MTU: 9100, Remote MTU: 9100
Local Control Word: disabled Remote Control Word: Not-Applicable Current
use: disabled

```

```
Local PW Status Capability : enabled
Remote PW Status Capability : enabled
Current PW Status TLV : enabled
Local PW Status :
  Forwarding
  Active
Remote PW Status :
  Forwarding
  Active
```

```
PE2#show ldp mpls-l2-circuit 1002 detail
vcid: 1002 type: vlan, local groupid: 0, remote groupid: 0 (vc is up)
destination: 32.32.32.32, Peer LDP Ident: 32.32.32.32
Local label: 24968, remote label: 24961
Access IF: pol, Network IF: xe14
Local MTU: 9100, Remote MTU: 9100
Local Control Word: disabled Remote Control Word: Not-Applicable Current
use: disabled
Local PW Status Capability : enabled
Remote PW Status Capability : enabled
Current PW Status TLV : enabled
Local PW Status :
  Not Forwarding
  Ingress AC Receive Fault
  Egress AC Transmit Fault
Remote PW Status :
  Not Forwarding
  Standby
```

```
PE5#show ldp mpls-l2-circuit 1001 detail
vcid: 1001 type: vlan, local groupid: 0, remote groupid: 0 (vc is up)
destination: 35.35.35.35, Peer LDP Ident: 35.35.35.35
Local label: 24960, remote label: 24986
Access IF: xe23, Network IF: xe14
Local MTU: 9100, Remote MTU: 9100
Local Control Word: disabled Remote Control Word: Not-Applicable Current
use: disabled
Local PW Status Capability : enabled
Remote PW Status Capability : enabled
Current PW Status TLV : enabled
Local PW Status :
  Forwarding
  Active
Remote PW Status :
  Forwarding
  Active
```

```
PE5#show ldp mpls-l2-circuit 1002 detail
vcid: 1002 type: vlan, local groupid: 0, remote groupid: 0 (vc is up)
destination: 33.33.33.33, Peer LDP Ident: 33.33.33.33
Local label: 24961, remote label: 24968
Access IF: xe23, Network IF: xe12
Local MTU: 9100, Remote MTU: 9100
Local Control Word: disabled Remote Control Word: Not-Applicable Current
use: disabled
Local PW Status Capability : enabled
Remote PW Status Capability : enabled
Current PW Status TLV : enabled
```

Local PW Status :
 Not Forwarding
 Standby
Remote PW Status :
 Not Forwarding
 Ingress AC Receive Fault
 Egress AC Transmit Fault

CHAPTER 16 Traffic Mirroring Configuration

This chapter contains a sample local and remote switched port analyzer feature configuration.

SPAN Overview

Switched Port Analyzer (SPAN) refers to selecting network traffic for analysis by a network analyzer. SPAN feature is introduced on switches as the switch forwards traffic that is destined for a MAC address directly to the corresponding port leaving no scope to analyze the traffic.

SPAN monitors the traffic on source port and sends a copy of the traffic to a destination port. The network analyzer, which is attached to the destination port, analyzes the received traffic. Source port can be a single port or multiple ports. A replication of the packets is sent to the destination port for analysis

SPAN is originally referred to port mirroring or port monitoring where all the network traffic on the source port is mirrored to destination port. Port mirroring has three subdivisions.

- Ingress mirroring: Traffic received on the source port will be monitored
- Egress mirroring: Traffic transmitted from the source port will be monitored
- Ingress and egress mirroring: Both received and transmitted traffic on the source port will be monitored.

With enhancements to SPAN, mirroring can be classified into three categories.

Port Mirroring

In port mirroring, source will be a port which could be a physical interface or a port channel. All the traffic on the source port will be mirrored to destination port. Either traffic received on the source port or traffic transmitted from the source port or both can be monitored.

VLAN Mirroring

In VLAN mirroring, the source is a VLAN identifier and the traffic received on all ports with the VLAN identifier matching source VLAN identifier are mirrored to destination port.

Rule Based Mirroring

In rule based mirroring, there is a set of matching criteria for the ingress traffic such as matching destination MAC address, matching frame type, and so on. The traffic matching the rules is mirrored to the destination port

Topology

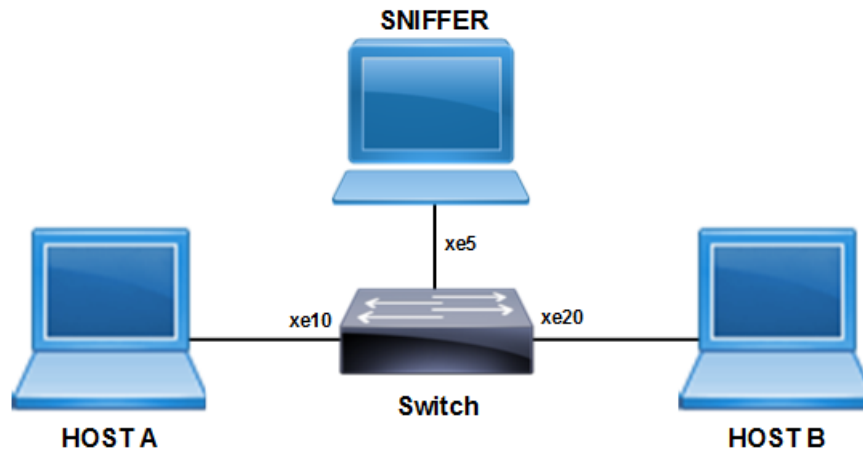

Figure 16-36: SPAN Topology

Port Mirroring Configuration

This example shows detailed configuration of port mirroring.

#configure terminal	Enter configure mode.
(config)# bridge 1 protocol mstp	Configure bridge 1 as MSTP bridge.
(config)# vlan 101-110 bridge 1 state enable	Configure VLANs.
(config)#interface xe10	Enter interface mode.
(config-if)# switchport	Configure interface as a layer 2 port.
(config-if)# bridge-group 1	Associate bridge to an interface.
(config-if)# switchport mode trunk	Configure port as a trunk.
(config-if)# switchport trunk allowed vlan add 101-110	Allow VLANs 101-110 on the interface.
(config-if)# no shutdown	Make interface admin up.
(config-if)#exit	Exit interface mode.
(config)#interface xe20	Enter interface mode.
(config-if)# switchport	Configure interface as a layer 2 port.
(config-if)# bridge-group 1	Associate bridge to an interface.
(config-if)# switchport mode trunk	Configure port as a trunk.
(config-if)# switchport trunk allowed vlan add 101-110	Allow VLANs 101-110 on the interface.
(config-if)# no shutdown	Make interface admin up.
(config-if)#exit	Exit interface mode.
(config)#interface xe5	Enter interface mode.
(config-if)# switchport	Configure interface as a layer 2 port.
(config-if)#exit	Exit interface mode.

(config)# monitor session 1	Enter monitor session configuration mode
(config-monitor)# destination interface xe5	Configure the interface as destination port
(config-monitor)# source interface xe10 both	Configure the source interface to mirror ingress as well as egress direction traffic
(config-monitor)# no shut	Activate monitor session
(config-monitor)#end	Exit monitor session configuration mode

Validation

Enter the below commands to confirm the configurations.

```
#show running-config monitor
!
monitor session 1
  source interface xe10 both
  destination interface xe5
  no shut
```

```
#show monitor session all
  session 1
```

```
-----
type           : local
state          : up
source intf    :
  tx           : xe10
  rx           : xe10
  both         : xe10
source VLANs   :
  rx           :
destination ports : xe5
filter count   :
```

Legend: f = forwarding enabled, l = learning enabled

VLAN and Rule Based Mirroring

This example shows detailed configuration of VLAN with rule based mirroring.

#configure terminal	Enter configure mode.
(config)# bridge 1 protocol mstp	Configure bridge 1 as MSTP bridge.
(config)# vlan 101-110 bridge 1 state enable	Configure VLANs
(config)#interface xe10	Enter interface mode.
(config-if)# switchport	Configure interface as a layer 2 port.
(config-if)# bridge-group 1	Associate bridge to an interface.
(config-if)# switchport mode trunk	Configure port as a trunk.
(config-if)# switchport trunk allowed vlan add 101-110	Allow VLANs 101-110 on the interface.
(config-if)# no shutdown	Make interface admin up
(config-if)#exit	Exit interface mode.
(config)#interface xe20	Enter interface mode.
(config-if)# switchport	Configure interface as a layer 2 port.
(config-if)# bridge-group 1	Associate bridge to an interface.
(config-if)# switchport mode trunk	Configure port as a trunk.
(config-if)# switchport trunk allowed vlan add 101-110	Allow VLANs 101-110 on the interface.
(config-if)# no shutdown	Make interface admin up
(config-if)#exit	Exit interface mode.
(config)#interface xe5	Enter interface mode.
(config-if)# switchport	Configure interface as a layer 2 port.
(config-if)#exit	Exit interface mode.
(config)# monitor session 1	Enter monitor session configuration mode
(config-monitor)# destination interface xe5	Configure the interface as destination port
(config-monitor)# source vlan 101	Configure source VLAN to be mirrored
(config-monitor)# filter src-mac host 0000.0000.0005	Configure the rule to match the source MAC
(config-monitor)# no shut	Activate monitor session
(config-monitor)#end	Exit monitor session configuration mode

Validation

Enter the below commands to confirm the configurations.

```
#show running-config monitor
!
monitor session 1
 source vlan 101
 destination interface xe5
```

```
10 filter src-mac host 0000.0000.0005
no shut
```

```
#show monitor session all
  session 1
```

```
-----
type           : local
state          : up
source intf    :
  tx           :
  rx           :
  both         :
source VLANs   :
  rx           : 101
destination ports : xe5
filter count   : 1
```

Legend: f = forwarding enabled, l = learning enabled

```
#show monitor session 1 filter
  session 1
```

```
-----
filter count   : 1

-----
match set 1
-----
source mac address : 0000.0000.0005 (host)
```

RSPAN Overview

When several switches need to be analyzed with a single centralized sniffer, remote switched port analyzer (RSPAN) is used. In RSPAN, all the mirrored traffic will be tagged with a RSPAN VLAN ID and forwarded to remote destination via a port called reflector port. Reflector port will have the same characteristics of a local destination port. RSPAN VLAN ID will be a dedicated VLAN for the monitoring purpose and will not participate in bridging. RSPAN destination switch will strip the RSPAN VLAN tag and send it the sniffer for analysis. RSPAN will have the same sub-categories as SPAN except that the mirrored traffic will be tagged with RSPAN VLAN header and forwarded to destination switch for analysis.

Topology

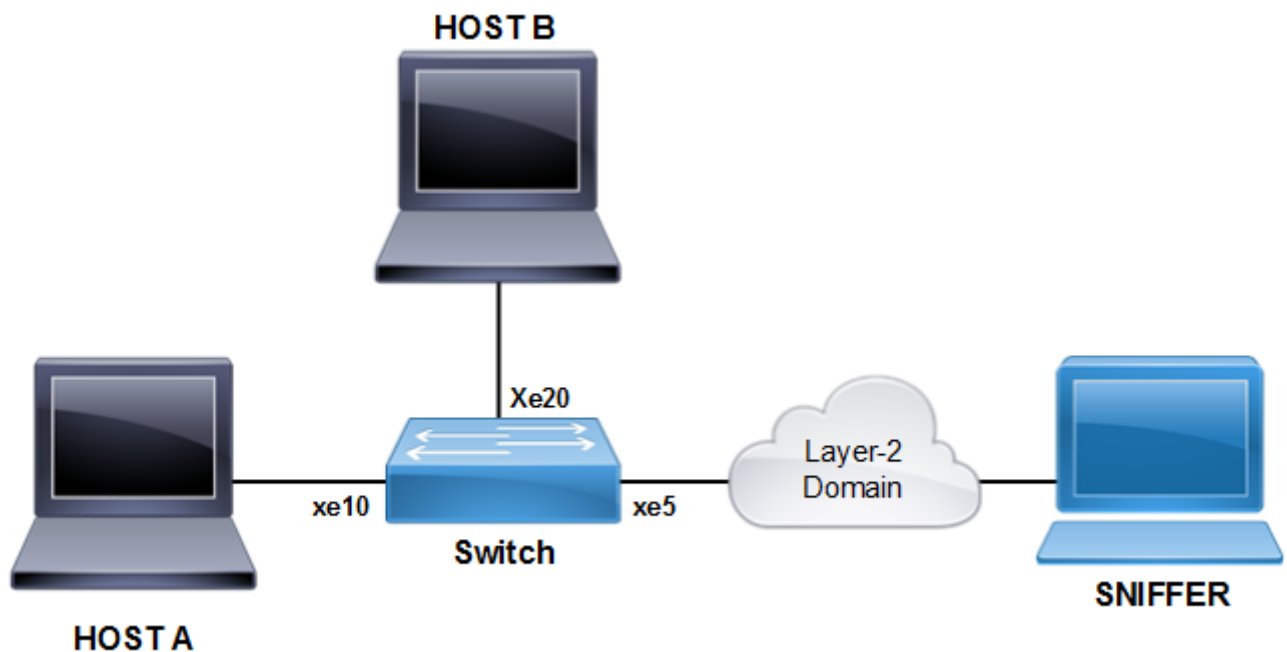

Figure 16-37: RSPAN Topology

Port Mirroring Configuration

This example shows detailed configuration of port mirroring.

#configure terminal	Enter configure mode.
(config)# bridge 1 protocol mstp	Configure bridge 1 as MSTP bridge.
(config)# vlan 101-110 bridge 1 state enable	Configure VLANs.
(config)#interface xe10	Enter interface mode.
(config-if)# switchport	Configure interface as a layer 2 port.
(config-if)# bridge-group 1	Associate bridge to an interface.
(config-if)# switchport mode trunk	Configure port as a trunk.

(config-if)# switchport trunk allowed vlan add 101-110	Allow VLANs 101-110 on the interface.
(config-if)# no shutdown	Make interface admin up.
(config-if)#exit	Exit interface mode.
(config)#interface xe20	Enter interface mode.
(config-if)# switchport	Configure interface as a layer 2 port.
(config-if)# bridge-group 1	Associate bridge to an interface.
(config-if)# switchport mode trunk	Configure port as a trunk.
(config-if)# switchport trunk allowed vlan add 101-110	Allow VLANs 101-110 on the interface.
(config-if)# no shutdown	Make interface admin up.
(config-if)#exit	Exit interface mode.
(config)#interface xe5	Enter interface mode.
(config-if)# switchport	Configure interface as a layer 2 port.
(config-if)#exit	Exit interface mode.
(config)# monitor session 1 type remote	Enter monitor session configuration mode.
(config-monitor)# destination remote vlan 100 reflector-port xe5	Configure the interface as remote destination port
(config-monitor)# source interface xe10 both	Configure the source interface to mirror ingress as well as egress direction traffic.
(config-monitor)# no shut	Activate monitor session.
(config-monitor)#end	Exit monitor session configuration mode.

Validation

Enter the commands below to confirm the configurations

```
#show running-config monitor
!
monitor session 1 type remote
  source interface xe10 both
  destination remote vlan 100 reflector-port xe5
  no shut
```

```
#show monitor session all
  session 1
-----
type           : remote
state          : up
source intf    :
  tx           : xe10
  rx           : xe10
  both         : xe10
source VLANs   :
  rx           :
rspan VLAN     : 100
```

reflector ports : xe5
filter count :

Legend: f = forwarding enabled, l = learning enabled

VLAN and Rule Based Mirroring Configuration

This example shows detailed configuration of VLAN with rule based mirroring.

#configure terminal	Enter configure mode.
(config)# bridge 1 protocol mstp	Configure bridge 1 as MSTP bridge.
(config)# vlan 101-110 bridge 1 state enable	Configure VLANs.
(config)#interface xe10	Enter interface mode.
(config-if)# switchport	Configure interface as a layer 2 port.
(config-if)# bridge-group 1	Associate bridge to an interface.
(config-if)# switchport mode trunk	Configure port as a trunk.
(config-if)# switchport trunk allowed vlan add 101-110	Allow VLANs 101-110 on the interface.
(config-if)# no shutdown	Make interface admin up.
(config-if)#exit	Exit interface mode.
(config)#interface xe20	Enter interface mode.
(config-if)# switchport	Configure interface as a layer 2 port.
(config-if)# bridge-group 1	Associate bridge to an interface.
(config-if)# switchport mode trunk	Configure port as a trunk.
(config-if)# switchport trunk allowed vlan add 101-110	Allow VLANs 101-110 on the interface.
(config-if)# no shutdown	Make interface admin up.
(config-if)#exit	Exit interface mode.
(config)#interface xe5	Enter interface mode.
(config-if)# switchport	Configure interface as a layer 2 port.
(config-if)#exit	Exit interface mode.
(config)# monitor session 1 type remote	Enter monitor session configuration mode.
(config-monitor)# destination remote vlan 100 reflector-port xe5	Configure the interface as remote destination port.
(config-monitor)# source vlan 101	Configure source VLAN to be mirrored.
(config-monitor)# filter src-mac host 0000.0000.0005	Configure the rule to match the source MAC.
(config-monitor)# no shut	Activate monitor session.
(config-monitor)#end	Exit monitor session configuration mode.

Validation

Enter the commands below to confirm the configuration.

```
#show running-config monitor
!
monitor session 1 type remote
source vlan 101
```

```
destination remote vlan 100 reflector-port xe5
10 filter src-mac host 0000.0000.0005
no shut
```

```
#show monitor session all
  session 1
```

```
-----
type           : remote
state          : up
source intf    :
  tx           :
  rx           :
  both         :
source VLANs   :
  rx           : 101
rspan VLAN     : 100
reflector ports : xe5
filter count   : 1
```

Legend: f = forwarding enabled, l = learning enabled

```
#show monitor session 1 filter
  session 1
```

```
-----
filter count   : 1
```

```
-----
match set 1
```

```
-----
source mac address : 0000.0000.0005 (host)
```

CHAPTER 17 Port Security Configuration

The Port Security feature allows network administrators to block unauthorized access to the network. Network administrators can configure each port of the switch to allow network access from only secured MACs, so that the switch forwards traffic from only secured MACs.

Users can limit each port's ingress traffic by limiting MAC addresses (source MACs) that are used to send traffic into ports. Port Security enables users to configure the maximum number of secured MACs for each port. Switches learn secured MAC dynamically (learned by switch during traffic inflow) or statically (User configured MACs). Dynamically Learned or statically programmed MAC addresses cannot exceed the maximum number of secured MACs configured for a particular port. Once the switch reaches the maximum limit for secured MACs, traffic from all other MAC addresses are dropped.

The violated MACs are logged in syslog messages. Refer to `cpu queue portsec-drop` using the command `show interface cpu counter queue-stats` for information on the number of violated MACs.

Note: When configuring port-security over MLAG, configure the port-security in both MASTER and SLAVE MLAG nodes.

Note: When a port-security limit 2X is configured on MLAG (X in Master and X in Slave), the total number of secured MACs could be less than 2X if most of the traffic is load-balanced with one MLAG node which is not capable of securing more than X MACs even if peer MLAG node has secured less than X MACs.

Secured MACs Learned Dynamically



Figure 17-38: Secured MACs learned dynamically

Send Layer 2 traffic with incremental source MAC of 100 and with VLAN 100 from IXIA1. Because the maximum limit is configured to 3, only 3 secure MAC addresses will be learned by SW1.

SW1

<code>#configure terminal</code>	Enter configure mode.
<code>(config)#hostname SW1</code>	Set the host name
<code>(config)#bridge 1 protocol rstp vlan-bridge</code>	Create a RSTP VLAN bridge on customer side
<code>(config)#vlan database</code>	Enter vlan database mode.
<code>(config)#vlan 2-200 bridge 1 state enable</code>	Configure VLAN for the bridge
<code>(config-vlan)#exit</code>	Exit from vlan database mode.
<code>(config)#interface ge1</code>	Enter interface mode
<code>(config-if)#switchport</code>	Make the interface Layer 2
<code>(config-if)#bridge-group 1</code>	Associate the interface to bridge
<code>(config-if)#switchport mode hybrid</code>	Configure the mode as trunk
<code>(config-if)#switchport hybrid allowed vlan all</code>	Configure allowed VLAN all on the interface

(config-if)#switchport port-security	Enable port security mode dynamic
(config-if)#switchport port-security maximum 3	Limit secure MAC to 3 mac addresses.
(config-if)#commit	Commit the candidate configuration to the running configuration.
(config-if)#exit	Exit interface mode
(config)#interface ge2	Enter interface mode
(config-if)#switchport	Make the interface Layer 2
(config-if)#bridge-group 1	Associate the interface to bridge
(config-if)#switchport mode hybrid	Configure the mode as trunk
(config-if)#switchport hybrid allowed vlan all	Configure allowed VLAN all on the interface
(config-if)#commit	Commit the candidate configuration to the running configuration.
(config-if)#exit	Exit interface mode
(config)#logging monitor 7	Enable logging level as 7 for debugging
(config-if)#commit	Commit the candidate configuration to the running configuration.
(config-if)#exit	Exit interface mode

Validation

Validation commands are `show port-security`, `show port-security interface <ifname>`, `show mac address-table count bridge 1`, `show bridge`, and `show mac address-table bridge 1`.

```
SW1#show port-security
Port      port-security mode  MAC limit  CVLAN  SVLAN  static secure MAC
-----+-----+-----+-----+-----+-----
ge1       dynamic              3
```

```
SW1#show port-security interface ge1
Port Security Mode      : Dynamic
Secure MAC limit       : 3
Static Secure MAC list :
CVLAN  SVLAN  MAC Address
-----+-----+-----
```

```
SW1#show mac address-table count bridge 1
MAC Entries for all vlans:
Dynamic Address Count: 3
Static (User-defined) Unicast MAC Address Count: 0
Static (User-defined) Multicast MAC Address Count: 0
Total MAC Addresses in Use: 3
```

```
SW1#show bridge
Ageout time is global and if something is configured for vxlan then it will be affected here also
```

```
Bridge      CVLAN  SVLAN  BVLAN  Port          MAC Address          FWD  Time-out
-----+-----+-----+-----+-----+-----+-----+-----
```

1	100	ge1	0000.0300.0500	1	100
1	100	ge1	0000.0300.055b	1	100
1	100	ge1	0000.0300.055c	1	100

SW1#show mac address-table bridge 1

CVLAN	SVLAN	MAC Address	Type	Ports	Port-security
100		0000.0300.0500	dynamic	ge1	Enable
100		0000.0300.055b	dynamic	ge1	Enable
100		0000.0300.055c	dynamic	ge1	Enable

Secured MAC Addresses Learned Statically

1. Stop the traffic from IXIA1 and do a `clear mac address-table dynamic bridge 1` on SW1.
2. Verify all dynamic secured MAC addresses are cleared.
3. Configure 3 static secure MAC addresses using the commands below in port security configured interface.
4. Try to add a fourth static secure MAC address.
5. Verify operator log message is displayed, saying “port security mac limit reached.”

<code>(config)#interface gel</code>	Enter interface mode
<code>(config-if)#switchport port-security mac-address 0000.0000.aaaa vlanId 100</code>	Add static secure MAC address for VLAN 100 in interface mode
<code>(config-if)#switchport port-security mac-address 0000.0000.aaab vlanId 100</code>	Add static secure MAC address for VLAN 100 in interface mode
<code>(config-if)#switchport port-security mac-address 0000.0000.aaac vlanId 100</code>	Add static secure MAC address for VLAN 100 in interface mode
<code>(config-if)#commit</code>	Commit the candidate configuration to the running configuration.
<code>(config-if)#exit</code>	Exit interface mode

Validation

```
SW1#show port-security
Port    port-security mode  MAC limit  CVLAN   SVLAN   static secure MAC
-----+-----+-----+-----+-----+-----
gel     dynamic             3          100    100    0000.0000.aaaa
                100    0000.0000.aaab
                100    0000.0000.aaac
```

```
SW1#show port-security interface gel
Port Security Mode      : Dynamic
Secure MAC limit       : 3
Static Secure MAC list :
CVLAN  SVLAN  MAC Address
-----+-----+-----
100    0000.0000.aaaa
100    0000.0000.aaab
100    0000.0000.aaac
```

```
SW1#show mac address-table count bridge 1
MAC Entries for all vlans:
Dynamic Address Count: 0
Static (User-defined) Unicast MAC Address Count: 3
Static (User-defined) Multicast MAC Address Count: 0
Total MAC Addresses in Use: 3
```

```
SW1#show bridge
```

Ageout time is global and if something is configured for vxlan then it will be affected here also

Bridge	CVLAN	SVLAN	BVLAN	Port	MAC Address	FWD	Time-out
1	100			ge1	0000.0000.aaaa	1	-
1	100			ge1	0000.0000.aaab	1	-
1	100			ge1	0000.0000.aaac	1	-

SW1#show mac address-table bridge 1

CVLAN	SVLAN	MAC Address	Type	Ports	Port-security
100		0000.0000.aaaa	static	ge1	Enable
100		0000.0000.aaab	static	ge1	Enable
100		0000.0000.aaac	static	ge1	Enable

SW1#

Remove the port-security configuration method using the two commands below:

config)#interface ge1	Enter interface mode
(config-if)#no switchport port-security	Set the port-security method to static.
(config-if)#commit	Commit the candidate configuration to the running configuration.
(config-if)#exit	Exit interface mode

Static Mode

Use the below command to configure the port-security method to static and configure static secure MAC addresses using the commands in static port-security method, below.

(config)#interface ge1	Enter interface mode
(config-if)#switchport port-security static	Set the port-security method as static.
(config-if)#switchport port-security max 3	Limit static secure MAC to 3 mac addresses.
(config-if)#switchport port-security mac-address 0000.0000.aaaa vlanId 100	Add static secure MAC address for VLAN 100 in interface mode.
(config-if)#switchport port-security mac-address 0000.0000.aaab vlanId 100	Add static secure MAC address for VLAN 100 in interface mode.
(config-if)#switchport port-security mac-address 0000.0000.aaac vlanId 100	Add static secure MAC address for VLAN 100 in interface mode .
(config-if)#commit	Commit the candidate configuration to the running configuration.
(config-if)#exit	Exit interface mode

Verify the 3 secure static MAC addresses are added in interface ge1 using show running-config and also verify the port-security method should be static using below show commands.

Validation

```
SW1#show running-config interface gel
interface gel
  switchport
  bridge-group 1
  switchport mode hybrid
  switchport mode hybrid acceptable-frame-type all
  switchport hybrid allowed vlan all
  switchport port-security static
  switchport port-security maximum 3
  switchport port-security mac-address 0000.0000.aaaa vlanId 100
  switchport port-security mac-address 0000.0000.aaab vlanId 100
  switchport port-security mac-address 0000.0000.aaac vlanId 100
```

```
SW1#show port-security
Port      port-security mode  MAC limit  CVLAN   SVLAN   static secure MAC
-----+-----+-----+-----+-----+-----+-----+
gel      static              3          100     100     0000.0000.aaaa
          100                0000.0000.aaab
          100                0000.0000.aaac
```

```
SW1#show port-security interface gel
Port Security Mode      : Static
Secure MAC limit       : 3
Static Secure MAC list :
CVLAN  SVLAN  MAC Address
-----+-----+-----+
100    100    0000.0000.aaaa
100    100    0000.0000.aaab
100    100    0000.0000.aaac
```

```
SW1#show mac address-table count bridge 1
MAC Entries for all vlans:
Dynamic Address Count: 0
Static (User-defined) Unicast MAC Address Count: 3
Static (User-defined) Multicast MAC Address Count: 0
Total MAC Addresses in Use: 3
```

```
SW1#show bridge
Ageout time is global and if something is configured for vxlan then it will be affected here also
```

Bridge	CVLAN	SVLAN	BVLAN	Port	MAC Address	FWD	Time-out
1	100			gel	0000.0000.aaaa	1	-
1	100			gel	0000.0000.aaab	1	-
1	100			gel	0000.0000.aaac	1	-

```
SW1#show mac address-table bridge 1
CVLAN  SVLAN  MAC Address      Type      Ports      Port-security
```

```
-----+-----+-----+-----+-----+-----
100          0000.0000.aaaa  static   ge1      Enable
100          0000.0000.aaab  static   ge1      Enable
100          0000.0000.aaac  static   ge1      Enable
```

Configure one more static secure MAC address on interface ge1 and try to verify “port security mac limit reached” operator log message is displayed.

Start sending Layer-2 traffic with incremental source MAC of 100 and with VLAN 100 from IXIA1, and verify no dynamic secure MAC addresses are being learned using all the validation commands used.

CHAPTER 18 Private VLAN Configuration

A private VLANs (PVLAN) splits a primary VLAN domain into multiple isolated broadcast sub-domains. PVLAN, also known as port isolation, is a technique where a VLAN contains switch ports that are restricted such that they can only communicate with a given uplink.

Topology

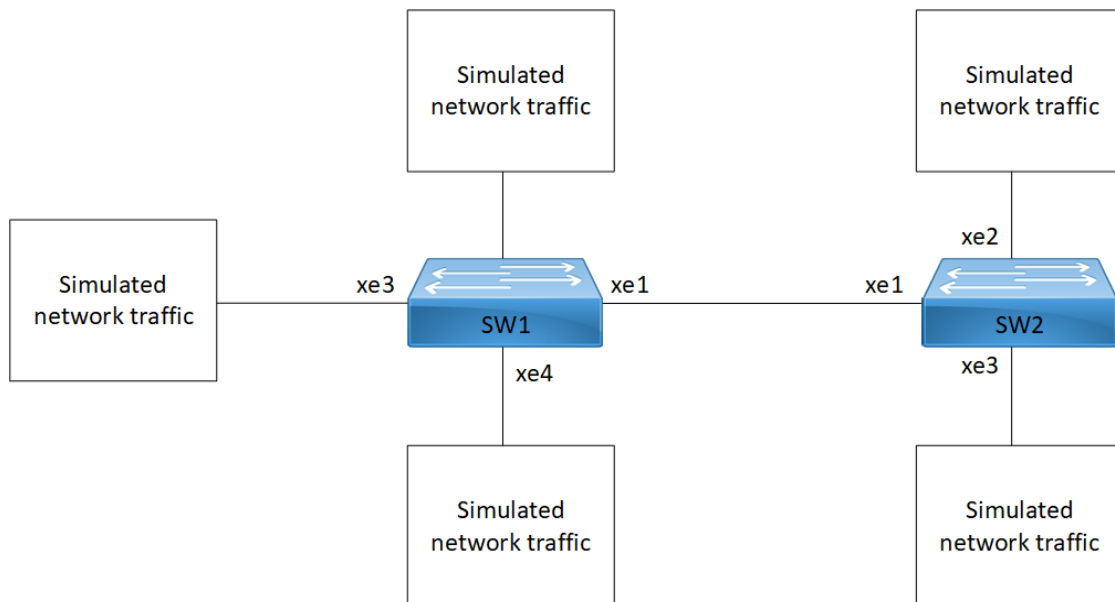

Figure 18-39: PVLAN configuration

Configure PVLAN Trunk and Promiscuous Trunk Port

SW1

SW1#configure terminal	Enter configuration mode
SW1(config)#bridge 1 protocol ieee vlan-bridge	Create bridge
SW1(config)#vlan database	Enter VLAN configuration mode
SW1(config-vlan)#vlan 10 bridge 1 state enable	Create VLAN 10
SW1(config-vlan)#vlan 20 bridge 1 state enable	Create VLAN 20
SW1(config-vlan)#vlan 100 bridge 1 state enable	Create VLAN 100
SW1(config-vlan)#private-vlan 10 isolated bridge 1	Configure VLAN 10 as isolated VLAN

SW1(config-vlan)#private-vlan 20 community bridge 1	Configure VLAN 20 as community VLAN
SW1(config-vlan)#private-vlan 100 primary bridge 1	Configure VLAN 100 as primary VLAN
SW1(config-vlan)#private-vlan 100 association add 10 bridge 1	Associate secondary isolated VLAN 10 with primary VLAN 100
SW1(config-vlan)#private-vlan 100association add 20 bridge 1	Associate secondary community VLAN 20 with primary VLAN 100
SW1(config-vlan)#exit	Exit VLAN configuration mode
SW1(config)#interface xe1	Enter interface configuration mode for xe1
SW1(config-if)#switchport	Configure switchport
SW1(config-if)#bridge-group 1	Associate interface with bridge-group 1
SW1(config-if)#switchport mode trunk	Set the switching characteristics of this interface as trunk
SW1(config-if)#switchport trunk allowed vlan add 10,20,100	Configure VLAN 10,20,100 (primary, secondary VLANs)
SW1(config-if)#exit	Exit interface mode
SW1(config)#interface xe3	Enter interface configuration mode for xe3
SW1(config-if)#switchport	Configure switchport
SW1(config-if)#bridge-group 1	Associate interface with bridge-group 1
SW1(config-if)#switchport mode trunk	Set the switching characteristics of this interface as trunk
SW1(config-if)#switchport mode private-vlan promiscuous	Configure the interface as promiscuous port for private-vlan
SW1(config-if)#switchport trunk allowed vlan add 100	Configure VLAN 100 (primary VLAN)
SW1(config-if)#switchport private-vlan mapping 100 add 10	Associate port with primary and secondary VLAN of private-vlan
SW1(config-if)#switchport private-vlan mapping 100 add 20	Associate port with primary and secondary VLAN of private-vlan
SW1(config-if)#exit	Exit interface mode
SW1(config)#interface xe4	Enter interface configuration mode for xe4
SW1(config-if)#switchport	Configure switchport
SW1(config-if)#bridge-group 1	Associate interface with bridge-group 1
SW1(config-if)#switchport mode access	Set the switching characteristics of this interface as access
SW1(config-if)#switchport mode private-vlan host	Configure the interface as host port for private-vlan
SW1(config-if)#switchport access vlan 20	Configure VLAN 20 (community VLAN)
SW1(config-if)#switchport private-vlan host- association 100 add 20	Associate port with primary and secondary VLAN of private-vlan
SW1(config-if)#exit	Exit interface mode
SW1(config)#interface xe2	Enter interface configuration mode for xe2
SW1(config-if)#switchport	Configure switchport
SW1(config-if)#bridge-group 1	Associate interface with bridge-group 1
SW1(config-if)#switchport mode access	Set the switching characteristics of this interface as access
SW1(config-if)#switchport mode private-vlan host	Configure the interface as host port for private-vlan

SW1(config-if)#switchport access vlan 10	Configure VLAN 10 (isolated VLAN)
SW1(config-if)#switchport private-vlan host-association 100 add 10	Associate port with primary and secondary VLAN of private-vlan
SW1(config-if)#exit	Exit interface mode
SW1(config)#commit	Commit the configure on the node.
SW1(config)#exit	Exit configuration mode

SW2

SW2#configure terminal	Enter configuration mode
SW2(config)#bridge 1 protocol ieee vlan-bridge	Create bridge
SW2(config)#vlan database	Enter VLAN configuration mode
SW2(config-vlan)#vlan 10 bridge 1 state enable	Create VLAN 10
SW2(config-vlan)#vlan 20 bridge 1 state enable	Create VLAN 20
SW2(config-vlan)#vlan 100 bridge 1 state enable	Create VLAN 100
SW2(config-vlan)#private-vlan 10 isolated bridge 1	Configure VLAN 10 as isolated VLAN
SW2(config-vlan)#private-vlan 20 community bridge 1	Configure VLAN 20 as community VLAN
SW2(config-vlan)#private-vlan 100 primary bridge 1	Configure VLAN 100 as primary VLAN
SW1(config-vlan)#private-vlan 100 association add 10 bridge 1	Associate secondary isolated VLAN 10 with primary VLAN 100
SW1(config-vlan)#private-vlan 100 association add 20 bridge 1	Associate secondary community VLAN 20 with primary VLAN 100
SW2(config-vlan)#exit	Exit VLAN configuration mode
SW2(config)#interface xe1	Enter interface configuration mode for xe1
SW2(config-if)#switchport	Configure switchport
SW2(config-if)#bridge-group 1	Associate interface with bridge-group 1
SW2(config-if)#switchport mode trunk	Set the switching characteristics of this interface as trunk
SW2(config-if)#switchport trunk allowed vlan add 10,20,100	Configure VLAN 10,20,100 (primary, secondary VLANs)
SW2(config-if)#exit	Exit interface mode
SW2(config)#interface xe2	Enter interface configuration mode for xe2
SW2(config-if)#switchport	Configure switchport
SW2(config-if)#bridge-group 1	Associate interface with bridge-group 1
SW2(config-if)#switchport mode access	Set the switching characteristics of this interface as access
SW2(config-if)#switchport mode private-vlan host	Configure the interface as host port for private-vlan
SW2(config-if)#switchport access vlan 10	Configure VLAN 10 (isolated VLAN)
SW2(config-if)#switchport private-vlan host-association 100 add 10	Associate port with primary and secondary VLAN of private-vlan

SW2(config-if)#exit	Exit interface mode
SW2(config)#interface xe3	Enter interface configuration mode for xe3
SW2(config-if)#switchport	Configure switchport
SW2(config-if)#bridge-group 1	Associate interface with bridge-group 1
SW2(config-if)#switchport mode access	Set the switching characteristics of this interface as access
SW2(config-if)#switchport mode private-vlan host	Configure the interface as host port for private-vlan
SW2(config-if)#switchport access vlan 20	Configure VLAN 20 (community VLAN)
SW2(config-if)#switchport private-vlan host-association 100 add 20	Associate port with primary and secondary VLAN of private-vlan
SW2(config-if)#exit	Exit interface mode
SW2(config)#commit	Commit the configure on the node.
SW2(config)#exit	Exit configuration mode

Validation

```
SW1#show vlan private-vlan bridge 1
PRIMARY          SECONDARY          TYPE                INTERFACES
-----          -
          100          10          isolated          xe1,xe2,
          100          20          community          xe1,xe4,
SW1#
SW2#show vlan private-vlan bridge 1
PRIMARY          SECONDARY          TYPE                INTERFACES
-----          -
          100          10          isolated          xe1,xe2,
          100          20          community          xe1,xe3,
SW2#
```

Configure PVLAN Trunk and Promiscuous Access Port

SW1

SW1#configure terminal	Enter configuration mode
SW1(config)#bridge 1 protocol ieee vlan-bridge	Create bridge
SW1(config)#vlan database	Enter VLAN configuration mode
SW1(config-vlan)#vlan 10 bridge 1 state enable	Create VLAN 10
SW1(config-vlan)#vlan 20 bridge 1 state enable	Create VLAN 20
SW1(config-vlan)#vlan 100 bridge 1 state enable	Create VLAN 100

SW1(config-vlan)#private-vlan 10 isolated bridge 1	Configure VLAN 10 as isolated VLAN
SW1(config-vlan)#private-vlan 20 community bridge 1	Configure VLAN 20 as community VLAN
SW1(config-vlan)#private-vlan 100 primary bridge 1	Configure VLAN 100 as primary VLAN
SW1(config-vlan)#private-vlan 100 association add 10 bridge 1	Associate secondary isolated VLAN 10 with primary VLAN 100
SW1(config-vlan)#private-vlan 100 association add 20 bridge 1	Associate secondary community VLAN 20 with primary VLAN 100
SW1(config-vlan)#exit	Exit VLAN configuration mode
SW1(config)#interface xe1	Enter interface configuration mode for xe1
SW1(config-if)#switchport	Configure switchport
SW1(config-if)#bridge-group 1	Associate interface with bridge-group 1
SW1(config-if)#switchport mode trunk	Set the switching characteristics of this interface as trunk
SW1(config-if)#switchport trunk allowed vlan add 10,20,100	Configure VLAN 10,20,100 (primary, secondary VLANs)
SW1(config-if)#exit	Exit interface mode
SW1(config)#interface xe3	Enter interface configuration mode for xe3
SW1(config-if)#switchport	Configure switchport
SW1(config-if)#bridge-group 1	Associate interface with bridge-group 1
SW1(config-if)#switchport mode access	Set the switching characteristics of this interface as access
SW1(config-if)#switchport mode private-vlan promiscuous	Configure the interface as promiscuous port for private-vlan
SW1(config-if)#switchport access vlan 100	Configure VLAN 100 (primary VLAN)
SW1(config-if)#switchport private-vlan mapping 100 add 10	Associate port with primary and secondary VLAN of private-vlan
SW1(config-if)#switchport private-vlan mapping 100 add 20	Associate port with primary and secondary VLAN of private-vlan
SW1(config-if)#exit	Exit interface mode
SW1(config)#interface xe4	Enter interface configuration mode for xe4
SW1(config-if)#switchport	Configure switchport
SW1(config-if)#bridge-group 1	Associate interface with bridge-group 1
SW1(config-if)#switchport mode access	Set the switching characteristics of this interface as access
SW1(config-if)#switchport mode private-vlan host	Configure the interface as host port for private-vlan
SW1(config-if)#switchport access vlan 20	Configure VLAN 20 (community VLAN)
SW1(config-if)#switchport private-vlan host-association 100 add 20	Associate port with primary and secondary VLAN of private-vlan
SW1(config-if)#exit	Exit interface mode
SW1(config)#interface xe2	Enter interface configuration mode for xe2
SW1(config-if)#switchport	Configure switchport
SW1(config-if)#bridge-group 1	Associate interface with bridge-group 1
SW1(config-if)#switchport mode access	Set the switching characteristics of this interface as access

SW1(config-if)#switchport mode private-vlan host	Configure the interface as host port for private-vlan
SW1(config-if)#switchport access vlan 10	Configure VLAN 10 (isolated VLAN)
SW1(config-if)#switchport private-vlan host-association 100 add 10	Associate port with primary and secondary VLAN of private-vlan
SW1(config-if)#exit	Exit interface mode
SW1(config)#commit	Commit the configure on the node.
SW1(config)#exit	Exit configuration mode

SW2

SW2#configure terminal	Enter configuration mode
SW2(config)#bridge 1 protocol ieee vlan-bridge	Create bridge
SW2(config)#vlan database	Enter VLAN configuration mode
SW2(config-vlan)#vlan 10 bridge 1 state enable	Create VLAN 10
SW2(config-vlan)#vlan 20 bridge 1 state enable	Create VLAN 20
SW2(config-vlan)#vlan 100 bridge 1 state enable	Create VLAN 100
SW2(config-vlan)#private-vlan 10 isolated bridge 1	Configure VLAN 10 as isolated VLAN
SW2(config-vlan)#private-vlan 20 community bridge 1	Configure VLAN 20 as community VLAN
SW2(config-vlan)#private-vlan 100 primary bridge 1	Configure VLAN 100 as primary VLAN
SW1(config-vlan)#private-vlan 100 association add 10 bridge 1	Associate secondary isolated VLAN 10 with primary VLAN 100
SW1(config-vlan)#private-vlan 100 association add 20 bridge 1	Associate secondary community VLAN 20 with primary VLAN 100
SW2(config-vlan)#exit	Exit VLAN configuration mode
SW2(config)#interface xe1	Enter interface configuration mode for xe1
SW2(config-if)#switchport	Configure switchport
SW2(config-if)#bridge-group 1	Associate interface with bridge-group 1
SW2(config-if)#switchport mode trunk	Set the switching characteristics of this interface as trunk
SW2(config-if)#switchport trunk allowed vlan add 10,20,100	Configure VLAN 10,20,100 (primary, secondary VLANs)
SW2(config-if)#exit	Exit interface mode
SW2(config)#interface xe2	Enter interface configuration mode for xe2
SW2(config-if)#switchport	Configure switchport
SW2(config-if)#bridge-group 1	Associate interface with bridge-group 1
SW2(config-if)#switchport mode access	Set the switching characteristics of this interface as access
SW2(config-if)#switchport mode private-vlan host	Configure the interface as host port for private-vlan
SW2(config-if)#switchport access vlan 10	Configure VLAN 10 (isolated VLAN)

SW2(config-if)#switchport private-vlan host-association 100 add 10	Associate port with primary and secondary VLAN of private-vlan
SW2(config-if)#exit	Exit interface mode
SW2(config)#interface xe3	Enter interface configuration mode for xe3
SW2(config-if)#switchport	Configure switchport
SW2(config-if)#bridge-group 1	Associate interface with bridge-group 1
SW2(config-if)#switchport mode access	Set the switching characteristics of this interface as access
SW2(config-if)#switchport mode private-vlan host	Configure the interface as host port for private-vlan
SW2(config-if)#switchport access vlan 20	Configure VLAN 20 (community VLAN)
SW2(config-if)#switchport private-vlan host-association 100 add 20	Associate port with primary and secondary VLAN of private-vlan
SW2(config-if)#exit	Exit interface mode
SW2(config)#commit	Commit the configure on the node.
SW2(config)#exit	Exit configuration mode

Validation

```
SW1#show vlan private-vlan bridge 1
```

PRIMARY	SECONDARY	TYPE	INTERFACES
100	10	isolated	xe1, xe2,
100	20	community	xe1, xe4,

```
SW2#show vlan private-vlan bridge 1
```

PRIMARY	SECONDARY	TYPE	INTERFACES
100	10	isolated	xe1, xe2,
100	20	community	xe1, xe3,

```
SW2#
```

Traffic Validation

Configure Host trunk and promiscuous trunk configurations on SW1 and SW2

1. Send untagged traffic from SW1 xe3 (promiscuous port), traffic should forward to interfaces xe1,xe2, and xe4. On SW2, traffic should receive from xe1 and forward through xe2 and xe3.

```
SW1#show interface counters rate mbps
```

Interface	Rx mbps	Rx pps	Tx mbps	Tx pps
xe1	0.00	0	86.49	84462
xe2	0.00	0	86.49	84462
xe3	86.49	84462	0.00	0
xe4	0.00	0	86.49	84462

```
SW2#show interface counters rate mbps
```

Interface	Rx mbps	Rx pps	Tx mbps	Tx pps
xe1	86.49	84462	0.00	0
xe2	0.00	0	86.49	84462
xe3	0.00	0	86.49	84462

2. Send untagged traffic from SW1 xe2 (isolated port), traffic should forward to interfaces xe3 and xe1. On SW2, traffic should receive from xe1 and remaining ports should be 0.

SW1#show interface counters rate mbps

Interface	Rx mbps	Rx pps	Tx mbps	Tx pps
xe1	0.00	0	86.49	84462
xe2	86.49	84462	0.00	0
xe3	0.00	0	86.49	84462
xe4	0.00	0	0.00	0

SW2#show interface counters rate mbps

Interface	Rx mbps	Rx pps	Tx mbps	Tx pps
xe1	86.49	84462	0.00	0
xe2	0.00	0	0.00	0
xe3	0.00	0	0.00	0

3. Send untagged traffic from SW1 xe4 (community port), traffic should forward through interfaces xe3 and xe1. On SW2, traffic should receive from xe1 and forward to xe3.

SW1#show interface counters rate mbps

Interface	Rx mbps	Rx pps	Tx mbps	Tx pps
xe1	0.00	0	86.49	84462
xe2	0.00	0	0.00	0
xe3	0.00	0	86.49	84462
xe4	86.49	84462	0.00	0

SW2#show interface counters rate mbps

Interface	Rx mbps	Rx pps	Tx mbps	Tx pps
xe1	86.49	84462	0.00	0
xe2	0.00	0	0.00	0
xe3	0.00	0	86.49	84462

CHAPTER 19 Layer 2 Subinterface Configuration

This chapter contains examples of configuring L2 Subinterfaces.

A single physical interface when required to handle multiple VLAN traffic, can be divided into multiple logical interfaces called sub-interfaces.

All sub-interfaces under the physical port will use their parent port for sending and receiving data.

Sub-interfaces let you divide a physical interface into multiple logical interfaces that are tagged with different VLAN identifiers. Because VLANs allow you to keep traffic separate on a given physical interface, you can increase the number of interfaces available to your network without adding additional physical interfaces.

Note: Refer to the release note for features supported by L2 Sub-interface.

Topology

Below figure shows an example of subinterface configuration for one node with cross-connect. In this example, there is one router R1 with 2 connections

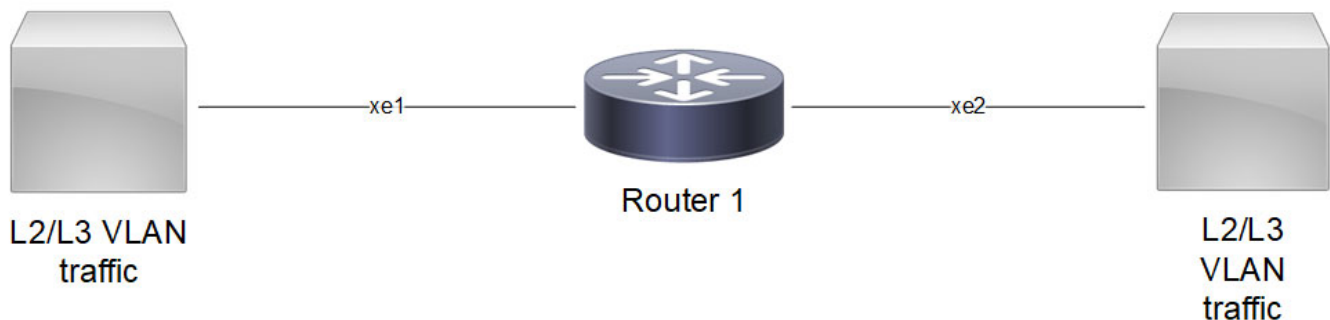

The xe1.10 and xe2.10 subinterface is created on R1

Sub-interface can be created over physical or LAG interfaces.

Note: Use `dot1ad ethertype (0x8100 | 0x88a8 | 0x9100 | 0x9200)` command to configure the service-tpid value on parent port of a subinterface. By this the tpid used for service tag for a subinterface may be inherited from the one applied to parent interface.

Note: For any dot1ad subinterface to be functional, `dot1ad ethertype` should be set to desired value as 0x88a8/0x9100/0x9200. Default value is 8100. To verify the ethertype value for the interface use `show interface <subinterface>` command.

Configure L2 Subinterface with cross-connect

<code>#configure terminal</code>	Enter configure mode.
<code>(config)#interface xe1</code>	Enter interface mode

(config-if)# dot1ad ethertype 0x88a8	Configure interface with tpid value as 88a8
(config-if)#exit	Exit interface mode.
(config)#interface xe1.10 switchport	Creates a L2 sub-interface as xe1.10
(config-if)#encapsulation dot1q 10	Configure the encapsulation as dot1q matching vlan 10
(config-if)#exit	Exit interface mode.
(config)#interface xe2	Enter interface mode
(config-if)# dot1ad ethertype 0x88a8	Configure interface with tpid value as 88a8
(config-if)#exit	Exit interface mode.
(config-if)#interface xe2.10 switchport	Creates a L2 sub-interface as xe2.10
(config-if)#encapsulation dot1q 10	Configure the encapsulation as dot1q matching vlan 10
(config-if)#exit	Exit interface mode.
(config)# cross-connect CC1	Create cross-connect with name CC1
(config-xc)# interface xe1.10	Attach interface xe1.10
(config-xc)# interface xe2.10	Attach interface xe2.10
(config-xc)#exit	Exit cross-connect mode.
(config)#commit	Commit the transaction.

Configure L2 Subinterface(Double-Push) with cross-connect

#configure terminal	Enter configure mode.
(config)#interface xe1.10 switchport	Creates a L2 sub-interface as xe1.10
(config-if)#encapsulation untagged	Configure the encapsulation as untagged
(config-if)# rewrite push 0x8100 200 inner-dot1q 200	Configure rewrite push with inner vlan 200 and outer vlan 200
(config-if)#exit	Exit interface mode
(config)#interface xe2.10 switchport	Creates a L2 sub-interface as xe2.10
(config-if)# encapsulation dot1ad 200 inner-dot1q 200	Configure the encapsulation with inner vlan 200 and outer vlan 200
(config-if)#exit	Exit interface mode
(config)# cross-connect CC1	Create cross-connect with name CC1
(config-xc)# interface xe1.10	Attach interface xe1.10
(config-xc)# interface xe2.10	Attach interface xe2.10
(config-xc)#exit	Exit cross-connect mode.
(config)#commit	Commit the transaction.

Configure L2 Subinterface(Double-Pop) with cross-connect

#configure terminal	Enter configure mode.
(config)##interface xe1.10 switchport	Creates a L2 sub-interface as xe1.10

<code>(config-if)#encapsulation untagged</code>	Configure the encapsulation as untagged
<code>(config-if)#exit</code>	Exit interface mode
<code>(config)#interface xe2.10 switchport</code>	Creates a L2 sub-interface as xe2.10
<code>(config-if)# encapsulation dot1ad 200 inner-dot1q 200</code>	Configure the encapsulation with inner vlan 200 and outer vlan 200
<code>(config-if)# rewrite pop-2tag</code>	Configure rewrite pop-2tag
<code>(config-if)#exit</code>	Exit interface mode
<code>(config)# cross-connect CC1</code>	Create cross-connect with name CC1
<code>(config-xc)# interface xe1.10</code>	Attach interface xe1.10
<code>(config-xc)# interface xe2.10</code>	Attach interface xe2.10
<code>(config-xc)#exit</code>	Exit cross-connect mode.
<code>(config)#commit</code>	Commit the transaction.

Creating a Subinterface with Encapsulation

Single encapsulation as dot1q with vlan range

```
configure terminal (config)#interface xe1.100 switchport
(config-if)# encapsulation dot1q 100-200
```

Single encapsulation as dot1ad with vlan range

```
configure terminal (config)#interface xe1.100 switchport
(config-if)# encapsulation dot1ad 100-200
```

Double encapsulation as dot1q

```
configure terminal (config)#interface xe1.100 switchport
(config-if)# encapsulation dot1q 10 inner-dot1q 10
```

Double encapsulation as dot1ad

```
configure terminal (config)#interface xe1.200 switchport
(config-if)# encapsulation dot1ad 20 inner-dot1q 20
```

Encapsulation as default

```
configure terminal (config)#interface xe1.101 switchport
(config-if)# encapsulation default
```

Encapsulation as untagged

```
configure terminal (config)#interface xe1.102 switchport
(config-if)# encapsulation untagged
```

Rewrite with push

```
configure terminal (config)#interface xe1.10 switchport
(config-if)# encapsulation dot1q 10
(config-if)# rewrite push 0x8100 100
(config-if)#interface xe2.20 switchport
(config-if)# encapsulation dot1q 100 inner-dot1q 10
(config-if)#exit
(config)# cross-connect CC1
```

```
(config-xc)# interface xe1.10
(config-xc)# interface xe2.10
```

Note: At interface xe1.10, for incoming traffic "rewrite push" will add vlan as 100 with tpid values 8100.

Note: At interface xe1.10, for outgoing traffic "rewrite push" will pop the vlan.

Rewrite with translate

```
configure terminal (config)# interface xe1
(config-if)# dot1ad ethertype 0x9100
(config-if)#interface xe1.10 switchport
(config-if)# encapsulation dot1ad 200
(config-if)# rewrite translate 1-to-1 0x9100 100
(config-if)#interface xe2
(config-if)# dot1ad ethertype 0x9100
(config-if)#interface xe2.20 switchport
(config-if)# encapsulation dot1ad 100
(config-if)#exit
(config)# cross-connect CC1
(config-xc)# interface xe1.10
(config-xc)# interface xe2.10
```

Note: At interface xe1.10, for incoming traffic "rewrite translate" will update vlan as 100 with tpid values 9100.

Note: At interface xe1.10, for outgoing traffic "rewrite translate" will update vlan as 200 with tpid values 9100.

Rewrite with pop

```
#configure terminal (config)#interface xe1.10 switchport
(config-if)# encapsulation dot1q 100
(config-if)# rewrite pop
(config-if)#interface xe2.20 switchport
(config-if)# encapsulation untagged
(config-if)#exit
(config)# cross-connect CC1
(config-xc)# interface xe1.10
(config-xc)# interface xe2.10
```

Note: At interface xe1.10, for incoming traffic "rewrite pop" will pop the vlan.

Note: At interface xe1.10, for outgoing traffic "rewrite pop" will add vlan as 100 with tpid values 8100.

Note: Push, pop and translate rewrite operations are supported with tpid values 8100/88a8/9100/9200 as symmetric operation.

No subinterfaces

```
#configure terminal (config)#interface xe1
(config-if)# no subinterfaces
```

Note: no Subinterfaces will remove all the Subinterfaces.

Note: Same physical interface will support both L2 and L3 subinterfaces.

L2SI Statistics

Enable below commands to get L2SI statistics

```
#configure terminal (config)# hardware-profile statistics ac-lif enable
```

Note: Reload the node, and then only statistics command will get effective.

Verification commands

Subinterfaces appear as any physical interface in the show running-config or the show ip interface brief output and can be configured as any other interface.

The following examples display subinterface information from various show commands.

show interface brief

```
R1#show interface brief | include xe1
xe1          ETH    --    routed          up          none    10g    --
xe1.10       SUBINTERFACE  up          --          N/A
```

show interface <>

```
R1#show interface xe1.10
Interface xe1.10
  Hardware is SUBINTERFACE Current HW addr: b86a.97d0.25c5
  Physical:(Not Applicable) Logical:(not set)
  Port Mode is Switch
  Interface index: 20484106
  Metric 1
  <UP,BROADCAST,RUNNING,MULTICAST>
  VRF Binding: Not bound
  Encapsulation Dot1q (0x8100) Virtual LAN
  Outer Match: Dot1q VLAN 10
  Label switching is disabled
  No Virtual Circuit configured
  Administrative Group(s): None
  Bandwidth 1g
  DHCP client is disabled.
  Last Flapped: Never
  Statistics last cleared: Never
RX
  unicast packets 0 multicast packets 0 broadcast packets 0
  input packets 0 bytes 0
  jumbo packets 0
  undersize 0 oversize 0 CRC 0 fragments 0 jabbers 0
  input error 0
  input with dribble 0 input discard 0
  Rx pause 0
TX
  unicast packets 0 multicast packets 0 broadcast packets 0
  output packets 0 bytes 0
  jumbo packets 0
  output errors 0 collision 0 deferred 0 late collision 0
  output discard 0
  Tx pause 0
```

show cross-connect

```
R1#show cross-connect
```

```
cross-connect status
XC name                Ep1                Ep2                Status
-----+-----+-----+-----
CC1                    xe1.10            xe2.10            UP
-----+-----+-----+-----
```

AC cross-connect summary

Total : 1

Up : 1

Down : 0

R1#show running-config interface xe1

!

interface xe1

dot1ad ethertype 0x88a8

!

R1#show run interface xe1.10

!

interface xe1.10 switchport

encapsulation dot1q 10

rewrite push 0x8100 10

!

R1#show running-config interface xe1

!

interface xe2

dot1ad ethertype 0x88a8

!

R1#show run interface xe2.10

!

interface xe2.10 switchport

encapsulation dot1q 10

!

show interface xe1.10 counters

R1#show interface xe1.10 counters

Interface xe1.10

Rx Packets: 50000

Rx Bytes: 50000000

R1#show interface xe2.10 counters

Interface xe2.10

Tx Packets: 50000

Tx Bytes: 49900000

CHAPTER 20 Layer 2 EPL and EVPL Configuration

This chapter contains examples of configuring L2 EPL and EVPL Subinterfaces.

Ethernet Private Line (EPL) and Ethernet Virtual Private Line (EVPL) are Ethernet services standardized by the Metro Ethernet Forum (MEF) under the category of 'E-Line' services. Both EPL and EVPL offer the advantages of private, high-speed connections with the added flexibility and scalability provided by Multiprotocol Label Switching (MPLS) technology. They are designed to operate across a range of bandwidths to meet diverse business requirements. The key distinction between EPL and EVPL lies in their configuration and how they handle network connections.

- EPL provides a Point-to-Point (P2P) connection between two dedicated User Network Interfaces (UNIs). This setup offers a high degree of transparency and is ideal for businesses requiring a simple and direct link between two locations.
- EVPL enables multiple Ethernet Virtual Connections (EVCs) per UNI, supporting Point-to-MultiPoint (P2MP) connectivity through service multiplexing. This allows businesses to establish a one-to-many network topology, where a single UNI can connect to multiple remote sites, providing greater flexibility in network design.

Topology

Below figure shows the EPL configuration:

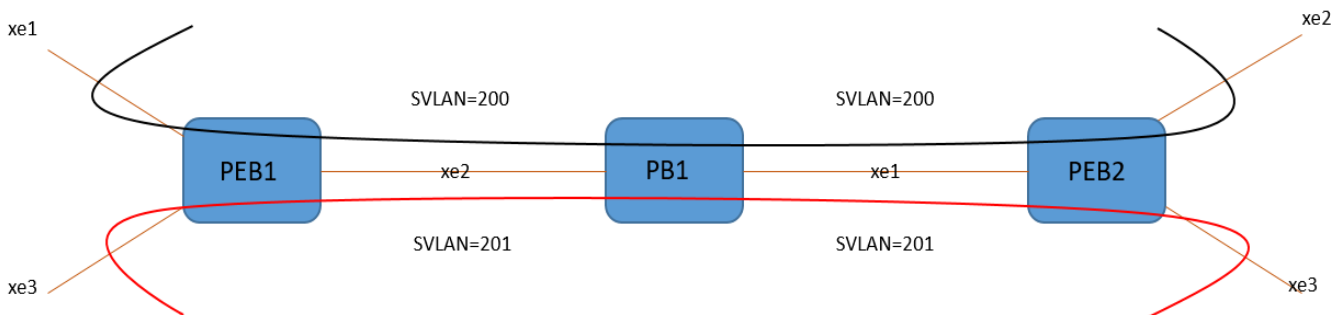

Configure L2 EPL

PEB1

#configure terminal	Enter configure mode.
(config)#interface xe1	Enter interface mode
(config-if)# dot1ad ethertype 0x88a8	Configure interface with tpid value as 88a8
(config-if)#interface xe1.200 switchport	Creates a L2 sub-interface as xe1.200
(config-if)#encapsulation default	Configure the encapsulation as default
(config-if)# rewrite push 0x8100 200	Configure rewrite push with vlan 200
(config-if)#exit	Exit interface mode.

(config)#interface xe2	Enter interface mode
(config-if)# dot1ad ethertype 0x88a8	Configure interface with tpid value as 88a8
(config-if)#interface xe2.200 switchport	Creates a L2 sub-interface as xe2.10
(config-if)#encapsulation dot1q 200	Configure the encapsulation as dot1q matching vlan 200
(config-if)#exit	Exit interface mode.
(config)# cross-connect PEB-1 200	Create cross-connect with name PEB1-200
(config-xc)# interface xe1.200	Attach interface xe1.10
(config-xc)# interface xe2.200	Attach interface xe2.10
(config)#interface xe3	Enter interface mode
(config-if)# dot1ad ethertype 0x88a8	Configure interface with tpid value as 88a8
(config-if)#interface xe3.201 switchport	Creates a L2 sub-interface as xe3.201
(config-if)#encapsulation default	Configure the encapsulation as default
(config-if)# rewrite push 0x8100 201	Configure rewrite push with vlan 201
(config-if)#exit	Exit interface mode.
(config)#interface xe2	Enter interface mode
(config-if)#interface xe2.201 switchport	Creates a L2 sub-interface as xe2.201
(config-if)#encapsulation dot1q 201	Configure the encapsulation as dot1q matching vlan 201
(config)# cross-connect PEB1-201	Create cross-connect with name PEB1-201
(config-xc)# interface xe3.201	Attach interface xe3.201
(config-xc)# interface xe2.201	Attach interface xe2.201
(config-if)#exit	Exit interface mode.

PB1

#configure terminal	Enter configure mode.
(config)#interface xe2	Enter interface mode
(config-if)# dot1ad ethertype 0x88a8	Configure interface with tpid value as 88a8
(config-if)#interface xe2.200 switchport	Creates a L2 sub-interface as xe2.200
(config-if)#encapsulation dot1ad 200	Configure the encapsulation vlan 200
(config-if)#exit	Exit interface mode.
(config)#interface xe1	Enter interface mode
(config-if)# dot1ad ethertype 0x88a8	Configure interface with tpid value as 88a8
(config-if)#interface xe1.200 switchport	Creates a L2 sub-interface as xe1.200
(config-if)#encapsulation dot1ad 200	Configure the encapsulation as dot1ad matching vlan 200
(config-if)#exit	Exit interface mode.
(config)# cross-connect PB1-200	Create cross-connect with name PB1-200
(config-xc)# interface xe2.200	Attach interface xe2.200
(config-xc)# interface xe1.200	Attach interface xe1.200
(config)#interface xe2	Enter interface mode
(config-if)# dot1ad ethertype 0x88a8	Configure interface with tpid value as 88a8

(config-if)#interface xe2.201 switchport	Creates a L2 sub-interface as xe2.201
(config-if)#encapsulation dot1ad 201	Configure the encapsulation as dot1ad with vlan 201
(config-if)#exit	Exit interface mode.
(config)#interface xe1	Enter interface mode
(config-if)#interface xe1.201 switchport	Creates a L2 sub-interface as xe1.201
(config-if)#encapsulation dot1ad 201	Configure the encapsulation as dot1ad with vlan 201
(config-if)#exit	Exit interface mode.
(config)# cross-connect PB1-201	Create cross-connect with name PEB1-201
(config-xc)# interface xe1.201	Attach interface xe1.201
(config-xc)# interface xe2.201	Attach interface xe2.201
(config-if)#exit	Exit interface mode.

PB1

#configure terminal	Enter configure mode.
(config)#interface xe1	Enter interface mode
(config-if)# dot1ad ethertype 0x88a8	Configure interface with tpid value as 88a8
(config-if)#interface xe1.200 switchport	Creates a L2 sub-interface as xe1.200
(config-if)#encapsulation dot1ad 200	Configure the encapsulation as dot1ad 200
(config-if)#exit	Exit interface mode.
(config)#interface xe2	Enter interface mode
(config-if)# dot1ad ethertype 0x88a8	Configure interface with tpid value as 88a8
(config-if)#interface xe2.200 switchport	Creates a L2 sub-interface as xe2.200
(config-if)#encapsulation default	Configure the encapsulation as default
(config-if)# rewrite push 0x88a8 200	Configure rewrite push with vlan 200
(config-if)#exit	Exit interface mode.
(config)# cross-connect PEB2-200	Create cross-connect with name CC1
(config-xc)# interface xe1.200	Attach interface xe1.200
(config-xc)# interface xe2.200	Attach interface xe2.200
(config)#interface xe1	Enter interface mode
(config-if)#interface xe1.201 switchport	Creates a L2 sub-interface as xe1.201
(config-if)#encapsulation dot1ad 201	Configure the encapsulation as dot1ad with vlan 201
(config-if)#exit	Exit interface mode.
(config)#interface xe3	Enter interface mode
(config-if)# dot1ad ethertype 0x88a8	Configure interface with tpid value as 88a8
(config-if)#interface xe3.201 switchport	Creates a L2 sub-interface as xe3.201
(config-if)#encapsulation default	Configure the encapsulation as default
(config-if)# rewrite push 0x88a8 201	Configure rewrite push with vlan 201
(config-if)#exit	Exit interface mode.
(config)# cross-connect PEB2-201	Create cross-connect with name CC1

(config-xc) # interface xe1.201	Attach interface xe1.201
(config-xc) # interface xe3.201	Attach interface xe3.201
(config-if) #exit	Exit interface mode.

Configure L2 EVPL

Topology

Below figure shows the EVPL configuration:

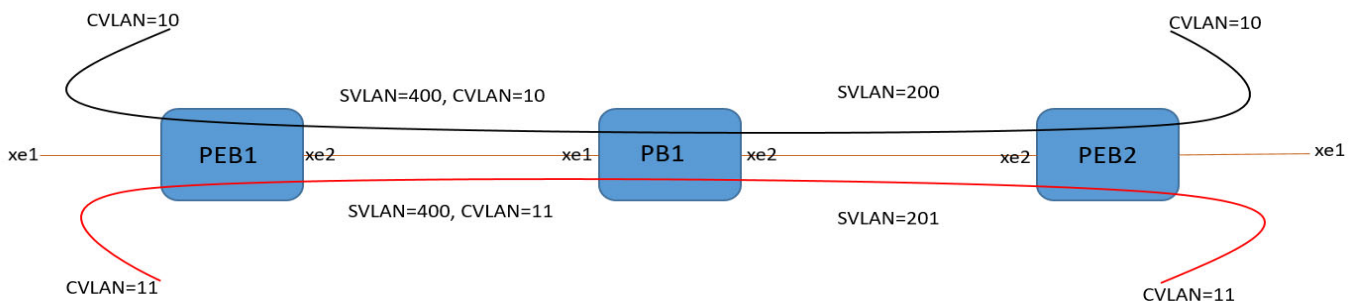

PEB1

SERVICE Configuration (SVLAN=400, CVLAN=10 and SVLAN=400, CVLAN=11

```
)
#configure terminal
(config)#interface xe1
(config-if)# dot1ad ethertype 0x88a8
(config-if)#interface xe1.10 switchport
(config-if)#encapsulation dot1q 10
(config-if)# rewrite push 0x88a8 400
(config-if)#exit
(config)#interface xe2
(config-if)# dot1ad ethertype 0x88a8
(config-if)#interface xe2.400 switchport
(config-if)#encapsulation dot1ad 400
(config-if)#exit
(config)# cross-connect PEB1-400-10
(config-xc) # interface xe1.10
(config-xc) # interface xe2.400
(config)#interface xe1
(config-if)#interface xe1.11 switchport
```

#configure terminal	Enter configure mode.
(config)#interface xe1	Enter interface mode
(config-if)# dot1ad ethertype 0x88a8	Configure interface with tpid value as 88a8
(config-if)#interface xe1.10 switchport	Creates a L2 sub-interface as xe1.10
(config-if)#encapsulation dot1q 10	Configure the encapsulation as default
(config-if)# rewrite push 0x88a8 400	Configure rewrite push with vlan 400
(config-if)#exit	Exit interface mode.
(config)#interface xe2	Enter interface mode
(config-if)# dot1ad ethertype 0x88a8	Configure interface with tpid value as 88a8
(config-if)#interface xe2.400 switchport	Creates a L2 sub-interface as xe2.400
(config-if)#encapsulation dot1ad 400	Configure the encapsulation as dot1ad matching vlan 400
(config-if)#exit	Exit interface mode.
(config)# cross-connect PEB1-400-10	Create cross-connect with name CC1
(config-xc) # interface xe1.10	Attach interface xe1.10
(config-xc) # interface xe2.400	Attach interface xe2.400
(config)#interface xe1	Enter interface mode
(config-if)#interface xe1.11 switchport	Creates a L2 sub-interface as xe1.11

(config-if)#encapsulation dot1q 11	Configure the encapsulation as dot1q matching vlan 11
(config-if)# rewrite push 0x88a8 400	Configure rewrite push with vlan 400
(config-if)#exit	Exit interface mode.
(config)# cross-connect PEB1-400-11	Create cross-connect with name CC1
(config-xc)# interface xe1.11	Attach interface xe1.11
(config-xc)# interface xe2.400	Attach interface xe2.400
(config-if)#exit	Exit interface mode.

PB1**PB Transport Configuration**

#configure terminal	Enter configure mode.
(config)#interface xe1	Enter interface mode
(config-if)# dot1ad ethertype 0x88a8	Configure interface with tpid value as 88a8
(config-if)#interface xe1.400 switchport	Creates a L2 sub-interface as xe1.10
(config-if)#encapsulation dot1ad 400	Configure the encapsulation as dot1ad matching vlan 400
(config-if)#exit	Exit interface mode.
(config)#interface xe2	Enter interface mode
(config-if)# dot1ad ethertype 0x88a8	Configure interface with tpid value as 88a8
(config-if)#interface xe2.400 switchport	Creates a L2 sub-interface as xe2.400
(config-if)#encapsulation dot1ad 400	Configure the encapsulation as dot1ad matching vlan 400
(config-if)#exit	Exit interface mode.
(config)# cross-connect PB1-400	Create cross-connect with name CC1
(config-xc)# interface xe1.400	Attach interface xe1.400
(config-xc)# interface xe2.400	Attach interface xe2.400
(config-if)#exit	Exit interface mode.

PEB2**SERVICE Configuration (SVLAN=400, CVLAN=10 and SVLAN=400, CVLAN=11)**

#configure terminal	Enter configure mode.
(config)#interface xe1	Enter interface mode
(config-if)# dot1ad ethertype 0x88a8	Configure interface with tpid value as 88a8
(config-if)#interface xe1.10 switchport	Creates a L2 sub-interface as xe1.10
(config-if)#encapsulation dot1q 10	Configure the encapsulation as dot1q matching vlan 10
(config-if)# rewrite push 0x88a8 400	Configure rewrite push with vlan 400
(config-if)#exit	Exit interface mode.
(config)#interface xe2	Enter interface mode
(config-if)# dot1ad ethertype 0x88a8	Configure interface with tpid value as 88a8
(config-if)#interface xe2.400 switchport	Creates a L2 sub-interface as xe2.400

(config-if)#encapsulation dot1ad 400	Configure the encapsulation as dot1ad matching vlan 400
(config-if)#exit	Exit interface mode.
(config)# cross-connect PEB2-400-10	Create cross-connect with name CC1
(config-xc)# interface xe1.10	Attach interface xe1.10
(config-xc)# interface xe2.400	Attach interface xe2.400
(config)#interface xe1	Enter interface mode
(config-if)#interface xe1.11 switchport	Creates a L2 sub-interface as xe1.11
(config-if)#encapsulation dot1q 11	Configure the encapsulation as dot1q matching vlan 11
(config-if)# rewrite push 0x88a8 400	Configure rewrite push with vlan 400
(config-if)#exit	Exit interface mode.
(config)# cross-connect PEB2-400-11	Create cross-connect with name PEB2-400-11
(config-xc)# interface xe1.11	Attach interface xe1.11
(config-xc)# interface xe2.400	Attach interface xe2.400
(config-if)#exit	Exit interface mode.

Verification commands

The following examples display L2 EPL And EVPL information from various show commands.

show interface brief

```
PEB1#show interface brief | include xe2
xe2          ETH          --      routed          up      none      10g      --          No      No
xe2.200      SUBINTERFACE  --      --              up      none      10g      --          No      No
xe2.201      SUBINTERFACE  --      --              up      none      10g      --          No      No
PEB1#
PEB1#
PEB1#show interface brief | include xe1
xe1          ETH          --      routed          up      none      10g      --          No      No
xe1.201      SUBINTERFACE  --      --              up      none      10g      --          No      No
PEB1#
PEB1#show interface brief | include xe3
xe3          ETH          --      routed          up      none      10g      --          No      No
xe3.200      SUBINTERFACE  --      --              up      none      10g      --          No      No
```

show interface <>

```
PEB1#sh interface xe2.200
Interface xe2.200
  Hardware is SUBINTERFACE Current HW addr: e8c5.7a90.d9c8
  Physical:e8c5.7a90.d9c8 Logical:(not set)
  Port Mode is Switch
  Interface index: 327909576
  GMPLS index: 56
  Metric 1 mtu 1500 link-speed 10g
  Debounce timer: disable
  <UP,BROADCAST,RUNNING,ALLMULTI,MULTICAST>
```

```

VRF Binding: Not bound
Encapsulation Dot1q (0x8100) Virtual LAN
Outer Match: Dot1q VLAN 200
Label switching is disabled
No Virtual Circuit configured
Administrative Group(s): None
Extended-Admin-Group(s): None
Bandwidth 10g
DHCP client is disabled.
Last Flapped: Never
Statistics last cleared: Never
RX
  unicast packets 0 multicast packets 0 broadcast packets 0
  input packets 0 bytes 0
  jumbo packets 0
  undersize 0 oversize 0 CRC 0 fragments 0 jabbers 0
  input error 0
  input with dribble 0 input discard 0
  Rx pause 0
TX
  unicast packets 0 multicast packets 0 broadcast packets 0
  output packets 0 bytes 0
  jumbo packets 0
  output errors 0 collision 0 deferred 0 late collision 0
  output discard 0
  Tx pause 0

```

show cross-connect

```

PEB1#show cross-connect
cross-connect status
XC name          Ep1          Bkp-Ep1      Ep2          Bkp-
Ep2          Status
-----+-----+-----+-----+-----
-----+-----
PEB-1-200      xe4.200      -            xe6.200      -
UP
PEB1-201      xe11.201     -            xe6.201      -
UP
-----+-----+-----+-----+-----
-----+-----

```

AC cross-connect summary

```

Total : 2
Up    : 2
Down  : 0
!
```

show interface xe1.200 counters

```

PEB1:
PEB1#show interface xe2.200 counters
Interface xe2.200
  Tx Packets: 50000
  Tx Bytes: 50000000

```

```
PEB1#show interface xe1.200 counters
Interface xe1.200
  Tx Packets: 50000
  Tx Bytes: 50000000
PEB1#show interface xe2.201 counters
Interface xe2.201
  Tx Packets: 50000
  Tx Bytes: 50000000
PEB1#show interface xe3.201 counters
Interface xe3.201
  Tx Packets: 50000
  Tx Bytes: 50000000
```

CHAPTER 21 Bridging Support Over Layer2 Sub Interface

This chapter contains examples of configuring Bridging Support Over Layer2 Subinterfaces.

To support ELAN service between sub-interfaces, Bridge domain is being used to switch the traffics between sub interfaces. Bridge-domain supports Learn and Forward mechanism. BUM traffic will be flooded in bridge-domain and known unicast will be forwarded based on L2 FDB table lookup.

Topology

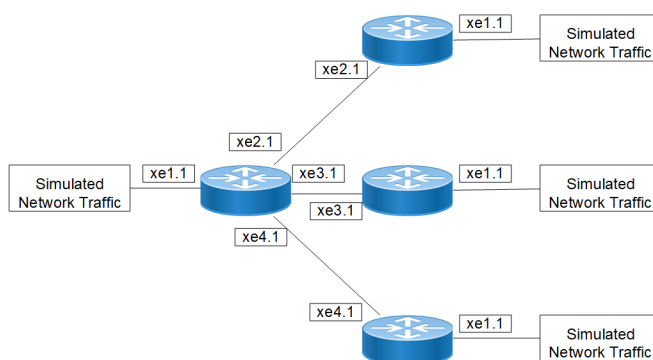

Figure 21-40: Bridging support over L2 subinterface

Configure L2 Subinterface and Bridge Domain

#configure terminal	Enter configure mode.
(config)#interface xe1	Enter interface mode
(config-if)#dot1ad ethertype 0x88a8	Configure interface with tpid value as 88a8
(config-if)#interface xe1.1 switchport	Creates a L2 sub-interface as xe1.1
(config-if)#encapsulation dot1q 10	Configure the encapsulation as dot1q matching vlan 10
(config-if)#exit	Exit interface mode.
(config)#interface xe2	Enter interface mode
(config-if)#dot1ad ethertype 0x88a8	Configure interface with tpid value as 88a8
(config-if)#interface xe2.1 switchport	Creates a L2 sub-interface as xe2.1
(config-if)#encapsulation dot1q 10	Configure the encapsulation as dot1q matching vlan 10
(config-if)#exit	Exit interface mode.
(config)#bridge-domain 1	Create bridge-domain with the id 1
(config-bridge-domain)#interface xe1.1	Attach interface xe1.1
(config-bridge-domain)#interface xe2.1	Attach interface xe2.1
(config-bridge-domain)#exit	Exit interface mode.
(config)#commit	Commit the transaction.

Configure L2 Subinterface (Double-Push) and attach to Bridge Domain

#configure terminal	Enter configure mode.
(config)#interface xe1.1 switchport	Creates a L2 sub-interface as xe1.1
(config-if)#encapsulation untagged	Configure the encapsulation as untagged
(config-if)#rewrite push 0x8100 200 inner-dot1q 200	Configure rewrite push with inner vlan 200 and outer vlan 200
(config-if)#exit	Exit interface mode
(config)#interface xe2.1 switchport	Creates a L2 sub-interface as xe2.1
(config-if)#encapsulation dot1ad 200 inner-dot1q 200	Configure the encapsulation with inner vlan 200 and outer vlan 200
(config-if)#exit	Exit interface mode
(config)#bridge-domain 1	Create bridge-domain with the id 1
(config-bridge-domain)#interface xe1.1	Attach interface xe1.1
(config-bridge-domain)#interface xe2.1	Attach interface xe2.1
(config-bridge-domain)#exit	Exit interface mode.
(config)#commit	Commit the transaction.

Configure L2 Subinterface (Double-Pop) attach to Bridge Domain

#configure terminal	Enter configure mode.
(config)##interface xe1.1 switchport	Creates a L2 sub-interface as xe1.1
(config-if)#encapsulation untagged	Configure the encapsulation as untagged
(config-if)#exit	Exit interface mode
(config)#interface xe2.1 switchport	Creates a L2 sub-interface as xe2.1
(config-if)#encapsulation dot1ad 200 inner-dot1q 200	Configure the encapsulation with inner vlan 200 and outer vlan 200
(config-if)#rewrite pop-2tag	Configure rewrite pop-2tag
(config-if)#exit	Exit interface mode
(config)#bridge-domain 1	Create bridge-domain with the id 1
(config-bridge-domain)#interface xe1.1	Attach interface xe1.1
(config-bridge-domain)#interface xe2.1	Attach interface xe2.1
(config-bridge-domain)#exit	Exit interface mode.
(config)#commit	Commit the transaction.

Creating a Subinterface with Encapsulation

Single encapsulation as dot1q with vlan range

```
#configure terminal
(config)#interface xe1.100 switchport
(config-if)#encapsulation dot1q 100-200
```

Single encapsulation as dot1ad with vlan range

```
#configure terminal
(config)#interface xe1.100 switchport
(config-if)#encapsulation dot1ad 100-200
```

Double encapsulation as dot1q

```
#configure terminal
(config)#interface xe1.100 switchport
(config-if)#encapsulation dot1q 10 inner-dot1q 10
```

Double encapsulation as dot1ad

```
#configure terminal
(config)#interface xe1.200 switchport
(config-if)#encapsulation dot1ad 20 inner-dot1q 20
```

Encapsulation as default

```
#configure terminal
(config)#interface xe1.101 switchport
(config-if)#encapsulation default
```

Encapsulation as untagged

```
#configure terminal
(config)#interface xe1.102 switchport
(config-if)#encapsulation untagged
```

Rewrite with push

```
#configure terminal
(config)#interface xe1.1 switchport
(config-if)#encapsulation dot1q 10
(config-if)#rewrite push 0x8100 100
(config-if)#interface xe2.2 switchport
(config-if)#encapsulation dot1q 100 inner-dot1q 10
(config-if)#exit
(config)#bridge-domain 1
(config-xc)#interface xe1.1
(config-xc)#interface xe2.1
```

Note: At interface xe1.1, for incoming traffic "rewrite push" will add VLAN as 100 with TPID values 8100.

Note: At interface xe1.1, for outgoing traffic "rewrite push" will pop the VLAN.

Rewrite with translate

```
#configure terminal
(config)#interface xe1
(config-if)#dot1ad ethertype 0x9100
(config-if)#interface xe1.1 switchport
(config-if)#encapsulation dot1ad 200
(config-if)#rewrite translate 1-to-1 0x9100 100
(config-if)#interface xe2
(config-if)#dot1ad ethertype 0x9100
(config-if)#interface xe2.2 switchport
(config-if)#encapsulation dot1ad 100
```

```
(config-if)#exit
(config)#bridge-domain 1
(config-xc)#interface xe1.1
(config-xc)#interface xe2.1
```

Note: At interface xe1.10, for incoming traffic "rewrite translate" will update VLAN as 100 with TPID values 9100.

Note: At interface xe1.10, for outgoing traffic "rewrite translate" will update VLAN as 200 with TPID values 9100.

Rewrite with pop

```
#configure terminal
(config)#interface xe1.1 switchport
(config-if)#encapsulation dot1q 100
(config-if)#rewrite pop
(config-if)#interface xe2.2 switchport
(config-if)#encapsulation untagged
(config-if)#exit
(config)#bridge-domain 1
(config-xc)#interface xe1.1
(config-xc)#interface xe2.1
```

Note: At interface xe1.1, for incoming traffic "rewrite pop" will pop the VLAN.

Note: At interface xe1.1, for outgoing traffic "rewrite pop" will add VLAN as 100 with TPID values 8100.

Note: Push, pop and translate rewrite operations are supported with TPID values 8100/88a8/9100/9200 as symmetric operation.

No subinterfaces

```
#configure terminal
(config)#interface xe1
(config-if)#no subinterfaces
```

Note: no Subinterfaces will remove all the Subinterfaces.

Note: Same physical interface will support both L2 and L3 subinterfaces.

Verification commands

```
#show bridge-domain
Bridge Id   interfaces           Status
-----+-----+-----+-----+
 1          xe1.1                UP
           xe2.1                UP
```

1. Command to display the learned MAC entries of bridge domain

```
OcNOS#show mac address-table dynamic bridge-domain id 1
Bridge MAC Address      Type      Ports
-----+-----+-----+-----+
 1          0022.3344.5566    dynamic  xe1.1
```

```
OcNOS#show mac address-table dynamic bridge-domain all
Bridge MAC Address      Type      Ports
-----+-----+-----+-----+
 1          0022.3344.5566    dynamic  xe1.1
```



```
OcNOS#show mac address-table dynamic bridge-domain interface xe1.1
Bridge MAC Address      Type      Ports
-----+-----+-----+-----+
1          0022.3344.5566  dynamic  xe1.1
```

```
OcNOS#show mac address-table dynamic bridge-domain address 0022.3344.5566
Bridge MAC Address      Type      Ports
-----+-----+-----+-----+
1          0022.3344.5566  dynamic  xe1.1
```

2. Command to clear the learned MAC entries

```
OcNOS#clear mac address-table dynamic bridge-domain id 1
OcNOS#clear mac address-table dynamic bridge-domain id 1 interface xe1.1
OcNOS#clear mac address-table dynamic bridge-domain id 1 address 0022.3344.5566
OcNOS#clear mac address-table dynamic bridge-domain all
```

```
OcNOS#sh mac address-table dynamic bridge-domain id 1
Bridge MAC Address      Type      Ports
-----+-----+-----+-----+
```

CHAPTER 22 Layer 2 Control Protocols Tunneling

Overview

The Layer 2 Control Protocols (L2CP) processing specified here is based largely on the IEEE 802.1Q specification for handling L2CP Frames, i.e. if they should be forwarded, peered, or discarded.

IEEE 802.1Q provides a mechanism for separating the Layer2 control plane into multiple customer and provider control planes. It allows a certain layer 2 control protocol to operate only within a provider network, or to allow interaction between the customer and the provider network, or to pass transparently through a provider network with complete isolation from other customer networks.

In case of non-PB case, packet is forwarded without changing any MAC.

L2CP Tunneling for Provider Bridging

L2CP tunneling provides support for tunneling control plane frames between CE nodes.

In the context of PB, a L2CP frame is defined as any frame containing a destination MAC address as 01:00:0C:CD:CD:D0 or 01:04:DF:CD:CD:D0 (which can be changed via CLI)

When control frames received at CEP port of a PE bridge, predefined multicast address (01-00-C2-CD-CD-D0) is replaced as destination for tunneling the packets across service provider network. If control packets are customer vlan tagged or untagged, then PE bridge will append corresponding service vlan tag to the control packet as per registration table / vlan translation table mapped to the port and send it across the service provider as a data packet.

When tunneled control packet with multicast address (01-00-C2-CD-CD-D0) received on PNP port, the multicast address is replaced with corresponding control packet multicast address and cvlan/svlan removal or update is done as per registration table / vlan translation table.

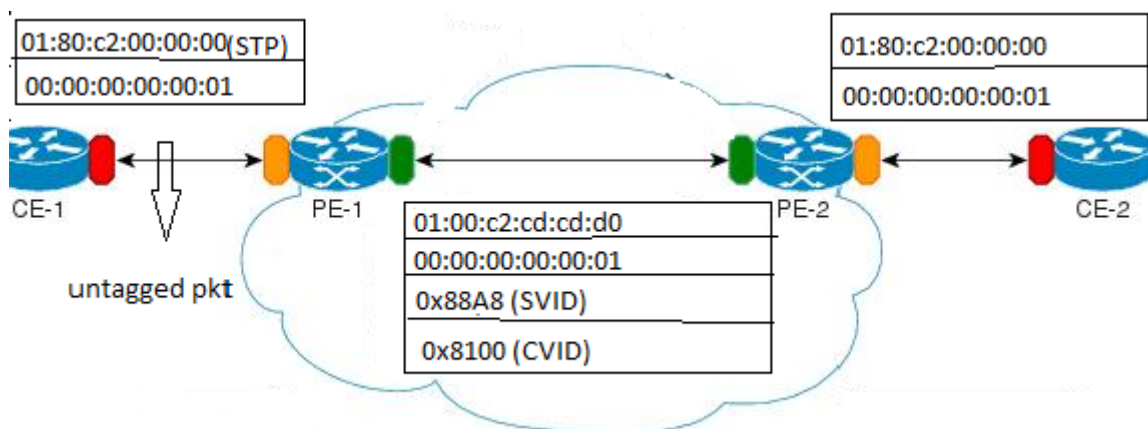

Figure 22-41: L2CP tunneling for provider bridging

L2CP Tunneling for VPLS/VPWS/Hybrid (Bridge+VPWS)

L2CP tunneling provides support for tunneling Control plane frames across L2VPN.

L2CP Tunneling for VXLAN

L2CP tunneling provides support for tunneling Control plane frames across VXLAN/MH.

Topology

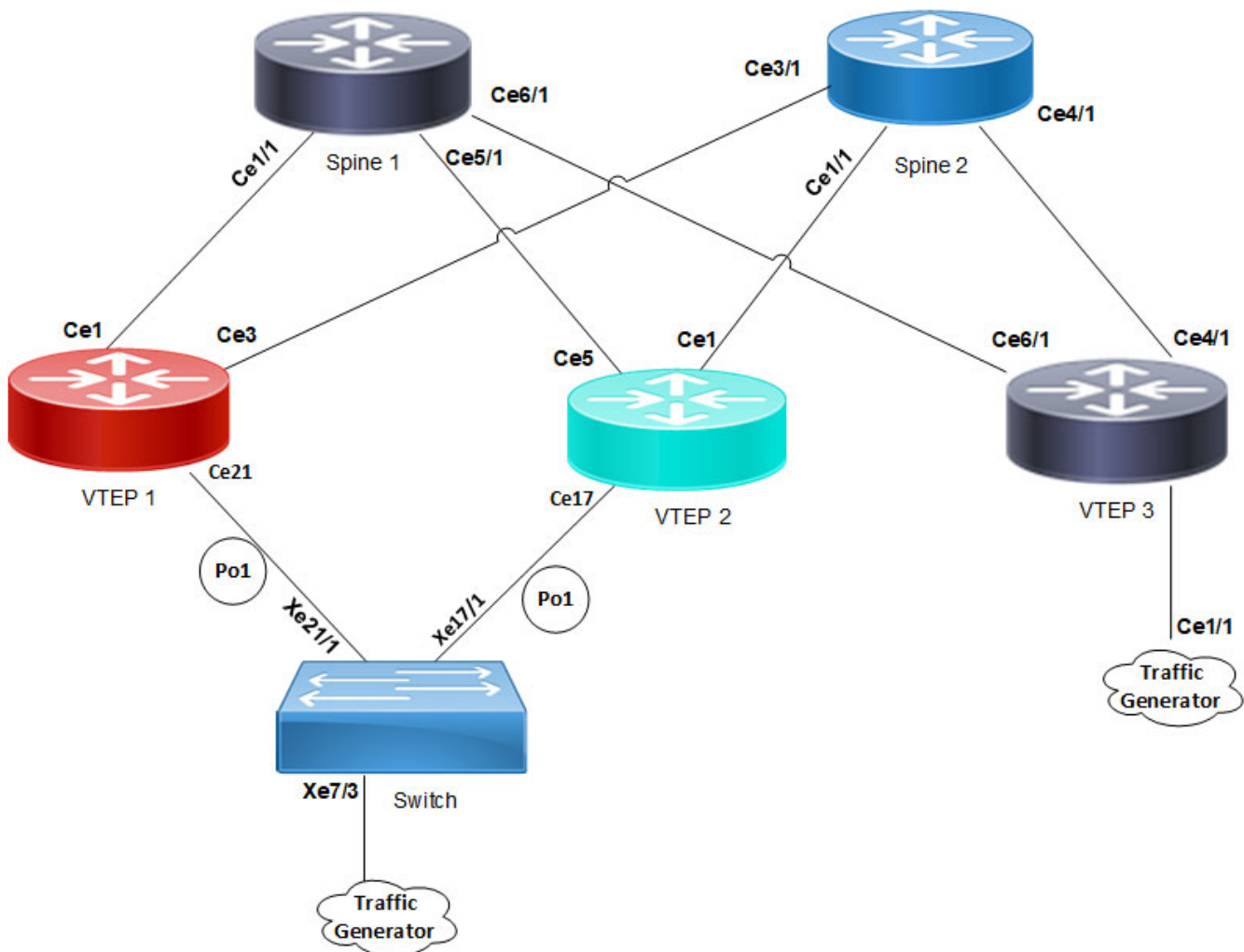

Figure 22-42: L2CP tunneling for VXLAN

VXLAN creates LAN segments using a MAC in IP encapsulation. The encapsulation carries the original L2 frame received from a host to the destination in another server using IP tunnels. The endpoints of the virtualized tunnel formed using VXLAN are called VTEPs (VXLAN Tunnel EndPoints).

L2CP tunneling provides support for tunneling control plane frames across VXLAN with MH/SH combination.

Any L2CP frame that is destined towards other end with a multicast destination MAC Address for L2 protocol is decided by looking at the frame and upon the configured values of the L2CP Service Attributes.

As and when Control packets with default destination MAC address for any L2 protocol is generated, it will be forwarded by VTEPs that are part of MH towards the VTEP that is part of SH and vice versa.

During this operation, the default destination MAC address for any L2 protocol is replaced with predefined multicast address as destination for tunneling the packets across SPINE nodes. When tunneled control packet with pre-defined multicast address received on ingress port on the other end of the VTEP, the multicast address is replaced with corresponding control packet multicast address.

Default Behavior

If control packets are received at the PE router on AC port (vlan tagged/untagged), corresponding AC port properties will take care of forwarding to peer PE node. These packets are encapsulated with MPLS headers and sent across the network to the remote PE router. The egress PE router receives the packet and performs MPLS decapsulation and forwards to the CE. Except for LACP, all other control packets are tunnels across the MPLS circuit.

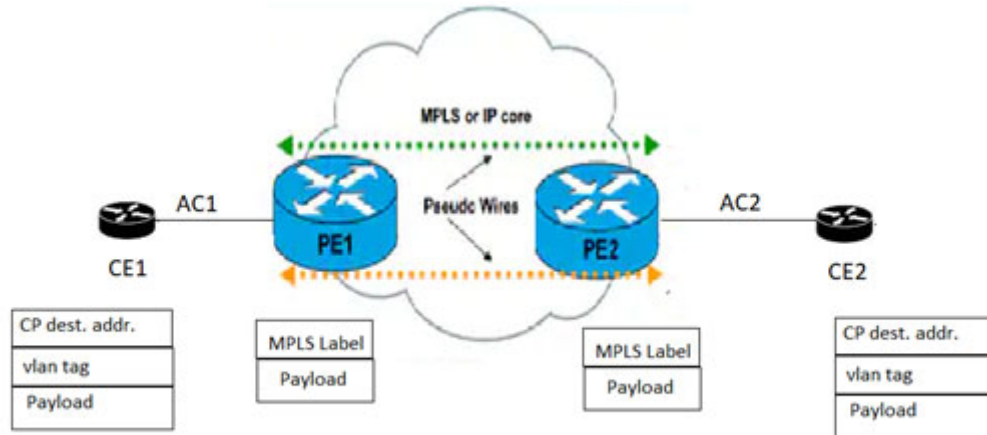

Figure 22-43: L2CP tunneling for VPLS/VPWS/Hybrid (bridge+VPWS)

Hybrid Port

When the incoming port is configured as Hybrid (Bridge+L2VPN), L2CP switches to peering mode. You can override this behavior with the help of L2CP configurations.

L2CP Behavior

The action taken for a given L2CP Frame at a given L2CP Decision Point depends upon the Destination Address within the frame, and upon the configured values of the L2CP Service Attributes.

The three possible actions at an L2CP Decision Points are: Discard, Peer, or Pass/Tunnel.

Discard	The L2CP frame is neither peered nor forwarded.
Peer	The L2CP frame will be processed.
Pass/Tunnel	Pass (or forwarded) means that the frame will be passed transparently in the same way as normal data frames.

Default L2CP configuration

Default L2CP decision in Provider Bridging case:

Table 22-2: Default L2CP decision for Provider Bridging

Protocol Type	L2CP destination address	Ethertype/subtype	Default L2CP action
STP (Spanning Tree Protocols)	01-80-c2-00-00-00	N/A	PEER
LACP (Link Aggregation Control Protocol)	01-80-c2-00-00-02	ethertype 0x8809 and subtype 0x1 or 0x2	PEER
DOT1X (Port Authentication (802.1 X))	01-80-c2-00-00-03	N/A	PEER
LLDP (Link layer discovery protocol)	01-80-c2-00-00-0e	ethertype 0x88CC	PEER
EFM (Ethernet first mile (Link OAM))	01-80-c2-00-00-02	ethertype 0x8809 and subtype 0x3	PEER
ELMI (Ethernet Local Management Interface)	01-80-c2-00-00-07	ethertype 0x88EE	PEER

Default L2CP Decision in VPLS/VPWS/Hybrid case:

- For bridged packets in case of hybrid port:

Table 22-3: Default L2CP decision for hybrid port

Protocol Type	L2CP destination address	Default L2CP action
STP(Spanning Tree Protocols)	01-80-c2-00-00-00	PEER
LACP (Link Aggregation Control Protocol)	01-80-c2-00-00-02	PEER
DOT1X (Port Authentication (802.1 X))	01-80-c2-00-00-03	PEER
LLDP (Link layer discovery protocol)	01-80-c2-00-00-0e	PEER
EFM (Ethernet first mile (Link OAM))	01-80-c2-00-00-02	PEER
ELMI (Ethernet Local Management Interface)	01-80-c2-00-00-07	PEER

- For VPLS/VPWS:

Table 22-4: Default L2CP decision for VPLS/VPWS

Protocol Type	L2CP destination address	Default L2CP action
STP (Spanning Tree Protocols)	01-80-c2-00-00-00	TUNEEL
LACP (Link Aggregation Control Protocol)	01-80-c2-00-00-02	PEER

Table 22-4: Default L2CP decision for VPLS/VPWS (Continued)

Protocol Type	L2CP destination address	Default L2CP action
DOT1X (Port Authentication (802.1 X))	01-80-c2-00-00-03	TUNNEL
LLDP (Link layer discovery protocol)	01-80-c2-00-00-0e	TUNNEL
EFM (Ethernet first mile (Link OAM))	01-80-c2-00-00-02	TUNNEL
ELMI (Ethernet Local Management Interface)	01-80-c2-00-00-07	TUNNEL

Operational Concepts and Scenarios

Basic Configuration for L2CP for Hybrid+VPLS

Enabling tunneling at bridged interface:

```
(config-if)#show run in xel1
!
interface xel1
 speed 1g
 switchport
 bridge-group 1
 switchport mode trunk
 switchport trunk allowed vlan all
 mpls-l2-circuit vc1 service-template svc1

#config ter
#(config)interface xel1
(config-if)#l2protocol stp tunnel
(config-if)#commit
(config-if)#end
```

To display L2CP information:

```
#show l2protocol processing interface xel1
Bridge      Interface Name  Protocol      Processing Status      Hardware Status
=====      =====
-          xel1           stp           Tunnel                 Tunnel
-          xel1           lacp          None                   Peer
-          xel1           dot1x         None                   Peer
-          xel1           lldp          None                   Peer
-          xel1           efm           None                   Peer
-          xel1           elmi          None                   Peer
```

```
(config)#in xel1
(config-if)#no l2protocol stp
(config-if)#end
```

```
#show l2protocol processing interface xe11
```

Bridge	Interface Name	Protocol	Processing Status	Hardware Status
-	xe11	stp	None	Peer
-	xe11	lacp	None	Peer
-	xe11	dot1x	None	Peer
-	xe11	lldp	None	Peer
-	xe11	efm	None	Peer
-	xe11	elmi	None	Peer

Note: If the configuration is not done, hardware status shows the default values while the configured will be none. On configuring L2CP on interface, configured and hardware status will be same.

Basic Configuration for L2CP in VPLS

Enabling tunneling at ingress VPLS interface:

```
#show run in xe12
!
interface xe12
 speed 1g
 mpls-l2-circuit vc1 service-template svcl
!
#config ter
#(config)interface xe12
(config-if)#commit
```

To display L2CP information:

```
#show l2protocol processing interface xe12
```

Bridge	Interface Name	Protocol	Processing Status	Hardware Status
-	xe12	stp	Discard	Discard
-	xe12	lacp	None	Peer
-	xe12	dot1x	None	Tunnel
-	xe12	lldp	None	Tunnel
-	xe12	efm	None	Tunnel
-	xe12	elmi	None	Tunnel

Basic Configuration for L2CP on Provider Bridging

Enabling tunneling at interface:

```
(config)#bridge 1 protocol provider-rstp edge
(config)#vlan database
(config-vlan)#vlan 2-10 bridge 1 state enable
(config-vlan)#vlan 11 type service point-point bridge 1 state enable
(config-vlan)#ex
(config)#cvlan registration table map1 bridge 1
(config-cvlan-registration)#cvlan 2 svlan 11
(config-cvlan-registration)#ex
```

```
(config)#interface xe1
(config-if)#switchport
(config-if)#bridge-group 1
(config-if)#switchport mode customer-edge hybrid
(config-if)#switchport customer-edge hybrid allowed vlan all
(config-if)#switchport customer-edge vlan registration map1
(config-if)#l2protocol stp tunnel
#show running-config interface xe1
!
interface xe1
speed 1g
switchport
bridge-group 1
switchport mode customer-edge hybrid
switchport customer-edge hybrid allowed vlan all
switchport customer-edge vlan registration map1
l2protocol stp tunnel
customer-spanning-tree provider-edge svlan 11 path-cost 128
(config-if)#commit
```

Configuring egress interfaces:

```
(config)#interface xe2
(config-if)#switchport
(config-if)#bridge-group 1
(config-if)#switchport mode provider-network
(config-if)#switchport provider-network allowed vlan all
(config-if)#commit
```

To display L2protocol information:

```
#show l2protocol processing interface xe1
```

Bridge	Interface Name	Protocol	Processing Status	Hardware Status
=====	=====	=====	=====	=====
1	xe1	stp	Tunnel	Tunnel
1	xe1	lacp	Peer	Peer
1	xe1	dot1x	Peer	Peer
1	xe1	lldp	Peer	Peer
1	xe1	efm	Peer	Peer
1	xe1	elmi	Peer	Peer

To display L2protocol counters:

```
#show l2protocol interface counters
Interface xe1
Tunnel          : stp          : 45
```

CHAPTER 23 ErrDisable for Link-Flapping Configuration

If a link flaps continuously, the interface goes into ErrDisable state. When a port is the ErrDisable state, it is effectively shut down and no traffic is sent or received on that port. The port can be recovered from the ErrDisable state manually (shutting down the interface) or automatically (setting a timeout value).

Note:

- An interface should change state as up-down to complete one cycle of a link flap.
- Admin shut/no-shut is considered as a link-flap for errdisable.
- The LED does not glow when an interface is in the errdisable state.
- Errdisable is supported only on physical interfaces.
- A LAG interface does not go into the errdisable state when all of its member ports are in the errdisable state
- The error disable computation is based on a sliding window of time. The window size is configurable in seconds. This window is taken as the current time to the last <t> second, where <t> is the configured window size. If the accumulated link flap count reaches the maximum flap count for a particular sliding window, a link flap error disable fault is triggered.

Topology



Figure 23-44: ErrDisable

Automatic Recovery

By default, an interface goes into the ErrDisable state when a link flaps 5 times in 10 seconds. An interface is recovered from the ErrDisable state when the configured non-zero errdisable time-out interval value expires.

RTR1

#configure terminal	Enter configure mode.
(config)#errdisable cause link-flap	Enable ErrDisable due to link-flap
(config)#errdisable link-flap-setting max-flaps 2 time 30	Configure Link flap settings. Max link flap count and interval for linkFlap Timer
(config)#errdisable timeout interval 50	Configure interval to recover from error disable state
(config)#commit	Commit the candidate configuration to the running configuration.
(config)#exit	Exit interface mode

Note: Automatic recovery timeout is disabled, if you configure `errdisable timeout interval 0`

Validation

```
#show errdisable details
```

```
Error Disable Recovery Timeout Interval : 50 secs
Link Flap Timer Interval : 30 secs
Link Flaps allowed Max. count : 2
```

```
ErrDisable Cause      Status
-----
Link-Flap             Enabled
Lag-Mismatch          Disabled
Stp-Bpdu-Guard        Enabled
Mac-move-limit        Disabled
```

Note: Stp-Bpdu-Guard is enabled by default on the global level configuration.

```
#show interface errdisable status
Interfaces that will be enabled at the next timeout
Interface      ErrDisable Cause  Time left(secs)
-----
xe11           link-flap         38
```

```
#show interface brief | include ED
          ED - ErrDisabled, PD - Protocol Down, AD - Admin Down, IA - InActive
xe11     ETH  --  --                down  ED    10g  --      No  No
#
```

Note: Interface xe11 went into the ErrDisable state after flapping 2 times in 30 seconds.

Log Message

Edgel-SiteX#configure terminal	Enter configure mode.
Edgel-SiteX(config)#logging level nsm 4	Enable Operational log to display recovery message
Edgel-SiteX(config)#commit	Commit the candidate configuration to the running configuration.
Edgel-SiteX(config)#exit	Exit interface mode

```
2017 Sep 18 11:52:12 : NSM : CRITI : [IFMGR_IF_DOWN_2]: Interface xe11 changed state to
down
(config-if)#no shut
(config-if)#2017 Sep 18 11:52:15 : NSM : CRITI : [IFMGR_IF_UP_2]: Interface xe11 changed
state to up
2017 Sep 18 11:52:15 : NSM : WARN : [VXLAN_OPR_ACCESSPORT_UP_4]: VXLAN Access port on
xe11 is up
2017 Sep 18 11:52:15 : NSM : CRITI : [IFMGR_ERR_DISABLE_DOWN_2]: Interface xe11 moved to
errdisable state due to link-flap
2017 Sep 18 11:52:15 : NSM : CRITI : [IFMGR_IF_DOWN_2]: Interface xe11 changed state to
down
```

Note: Interface xe11 recovered from the ErrDisable state after a 50 second time-out.

Manual Recovery

An interface can be recovered manually from the Errdisable state, when configure shutdown followed by no shutdown using CLI. Shutdown will recover the interface from errdisable state and No shutdown will make the interface up state.

RTR1

#configure terminal	Enter configure mode.
(config)#errdisable cause link-flap	Enable errdisable due to link-flap
(config)#errdisable link-flap-setting max-flaps 3 time 20	Configure Link flap settings. Max link flap count and interval for linkFlap Timer
(config)#commit	Commit the candidate configuration to the running configuration.
(config)#exit	Exit interface mode

```
#show running-config | include errdisable
errdisable cause link-flap
errdisable link-flap-setting max-flaps 3 time 20
errdisable cause stp-bpdu-guard
```

```
#show errdisable details
```

```
Link Flap Timer Interval : 20 secs
Link Flaps allowed Max. count : 3
```

ErrDisable Cause	Status
-----	-----
Link-Flap	Enabled
Lag-Mismatch	Disabled
Stp-Bpdu-Guard	Disabled
Mac-move-limit	Disabled

Note: Interface xe11 went into the ErrDisable state after flapping 3 times in 20 seconds.

```
(config)#do show interface errdisable status
Interfaces that will be enabled at the next timeout
Interface      ErrDisable Cause      Time left(secs)
-----      -
xe11          link-flap              NA
(config)#do show int brief | include ED
          ED - ErrDisabled, PD - Protocol Down, AD - Admin Down, IA - InActive
xe11      ETH  --  --                down  ED    10g  --  No  No
```

Note: Interface xe11 recovered from the ErrDisable state after entering shutdown followed by no shutdown.

```
(config)#interface xell
(config-if)#shutdown
2017 Sep 18 13:02:20 : NSM : WARN : [IFMGR_ERR_DISABLE_UP_4]: Interface xell recovered
from link-flap errdisable
(config-if)#no shut
(config-if)#2017 Sep 18 13:02:21 : NSM : CRITI : [IFMGR_IF_UP_2]: Interface xell changed
state to up
2017 Sep 18 13:02:21 : NSM : WARN : [VXLAN_OPR_ACCESSSPORT_UP_4]: VXLAN Access port on
xell is up
```

```
config)#do show interface errdisable
(config)#do show interface brief | include ED
      ED - ErrDisabled, PD - Protocol Down, AD - Admin Down, IA - InActive
(config)#
```

If you configure no errdisable cause link-flap, at the global level, it recovers all the interfaces from the ErrDisable state

Errdisable at the Interface Level

If you enable errdisable globally, by default all physical interfaces enable link-flap errdisable. To turn off errdisable for an interface, configure the commands below.

#configure terminal	Enter configure mode.
(config)#interface xell	Enter into interface level
(config-if)#no link-flap errdisable	Disable link-flap errdisable for interface
(config)#commit	Commit the candidate configuration to the running configuration.
(config)#exit	Exit interface mode

Note: If you configure “no link-flap errdisable” in interface level, either it won’t allow the interface move to errdisable state or it will recover interface from errdisable state

Validation

```
#show run int xell
!
interface xell
description *1/2 member of PO3 - Connected to IXIA 6/6*
channel-group 3 mode active
no link-flap errdisable
!
```

CHAPTER 24 Unidirectional Link Detection Configuration

This chapter shows a complete configuration to enable UDLD in a simple network topology.

The purpose of Unidirectional Link Detection protocol (UDLD) is to monitor the physical links and detect when a unidirectional link exists. Upon detection user can either block the port or notify the link status based on the network administrator's configuration.

UDLD works in two different modes:

- Normal mode
- Aggressive mode

Topology

Figure 24-45 shows the topology of the UDLD configuration.

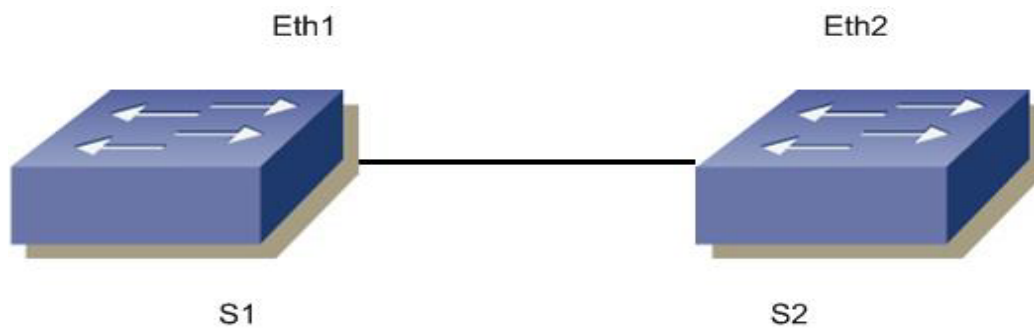

Figure 24-45: UDLD Configuration

S1

#configure terminal	Enter configure mode
(config)#udld enable	Enable UDLD globally
(config)# udld message-time 7	Configure message time for UDLD packets
(config)#interface eth1	Enter interface mode
(config-if)#switchport	Configure the interface as switch port
(config-if)#udld state enable	Enable UDLD on the interface
(config-if)udld mode normal	Configure udld mode as normal or aggressive
(config-if)#commit	Commit config.
(config-if)#exit	Exit from the interface mode

S2

#configure terminal	Enter configure mode.
(config)#udld enable	Enable UDLD globally.
(config)#udld message-time 7	Configure message time for UDLD packets
(config)#interface eth2	Enter interface mode
(config-if)#switchport	Configure the interface as switch port.
(config-if)#udld state enable	Enable UDLD on the interface.
(config-if)udld mode normal	Configure udld mode as normal or aggressive
(config-if)#commit	Commit config.
(config-if)#exit	Exit from the interface mode

Validation

```
#show udld
UDLD: Enable
Message Interval(sec) : 7
```

Port	UDLD Status	Mode	Link-Status
Eth1	Enable	Normal	Bi-directional
Eth2	Disable	Normal	Unknown
Eth3	Disable	Normal	Unknown
Eth4	Disable	Normal	Unknown
Eth5	Disable	Normal	Unknown
Eth6	Disable	Normal	Unknown

Once the links is made Uni-directional, the output of the command Show udld is as follows:

```
#show udld
UDLD: Enable
Message Interval(sec) : 7
```

Port	UDLD Status	Mode	Link-Status
Eth1	Enable	Normal	Unidirectional
Eth2	Disable	Normal	Unknown
Eth3	Disable	Normal	Unknown
Eth4	Disable	Normal	Unknown
Eth5	Disable	Normal	Unknown
Eth6	Disable	Normal	Unknown

```
#sh running-config
udld Enable
udld message-time 7
```

```
#sh running-config in eth1
!
interface eth1
  switchport
  udld state Enable
!
```

```
#sh udld interface eth1
UDLD Status      : Enable
UDLD Mode        : Normal
Link-State       : Unknown
```

For aggressive mode, udld output is as follows:

```
#show udld
  UDLD  : Enable
  Message Interval(sec) : 7
```

Port	UDLD Status	Mode	Link-Status
eth1	Enable	Aggressive	Bi-Directional

```
#sh running config
udld Enable
udld message-time 7
```

```
#sh running-config in eth1
  interface eth1
  switchport
```

Enable UDLD under bridge-group

S1

#configure terminal	Enter configure mode
(config)#bridge 1 protocol rstp	Bridge 1 config
(config)#udld enable	Enable UDLD globally
(config)#udld message-time 7	Configure message time for UDLD packets
(config)#commit	Commit config.
(config)#interface eth1	Enter interface mode
(config-if)#switchport	Configure the interface as switch port
(config-if)#bridge-group 1	Bridge group 1
(config-if)#udld state enable	Enable UDLD on the interface
(config-if)#udld mode normal	Configure udld mode as normal or aggressive
(config-if)#commit	Commit config.
(config-if)#exit	Exit from the interface mode

S2

#configure terminal	Enter configure mode.
(config)#bridge 1 protocol rstp	Bridge 1 config.
(config)#udld enable	Enable UDLD globally.
(config)#udld message-time 7	Configure message time for UDLD packets
(config)#commit	Commit config.
(config)#interface eth2	Enter interface mode
(config-if)#switchport	Configure the interface as switch port.
(config-if)#bridge-group 1	Bridge group 1
(config-if)#udld state enable	Enable UDLD on the interface.
(config-if)#udld mode normal	Configure udld mode as normal or aggressive
(config-if)#commit	Commit config.
(config-if)#exit	Exit from the interface mode

Validation

```
#sh running-config | i bridge 1
bridge 1 protocol rstp
```

```
#sh running-config in eth1
interface eth1
switchport
bridge-group 1
udld state Enable
```



```
#sh uddl
UDLD : Enable
Message Interval(sec) : 15
```

Port	UDLD Status	Mode	Link-Status
eth1	Enable	Normal	Bi-Directional

CHAPTER 25 MAC Authentication Bypass

MAC Authentication Bypass (MAB) is used for a non-authenticating device (a device without an 802.1X supplicant running on it) connecting to a network with 802.1X enabled. Since there is no supplicant to answer the EAP identity requests from the authenticator (switch, wireless controller, etc.) the authenticator will generate the authentication request for the endpoint using the endpoint's MAC address as the username/password for the Access-Request message.

Note: Multicast address is not accepted for host address of radius-server.

Topology

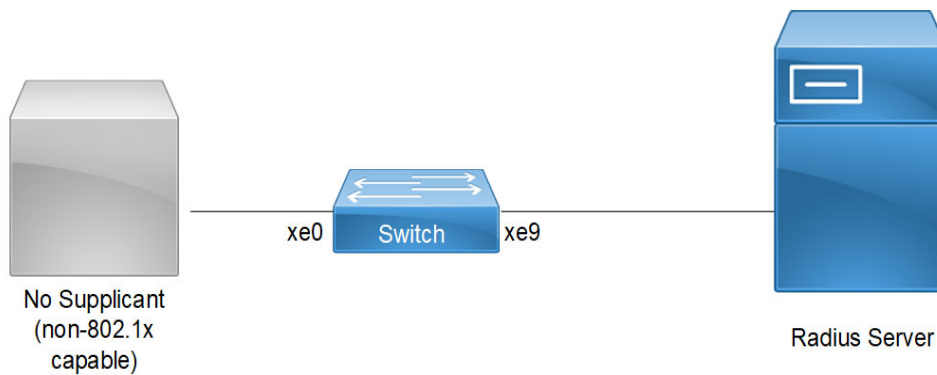

Figure 25-46: MAB Topology

Configuration

Switch Configuration for MAC Authentication Bypass (MAB)

Switch#configure terminal	Enter configure mode
Switch(config)#bridge 1 protocol ieee vlan-bridge	Create bridge 1
OcNOS(config)#commit	Commit candidate configuration to be running configuration
Switch(config)#port-security disable	Disable port security
Switch(config)#dot1x system-auth-ctrl	Enable dot1x authentication globally
Switch(config)#auth-mac system-auth-ctrl	Enable MAC authentication bypass globally
Switch(config)#radius-server dot1x host 10.1.1.1 key 0 testing123	Specify the host IP and key with string name between radius server and client.
Switch(config)#commit	Commit transaction
Switch(config)#interface xe0	Configure interface xe0
Switch(config-if)#switchport	Enable switch port on interface.
Switch(config-if)#bridge-group 1	Associate bridge to an interface.
Switch(config-if)#switchport mode access	Configure port as access
Switch(config-if)#dot1x port-control auto	Enable authentication (via Radius) on port (xe0)
Switch(config-if)#dot1x mac-auth-bypass enable	Enable MAC authentication bypass on interface

OcNOS(config)#commit	Commit candidate configuration to be running configuration
Switch(config)#interface xe9	Configure interface xe9
Switch(config-if)#ip address 10.1.1.2/24	Set the IP address on interface xe9
Switch(config-if)#commit	Commit transaction
Switch(config-if)#end	Exit config mode.

Validation

Verify MAB on Switch

```
Switch#show mab all
Global MAC Authentication Enabled
  RADIUS server address: 10.1.1.1:1812
  Next radius message id: 4
  RADIUS client address: not configured
```

```
MAB info for interface xe0
  Dot1x timer: Expired
  MAB Authentication Enabled
  Supplicant name: 00:07:E9:A5:3D:FA
  Status: MAC Authorized
  Last rejected MAC:
```

Configuration

MAC Authentication Configuration

Switch#configure terminal	Enter configure mode
Switch(config)#bridge 1 protocol ieee vlan-bridge	Create bridge 1
Switch(config)#port-security disable	Disable port security
Switch(config)#dot1x system-auth-ctrl	Enable dot1x authentication globally
Switch(config)#auth-mac system-auth-ctrl	Enable MAC authentication bypass globally
Switch(config)#radius-server dot1x host 10.1.1.1 key 0 testing123	Specify the host IP and key with string name between radius server and client.
Switch(config)#commit	Commit transaction
Switch(config)#interface xe0	Configure interface xe0
Switch(config-if)#switchport	Enable switch port on interface.
Switch(config-if)#bridge-group 1	Associate bridge to an interface.
Switch(config-if)#switchport mode access	Configure port as access
Switch(config-if)#auth-mac enable	Enable MAC authentication on interface
OcNOS(config)#commit	Commit candidate configuration to be running configuration
Switch(config)#interface xe9	Configure interface xe9
Switch(config-if)#ip address 10.1.1.2/24	Set the IP address on interface xe9

Switch(config-if)#commit	Commit transaction
Switch(config-if)#end	Exit config mode.

Note: When AUTH-MAC is enabled on the interface MAC-AUTH bypass cannot be enabled and vice-versa.

Validation

Verify MAB on Switch

```
Switch#show mab all
Global MAC Authentication Enabled
  RADIUS server address: 10.1.1.1:1812
  Next radius message id: 9
  RADIUS client address: not configured
```

```
MAB info for interface xe0
  Dot1x timer: Expired
  MAB Authentication Disabled
  Supplicant name: 00:07:E9:A5:3D:FA
  Status: MAC Authorized
  Last rejected MAC: 00:07:E9:A5:4E:25
```

CHAPTER 26 Traffic Segmentation-Protected Port

The protected port is a feature that does not forward any traffic (unicast, multicast, or broadcast) to any other port that is also a protected port. However, a protected port can communicate with an unprotected port and vice-versa.

The protected port is a feature that does not forward any traffic (unicast, multicast, or broadcast) to any other port that is also a protected port. However, a protected port can communicate with an unprotected port and vice-versa.

- Protected port(isolated) to protected port(isolated) - communication is not allowed.
- Protected port(isolated) to protected port(community) - communication is not allowed.
- Protected port(isolated) to protected port(promiscuous) - communication is allowed.
- Protected port(community) to protected port(community) - communication is allowed.
- Protected port(community) to protected port(promiscuous) - communication is allowed.
- Protected port(promiscuous) to protected port(promiscuous) - communication is allowed.
- Unprotected port to protected port(any type) - communication is allowed.

The protected port configuration is local to the switch. This information is not propagated outside the switch. Protected ports across switches can still be able to communicate with each other.

The use of protected ports ensures that there is no exchange of unicast, broadcast, or multicast data traffic between ports on the same switch so that one neighbor does not see the traffic generated by another neighbor.

Topology

Figure 26-47 displays Traffic Segmentation-Protected Port Topology

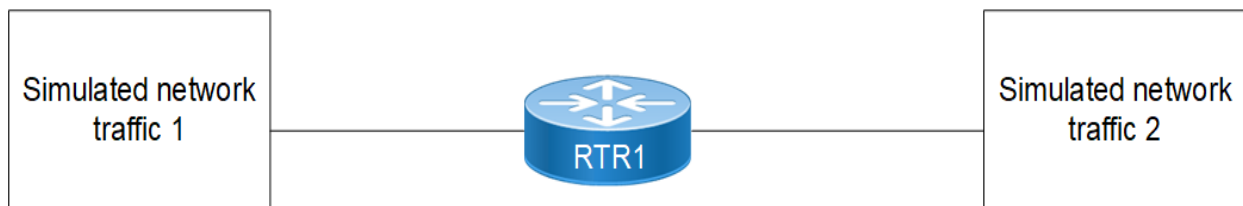

Figure 26-47: Traffic Segmentation-Protected Port Topology

Isolated-Promiscuous Configuration

RTR1

Bridge Configuration:

#configure terminal	Enter configure mode.
(config)#bridge 1 protocol ieee vlan-bridge	Configure bridge

VLAN Configuration:

#configure terminal	Enter configterminal mode
(config)#vlan database	Enter into the vlan database
(config-vlan)# vlan 30 bridge 1 state enable	Configure vlan 30 to bridge 1
(config-vlan)#Exit	Exit from the vlan database.
(config)#int xe1	Enter interface configuration mode for xe1
(config-if)#switchport	Configure switchport
(config-if)#bridge-group 1	Associate interface with bridge-group 1
(config-if)#switchport mode trunk	Set the switching characteristics of this interface as trunk
(config-if)#switchport trunk allowed vlan add 30	Configure vlan 30
(config-if)#switchport protected isolated	Configure interface as isolated port
(config-if)#exit	Exit from interface
(config)#int xe2	Enter interface configuration mode for xe2
(config-if)#switchport	Configure switchport
(config-if)#bridge-group 1	Associate interface with bridge-group 1
(config-if)#switchport mode trunk	Set the switching characteristics of this interface as trunk
(config-if)#switchport trunk allowed vlan add 30	Configure vlan 30
(config-if)#switchport protected promiscuous	Configure interface as promiscuous port
(config-if)#exit	Exit from interface mode
(config)#commit	Commit the configure on the node.

Validation**RTR1**

```
#show running-config interface xe1
!
interface xe1
switchport
    switchport protected isolated
    bridge-group 1
    switchport mode trunk
    switchport trunk allowed vlan add 30
!
#show running-config interface xe2
!
interface xe2
switchport
switchport protected promiscuous
bridge-group 1
switchport mode trunk
switchport trunk allowed vlan add 30
```

```
#show interface xe1
Interface xe1
  Flexport: Non Control Port (Active)
  Hardware is ETH Current HW addr: 80a2.353f.edb7
  Physical:80a2.353f.edb7 Logical:(not set)
  Forward Error Correction (FEC) configured is Auto (default)
  FEC status is N/A
  Port Mode is trunk
  Protected Mode is Isolated
  Interface index: 5001
  Metric 1 mtu 1500 duplex-full link-speed 10g
  Debounce timer: disable
  <UP,BROADCAST,RUNNING,MULTICAST>
  VRF Binding: Not bound
  Label switching is disabled
  No Virtual Circuit configured
  Administrative Group(s): None
  Bandwidth 10g
  DHCP client is disabled.
  Last Flapped: 2022 Jan 06 13:13:42 (00:24:53 ago)
  Statistics last cleared: 2022 Jan 06 13:13:42 (00:24:53 ago)
  5 minute input rate 0 bits/sec, 0 packets/sec
  5 minute output rate 256 bits/sec, 0 packets/sec
RX
  unicast packets 0 multicast packets 7 broadcast packets 0
  input packets 7 bytes 814
  jumbo packets 0
  undersize 0 oversize 0 CRC 0 fragments 0 jabbers 0
  input error 0
  input with dribble 0 input discard 7
  Rx pause 0
TX
  unicast packets 0 multicast packets 749 broadcast packets 0
  output packets 749 bytes 47944
  jumbo packets 0
  output errors 0 collision 0 deferred 0 late collision 0
  output discard 0
  Tx pause 0

#show interface xe2
Interface xe2
  Flexport: Non Control Port (Active)
  Hardware is ETH Current HW addr: 80a2.353f.edb9
  Physical:80a2.353f.edb9 Logical:(not set)
  Forward Error Correction (FEC) configured is Auto (default)
  FEC status is N/A
  Port Mode is trunk
  Protected Mode is Promiscuous
  Interface index: 5003
```

```

Metric 1 mtu 1500 duplex-full link-speed 10g
Debounce timer: disable
<UP,BROADCAST,RUNNING,MULTICAST>
VRF Binding: Not bound
Label switching is disabled
No Virtual Circuit configured
Administrative Group(s): None
Bandwidth 10g
DHCP client is disabled.
Last Flapped: Never
Statistics last cleared: 2022 Jan 06 13:15:32 (00:23:52 ago)
5 minute input rate 0 bits/sec, 0 packets/sec
5 minute output rate 0 bits/sec, 0 packets/sec
RX
  unicast packets 0 multicast packets 0 broadcast packets 0
  input packets 0 bytes 0
  jumbo packets 0
  undersize 0 oversize 0 CRC 0 fragments 0 jabbers 0
  input error 0
  input with dribble 0 input discard 0
  Rx pause 0
TX
  unicast packets 0 multicast packets 4569 broadcast packets 0
  input packets 4569 bytes 327802
  jumbo packets 0
  output errors 0 collision 0 deferred 0 late collision 0
  output discard 0
  Tx pause 0

```

```

Send the vlan 30 tagged traffic from traffic 1 to traffic 2,
#show interface counters rate mbps

```

```

+-----+-----+-----+-----+-----+
| Interface|Rx mbps|Rx pps|Tx mbps|Tx pps|
+-----+-----+-----+-----+-----+
|  Xe1      | 100.01 | 20   | 0.00  | 0     |
|  Xe2      | 0.00   | 0    | 100.01| 20    |

```

```

Send the vlan 30 tagged traffic from traffic 1 to traffic 2,
#show interface counters rate mbps

```

```

+-----+-----+-----+-----+-----+
| Interface|Rx mbps|Rx pps|Tx mbps|Tx pps|
+-----+-----+-----+-----+-----+
|  Xe1      | 0.00   | 20   | 100.00| 0     |
|  Xe2      | 100.00 | 0    | 0.00  | 20    |

```

Isolated-Isolated Configuration

RTR1

Bridge Configuration:

#configure terminal	Enter configure mode.
(config)#bridge 1 protocol ieee vlan-bridge	Configure bridge

VLAN Configuration:

#configure terminal	Enter configterminal mode
(config)#vlan database	Enter into the vlan database
(config-vlan)# vlan 30 bridge 1 state enable	Configure vlan 30 to bridge 1
(config-vlan)#Exit	Exit from the vlan database.
(config)#int xe1	Enter interface configuration mode for xe1
(config-if)#switchport	Configure switchport
(config-if)#bridge-group 1	Associate interface with bridge-group 1
(config-if)#switchport mode trunk	Set the switching characteristics of this interface as trunk
(config-if)#switchport trunk allowed vlan add 30	Configure vlan 30
(config-if)#switchport protected isolated	Configure interface as isolated port
(config-if)#exit	Exit from interface
(config)#int xe2	Enter interface configuration mode for xe2
(config-if)#switchport	Configure switchport
(config-if)#bridge-group 1	Associate interface with bridge-group 1
(config-if)#switchport mode trunk	Set the switching characteristics of this interface as trunk
(config-if)#switchport trunk allowed vlan add 30	Configure vlan 30
(config-if)#switchport protected isolated	Configure interface as isolated port
(config-if)#exit	Exit from interface mode
(config)#commit	Commit the configure on the node.

Validation

RTR1

```
#show running-config interface xe1
!
interface xe1
switchport
    switchport protected isolated
    bridge-group 1
```

```
switchport mode trunk
switchport trunk allowed vlan add 30
!
#show running-config interface xe2
!
interface xe2
switchport
switchport protected isolated
bridge-group 1
switchport mode trunk
switchport trunk allowed vlan add 30

#show interface xe1
Interface xe1
Flexport: Non Control Port (Active)
Hardware is ETH Current HW addr: 80a2.353f.edb7
Physical:80a2.353f.edb7 Logical:(not set)
Forward Error Correction (FEC) configured is Auto (default)
FEC status is N/A
Port Mode is trunk
Protected Mode is Isolated
Interface index: 5001
Metric 1 mtu 1500 duplex-full link-speed 10g
Debounce timer: disable
<UP,BROADCAST,RUNNING,MULTICAST>
VRF Binding: Not bound
Label switching is disabled
No Virtual Circuit configured
Administrative Group(s): None
Bandwidth 10g
DHCP client is disabled.
Last Flapped: 2022 Jan 06 13:13:42 (00:24:53 ago)
Statistics last cleared: 2022 Jan 06 13:13:42 (00:24:53 ago)
5 minute input rate 0 bits/sec, 0 packets/sec
5 minute output rate 256 bits/sec, 0 packets/sec
RX
  unicast packets 0 multicast packets 7 broadcast packets 0
  input packets 7 bytes 814
  jumbo packets 0
  undersize 0 oversize 0 CRC 0 fragments 0 jabbers 0
  input error 0
  input with dribble 0 input discard 7
  Rx pause 0
TX
  unicast packets 0 multicast packets 749 broadcast packets 0
  output packets 749 bytes 47944
  jumbo packets 0
  output errors 0 collision 0 deferred 0 late collision 0
  output discard 0
  Tx pause 0
```

#show interface xe2

Interface xe2

```

Flexport: Non Control Port (Active)
Hardware is ETH Current HW addr: 80a2.353f.edb9
Physical:80a2.353f.edb9 Logical:(not set)
Forward Error Correction (FEC) configured is Auto (default)
FEC status is N/A
Port Mode is trunk
Protected Mode is Isolated
Interface index: 5003
Metric 1 mtu 1500 duplex-full link-speed 10g
Debounce timer: disable
<UP,BROADCAST,RUNNING,MULTICAST>
VRF Binding: Not bound
Label switching is disabled
No Virtual Circuit configured
Administrative Group(s): None
Bandwidth 10g
DHCP client is disabled.
Last Flapped: Never
Statistics last cleared: 2022 Jan 06 13:15:32 (00:23:52 ago)
5 minute input rate 0 bits/sec, 0 packets/sec
5 minute output rate 0 bits/sec, 0 packets/sec

```

RX

```

unicast packets 0 multicast packets 0 broadcast packets 0
input packets 0 bytes 0
jumbo packets 0
undersize 0 oversize 0 CRC 0 fragments 0 jabbers 0
input error 0
input with dribble 0 input discard 0
Rx pause 0

```

TX

```

unicast packets 0 multicast packets 0 broadcast packets 0
output packets 0 bytes 0
jumbo packets 0
output errors 0 collision 0 deferred 0 late collision 0
output discard 0
Tx pause 0

```

Send the vlan 30 tagged traffic from traffic 1 to traffic 2,

#show interface counters rate mbps

```

+-----+-----+-----+-----+-----+
| Interface | Rx mbps | Rx pps | Tx mbps | Tx pps |
+-----+-----+-----+-----+-----+
| Xe1       | 100.01  | 20     | 0.00    | 0       |
| Xe2       | 0.00    | 0      | 0.00    | 0       |

```

CHAPTER 27 MLAG with Provider Bridging Configuration

This chapter contains sample MLAG with Provider bridging configuration.

A provider bridged network is a virtual bridged Local Area Network that comprises provider bridges (SVLAN bridges and provider edge bridges) and attached LANs, under the administrative control of a single service provider. Provider bridges interconnect the separate MACs of the IEEE 802 LANs that compose a provider bridged network, relaying frames to provide connectivity between all the LANs that provide customer interfaces for each service instance.

MLAG (also called DRNI, Distributed Resilient Network Interconnect) expands the concept of link aggregation so that it provides node-level redundancy by allowing two or more nodes to share a common LAG endpoint. MLAG emulates multiple nodes to represent as a single logical node to the remote node running link aggregation. As a result, even if one of the nodes is down there exists a path to reach the destination through the other nodes.

Note: For MLAG with PB, use provider rstp edge bridge on TOR (PEB) nodes and LEAF (PB) node.

Topology

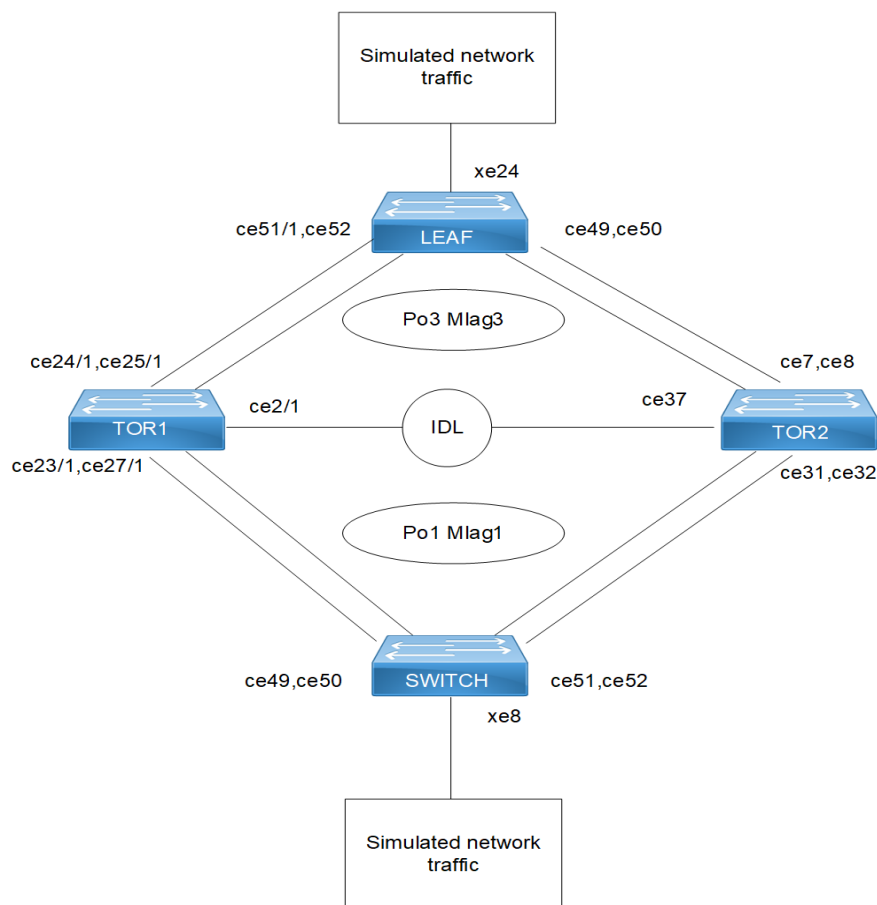

Figure 27-48: MLAG with Provider Bridging

Configuration

Switch

SWITCH#configure terminal	Enter configuration mode
SWITCH(config)#bridge 1 protocol rstp vlan-bridge	Configure the rstp vlan bridge
SWITCH(config)#vlan database	Enter VLAN configuration mode
SWITCH(config-vlan)#vlan 2-2000 bridge 1 state enable	Create vlan for bridge
SWITCH(config-vlan)#exit	Exit VLAN configuration mode
SWITCH(config)#interface po1	Enter interface configuration mode for po1
SWITCH(config-if)#switchport	Configure switchport
SWITCH(config-if)#bridge-group 1 spanning-tree disable	Associate interface with bridge-group 1 by disblaing spanning tree
SWITCH(config-if)#switchport mode trunk	Configure switchport mode as trunk
SWITCH(config-if)#switchport trunk allowed vlan all	Associate created vlans to po1 interface
SWITCH(config-if)#exit	Exit from interface mode
SWITCH(config)#interface xe8	Enter interface configuration mode for xe8
SWITCH(config-if)#switchport	Configure switchport
SWITCH(config-if)#bridge-group 1 spanning-tree disable	Associate interface with bridge-group 1 by disblaing spanning tree
SWITCH(config-if)#switchport mode trunk	Configure switchport mode as trunk
SWITCH(config-if)#switchport trunk allowed vlan all	Associate created vlans to xe8 interface
SWITCH(config-if)#exit	Exit from interface mode
SWITCH(config)#interface ce49	Enter interface configuration mode for ce49
SWITCH(config-if)# channel-group 1 mode active	Configure interface as member port for po1- port channel
SWITCH(config-if)#exit	Exit from interface mode
SWITCH(config)#interface ce50	Enter interface configuration mode for ce49
SWITCH(config-if)#channel-group 1 mode active	Configure interface as member port for po1- port channel
SWITCH(config-if)#exit	Exit from interface mode
SWITCH(config)#interface ce51	Enter interface configuration mode for ce49
SWITCH(config-if)#channel-group 1 mode active	Configure interface as member port for po1- port channel
SWITCH(config-if)#exit	Exit from interface mode
SWITCH(config)#interface ce52	Enter interface configuration mode for ce49
SWITCH(config-if)#channel-group 1 mode active	Configure interface as member port for po1- port channel
SWITCH(config-if)#exit	Exit from interface mode

SWITCH(config)#commit	Commit the candidate configuration to the running configuration.
SWITCH(config)#exit	Exit from config mode

TOR1 (PEB)

TOR1#configure terminal	Enter configuration mode
TOR1(config)#bridge 1 protocol provider-rstp edge	Create provider rstp edge bridge
TOR1(config)#vlan database	Enter VLAN configuration mode
TOR1(config-vlan)#vlan 2-500 type customer bridge 1 state enable	Create customer vlan VLAN 2-500
TOR1(config-vlan)#vlan 501-1005 type service point-point bridge 1 state enable	Create service vlan VLAN 501-1005
TOR1(config-vlan)#exit	Exit VLAN configuration mode
TOR1(config)#cvlan registration table cvlan100 bridge 1	Create cvlan registration table with name cvlan100
TOR1(config-cvlan-registration)#cvlan 100 svlan 1000	Map cvlan100 with svlan 1000
TOR1(config-cvlan-registration)#exit	Exit registration table
TOR1(config)#hardware-profile filter egress-l2 enable	Enable the hardware-profile filter for egress l2.
TOR1(config)#interface mlag1	Enter interface configuration mode for mlag1
TOR1(config-if)#switchport	Configure switchport
TOR1(config-if)#bridge-group 1 spanning-tree disable	Associate interface with bridge-group 1 and disable spanning-tree
TOR1(config-if)#switchport mode customer-edge trunk	Configure switchport mode customer edge
TOR1(config-if)# switchport customer-edge trunk allowed vlan add 100	Associate customer vlan100 to interface
TOR1(config-if)#switchport customer-edge vlan registration cvlan100	Attach registration table cvlan100 to interface
TOR1(config-if)#mode active-active	Configure mlag mode as active-active
TOR1(config-if)#exit	Exit interface mode
TOR1(config)#interface mlag3	Enter interface configuration mode for mlag3
TOR1(config-if)#switchport	Make interface as switchport
TOR1(config-if)# bridge-group 1 spanning-tree disable	Associate interface with bridge-group 1 and disable spanning-tree
TOR1(config-if)#switchport mode provider-network	Configure switchport pnp port
TOR1(config-if)#switchport provider-network allowed vlan all	Associate all svlan to the port
TOR1(config-if)#mode active-active	Configure mlag mode as active-active
TOR1(config-if)#exit	Exit interface configuration mode
TOR1(config)#interface po1	Enter interface configuration mode for po1
TOR1(config-if)#switchport	Make interface as switchport

TOR1 (config-if) #mlag 1	Associate mlag1 interface to po1
TOR1 (config-if) #exit	Exit interface configuration mode
TOR1 (config) #interface po3	Enter interface configuration mode for po3
TOR1 (config-if) #switchport	Make interface as switchport
TOR1 (config-if) #dot1ad ethertype 0x88a8	Configure TPID with 88a8 to send and receive double tag (Q in Q)
TOR1 (config-if) #mlag 3	Associate mlag3 interface to po3
TOR1 (config-if) #exit	Exit interface configuration mode
TOR1 (config) #interface ce2/1	Enter interface configuration mode for ce2/1 which is an IDL link
TOR1 (config-if) #switchport	Make interface as switchport
TOR1 (config-if) #exit	Exit interface configuration mode
TOR1 (config) #interface ce24/1	Enter interface configuration mode for ce24/1
TOR1 (config-if) #channel-group 3 mode active	Configure interface as member port for po3- port channel
TOR1 (config-if) #exit	Exit interface configuration mode
TOR1 (config) # interface ce25/1	Enter interface configuration mode for ce25/1
TOR1 (config-if) #channel-group 3 mode active	Configure interface as member port for po3- port channel
TOR1 (config-if) #exit	Exit interface configuration mode
TOR1 (config) #interface ce23/1	Enter interface configuration mode for ce23/1
TOR1 (config-if) #channel-group 1 mode active	Configure interface as member port for po1- port channel
TOR1 (config-if) #exit	Exit interface configuration mode
TOR1 (config) #interface ce27/1	Enter interface configuration mode for ce2471
TOR1 (config-if) #channel-group 1 mode active	Configure interface as member port for po1- port channel
TOR1 (config-if) #exit	Exit interface configuration mode
TOR1 (config) #mcec domain configuration	Enter mcec domain configuration mode
TOR1 (config-mcec-domain) #domain-address 2222.3333.4444	Configure domain address for mlag domain
TOR1 (config-mcec-domain) #domain-system-number 1	Configure domain number to identify node in a domain
TOR1 (config-mcec-domain) #intra-domain-link ce2/1	Configure intra domain link between tor nodes mlag domain
TOR1 (config-mcec-domain) #exit	Exit from mcec domain mode
TOR1 (config) #commit	Commit the candidate configuration to the running configuration.
TOR1 (config) #exit	Exit from config mode

TOR2 (PEB)

TOR2#configure terminal	Enter configuration mode
TOR2 (config) #bridge 1 protocol provider-rstp edge	Create provider rstp edge bridge
TOR2 (config) #vlan database	Enter VLAN configuration mode
TOR2 (config-vlan) #vlan 2-500 type customer bridge 1 state enable	Create customer vlan VLAN 2-500

TOR2(config-vlan)#vlan 501-1005 type service point-point bridge 1 state enable	Create service vlan VLAN 501-1005
TOR2(config-vlan)#exit	Exit VLAN configuration mode
TOR2(config)#cvlan registration table cvlan100 bridge 1	Create cvlan registration table with name cvlan100
TOR2(config-cvlan-registration)#cvlan 100 svlan 1000	Map cvlan100 with svlan 1000
TOR2(config-cvlan-registration)#exit	Exit registration table
TOR2(config)#hardware-profile filter egress-l2 enable	Enable the hardware-profile filter for egress l2.
TOR2(config)#interface mlag1	Enter interface configuration mode for mlag1
TOR2(config-if)#switchport	Configure switchport
TOR2(config-if)#bridge-group 1 spanning-tree disable	Associate interface with bridge-group 1 and disable spanning-tree
TOR2(config-if)#switchport mode customer-edge trunk	Configure switchport mode customer edge
TOR2(config-if)# switchport customer-edge trunk allowed vlan add 100	Associate customer vlan 100 to interface
TOR2(config-if)#switchport customer-edge vlan registration cvlan100	Attach registration table cvlan100 to interface
TOR2(config-if)#mode active-active	Configure mlag mode as active-active
TOR2(config-if)#exit	Exit interface mode
TOR2(config)#interface mlag3	Enter interface configuration mode for mlag3
TOR2(config-if)#switchport	Make interface as switchport
TOR2(config-if)# bridge-group 1 spanning-tree disable	Associate interface with bridge-group 1 and disable spanning-tree
TOR2(config-if)#switchport mode provider-network	Configure switchport pnp port
TOR2(config-if)#switchport provider-network allowed vlan all	Associate all svlan to the port
TOR2(config-if)#mode active-active	Configure mlag mode as active-active
TOR2(config-if)#exit	Exit interface configuration mode
TOR2(config)#interface po1	Enter interface configuration mode for po1
TOR2(config-if)#switchport	Make interface as switchport
TOR2(config-if)#mlag 1	Associate mlag1 interface to po1
TOR2(config-if)#exit	Exit interface configuration mode
TOR2(config)#interface po3	Enter interface configuration mode for po3
TOR2(config-if)#switchport	Make interface as switchport
TOR2(config-if)#dot1ad ethertype 0x88a8	Configure TPID with 88a8 to send and receive double tag (Q in Q)
TOR2(config-if)#mlag 3	Associate mlag1 interface to po3
TOR2(config-if)#exit	Exit interface configuration mode
TOR2(config)#interface ce37	Enter interface configuration mode for ce2/1 which is an IDL link
TOR2(config-if)#switchport	Make interface as switchport

TOR2 (config-if) #exit	Exit interface configuration mode
TOR2 (config) #interface ce7	Enter interface configuration mode for ce7
TOR2 (config-if) #channel-group 3 mode active	Configure interface as member port for po3- port channel
TOR2 (config-if) #exit	Exit interface configuration mode
TOR2 (config) # interface ce8	Enter interface configuration mode for ce8
TOR2 (config-if) #channel-group 3 mode active	Configure interface as member port for po3- port channel
TOR2 (config-if) #exit	Exit interface configuration mode
TOR2 (config) #interface ce31	Enter interface configuration mode for ce31
TOR2 (config-if) #channel-group 1 mode active	Configure interface as member port for po1- port channel
TOR2 (config-if) #exit	Exit interface configuration mode
TOR2 (config) #interface ce32	Enter interface configuration mode for ce32
TOR2 (config-if) #channel-group 1 mode active	Configure interface as member port for po1- port channel
TOR2 (config-if) #exit	Exit interface configuration mode
TOR2 (config) #mcec domain configuration	Enter mcec domain configuration mode
TOR2 (config-mcec-domain) #domain-address 2222.3333.4444	Configure domain address for mlag domain
TOR2 (config-mcec-domain) #domain-system-number 2	Configure domain number to identify node in a domain
TOR2 (config-mcec-domain) #intra-domain-link ce37	Configure intra domain link between tor nodes mlag domain
TOR2 (config-mcec-domain) #exit	Exit interface configuration mode
TOR2 (config) #commit	Commit the candidate configuration to the running configuration.
TOR2 (config) #exit	Exit interface configuration mode

LEAF(PB)

LEAF#configure terminal	Enter configuration mode
LEAF (config) # bridge 1 protocol provider-rstp edge	Create provider rstp edge bridge
LEAF (config) #vlan database	Enter VLAN configuration mode
LEAF (config-vlan) #vlan 2-500 type customer bridge 1 state enable	Create customer vlan VLAN 2-500
LEAF (config-vlan) #vlan 501-1005 type service point-point bridge 1 state enable	Create service vlan VLAN 501-1005
LEAF (config-vlan) #exit	Exit VLAN configuration mode
LEAF (config) #interface po3	Enter interface configuration mode for po3
LEAF (config-if) #switchport	Make interface as switchport
LEAF (config-if) #dot1ad ethertype 0x88a8	Configure TPID with 88a8 to send and receive double tag (Q in Q)
LEAF (config-if) #bridge-group 1 spanning-tree disable	Associate interface with bridge-group 1 and disable spanning-tree
LEAF (config-if) #switchport mode provider-network	Configure switchport pnp port

LEAF(config-if)#switchport provider-network allowed vlan all	Associate all svlan to the port
LEAF(config-if)#exit	Exit interface configuration mode
LEAF(config)#interface xe24	Enter interface configuration mode for xe24
LEAF(config-if)#switchport	Make interface as switchport
LEAF(config-if)#dot1ad ethertype 0x88a8	Configure TPID with 88a8 to send and receive double tag (Q in Q)
LEAF(config-if)#bridge-group 1 spanning-tree disable	Associate interface with bridge-group 1 and disable spanning-tree
LEAF(config-if)#switchport mode provider-network	Configure switchport pnp port
LEAF(config-if)#switchport provider-network allowed vlan all	Associate all svlan to the port
LEAF(config-if)#exit	Exit interface configuration mode
LEAF(config)#interface ce49	Enter interface configuration mode for ce49
LEAF(config-if)# channel-group 3 mode active	Configure interface as member port for po3- port channel
LEAF(config-if)#exit	Exit interface configuration mode
LEAF(config)#interface ce50	Enter interface configuration mode for ce50
LEAF(config-if)# channel-group 3 mode active	Configure interface as member port for po3- port channel
LEAF(config-if)#exit	Exit interface configuration mode
LEAF(config)#interface ce51	Enter interface configuration mode for ce51
LEAF(config-if)# channel-group 3 mode active	Configure interface as member port for po3- port channel
LEAF(config-if)#exit	Exit interface configuration mode
LEAF(config)#interface ce52	Enter interface configuration mode for ce52
LEAF(config-if)# channel-group 3 mode active	Configure interface as member port for po3- port channel
LEAF(config-if)#exit	Exit interface configuration mode
LEAF(config)#commit	Commit the candidate configuration to the running configuration.
LEAF(config)#exit	Exit from config mode

Validation

Validation commands are : show mlag domain summary , show mlag domain details, show ether-channel summary, show bridge, Show mac address-table bridge <bridge-id>, show cvlan registration table bridge <bridge-id>

For below show mac table output sending cvlan 100 traffic from SWITCH to LEAF, for which TOR nodes add svlan 1000 and egress same to LEAF and LEAF ixia also receives double tag.

```
TOR1#show mlag domain details
```

```
-----
Domain Configuration
-----
```

```
Domain System Number      : 1
Domain Address            : 2222.3333.4444
Domain Priority           : 32768
Intra Domain Interface    : ce2/1

Hello RCV State          : Current
Hello Periodic Timer State : Slow Periodic
Domain Sync               : IN_SYNC
Neigh Domain Sync        : IN_SYNC
Domain Adjacency         : UP
Domain Sync via          : Intra-domain-interface
```

```
-----
MLAG Configuration
-----
```

MLAG-1

```
Mapped Aggregator        : po1
Admin Key                : 16385
Oper Key                 : 16385
Physical status          : 1
Physical properties Digest : 1b bc c2 24 5a 1c cf 6 88 32 a1 4b 62 c2 c0 2

Neigh Admin Key          : 32769
Neigh Physical status    : 1
Neigh Physical Digest    : 1b bc c2 24 5a 1c cf 6 88 32 a1 4b 62 c2 c0 2
Info RCV State           : Current
Info Periodic Time State : Standby
Mlag Sync                 : IN_SYNC
Mode                     : Active-Active
Current Mlag state       : Active
```

MLAG-3

```
Mapped Aggregator        : po3
Admin Key                : 16387
Oper Key                 : 16387
Physical status          : 1
Physical properties Digest : 46 51 95 9d e2 90 81 47 d0 51 d9 de 4f 8 48 93

Neigh Admin Key          : 32771
Neigh Physical status    : 1
Neigh Physical Digest    : 46 51 95 9d e2 90 81 47 d0 51 d9 de 4f 8 48 93
Info RCV State           : Current
Info Periodic Time State : Standby
Mlag Sync                 : IN_SYNC
Mode                     : Active-Active
Current Mlag state       : Active
```

TOR1#

TOR1#show mlag domain summary

Domain Configuration

Domain System Number : 1
Domain Address : 2222.3333.4444
Domain Priority : 32768
Intra Domain Interface : ce2/1
Domain Adjacency : UP
Domain Sync via : Intra-domain-interface

MLAG Configuration

MLAG-1

Mapped Aggregator : po1
Physical properties Digest : 1b bc c2 24 5a 1c cf 6 88 32 a1 4b 62 c2 c0 2
Total Bandwidth : 400g
Mlag Sync : IN_SYNC
Mode : Active-Active
Current Mlag state : Active

MLAG-3

Mapped Aggregator : po3
Physical properties Digest : 46 51 95 9d e2 90 81 47 d0 51 d9 de 4f 8 48 93
Total Bandwidth : 400g
Mlag Sync : IN_SYNC
Mode : Active-Active
Current Mlag state : Active

TOR1#

TOR1#show etherchannel summary

Aggregator po1 100001
Aggregator Type: Layer2
Admin Key: 16385 - Oper Key 16385
Link: ce23/1 (5001) sync: 1 (Mlag-active-link)
Link: ce27/1 (5029) sync: 1 (Mlag-active-link)

Aggregator po3 100003
Aggregator Type: Layer2
Admin Key: 16387 - Oper Key 16387
Link: ce25/1 (5005) sync: 1 (Mlag-active-link)
Link: ce24/1 (5117) sync: 1 (Mlag-active-link)

TOR1#

TOR2#show mlag domain details

Domain Configuration

Domain System Number : 2
Domain Address : 2222.3333.4444
Domain Priority : 32768
Intra Domain Interface : ce37

Hello RCV State : Current
Hello Periodic Timer State : Slow Periodic
Domain Sync : IN_SYNC
Neigh Domain Sync : IN_SYNC
Domain Adjacency : UP
Domain Sync via : Intra-domain-interface

MLAG Configuration

MLAG-1

Mapped Aggregator : po1
Admin Key : 32769
Oper Key : 16385
Physical status : 1
Physical properties Digest : 1b bc c2 24 5a 1c cf 6 88 32 a1 4b 62 c2 c0 2

Neigh Admin Key : 16385
Neigh Physical status : 1
Neigh Physical Digest : 1b bc c2 24 5a 1c cf 6 88 32 a1 4b 62 c2 c0 2
Info RCV State : Current
Info Periodic Time State : Standby
Mlag Sync : IN_SYNC
Mode : Active-Active
Current Mlag state : Active

MLAG-3

Mapped Aggregator : po3
Admin Key : 32771
Oper Key : 16387
Physical status : 1
Physical properties Digest : 46 51 95 9d e2 90 81 47 d0 51 d9 de 4f 8 48 93

Neigh Admin Key : 16387
Neigh Physical status : 1
Neigh Physical Digest : 46 51 95 9d e2 90 81 47 d0 51 d9 de 4f 8 48 93
Info RCV State : Current
Info Periodic Time State : Standby

```
Mlag Sync           : IN_SYNC
Mode                : Active-Active
Current Mlag state  : Active
```

```
TOR2# show mlag domain summary
```

```
-----
Domain Configuration
-----
```

```
Domain System Number      : 2
Domain Address            : 2222.3333.4444
Domain Priority           : 32768
Intra Domain Interface    : ce37
Domain Adjacency         : UP
Domain Sync via          : Intra-domain-interface
```

```
-----
MLAG Configuration
-----
```

```
MLAG-1
```

```
Mapped Aggregator       : po1
Physical properties Digest : 1b bc c2 24 5a 1c cf 6 88 32 a1 4b 62 c2 c0 2
Total Bandwidth         : 400g
Mlag Sync               : IN_SYNC
Mode                    : Active-Active
Current Mlag state      : Active
```

```
MLAG-3
```

```
Mapped Aggregator       : po3
Physical properties Digest : 46 51 95 9d e2 90 81 47 d0 51 d9 de 4f 8 48 93
Total Bandwidth         : 400g
Mlag Sync               : IN_SYNC
Mode                    : Active-Active
Current Mlag state      : Active
```

```
TOR2#
```

```
TOR2#show etherchannel summary
```

```
Aggregator po1 100001
Aggregator Type: Layer2
Admin Key: 32769 - Oper Key 16385
  Link: ce31 (5062) sync: 1 (Mlag-active-link)
  Link: ce32 (5064) sync: 1 (Mlag-active-link)
```

```
-----
Aggregator po3 100003
Aggregator Type: Layer2
Admin Key: 32771 - Oper Key 16387
  Link: ce7 (5029) sync: 1 (Mlag-active-link)
  Link: ce8 (5031) sync: 1 (Mlag-active-link)
```

TOR2#

SWITCH2#show bridge

bridge 1 is running on rstp vlan-bridge

Ageout time is global and if something is configured for vxlan then it will be affected here also

Bridge	CVLAN	SVLAN	BVLAN	Port	MAC Address	FWD	Time-out
1	100			xe8	0000.2223.2425	1	300

SWITCH2#

SWITCH2#

SWITCH2#show mac address-table bridge 1

CVLAN	SVLAN	MAC Address	Type	Ports	Port-security
100		0000.2223.2425	dynamic	xe8	Disable

SWITCH2#

TOR1# show bridge

bridge 1 is running on provider-rstp edge

Ageout time is global and if something is configured for vxlan then it will be affected here also

Bridge	CVLAN	SVLAN	BVLAN	Port	MAC Address	FWD	Time-out
1		1000		m1ag1	0000.2223.2425	1	300

TOR1#show mac address-table bridge 1

CVLAN	SVLAN	MAC Address	Type	Ports	Port-security
	1000	0000.2223.2425	dynamic	m1ag1	Disable

TOR1#

TOR2#show bridge

bridge 1 is running on provider-rstp edge

Ageout time is global and if something is configured for vxlan then it will be affected here also

Bridge	CVLAN	SVLAN	BVLAN	Port	MAC Address	FWD	Time-out
1		1000		m1ag1	0000.2223.2425	1	300

TOR2#

TOR2#

TOR2#show mac address-table bridge 1

CVLAN	SVLAN	MAC Address	Type	Ports	Port-security
	1000	0000.2223.2425	dynamic	m1ag1	Disable

TOR2#

```
LEAF#show mac address-table bridge 1
CVLAN  SVLAN  MAC Address      Type      Ports      Port-security
-----+-----+-----+-----+-----+-----
          1000  0000.2223.2425  dynamic   po3        Disable
LEAF#
```

```
LEAF#show bridge
bridge 1 is running on provider-rstp edge
Ageout time is global and if something is configured for vxlan then it will be affected here also
Bridge      CVLAN  SVLAN  BVLAN  Port      MAC Address      FWD  Time-out
-----+-----+-----+-----+-----+-----+-----+-----+
1           1000          po3     0000.2223.2425  1      300
LEAF#
```

Now send traffic with svlan-1000 and c-vlan 100 from LEAF to SWITCH, Tor removes svlan and send only cvlan to SWITCH

```
LEAF#show bridge
bridge 1 is running on provider-rstp edge
Ageout time is global and if something is configured for vxlan then it will be affected here also
Bridge      CVLAN  SVLAN  BVLAN  Port      MAC Address      FWD  Time-out
-----+-----+-----+-----+-----+-----+-----+-----+
1           1000          po3     0000.2223.2425  1      300
1           1000          xe24    0000.2425.2627  1      300
LEAF#
```

```
LEAF#show mac address-table bridge 1
CVLAN  SVLAN  MAC Address      Type      Ports      Port-security
-----+-----+-----+-----+-----+-----
          1000  0000.2223.2425  dynamic   po3        Disable
          1000  0000.2425.2627  dynamic   xe24       Disable
LEAF#
```

```
TOR1#show bridge
bridge 1 is running on provider-rstp edge
Ageout time is global and if something is configured for vxlan then it will be affected here also
Bridge      CVLAN  SVLAN  BVLAN  Port      MAC Address      FWD  Time-out
-----+-----+-----+-----+-----+-----+-----+-----+
1           1000          mlag1    0000.2223.2425  1      300
1           1000          mlag3    0000.2425.2627  1      300
```

TOR1#

TOR1#show mac address-table bridge 1

CVLAN	SVLAN	MAC Address	Type	Ports	Port-security
	1000	0000.2223.2425	dynamic	m1ag1	Disable
	1000	0000.2425.2627	dynamic	m1ag3	Disable

TOR1#

TOR2#show bridge

bridge 1 is running on provider-rstp edge

Ageout time is global and if something is configured for vxlan then it will be affected here also

Bridge	CVLAN	SVLAN	BVLAN	Port	MAC Address	FWD	Time-out
1		1000		m1ag1	0000.2223.2425	1	300
1		1000		m1ag3	0000.2425.2627	1	300

TOR2#

TOR2#show mac address-table bridge 1

CVLAN	SVLAN	MAC Address	Type	Ports	Port-security
	1000	0000.2223.2425	dynamic	m1ag1	Disable
	1000	0000.2425.2627	dynamic	m1ag3	Disable

TOR2#

SWITCH2#show bridge

bridge 1 is running on rstp vlan-bridge

Ageout time is global and if something is configured for vxlan then it will be affected here also

Bridge	CVLAN	SVLAN	BVLAN	Port	MAC Address	FWD	Time-out
1	100			xe8	0000.2223.2425	1	300
1	100			po1	0000.2425.2627	1	300

SWITCH2#

SWITCH2#show mac address-table bridge 1

CVLAN	SVLAN	MAC Address	Type	Ports	Port-security
100		0000.2223.2425	dynamic	xe8	Disable
100		0000.2425.2627	dynamic	po1	Disable

SWITCH2#

L2CP with MLAG-Provider Bridging Configuring

Switch

SWITCH#configure terminal	Enter configuration mode
SWITCH(config)#interface xe8	Enter interface configuration mode for xe8
SWITCH(config-if)#switchport	Configure switchport
SWITCH(config-if)#bridge-group 1 spanning-tree disable	Associate interface with bridge-group 1 by disblaing spanning tree
SWITCH(config-if)#switchport mode trunk	Configure switchport mode as trunk
SWITCH(config-if)#switchport trunk allowed vlan all	Associate created vlans to xe8 interface
SWITCH(config-if)#l2protocol stp/lldp/elmi/efm/dot1x tunnel	Configure STP/LLDP/ELMI/EFM/dot1x protocol as Tunnel
SWITCH(config-if)#l2protocol stp tunnel	Configure STP protocol as Tunnel
SWITCH(config-if)#l2protocol lldp tunnel	Configure LLDP protocol as Tunnel
SWITCH(config-if)#l2protocol elmi tunnel	Configure ELMI protocol as Tunnel
SWITCH(config-if)#l2protocol efm tunnel	Configure EFM protocol as Tunnel
SWITCH(config-if)#l2protocol dot1x tunnel	Configure dot1x protocol as Tunnel
SWITCH(config-if)#exit	Exit from interface mode
SWITCH(config)#commit	Commit the candidate configuration to the running configuration.

TOR1 (PEB)

TOR1#configure terminal	Enter configuration mode
TOR1(config)#interface mlag1	Enter interface configuration mode for mlag1
TOR1(config-if)#switchport	Configure switchport
TOR1(config-if)#bridge-group 1 spanning-tree disable	Associate interface with bridge-group 1 and disable spanning-tree
TOR1(config-if)#switchport mode customer-edge trunk	Configure switchport mode customer edge
TOR1(config-if)# switchport customer-edge trunk allowed vlan add 100	Associate customer vlan100 to interface
TOR1(config-if)#switchport customer-edge vlan registration cvlan100	Attach registration table cvlan100 to interface
TOR1(config-if)#mode active-active	Configure mlag mode as active-active
TOR1(config-if)#l2protocol stp/lldp/elmi/efm/dot1x tunnel/peer/discard	Configure STP/LLDP/ELMI/EFM/dot1x protocol as tunnel/peer/discard

SWITCH(config-if)#l2protocol stp tunnel	Configure STP protocol as Tunnel
SWITCH(config-if)#l2protocol lldp tunnel	Configure LLDP protocol as Tunnel
SWITCH(config-if)#l2protocol elmi tunnel	Configure ELMI protocol as Tunnel
SWITCH(config-if)#l2protocol efm tunnel	Configure EFM protocol as Tunnel
SWITCH(config-if)#l2protocol dot1x tunnel	Configure dot1x protocol as Tunnel
TOR1 (config-if)#exit	Exit interface mode
TOR1 (config)#commit	Commit the candidate configuration to the running configuration.

TOR2 (PEB)

TOR2#configure terminal	Enter configuration mode
TOR2 (config)#interface mlag1	Enter interface configuration mode for mlag1
TOR2 (config-if)#switchport	Configure switchport
TOR2 (config-if)#bridge-group 1 spanning-tree disable	Associate interface with bridge-group 1 and disable spanning-tree
TOR2 (config-if)#switchport mode customer-edge trunk	Configure switchport mode customer edge
TOR2 (config-if)# switchport customer-edge trunk allowed vlan add 100	Associate customer vlan 100 to interface
TOR2 (config-if)#switchport customer-edge vlan registration cvlan100	Attach registration table cvlan100 to interface
TOR2 (config-if)#mode active-active	Configure mlag mode as active-active
TOR2 (config-if)#l2protocol stp/lldp/elmi/efm/dot2x tunnel/peer/discard	Configure STP/LLDP/ELMI/EFM/dot1x protocol as tunnel/peer/discard
SWITCH(config-if)#l2protocol stp tunnel	Configure STP protocol as Tunnel
SWITCH(config-if)#l2protocol lldp tunnel	Configure LLDP protocol as Tunnel
SWITCH(config-if)#l2protocol elmi tunnel	Configure ELMI protocol as Tunnel
SWITCH(config-if)#l2protocol efm tunnel	Configure EFM protocol as Tunnel
SWITCH(config-if)#l2protocol dot1x tunnel	Configure dot1x protocol as Tunnel
TOR2 (config-if)#exit	Exit interface mode
TOR2 (config)#commit	Commit the candidate configuration to the running configuration.

Validation

Switch:

SWITCH#show l2protocol processing interface xe8

Bridge	Interface Name	Protocol	Processing Status	Hardware Status
--------	----------------	----------	-------------------	-----------------

```

=====
1      xe8      stp      Tunnel      Tunnel
1      xe8      lacp     None        Peer
1      xe8      dot1x    Tunnel      Tunnel
1      xe8      lldp     Tunnel      Tunnel
1      xe8      efm      Tunnel      Tunnel
1      xe8      elmi     Tunnel      Tunnel
=====

```

TOR1:

```
TOR1#show l2protocol processing interface mlag1
```

```

Bridge   Interface Name  Protocol  Processing Status  Hardware Status
=====
1        mlag1        stp       Tunnel             -
1        mlag1        lacp      None              -
1        mlag1        dot1x     Discard           -
1        mlag1        lldp      Tunnel            -
1        mlag1        efm       Discard           -
1        mlag1        elmi      Peer              -
1        mlag1        synce     None              -
=====

```

```
TOR1#show l2protocol processing interface ce23/1
```

```

Bridge   Interface Name  Protocol  Processing Status  Hardware Status
=====
1        ce23/1        stp       Tunnel             Tunnel
1        ce23/1        lacp      None              Peer
1        ce23/1        dot1x     Discard           Discard
1        ce23/1        lldp      Tunnel            Tunnel
1        ce23/1        efm       Discard           Discard
1        ce23/1        elmi      Peer              Peer
1        ce23/1        synce     None              Peer
=====

```

```
TOR1#show l2protocol interface mlag1 counters
```

```

Interface mlag1
Tunnel          : stp          : 241782

```

TOR2:

```
TOR2#show l2protocol processing interface mlag1
```

```

Bridge   Interface Name  Protocol  Processing Status  Hardware Status
=====
1        mlag1        stp       Tunnel             -
1        mlag1        lacp      None              -
1        mlag1        dot1x     Discard           -
1        mlag1        lldp      Tunnel            -
=====

```

1	m1ag1	efm	Discard	-
1	m1ag1	elmi	Peer	-
1	m1ag1	synce	None	-

TOR2#show l2protocol processing interface ce32

Bridge	Interface Name	Protocol	Processing Status	Hardware Status
=====	=====	=====	=====	=====
1	ce32	stp	Tunnel	Tunnel
1	ce32	lacp	None	Peer
1	ce32	dot1x	Discard	Discard
1	ce32	lldp	Tunnel	Tunnel
1	ce32	efm	Discard	Discard
1	ce32	elmi	Peer	Peer
1	ce32	synce	None	Peer

CHAPTER 28 Support IGMP Snooping for Provider Bridge

Overview

In Layer-2 switches, multicast IP traffic is handled in the same manner as broadcast traffic and forwards frames received on one interface to all other interfaces. This creates excessive traffic on the network, and affects network performance. The Internet Group Management Protocol (IGMP) Snooping allows switches to monitor network traffic, and determine hosts to receive multicast traffic. Thus, at a time only an host's membership report is relayed from a group instead of a report from each host in the group.

A Provider Bridge (PB) network is a virtual bridge Local Area Network (LAN) that comprises of Service provider bridges (SVLAN and PB) and attached LANs controlled under a single service provider administration. Provider bridges interconnect the MACs of the IEEE 802 LANs separately. This combined provider bridged network relay frames to all the connected LANs that provide customer interfaces for each service instance.

Feature Characteristics

The existing IGMP Snooping extended to support in the Provider Bridged (PB) network. The PB connects customer LANs using the switched provider network consisting of SVLAN bridges and provider edge bridges. Each customer LAN is connected to a separate service VLAN inside the provider network. Current release supports the IGMPv1/IGMPv2/IGMPv3.

The following are supported:

- Snooping entries are captured in provider bridge network
- Egress traffic from router is tagged with single SVLAN ID
- IGMP snooping feature supported only in SVLAN

Benefits

This feature enables a Provider bridging network service provider to conserve bandwidth by efficiently switching the multicast packets.

Prerequisites

IGMP snooping is available over a number of network underlays. In this chapter, it is assumed that Provider Bridge support is configured.

Configuration

Topology

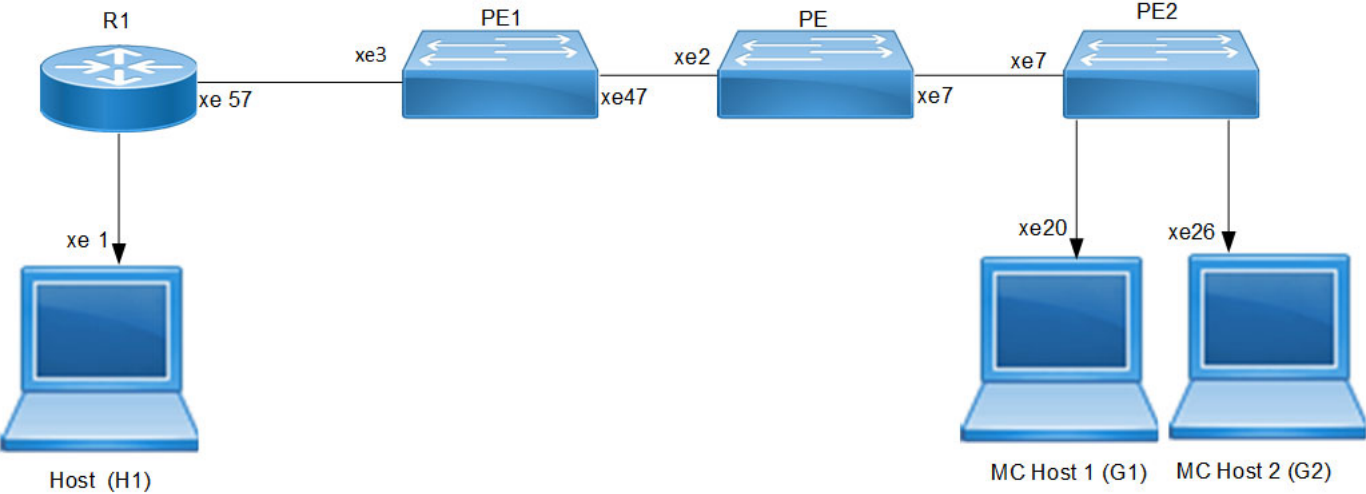

Figure 28-49: IGMP Snooping Provider Bridge Topology

R1

#configure terminal	Enter the configure mode.
R1(config)#bridge 1 protocol provider-rstp edge	Configure bridge 1 to the spanning-tree table.
R1(config)#vlan database	Configure the VLAN database.
R1(config)#vlan 2 type service point-point bridge 1 state enable	Configure the SVLAN 2 to bridge 1.
R1(config)#ip multicast-routing	Configure the multicast routing on the router.
R1(config)#ip pim rp-address 1.1.1.1	Configure Rendezvous Point (RP) address for multicast groups.
R1(config)#interface lo	Enter into lo interface.
R1(config-if)#ip address 1.1.1.1/24 secondary	Configure rp address as secondary.
R1(config-if)#ip pim sparse-mode	Enable the PIM sparse mode.
R1(config-if)#exit	Exit the loopback interface mode.
R1(config)#interface svlan1.2	Create the SVLAN interface.
R1(config-if)#ip address 20.1.1.1/24	Configure IPv4 address to VLAN interface.
R1(config-if)#ip pim sparse-mode	Configure PIM sparse mode.
R1(config-if)#exit	Exit the SVLAN interface mode.
R1(config)#interface xe1	Enter interface mode.
R1(config-if)#ip address 10.1.1.1/24	Configure IPv4 address to interface
R1(config-if)#ip pim sparse-mode	Configure PIM sparse mode.
R1(config-if)#commit	Commit the configurations.
R1(config-if)#exit	Exit the interface mode.
R1(config)#interface xe57	Enter interface mode.
R1(config-if)#switchport	Configure switchport.
R1(config-if)#dot1ad ethertype 0x8100	Configure ether type 0x8100.
R1(config-if)#bridge-group 1 spanning-tree disable	Configure bridge group.
R1(config-if)#switchport mode provider-network	Configure switchport trunk mode.
R1(config-if)#switchport provider-network allowed vlan add 2	Configure the VLAN to switchport trunk mode.
R1(config-if)#commit	Commit configurations

PE1

#configure terminal	Enter the configure mode.
PE1(config)#bridge 1 protocol provider-rstp edge	Configure bridge 1 to the spanning-tree table.

PE1(config)#vlan database	Configure the VLAN database.
PE1(config)#vlan 2 type service point-point bridge 1 state enable	Configure the SVLAN 2 to bridge 1.
PE1(config)#ip multicast-routing	Configure the multicast routing on the router.
PE1(config)#interface svlan1.2	Create VLAN interface.
PE1(config-if)#igmp snooping enable	Configure IPv4 address to VLAN interface .
PE1PE1(config-if)#exit	Exit the interface mode.
PE1(config)#interface xe3	Enter interface mode.
PE1(config-if)#switchport	Configure Switchport.
PE1(config-if)#dot1ad ethertype 0x8100	Configure ethertype.
PE1(config-if)#bridge-group 1 spanning-tree disable	Configure bridge group spanning tree disable .
PE1(config-if)#switchport mode provider- network	Configure provider network .
PE1(config-if)#switchport provider-network allowed vlan add 2	Configure the SVLAN to interface .
PE1(config-if)#commit	Commit configurations.
PE1(config-if)#exit	Exit the interface mode.
PE1(config)#interface xe47	Enter interface mode.
PE1(config-if)#switchport	Configure switchport
PE1(config-if)#dot1ad ethertype 0x8100	Configure ethertype.
PE1(config-if)#bridge-group 1 spanning-tree disable	Configure bridge group spanning tree disable.
PE1(config-if)#switchport mode provider- network	Configure provider network.
PE1(config-if)#switchport provider-network allowed vlan add 2	Configure service vlan to provider network.
PE1(config-if)#commit	Commit configurations.
PE1(config-if)#exit	Exit the interface mode.

PE

#configure terminal	Enter the configure mode.
PE(config)#bridge 1 protocol provider-rstp edge	Configure bridge 1 to the spanning-tree table.
PE(config)#vlan database	Configure the VLAN database
PE(config)#vlan 2 type service point-point bridge 1 state enable	Configure the SVLAN 2 to bridge 1.
PE(config)#ip multicast-routing	Configure the multicast routing on the router.
PE(config)#interface svlan1.2	Create VLAN interface.
PE(config-if)#igmp snooping enable	Configure IPv4 address to VLAN interface.
PE(config-if)#exit	Exit the interface mode.
PE(config)#interface xe2	Enter interface mode.
PE(config-if)#switchport	Configure Switchport
PE(config-if)#dot1ad ethertype 0x8100	Configure ethertype
PE(config-if)#bridge-group 1 spanning-tree disable	Configure bridge group spanning tree disable.
PE(config-if)#switchport mode provider-network	Configure provider network.
PE(config-if)#switchport provider-network allowed vlan add 2	Configure the SVLAN to interface.
PE(config-if)#commit	Commit configurations.
PE(config-if)#exit	Exit the interface mode.
PE(config)#interface xe7	Enter interface mode.
PE(config-if)#switchport	Configure switchport.
PE(config-if)#dot1ad ethertype 0x8100	Configure ethertype.
PE(config-if)#bridge-group 1 spanning-tree disable	Configure bridge group spanning tree disable.
PE(config-if)#switchport mode provider-network	Configure provider network.
PE(config-if)#switchport provider-network allowed vlan add 2	Configure service vlan to provider network.
PE(config-if)#commit	Commit configurations.
PE(config-if)#exit	Exit the interface mode.

PE2

#configure terminal	Enter the configure mode.
PE2(config)#bridge 1 protocol provider-rstp edge	Configure bridge 1 to the spanning-tree table.
PE2(config)#vlan database	Configure the VLAN database.
PE2(config)#vlan 2 type service point-point bridge 1 state enable	Configure the SVLAN 2 to bridge 1.
PE2(config)#ip multicast-routing	Configure the multicast routing on the router.
PE2(config)#interface svlan1.2	Create VLAN interface.
PE2(config-if)#igmp snooping enable	Enable the IGMP snooping on VLAN interface.
PE2(config-if)#exit	Exit the VLAN interface mode.
PE2(config)#interface xe7	Enter interface mode.
PE2(config-if)#switchport	Configure Switchport.
PE2(config-if)#dot1ad ethertype 0x8100	Configure ethertype.
PE2(config-if)#bridge-group 1 spanning-tree disable	Configure bridge group spanning tree disable.
PE2(config-if)#switchport mode provider-network	Configure provider network.
PE2(config-if)#switchport provider-network allowed vlan add 2	Configure the SVLAN to interface.
PE2(config-if)#commit	Commit configurations.
PE2(config-if)#exit	Exit the interface mode.
PE2(config)#interface xe20	Enter interface mode.
PE2(config-if)#switchport	Configure switchport.
PE2(config-if)#dot1ad ethertype 0x8100	Configure ethertype.
PE2(config-if)#bridge-group 1 spanning-tree disable	Configure bridge group spanning tree disable.
PE2(config-if)#switchport mode provider-network	Configure provider network.
PE2(config-if)#switchport provider-network allowed vlan add 2	Configure service VLAN to provider network.
PE2(config-if)#commit	Commit configurations.
PE2(config-if)#exit	Exit the interface mode.
PE2(config)#interface xe22	Enter interface mode.
PE2(config-if)#switchport	Configure switchport.
PE2(config-if)#dot1ad ethertype 0x8100	Configure ethertype.
PE2(config-if)#bridge-group 1 spanning-tree disable	Configure bridge group spanning tree disable.

PE2(config-if)#switchport mode provider-network	Configure provider network.
PE2(config-if)#switchport provider-network allowed vlan add 2	Configure service VLAN to provider network.
PE2(config-if)#commit	Commit configurations.
PE2(config-if)#exit	Exit the interface mode.

Validation

R1

```
MCRTR#show ip igmp groups
```

```
IGMP Instance wide G-Recs Count is: 2
```

```
IGMP Connected Group Membership
```

Group Address	Interface	Uptime	Expires	State	Last Reporter
231.1.1.1	svlan1.2	00:00:12	00:04:07	Active	0.0.0.0
231.1.1.2	svlan1.2	00:00:12	00:04:07	Active	0.0.0.0

```
MCRTR#
```

```
MCRTR#show ip pim mroute
```

```
IP Multicast Routing Table
```

```
(*,* ,RP) Entries: 0
```

```
G/prefix Entries: 0
```

```
(* ,G) Entries: 2
```

```
(S,G) Entries: 0
```

```
(S,G,rpt) Entries: 0
```

```
FCR Entries: 0
```

```
(* , 231.1.1.1)
```

```
RP: 1.1.1.1
```

```
RPF nbr: 0.0.0.0
```

```
RPF idx: None
```

```
Upstream State: JOINED
```

```
Local ..i.....
```

```
Joined .....
```

```
Asserted .....
```

```
FCR:
```

```
(* , 231.1.1.2)
```

```
RP: 1.1.1.1
```

```
RPF nbr: 0.0.0.0
```

```
RPF idx: None
```

```
Upstream State: JOINED
```

```
Local ..i.....
```

```
Joined .....
```

```
Asserted .....
```

```
FCR:
```

```
MCRTR#
```

PE1

```
PEB1-7014#show igmp snooping interface
```

```
Global IGMP Snooping information
```

```
IGMP Snooping Enabled
IGMPv1/v2 Report suppression Enabled
IGMPv3 Report suppression Enabled
```

```
IGMP Snooping information for svlan1.2
```

```
IGMP Snooping enabled
Snooping Querier none
IGMP Snooping other querier timeout is 255 seconds
Group Membership interval is 260 seconds
IGMPv2 fast-leave is disabled
IGMPv1/v2 Report suppression enabled
IGMPv3 Report suppression enabled
Router port detection using IGMP Queries
Number of router-ports: 1
Number of Groups: 0
Number of v1-reports: 0
Number of v2-reports: 0
Number of v2-leaves: 0
Number of v3-reports: 0
Active Ports:
  xe3
  xe47
```

```
PEB1-7014#show igmp snooping groups
```

```
IGMP Instance wide G-Recs Count is: 2
```

```
IGMP Snooping Group Membership
```

```
Group source list: (R - Remote, S - Static, > - Hw Installed)
```

Vlan	Group/Source Address	Interface	Flags	Uptime	Expires	Last Reporter	Version
2	231.1.1.1	xe47	R >	00:07:15	00:03:48	0.0.0.0	V3
2	231.1.1.2	xe47	R >	00:07:15	00:03:48	0.0.0.0	V3

```
PEB1-7014#
```

PE

```
PB-7024#show igmp snooping interface
```

```
Global IGMP Snooping information
```

```
IGMP Snooping Enabled
IGMPv1/v2 Report suppression Enabled
IGMPv3 Report suppression Enabled
```

```
IGMP Snooping information for svlan1.2
```

```
IGMP Snooping enabled
Snooping Querier none
IGMP Snooping other querier timeout is 255 seconds
Group Membership interval is 260 seconds
IGMPv2 fast-leave is disabled
IGMPv1/v2 Report suppression enabled
IGMPv3 Report suppression enabled
```

Router port detection using IGMP Queries

Number of router-ports: 1

Number of Groups: 0

Number of v1-reports: 0

Number of v2-reports: 0

Number of v2-leaves: 0

Number of v3-reports: 0

Active Ports:

xe7

xe2

PB-7024#

PB-7024#show igmp snooping groups

IGMP Instance wide G-Recs Count is: 2

IGMP Snooping Group Membership

Group source list: (R - Remote, S - Static, > - Hw Installed)

Vlan	Group/Source	Address	Interface	Flags	Uptime		
Expires	Last Reporter	Version					
2	231.1.1.1		xe7	R >	00:07:15	00:03:45	20.1.1.2 V3
2	231.1.1.2		xe7	R >	00:07:15	00:03:51	20.1.1.3 V3

PB-7024#

PE2

PEB2-7019#show igmp snooping interface

Global IGMP Snooping information

IGMP Snooping Enabled

IGMPv1/v2 Report suppression Disabled

IGMPv3 Report suppression Disabled

IGMP Snooping information for svlan1.2

IGMP Snooping enabled

Snooping Querier none

IGMP Snooping other querier timeout is 255 seconds

Group Membership interval is 260 seconds

IGMPv2 fast-leave is disabled

IGMPv1/v2 Report suppression disabled

IGMPv3 Report suppression disabled

Router port detection using IGMP Queries

Number of router-ports: 1

Number of Groups: 0

Number of v1-reports: 0

Number of v2-reports: 0

Number of v2-leaves: 0

Number of v3-reports: 0

Active Ports:

xe20

xe26

xe7

PEB2-7019#

PEB2-7019#show igmp snooping groups

IGMP Instance wide G-Recs Count is: 2

IGMP Snooping Group Membership

```
Group source list: (R - Remote, S - Static, > - Hw Installed)
Vlan Group/Source Address Interface Flags Uptime Expires Last Reporter Version
2 231.1.1.1 xe20 R > 00:07:14 00:03:45 20.1.1.2 v3
2 231.1.1.2 xe26 R > 00:07:15 00:03:51 20.1.1.3 v3
PEB2-7019#
```

Abbreviations

Table 28-5:

Acronym	Description
IGMP	Internet Group Management Protocol
PB	Provider Bridged
SVLAN	Service Provider VLAN

Layer 2 Command Reference

CHAPTER 1 Link Layer Discovery Protocol v2 Commands

The commands in this chapter support:

- Link Layer Discovery Protocol (LLDP) version 2 as described in IEEE 802.1AB 2009
- LLDP-MED protocol extension as per ANSI/TIA-1057 April 2006.

Note: To enable LLDPv2, LLDP (previous version) should be disabled or vice versa.

- `clear lldp counters`
- `lldp-agent`
- `debug lldp`
- `lldp run`
- `lldp tlv basic-mgmt`
- `lldp tlv med`
- `lldp tlv ieee-8021-org-specific`
- `lldp tlv ieee-8023-org-specific`
- `lldp tlv-select basic-mgmt`
- `lldp tlv-select ieee-8021-org-specific`
- `lldp tlv-select ieee-8023-org-specific`
- `set lldp agt-circuit-id`
- `set lldp chassis-id-tlv`
- `set lldp chassis locally-assigned`
- `set lldp disable`
- `set lldp enable`
- `set lldp locally-assigned`
- `set lldp management-address-tlv`
- `set lldp med-devtype`
- `set lldp msg-tx-hold`
- `set lldp port-id-tlv`
- `set lldp timer`
- `set lldp too-many-neighbors`
- `set lldp tx-fast-init`
- `set lldp tx-max-credit`
- `show debugging lldp`
- `show lldp neighbors`
- `show lldp interface`
- `snmp restart lldp`

clear lldp counters

Use this command to clear the LLDP statistics on all the interfaces.

Command Syntax

```
clear lldp counters
```

Parameters

`counters` Reset the LLDP traffic counters to zero.

Command Mode

Exec Mode and Privileged Exec mode

Applicability

This command was introduced before OcnOS version 1.3.

Examples

```
#clear lldp counters
```

lldp-agent

Use this command to create an LLDP agent mode.

Note: This command is not supported in SVLAN, VLAN, and loopback interfaces.

Use the `no` parameter to remove configured lldp agent mode.

Command Syntax

```
lldp-agent (non-tpmr-bridge |customer-bridge| )
no lldp-agent (non-tpmr-bridge |customer-bridge| )
```

Parameters

```
non-tpmr-bridge
                    non-tpmr-bridge
customer-bridge
                    customer-bridge
```

Default

By default LLDP agent is disabled.

Command Mode

Interface Mode

Applicability

This command was introduced before OcNOS version 1.3.

Examples

```
#configure terminal
(config)#interface eth0
(config-if)#lldp-agent customer-bridge
(if-lldp-agent)#

(if-lldp-agent)#no lldp-agent customer-bridge
(if-lldp-agent)#exit
(config-if)#
```

debug lldp

Use this command to set the debugging functions for LLDP.

Use the no form of this command to turn off LLDP debugging functions

Command Syntax

```
debug lldp (event|ha|rx|tx|message)
no debug lldp (event|ha|rx|tx|message)
```

Parameters

event	Enable or disable event debugging
ha	Enable or disable high availability debugging
rx	Enable or disable RX debugging
tx	Enable or disable TX debugging
message	Enable or disable NSM message debugging

Command Mode

Exec mode

Applicability

This command was introduced before OcNOS version 1.3.

Examples

```
#debug lldp event
#debug lldp message
```

lldp run

Use this command to start the Link Layer Discovery Protocol (LLDP)

Use the no form of this command to stop LLDP

Command Syntax

```
lldp run
no lldp run
```

Parameters

None

Command Mode

Configure mode

Applicability

This command was introduced before OcnOS version 1.3.

Example

```
#configure terminal
(config)#lldp run

(config)#no lldp run
```

lldp tlv basic-mgmt

Use this command to select and unselect basic management TLVs in LLDP frames at the interface agent level. This command has precedence over the global configurations for inclusion of TLVs in LLDP frames.

Use the `no` parameter to remove the basic management TLV select/unselect configuration from the interface agent level.

Command Syntax

```
lldp tlv basic-mgmt (management-address|port-description|system-
capabilities|system-description|system-name) (select|unselect)
no lldp tlv basic-mgmt (management-address|port-description|system-
capabilities|system-description|system-name)
```

Parameters

management-address	Management address TLV
port-description	Port description TLV
system-capabilities	System capabilities TLV
system-description	System Description TLV
system-name	System name TLV
select	Select the LLDP TLV to send
unselect	Unselect the LLDP TLV to send

Default Value

None

Command Mode

LLDP agent mode

Applicability

This command was introduced in OcNOS version 3.0.

Examples

```
#configure terminal
(config)#interface eth0
(config-if)lldp-agent
(if-lldp-agent)#lldp tlv basic-mgmt system-name select
(if-lldp-agent)#exit
```

lldp tlv med

Use this command to select and unselect Media Endpoint Devices (MED) TLVs in LLDP frames at the interface agent level. This command has precedence over the global configurations for inclusion of TLVs in LLDP frames.

LLDP MED TLVs determine the capabilities the connected device supports and the capabilities the device has enabled.

Use the `no` parameter to remove the MED TLV select/unselect configuration from the interface agent level.

Command Syntax

```
lldp tlv med (network-policy|location|inventory|media-capabilities|extended-power-
  via-mdi) (select|unselect)

no lldp tlv med (network-policy|location|inventory|media-capabilities|extended-
  power-via-mdi)
```

Parameters

<code>network-policy</code>	Network-policy TLV
<code>location</code>	Location TLV
<code>inventory</code>	Inventory TLV
<code>media-capabilities</code>	Media-capabilities TLV
<code>extended-power-via-mdi</code>	Extended-power-via-mdi TLV (when PoE is available)
<code>select</code>	Select the LLDP TLV to send
<code>unselect</code>	Unselect the LLDP TLV to send

Default Value

None

Command Mode

LLDP agent mode

Applicability

This command was introduced in OcNOS version 3.0.

Examples

```
#configure terminal
(config)#interface eth0
(config-if)lldp-agent
(if-lldp-agent)#lldp tlv med network-policy select
(if-lldp-agent)#exit
```

Ildp tlv ieee-8021-org-specific

Use this command to select and unselect ieee-8021-org-specific TLVs in LLDP frames at the interface agent level. This command has precedence over the global configurations for inclusion of TLVs in LLDP frames.

Use the `no` parameter to remove the ieee-8021-org-specific TLV select/unselect configuration from the interface agent level.

Command Syntax

```
lldp tlv ieee-8021-org-specific (link-agg|mgmt-vid|port-ptcl-vlanid|port-
  vlanid|ptcl-identity|vid-digest|vlan-name) (select|unselect)
```

```
no lldp tlv ieee-8021-org-specific {port-vlanid| port-ptcl-vlanid| vlan-name|ptcl-
  identity|vid-digest|mgmt-vid|link-agg}
```

Parameters

<code>link-agg</code>	Link-aggregation TLV
<code>mgmt-vid</code>	Management VLAN identifier TLV
<code>port-ptcl-vlanid</code>	Port protocol VLAN identifier TLV
<code>port-vlanid</code>	Port VLAN identifier TLV
<code>ptcl-identity</code>	Protocol-identifier TLV
<code>vid-digest</code>	VLAN identifier digest TLV
<code>vlan-name</code>	VLAN name TLV
<code>select</code>	Select the LLDP TLV to send
<code>unselect</code>	Unselect the LLDP TLV to send

Default Value

None

Command Mode

LLDP agent mode

Applicability

This command was introduced in OcNOS version 3.0.

Examples

```
#configure terminal
(config)#interface eth0
(config-if)lldp-agent
(if-lldp-agent)#lldp tlv ieee-8021-org-specific port-vlanid select
(if-lldp-agent)#exit
```

lldp tlv ieee-8023-org-specific

Use this command to select and unselect ieee-8023-org-specific TLVs in LLDP frames at the interface agent level. This command has precedence over the global configurations for inclusion of TLVs in LLDP frames.

Use the `no` parameter to remove the ieee-8023-org-specific TLV select/unselect configuration from the interface agent level.

Command Syntax

```
lldp tlv ieee-8023-org-specific (mac-phy| power-via-mdi| max-mtu-size)
(select|unselect)
no lldp tlv ieee-8023-org-specific (mac-phy| power-via-mdi| max-mtu-size)
```

Parameters

<code>mac-phy</code>	Provider edge port VLAN ID TLV
<code>power-via-mdi</code>	Power-via-MDI TLV (when PoE is available)
<code>max-mtu-size</code>	Maximum MTU size TLV
<code>select</code>	Select the LLDP TLV to send
<code>unselect</code>	Unselect the LLDP TLV to send

Default Value

None

Command Mode

LLDP agent mode

Applicability

This command was introduced in OcNOS version 3.0.

Examples

```
#configure terminal
(config)#interface eth0
(config-if)lldp-agent
(if-lldp-agent)#lldp tlv ieee-8023-org-specific mac-phy select
(if-lldp-agent)#exit
```

lldp tlv-select basic-mgmt

Use this command to select basic management TLVs to be include in the LLDP frames.

Use the `no` parameter to disable basic management TLVs.

Command Syntax

```
lldp tlv-select basic-mgmt (management-address|port-description|system-  
capabilities|system-description|system-name)
```

```
no lldp tlv-select basic-mgmt (management-address|port-description|system-  
capabilities|system-description|system-name)
```

Parameters

<code>management-address</code>	Management address specific TLV
<code>port-description</code>	Port description specific TLV
<code>system-capabilities</code>	System capabilities specific TLV
<code>system-description</code>	System Description specific TLV
<code>system-name</code>	System name specific TLV

Default Value

None

Command Mode

Configuration mode

Applicability

This command was introduced in OcNOS version 3.0.

Examples

```
#configure terminal  
(config)#lldp tlv-select basic-mgmt system-name
```

lldp tlv-select ieee-8021-org-specific

Use this command to select ieee-8021-org-specific TLVs to include in the LLDP frames.

Use the `no` parameter to disable ieee-8021-org-specific TLVs.

Command Syntax

```
lldp tlv-select ieee-8021-org-specific (link-agg|mgmt-vid|port-ptcl-vlanid|port-  
vlanid|ptcl-identity|vid-digest|vlan-name)  
no lldp tlv-select ieee-8021-org-specific {port-vlanid| port-ptcl-vlanid| vlan-  
name|ptcl-identity| vid-digest|mgmt-vid|link-agg}
```

Parameters

<code>link-agg</code>	Link-aggregation TLV
<code>mgmt-vid</code>	Management VLAN identifier TLV
<code>port-ptcl-vlanid</code>	Port protocol VLAN identifier TLV
<code>port-vlanid</code>	Port VLAN identifier TLV
<code>ptcl-identity</code>	Protocol-identifier TLV
<code>vid-digest</code>	VLAN identifier digest TLV
<code>vlan-name</code>	VLAN name TLV

Default Value

None

Command Mode

Configuration mode

Applicability

This command was introduced in OcNOS version 3.0.

Examples

```
#configure terminal  
(config)#lldp tlv-select ieee-8021-org-specific port-vlanid
```

lldp tlv-select ieee-8023-org-specific

Use this command to select ieee-8023-org-specific TLVs to be include in LLDP frames.

Use the `no` parameter to disable ieee-8023-org-specific TLVs.

Command Syntax

```
lldp tlv-select ieee-8023-org-specific (mac-phy| power-via-mdi| max-mtu-size)
no lldp tlv-select ieee-8023-org-specific (mac-phy| power-via-mdi| max-mtu-size)
```

Parameters

<code>mac-phy</code>	VLAN ID Of the provider edge port <2-4094>.
<code>power-via-mdi</code>	Power-via-MDI (only when PoE feature is available)
<code>max-mtu-size</code>	Maximum MTU size TLV

Default Value

None

Command Mode

Configure mode

Applicability

This command was introduced in OcNOS version 3.0.

Examples

```
#configure terminal
(config)#lldp tlv-select ieee-8023-org-specific mac-phy
```

set lldp agt-circuit-id

Use this command to configure LLDP agt-circuit-id.

Command Syntax

```
set lldp agt-circuit-id VALUE
```

Parameters

VALUE Specify LLDP global agt-circuit ID.

Command Mode

Interface mode

Applicability

This command was introduced before OcnOS version 1.3.

Examples

```
(config)#interface eth0  
(config-if)#set lldp agt-circuit-id sample
```

set lldp chassis-id-tlv

Use this command to set the chassis ID subtype for the LLDP agent on a port.

Use `no` form of this command to unset the chassis ID subtype.

In Configure mode, the command is applied globally to all supported interfaces.

LLDP Agent mode or Interface mode has priority over the Configure mode command.

Command Syntax

```
set lldp chassis-id-tlv (if-alias | ip-address | mac-address | if-name | locally-
  assigned | ipv6-address)
no set lldp chassis-id-tlv
```

Parameters

<code>mac-address</code>	Use the MAC address as the chassis ID.
<code>ip-address</code>	Use the management IP address as the chassis ID.
<code>if-alias</code>	Use the interface description as the chassis ID.
<code>if-name</code>	Use the interface name as the chassis ID.
<code>locally-assigned</code>	Use the locally assigned value as the chassis ID.
<code>ipv6-address</code>	Use the management IPv6 address as the chassis ID.

Command Mode

LLDP Agent mode and Configure mode

Applicability

This command was introduced before OcNOS version 1.3. Global support in Command mode was introduced in OcNOS version 6.6.0.

Examples

```
#configure terminal
(config)#interface eth0
(config-if)#lldp-agent
(if-lldp-agent)#set lldp chassis-id-tlv ip-address
(if-lldp-agent)#no set lldp chassis-id-tlv
```

set lldp chassis locally-assigned

Use this command to set the locally assigned chassis name for the LLDP interface.

Command Syntax

```
set lldp chassis locally-assigned NAME
```

Parameters

NAME Name assigned to the chassis.

Command Mode

Configure mode

Applicability

This command was introduced before OcnOS version 1.3.

Examples

```
#configure terminal
(config)#set lldp chassis locally-assigned box1
```

set lldp disable

Use this command to disable the admin status of a LLDP agent on a port.

Use the `no` form of this command to unset the admin status.

Command Syntax

```
set lldp disable
no set lldp disable
```

Parameters

None

Command Mode

LLDP Agent mode

Applicability

This command was introduced before OcnOS version 1.3.

Examples

```
#configure terminal
(config)#interface eth0
(config-if)#lldp-agent
(if-lldp-agent)#set lldp disable
(if-lldp-agent)#no set lldp disable
(if-lldp-agent)#exit
```

set lldp enable

Use this command to set the admin status of a LLDP agent on a port.

Use the `no` form of this command to unset the admin status.

In Configure mode, the command is applied globally to all supported interfaces.

LLDP Agent mode or Interface mode has priority over the Configure mode command.

Command Syntax

```
set lldp enable (txonly|rxtx|rxonly)
```

```
no set lldp enable (txonly|rxtx|rxonly)
```

Parameters

<code>rxonly</code>	Receive-only
<code>txonly</code>	Transmit-only
<code>txrx</code>	Transmit and receive

Default

By default, no LLDP agent is enabled for a port.

Command Mode

LLDP Agent mode and Configure mode

Applicability

This command was introduced before OcNOS version 1.3. The `no` form CLI is introduced in OcNOS version 6.6.0.

Global support in Command mode was introduced in OcNOS version 6.6.0.

Examples

```
#configure terminal
(config)#interface eth0
(config-if)#lldp-agent
(if-lldp-agent)#set lldp enable rxonly
(if-lldp-agent)#no set lldp enable rxonly
(if-lldp-agent)#exit
```

set lldp locally-assigned

Use this command to set the locally assigned name for LLDP interface.

Use no form of this command to remove the locally assigned name for LLDP interface.

Command Syntax

```
set lldp locally-assigned NAME
no set lldp locally-assigned NAME
```

Parameters

NAME	Name assigned to the port.
------	----------------------------

Command Mode

Interface Mode

Applicability

This command was introduced before OcNOS version 1.3.

Examples

```
#configure terminal
(config)#interface eth0
(config-if)#set lldp locally-assigned port1
(config-if)#no set lldp locally-assigned
```

set lldp management-address-tlv

Use this command to set the sub type of the Management Address TLV.

Use `no` form of this command to unset the sub type of the Management Address TLV.

In Configure mode, the command is applied globally to all supported interfaces.

LLDP Agent mode or Interface mode has priority over the Configure mode command.

Command Syntax

```
set lldp management-address-tlv (mac-address | ip-address | ipv6-address)
no set lldp management-address-tlv
```

Parameters

<code>mac-address</code>	Use the MAC address as the Management Address.
<code>ip-address</code>	Use the management IP address as the Management Address.
<code>ipv6-address</code>	Use the management IP address as the Management Address.

Command Mode

LLDP Agent mode and Configure mode

Applicability

This command was introduced before OcNOS version 1.3. Global support in Command mode was introduced in OcNOS version 6.6.0.

Examples

```
#configure terminal
(config)#interface eth0
(config-if)#lldp-agent
(if-lldp-agent)#set lldp management-address-tlv ip-address
(if-lldp-agent)#no set lldp management-address-tlv
```

set lldp med-devtype

Use this command to configure the LLDP device type as Network-Connectivity/ End-Point Class1/ End-Point Class2/ End-Point Class3 device.

Use the `no` parameter to un set the configured LLDP device type.

Command Syntax

```
set lldp med-devtype (net-connect| ep-class1| ep-class2| ep-class3)
no lldp med-devtype (net-connect| ep-class1| ep-class2| ep-class3)
```

Parameters

<code>net-connect</code>	Set device type as Network-Connectivity
<code>ep-class1</code>	Set device type as End-Point Class1
<code>ep-class2</code>	Set device type as End-Point Class2
<code>ep-class3</code>	Set device type as End-Point Class3

Default

None

Command Mode

Interface mode

Applicability

This command was introduced before OcnOS version 1.3.

Examples

```
#configure terminal
(config)#interface eth0
(config-if)#set lldp med-devtype ep-class1
(config-if)#exit
```

```
#configure terminal
(config)#interface eth0
(config-if)#no set lldp med-devtype
(config-if)#exit
```

set lldp msg-tx-hold

Use this command to set the `msg-tx-hold` parameter that determines the Time To Live (TTL) value for LLDPDUs to be transmitted by the port. The value set with this command is multiplied by the `lldp timer msg-tx-interval` value, which determines the final TTL value.

Use `no` form of this command to set the default value of message transmit hold.

In Configure mode, the command is applied globally to all supported interfaces.

LLDP Agent mode or Interface mode has priority over the Configure mode command.

Command Syntax

```
set lldp msg-tx-hold <1-100>
no set lldp msg-tx-hold
```

Parameters

<1-100> Time in seconds to set message transmit hold.

Default

The default value of message transmit hold is 4 seconds.

Command Mode

LLDP agent mode and Configure mode

Applicability

This command was introduced before OcNOS version 1.3. Global support in Command mode was introduced in OcNOS version 6.6.0.

Examples

```
(config)#interface eth0
(config-if)#lldp-agent
(if-lldp-agent)#set lldp msg-tx-hold 3
(if-lldp-agent)#no set lldp msg-tx-hold
```

set lldp port-id-tlv

Use this command to set the sub type of the Port ID.

Use `no` form of this command to unset the sub type of the Port ID.

In Configure mode, the command is applied globally to all supported interfaces.

LLDP Agent mode or Interface mode has priority over the Configure mode command.

Command Syntax

```
set lldp port-id-tlv (if-alias | ip-address | mac-address | if-name | agt-circuit-  
id | locally-assigned | ipv6-address)  
no set lldp port-id-tlv
```

Parameters

<code>mac-address</code>	Use the MAC address as the port-id-tlv.
<code>ip-address</code>	Use the management IP address as the port-id-tlv
<code>if-alias</code>	Use the IP alias as the port-id-tlv
<code>if-name</code>	Use the interface name as the port-id-tlv
<code>agt-circuit-id</code>	Use the agt-circuit-id name as the port-id-tlv
<code>locally-assigned</code>	Use the locally assigned value as the port-id-tlv
<code>ipv6-address</code>	Use the management IP address as the port-id-tlv

Command Mode

LLDP Agent mode and Configure mode

Applicability

This command was introduced before OcNOS version 1.3. Global support in Command mode was introduced in OcNOS version 6.6.0.

Examples

```
(config)#interface eth0  
(config-if)#lldp-agent  
(if-lldp-agent)#set lldp port-id-tlv ip-address  
(if-lldp-agent)#no set lldp port-id-tlv
```

set lldp timer

Use this command to set the interval at which LLDP frames are transmitted.

Use `no` form of this command to set the default value for timer.

In Configure mode, the command is applied globally to all supported interfaces.

LLDP Agent mode or Interface mode has priority over the Configure mode command.

Command Syntax

```
set lldp timer msg-fast-tx <1-3600>
set lldp timer msg-tx-interval <5-3600>
set lldp timer reinit-delay <1-10>
no set lldp timer msg-fast-tx
no set lldp timer msg-tx-interval
no set lldp timer reinit-delay
```

Parameters

<code>msg-fast-tx</code>	Set the value in range <1-3600>
<code>msg-tx-interval</code>	Set the value in range <5-3600>
<code>reinit-delay</code>	Set the value in range <1-10>

Default Values

The default value for `msg-fast-tx` is 1 second.

The default value for `msg-tx-interval` is 30 seconds.

The default value for `reinit-delay` is 2 seconds.

Command Mode

LLDP Agent mode and Configure mode

Applicability

This command was introduced before OcNOS version 1.3. Global support in Command mode was introduced in OcNOS version 6.6.0.

Examples

```
#configure terminal
(config)#interface eth0
(config-if)#lldp-agent
(if-lldp-agent)#set lldp timer msg-fast-tx 40
(if-lldp-agent)#no set lldp timer msg-fast-tx
(if-lldp-agent)#exit

#configure terminal
(config)#interface eth0
(config-if)#lldp-agent
```



```
(if-lldp-agent)#set lldp timer msg-tx-interval 40  
(if-lldp-agent)#no set lldp timer msg-tx-interval  
(if-lldp-agent)#exit
```

```
#configure terminal  
(config)#interface eth0  
(config-if)#lldp-agent  
(if-lldp-agent)#set lldp timer reinitDelay 3  
(if-lldp-agent)#no set lldp timer reinitDelay  
(if-lldp-agent)#exit
```

set lldp too-many-neighbors

Use this command to set the action to take when the remote table is full.

Use no form of this command to unset too many neighbors parameters.

In Configure mode, the command is applied globally to all supported interfaces.

LLDP Agent mode or Interface mode has priority over the Configure mode command.

Command Syntax

```
set lldp too-many-neighbors limit <1-65535> discard received-info timer <1-65535>
set lldp too-many-neighbors limit <1-65535> discard existing-info MAC timer <1-
65535>
no set lldp too-many-neighbors limit
```

Parameters

limit	The limit on the number of LLDP neighbors.
<1-65535>	Upper limit for the number of Remote LLDP Information.
received-info	The information received for this neighbor.
timer	The period after which received information is discarded.
<1-65535>	The period in seconds after which received information is discarded.
existing-info	The information for this neighbor.
MAC	Identifies the remote LLDP Agent for which information is discarded.
timer	The period in seconds after which existing information is discarded.
<1-65535>	The period in seconds after which existing information is discarded.

Default Value

No upper limit is enforced for the number of remote LLDP agents.

Command Mode

LLDP Agent mode and Configure mode

Applicability

This command was introduced before OcNOS version 1.3. Global support in Command mode was introduced in OcNOS version 6.6.0.

Examples

```
#configure terminal
(config)#interface eth1
(config-if)#lldp-agent
(if-lldp-agent)#set lldp too-many-neighbors limit 20 disc existing-info
1001.1001.1001 timer 1

(config)#interface eth1
```

```
(config-if)#lldp-agent
(if-lldp-agent)#set lldp too-many-neighbors limit 1 discard received-info
timer 1
```

set lldp tx-fast-init

Use this command to determine the maximum value of LLDP frames that are transmitted during a fast transmission period.

Use `no` form of this command to set fast transmission period to default value.

In Configure mode, the command is applied globally to all supported interfaces.

LLDP Agent mode or Interface mode has priority over the Configure mode command.

Command Syntax

```
set lldp tx-fast-init <1-8>
no set lldp tx-fast-init
```

Parameters

`tx-fast-init` Set the message transmit interval value <1-8>.

Default Value

Default value is 4.

Command Mode

LLDP Agent mode and Configure mode

Applicability

This command was introduced before OcNOS version 1.3. Global support in Command mode was introduced in OcNOS version 6.6.0.

Examples

```
#configure terminal
(config)#interface eth0
(config-if)#lldp-agent
(if-lldp-agent)#set lldp tx-fast-init 4
(if-lldp-agent)#no set lldp tx-fast-init
(if-lldp-agent)#exit
```

set lldp tx-max-credit

Use this command to set the maximum value of transmission credit, which signifies the number of consecutive LLDP frames transmitted.

Use `no` form of this command to set the maximum value of transmission credit to default value.

In Configure mode, the command is applied globally to all supported interfaces.

LLDP Agent mode or Interface mode has priority over the Configure mode command.

Command Syntax

```
set lldp tx-max-credit <1-10>
no set lldp tx-max-credit
```

Parameters

`tx-max-credit` The maximum value of transmission credit.

Default Value

Default value is 5

Command Mode

LLDP Agent mode and Configure mode

Applicability

This command was introduced before OcNOS version 1.3. Global support in Command mode was introduced in OcNOS version 6.6.0.

Examples

```
#configure terminal
(config)#interface eth0
(config-if)lldp-agent
(if-lldp-agent)#set lldp tx-max-credit <1-10>
(if-lldp-agent)#no set lldp tx-max-credit
(if-lldp-agent)#exit
```

show debugging lldp

Use this command to display LLDP debugging information.

Command Syntax

```
show debugging lldp
```

Parameters

None

Command Mode

Exec mode and Privileged Exec mode

Applicability

This command was introduced before OcNOS version 1.3.

Example

The following sample output displays information about an LLDP debugging.

```
#show debugging lldp
LLDP debugging status:
  LLDP message debugging is on
```

show lldp neighbors

Use this command to display LLDP neighbors information.

Command Syntax

```
show lldp (nearest-bridge| non-tpmr-bridge| customer-bridge|) neighbors
(brief|details)
```

Parameters

nearest-bridge	Display LLDP nearest bridge information
non-tpmr-bridge	Display LLDP non-TPMR-bridge information
customer-bridge	Display LLDP customer-bridge information
neighbor	Neighbor
brief	Brief
details	Details

Command Mode

Exec mode and Privileged Exec mode

Applicability

This command was introduced before OcNOS version 1.3 and changed in OcNOS version 1.3.1.

Example

The following sample output displays information about an LLDP neighbors

```
#sh lldp nearest-bridgr neighbors brief
Loc PortID  Rem Host Name    Rem Chassis Id  Rem Port Id  Agent Mode
-----
xe3/1      OcNOS            ecf4.bbfe.2864  ecf4.bbb2.4c65 Nearest bridge
```

```
#show lldp neighbors detail
```

```
-----
Nearest bridge Neighbors
Interface Name : xe11
Mandatory TLVs
Chassis id type : MAC address [8cea.1b67.236c]
Port id type : MAC address [8cea.1b28.4f6d]
Time to live : 121
Basic Management TLVs
System Name : OcNOS
System Description : Hardware Model:EC_AS5912-54X, Software version: OcNOS,1.3.1.122
Port Description : xe11
Remote System Capabilities : Bridge Router
Capabilities Enabled : Router
```

```

Management Address : MAC Address [8cea.1b67.236c]
Interface Number subtype : ifindex
Interface Number : 10011
OID Number : 0
802.1 Org specific TLVs
Port vlan id : 0
Port & Protocol vlan id : 0
Remote Configured VLANs : None
Remote Protocols Advertised: None
Remote VID Usage Digest : 0
Remote Management Vlan : 0
Link Aggregation Capability: capable of being aggregated
Link Aggregation Status : not currently in aggregation
Link Aggregation Port ID :
802.3 Org specific TLVs
AutoNego Support : Supported
AutoNego Status : Disabled
AutoNego Capability : 16
Operational MAU Type : 54 [Four-pair Category 6A or better, full duplex mode only]
Max Frame Size : 1518
    
```

Table 1-7 Shows the output details.

Table 1-6: show lldp neighbor output details

Entry	Description
Loc Port ID	Local interface SNMP index (appears when the interface option is used).
Rem Host Name	Name of the remote host.
Rem Chassis Id	Remote chassis identifier of the chassis type listed.
Rem Port Id	Remote port identifier of the port type listed.
Agent Mode	Agent mode enabled to the nearest bridge.
Time to live	Number of seconds for which this information is valid.
Interface Name	Name of the interface.
Chassis id type	Chassis identifier of the chassis type listed.
Port id type	Type of port identifier supplied, such as Locally assigned.
System Name	Name supplied by the system on the interface.
System Description	Description supplied by the system on the interface.
Port Description	The port description field uses the configured port description, the port name or the SNMP if Index (appears when the interface option is used).
Remote System Capabilities	Remote system capabilities (such as Bridge, Bridge Router, and Bridge Telephone) that are supported.

Table 1-6: show lldp neighbor output details

Entry	Description
Capabilities Enabled	Enabled by the system on the interface (appears when the interface option is used).
Management Address	Details of management address (such as 10.204.35.34).
Interface Number subtype	Interfaces subtype for which neighbor information is available.
Interface Number	Interfaces for which neighbor information is available.
OID Number	Number of identifier.
Port VLAN ID	Details of the port VLAN identifier.
Protocol VLAN ID	Details of the protocol VLAN identifier.
Remote Configured VLANs	Details of the remote configured VLAN.
Remote Protocols Advertised	Details of the remote protocols.
Remote VID usage Digest	Details of the VID usage.
Remote Management VLAN	Details of the management VLAN.
Link Aggregation Capability	Capabilities that supported by the link aggregation on the interface.
Link Aggregation Status	Status of the link aggregation.
Link Aggregation Port ID	Details of the link aggregation port identifier.
Auto Nego Support	Support of the auto nego on the interface.
Auto Nego Status	Status of the auto nego.
Auto Nego Capability	Capabilities that supported by the auto nego on the interface.
Operational MAU Type	Type of operational MAU on the interface.
Max Frame Size	Maximum frame size on the transit.

show lldp interface

Use this command to display LLDP interface information.

Command Syntax

```
show lldp interface IFNAME (nearest-bridge| non-tpmr-bridge| customer-bridge | )
    (neighbor| )
```

Parameters

IFNAME	
	Display LLDP interface information for all agent
nearest-bridge	
	Display LLDP nearest bridge information
non-TPMR-bridge	
	Display LLDP non-TPMR-bridge information
customer-bridge	
	Display LLDP customer-bridge information
neighbor	
	Display LLDP neighbor details.

Command Mode

Exec mode and Privileged Exec mode

Applicability

This command was introduced before OcNOS version 1.3.

Example

```
#show lldp interface eth0
Agent Mode : Customer-bridge
Enable (tx/rx): N/N
MED Enabled :N
Device Type: NOT_DEFINED
LLDP Agent traffic statistics:
Total frames transmitted: 0
Total entries aged: 0
Total frames recieved: 0
Total frames received in error: 0
Total frames discarded: 0
Total discarded TLVs: 0
Total unrecognised TLVs: 0

Agent Mode : Non-TPMR-bridge
Enable (tx/rx): N/N
MED Enabled :N
Device Type: NOT_DEFINED
LLDP Agent traffic statistics:
Total frames transmitted: 0
```

```

Total entries aged: 0
Total frames recieved: 0
Total frames received in error: 0
Total frames discarded: 0
Total discarded TLVs: 0
Total unrecognised TLVs: 0

```

```

Agent Mode : Nearest bridge
Enable (tx/rx): Y/Y
MED Enabled :N
Device Type: NOT_DEFINED
LLDP Agent traffic statistics:
Total frames transmitted: 2495
Total entries aged: 0
Total frames recieved: 0
Total frames received in error: 0
Total frames discarded: 0
Total discarded TLVs: 0
Total unrecognised TLVs: 0

```

Table 1-7 Shows the output details.

Table 1-7: show lldp interface output details

Entry	Description
Agent Mode	Agent mode enabled to the customer-bridge, Non-TPMR-bridge, and nearest bridge.
Enable (tx/rx)	Enables the transmit and receive on the interface.
Device Type	Type of device in the networks.
LLDP Agent traffic statistics	Statistics on exchanged LLDP frames between a device and neighbors.
Total frames transmitted	Number of frames transmitted in network.
Total entries aged	Number of aged entries in a networks.
Total frames received	Number of frames received from the neighbor network.
Total frames received in error	Number of frames not received from the neighbor network.
Total discarded TLVs	Number of TLVs discarded in transit.
Total unrecognised TLVs	Number of unrecognised TLVs in transit.

snmp restart lldp

Use this command to restart SNMP in Link Layer Discovery Protocol (LLDP)

Command Syntax

```
snmp restart lldp
```

Parameters

None

Command Mode

Configure mode

Applicability

This command was introduced before OcNOS version 1.3.

Examples

```
(config)#snmp restart lldp
```

CHAPTER 2 Provider Bridging Commands

This chapter describes the Provider Bridging (PB) commands.

IEEE 802.1ad standardizes the architecture and bridged protocols to allow Ethernet frames with multiple VLAN tags. Packets through a provider network are doubly tagged with both an:

Note: Customer-Network Port is not supported in Qumran1 series platforms.

- Inner (C-VLAN) tag which is the customer network VLAN identifier
- Outer (S-VLAN) tag which is the service provider network VLAN identifier
 - [bridge protocol provider-mstp](#)
 - [bridge protocol provider-rstp](#)
 - [cvlan registration table](#)
 - [cvlan svlan](#)
 - [dot1ad ethertype](#)
 - [show cvlan registration table](#)
 - [switchport customer-edge](#)
 - [switchport customer-edge hybrid](#)
 - [switchport customer-edge trunk](#)
 - [switchport customer-edge vlan registration](#)
 - [switchport customer-network allowed vlan](#)
 - [switchport customer-network vlan](#)
 - [switchport mode](#)
 - [switchport mode customer-edge](#)
 - [switchport mode customer-edge hybrid acceptable-frame-type](#)
 - [switchport provider-network](#)
 - [switchport provider-network isolated-vlan](#)
 - [vlan type](#)
 - [vlan type customer](#)

bridge protocol provider-mstp

Use this command to create a provider multiple spanning-tree protocol (MSTP) bridge. MSTP bridges can have different spanning-tree topologies for different VLANs inside a region of similar MSTP bridges.

Using this command creates an instance of the spanning tree, and associates the VLANs specified with that instance. A bridge created by this command forms its own separate region.

The multiple spanning tree protocol, like the rapid spanning tree protocol, provides rapid reconfiguration features, while providing load-balancing capability.

Command Syntax

```
bridge <1-32> protocol provider-mstp (edge|)
```

Parameters

<1-32>	Bridge identifier.
edge	Configure as an edge bridge.

Command Mode

Configure mode

Applicability

This command was introduced before OcnOS version 1.3.

Example

```
#configure terminal  
(config)#bridge 2 protocol provider-mstp edge
```

bridge protocol provider-rstp

Use this command to add an IEEE 802.1D-2004 Rapid Spanning Tree Protocol (RSTP) bridge.

After creating a bridge instance, add interfaces to the bridge using the `bridge-group` command. Bring the bridge instance into operation with the `no shutdown` command in interface mode.

Command Syntax

```
bridge <1-32> protocol provider-rstp (edge|)
```

Parameters

<code><1-32></code>	Bridge identifier.
<code>edge</code>	Configure as an edge bridge.

Command Mode

Configure mode

Applicability

This command was introduced before OcnOS version 1.3.

Example

```
#configure terminal  
(config)#bridge 2 protocol provider-rstp edge
```

cvlan registration table

Use this command to create a customer VLAN (CVLAN) registration table that maps between CVLANs and service provider VLANs (SVLANs).

Use the `no` parameter with this command to delete the CVLAN registration table.

Command Syntax

```
cvlan registration table WORD bridge <1-32>
no cvlan registration table WORD bridge <1-32>
```

Parameters

WORD	Name of the CVLAN registration table.
<1-32>	Specify a bridge ID.

Command Mode

Configure mode

Applicability

This command was introduced before OcnOS version 1.3.

Example

```
#configure terminal
(config)#cvlan registration table customer1
(config-cvlan-registration)#
```

cvlan svlan

Use this command to map one or more customer VLANs (CVLANs) to a service provider VLAN (SVLAN).

To update the optional QoS parameters `cos-to-queue` and `remark-cos`, execute the complete command along with the optional parameters. To remove these options, execute the same command by removing the optional parameters.

Refer `qos profile` commands from configuration guide for more details about qos profiles.

Use the `no` forms of this command to delete a mapping.

Command Syntax

```
cvlan VLAN_RANGE2 (cvlan VLAN_ID|) svlan VLAN_ID ({untagged-pep|untagged-
  cep|}) ({cos-to-queue NAME | remark-cos|})
no cvlan VLAN_RANGE2  svlan VLAN_ID
```

Parameters

<code>cvlan</code>	CVLAN
<code>VLAN_RANGE2</code>	VLAN identifier <1-4094> or range such as 2-5,10 or 2-5,7-19
<code>cvlan</code>	Translation of CVID
<code>VLAN_ID</code>	Translated CVID <1-4095>
<code>svlan</code>	SVLAN corresponding to the C-VLAN
<code>VLAN_ID</code>	VLAN identifier 1-4094>
<code>untagged-pep</code>	Provider edge port is untagged for this CVLAN
<code>untagged-cep</code>	Customer edge port is untagged for this CVLAN
<code>cos-to-queue</code>	Configure cos-to-queue map for cvlan
<code>NAME</code>	Ingress profile to modify queue/color on basis of c-cos
<code>remark-cos</code>	Remark Egress COS

Command Mode

CVLAN Registration mode

Applicability

This command was introduced before OcNOS version 1.3 and updated in OcNOS version 3.0.

Example

```
#configure terminal
(config)#cvlan registration table customer1 bridge 1
(config-cvlan-registration)#cvlan 2 svlan 3
(config-cvlan-registration)#cvlan 3 svlan 3 cos-to-queue c1 remark-cos
(config-cvlan-registration)#cvlan 100 cvlan 101 svlan 200 cos-to-queue p1
remark-cos
(config-cvlanregistration)#cvlan 3 svlan 3 remark-cos
(config-cvlan-registration)#cvlan 4 svlan 5 untagged-pep
(config-cvlan-registration)#cvlan 5 svlan 6 untagged-cep
(config-cvlan-registration)#no cvlan 3 svlan 3
```

```
(config-cvlan-registration)#cvlan 23 svlan 31 untagged-pep untagged-cep cos-  
to-queue pl remark-cos  
(config-cvlan-registration)#cvlan 15-16 svlan 18 untagged-cep remark-cos
```

dot1ad ethertype

Use this command to change the TPID for a port.

Use the no form of this command to set the TPID to its default value.

Command Syntax

```
dot1ad ethertype (0x8100 | 0x88a8 | 0x9100 | 0x9200)
no dot1ad ethertype
```

Parameters

0x8100	IEEE 802.1Q VLAN-tagged frame
0x88a8	IEEE 802.1ad Provider Bridging Service VLAN tag identifier (S-Tag)
0x9100	Supported for interoperability with legacy devices
0x9200	Supported for interoperability with legacy devices

Default

The default TPID value is 8100.

Command Mode

Interface Mode

Applicability

This command was introduced before OcnOS version 3.0.

Examples

```
(config)#interface xe1
(config-if)#dot1ad ethertype 0x9100
(config-if)#exit
(config)#interface xe1
(config-if)#no dot1ad ethertype
(config-if)#exit
```

show cvlan registration table

Use this command to display the CVLAN registration table.

Command Syntax

```
show cvlan registration table (WORD|bridge <1-32>|WORD bridge <1-32>|)
```

Parameters

WORD CVLAN registration table name.
 <1-32> Bridge identifier

Command Mode

Exec mode

Applicability

This command was introduced before OcnOS version 1.3.

Example

```
#sh cvlan registration table bridge 1
Bridge          Table Name      Port List
=====
1              map            xe17

CVLAN ID       T-CVLAN ID     SVLAN ID       Profile Name    Egress remark-Cos
=====
100            101            200            p1              Yes
```

[Table 2-8](#) explains the output fields.

Table 2-8: show cvlan registration table output

Entry	Description
Bridge	ID number of the bridge associated with the Customer VLAN (CVLAN).
Table Name	ID of the CVLAN registration table.
Port List	List of ports used by this CVLAN (including Link aggregators).
CVLAN ID	ID number of the CVLAN.
T-CVLAN ID	Translation CVLAN ID.
SVLAN ID	ID number of the Service VLAN (SVLAN) associated with the CVLAN.
Profile Name	cos-to-queue profile name.
Egress remark-Cos	Remark Egress Cos

switchport customer-edge

Use this command to set the switching characteristics of the layer 2 interface and the default customer VLAN.

Use the `no` form of this command to remove a customer VLAN.

Command Syntax

```
switchport customer-edge (access|hybrid) vlan <1-4094>
no switchport customer-edge (access|hybrid) vlan
```

Parameters

<code>access</code>	Set the layer 2 interface as access.
<code>hybrid</code>	Set the layer 2 interface as hybrid.
<code><1-4094></code>	Set the default VID for the interface.

Command Mode

Interface mode

Applicability

This command was introduced before OcnOS version 1.3.

Examples

```
#configure terminal
(config)#interface eth0
(config-if)#switchport customer-edge access vlan 3

(config)#interface eth0
(config-if)#no switchport customer-edge access vlan
```

switchport customer-edge hybrid

Use this command to set the switching characteristics of the Layer 2 customer-facing interface to hybrid. Both tagged and untagged frames will be classified over hybrid interfaces.

Command Syntax

```
switchport customer-edge hybrid allowed vlan add VLAN_ID
switchport customer-edge hybrid allowed vlan remove VLAN_ID
switchport customer-edge hybrid allowed vlan all
switchport customer-edge hybrid allowed vlan none
```

Parameters

add	Add a VLAN to transmit and receive through the Layer 2 interface.
VLAN_ID	ID of the VLAN <1-4094>.
remove	Remove a VLAN from the member set.
VLAN_ID	ID of the VLAN <1-4094>.
all	Allow all VLANs to transmit and receive through the Layer 2 interface.
none	Allow no VLANs to transmit and receive through the Layer 2 interface.

Command Mode

Interface mode

Applicability

This command was introduced before OcnOS version 1.3.

Examples

```
(config)#interface eth0
(config-if)#switchport customer-edge hybrid allowed vlan add 2
```

switchport customer-edge trunk

Use this command to set the Layer2 interface as trunk.

Command Syntax

```
switchport customer-edge trunk allowed vlan add VLAN_ID
switchport customer-edge trunk allowed vlan remove VLAN_ID
switchport customer-edge trunk allowed vlan all
switchport customer-edge trunk allowed vlan none
```

Parameters

add	Add a VLAN to the member set.
VLAN_ID	Specify a VLAN ID <2-4094>
remove	Remove a VLAN from the member set.
all	Allow all VLANs to transmit and receive through the Layer 2 interface.
none	Allow no VLANs to transmit and receive through the Layer 2 interface.

Command Mode

Interface mode

Applicability

This command was introduced before OcnOS version 1.3.

Examples

```
#configure terminal
(config)#interface eth1
(config-if)#switchport customer-edge trunk allowed vlan add 12
```

switchport customer-edge vlan registration

Use this command to configure the VLAN registration parameters.

Use the `no` parameter with this command to delete the mapping from the interface.

Command Syntax

```
switchport customer-edge vlan registration WORD
no switchport customer-edge vlan registration
```

Parameters

WORD Name of the CVLAN registration table.

Command Mode

Interface mode

Applicability

This command was introduced before OcnOS version 1.3.

Example

```
#configure terminal
(config)#interface eth1
(config-if)#switchport customer-edge vlan registration customer1
```

switchport customer-network allowed vlan

Use this command to add SVLAN IDs to the Customer Network Port.

Note: Customer-Network Port is not supported in Qumran1 series platforms.

Command Syntax

```
switchport customer-network allowed vlan add VLAN_RANGE
```

Parameters

VLAN_RANGE VLAN identifier <1-4094> or range such as 2-5,10 or 2-5,7-19.

Command Mode

Interface mode

Applicability

This command was introduced before OcnOS version 6.2.0.

Examples

In this example, the xe1 interface allows S-TAG 100-200 and 400 traffic from customer.

```
(config)#interface xe1
(config-if)#switchport
(config-if)#dot1ad ethertype 0x88a8
(config-if)#bridge-group 1
(config-if)#switchport mode customer-network
(config-if)#switchport customer-network allowed vlan add 100-200,400
```

switchport customer-network vlan

Use this command to set the default SVLAN ID for the Customer Network Port.

Note: Customer-Network Port is not supported in Qumran1 series platforms.

Command Syntax

```
switchport customer-network vlan <2-4094>
no switchport customer-network vlan
```

Parameters

<2-4094> Set the default VLAN ID for the interface.

Default

Default Customer Network VLAN is 1.

Command Mode

Interface mode

Applicability

This command was introduced before OcnOS version 6.2.0

Examples

In this example, the xe1 interface allows C-TAG/untagged traffic from customers, adding SVLAN ID 100 before forwarding to the provider network. While egressing out, the SVLAN ID 100 will be stripped out.

```
(config)#interface xe1
(config-if)#switchport
(config-if)#dot1ad ethertype 0x88a8
(config-if)#bridge-group 1
(config-if)#switchport mode customer-network
(config-if)#switchport customer-network allowed vlan add 100
(config-if)#switchport customer-network vlan 100
```

switchport mode

Use this command to set the switching characteristics of the Layer 2 interface.

Note: Customer-Network Port is not supported in Qumran1 series platforms.

Command Syntax

```
switchport mode (provider-network|customer-edge|customer-network)
```

Parameters

```
provider-network Provider network.  
customer-edge    Customer edge.  
customer-network Customer network.
```

Command Mode

Interface mode

Applicability

This command was introduced before OcNOS version 1.3.

Example

```
#configure terminal  
(config)#interface eth0  
(config-if)#switchport mode provider-network
```

switchport mode customer-edge

Use this command to set the switching characteristics of the Layer 2 customer facing interface and classify only untagged frames. Received frames are classified based on the VLAN characteristics, then accepted or discarded based on the specified filtering criteria.

Command Syntax

```
switchport mode customer-edge (access|hybrid|trunk)
switchport mode customer-edge (access|hybrid|trunk)
```

Parameters

access	Set the layer 2 interface as access.
hybrid	Set the layer 2 interface as hybrid.
trunk	Set the layer 2 interface as trunk.

Command Mode

Interface mode

Applicability

This command was introduced before OcNOS version 1.3.

Example

```
#configure terminal
(config)#interface eth0
(config-if)#switchport mode customer-edge access
```

switchport mode customer-edge hybrid acceptable-frame-type

Use this command to set the layer 2 interface acceptable frames types. This processing occurs after VLAN classification.

Command Syntax

```
switchport mode customer-edge hybrid acceptable-frame-type (all|vlan-tagged)
```

Parameters

all	Set all frames can be received.
vlan-tagged	Set only VLAN-tagged frames can be received.

Command Mode

Interface mode

Applicability

This command was introduced before OcnOS version 1.3.

Example

```
#configure terminal
(config)#interface eth0
(config-if)#switchport mode customer-edge hybrid acceptable-frame-type vlan-
tagged
```

switchport provider-network

Use this command to set the switching characteristics of the provider-network interface.

Command Syntax

```
switchport provider-network allowed vlan add VLAN_RANGE2
switchport provider-network allowed vlan remove VLAN_RANGE2
switchport provider-network allowed vlan except VLAN_RANGE2
switchport provider-network allowed vlan all
switchport provider-network allowed vlan none
```

Parameters

add	Add a VLAN to transmit and receive through the Layer 2 interface.
VLAN_RANGE2	VLAN ID 1-4094 or range(s): 2-5 10 or 2-5 7-20.
remove	Remove a VLAN from the member set.
VLAN_RANGE2	VLAN ID 1-4094 or range(s): 2-5 10 or 2-5 7-20.
Except	All VLANs except these VLANs are part of the member set.
VLAN_RANGE2	VLAN ID 1-4094 or range(s): 2-5 10 or 2-5 7-20.
all	Allow all VLANs to transmit and receive through the Layer 2 interface.
none	Allow no VLANs to transmit and receive through the Layer 2 interface.

Command Mode

Interface mode

Applicability

This command was introduced before OcNOS version 1.3.

Examples

```
(config)#interface eth0
(config-if)#switchport provider-network allowed vlan add 2
```

switchport provider-network isolated-vlan

Use this command to attach a VLAN as an isolated VLAN for a provider network port.

Using an isolated VLAN for PNP ports on a switch can forward all frames received from the PNP port to all other PNP ports. However, if VLANs are configured to be isolated, they can traverse PNP port without sharing any of their frames.

Use the `no` form of this command to remove an isolated VLAN for a provider network port.

Command Syntax

```
switchport provider-network isolated-vlan VLAN_RANGE
no switchport provider-network isolated-vlan VLAN_RANGE
```

Parameters

VLAN_RANGE VLAN identifier <2-4094> or range such as 2-5,10 or 2-5,7-19

Command Mode

Interface mode

Applicability

This command was introduced in OcNOS version 3.0.

Example

```
#configure terminal
(config)#bridge 1 protocol provider-rstp
(config)#vlan database
(config-vlan)#vlan 2-10 type service point-point bridge 1 state enable
(config-vlan)#exit
(config)#interface xe0
(config-if)#switchport
(config-if)#bridge-group 1
(config-if)#switchport provider-network allowed vlan all
(config-if)#switchport provider-network isolated-vlan 2-10
```

switchport provider-network vlan translation

Use this command to add a translation table entry for CVLAN and SVLAN on a provider network port.

Use the `no` form of this command to delete a translation table entry for CVLAN and SVLAN on a provider network port.

Command Syntax

```
switchport provider-network vlan translation (cvlan <2-4094>| ) svlan <2-4094>
  (cvlan <2-4094> | ) svlan <2-4094>
no switchport (provider-network) vlan translation svlan VLAN_ID svlan VLAN_ID
no switchport (provider-network) vlan translation cvlan <1-4095> svlan <1-4095>
```

Parameters

<code>cvlan</code>	CVLAN to translate
<code><2-4094></code>	CVLAN identifier to translate
<code>svlan</code>	SVLAN to translate
<code><2-4094></code>	SVLAN identifier to translate
<code>cvlan</code>	Translated CVLAN
<code><2-4094></code>	Translated CVLAN identifier
<code>svlan</code>	Translated SVLAN
<code><2-4094></code>	Translated SVLAN identifier
<code>scos</code>	Class of Service in the Priority Code Point (PCP) field of the service provider tag (STAG)
<code><0-7></code>	Class-of-service value
<code>scfi</code>	Canonical Format Indicator in the Drop Eligible Indicator (DEI) field of the STAG
<code><0-1></code>	Canonical Format Indicator value
<code>ccos</code>	Class of Service in the PCP field of the customer tag (CTAG)
<code><0-7></code>	Class-of-service value
<code>ccfi</code>	Canonical Format Indicator in the DEI field of the CTAG
<code><0-1></code>	Canonical Format Indicator value

Command Mode

Interface mode

Applicability

This command was introduced before OcNOS version 1.3.

Example

```
#configure terminal
(config)#interface eth1
(config-if)#switchport
(config-if)#bridge-group 1
(config-if)#switchport mode provider-network
(config-if)#switchport provider-network allowed vlan all
```



```
(config-if)#switchport provider-network vlan translation cvlan 2 svlan 3 cvlan  
4 svlan 5
```

vlan type

This command allows you to create a single/range of VLAN's on provide/edge bridge.

Use the no form of this command to delete the VLAN.

Command Syntax

```
vlan VLAN_RANGE type customer bridge <1-32>
vlan VLAN_RANGE type customer bridge <1-32> name WORD
vlan VLAN_RANGE type customer bridge <1-32> state (enable | disable)
vlan VLAN_RANGE type service point-point bridge <1-32>
vlan VLAN_RANGE type service point-point bridge <1-32> name WORD
vlan VLAN_RANGE type service point-point bridge <1-32> state (enable | disable)

no vlan VLAN_RANGE type customer bridge <1-32>
no vlan VLAN_RANGE type service bridge <1-32>
```

Parameters

VLAN_RANGE	VLAN identifier <2-4094> or range such as 2-5,10 or 2-5,7-19
customer	Identifies the Customer VLAN
bridge	Specify the bridge group ID in the range <1-32>.
name	The ASCII name of the VLAN. Maximum length allowed is 16 characters.
point-point	Sets the VLAN connectivity mode to point-to-point
WORD	ASCII name of the VLAN.
state	Indicates the operational state of the VLAN.
enable	Sets VLAN into an enable state.
disable	Sets VLAN into a disable state.

Command Mode

Configuration Mode

Applicability

This command was introduced before OcNOS version 1.3.

Examples

```
(config)vlan 2,4,5-6 customer bridge 2
(config)vlan 10-12 service type point-point bridge 3
```

vlan type customer

Use this command to configure VLANs of type customer, to enable or disable the state of the VLANs, and to configure the name for VLANs.

Use the `no` form of this command to remove the VLAN type.

Command Syntax

```
vlan <2-4094> type customer bridge <1-32>
vlan <2-4094> type customer bridge <1-32> state (enable|disable)
vlan <2-4094> type customer bridge <1-32> name WORD
no vlan <2-4094> type customer bridge <1-32>
```

Parameters

<2-4094>	The VID of the VLAN that will be enabled or disabled on the bridge <2-4094>.
type	Identifies the VLAN as a customer, service, or VLAN.
customer	Identifies the Customer VLAN
bridge	Indicates a Service VLAN <1-32>.
name	The ASCII name of the VLAN. Maximum length allowed is 16 characters.
state	Indicates the operational state of the VLAN.
enable	Sets VLAN into an enable state.
disable	Sets VLAN into a disable state.
WORD	ASCII name of the VLAN.

Command Mode

VLAN Configuration mode

Applicability

This command was introduced before OcNOS version 1.3.

Examples

```
#configure terminal
(config)#vlan database
(config-vlan)#vlan 12 type customer bridge 1 name new state enable
```

CHAPTER 3 Bridge Commands

This chapter provides a description, syntax, and examples of the bridge commands. It includes the following commands:

- `bridge acquire`
- `bridge address`
- `bridge ageing`
- `bridge encapsulation dot1q`
- `bridge forward-time`
- `bridge hello-time`
- `bridge max-age`
- `bridge max-hops`
- `bridge priority`
- `bridge shutdown`
- `bridge transmit-holdcount`
- `bridge-group`
- `bridge-group path-cost`
- `bridge-group priority`
- `clear allowed-ethertype`
- `clear mac address-table`
- `show allowed-ethertype`
- `show bridge`
- `show interface switchport`
- `show mac address-table count bridge`
- `show mac address-table bridge`
- `switchport`
- `switchport allowed ethertype`

bridge acquire

Use this command to enable a bridge to learn station location information for an instance. This helps in making forwarding decisions.

Use the `no` parameter with this command to disable learning.

Note: OcNOS supports only configuration of a single bridge.

Command Syntax

```
bridge <1-32> acquire
no bridge <1-32> acquire
```

Parameter

<1-32> Bridge group ID.

Default

By default, learning is enabled for all instances.

Command Mode

Configure mode

Applicability

This command was introduced before OcNOS version 1.3.

Example

```
#configure terminal
(config)#bridge 3 acquire
(config)#no bridge 3 acquire
```

bridge address

Use this command to add a static forwarding table entry for the bridge.

Use the no parameter with this command to remove the entry for the bridge

Note: Forward MAC must refer to the source MAC, and discard MAC must refer to the destination MAC.

Command Syntax

```
bridge <1-32> address XXXX.XXXX.XXXX (forward|discard) IFNAME
bridge <1-32> address XXXX.XXXX.XXXX (forward|discard) IFNAME vlan <2-4094>
bridge <1-32> address XXXX.XXXX.XXXX (forward|discard) IFNAME vlan <2-4094> svlan
  <2-4094>
no bridge <1-32> address XXXX.XXXX.XXXX
no bridge <1-32> address XXXX.XXXX.XXXX vlan <2-4094>
no bridge <1-32> address XXXX.XXXX.XXXX vlan <2-4094> svlan <2-4094>
```

Parameters

<1-32>	Bridge identifier
XXXX.XXXX.XXXX	Media Access Control (MAC) address in HHHH.HHHH.HHHH format.
forward	Forward matching frames.
discard	Discard matching frames.
IFNAME	Interface on which the frame comes out.
vlan	Identity of the VLAN in the range of <2-4094>.
svlan	Identity of the SVLAN in the range of <2-4094>.

Default

By default, bridge address is disabled

Command Mode

Configure mode

Applicability

This command was introduced before OcNOS version 1.3.

Example

```
#configure terminal
(config)#bridge 1 address 0000.000a.0021 forward eth0
(config)#no bridge 1 address 0000.000a.0021
(config)#bridge 1 address 0011.2222.3333 forward xe5 vlan 23
(config)#no bridge 1 address 0011.2222.3333 vlan 23
(config)#bridge 1 address 0011.2222.3333 forward xe5 vlan 11 svlan 21
(config)#no bridge 1 address 0011.2222.3333 vlan 11 svlan 21
(config)#bridge 1 address 0011.2222.3334 discard xe6 vlan 12 svlan 22
(config)#no bridge 1 address 0011.2222.3334 vlan 12 svlan 22
```

bridge ageing

Use this command to specify the aging time for a learned MAC address. A learned MAC address persists until this specified time.

Note: The bridge aging time affects the ARP entries which are dependent upon the MAC addresses in hardware. If a MAC address ages out, it causes the corresponding ARP entry to refresh.

Note: On Qumran, the MAC aging time can vary by up to 16%. For example, if the MAC aging time is set to 60 seconds, the aging time can happen anywhere between 50-60 seconds.

Use the `no` form of this command to set the MAC address aging time to its default (300).

Command Syntax

```
bridge <1-32> ageing-time (0|<10-572>)
bridge <1-32> ageing disable
no bridge <1-32> ageing-time
```

Parameters

0	Disable Ageing Time
<1-32>	Bridge group ID.
<10-572>	Aging time in seconds.
disable	Turn off MAC address aging completely.

Default

By default, the aging time is 300 seconds.

Command Mode

Configure mode

Applicability

This command was introduced before OcNOS version 1.3.

Example

```
#configure terminal
(config)#bridge 3 ageing-time 100
(config)#no bridge 3 ageing-time
```

bridge encapsulation dot1q

Use this command to add the TPID which is configured on a parent interface in the case of a routed packet destined to an SVI interface.

Use the `no` parameter with this command to configure the default behavior.

Note: OcNOS only supports configuration of a single bridge.

Command Syntax

```
bridge <1-32> encapsulation dot1q
no bridge <1-32> encapsulation dot1q
```

Parameter

<1-32> Bridge group ID.

Default

By default, routed packets destined to an SVI interface adds 0x8100 as the outer TPID.

Command Mode

Configure mode

Applicability

This command was introduced in OcNOS version 4.0.

Example

```
#configure terminal
(config)#bridge 1 encapsulation dot1q
(config)#no bridge 1 encapsulation dot1q
```

bridge forward-time

Use this command to set the time (in seconds) after which (if this bridge is the root bridge) each port changes states to learning and forwarding. This value is used by all instances.

Use the `no` parameter with this command to restore the default value of 15 seconds.

Command Syntax

```
bridge <1-32> forward-time <4-30>
no bridge <1-32> forward-time
```

Parameters

<1-32> Specify the bridge group ID.
<4-30> Specify the forwarding time delay in seconds.

Note: Care should be exercised if the value is to be made below 7 seconds.

Default

By default, value is 15 seconds

Command Mode

Configure mode

Applicability

This command was introduced before OcnOS version 1.3.

Example

```
#configure terminal
(config)#bridge 3 forward-time 6
(config)#no bridge 3 forward-time
```

bridge hello-time

Use this command to set the hello-time, the time in seconds after which (if this bridge is the root bridge) all the bridges in a bridged LAN exchange Bridge Protocol Data Units (BPDUs). A very low value of this parameter leads to excessive traffic on the network, while a higher value delays the detection of topology change. This value is used by all instances.

Configure the bridge instance name before using this command. The allowable range of values is 1-10 seconds. However, make sure that the value of hello time is always greater than the value of hold time (2 seconds by default).

Use the `no` parameter to restore the default value of the hello time.

Note: A Bridge enforces the following relationships for Hello-time, Max-age and Forward-delay.

- $2 \times (\text{Bridge_Forward_Delay} - 1.0 \text{ seconds}) \geq \text{Bridge_Max_Age}$
- $\text{Bridge_Max_Age} \geq 2 \times (\text{Bridge_Hello_Time} + 1.0 \text{ seconds})$

Note: Hello-time is allowed only on RSTP, IEEE and Provider-RSTP types of bridges. For MSTP and Provider-MSTP hello timer is restricted.

Command Syntax

```
bridge <1-32> hello-time <1-10>
no bridge <1-32> hello-time
```

Parameters

- | | |
|--------|---|
| <1-32> | Specify the bridge group ID. |
| <1-10> | Specify the hello BPDU interval in seconds. |

Default

By default, value is 2 seconds

Command Mode

Configure mode

Applicability

This command was introduced before OcnOS version 1.3.

Examples

```
#configure terminal
(config)#bridge 3 hello-time 3

(config)#no bridge 3 hello-time
```

bridge max-age

Use this command to set the maximum age for a bridge. This value is used by all instances.

Maximum age is the maximum time in seconds for which (if a bridge is the root bridge) a message is considered valid. This prevents the frames from looping indefinitely. The value of maximum age should be greater than twice the value of hello time plus 1, but less than twice the value of forward delay minus 1. The allowable range for max-age is 6-40 seconds. Configure this value sufficiently high, so that a frame generated by root can be propagated to the leaf nodes without exceeding the maximum age.

Use the `no` parameter with this command to restore the default value of the maximum age.

Note: A Bridge shall enforce the following relationships for Hello-time, Max-age and Forward-delay.

- $2 \times (\text{Bridge_Forward_Delay} - 1.0 \text{ seconds}) \geq \text{Bridge_Max_Age}$
- $\text{Bridge_Max_Age} \geq 2 \times (\text{Bridge_Hello_Time} + 1.0 \text{ seconds})$

Command Syntax

```
bridge <1-32> max-age <6-40>
no bridge <1-32> max-age
```

Parameters

- | | |
|--------|---|
| <1-32> | Specify the bridge group ID. |
| <6-40> | Specify the maximum time, in seconds, to listen for the root bridge <6-40>. |

Default

By default, bridge maximum age is 20 seconds

Command Mode

Configure Mode

Applicability

This command was introduced before OcnOS version 1.3.

Examples

```
#configure terminal
(config)#bridge 2 max-age 12

(config)#no bridge 2 max-age
```

bridge max-hops

Use this command to specify the maximum allowed hops for a BPDU in an MST region. This parameter is used by all the instances of the MST. Specifying the maximum hops for a BPDU prevents the messages from looping indefinitely in the network. When a bridge receives an MST BPDU that has exceeded the allowed maximum hops, it discards the BPDU.

Use the `no` parameter with this command to restore the default value.

Command Syntax

```
bridge <1-32> max-hops <1-40>
```

```
no bridge <1-32> max-hops
```

Parameters

<1-32> Specify the bridge-group ID.

<1-40> Specify the maximum hops for which the BPDU will be valid <1-40>.

Default

By default, maximum hops in an MST region are 20

Command Mode

Configure mode

Applicability

This command was introduced before OcnOS version 1.3.

Examples

```
#configure terminal
(config)#bridge 3 max-hops 25
```

```
#configure terminal
(config)#no bridge 3 max-hops
```

bridge priority

Use this command to set the bridge priority for the common instance. Using a lower priority indicates a greater likelihood of the bridge becoming root. The priority values can be set only in increments of 4096.

Use the `no` form of the command to reset it to the default value.

Command Syntax

```
bridge (<1-32> | ) priority <0-61440>
no bridge (<1-32> | )priority
```

Parameters

<1-32>	Specify the bridge group ID.
<0-61440>	Specify the bridge priority in the range of <0-61440>.

Default

By default, priority is 32768 (or hex 0x8000).

Command Mode

Configure mode

Applicability

This command was introduced before OcnOS version 1.3.

Examples

```
#configure terminal
(config)#bridge 2 priority 4096

(config)#no bridge 2 priority
```

bridge shutdown

Use this command to disable a bridge.

Use the `no` parameter to reset the bridge.

Command Syntax

```
bridge shutdown <1-32>
bridge shutdown <1-32> ((bridge-blocked|bridge-forward) |)
no bridge shutdown <1-32>
```

Parameters

<1-32>	Specify the bridge group ID.
bridge-forward	Put all ports of the bridge into forwarding state
bridge-blocked	Put all ports of the bridge into blocked state

Default

No default value is specified

Command Mode

Configure mode

Applicability

This command was introduced before OcnOS version 1.3.

Example

```
#configure terminal
(config)#bridge shutdown 4
(config)#no bridge shutdown 4
```

bridge transmit-holdcount

Use this command to set the maximum number of transmissions of BPDUs by the transmit state machine.

Use the `no` parameter with this command to restore the default transmit hold-count value.

Command Syntax

```
bridge <1-32> transmit-holdcount <1-10>
no bridge <1-32> transmit-holdcount
```

Parameters

<1-32>	Specify the bridge group ID.
<1-10>	Transmit hold-count value.

Default

By default, transmit hold-count is 6

Command Mode

Configure mode

Applicability

This command was introduced before OcNOS version 1.3.

Examples

```
#configure terminal
(config)#bridge 1 transmit-holdcount 5

(config)#no bridge 1 transmit-holdcount
```

bridge-group

Use this command to bind an interface with a bridge specified by the parameter.

Use the `no` parameter with this command to disable this command.

Command Syntax

```
bridge-group (<1-32>)  
no bridge-group (<1-32>)
```

Parameters

<1-32> Specify the bridge group ID.

Default

By default, `bridge-group` is disabled

Command Mode

Interface mode

Applicability

This command was introduced before OcnOS version 1.3.

Examples

```
#configure terminal  
(config)#interface eth1  
(config-if)#bridge-group 2  
  
(config)#interface eth1  
(config-if)#no bridge-group 2
```

bridge-group path-cost

Use this command to set the cost of a path associated with a bridge group. The lower the path cost, the greater the likelihood of the bridge becoming root.

Use the `no` parameter with this command to restore the default priority value.

Command Syntax

```
bridge-group <1-32> path-cost <1-200000000>
no bridge-group <1-32> path-cost
```

Parameters

<1-32>	Specify the bridge group ID.
path-cost	Specify the path-cost of a port.
<1-200000000>	Specify the cost to be assigned to the group.

Default

By default, bridge-group is disabled

Command Mode

Interface mode

Applicability

This command was introduced before OcnOS version 1.3.

Example

```
#configure terminal
(config)#interface eth1
(config-if)#bridge-group 3 path-cost 123

(config-if)#no bridge-group 3 path-cost
```

bridge-group priority

Use this command to set the port priority for a bridge. A lower priority indicates a greater likelihood of the bridge becoming root.

Command Syntax

```
bridge-group <1-32> priority <0-240>
no bridge-group <1-32> priority
```

Parameters

<1-32>	Specify the bridge group ID.
<0-240>	Specify the port priority range (a lower priority indicates greater likelihood of the interface becoming a root). The priority values can only be set in increments of 16.

Default

By default, priority is 1

Command Mode

Interface mode

Applicability

This command was introduced before OcnOS version 1.3.

Example

```
#configure terminal
(config)#interface eth1
(config-if)#bridge-group 4 priority 96

(config)#interface eth1
(config-if)#no bridge-group 4 priority
```

clear allowed-ethertype

Use this command to clear statistics for each ethertype per interfaces.

```
clear allowed-ethertype statistics (IFNAME|)
```

Parameters

IFNAME Interface name.

Command Mode

Exec mode

Applicability

This command was introduced before OcNOS version 1.3.

Example

```
#clear allowed-ethertype statistics xe54/1

#show allowed-ethertype statistics xe54/1
Interface xe54/1
arp: 0 Packets, 0 Bytes
ipv4: 0 Packets, 0 Bytes
ipv6: 0 Packets, 0 Bytes
dropped: 0 Packets, 0 Bytes
```

clear mac address-table

Use this command to clear the filtering database for the bridge. This command can be issued to do the following:

- clear the filtering database
- clear all filtering database entries configured through CLI (static)
- clear all multicast filtering database entries
- clear all multicast filtering database entries for a given VLAN or interface
- clear all static or multicast database entries based on a mac address

Command Syntax

```
clear mac address-table (dynamic|multicast) bridge <1-32>
clear mac address-table (dynamic|multicast) (address MACADDR | interface IFNAME |
vlan VID ) bridge <1-32>
clear mac address-table (dynamic|multicast) (address MACADDR | interface IFNAME |
vlan VID ) (instance INST) bridge <1-32>
```

Parameters

dynamic	Clears all dynamic entries.
multicast	Clears all multicast filtering database entries.
address	Clear the specified MAC Address.
MACADDR	When filtering database, entries are cleared based on the MAC address.
bridge	Clears the bridge group ID. Value range is 1-32.
bridge	Clears the bridge group ID. Value range is 1-32.
interface	Clears all MAC address for the specified interface.
bridge	Clears the bridge group ID. Value range is 1-32.
instance	Clears MSTP instance ID. Value range is <1-63>.
vlan	Clears all MAC address for the specified VLAN. Value range is 1-4094.
bridge	Clears the bridge group ID. Value range is 1-32.

Command Mode

Privileged Exec mode

Applicability

This command was introduced before OcNOS version 1.3.

Examples

This example shows how to clear multicast filtering database entries:

```
#clear mac address-table multicast bridge 1
```

This example shows how to clear multicast filtering database entries for a given VLAN.

```
#clear mac address-table multicast vlan 2 bridge 1
```

This example shows how to clear all filtering database entries learned through bridge operation for a given MAC address.

```
#clear mac address-table dynamic address 0202.0202.0202 bridge 1
```

show allowed-ethertype

Use this command to show allowed and denied traffic statistics.

Note: Dropped slow protocol packets provides the count of slow protocol packets among the total dropped count. Total drop count is fetched from hardware and slow protocol packet count is fetched from software. Hence there can be one or two packet difference.

Command Syntax

```
show allowed-ethertype statistics (IFNAME|)
```

Parameters

IFNAME Interface name.

Command Mode

Exec mode

Applicability

This command was introduced before OcNOS version 1.3.

Examples

```
#show allowed-ethertype statistics
Interface po1
arp : 0 Packets, 0 Bytes
ipv4 : 511016709 Packets, 184897169366 Bytes
ipv6 : 0 Packets, 0 Bytes
dropped : 220 Packets, 28160 Bytes
dropped slow protocol pkts : lacp 220, efm 0, others 0
Interface xe47
arp : 0 Packets, 0 Bytes
ipv4 : 169763534 Packets, 61427990740 Bytes
ipv6 : 0 Packets, 0 Bytes
dropped : 0 Packets, 0 Bytes
Interface xe48
arp : 0 Packets, 0 Bytes
ipv4 : 0 Packets, 0 Bytes
ipv6 : 0 Packets, 0 Bytes
dropped : 0 Packets, 0 Bytes
```

show bridge

Use this command to display the filtering database for the bridge. The filtering database is used by a switch to store the MAC addresses that have been learned and which ports that MAC address was learned on.

Command Syntax

```
show bridge (ieee|rpvst+|mstp|)
```

Parameters

ieee	STP bridges.
rpvst+	RPVST+ bridges.
mstp	MSTP bridges.

Command Mode

Exec mode and Privileged Exec mode

Applicability

This command was introduced before OcnOS version 1.3.

Example

```
#show bridge
```

Ageout time is global and if something is configured for vxlan then it will be affected here also

Bridge	CVLAN	SVLAN	BVLAN	Port	MAC Address	FWD	Time-out
1	1			eth1	5254.0029.929c	1	0
1	2			eth1	5254.004c.dcc6	1	297
1	1			eth1	5254.004c.dcc6	1	291

[Table 3-9](#) explains the show command output fields.

Table 3-9: show bridge output fields

Field	Description
Bridge	Bridge identifier.
VLAN, SVLAN, BVLAN	CVLAN, SVLAN, and BVLAN identifiers.
Port	Interface name.
MAC Address	Learned MAC address.
FWD	Whether frames for the MAC addresses are forwarded.
Time-out	How long the learned MAC address persists.

show interface switchport

Use this command to display the characteristics of the interface with the current VLAN.

Command Syntax

```
show interface switchport bridge <1-32>
```

Parameter

bridge Bridge name.

Command Mode

Exec mode and Privileged Exec mode

Applicability

This command was introduced before OcNOS version 1.3.

Example

The following is an output of this command displaying the characteristics of this interface on bridge 2.

```
#show interface switchport bridge 2
Interface name       : eth5
Switchport mode     : access
Ingress filter      : disable
Acceptable frame types : all
Vid swap            : disable
Default vlan        : 2
Configured vlans    : 2
Interface name       : eth4
Switchport mode     : access
Ingress filter      : disable
Acceptable frame types : all
Vid swap            : disable
Default vlan        : 1
Configured vlans    : 1
```

Table 3-10 explains the show command output fields.

Table 3-10: show interface switchport output fields

Field	Description
Interface name	Display the name of interface.
Switchport mode	Port that used to connect between switches and access port.
Ingress filter	Ingress filtering examines all inbound packets and then permits or denies entry to the network.
Acceptable frame types	Type of acceptable frame in the interface.
VID swap	Displays the status of the VID swap.

Table 3-10: show interface switchport output fields (Continued)

Field	Description
Default vlan	Default value for the VLAN.
Configured vlans	Displays the information on configured VLANs.

show mac address-table count bridge

Use this command to display a count of MAC entries from the filtering database.

Command Syntax

```
show mac address-table (local|remote|) count bridge <1-32> ((dynamic | multicast |
static) | address MAC | interface IFNAME | vlan <1-4094> | svlan <1-4094>|)
```

Parameter

local	Local dynamic FDB entries
remote	Remote dynamic FDB entries
<1-32>	Bridge group
dynamic	Dynamic entries
multicast	Multicast entries
static	Static entries
MAC	MAC address in HHHH.HHHH.HHHH format
IFNAME	Name of the interface
<1-4094>	VLAN identifier
<1-4094>	SVLAN identifier

Command Mode

Exec mode

Applicability

This command was introduced before OcnOS version 1.3.

Example

```
#show mac address-table count bridge 1
MAC Entries for all vlans:
Dynamic Address Count: 3
Static (User-defined) Unicast MAC Address Count: 0
Static (User-defined) Multicast MAC Address Count: 0
Total MAC Addresses in Use: 3
```

[Table 3-11](#) explains the show command output fields.

Table 3-11: show mac address-table count output fields

Field	Description
Dynamic Address Count	Number of dynamic addresses.
Unicast MAC Address Count	Number of unicast addresses.
Multicast MAC Address Count	Number of multicast addresses.
Total MAC Addresses	Total number of addresses.

show mac address-table bridge

Use this command to display MAC entries from the filtering database.

Note: The hardware can learn the MAC address at line rate, but OcnOS will learn the MAC address at a much slower rate. The learning in OcnOS will also depend upon the current load in the system. Under normal conditions OcnOS can learn the mac-address at approximately 3000 MACs per sec.

Command Syntax

```
show mac address-table (local|remote|) bridge <1-32> ({(dynamic | multicast |
static) | address MAC | interface IFNAME | vlan <1-4094> | svlan <1-4094>})
```

Parameter

local	Local dynamic FDB entries
remote	Remote dynamic FDB entries
<1-32>	Bridge group
dynamic	Dynamic entries
multicast	Multicast entries
static	Static entries
MAC	MAC address in HHHH.HHHH.HHHH format
IFNAME	Name of the interface
<1-4094>	VLAN identifier
<1-4094>	SVLAN identifier

Command Mode

Exec mode

Applicability

This command was introduced before OcnOS version 1.3.

Example

```
#show mac address-table bridge 1
CVLAN  SVLAN  MAC Address      Type      Ports      Port-security
-----+-----+-----+-----+-----+-----
100    200    1111.2222.1111  static   xe12      Disable
102    202    1111.2222.1111  static   xe12      Disable
      201    1111.1111.1111  static   xe14      Disable
      202    1111.1111.1111  static   xe14      Disable
      203    1111.1111.1111  static   xe14      Disable
      201    0000.0700.0d00  dynamic   xe14      Disable
      202    0000.0700.0d00  dynamic   xe14      Disable
      203    0000.0700.0d00  dynamic   xe14      Disable
      204    0000.0700.0d00  dynamic   xe14      Disable
      205    0000.0700.0d00  dynamic   xe14      Disable
      206    0000.0700.0d00  dynamic   xe14      Disable
      207    0000.0700.0d00  dynamic   xe14      Disable
      208    0000.0700.0d00  dynamic   xe14      Disable
      209    0000.0700.0d00  dynamic   xe14      Disable
```

```

103 203 0000.0700.0b00 dynamic xe12 Disable
101 201 0000.0700.0b00 dynamic xe12 Disable
100 200 0000.0700.0b00 dynamic xe12 Disable
102 202 0000.0700.0b00 dynamic xe12 Disable

```

Table 3-12 explains the show command output fields.

Table 3-12: show mac address-table output fields

Field	Description
VLAN	VLAN identifier.
MAC Address	Media Access Control address.
Type	Dynamic, multicast, or static.
Ports	Interface name.

switchport

Use this command to set the mode of an interface to switched.

All interfaces are configured routed by default. To change the behavior of an interface from switched to routed, you must explicitly give the `no switchport` command.

Note: When you change the mode of an interface from switched to routed and vice-versa, all configurations for that interface are erased.

Use the `no` form of this command to set the mode to routed.

Command Syntax

```
switchport
no switchport
```

Parameters

None

Default

All interfaces are configured routed by default. To change the behavior of an interface from switched to routed, you must explicitly give the `no switchport` command.

Command Mode

Interface mode

Applicability

This command was introduced before OcNOS version 1.3.

Examples

```
#configure terminal
(config)#interface eth0
(config-if)#switchport

(config)#interface eth0
(config-if)#no switchport
```

switchport allowed ethertype

Use this command to allow a set of ethertype on the access port and deny remaining traffic.

Use the no command to remove ethertype configuration.

Command Syntax

```
switchport allowed ethertype {arp|ipv4|ipv6|mpls|WORD|log}
no switchport allowed ethertype ({arp|ipv4|ipv6|mpls|WORD|log}|)
```

Parameters

arp	Ethertype 0x0806.
ipv4	Ethertype 0x0800.
ipv6	Ethertype 0x086dd.
mpls	Ethertype 0x8847.
WORD	Any Ethertype value (0x600 - 0xFFFF).
log	Log unwanted ethertype packets.

Default

No default value is specified

Command Mode

Interface mode

Applicability

This command was introduced before OcNOS version 1.3.

Examples

```
#configure terminal
(config)#interface xe1
(config-if)#switchport allowed ethertype arp ipv4 ipv6 log

(config-if)#no switchport allowed ethertype ipv4
```

CHAPTER 4 Spanning Tree Protocol Commands

This chapter provides a description, syntax, and examples of the Spanning Tree Protocol (STP), Rapid Spanning Tree Protocol (RSTP) and Multiple Spanning Tree Protocol (MSTP) commands. It includes the following commands:

- `bridge cisco-interoperability`
- `bridge instance`
- `bridge instance priority`
- `bridge instance vlan`
- `bridge multiple-spanning-tree`
- `bridge protocol ieee`
- `bridge protocol mstp`
- `bridge protocol rstp`
- `bridge rapid-spanning-tree`
- `bridge region`
- `bridge revision`
- `bridge spanning-tree`
- `bridge spanning-tree errdisable-timeout`
- `bridge spanning-tree force-version`
- `bridge spanning-tree pathcost`
- `bridge spanning-tree portfast`
- `bridge te-msti`
- `bridge te-msti vlan`
- `bridge-group instance`
- `bridge-group instance path-cost`
- `bridge-group instance priority`
- `bridge-group path-cost`
- `bridge-group priority`
- `bridge-group spanning-tree`
- `clear spanning-tree detected protocols`
- `clear spanning-tree statistics`
- `customer-spanning-tree customer-edge path-cost`
- `customer-spanning-tree customer-edge priority`
- `customer-spanning-tree forward-time`
- `customer-spanning-tree hello-time`
- `customer-spanning-tree max-age`
- `customer-spanning-tree priority`
- `customer-spanning-tree provider-edge path-cost`
- `customer-spanning-tree provider-edge priority`
- `customer-spanning-tree transmit-holdcount`

- `debug mstp`
- `show debugging mstp`
- `show spanning-tree`
- `show spanning-tree mst`
- `show spanning-tree statistics`
- `spanning-tree autoedge`
- `spanning-tree edgeport`
- `spanning-tree edgeport`
- `spanning-tree guard`
- `spanning-tree instance restricted-role`
- `spanning-tree instance restricted-tcn`
- `spanning-tree link-type`
- `spanning-tree mst configuration`
- `spanning-tree restricted-domain-role`
- `spanning-tree restricted-role`
- `spanning-tree restricted-tcn`
- `spanning-tree te-msti configuration`
- `storm-control`

bridge cisco-interoperability

Use this command to enable/disable Cisco interoperability for MSTP (Multiple Spanning Tree Protocol).

If Cisco interoperability is required, all OcnOS devices in the switched LAN must be Cisco-interoperability enabled. When OcnOS inter operates with Cisco, the only criteria used to classify a region are the region name and revision level. VLAN-to-instance mapping is not used to classify regions when interoperating with Cisco.

Command Syntax

```
bridge <1-32> cisco-interoperability (enable | disable)
```

Parameters

<1-32>	Specify the bridge group ID
enable	Enable Cisco interoperability for MSTP bridge
disable	Disable Cisco interoperability for MSTP bridge

Default

By default, cisco interoperability is disabled.

Command Mode

Configure mode

Applicability

This command was introduced before OcnOS version 1.3.

Examples

To enable Cisco interoperability on a switch for a bridge:

```
#configure terminal
(config)#bridge 2 cisco-interoperability enable
```

To disable Cisco interoperability on a switch for a particular bridge:

```
#configure terminal
(config)#bridge 2 cisco-interoperability disable
```

bridge instance

Use this command to add an MST instance to a bridge.

Use the `no` form of this command to delete an MST instance identifier from a bridge.

Command Syntax

```
bridge (<1-32> | backbone) instance (<1-62>)  
no bridge (<1-32> | backbone) instance (<1-62>)
```

Parameters

<1-32>	Bridge identifier.
backbone	Backbone bridge.
<1-62>	MST instance identifier.

Default

The bridge instance default is 1.

Command Mode

MST configure mode

Applicability

This command was introduced before OcnOS version 1.3.

Examples

```
#configure terminal  
(config)#bridge 4 protocol mstp  
(config)#spanning-tree mst configuration  
(config-mst)#bridge 4 instance 3  
...  
(config-mst)#no bridge 4 instance 3
```

bridge instance priority

Use this command to set the bridge instance priority.

Use the `no` form of this command to reset the priority to its default.

Command Syntax

```
bridge (<1-32> | backbone) instance <1-63> priority <0-61440>
no bridge (<1-32> | backbone) instance <1-63> priority
```

Parameters

<code><1-32></code>	Specify the bridge identifier.
<code>backbone</code>	Specifies the backbone bridge.
<code><1-63></code>	Specify the instance identifier.
<code>priority</code>	Specify the bridge priority for the instance. The lower the priority of the bridge, the better the chances is of the bridge becoming a root bridge or a designated bridge for the LAN. The priority values can be set only in increments of 4096. The default value is 32768.
<code><0-61440></code>	Specify the bridge priority.

Default

By default, bridge instance priority is 32768

Command Mode

Configure mode

Applicability

This command was introduced before OcNOS version 1.3.

Examples

```
(config)#bridge 4 instance 3 priority 1
```

bridge instance vlan

Use this command to simultaneously add multiple VLANs for the corresponding instance of a bridge. The VLANs must be created before being associated with an MST instance (MSTI). If the VLAN range is not specified, the MSTI will not be created.

Use the `no` form of this command to simultaneously remove multiple VLANs for the corresponding instance of a bridge.

Command Syntax

```
bridge (<1-32> | backbone) instance (<1-63>) vlan VLANID
no bridge (<1-32> | backbone) instance (<1-63>) vlan VLANID
```

Parameters

<1-32>	Bridge identifier.
backbone	Backbone bridge.
<1-63>	MST instance identifier.
VLANID	VLAN identifier(s) <2-4094>. You can specify a single VLAN, a VLAN range, or a VLAN list. For a VLAN range, specify two VLAN identifiers: the lowest and then the highest separated by a hyphen. For a VLAN list, specify the VLAN identifiers separated by commas. Do not enter spaces between the hyphens or commas.

Default

The bridge instance VLAN ID Interfaces default-switch is VLAN100 100 ae0.0 ae1.0 ae2.0.

Command Mode

MST configure mode

Applicability

This command was introduced before OcNOS version 1.3.

Examples

To associate multiple VLANs, in this case VLANs 10 and 20 to instance 1 of bridge 1:

```
#configure terminal
(config)#bridge 1 protocol mstp
(config)#spanning-tree mst configuration
(config-mst)#bridge 1 instance 1 vlan 10,20
```

To associate multiple VLANs, in this case, VLANs 10, 11, 12, 13, 14, and 15 to instance 1 of bridge 1:

```
#configure terminal
(config)#bridge 1 protocol mstp
(config)#spanning-tree mst configuration
(config-mst)#bridge 1 instance 1 vlan 10-15
```

To delete multiple VLANs, in this case, VLANs 10 and 11 from instance 1 of bridge 1:

```
#configure terminal
(config)#bridge 1 protocol mstp
(config)#spanning-tree mst configuration
```

```
(config-mst)#no bridge 1 instance 1 vlan 10,11
```

bridge multiple-spanning-tree

Use this command to enable MSTP on a bridge.

Use the `no` form of this command to disable MSTP on the bridge.

Command Syntax

```
bridge <1-32> multiple-spanning-tree enable
no bridge <1-32> multiple-spanning-tree enable (bridge-forward|bridge-block)
```

Parameters

<code><1-32></code>	Specify the bridge-group ID.
<code>enable</code>	Enables the spanning tree protocol.
<code>bridge-forward</code>	Puts all ports of the specified bridge into forwarding state.
<code>bridge-block</code>	Puts all ports of the specified bridge into blocking state.

Default

If the `bridge-forward` option is entered when using the `no` parameter, the default behavior is to put all bridge ports in forwarding state.

If the `bridge-block` option is entered when using the `no` parameter, the behavior is to put all bridge ports in blocking state.

If no options are defined after the command `no bridge <1-32> multiple-spanning-tree enable`, then the default behavior is same as `bridge-block` command.

Command Mode

Configure mode

Applicability

This command was introduced before OcNOS version 1.3.

Examples

```
#configure terminal
(config)#bridge 2 multiple-spanning-tree enable

#configure terminal
(config)#no bridge 2 multiple-spanning-tree enable bridge-forward
```

bridge protocol ieee

Use this command to add a IEEE 802.1d Spanning Tree Protocol bridge.

After creating a bridge instance, add interfaces to the bridge using the `bridge-group` command. Bring the bridge instance into operation with the `no shutdown` command in interface mode.

Use the `no` parameter with this command to remove the bridge.

Command Syntax

```
bridge <1-32> protocol ieee (vlan-bridge|)
no bridge <1-32>
```

Parameters

<1-32>	Specify the bridge group ID.
vlan-bridge	Specify this as a VLAN-aware bridge.

Default

Disabled

Command Mode

Configure mode

Applicability

This command was introduced before OcnOS version 1.3.

Example

```
#configure terminal
(config)#bridge 3 protocol ieee

(config)#bridge 4 protocol ieee vlan-bridge
```

bridge protocol mstp

Use this command to create a multiple spanning-tree protocol (MSTP) bridge of a specified parameter. This command creates an instance of the spanning tree and associates the VLANs specified with that instance.

The MSTP bridges can have different spanning-tree topologies for different VLANs inside a region of “similar” MSTP bridges. The multiple spanning tree protocol, like the rapid spanning tree protocol, provides rapid reconfiguration capability, while providing load balancing ability. A bridge created with this command forms its own separate region unless it is added explicitly to a region using the `region name` command.

Use the `no` parameter with this command to remove the bridge.

Command Syntax

```
bridge <1-32> protocol mstp
no bridge <1-32>
```

Parameters

<1-32> Specify the bridge group ID.

Default

Disabled

Command Mode

Configure mode

Applicability

This command was introduced before OcnOS version 1.3.

Examples

```
#configure terminal
(config)#bridge 2 protocol mstp
```

bridge protocol rstp

Use this command to add an IEEE 802.1w Rapid Spanning Tree Protocol (RSTP) bridge.

After creating a bridge instance, add interfaces to the bridge using the `bridge-group` command. Bring the bridge instance into operation with the `no shutdown` command in Interface mode.

Use the `no` parameter with this command to remove the bridge.

Command Syntax

```
bridge <1-32> protocol rstp
bridge <1-32> protocol rstp (vlan-bridge|)
no bridge <1-32>
```

Parameters

<code><1-32></code>	Specify the bridge group ID.
<code>vlan-bridge</code>	(Optional) Adds a VLAN-aware bridge.

Default

Disabled

Command Mode

Configure mode

Applicability

This command was introduced before OcnOS version 1.3.

Examples

```
#configure terminal
(config)#bridge 2 protocol rstp
```

bridge rapid-spanning-tree

Use this command to enable or disable RSTP on a specific bridge. Use the `bridge-forward` option with the `no` form of the command to place all ports on the specified bridge into the forwarding state.

Use the `no` form of the command to disable the Rapid Spanning Tree protocol on a bridge.

Command Syntax

```
bridge <1-32> rapid-spanning-tree enable
no bridge <1-32> rapid-spanning-tree enable (bridge-forward|bridge-block)
```

Parameters

<code><1-32></code>	Specify the bridge group ID.
<code>enable</code>	Enables the spanning tree protocol.
<code>bridge-forward</code>	(Optional) Puts all ports of the specified bridge into forwarding state.
<code>bridge-block</code>	(Optional) Puts all ports of the specified bridge into blocking state.

Default

When the `bridge-forward` option is used with the `no` parameter, the default behavior puts all bridge ports in the forwarding state.

If the `bridge-block` option is entered when using the `no` parameter, the behavior is to put all bridge ports in blocking state.

If no options are defined after the command `no bridge <1-32> rapid-spanning-tree enable`, then the default behavior is same as `bridge-block` command.

Command Mode

Configure mode

Applicability

This command was introduced before OcNOS version 1.3.

Examples

```
configure terminal
(config)#bridge 2 rapid-spanning-tree enable

configure terminal
(config)#no bridge 2 rapid-spanning-tree enable bridge-forward
```

bridge region

Use this command to create an MST region and specify its name. MST bridges of a region form different spanning trees for different VLANs.

Use the `no` form of the command to disable the Rapid Spanning Tree protocol on a region.

Command Syntax

```
bridge <1-32> region REGION_NAME
no bridge <1-32> region
```

Parameters

<1-32>	Specify the bridge group ID.
REGION_NAME	Specify the name of the region.

Default

By default, each MST bridge starts with the region name as its bridge address. This means each MST bridge is a region by itself, unless specifically added to one.

Command Mode

MST configure mode

Applicability

This command was introduced before OcnOS version 1.3.

Examples

```
#configure terminal
(config)#spanning-tree mst configuration
(config-mst)#bridge 3 region myRegion

(config)#spanning-tree mst configuration
(config-mst)#no bridge 3 region
```

bridge revision

Use this command to specify the number for configuration information.

Command Syntax

```
bridge <1-32> revision <0-65535>
```

Parameters

<1-32>	Specify the bridge group ID in the range of <1-32>.
<0-65535>	Specify a revision number in the range of <0-65535>.

Default

By default, revision number is 0

Command Mode

MST configure mode

Applicability

This command was introduced before OcnOS version 1.3.

Example

```
#configure terminal
(config)#spanning-tree mst configuration
(config-mst)#bridge 3 revision 25
```

bridge spanning-tree

Use this command to enable the Spanning Tree Protocol on a bridge.

Use the `no` parameter to disable the Spanning Tree Protocol on the bridge.

Command Syntax

```
bridge <1-32> spanning-tree enable
no bridge <1-32> spanning-tree enable (bridge-forward|bridge-block)
```

Parameters

<code><1-32></code>	Specify the bridge group ID.
<code>enable</code>	Enables the spanning tree protocol on this bridge.
<code>bridge-forward</code>	Puts all ports of the specified bridge into the forwarding state.
<code>bridge-block</code>	Puts all ports of the specified bridge into the blocking state.

Default

If the `bridge-forward` option is entered when using the `no` parameter, the default behavior is to put all bridge ports in forwarding state.

If the `bridge-block` option is entered when using the `no` parameter, the behavior is to put all bridge ports in blocking state.

If no options are defined after the command `no bridge <1-32> spanning-tree enable`, then the default behavior is same as `bridge-block` command.

Command Mode

Configure mode

Applicability

This command was introduced before OcNOS version 1.3.

Examples

```
#configure terminal
(config)#bridge 2 spanning-tree enable

#configure terminal
(config)#no bridge 2 spanning-tree enable bridge-forward
```

bridge spanning-tree errdisable-timeout

Use this command to enable the error-disable-timeout facility, which sets a timeout for ports that are disabled due to the BPDU guard feature.

The BPDU guard feature shuts down the port on receiving a BPDU on a BPDU-guard enabled port. This command associates a timer with the feature such that the port gets enabled back without manual intervention after a set interval.

Use the `no` parameter to disable the error-disable-timeout facility.

Command Syntax

```
bridge <1-32> spanning-tree errdisable-timeout enable
no bridge <1-32> spanning-tree errdisable-timeout enable
```

Parameters

<code><1-32></code>	Specify the bridge group ID.
<code>enable</code>	Enable the timeout mechanism for the port to be enabled back

Default

By default, the port is enabled after 300 seconds

Command Mode

Configure mode

Applicability

This command was introduced before OcnOS version 1.3.

Examples

```
#configure terminal
(config)#bridge 1 spanning-tree errdisable-timeout enable
```

bridge spanning-tree force-version

Use this command to set the version for the bridge. A version identifier of less than a value of 2 enforces the spanning tree protocol. Although the command supports an input range of 0-4, for RSTP, the valid range is 0-2. When the force-version is set for a bridge, all ports of the bridge have the same spanning tree version set.

Use the `show spanning tree` command to display administratively configured and currently running values of the BPDU filter parameter for the bridge and port (see [show spanning-tree](#)).

Use the `no` parameter with this command to disable the version for the bridge.

Command Syntax

```
bridge <1-32> spanning-tree force-version <0-4>
no bridge <1-32> spanning-tree force-version
```

Parameters

<1-32>	Specify the bridge group ID.
force-version	Specify a force version identifier:
0	STP
1	Not supported
2	RSTP
3	MSTP

Default

By default, spanning tree force version is 0

Command Mode

Configure mode

Applicability

This command was introduced before OcNOS version 1.3.

Examples

Set the value to enforce the spanning tree protocol:

```
#configure terminal
(config)#bridge 1 spanning-tree force-version 0

(config)#no bridge 1 spanning-tree force-version
```

bridge spanning-tree pathcost

Use this command to set a spanning-tree path cost method.

If the short parameter is used, the switch uses a value for the default path cost a number in the range 1 through 65,535. If the long parameter is used, the switch uses a value for the default path cost a number in the range 1 through 200,000,000. Use the [show spanning-tree](#) to view the administratively configured and current running pathcost method running on a bridge.

Use the `no` option with this command to return the path cost method to the default setting.

Command Syntax

```
bridge <1-32> spanning-tree pathcost method (short|long)
no bridge <1-32> spanning-tree pathcost method
```

Parameters

<code><1-32></code>	Specify the bridge group ID.
<code>method</code>	Method used to calculate default port path cost.
<code>long</code>	Use 16-bit based values for default port path costs.
<code>short</code>	Use 32-bit based values for default port path costs.

Default

By default, path cost method for STP is short and for MSTP/RSTP is long.

Command Mode

Configure mode

Applicability

This command was introduced before OcNOS version 1.3.

Examples

```
#configure terminal
(config)#bridge 1 spanning-tree pathcost method short

(config)#no bridge 1 spanning-tree pathcost method
```

bridge spanning-tree portfast

Use this command to set the portfast BPDU (Bridge Protocol Data Unit) guard or filter for the bridge.

Use the `show spanning tree` command to display administratively configured and currently running values of the BPDU filter parameter for the bridge and port (see [show spanning-tree](#)).

Use the `no` parameter with this command to disable the BPDU filter for the bridge.

BPDU Filter

All ports that have their BPDU filter set to default take the same value of BPDU filter as that of the bridge. The Spanning Tree Protocol sends BPDUs from all ports. Enabling the BPDU Filter feature ensures that PortFast-enabled ports do not transmit or receive any BPDUs.

Note: On BPDU-Filter enabled port when BPDU is received the interface loses its port-fast operational status and re-enable the spanning-tree operation. Hence the "spanning-tree portfast" is removed from the interface which is an expected behavior.

BPDU Guard

When the BPDU guard feature is set for a bridge, all portfast-enabled ports of the bridge that have the BPDU guard set to default shut down the port on receiving a BPDU. In this case, the BPDU is not processed. You can either bring the port back up manually by using the `no shutdown` command, or configure the `errdisable-timeout` feature to enable the port after the specified time interval.

Command Syntax

```
bridge <1-32> spanning-tree portfast bpdu-guard
bridge <1-32> spanning-tree portfast bpdu-filter
no bridge <1-32> spanning-tree portfast bpdu-guard
no bridge <1-32> spanning-tree portfast bpdu-filter
```

Parameters

<1-32>	Specify the bridge group ID.
bpdu-filter	Specify to filter the BPDUs on portfast enabled ports.
bpdu-guard	Specify to guard the portfast ports against BPDU receive.

Default

By default, portfast for STP is enabled

Command Mode

Configure mode

Applicability

This command was introduced before OcnOS version 1.3.

Example

```
#configure terminal
(config)#bridge 3 spanning-tree portfast bpdu-filter
```

```
#configure terminal  
(config)#bridge 1 spanning-tree portfast bpdu-guard
```

bridge te-msti

Use this command to enable or disable a Multiple Spanning Tree Instance (MSTI).

The `te-msti` always refers to the MST instance indexed by the pre-defined macro constant `MSTP_TE_MSTID` internally. This is the only MST instance which supports the disabling of spanning trees.

Use the `no` form of this command to remove the configuration.

Command Syntax

```
bridge (<1-32> | backbone) te-msti
no bridge (<1-32> | backbone) te-msti
```

Parameters

<code><1-32></code>	Specify the bridge group ID.
<code>backbone</code>	Identity of the backbone bridge group.
<code>te-msti</code>	MSTI to be the traffic engineering MSTI instance.

Default

By default, `bridge te-msti` is disabled

Command Mode

TE-MSTI Configure mode

Applicability

This command was introduced before OcnOS version 1.3.

Examples

```
#configure terminal
(config)#spanning-tree te-msti configuration
(config-te-msti)#bridge 2 te-msti

(config-te-msti)#no bridge 2 te-msti
```

bridge te-msti vlan

Use this command to enable or disable a Multiple Spanning Tree Instance (MSTI). When an MSTI is shutdown (disabled) each VLAN in the MSTI is set to the forwarding state on all bridge ports which the VLAN is a member of. When an MSTI is enabled (no shutdown), normal MSTP operation is started for the MSTI.

The `te-msti` always refers to the MST instance indexed by the pre-defined macro constant `MSTP_TE_MSTID` internally. This is the only MST instance which supports the disabling of spanning trees. All VLANs that do not want spanning tree topology computation need to be assigned to this `te-msti` instance.

This command is intended for supporting Traffic Engineering (TE) Ethernet tunnels. All VLANs allocated for traffic engineering should be assigned to one MSTI. That MSTI can in turn shutdown the spanning tree operation so that each VLAN path through the network can be manually provisioned.

Use the `no` form of this command to remove the configuration.

Command Syntax

```
bridge (<1-32> | backbone) te-msti vlan <1-4094>
no bridge (<1-32> | backbone) te-msti vlan <1-4094>
```

Parameters

<code><1-32></code>	Specify the bridge group ID.
<code>backbone</code>	Identity of the backbone bridge group.
<code>vlan</code>	Specify a VLAN.
<code><1-4094></code>	Specify a VLAN identifier to be associated.

Note: This designated instance is defined in 802.1Qay clause 8.9 to be 0xFFE.

Default

By default, `te-msti vlan` is `vlan1`.

Command Mode

TE-MSTI Configure mode

Applicability

This command was introduced before OcnOS version 1.3.

Examples

```
#configure terminal
(config)#spanning-tree te-msti configuration
(config-te-msti)#bridge 2 te-msti vlan 10
(config-te-msti)#no bridge 2 te-msti vlan 10
```

bridge-group instance

Use this command to assign a Multiple Spanning Tree (MST) instance to a port.

Use the `no` form of this command to remove the interface from the MST instance.

Command Syntax

```
bridge-group (<1-32> | backbone) instance (<1-63> | te-msti)
no bridge-group (<1-32> | backbone) instance (<1-63> | te-msti)
```

Parameters

<code><1-32></code>	Bridge identifier.
<code>backbone</code>	Backbone bridge.
<code><1-63></code>	Multiple spanning tree instance identifier.
<code>te-msti</code>	Traffic engineering MSTI instance.

For Provider Backbone Bridging (PBB), bridge-group <1-32> refers to the I-component or PB bridge while the <backbone> bridge group refers to the B-component. Usually for a BEB (Backbone Edge Bridge) device, the backbone bridge-group is used for traffic engineering.

For a PB (Provider Bridge) device used as BCB (Backbone Core Bridge), bridge group <1-32> is used for traffic engineering.

Default

By default, the bridge port remains in the listening and learning states for 15 seconds before transitional to the forwarding state.

Command Mode

Interface mode

Applicability

This command was introduced before OcNOS version 1.3.

Examples

```
#configure terminal
(config)#interface eth0
(config-if)#bridge-group 1
(config-if)#bridge-group 1 instance te-msti
```

bridge-group instance path-cost

Use this command to set a path cost for a multiple spanning tree instance.

Before you can give this command, you must explicitly add an MST instance to a port using the `bridge-group instance` command.

Use the `no` form of this command to set the path cost to its default which varies depending on bandwidth.

Command Syntax

```
bridge-group (<1-32> | backbone) instance <1-63> path-cost <1-200000000>
no bridge-group ( <1-32> | backbone) instance <1-63> path-cost
```

Parameters

<1-32>	Bridge identifier.
backbone	Specify the backbone bridge.
<1-63>	Set the MST instance identifier.
<1-200000000>	Path cost for a port (a lower path cost means greater likelihood of becoming root).

Default

Assuming a 10 Mb/s link speed, the default value is 200,000.

Command Mode

Interface mode

Applicability

This command was introduced before OcnOS version 1.3.

Example

```
#configure terminal
(config)#spanning-tree mst configuration
(config-mst)#bridge 4 instance 3 vlan 3
(config-mst)#exit
(config)#interface eth1
(config-if)#bridge-group 4 instance 3
(config-if)#bridge-group 4 instance 3 path-cost 1000
```

bridge-group instance priority

Use this command to set the priority of a multiple spanning tree instance.

The Multiple Spanning Tree Protocol uses port priority as a tiebreaker to determine which port should forward frames for a particular instance on a LAN, or which port should be the root port for an instance. A lower value implies a better priority. In the case of the same priority, the interface index will serve as the tiebreaker, with the lower-numbered interface being preferred over others.

Command Syntax

```
bridge-group (<1-32>) instance (<1-63>) priority <0-240>
no bridge-group (<1-32>) instance (<1-63>) priority
```

Parameters

<1-32>	Bridge identifier.
backbone	Backbone bridge.
<1-63>	Multiple spanning tree instance identifier.
<0-240>	Port priority. A lower value means greater likelihood of becoming root. Set the port priority in increments of 16.

Default

By default, the port priority is 128

Command Mode

Interface mode

Applicability

This command was introduced before OcnOS version 1.3.

Example

```
(config)#interface eth2
(config-if)#bridge-group 2
(config-if)#bridge-group 2 instance 4
(config-if)#bridge-group 2 instance 4 priority 64
```

bridge-group path-cost

Use this command to set the cost of a path. Before you can use this command to set a path-cost in a VLAN configuration, you must explicitly add an MST instance to a port using the `bridge-group instance` command.

Use the `no` parameter with this command to restore the default cost value of the path which varies depending on the bandwidth.

Command Syntax

```
bridge-group <1-32> path-cost <1-200000000>
no bridge-group <1-32> path-cost
```

Parameters

<code><1-32></code>	Specify the bridge group ID.
<code>path-cost</code> <code><1-200000000></code>	Specify the cost of path for a port. Specify the cost of the path (a lower cost means a greater likelihood of the interface becoming root).

Default

Assuming a 10 Mb/s link speed, the default value is 200,000.

Command Mode

Interface mode

Applicability

This command was introduced before OcnOS version 1.3.

Examples

```
#configure terminal
(config)#spanning-tree mst configuration
(config-mst)#bridge 4 instance 3 vlan 3
(config-mst)#exit
(config)#interface eth1
(config-if)#bridge-group 4
(config-if)#bridge-group 4 path-cost 1000
```

bridge-group priority

Use this command to set the port priority for a bridge group.

The Multiple Spanning Tree Protocol uses port priority as a tiebreaker to determine which port should forward frames for a particular instance on a LAN, or which port should be the root port for an instance. A lower value implies a better priority. In the case of the same priority, the interface index will serve as the tiebreaker, with the lower-numbered interface being preferred over others.

Command Syntax

```
bridge-group (<1-32> | backbone) priority <0-240>
no bridge-group (<1-32> | backbone) priority
```

Parameters

<1-32>	Specify the bridge group ID.
backbone	Backbone bridge.
<0-240>	Specify the port priority (a lower priority indicates greater likelihood of the interface becoming a root). The priority values can only be set in increments of 16.

Default

By default, port priority for each instance is 128

Command Mode

Interface mode

Applicability

This command was introduced before OcnOS version 1.3.

Example

```
#configure terminal
(config)#interface eth0
(config-if)#bridge-group 4 priority 80
```

bridge-group spanning-tree

This command is used to enable or disable the spanning-tree on a configured bridge.

Command Syntax

```
bridge-group <1-32> spanning-tree (disable|enable)
```

Parameters

<1-32>	Specify the bridge group ID.
disable	Disable spanning tree on the interface.
enable	Enable spanning tree on the interface.

Default

By default, spanning-tree is enabled

Command Mode

Interface mode

Applicability

This command was introduced before OcnOS version 1.3.

Example

```
(config)#interface eth1  
(config-if)#bridge-group 1 spanning-tree enable
```

clear spanning-tree detected protocols

Use this command to clear the detected protocols for a specific bridge or interface. This command begins the port migration as per IEEE 802.1w-2001, Section 17.26. After issuing this command, the migration timer is started on the port, only if the force version is RSTP or MSTP (greater versions of RSTP).

Command Syntax

```
clear spanning-tree detected protocols bridge <1-32>
```

Parameters

<1-32> Specify the bridge group ID.

Command Mode

Exec mode and Privileged Exec mode

Applicability

This command was introduced before OcnOS version 1.3.

Example

```
#clear spanning-tree detected protocols bridge 2
```

clear spanning-tree statistics

Use this command to clear all STP BPDU statistics.

Command Syntax

```
clear spanning-tree statistics bridge <1-32>
clear spanning-tree statistics interface IFNAME (instance (<1-63>)| vlan <1-4094>)
  bridge <1-32>
clear spanning-tree statistics (interface IFNAME| (instance (<1-63>)| vlan <2-
  4094>)) bridge <1-32>
```

Parameters

<1-32>	Specify the bridge identifier.
IFNAME	Specify the name of the interface on which protocols have to be cleared.
<1-63>	MST instance ID.
<1-4094>	VLAN identifier where spanning tree is located <2-4094>

Command Mode

Exec mode and Privileged Exec mode

Applicability

This command was introduced before OcNOS version 1.3.

Example

```
#clear spanning-tree statistics bridge 32
```

customer-spanning-tree customer-edge path-cost

Use this command to set the cost of a path associated with a customer edge port on a customer edge spanning tree.

Use the `no` form of this command to remove the cost of a path associated with a customer edge port on a customer edge spanning tree.

Command Syntax

```
customer-spanning-tree customer-edge path-cost <1-200000000>
no customer-spanning-tree customer-edge path-cost
```

Parameters

<code>path-cost</code>	Specify the path-cost of a port.
<code><1-200000000></code>	Specify the cost to be assigned to the group.

Default

Assuming a 10 Mb/s link speed, the default value is 200,000

Command Mode

Interface mode

Applicability

This command was introduced before OcnOS version 1.3.

Example

```
#configure terminal
(config)#interface eth1
(config-if)#customer-spanning-tree customer-edge path-cost 1000
```

customer-spanning-tree customer-edge priority

Use this command to set the port priority for a customer-edge port in the customer spanning tree.

Command Syntax

```
customer-spanning-tree customer-edge priority <0-240>
```

Parameters

<code>priority</code>	Specify the port priority.
<code><0-240></code>	Specify the port priority range (a lower priority indicates greater likelihood of the interface becoming a root). The priority values can only be set in increments of 16.

Default

By default, priority is 1

Command Mode

Interface mode

Applicability

This command was introduced before OcnOS version 1.3.

Example

```
#configure terminal
(config)#interface eth1
(config-if)#customer-spanning-tree customer-edge priority 100
```

customer-spanning-tree forward-time

Use this command to set the time (in seconds) after which (if this bridge is the root bridge) each port changes states to learning and forwarding. This value is used by all instances.

Use the `no` form of this command to restore the default value of 15 seconds.

Command Syntax

```
customer-spanning-tree forward-time <4-30>
no customer-spanning-tree forward-time
```

Parameters

<4-30> Specify the forwarding time delay in seconds.

Note: Care should be exercised if the value is set to less than 7 seconds.

Default

By default, priority is 15 seconds

Command Mode

Interface mode

Applicability

This command was introduced before OcnOS version 1.3.

Examples

```
#configure terminal
(config)#interface eth1
(config-if)#customer-spanning-tree forward-time 6

(config-if)#no customer-spanning-tree forward-time
```

customer-spanning-tree hello-time

Use this command to set the hello-time, the time in seconds after which (if this bridge is the root bridge) all the bridges in a bridged LAN exchange Bridge Protocol Data Units (BPDUs). Avoid a very low value of this parameter as this can lead to excessive traffic on the network; a higher value delays the detection of topology change. This value is used by all instances.

Use the `no` option with this command to restore the default value of the hello-time.

Command Syntax

```
customer-spanning-tree hello-time <1-10>
no customer-spanning-tree hello-time
```

Parameters

<1-10> Specify the hello BPDU interval in seconds.

Default

By default, level is 2 seconds

Command Mode

Interface mode

Applicability

This command was introduced before OcnOS version 1.3.

Examples

```
#configure terminal
(config)#interface eth1
(config-if)#customer-spanning-tree hello-time 3

(config-if)#no customer-spanning-tree hello-time
```

customer-spanning-tree max-age

Use this command to set the max-age for a bridge.

Max-age is the maximum time in seconds for which (if a bridge is the root bridge) a message is considered valid. This prevents the frames from looping indefinitely. The value of max-age should be greater than twice the value of hello-time plus one, but less than twice the value of forward delay minus one. The allowable range for max-age is 6-40 seconds. Configure this value sufficiently high, so that a frame generated by a root can be propagated to the leaf nodes without exceeding the max-age.

Use the `no` parameter with this command to restore the default value of max-age.

Command Syntax

```
customer-spanning-tree max-age <6-40>
no customer-spanning-tree max-age
```

Parameters

<6-40> Specify the maximum time in seconds to listen for the root bridge.

Default

By default, bridge max-age is 20 seconds

Command Mode

Interface mode

Applicability

This command was introduced before OcnOS version 1.3.

Examples

```
#configure terminal
(config)#interface eth1
(config-if)#customer-spanning-tree max-age 12

(config-if)#no customer-spanning-tree max-age
```

customer-spanning-tree priority

Use this command to set the bridge priority for the spanning tree on a customer edge port. Using a lower priority indicates a greater likelihood of the bridge becoming root. This command must be used to set the priority of the customer spanning tree running on the customer edge port.

Use the `no` form of the command to reset it to the default value.

Command Syntax

```
customer-spanning-tree priority <0-61440>
no customer-spanning-tree priority
```

Parameters

<0-61440> Specify the bridge priority in the range <0-61440>. Priority values can be set only in increments of 4096.

Default

By default, priority is 61440

Command Mode

Interface mode

Applicability

This command was introduced before OcnOS version 1.3.

Examples

```
#configure terminal
(config)#interface eth1
(config-if)#customer-spanning-tree priority 4096

(config-if)#no customer-spanning-tree priority
```

customer-spanning-tree provider-edge path-cost

Use this command to set the cost of a path associated with a provider edge port on a customer edge spanning tree.

Use the `no` form of this command to remove the cost of a path associated with a provider edge port on a customer edge spanning tree.

Command Syntax

```
customer-spanning-tree provider-edge svlan <1-4094> path-cost <1-200000000>
no customer-spanning-tree provider-edge svlan <1-4094> path-cost
```

Parameters

<1-4094> Specify the SVLAN identifier of provider edge port.
<1-200000000> Specify the cost to be assigned to the group.

Default

Assuming a 10 Mb/s link speed, the default value is 200,000

Command Mode

Interface mode

Applicability

This command was introduced before OcnOS version 1.3.

Examples

```
#configure terminal
(config)#interface eth1
(config-if)#customer-spanning-tree provider-edge svlan 2 path-cost 1000

(config-if)#no customer-spanning-tree provider-edge svlan 2 path-cost
```

customer-spanning-tree provider-edge priority

Use this command to set the port priority for a provider-edge port in the customer spanning tree.

Command Syntax

```
customer-spanning-tree provider-edge svlan <1-4094> priority <0-240>
```

Parameters

<1-4094>	Specify the SVLAN identifier of provider edge port.
<0-240>	Specify the port priority (a lower priority means greater likelihood of the interface becoming root). The priority values can only be set in increments of 16.

Default

By default, priority is 1

Command Mode

Interface mode

Applicability

This command was introduced before OcnOS version 1.3.

Example

```
#configure terminal
(config)#interface eth1
(config-if)#customer-spanning-tree provider-edge svlan 2 priority 0
```

customer-spanning-tree transmit-holdcount

Use this command to set the transmit-holdcount for a bridge.

Use the `no` parameter with this command to restore the default value of `transmit-holdcount`.

Command Syntax

```
customer-spanning-tree transmit-holdcount <1-10>
no customer-spanning-tree transmit-holdcount
```

Parameters

<1-10> Specify the maximum number that can be transmitted per second.

Default

By default, bridge transmit hold count is 6

Command Mode

Interface mode

Applicability

This command was introduced before OcnOS version 1.3.

Examples

```
#configure terminal
(config)#interface eth1
(config-if)#customer-spanning-tree transmit-holdcount 3

(config-if)#no customer-spanning-tree transmit-holdcount
```

debug mstp

Use this command to turn on, and turn off, debugging and echoing data to the console, at various levels.

Note: This command enables MSTP, RSTP, and STP debugging.

Use the `no` parameter with this command to turn off debugging.

Command Syntax

```
debug mstp all
debug mstp cli
debug mstp packet rx
debug mstp packet tx
debug mstp protocol
debug mstp protocol detail
debug mstp timer
debug mstp timer detail
no debug mstp all
no debug mstp cli
no debug mstp packet rx
no debug mstp packet tx
no debug mstp protocol
no debug mstp protocol detail
no debug mstp timer
no debug mstp timer detail
```

Parameters

<code>all</code>	Echoes all spanning-tree debugging levels to the console.
<code>cli</code>	Echoes spanning-tree commands to the console.
<code>packet</code>	Echoes spanning-tree packets to the console.
<code>rx</code>	Received packets.
<code>tx</code>	Transmitted packets.
<code>protocol</code>	Echoes protocol changes to the console.
<code>detail</code>	Detailed output.
<code>timer</code>	Echoes timer start to the console.
<code>detail</code>	Detailed output.

Command Mode

Exec, Privileged Exec, and Configure modes

Applicability

This command was introduced before OcNOS version 1.3.

Examples

```
#configure terminal
(config)#debug mstp all
(config)#debug mstp cli
(config)#debug mstp packet rx
(config)#debug mstp protocol detail
(config)#debug mstp timer
```

show debugging mstp

Use this command to display the status of debugging of the MSTP system.

Command Syntax

```
show debugging mstp
```

Parameters

None

Command Mode

Exec mode and Privileged Exec mode

Applicability

This command was introduced before OcNOS version 1.3.

Examples

```
#show debugging mstp
MSTP debugging status:
MSTP debugging status:
MSTP timer debugging is on
MSTP protocol debugging is on
MSTP detailed protocol debugging is on
MSTP cli echo debugging is on
MSTP transmitting packet debugging is on
MSTP receiving packet debugging is on
#
```

show spanning-tree

Use this command to show the state of the spanning tree for all STP or RSTP bridge-groups, including named interface and VLANs.

Command Syntax

```
show spanning-tree
show spanning-tree interface IFNAME
show spanning-tree mst
show spanning-tree mst config
show spanning-tree mst interface IFNAME
show spanning-tree mst detail
show spanning-tree mst detail interface IFNAME
show spanning-tree mst instance (<1-63>) interface IFNAME
show spanning-tree mst instance (<1-63> | te-msti)
show spanning-tree statistics bridge <1-32>
show spanning-tree statistics interface IFNAME (instance (<1-63>)| vlan <2-4094>)
  bridge <1-32>
show spanning-tree statistics (interface IFNAME | (instance (<1-63>) | vlan <1-
  4094>)) bridge <1-32>
show spanning-tree vlan range-index
```

Parameters

interface	Display interface information
mst	Display MST information
statistics	Display statistics of the BPDUs
vlan range-index	Display a VLAN range-index value
config	Display configuration information
detail	Display detailed information
instance	Display instance information
<1-63>	Specify the instance identifier
te-msti	Display Traffic Engineering MSTI instance
<1-32>	Specify the bridge identifier
IFNAME	Display the interface name
<2-4094>	Specify a VLAN identifier, associated with the instance

Command Mode

Exec mode and Privileged Exec mode

Applicability

This command was introduced before OcnOS version 1.3.

Example

The following is a sample output of this command displaying spanning tree information.

```
#show spanning-tree
% 1: Bridge up - Spanning Tree Enabled
% 1: Root Path Cost 0 - Root Port 0 - Bridge Priority 32768
% 1: Forward Delay 15 - Hello Time 2 - Max Age 20
% 1: Root Id 80000002b328530a
% 1: Bridge Id 80000002b328530a
% 1: last topology change Wed Nov 19 22:39:18 2008
% 1: 11 topology change(s) - last topology change Wed Nov 19 22:39:18 2008
% 1: portfast bpdu-filter disabled
% 1: portfast bpdu-guard disabled
% 1: portfast errdisable timeout disabled
% 1: portfast errdisable timeout interval 300 sec
%eth2: Ifindex 5 - Port Id 8005 - Role Designated - State Forwarding
%eth2: Designated Path Cost 0
%eth2: Configured Path Cost 200000 - Add type Explicit ref count 1
%eth2: Designated Port Id 8005 - Priority 128 -
%eth2: Root 80000002b328530a
%eth2: Designated Bridge 80000002b328530a
%eth2: Message Age 0 - Max Age 20
%eth2: Hello Time 2 - Forward Delay 15
%eth2: Forward Timer 0 - Msg Age Timer 0 - Hello Timer 1 - topo change timer 0
%eth2: forward-transitions 4
%eth2: Version Rapid Spanning Tree Protocol - Received RSTP - Send RSTP
%eth2: No portfast configured - Current portfast off
%eth2: portfast bpdu-guard default - Current portfast bpdu-guard off
%eth2: portfast bpdu-filter default - Current portfast bpdu-filter off
%eth2: no root guard configured- Current root guard off
%eth2: Configured Link Type point-to-point - Current point-to-point
%eth1: Ifindex 4 - Port Id 8004 - Role Designated - State Forwarding
%eth1: Designated Path Cost 0
%eth1: Configured Path Cost 200000 - Add type Explicit ref count 1
%eth1: Designated Port Id 8004 - Priority 128 -
%eth1: Root 80000002b328530a
%eth1: Designated Bridge 80000002b328530a
%eth1: Message Age 0 - Max Age 20
%eth1: Hello Time 2 - Forward Delay 15
%eth1: Forward Timer 0 - Msg Age Timer 0 - Hello Timer 1 - topo change timer 0
%eth1: forward-transitions 4
%eth1: Version Rapid Spanning Tree Protocol - Received None - Send RSTP
%eth1: No portfast configured - Current portfast off
%eth1: portfast bpdu-guard default - Current portfast bpdu-guard off
%eth1: portfast bpdu-filter default - Current portfast bpdu-filter off
%eth1: no root guard configured- Current root guard off
%eth1: Configured Link Type point-to-point - Current point-to-point
%
%
```

The following is a sample output of this command displaying the state of the spanning tree for interface eth1.

```
#show spanning-tree interface eth1
```

```

% 1: Bridge up - Spanning Tree Enabled
% 1: Root Path Cost 0 - Root Port 0 - Bridge Priority 32768
% 1: Forward Delay 15 - Hello Time 2 - Max Age 20
% 1: Root Id 80000002b328530a
% 1: Bridge Id 80000002b328530a
% 1: last topology change Wed Nov 19 22:39:18 2008
% 1: ll topology change(s) - last topology change Wed Nov 19 22:39:18 2008
% 1: portfast bpdu-filter disabled
% 1: portfast bpdu-guard disabled
% 1: portfast errdisable timeout disabled
% 1: portfast errdisable timeout interval 300 sec
% eth1: Ifindex 4 - Port Id 8004 - Role Designated - State Forwarding
% eth1: Designated Path Cost 0
% eth1: Configured Path Cost 200000 - Add type Explicit ref count 1
% eth1: Designated Port Id 8004 - Priority 128 -
% eth1: Root 80000002b328530a
% eth1: Designated Bridge 80000002b328530a
% eth1: Message Age 0 - Max Age 20
% eth1: Hello Time 2 - Forward Delay 15
% eth1: forward-transitions 4
% eth1: Version Rapid Spanning Tree Protocol - Received None - Send RSTP
% eth1: No portfast configured - Current portfast off
% eth1: portfast bpdu-guard default - Current portfast bpdu-guard off
% eth1: portfast bpdu-filter default - Current portfast bpdu-filter off
% eth1: no root guard configured- Current root guard off

```

Table 4-13 Explains the show command output fields.

Table 4-13: show spanning-tree interface output fields

Field	Description
Bridge up	A network bridge is a computer networking device that creates a single aggregate network from multiple communication networks or network segments.
Root Path Cost	Root cost for the interface.
Root Port	Interface that is the current elected root port for this bridge.
Bridge Priority	Used for the common instance.
Forward Delay	Configured time an STP bridge port remains in the listening and learning states before transitioning to the forwarding state.
Hello Time	Configured number of seconds between transmissions of configuration BPDUs.
Max Age	Maximum age of received protocol BPDUs.
Port Id	Logical interface identifier configured to participate in the MSTP instance.
Role Designated	Designated role for the packets in the interface.
State Forwarding	State of the forwarding packets in the interface.
Designated Path Cost	Designated cost for the interface.

Field	Description
Configured Path Cost	Configured cost for the interface.
Designated Port Id	Port ID of the designated port for the LAN segment this interface is attached to.
Priority	Specify the port priority.
Message Age	Number of seconds elapsed since the most recent BPDU was received.
Forward Timer	The forward delay timer is the time interval that is spent in the listening and learning state.
Msg Age Timer	The message age contains the length of time that has passed since the root bridge initially originated the BPDU.
Received RSTP	Number of times the received the RSTP.
Send RSTP	Number of times transmitted the RSTP.

show spanning-tree mst

Use this command to display the filtering database values. This command displays the number of instances created, and VLANs associated with it.

Command Syntax

```
show spanning-tree mst
show spanning-tree mst config
show spanning-tree mst detail
show spanning-tree mst detail interface IFNAME
show spanning-tree mst instance (<1-63>) interface IFNAME
show spanning-tree mst instance (<1-63> | te-msti)
show spanning-tree mst interface IFNAME
```

Parameters

config	Display configuration information.
detail	Display detailed information.
interface	Display interface information.
instance	Display instance information.
<1-63>	Specify the instance identifier.
te-msti	Traffic Engineering MSTI instance.

Command Mode

Exec mode and Privileged Exec mode

Applicability

This command was introduced before OcNOS version 1.3.

Examples

```
#show spanning-tree mst
% 1: Bridge up - Spanning Tree Enabled
% 1: CIST Root Path Cost 0 - CIST Root Port 0 - CIST Bridge
Priority 32768
% 1: Forward Delay 15 - Hello Time 2 - Max Age 20 - Max-hops 20
% 1: CIST Root Id 80000002b328530a
% 1: CIST Reg Root Id 80000002b328530a
% 1: CIST Bridge Id 80000002b328530a
% 1: 2 topology change(s) - last topology change Wed Nov 19 22:43:21 2008
% 1: portfast bpdu-filter disabled
% 1: portfast bpdu-guard disabled
% 1: portfast errdisable timeout disabled
% 1: portfast errdisable timeout interval 300 sec%
% Instance VLAN
% 0:      1
% 2:      3-4
```

[Table 4-14](#) Explains the show command output fields.

Table 4-14: show spanning-tree mst output fields

Field	Description
Bridge up	A network bridge is networking process that creates a single aggregate network from multiple communication networks or network segments.
CIST Root Path Cost	Calculated cost to reach the regional root bridge from the bridge where the command is entered.
CIST Root Port	Interface that is the current elected CIST root port for this bridge.
CIST Bridge	A CIST bridge is networking process that creates a single aggregate network from multiple communication networks.
Priority	Specify the port priority.
Forward Delay	Configured time an STP bridge port remains in the listening and learning states before transitioning to the forwarding state.
Hello Time	Configured number of seconds between transmissions of configuration BPDUs.
Max Age	Maximum age of received protocol BPDUs.
Max-hops	Configured maximum number of hops a BPDU can be forwarded in the MSTP region.

show spanning-tree statistics

Use this command to display detailed BPDU statistics for a spanning tree instance.

Command Syntax

```
show spanning-tree statistics bridge <1-32>
show spanning-tree statistics interface IFNAME (instance (<1-63>)| vlan <2-4094>)
  bridge <1-32>
show spanning-tree statistics (interface IFNAME | (instance (<1-63>) | vlan <1-
  4094>)) bridge <1-32>
```

Parameters

<1-32>	Bridge identifier.
<1-63>	MST instance identifier.
IFNAME	Displays the interface name.
<2-4094>	Specify a VLAN identifier, associated with the instance.

Command Mode

Exec mode and Privileged Exec mode

Applicability

This command was introduced before OcNOS version 1.3.

Example

In the following example, bridge-group 1 is configured for IEEE on the eth2 interface.

```
#show spanning-tree statistics interface eth2 bridge 1

      Port number = 4 Interface = eth2
      =====
% BPDU Related Parameters
% -----
% Port Spanning Tree           : Enable
% Spanning Tree Type           : Spanning Tree Protocol
% Current Port State           : Forwarding
% Port ID                       : 8004
% Port Number                   : 4
% Path Cost                     : 19
% Message Age                   : 0
% Designated Root               : 80:00:52:54:00:b2:49:c1
% Designated Cost               : 0
% Designated Bridge            : 80:00:52:54:00:b2:49:c1
% Designated Port Id           : 0x8004
% Top Change Ack                : FALSE
% Config Pending                : FALSE

% PORT Based Information & Statistics
```

```

% -----
% Config Bpdu's xmitted           : 54327
% Config Bpdu's received         : 0
% TCN Bpdu's xmitted             : 50
% TCN Bpdu's received           : 3
% Forward Trans Count            : 1

% STATUS of Port Timers
% -----
% Hello Time Configured          : 2
% Hello timer                    : ACTIVE
% Hello Time Value               : 0
% Forward Delay Timer            : INACTIVE
% Forward Delay Timer Value      : 0
% Message Age Timer              : INACTIVE
% Message Age Timer Value        : 0
% Topology Change Timer          : INACTIVE
% Topology Change Timer Value    : 0
% Hold Timer                     : INACTIVE
% Hold Timer Value               : 0

% Other Port-Specific Info
% -----
% Max Age Transitions            : 1
% Msg Age Expiry                 : 0
% Similar BPDUS Rcvd            : 0
% Src Mac Count                  : 0
% Total Src Mac Rcvd            : 3
% Next State                     : Discard/Blocking
% Topology Change Time           : 0

% Other Bridge information & Statistics
% -----
% STP Multicast Address          : 01:80:c2:00:00:00
% Bridge Priority                 : 32768
% Bridge Mac Address             : 80:00:52:54:00:b2
% Bridge Hello Time              : 2
% Bridge Forward Delay           : 15
% Topology Change Initiator      : 5
% Last Topology Change Occured   : Wed Feb 17 09:39:58 2021
% Topology Change                : FALSE
% Topology Change Detected       : FALSE
% Topology Change Count          : 5
% Topology Change Last Recvd from : 00:00:00:00:00:00

```

[Table 4-15](#) Explains the show command output fields.

Table 4-15: show spanning-tree statistics output fields

Field	Description
BPDU Related Parameters	Details of the BPDU related parameters.
PORT Based Information & Statistics	Information of the port and interface for which the statistics are being displayed.
STATUS of Port Timers	Status of the port timers.
Other Port-Specific Info	Specific information about the port.
Other Bridge information & Statistics	Information about bridge and statistics being displayed.

spanning-tree autoedge

Use this command to assist in automatic identification of the edge port.

Use the `no` parameter with this command to disable this feature.

Command Syntax

```
spanning-tree autoedge
no spanning-tree autoedge
```

Default

By default, spanning-tree autoedge is disabled

Parameters

None

Command Mode

Interface mode

Applicability

This command was introduced before OcNOS version 1.3.

Example

```
#configure terminal
(config)#interface eth0
(config-if)#spanning-tree autoedge
```

spanning-tree edgeport

Use this command to set a port as an edge-port and to enable rapid transitions.

Use the `no` parameter with this command to set a port to its default state (not an edge-port) and to disable rapid transitions.

Note: This command is an alias to the `spanning-tree portfast` command. Both commands can be used interchangeably.

Command Syntax

```
spanning-tree edgeport
no spanning-tree edgeport
```

Default

By default, spanning-tree edgeport is disabled

Parameters

None

Command Mode

Interface mode

Applicability

This command was introduced before OcNOS version 1.3.

Example

```
#configure terminal
(config)#interface eth0
(config-if)#spanning-tree edgeport
```

spanning-tree guard

Use this command to enable the root guard feature for the port. This feature disables reception of superior BPDUs.

The root guard feature makes sure that the port on which it is enabled is a designated port. If the root guard enabled port receives a superior BPDU, it goes to a Listening state (for STP) or discarding state (for RSTP and MSTP).

Use the `no` parameter with this command to disable the root guard feature for the port.

Command Syntax

```
spanning-tree guard root
no spanning-tree guard root
```

Parameters

<code>root</code>	Set to disable reception of superior BPDUs
-------------------	--

Default

By default, `spanning-tree guard root` is enabled

Command Mode

Interface mode

Applicability

This command was introduced before OcnOS version 1.3.

Example

```
#configure terminal
(config)#interface eth0
(config-if)#spanning-tree guard root
```

spanning-tree instance restricted-role

Use this command to set the restricted role value for the instance to TRUE.

Use the `no` parameter with this command to set the restricted role value for the instance to FALSE.

Command Syntax

```
spanning-tree instance <1-63> restricted-role
no spanning-tree instance <1-63> restricted-role
```

Parameters

<1-63> Specify the instance ID range.

Default

By default, restricted-role value is FALSE

Command Mode

Interface mode

Applicability

This command was introduced before OcnOS version 1.3.

Example

```
#configure terminal
(config)#interface eth0
(config-if)#spanning-tree instance 2 restricted-role
```

spanning-tree instance restricted-tcn

Use this command to set the restricted TCN value for the instance to TRUE.

Command Syntax

```
spanning-tree instance <1-63> restricted-tcn
no spanning-tree instance <1-63> restricted
```

Parameters

<1-63> Specify the instance ID range.

Default

By default, restricted TCN value is FALSE

Command Mode

Interface mode

Applicability

This command was introduced before OcnOS version 1.3.

Example

```
#configure terminal
(config)#interface eth0
(config-if)#spanning-tree instance 2 restricted-tcn
```

spanning-tree link-type

Use this command to enable or disable point-to-point or shared link types.

RSTP has a backward-compatible STP mode, `spanning-tree link-type shared`. An alternative is the `spanning-tree force-version 0`.

Use the `no` parameter with this command to disable rapid transition.

Command Syntax

```
spanning-tree link-type auto
spanning-tree link-type point-to-point
spanning-tree link-type shared
no spanning-tree link-type
```

Parameters

<code>auto</code>	Sets to either point-to-point or shared based on duplex state.
<code>point-to-point</code>	Enables rapid transition.
<code>shared</code>	Disables rapid transition.

Default

By default, `spanning-tree link-type` is enabled.

Command Mode

Interface mode

Applicability

This command was introduced before OcNOS version 1.3.

Examples

```
#configure terminal
(config)#interface eth0
(config-if)#spanning-tree link-type point-to-point

(config-if)#no spanning-tree link-type
```

spanning-tree mst configuration

Use this command to enter the Multiple Spanning Tree Configuration mode.

Command Syntax

```
spanning-tree mst configuration
```

Parameters

None

Default

No default value is specified.

Command Mode

Configure mode

Applicability

This command was introduced before OcNOS version 1.3.

Examples

```
#configure terminal  
(config)#spanning-tree mst configuration  
(config-mst)#
```

spanning-tree bpdu-filter

Use this command to set the BPDU filter value for individual ports. When the `enable` or `disable` parameter is used with this command, this configuration takes precedence over bridge configuration. However, when the `default` parameter is used with this command, the bridge level BPDU filter configuration takes effect for the port.

Use the `show spanning tree` command to display administratively configured and currently running values of the BPDU filter parameter for the bridge and port (see [show spanning-tree](#)).

Use the `no` parameter with this command to revert the port BPDU filter value to default.

Command Syntax

```
spanning-tree bpdu-filter (enable|disable|default)
no spanning-tree bpdu-filter
```

Parameters

<code>default</code>	Sets the bpdu-filter to the default level.
<code>disable</code>	Disables the BPDU-filter.
<code>enable</code>	Enables the BPDU-filter.

Default

By default, `spanning-tree bpdu-filter` is default option

Command Mode

Interface mode

Applicability

This command was introduced before OcnOS version 1.3.

Example

```
#configure terminal
(config)#interface eth0
(config-if)#spanning-tree bpdu-filter enable

(config-if)#no spanning-tree bpdu-filter
```

spanning-tree bpdu-guard

Use this command to enable or disable the BPDU Guard feature on a port.

This command supersedes the bridge level configuration for the BPDU Guard feature. When the `enable` or `disable` parameter is used with this command, this configuration takes precedence over bridge configuration. However, when the `default` parameter is used with this command, the bridge-level BPDU Guard configuration takes effect.

Use the `show spanning tree` command to display administratively configured and currently running values of the BPDU filter parameter for the bridge and port (see [show spanning-tree](#)).

Use the `no` parameter with this command to set the BPDU Guard feature on a port to default.

Command Syntax

```
spanning-tree bpdu-guard (enable|disable|default)
no spanning-tree bpdu-guard
```

Parameters

<code>default</code>	Sets the BPDU-guard to the default level.
<code>disable</code>	Disables the BPDU-guard.
<code>enable</code>	Enables the BPDU-guard.

Default

By default, `spanning-tree bpdu-guard` is default

Command Mode

Interface mode

Applicability

This command was introduced before OcnOS version 1.3.

Example

```
#configure terminal
(config)#interface eth0
(config-if)#spanning-tree bpdu-guard enable

(config-if)#no spanning-tree bpdu-guard
```

spanning-tree restricted-domain-role

Use this command to set the restricted-domain-role value of the port to TRUE.

Use the `no` parameter with this command to set the restricted-domain-role value of the port to FALSE.

Command Syntax

```
spanning-tree restricted-domain-role
no spanning-tree restricted-domain-role
```

Parameters

None

Default

By default, restricted-role value is FALSE

Command Mode

Interface mode

Applicability

This command was introduced before OcNOS version 1.3.

Example

```
#configure terminal
(config)#interface eth0
(config-if)#spanning-tree restricted-domain-role
```

spanning-tree restricted-role

Use this command to set the restricted-role value of the port to TRUE.

Use the `no` parameter with this command to set the restricted-role value of the port to FALSE.

Command Syntax

```
spanning-tree restricted-role
no spanning-tree restricted-role
```

Parameters

None

Default

By default, restricted-role value is FALSE

Command Mode

Interface mode

Applicability

This command was introduced before OcnOS version 1.3.

Example

```
#configure terminal
(config)#interface eth0
(config-if)#spanning-tree restricted-role
```

spanning-tree restricted-tcn

Use this command to set the restricted TCN value of the port to TRUE.

Use the `no` parameter with this command to set the restricted TCN value of the port to FALSE.

Command Syntax

```
spanning-tree restricted-tcn
no spanning-tree restricted-tcn
```

Parameters

None

Default

By default, restricted TCN value is FALSE

Command Mode

Interface mode

Applicability

This command was introduced before OcnOS version 1.3.

Example

```
#configure terminal
(config)#interface eth0
(config-if)#spanning-tree restricted-tcn
```

spanning-tree te-msti configuration

This command is used to put the terminal into the `te-msti` configuration mode.

After creating a bridge instance and adding VLAN to that bridge instance, use this command to enter `te-msti` configuration mode.

Command Syntax

```
spanning-tree te-msti configuration
```

Parameters

None

Default

No default value is specified

Command Mode

Configure mode

Applicability

This command was introduced before OcNOS version 1.3.

Examples

```
#configure terminal
(config)#spanning-tree te-msti configuration
(config-te-msti)#
```

storm-control

Use this command to set the rising threshold level for broadcast, multicast, or destination lookup failure traffic. The storm control action occurs when traffic utilization reaches this level.

Storm control is used to block the forwarding of unnecessary flooded traffic. A packet storm occurs when a large number of broadcast packets are received on a port. Forwarding these packets can cause the network to slow down or time out.

Use the `no` form of this command to disable storm control.

Note: Minimum granularity for storm-control is 64kbps.

Command Syntax

```
storm-control (broadcast|multicast|dlf) (level LEVEL | <0-1000000000>
(kbps|mbps|gbps))
no storm-control (broadcast|multicast|dlf)
```

Parameters

<code>broadcast</code>	Broadcast rate limiting.
<code>multicast</code>	Multicast rate limiting.
<code>dlf</code>	Destination lookup failure limiting.
<code>level</code>	Sets the percentage of the threshold.
LEVEL	The percentage of the threshold; percentage of the maximum speed (pps) of the interface <0.0000-99.0000>.
<0-1000000000>	Sets absolute threshold value <0-1000000000>
kbps	specifies the units of Kilobits per second.
mbps	specifies the units of Megabits per second.
gbps	specifies the units of Gigabits per second.

Default

By default, storm control is disabled

Command Mode

Interface mode

Applicability

This command was introduced before OcnOS version 1.3.

Examples

```
#configure terminal
(config)#interface eth0
(config-if)#storm-control broadcast level 30

(config)#interface eth0
(config-if)#storm-control multicast level 30

(config)#interface eth0
```

```
(config-if)#storm-control multicast 300 mbps
```

```
(config)#interface eth0
```

```
(config-if)#no storm-control multicast
```

CHAPTER 5 Link Aggregation Commands

This chapter describes link aggregation commands.

- `channel-group mode`
- `clear lacp`
- `debug lacp`
- `interface po`
- `interface sa`
- `lacp destination-mac`
- `lacp force-up`
- `lacp port-priority`
- `lacp system-priority`
- `lacp timeout`
- `port-channel min-links`
- `port-channel weight`
- `show debugging lacp`
- `show etherchannel`
- `show lacp sys-id`
- `show lacp-counter`
- `show port etherchannel`
- `show static-channel-group`
- `show static-channel load-balance`
- `snmp restart lacp`
- `static-channel-group`

channel-group mode

Use this command to add an interface to an existing link aggregation group.

After you execute this command, the interface loses its properties and takes the properties of the aggregated interface.

Use the `no` parameter with this command to remove an interface from a dynamic link aggregation group. When you remove an interface from a LAG, the interface acquires the default interface properties.

Command Syntax

```
channel-group <1-16383> mode (active|passive)
no channel-group
```

Parameters

<1-16383>	Specify a channel group number (with DRNI).
mode	Specify a channel mode.
active	Enable LACP negotiation.
passive	Disable LACP negotiation.

Command Mode

Interface mode

Applicability

This command was introduced before OcNOS version 1.3.

Examples

```
#configure terminal
(config)#interface xe1
(config-if)#switchport
(config-if)#channel-group 1 mode active
(config-if)#exit

#sh run in po1
!
interface po1
switchport
```

The is an example of `no channel-group`:

```
#configure terminal
(config)#interface xe1
(config-if)#switchport
(config-if)#no channel-group
(config-if)#exit

#sh run in xe1
!
interface xe1 switchport
!
#sh run in po1
!
```

```
interface po1  
  switchport
```

```
!
```

clear lacp

Use this command to clear the counters of all LACP aggregators or a given LACP aggregator.

Command Syntax

```
clear lacp <1-16383> counters
clear lacp counters
```

Parameters

<1-16383> Clears a channel-group number.

Command Mode

Exec mode and Privileged Exec mode

Applicability

This command was introduced before OcnOS version 1.3.

Example

```
#clear lacp 2 counters
```

debug lacp

Use this command to enable LACP debugging.

Use the `no` parameter with this command to disable debugging.

Command Syntax

```
debug lacp (event|cli|timer|packet|sync|ha|all|rx|tx)
no debug lacp (event|cli|timer|packet|sync|ha|allrx|tx)
```

Parameters

<code>all</code>	Enables all LACP debugging.
<code>cli</code>	Echo commands to console.
<code>event</code>	Sets the debug options for LACP events.
<code>ha</code>	Echo High availability events to console.
<code>packet</code>	Sets the debug option for LACP packets.
<code>sync</code>	Echo synchronization to console.
<code>timer</code>	Echo timer expiry to console.
<code>rx</code>	Echo receiving of lacpdus to console.
<code>tx</code>	Echo transmission of lacpdus to console.

Command Mode

Exec mode and Privileged Exec mode

Applicability

This command was introduced before OcNOS version 1.3.

Example

```
#debug lacp all
```

interface po

Use this command to create a dummy dynamic link aggregate interface (by default an L3 LAG interface).

Use the `no` form of this command to remove a dynamic link aggregate group and also it remove the properties of the `po` from all member ports.

Note: Switchport/routed mode needs to be set for the PO before adding member ports to it.

Command Syntax

```
interface po<1-16383>
no interface po<1-16383>
```

Parameters

<1-16383> Channel group number.

Default

By default, interface `po` is L3 LAG interface

Command Mode

Configuration mode

Applicability

This command was introduced before OcnOS version 1.3.

Example

```
#configure terminal
(config)#interface po1
(config-if)#switchport
(config-if)#exit
```

interface sa

Use this command to create a dummy static link aggregate interface (by default an L3 LAG interface) and to add an interface to an existing static link aggregation group.

Use the `no` form of this command to remove a static link aggregate group and also remove the properties of the ports from all member ports.

Command Syntax

```
interface sa<1-16383>
no interface sa<1-16383>
```

Parameters

<1-16383> Channel group number.

Default

By default, interface sa is L3 LAG interface

Command Mode

Configuration mode

Applicability

This command was introduced before OcnOS version 1.3.

Example

```
#configure terminal
(config)#interface sa1
(config-if)#switchport
(config-if)#exit
```

lacp destination-mac

Use this command to set the address type to use for sending LACPDU (Link Aggregation Control Protocol Data Units).

Note: The interface must be an aggregation port.

Use the `no` form of this command to set the address type to its default (multicast group address).

Command Syntax

```
lacp destination-mac (customer-bridge-group-address | multicast-group-address |
non-tmpr-group-address)
no lacp destination-mac
```

Parameters

```
customer-bridge-group-address
    Customer bridge group address
multicast-group-address
    Multicast group address (default)
non-TPMR-group-address
    Non-Two-Port Media Access Control Relay (TPMR) group address
```

Default

By default, `lacp destination-mac` is `multicast-group-address`

Command Mode

Interface mode

Applicability

This command was introduced before OcNOS version 1.3.

Example

```
#config terminal
(config)#interface eth1
(config-if)#lacp destination-mac customer-bridge-group-address
```

lacp force-up

Use this command to make a port immediately begin forwarding packets and not wait for an LACPDU. After you execute this command, the member port is forcefully up even if LACP is not in sync (only if no other member in the aggregator is in sync).

If a force-up port stops receiving LACPDUs, the port ignores the time-out and remains in operation.

This command can be configured on one member interface of a port channel.

Note: This command can only be given after executing the [channel-group mode](#) command on an interface. Force-up mode is not supported for LACP passive mode.

Note: For MLAG, only configure a force-up port on either on the master node or the slave node to prevent traffic drops/loops.

Use the `no` form of this command to disable force-up mode.

Command Syntax:

```
lacp force-up
no lacp force-up
```

Parameters

None

Default

By default, LACP force-up mode is disabled.

Command Mode

Interface mode

Applicability

This command was introduced in OcNOS version 1.3.6.

Example

```
#configure terminal
(config)#interface xe1
(config-if)#switchport
(config-if)#channel-group 1 mode active
(config-if)#lacp force-up
(config-if)#exit
```

lacp port-priority

Use this command to set the priority of a channel. Channels are selected for aggregation based on their priority with the higher priority (numerically lower) channels selected first.

Use the `no` parameter with this command to set the priority of port to the default value (32768).

Command Syntax

```
lacp port-priority <1-65535>
no lacp port-priority
```

Parameters

<1-65535> Specify the LACP port priority.

Default

By default, lacp port priority is 32768

Command Mode

Interface mode

Applicability

This command was introduced before OcNOS version 1.3.

Example

```
#configure terminal
(config)#interface eth0
(config-if)#lacp port-priority 34
```

lacp system-priority

Use this command to set the LACP system priority. This priority determines the system responsible for resolving conflicts in the choice of aggregation groups.

Note: A lower numerical value has a higher priority.

Use the `no` parameter with this command to set the system priority to its default value (32768).

Command Syntax

```
lacp system-priority <1-65535>
no lacp system-priority
```

Parameters

<1-65535> System priority.

Default

By default, system priority is 32768

Command Mode

Configure mode

Applicability

This command was introduced before OcnOS version 1.3.

Example

```
#configure terminal
(config)#lacp system-priority 6700
```

lacp timeout

Use this command to set either a short or long timeout value on a port. The timeout value is the number of seconds before invalidating a received LACP data unit (DU).

Command Syntax

```
lacp timeout (short|long)
```

Parameters

short LACP short timeout. 3 seconds.

long LACP long timeout. 90 seconds.

Note: Short: With this mode, BPDU will be sent at Fast_Periodic_Time of 1 second interval. It will timeout, before invalidating received LACPDU, after 3xFast_Periodic_Time(3seconds),

Long: With this mode, BPDU will be sent at Slow_Periodic_Time of 30 seconds intervals. It will timeout, before invalidating received LACPDU, after 3xSlow_Periodic_Time(90seconds)

Default

By default, lacp timeout is long.

Command Mode

Interface mode

Applicability

This command was introduced before OcnOS version 1.3.

Example

The following sets the LACP short timeout on a port.

```
#configure terminal
(config)#interface eth0
(config-if)#lacp timeout short
```

```
#configure terminal
(config)#interface eth0
(config-if)#lacp timeout long
```

port-channel min-links

Use this command to set the minimum number of aggregated links that need to be up in the LAG interface.

When a the minimum number of links are configured for a LAG, if the active links for that interface become less than the configured value, then the whole LAG is brought down. When the number of active links become the same or more than the configured value, then the whole LAG is restored.

Use the `no` form of this command to remove the minimum number of aggregated links that need to be up in the LAG interface.

Note: The minimum number of aggregated links should be same across both ends of an aggregation interface. If not configured, then on one of the nodes the LAG port will be treated as up and on the other as down and traffic will be discarded.

Note: When a LAG port is moved to the down state because it does not have the minimum number of required links up and running, then the traffic on the remaining interfaces in the LAG will be counted as port-block discards.

Note: While configuring min-links, it is recommended to configure PO (LACP) min-links only on one end of an etherchannel because it is specific to the each actor and triggers fail-over. The fail-over depends on the mux state and lacp timeout.

Command Syntax

```
port-channel min-links <2-32>
no port-channel min-links
```

Parameters

<2-32> Minimum number of links

Default

By default, port channel min-link is disabled

Command Mode

Interface mode

Applicability

This command was introduced before OcNOS version 1.3.

Example

```
#configure terminal
(config)#interface po1
(config-if)#port-channel min-links 10
(config-if)#exit
```

port-channel weight

Use this command to configure weighted load balancing on port-channel member links. As per the weights configured, traffic distribution will be happening across the member interfaces.

Consider if ports xe1 and xe2 associated with the L2 lag, having default load-balance as src-dst-mac and by default, best traffic distribution can happen upto 50% on each link (by varying source and destination macs). After weight configured as 2 on interface xe1, the best traffic distribution can happen as 66.66% and 33.33% on xe1 and xe2 respectively.

Note: Maximum weights configured over member interfaces should not cross the maximum member supported under a LAG as per device capacity.

Command Syntax

```
port-channel weight <1-64>
port-channel weight <1-16>
no port-channel weight
```

Parameters

<1-64>	Load balance weight for the interface for the Qumran1 series platforms.
<1-16>	Load balance weight for the interface for the Qumran2 series platforms.

Default

Disabled

Command Mode

Interface mode

Applicability

This command was introduced in OcNOS version 5.1.

Example

Static lag:

```
#configure terminal
(config)#interface sa1
(config)#exit
(config)#interface xe2
(config-if)#static-channel-group 1
(config-if)#port-channel-weight 2
(config-if)#exit
(config)#Interface xe3
(config-if)#static-channel-group 1
```

Dynamic lag:

```
#configure terminal
(config)#interface po1
```



```
(config)#exit  
(config)#interface xe2  
(config-if)#channel-group 1 mode active  
(config-if)#port-channel-weight 3
```

show debugging lacp

Use this command to display the status of the debugging of the LACP system.

Command Syntax

```
show debugging lacp
```

Parameters

None

Command Mode

Exec and Privileged Exec mode

Applicability

This command was introduced before OcNOS version 1.3.

Example

```
#show debugging lacp
```

```
LACP debugging status:  
LACP timer debugging is on
```

show etherchannel

Use this command to display information about link aggregation groups.

Command Syntax

```
show etherchannel
show etherchannel <1-16383>
```

With MLAG:

```
show etherchannel (<1-16383>|) detail
show etherchannel (<1-16383>|) limit
show etherchannel (<1-16383>|) load-balance
show etherchannel (<1-16383>|) summary
```

Without MLAG:

```
show etherchannel (<1-16383>|) detail
show etherchannel (<1-16383>|) limit
show etherchannel (<1-16383>|) load-balance
show etherchannel (<1-16383>|) summary
```

Parameters

<1-16383>	Specify channel-group number.
detail	Specify detailed etherchannel information.
limit	Specify channel limit.
Max Aggregators	Maximum number of aggregators supported is 128.
Max Ports in Aggregator	Maximum number of ports supported in aggregator 16.
load-balance	Specify load balancing.
summary	Specify Etherchannel summary information.

Command Mode

Exec mode and Privileged Exec mode

Applicability

This command was introduced before OcNOS version 1.3.

Example

```
OcNOS#show etherchannel limit
Max Aggregators           : 256
Max Ports in Aggregator   : 64

OcNOS#show etherchannel summary
% Aggregator po1 185
% Aggregator Type: Layer3
% Admin Key: 0001 - Oper Key 0001
% Link: eth3 (5) sync: 0
```

```

-----
% Aggregator po4 186
% Admin Key: 0004 - Oper Key 0004
% Link: eth2 (4) sync: 0
-----
% Aggregator po5 187
% Admin Key: 0005 - Oper Key 0005
% Link: eth1 (3) sync: 0

OcnOS#show etherchannel detail
% Aggregator po1 185
% Aggregator Type: Layer3
% Mac address: 08:00:27:36:f5:7d
% Admin Key: 0001 - Oper Key 0001
% Actor LAG ID- 0x8000,08-00-27-fa-4b-0e,0x0001
% Receive link count: 0 - Transmit link count: 0
% Individual: 0 - Ready: 0
% Partner LAG ID- 0x0000,00-00-00-00-00-00,0x0000
% Link: eth3 (5) sync: 0
% Collector max delay: 5
-----
% Aggregator po4 186
% Mac address: 08:00:27:76:0c:57
% Admin Key: 0004 - Oper Key 0004
% Actor LAG ID- 0x8000,08-00-27-fa-4b-0e,0x0004
% Receive link count: 0 - Transmit link count: 0
% Individual: 0 - Ready: 1
% Partner LAG ID- 0x0000,00-00-00-00-00-00,0x0000
% Link: eth2 (4) sync: 0
% Collector max delay: 5
-----
% Aggregator po5 187
% Mac address: 08:00:27:2f:d5:ae
% Admin Key: 0005 - Oper Key 0005
% Actor LAG ID- 0x8000,08-00-27-fa-4b-0e,0x0005
% Receive link count: 0 - Transmit link count: 0
% Individual: 0 - Ready: 0
% Partner LAG ID- 0x0000,00-00-00-00-00-00,0x0000
% Link: eth1 (3) sync: 0
% Collector max delay: 5

```

Table 5-16 explains the show command output fields.

Table 5-16: show etherchannel detail output

Field	Description
Aggregator	Link aggregators name and ID number.
Mac address	Unique MAC address for link identification.
Admin Key	LACP administrative key – automatically configured value on each port configured to use LACP.
Oper Key	LACP operator key on Partner – automatically configured value on each port configured to use LACP.

Table 5-16: show etherchannel detail output (Continued)

Field	Description
Actor LAG ID	LAG ID consisting of MAC address plus aggregator ID number for this Actor.
Receive link count	The number of link received from the peer LAG.
Transmit link count	The number of links contained transmitted to the peer LAG.
Individual	The individual physical network interfaces or ports contained in the LAG.
Ready	The number of links in the active state on this Actor.
Partner LAG ID	Partner LAG ID consisting of MAC address plus aggregator ID number.
Link	Interface and ID number of the link.
sync	MAC address synchronization enables a MLAG Partner to forward Layer 3 packets arriving on this interfaces with either its own MAC address or its Partner's.
Collector max delay	Maximum period of wait time between sending of two subsequent Ethernet frames on a link.

show lacp sys-id

Use this command to display the LACP system identifier and priority.

Command Syntax

```
show lacp sys-id
```

Parameters

<code>sys-id</code>	Display LACP system ID and priority
---------------------	-------------------------------------

Command Mode

Exec and Privileged Exec mode

Applicability

This command was introduced before OcnOS version 1.3.

Example

```
#show lacp sys-id
% System 8000,00-0e-0c-83-37-27
```

show lacp-counter

Use this command to display the packet traffic on all ports of all present LACP aggregators, or a given LACP aggregator.

Command Syntax

```
show lacp-counte
show lacp-counter <1-16383>
```

Parameters

<1-16383> Channel-group number

Command Mode

Exec and Privileged Exec mode

Applicability

This command was introduced before OcnOS version 1.3.

Example

```
#show lacp-counter 555
```

Port	LACPDUs		Marker		Pckt err	
	Sent	Recv	Sent	Recv	Sent	Recv

show port etherchannel

Use this command to display details about a PO and its members' interfaces or to display details of a single member interface of a PO.

Command Syntax

```
show port etherchannel IFNAME
```

Parameters

IFNAME	Interface name
--------	----------------

Command Mode

Exec and Privileged Exec mode

Applicability

This command was introduced before OcNOS version 1.3.

Example

```
#show port etherchannel ce29/1
LAG ID                               : 0x8000,cc-37-ab-a0-89-ca,0x0002
Partner oper LAG ID                  : 0x8000,a8-2b-b5-38-1e-48,0x0004
Aggregator ID                         : 100002
  LACP link info                       : ce29/1 - 10001
  Periodic Transmission
  machine state                         : Slow periodic
  Receive machine state                 : Current
  Mux machine state                     : Collecting/Distributing
  Actor Info :
  =====
  Actor Port priority                   : 0x8000 (32768)
  Admin key                             : 0x0002 (2) Oper key: 0x0002 (2)
  Physical admin key                    : (2)
  Actor Oper state                       : ACT:1 TIM:0 AGG:1 SYN:1 COL:1 DIS:1 DEF:0 EXP:0
  Actor Admin state                      : ACT:1 TIM:0 AGG:1 SYN:0 COL:0 DIS:0 DEF:1 EXP:0
  Partner Info:
  =====
  Partner oper port                     : 10009
  Partner link info                      : admin port 0
  Partner admin LAG ID                  : 0x0000-00:00:00:00:0000
  Partner system priority               : admin:0x0000 - oper:0x8000
  Partner port priority                  : admin:0x0000 - oper:0x8000
  Partner oper state                     : ACT:1 TIM:0 AGG:1 SYN:1 COL:1 DIS:1 DEF:0 EXP:0
  Partner admin state                    : ACT:0 TIM:0 AGG:1 SYN:0 COL:0 DIS:0 DEF:1 EXP:0

#show port etherchannel po2
LAG ID                               : 0x8000,cc-37-ab-a0-89-ca,0x0002
Partner oper LAG ID                  : 0x8000,a8-2b-b5-38-1e-48,0x0004
Aggregator ID                         : 100002
  LACP link info                       : ce29/1 - 10001
  Periodic Transmission
  machine state                         : Slow periodic
```



```

Receive machine state      : Current
Mux machine state        : Collecting/Distributing
Actor Info :
=====
Actor Port priority      : 0x8000 (32768)
Admin key                : 0x0002 (2) Oper key: 0x0002 (2)
Physical admin key      : (2)
Actor Oper state        : ACT:1 TIM:0 AGG:1 SYN:1 COL:1 DIS:1 DEF:0 EXP:0
Actor Admin state      : ACT:1 TIM:0 AGG:1 SYN:0 COL:0 DIS:0 DEF:1 EXP:0
Partner Info:
=====
Partner oper port       : 10009
Partner link info      : admin port 0
Partner admin LAG ID   : 0x0000-00:00:00:00:0000
Partner system priority : admin:0x0000 - oper:0x8000
Partner port priority  : admin:0x0000 - oper:0x8000
Partner oper state     : ACT:1 TIM:0 AGG:1 SYN:1 COL:1 DIS:1 DEF:0 EXP:0
Partner admin state    : ACT:0 TIM:0 AGG:1 SYN:0 COL:0 DIS:0 DEF:1 EXP:0

LACP link info         : ce30/1 - 10005
Periodic Transmission  :
machine state          : Slow periodic
Receive machine state  : Current
Mux machine state      : Collecting/Distributing
Actor Info :
=====
Actor Port priority    : 0x8000 (32768)
Admin key              : 0x0002 (2) Oper key: 0x0002 (2)
Physical admin key    : (2)
Actor Oper state      : ACT:1 TIM:0 AGG:1 SYN:1 COL:1 DIS:1 DEF:0 EXP:0
Actor Admin state     : ACT:1 TIM:0 AGG:1 SYN:0 COL:0 DIS:0 DEF:1 EXP:0
Partner Info:
=====
Partner oper port     : 10013
Partner link info    : admin port 0
Partner admin LAG ID : 0x0000-00:00:00:00:0000
Partner system priority : admin:0x0000 - oper:0x8000
Partner port priority : admin:0x0000 - oper:0x8000
Partner oper state   : ACT:1 TIM:0 AGG:1 SYN:1 COL:1 DIS:1 DEF:0 EXP:0
Partner admin state  : ACT:0 TIM:0 AGG:1 SYN:0 COL:0 DIS:0 DEF:1 EXP:0

```

Note: Most of the output of this command is duplicated in the [show etherchannel](#) command (see also the 802.3ad specification). The output of the `show port etherchannel` command is primarily a list of state machine values. An explanation of the state machine bits follows. See [Figure 5-50](#).

[Table 5-17](#) explains the show command output fields.

Table 5-17: show port etherchannel detailed output

Entry	Description
Actor/Partner state	The Actor's and Partner's state variables, encoded as individual bits within a single octet.
ACT	LACP_Activity is encoded in bit 0. Active LACP is encoded as a 1; Passive LACP as a 0.

Table 5-17: show port etherchannel detailed output (Continued)

Entry	Description
TIM	LACP_Timeout is encoded in bit 1. Short Timeout is encoded as a 1; Long Timeout as a 0.
AGG	Aggregability is encoded in bit 2. Aggregatable is encoded as a 1; Individual is encoded as a 0.
SYN	Synchronization is encoded in bit 3. In_Sync is encoded as a 1; Out_Of_Sync is encoded as a 0.
COL	Collecting is encoded in bit 4. True is encoded as a 1; False is encoded as a 0.
DIS	Distributing is encoded in bit 5. True is encoded as a 1; False is encoded as a 0.
DEF	Defaulted is encoded in bit 6.
EXP	Defaulted is encoded in bit 7.

Bits 7 and 8 are reserved; these are ignored on receipt and transmitted as zero. However, the received value of these bits is recorded on receipt to accurately reflect the actor's view of the partner's state in outgoing PDUs.

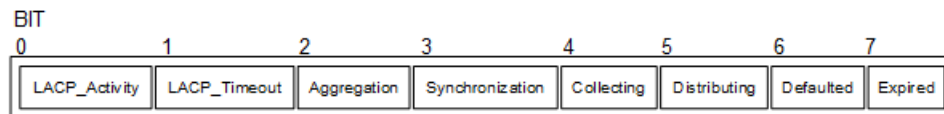
**Figure 5-50: Diagram of state machine octet**

show static-channel-group

Use this command to display the types of load-balancing port selection criteria (PSC) used on configured static aggregators.

Command Syntax

```
show static-channel-group (<1-16383>|)
```

Parameters

<1-16383> Specify channel-group number.

Command Mode

Privileged Exec mode

Applicability

This command was introduced before OcNOS version 1.3.

Examples

The following is an example of the output of this command:

```
#show static-channel-group 1
% Static Aggregator: sal
% Member:
  eth1
```

show static-channel load-balance

Use this command to display information about static channel groups.

Command Syntax

```
show static-channel (<1-16383>|) load-balance
```

Parameters

<1-16383> Specify static-channel-group number.

Command Mode

Privileged Exec mode

Applicability

This command was introduced before OcNOS Version 1.0.

Examples

The following is an example of the output of this command:

```
#show static-channel load-balance
% Static Aggregator: sa5
Flow based division
```

snmp restart lacp

Use this command to restart SNMP in LACP.

Command Syntax

```
snmp restart lacp
```

Parameters

None

Default

By default, snmp restart lacp is disabled

Command Mode

Configure mode

Applicability

This command was introduced before OcNOS version 1.3.

Examples

```
(config)#snmp restart lacp
```

static-channel-group

Use this command to create a static link aggregation group or to add an interface to an existing link aggregation group.

Use the `no` form of this command to remove an interface from a static link aggregation group without removing the static link aggregation group itself.

Command Syntax

```
static-channel-group <1-16383>
no static-channel-group
```

Parameter

<1-16383> Channel group number.

Default

By default, static channel group is disabled

Command Mode

Interface mode

Applicability

This command was introduced before OcnOS version 1.3.

Example

```
#configure terminal
(config)#interface xe1
(config-if)#switchport
(config-if)#static-channel-group 1
(config-if)#exit

#sh run in sa1
!
interface sa1
  switchport
```

This is an example of `no static-channel-group`:

```
#configure terminal
(config)#interface xe1
(config-if)#switchport
(config-if)#no static-channel-group
(config-if)#exit

#sh run in xe1
!
interface xe1 switchport
!
#sh run in sa1
!
interface sa1
  switchport
```

!

CHAPTER 6 Multi-chassis Link Aggregation Commands

This chapter describes the Multi-Chassis Link Aggregation commands.

Multi-Chassis Link Aggregation is also called MC-LAG, MLAG, or Distributed Resilient Network Interconnect (DRNI). In this document, it is called MLAG.

- [clear mcec statistics](#)
- [domain-address](#)
- [debug mcec](#)
- [domain hello timeout](#)
- [domain priority](#)
- [domain-system-number](#)
- [intra-domain-link](#)
- [intra-domain-peer](#)
- [mcec domain configuration](#)
- [mlog](#)
- [mode](#)
- [show mcec statistics](#)
- [show mlog detail](#)
- [show mlog domain](#)
- [show mlog stp-synchronization status](#)
- [show spanning-tree mlog operational-config](#)
- [show spanning-tree mlog sync-detail](#)
- [switchover type](#)

clear mcec statistics

Use this command to clear the statistics related to hello and information PDUs in the MCEC domain.

Command Syntax

```
clear mcec statistics
```

Parameters

None

Command Mode

Privileged exec mode

Applicability

This command was introduced before OcNOS version 4.0.

Examples

```
#clear mcec statistics
```

domain-address

Use this command to configure domain address, which helps to identify the mcec domain.

Use the `no` form of this command to remove the domain address.

Command Syntax

```
domain-address <domain-id>
no domain-address
```

Parameters

`domain-id` domain address in HHHH.HHHH.HHHH format

Command Mode

MCEC mode

Applicability

This command was introduced before OcNOS version 1.3.

Examples

```
#config terminal
(config)#mcec domain configuration
(config-mcec-domain)#domain-address 1111.2222.3333
```

debug mcec

Use this command to view debugging logs for MLAG.

Use the `no` form of this command to remove debugging logs for MLAG.

Command Syntax

```
debug mcec (timer|event|hello|info|cli|mac-sync|all)
no debug mcec (timer|event|hello|info|cli|mac-sync|all)
```

Parameters

<code>all</code>	ALL
<code>cli</code>	CLI
<code>event</code>	Event
<code>hello</code>	Hello
<code>info</code>	Info
<code>mac-sync</code>	Mac Sync
<code>timer</code>	Timer

Command Mode

Privileged Exec mode

Applicability

This command was introduced before OcnOS version 1.3.

Example

```
#debug mcec all
#no debug mcec all
```

domain hello timeout

Use this command to specify the domain hello-timeout value.

Command Syntax

```
domain-hello-timeout (long|short)
no domain-hello-timeout
```

Parameters

long	Long Timeout
short	Short Timeout

Command Mode

MCEC mode

Applicability

This command was introduced before OcnOS version 1.3.

Examples

```
#config terminal
(config)#mcec domain configuration
(config-mcec-domain)#domain-hello-timeout long
```

domain priority

Use this command to specify the priority value associated with mcec domain.

Use the `no` form of this command to remove the priority value associated with mcec domain.

Command Syntax

```
domain-priority <1-65535>
no domain-priority
```

Parameters

<1-65535>	Priority Value
-----------	----------------

Default

The default value is 32768.

Command Mode

MCEC mode

Applicability

This command was introduced before OcNOS version 1.3.

Example

```
#config terminal
(config)#mcec domain configuration
(config-mcec-domain)#domain-priority 2
```

domain-system-number

Use this command to configure domain system number, which uniquely identifies domain system in mcec domain.

Use the `no` form of this command to configure domain system number.

Command Syntax

```
domain-system-number <1-2>
no domain-system-number
```

Parameters

<1-2>	Domain System Number
-------	----------------------

Command Mode

MLAC mode

Applicability

This command was introduced before OcnOS version 1.3.

Example

```
#config terminal
(config)#mcec domain configuration
(config-mcec-domain)#domain-system-number 2
```

intra-domain-link

Use this command to map an interface as intra domain link that connects the domain system with its neighbor in a mcec domain.

Use the no form of this command to unmap the interface configured as intra domain link that connects the domain system with its neighbor in a mcec domain.

Command Syntax

```
intra-domain-link <IFNAME>
no intra-domain-link
```

Parameters

IFNAME	Interface name
--------	----------------

Command Mode

MCEC mode

Applicability

This command was introduced before OcnOS version 1.3.

Example

```
#config terminal
(config)#mcec domain configuration
(config-mcec-domain)#intra-domain-link eth2
```

intra-domain-peer

Use this command to map an interface as intra domain peer that connects the domain system with its neighbor in a mcec domain.

Use the `no` form of this command to unmap the interface configured as intra domain peer that connects the domain system with its neighbor in a mcec domain.

Command Syntax

```
intra-domain-peer A.B.C.D source-address A.B.C.D (vrf VRF_NAME|)
no intra-domain-peer
```

Parameters

Peer Address	Peer/Target IPv4 address
A.B.C.D	IPv4 address.
source-address	Source IPv4 address
A.B.C.D	IPv4 address.
VRF_NAME	VRF Interface name

Command Mode

MCEC mode

Applicability

This command was introduced before OcNOS version 3.0.

Example

```
#config terminal
(config)#mcec domain configuration
(config-mcec-domain)#intra-domain-peer 1.1.1.1 source-address 2.2.2.2 vrf
myvrf
```

mcec domain configuration

Use this command to enter MCEC Domain configuration mode to configure mcec domain information.

Command Syntax

```
mcec domain configuration
```

Parameters

None

Command Mode

Configure mode

Applicability

This command was introduced before OcNOS version 1.3.

Examples

```
#config terminal
(config)#mcec domain configuration
(config-mcec-domain)#
```

mlag

Use this command to create mlag instance.

Note: The mlag interface must be associated to a port channel.

Note: All MLAG nodes must use the same MAC table size.

Use the `no` form of this command to un-map the mlag instance.

Command Syntax

```
mlag <1-256>
```

```
no mlag
```

Parameters

```
<1-256>          MLAG identifier
```

Command Mode

Interface mode

Applicability

This command was introduced before OcnOS version 4.1.

Example

```
#config terminal  
(config)#interface mlag1
```

mode

Use this command to set the MLAG mode.

Use the `no` form of this command to turn off this feature.

Command Syntax

```
mode (active-standby|active-active)
no mode (active-standby|active-active)
```

Parameters

<code>active-standby</code>	The interface is ready for transition to the active state if a failure occurs in the other node.
<code>active-active</code>	The interface is the active interface that carries the traffic.

Command Mode

Configure mode

Applicability

This command was introduced before OcnOS version 4.0.

Examples

```
(config)#
(config)#interface mlag1
(config-if)#mode active-standby
```

show mcec statistics

Use this command to display all the statistics related to hello and info pdu's in mcec domain.

Command Syntax

```
show mcec statistics
```

Parameters

None

Command Mode

Privileged Exec mode

Applicability

This command was introduced before OcNOS version 1.3.

Examples

```
#sh mcec statistics
Unknown MCCPDU received on the system : 0

-----
IDP xe49
-----
Valid RX Hello PDUs : 109
Valid TX Hello PDUs : 201
Valid RX Info PDUs: 23
Valid TX Info PDUs : 28
Valid RX Mac Sync PDUs : 5
Valid TX Mac Sync PDUs : 4

MLAG 1
Valid RX Info PDUs : 5
Valid TX Info PDUs : 7
```

[Table 6-18](#) Shows the output details.

Table 6-18: Show mcec statistics details

Entry	Description
RX Hello PDUs	Total number of received hello PDUs.
TX Hello PDUs	Total number of transmitted hello PDUs.
RX Info PDUs	Total number of received Info PDUs.
TX Info PDUs	Total number of transmitted Info PDUs.
RX Mac Sync PDUs	Total number of received Mac Sync PDUs.
TX Mac Sync PDUs	Total number of transmitted Mac Sync PDUs.

show mlag detail

Use this command to display details about MLAG configuration and status.

Command Syntax

```
show mlag <1-256> detail
```

Parameters

<1-256> MLAG group number

Command Mode

Privileged Exec mode

Applicability

This command was introduced before OcNOS version 1.3.

Examples

```
#sh mlag 1 detail

MLAG-1
Mapped Aggregator : po1
Admin Key : 32769
Oper Key: 16385
Physical properties Digest : dd 9c f 76 dd b6 5f 2f eb a1 d3 bb 8d 96 fc 82

Neigh Admin Key: 16385
Neigh Physical Digest: dd 9c f 76 dd b6 5f 2f eb a1 d3 bb 8d 96 fc 82
Info RCV State : Current
Info Periodic Time State : Standby
Mlag Sync: IN_SYNC
```

[Table 6-19](#) Shows the output details.

Table 6-19: Show mlag output details

Entry	Description
Mapped Aggregator	Map the output of the aggregator in the interface which is active transformation.
Admin Key	MLAG administrative key – automatically configured value on each port configured to use MLAG.
Oper Key	MLAG operator key on Partner – automatically configured value on each port configured to use MLAG.
Physical properties Digest	Physical properties of the digest.
Neigh Admin Key	Neigh administrative key – automatically configured value on each port configured to use MLAG.
Neigh Physical Digest	Neigh physical properties of the digest.

Table 6-19: Show mlag output details

Entry	Description
Info RCV State	Details of the RCV.
Info Periodic Time State	A simple state space formulation of a general digital periodic time series is constructed.
Mlag Sync	MAC address synchronization enables a MLAG Partner to forward Layer 3 packets arriving on this interfaces with either its own MAC address or its Partner's.

show mlag domain

Use this command to display MLAG configuration and status.

Command Syntax

```
show mlag domain <details|summary>
```

Parameters

details	details
summary	summary

Command Mode

Privileged Exec mode

Applicability

This command was introduced before OcNOS version 1.3.

Examples

```
#show mlag domain summary
-----
Domain Configuration
-----
Domain System Number : 2
Domain Address: 1111.2222.3333
Domain Priority: 1000
Intra Domain Interface: xe49
Domain Adjacency: UP

-----
MLAG Configuration
-----

MLAG-1
Mapped Aggregator: po1
Physical properties Digest: dd 9c f 76 dd b6 5f 2f eb a1 d3 bb 8d 96 fc 82
Total Bandwidth : 40g
Mlag Sync : IN_SYNC

#sh mlag domain details
-----
Domain Configuration
-----

Domain System Number: 2
Domain Address: 1111.2222.3333
Domain Priority: 1000
Intra Domain Interface: xe49

Hello RCV State: Current
Hello Periodic Timer State: Fast Periodic
```

```

Domain Sync : IN_SYNC
Neigh Domain Sync : IN_SYNC
Domain Adjacency : UP

```

```

-----
MLAG Configuration
-----

```

```

MLAG-1
Mapped Aggregator: po1
Admin Key: 32769
Oper Key: 16385
Physical properties Digest: dd 9c f 76 dd b6 5f 2f eb a1 d3 bb 8d 96 fc 82

```

```

Neigh Admin Key: 16385
Neigh Physical Digest : dd 9c f 76 dd b6 5f 2f eb a1 d3 bb 8d 96 fc 82
Info RCV State : Current
Info Periodic Time State : Standby
Mlag Sync : IN_SYNC

```

Table 6-20 Shows the output details.

Table 6-20: Show mlag summary details

Entry	Description
Domain System Number	Number to identify the node in domain.
Domain Address	Domain address for the MLAG domain.
Domain Priority	Domain priority for the MLAG domain.
Intra Domain Interface	Intra domain interface between MLAG domains.
Domain Adjacency	Domain adjacency details and configuration.
Physical properties Digest	physical properties of the digest algorithm.
Total Bandwidth	Total bandwidth available on the interface.
Domain System Number	Number of the domain system.
Domain Address	Domain address for the MLAG domain.
Domain Priority	Domain priority for the MLAG domain.
Intra Domain Interface	Details of the intra domain in the interface.
Hello RCV State	State of the hello RCV in the interface.
Hello Periodic Timer State	State of the hello periodic timer in the interface.
Domain Sync	Detail of the domain configuration synchronization.
Mapped Aggregator	Map the output of the aggregator in the interface which is active transformation.
Admin Key	MLAG administrative key – automatically configured value on each port configured to use MLAG.

Table 6-20: Show mlag summary details

Entry	Description
Oper Key	MLAG operator key on Partner – automatically configured value on each port configured to use MLAG.
Physical properties Digest	Physical properties of the digest.
Neigh Admin Key	Neigh administrative key – automatically configured value on each port configured to use MLAG.
Neigh Physical Digest	Neigh physical properties of the digest.
Info RCV State	Details of the RCV.
Info Periodic Time State	A simple state space formulation of a general digital periodic time series is constructed.
Mlag Sync	MAC address synchronization enables a MLAG Partner to forward Layer 3 packets arriving on this interfaces with either its own MAC address or its Partner's.

show mlag stp-synchronization status

Use this command to display information about MLAG STP Synchronization status

Command Syntax

```
show mlag stp-synchronization status
```

Parameters

```
stp-synchronization STP synchronization related show commands
status              STP synchronization status
```

Command Mode

Exec mode and Privileged Exec mode

Applicability

This command was introduced before OcnOS version 1.3.

Examples

```
#show mlag stp-synchronization status
```

```
Home STP Domain Digest      : 27 e7 22 79 76 b2 c8 4e 49 9f b4 45 4f 20 68 aa
Neighbor STP Domain Digest  : 27 e7 22 79 76 b2 c8 4e 49 9f b4 45 4f 20 68 aa
STP Sync Status             : IN_SYNC
```

```
-----
MLAG Interface Status:
```

```
MLAG1:
```

```
Home Interface Digest       : 76 88 b9 cd 43 c1 b0 9d b 86 64 e5 b7 d2 7f a7
Neighbor Interface Digest   : 76 88 b9 cd 43 c1 b0 9d b 86 64 e5 b7 d2 7f a7
STP Sync Status             : IN_SYNC
```

```
#
```

Entry	Description
Home STP Domain Digest	STP Domain properties of the digest
Neighbor STP Domain Digest	Neighbor STP Domain properties of the
digest	
STP Sync Status	Detail of configured STP
synchronization.	
Home Interface Digest	Interface properties of the digest.
Neighbor Interface Digest	Neigh Interface properties of the
digest.	

show spanning-tree mlag operational-config

Use this command to display the operational information for MLAG.

Command Syntax

```
show spanning-tree mlag operational-config
```

Parameters

None

Command Mode

Privilege exec mode

Applicability

This command was introduced before OcNOS version 4.0.

Examples

```
#show spanning-tree mlag operational-config
Operational Configuration
-----
Bridge Priority : 32768
Pathcost method : Long
Interface : mlag1
Pathcost : 1000
Priority : 0
```

show spanning-tree mlag sync-detail

Use this command to display the spanning-tree properties shared with the domain peer node.

Command Syntax

```
show spanning-tree mlag sync-detail
```

Parameters

None

Command Mode

Privilege exec mode

Applicability

This command was introduced before OcNOS version 4.0.

Examples

```
#show spanning-tree mlag sync-detail
Domain Digest Parameters
-----
Max Age : 20
BPDU Filter : Disabled
BPDU Guard : Disabled
Hello time : 2
Forward Delay : 15
Force Version : 2
Err-disable status : Disabled
Err-disable timeout : 300
MSTP Enabled : Enabled
MSTP Bridge Forward : Disabled
Interface Digest parameters
-----
Port Name : mlag1
Admin Root Guard : Disabled
Admin Edge port : Disabled
Portfast configuration : Disabled
Restricted TCN : Disabled
Admin BPDU filter : Default
Admin BPDU guard : Default
```

switchover type

Use this command to set the MLAG switchover type.

Use the `no` form of this command to turn off switchover.

Command Syntax

```
switchover type revertive <1-3600>
switchover type non-revertive
no switchover type (revertive | non-revertive)
```

Parameters

`revertive <1-3600>` A network failure triggers a switchover, the initially active node becomes active again after failure recovery. Configure the number of seconds within this range to switch back to the initially active node after the failure recovery. The default time is 10 seconds.

`non-revertive` A network failure triggers a switchover, the initially active node remains on standby after failure recovery.

Default

None

Command Mode

Interface mode

Applicability

This command was introduced before OcNOS version 4.0 and the `revertive <1-3600>` is revised in OcNOS version 6.6.0.

Examples

```
OcNOS(config)#interface mlag1
OcNOS(config-if)#switchover type revertive 20

OcNOS(config)#interface mlag1
OcNOS(config-if)#switchover type non-revertive
```

CHAPTER 7 Traffic Mirroring Commands

This chapter provides a description of syntax, and examples for Traffic Mirroring. It includes the following commands:

- `monitor session`
- `monitor session shut`
- `source interface`
- `source vlan`
- `destination interface`
- `no shut`
- `shut`
- `filter`
- `description`
- `remote destination`
- `show monitor`
- `show monitor session`
- `show filter`
- `show monitor running configuration`

monitor session

Use this command to create a local or remote monitor session. By default, a local monitor session is created.

A monitor session consists of:

- A single destination interface, referred to as a mirror-to port or a single remote destination
- One or more source interfaces (egress, ingress, or both)
- One or more VLAN sources in the ingress direction
- One or more filters that can be applied to filter the mirrored packets

Use the `no` parameter to delete a monitor session.

Command Syntax

```
monitor session <1-18> ( | type ( local | remote ) )
no monitor session ( <1-18> | all )
```

Parameters

<1-18>	Session number
local	Create a local session
remote	Create a remote source node session
all	All sessions

Default

By default, monitor session type is local and will not be active by default

Command Mode

Configure mode

Applicability

This command was introduced before OcnOS version 1.3.

Examples

```
#configure terminal
(config)#monitor session 1
(config-monitor)#exit
(config)#monitor session 3 type remote
(config-monitor)#exit
(config)#no monitor session 1
```

monitor session shut

Use this command to deactivate one monitor session.

Use the `no` parameter to activate one monitor session.

Command Syntax

```
monitor session <1-18> shut
no monitor session <1-18> shut
```

Parameters

<1-18>	Session number
--------	----------------

Default

Monitor session will not be active by default

Command Mode

Configure mode

Applicability

This command was introduced before OcNOS version 1.3.

Examples

```
#configure terminal
(config)#monitor session 3 shut

(config)#no monitor session 3 shut
```

source interface

Use this command to configure a source port per monitor session in either ingress or egress or both directions. Source port can be physical interface or a trunk port.

Use the `no` parameter to remove the source port.

Note: The behavior is changed when the configuration is edited in the current release: For example, if you have configured as follows

```
source interface xe10 rx → running-config/backend: source interface xe10 rx
source interface xe10 tx → running-config/backend: source interface xe10 both
```

its direction is changed to as follows

```
source interface xe10 rx → running-config/backend: source interface xe10 rx
source interface xe10 tx → running-config/backend: source interface xe10 tx
```

Command Syntax

```
source interface IFNAME ( rx | tx | both | )
no source interface IFNAME
```

Parameters

IFNAME	Interface name
rx	Ingress direction
tx	Egress direction
both	Both directions

Default

Source port will be mirrored for both directions if the direction is not specified

Command Mode

Monitor configure mode

Applicability

This command was introduced before OcNOS version 1.3.

Example

```
#configure terminal
(config)#monitor session 1
(config-monitor)#source interface xe1 both
(config-monitor)#no source interface xe1
```

source vlan

Use this command to configure one or more VLANs as source per monitor session. A VLAN as source will be mirrored only in the ingress direction. Up to 32 VLANs can be configured as source per monitor session.

Use the `no` parameter to remove vlan source from monitor session.

Command Syntax

```
source vlan VLAN_RANGE
no source vlan VLAN_RANGE
```

Parameters

VLAN_RANGE VLAN identifier or VLAN identifier range

Default

A trunk port is a member of all VLANs by default.

Command Mode

Monitor configure mode

Applicability

This command was introduced before OcnOS version 1.3.

Example

```
#configure terminal
(config)#monitor session 1
(config-monitor)#source vlan 2
(config-monitor)#source vlan 4-10
(config-monitor)#no source vlan 2-5,10
```

destination interface

Use this command to configure a mirror-to port per local monitor session. A destination port can be a physical port or a trunk port.

Use the `no` parameter to remove the destination port from a local monitor session.

Note: For the monitor sessions, the destination interface should be an switchport with no service attached. This port will not participate in L2/L3 packet forwarding.

Command Syntax

```
destination interface IFNAME
no destination interface IFNAME
```

Parameters

IFNAME	Interface name
--------	----------------

Default

No default value is specified

Command Mode

Monitor configure mode

Applicability

This command was introduced before OcnOS version 1.3.

Example

```
#configure terminal
(config)#interface xe3
(config-if)#switchport
(config-if)#exit
(config)#monitor session 1
(config-monitor)#destination interface xe3
(config-monitor)#no destination interface xe3
```

no shut

Use this command to activate a monitor session

Command Syntax

```
no shut
```

Parameters

None

Default

Monitor session will not be active by default.

Command Mode

Monitor configure mode

Applicability

This command was introduced before OcNOS version 1.3.

Example

```
#configure terminal
(config)#monitor session 3
(config-monitor)#no shut
```

shut

Use this command to de-activate a monitor session.

Command Syntax

```
shut
```

Parameters

None

Default

Monitored session is not active by default.

Command Mode

Monitor configure mode

Applicability

This command was introduced before OcNOS version 1.3.

Example

```
#configure terminal
(config)#monitor session 3
(config-monitor)#shut
```

filter

Use this command to add filters to the monitor session. Filters can be applied only in case of ingress mirroring. The configuration of sequence identifier for each rule is optional, but even if it is not configured explicitly, it will always be generated and in steps of 10.

Use the `no` parameter to remove the filter from monitor session.

Command Syntax

```
(<1-268435453>/<1-4294967294> |) filter {vlan VLAN_RANGE| cos <0-7> | dest-mac
(host XXXX.XXXX.XXXX | XXXX.XXXX.XXXX XXXX.XXXX.XXXX) | src-mac (host
XXXX.XXXX.XXXX | XXXX.XXXX.XXXX XXXX.XXXX.XXXX) | frame-type (ETHTYPE | arp (req
| resp|) (sender-ip A.B.C.D|) (target-ip A.B.C.D|) | ipv4 (src-ip (A.B.C.D |
A.B.C.D/M)|) (dest-ip (A.B.C.D | A.B.C.D/M)|) | ipv6 (src-ip X:X::X:X/M |) (dest-
ip X:X::X:X/M |))}
no (<1-268435453>/<1-4294967294>) filter
```

Parameters

```
(<1-268435453>/<1-4294967294> |)
Sequence identifier for each rule.
<2-4094> VLAN identifier
<0-7> COS number
XXXX.XXXX.XXXX MAC address
ETHTYPE Ethertype
arp ARP frames
req Request frames
resp Response frames
A.B.C.D Single IP address
A.B.C.D/M IP addresses with mask
X:X::X:X/M IPv6 addresses with mask
```

Default

No default value is specified.

Command Mode

Monitor configure mode

Applicability

This command was introduced before OcNOS version 1.3.

Example

```
#configure terminal
(config)#monitor session 3
(config-monitor)#filter dest-mac host 0000.0001.2421 frame-type ipv4
(config-monitor)#filter cos 3 frame-type arp req sender-ip 2.2.2.1
```

```
(config-monitor)#35 filter vlan 200  
(config-monitor)#no 10 filter  
(config-monitor)#no 20 filter  
(config-monitor)#no 35 filterr
```

description

Use this command to add a description to the monitor session.

Use the `no` parameter to delete a description of the monitor session.

Command Syntax

```
description LINE
no description
```

Parameters

LINE Enter the description string

Default

No default value is specified.

Command Mode

Monitor configure mode

Applicability

This command was introduced before OcnOS version 1.3.

Example

```
#configure terminal
(config)#monitor session 3
(config-monitor)#description "port mirror rx"
(config-monitor)#no description
```

remote destination

Use this command to configure a destination VLAN and the reflector port for the remote monitor session.

Use the `no` parameter to remove a destination from a remote monitor session.

Command Syntax

```
destination remote vlan <2-4094> reflector-port IFNAME
no destination remote
```

Parameters

<2-4094>	VLAN identifier
IFNAME	Interface name

Default

No default value is specified

Command Mode

Monitor configure mode

Applicability

This command was introduced before OcnOS version 1.3.

Example

```
#configure terminal
(config)#no vlan 900 bridge 1
(config)#interface xe3
(config-if)#switchport
(config)#monitor session 1
(config-monitor)#destination remote vlan 900 reflector-port xe3
(config-monitor)#no destination remote
```

show monitor

Use this command to display states of all monitor sessions. If a session is down, the reason is displayed.

Command Syntax

```
show monitor
```

Parameters

None

Command Mode

Exec mode and Privileged Exec mode

Applicability

This command was introduced before OcNOS version 1.3.

Example

```
#show monitor
Session  State      Reason
-----  -
1        down      No sources configured
2        down      Dst in wrong mode
```

show monitor session

Use this command to display the configuration details of one or more monitor sessions.

Command Syntax

```
show monitor session (<1-18>|all|(range RANGE)) (brief|)
```

Parameters

<1-18>	Session number
all	All sessions
RANGE	Session number range (n1-n2)
brief	Brief information

Command Mode

Exec mode or Privileged Exec mode

Applicability

This command was introduced before OcNOS version 1.3.

Example

```
#show monitor session 1
session 1
-----
type           : local
state          : down (Session admin shut)
source intf    :
tx             : xe1 xe3 xe4
rx             : xe2 xe3 xe4
both          : xe3 xe4
source VLANs   :
rx             : 2,5-10,15,18-20
destination ports : xe5
filter count   :
```

Legend: f = forwarding enabled, l = learning enabled

#

[Table 7-21](#) Explains the show command output fields

Table 7-21: Show monitor session output fields

Field	Description
Type	Type of monitor session.
State	State of the security flow filter.
Rx	Incoming flow (source and destination IP addresses).
Tx	Reverse flow (source and destination IP addresses).

Field	Description
Both	Incoming and reverse flow (source and destination IP address)
Destination Port	Name of the destination port to be matched.
Source intf	Number of maximum intf central source session.
Source VLANs	Number of maximum VLANs central source session.
Filter count	Used to count number of lines in a file or table.

show filter

Use this command to display filters for one or more monitor sessions.

Command Syntax

```
show monitor session (<1-18>|all|(range RANGE)) filter
```

Parameters

<1-18>	Session number
all	All sessions
RANGE	Session number range (n1-n2)

Command Mode

Exec mode or Privileged Exec mode

Applicability

This command was introduced before OcnOS version 1.3.

Example

```
#show monitor session 1 filter
session 1
-----
filter count : 3
-----

match set 1
-----
destination mac address : 0000.0002.4451 (host)
source mac address : 0000.0012.2288 (host)
-----

match set 2
-----
frame type : arp
sender ip address : 2.2.2.5
target ip address : 2.2.2.8
-----

match set 3
-----
destination mac address : 0000.0001.1453 (host)
frame type : ipv4
source ip address : 3.3.3.5
#
```

show monitor running configuration

Use this command to display the mirror-related running configuration.

Command Syntax

```
show running-config monitor (all|)
```

Parameters

all Show running configuration with defaults

Command Mode

Exec mode or Privileged Exec mode

Applicability

This command was introduced before OcnOS version 1.3.

Example

```
#show running-config monitor
!
monitor session 1
 source interface xe10 rx
 destination interface po1
 no shut

#
```

CHAPTER 8 VLAN and Private VLAN Commands

This chapter has the commands used to manage VLANs and Private VLANs. A private VLAN contains switch ports that cannot communicate with each other, but can access other networks. This chapter includes the following commands:

- `global-bridge-vlan-check enable`
- `private-vlan association`
- `private-vlan community`
- `private-vlan isolated`
- `private-vlan primary`
- `show vlan`
- `show vlan brief`
- `show vlan classifier`
- `switchport access`
- `switchport hybrid`
- `switchport mode`
- `switchport mode hybrid acceptable-frame-type`
- `switchport trunk allowed`
- `switchport mode trunk disable-native-vlan`
- `switchport trunk native`
- `switchport mode private-vlan`
- `switchport private-vlan association-trunk`
- `switchport private-vlan host-association`
- `switchport private-vlan mapping`
- `feature vlan classifier`
- `vlan classifier activate`
- `vlan classifier group`
- `vlan classifier rule ipv4`
- `vlan classifier rule mac`
- `vlan classifier rule proto`
- `vlan database`
- `vlan VLAN_RANGE bridge`
- `vlan VLAN_RANGE type customer`
- `vlan VLAN_RANGE type service`

global-bridge-vlan-check enable

Use this command to establish a VLAN in the global VLAN database, ensuring that the same VLAN is not permitted to be encapsulated on a sub-interface.

Command Syntax

```
global-bridge-vlan-check enable
no global-bridge-vlan-check enable
```

Parameters

enable	Enable VLAN check validations
--------	-------------------------------

Default

Disabled.

Command Mode

VLAN Configuration mode

Applicability

This command is introduced from OcnOS version 6.5.1.

Example

1. Validating sub-interface encaps VLANs should not be overlapped with bridge VLANs.

```
 #(config)#bridge 1 protocol rstp vlan-bridge
 (config)#vlan 2-10 bridge 1
 (config)#commit
 (config)#
 (config)#global-bridge-vlan-check enable
 (config)#commit
 (config)#
 (config)#int xe2.2 switchport
 (config-if)#encapsulation dot1q 2
 (config-if)#commit
```

Bridge VLAN ids cannot be used for L2 sub-interface's encaps

Failed to commit. As error(s) encountered during commit operation.

2. Configure sub-interface encaps VLANs when not overlapping with bridge VLAN IDs.

```
 #(config)#int xe5.5 switchport
 (config-if)#encapsulation dot1q 11
 (config-if)#commit
 (config-if)#exit
 (config)#end
```

private-vlan association

Use this command to associate a secondary VLAN to a primary VLAN. Only one isolated VLAN can be associated to a primary VLAN. Multiple community VLANs can be associated to a primary VLAN.

Use the `no` form of this command to remove association of all the secondary VLANs to a primary VLAN.

Command Syntax

```
private-vlan association add VLAN_RANGE
private-vlan association remove VLAN_RANGE
no private-vlan association
```

Parameters

<code>add</code>	Add a VLAN to private VLAN list.
<code>remove</code>	Removes values associated with a single VLAN.
<code>VLAN_RANGE</code>	Specify VLAN ID 1-4094 or range(s): 1-5, 10 or 2-5,7-19 of the private VLANs to be configured

Default

By default, functionality is disabled

Command Mode

VLAN Configuration mode

Applicability

This command was introduced before OcnOS version 1.3.

Example

```
#configure terminal
(config)#vlan database
(config-vlan)#private-vlan association add 3-4
(config-vlan)#private-vlan association remove 3-4
(config-vlan)#no private-vlan association
```

private-vlan community

Use this command to set a VLAN type for a private (community) VLAN.

Use the `no` form of this command to remove the specified private VLAN.

Command Syntax

```
private-vlan <2-4094> community bridge <1-32>
no private-vlan <2-4094> bridge <1-32>
```

Parameters

<code><2-4094></code>	Specify a private VLAN identifier.
<code>bridge</code>	Specify the bridge identifier.

Default

By default, private vlan is disabled

Command Mode

VLAN Configuration mode

Applicability

This command was introduced before OcnOS version 1.3.

Example

```
#configure terminal
(config)#vlan database
(config-vlan)#private-vlan 4 community bridge 1
```

private-vlan isolated

Use this command to create an isolated private VLAN.

Use the `no` form of this command to remove the specified private VLAN.

Command Syntax

```
private-vlan <2-4094> isolated bridge <1-32>  
no private-vlan <2-4094> bridge <1-32>
```

Parameters

<code><2-4094></code>	Specify a private VLAN identifier.
<code>bridge</code>	Specify the bridge identifier.

Default

By default, private vlan is disabled

Command Mode

VLAN Configuration mode

Applicability

This command was introduced before OcnOS version 1.3.

Example

```
#configure terminal  
(config)#vlan database  
(config-vlan)#private-vlan 3 isolated bridge 1
```

private-vlan primary

Use this command to create a primary VLAN.

Use the `no` form of this command to remove the specified private VLAN.

Command Syntax

```
private-vlan <2-4094> primary bridge <1-32>  
no private-vlan <2-4094> bridge <1-32>
```

Parameters

<code><2-4094></code>	Specify a private VLAN identifier.
<code>bridge</code>	Specify the bridge identifier.

Default

By default, private vlan is disabled

Command Mode

VLAN Configuration mode

Applicability

This command was introduced before OcnOS version 1.3.

Example

```
#configure terminal  
(config)#vlan database  
(config-vlan)#private-vlan 2 primary bridge 1
```

show vlan

Use this command to display information about static, dynamic or all VLANs.

Command Syntax

```
show vlan (all|static|dynamic|auto) bridge <1-32>
```

Parameters

<1-32>	Displays the bridge group ID.
all	Displays all VLANs (static and dynamic).
static	Displays static VLANs.
dynamic	Displays dynamic VLANs.
auto	Displays auto configured VLANs.

Command Mode

Exec mode and Privileged Exec mode

Applicability

This command was introduced before OcNOS version 1.3.

Example

```
#sh vlan all bridge 1
Bridge  VLAN ID      Name                State  H/W Status      Member ports
          (u)-Untagged, (t)-Tagged
=====
1         1         default            ACTIVE  Up              xe2(u) xe10(u)
1         2         vlan2              ACTIVE  Up              xe10(t)
1        10        VLAN0010           ACTIVE  Up              xe2(t) xe10(t)
1        20        VLAN0020           ACTIVE  Up              xe2(t) xe10(t)
1        30        VLAN0030           ACTIVE  Up              xe10(t)
1        40        VLAN0040           ACTIVE  Up              xe10(t)
1        50        VLAN0050           ACTIVE  Up              xe10(t)
1        60        VLAN0060           ACTIVE  Up              xe10(t)
#
```

[Table 8-22](#) Explains the show command output fields.

Table 8-22: show vlan output fields

Field	Description
Bridge	Number of bridge in the interface.
VLAN ID	VLAN identifier of the VLAN listed.
Name	Name of the VLAN.
State	Indicates whether the physical link is operational and can pass packets.

Field	Description
H/W Status	Indicates that the hardware is operational.
Member ports	The tagged interfaces to which a VLAN is associated.

show vlan brief

Use this command to display brief VLAN information for all bridges.

Command Syntax

```
show vlan (brief | <2-4094>)
```

Parameters

None

Command Mode

Exec mode and Privileged Exec mode

Applicability

This command was introduced before OcNOS version 1.3.

Example

The following is a sample output from this command when using the `all` parameter.

```
#show vlan brief
```

```
Bridge          VLAN ID  Name          State  Member ports
=====
1              1      default      ACTIVE eth2 (u)
              (u)-Untagged, (t)-Tagged
=====
0              1      default      ACTIVE
0              2      new          ACTIVE
```

[Table 8-23](#) Explains the show command output fields.

Table 8-23: show vlan brief output fields

Field	Description
Bridge	Number of bridge in the interface.
VLAN ID	VLAN identifier of the VLAN listed.
Name	Name of the VLAN.
State	Indicates whether the physical link is operational and can pass packets.
H/W Status	Indicates that the hardware is operational.
Member ports	The tagged interfaces to which a VLAN is associated.

show vlan classifier

Use this command to display information on configured VLAN classifier groups, interfaces configured for a VLAN group or all the groups, or all configured VLAN classifier rules.

If either a group ID or rule ID is not specified, all configured VLAN classifier rules are shown. If either a group ID or rule ID is specified, a specific configured VLAN classifier rule is shown.

Command Syntax

```
show vlan classifier group interface IFNAME
show vlan classifier group (<1-16>|)
show vlan classifier interface group (<1-16>|)
show vlan classifier rule(<1-256>|)
```

Parameters

group	Displays group activated information.
<1-16>	Displays the group ID
interface	Displays interface information.
interface	Displays interface group information.
group	Displays group activated information.
<1-16>	Displays the group ID.
rule	Displays VLAN classifier rule ID.
<1-256>	Displays rule ID information.

Command Mode

Exec mode and Privileged Exec mode

Applicability

This command was introduced before OcNOS version 1.3.

Example

This example displays groups for VLAN classifier groups:

```
#show vlan classifier group 1
vlan classifier group 1 add rule 1
```

This example displays interfaces for all VLAN classifier groups:

```
#show vlan classifier interface group
vlan classifier group 1 interface fe2
vlan classifier group 1 interface fe3
vlan classifier group 2 interface fe5
vlan classifier group 3 interface fe7
```

This example displays interfaces for VLAN classifier group 1:

```
#show vlan classifier interface group 1
vlan classifier group 1 interface fe2
vlan classifier group 1 interface fe3
```

This example displays interfaces for VLAN classifier rule 1:

```
#show vlan classifier rule 1
vlan classifier rule 1 mac 0011.2222.3333 vlan 2
```

switchport access

Use this command to change the default VLAN on the current interface.

Note: IP Infusion Inc. does not recommend using VLAN identifier 1 because of interoperability issues with other vendors' equipment.

Use the `no` parameter to remove an existing VLAN.

Command Syntax

```
switchport access vlan <2-4094>
no switchport access vlan
```

Parameter

<2-4094> Specify the VLAN identifier.

Default

The switchport access vlan default value is 3968.

Command Mode

Interface mode

Applicability

This command was introduced before OcnOS version 1.3.

Examples

This example shows the steps of a typical VLAN session, creating and destroying a VLAN.

```
#configure terminal
(config)#interface eth0
(config-if)#switchport access vlan 3

(config)#interface eth0
(config-if)#no switchport access vlan
```

switchport hybrid

Use this command to set the switching characteristics of the interface to hybrid. Both tagged and untagged frames will be classified over hybrid interfaces.

For a VLAN range, specify two VLAN identifiers: the lowest and then the highest separated by a hyphen. For a VLAN list, specify the VLAN identifiers separated by commas. Do not enter spaces between the hyphens or commas.

Use the `no` parameter to turn off allowed hybrid switching.

Command Syntax

```
switchport hybrid allowed vlan all
switchport hybrid vlan <2-4094>
switchport hybrid allowed vlan none
switchport hybrid allowed vlan remove VLAN_ID
switchport hybrid allowed vlan add VLAN_ID
no switchport hybrid
no switchport hybrid vlan
```

Parameters

<code>all</code>	Allow all VLANs to transmit and receive through the interface.
<code>none</code>	Allow no VLANs to transmit and receive through the interface.
<code>remove</code>	Remove these VLANs from the member set.
<code>VLAN_ID</code>	VLAN identifier(s) <2-4094>. You can specify a single VLAN, a VLAN range, or a VLAN list.
<code>add</code>	Add these VLANs to the member set.
<code>VLAN_ID</code>	VLAN identifier(s) <2-4094>. You can specify a single VLAN, a VLAN range, or a VLAN list.

Default

By default, `switchport hybrid` is enabled.

Command Mode

Interface mode

Applicability

This command was introduced before OcNOS version 1.3.

Examples

The following shows adding a single VLAN to the member set.

```
(config-if)#switchport hybrid allowed vlan add VLAN_RANGE2
eg switchport hybrid allowed vlan add 2
```

The following shows adding a range of VLANs to the member set.

```
(config-if)#switchport hybrid allowed vlan add VLAN_RANGE2
eg switchport hybrid allowed vlan add 2-4
```

switchport mode

Use this command to set the switching characteristics of the Layer 2 interface.

Note: Customer-Network Port is not supported in Qumran1 series platforms.

Command Syntax

```
switchport mode (access|hybrid|trunk|provider-network|customer-edge
|customer-network|private-vlan)
```

Parameters

access	Access.
hybrid	Hybrid.
trunk	Trunk.
provider-network	Provider network.
customer-network	Customer network.

Default

By default, switchport mode access is enabled.

Configuring an interface to operate in trunk mode using the CLI command `switchport mode trunk` will automatically permit VLAN ID 1 on the trunk ports by default.

Command Mode

Interface mode

Applicability

This command was introduced before OcNOS version 1.3.

Example

```
#configure terminal
(config)#interface eth0
(config-if)#switchport mode access
```

switchport mode hybrid acceptable-frame-type

Use this command to set the interface acceptable frame types. This processing occurs after VLAN classification.

Command Syntax

```
switchport mode hybrid acceptable-frame-type (all|vlan-tagged)
```

Parameters

all	Set all frames can be received
vlan-tagged	Accept only classified frames that belong to the port's member set.

Default

Received frames that cannot be classified in the previous step based on the acceptable frame type parameter (access/trunk) are discarded.

Command Mode

Interface mode

Applicability

This command was introduced before OcnOS version 1.3.

Example

```
#configure terminal
(config)#interface eth0
(config-if)#switchport mode hybrid acceptable-frame-type vlan-tagged
```

switchport trunk allowed

Use this command to set the switching characteristics of the interface to trunk.

For a VLAN range, specify two VLAN identifiers: the lowest and then the highest separated by a hyphen. For a VLAN list, specify the VLAN identifiers separated by commas. Do not enter spaces between the hyphens or commas.

Use the `no` parameter to remove all VLAN identifiers configured on this port.

Command Syntax

```
switchport trunk allowed vlan all
switchport trunk allowed vlan none
switchport trunk allowed vlan add VLAN_ID
switchport trunk allowed vlan except VLAN_ID
switchport trunk allowed vlan remove VLAN_ID
no switchport trunk
```

Parameters

<code>all</code>	Allow all VLANs to transmit and receive through the interface.
<code>none</code>	Allow no VLANs to transmit and receive through the interface.
<code>add</code>	Add these VLANs to the member set.
<code>VLAN_ID</code>	VLAN identifier(s) <2-4094>. You can specify a single VLAN, a VLAN range, or a VLAN list.
<code>except</code>	All VLANs except these VLANs are part of the member set.
<code>VLAN_ID</code>	VLAN identifier(s) <2-4094>. You can specify a single VLAN, a VLAN range, or a VLAN list.
<code>remove</code>	Remove these VLANs from the member set.
<code>VLAN_ID</code>	VLAN identifier(s) <2-4094>. You can specify a single VLAN, a VLAN range, or a VLAN list.

Default

Received frames that cannot be classified in the previous step based on the acceptable frame type parameter (access/trunk) are discarded.

Command Mode

Interface mode

Applicability

This command was introduced before OcnOS version 1.3.

Examples

The following shows adding a single VLAN to the port's member set.

```
(config)#interface eth0
(config-if)#switchport trunk allowed vlan add 2
```

The following shows adding a range of VLANs to the port's member set.

```
(config)#interface eth0  
(config-if)#switchport trunk allowed vlan add 2-4
```

switchport mode trunk disable-native-vlan

Use this command to create a switchport mode trunk without any default native vlan (i.e. vlan 1).

Use the `no` form of this command to delete the CLI and add `vlan-1` back as `default-native-vlan` (i.e. vlan 1) as untagged.

Command Syntax

```
switchport mode trunk disable-native-vlan
no switchport mode trunk disable-native-vlan
```

Parameters

None

Command Mode

Interface mode

Applicability

This command is introduced in OcNOS version 5.1.

Example

```
(config)#int xe7
(config-if)#switchport mode trunk disable-native-vlan
```

switchport trunk native

Use this command to configure native VLANs for this port. The native VLAN is used for classifying the incoming untagged packets.

Use the `no` parameter to revert the native VLAN to the default VLAN identifier 1.

Command Syntax

```
switchport trunk native vlan VLAN_ID
no switchport trunk native vlan
```

Parameter

VLAN_ID	VLAN identifier(s) <1-4094>. You can specify a single VLAN, or a VLAN list. For a VLAN list, specify the VLAN identifiers separated by commas. Do not enter spaces in between the hyphens or commas.
---------	---

Default

The default is that ingress filtering is off and all frame types are classified and accepted.

Command Mode

Interface mode

Applicability

This command was introduced before OcnOS version 1.3.

Examples

```
#configure terminal
(config)#interface eth0
(config-if)#switchport trunk native vlan 2

(config)#interface eth0
(config-if)#no switchport trunk native vlan
```

switchport mode private-vlan

Use this command to make a Layer 2 port a host port, promiscuous port, or trunk port.

Use the `no` form of this command to remove the configuration.

Command Syntax

```
switchport mode private-vlan (host | promiscuous)
no switchport mode private-vlan
```

Parameters

<code>host</code>	This port type can communicate with all other host ports assigned to the same community VLAN, but it cannot communicate with the ports in the same isolated VLAN. All communications outside of this VLAN must pass through a promiscuous port in the associated primary VLAN.
<code>promiscuous</code>	A promiscuous port can communicate with all interfaces, including the community and isolated ports within a private VLAN

Default

By default, `switchport mode private-vlan` is `host`.

Command Mode

Interface mode

Applicability

This command was introduced before OcnOS version 1.3 and changed in OcnOS version 3.0.

Example

```
#configure terminal
(config)#interface eth0
(config-if)#switchport mode private-vlan host
(config)#interface eth1
(config-if)#switchport mode private-vlan promiscuous
(config)#interface eth2
(config-if)#no switchport mode private-vlan
```

switchport private-vlan association-trunk

Use this command to associate primary vlan and secondary vlan under "switchport mode trunk" and "switchport mode private-vlan host".

Note: Each secondary VLAN on a host trunk port must be associated with a different primary VLAN. User cannot put two secondary VLANs that are associated with the same primary VLAN on a host trunk port. Each secondary vlan on the same port has to have the same type, ie isolated or community, there cannot be mixed type.

Use the no form of this command to remove the association.

Command Syntax

```
switchport private-vlan association-trunk VLAN_ID VLAN_ ID
no switchport private-vlan association-trunk VLAN_ ID VLAN_ ID
no switchport private-vlan association-trunk
```

Parameters

VLAN_ ID VLAN ID 2-4094

Command Mode

Interface mode

Applicability

This command was introduced in OcNOS version 5.1.

Example

```
#configure terminal
(config)#interface xe2
(config-if)#speed 10g
(config-if)#switchport
(config-if)#bridge-group 1
(config-if)#switchport mode trunk
(config-if)#switchport trunk allowed vlan add 10 20
(config-if)#switchport mode private-vlan host
(config-if)#switchport private-vlan association-trunk 100 10
(config-if)#switchport private-vlan association-trunk 200 20
(config-if)#no switchport private-vlan association-trunk 100 10
(config-if)#no switchport private-vlan association-trunk
```

switchport private-vlan host-association

Use this command to associate a primary VLAN and a secondary VLAN to a host port. Only one primary and secondary VLAN can be associated to a host port.

Use the `no` form of this command to remove the association.

Command Syntax

```
switchport private-vlan host-association <2-4094> add <2-4094>
no switchport private-vlan host-association
```

Parameters

<2-4094>	VLAN identifier of the primary VLAN.
add	Adds the secondary VLAN.
<2-4094>	VLAN identifier of the secondary VLAN (either isolated or community).

Default

By default, switchport mode private-vlan value is 1

Command Mode

Interface mode

Applicability

This command was introduced before OcnOS version 1.3.

Example

```
#configure terminal
(config)#interface eth0
(config-if)#switchport private-vlan host-association 2 add 3

#configure terminal
(config)#interface eth0
(config-if)#no switchport private-vlan host-association
```

switchport private-vlan mapping

Use this command to associate a primary VLAN and a set of secondary VLANs to a promiscuous port.

Use the `no` form of this to remove all the association of secondary VLANs to primary VLANs for a promiscuous port.

Command Syntax

```
switchport private-vlan mapping <2-4094> add VLAN_ID
switchport private-vlan mapping <2-4094> remove VLAN_ID
no switchport private-vlan mapping
```

Parameters

<2-4094>	VLAN identifier of the primary VLAN.
add	Adds the secondary VLAN.
remove	Removes the secondary VLAN.
VLAN_ID	VLAN identifier <2-4094> of the secondary VLAN (either isolated or community).

Default

By default, switchport mode private-vlan mapping value is 1

Command Mode

Interface mode

Applicability

This command was introduced before OcnOS version 1.3.

Example

```
#configure terminal
(config)#interface eth0
(config-if)#switchport private-vlan mapping 2 add 3-4
(config-if)#switchport private-vlan mapping 2 remove 3-4

(config-if)#no switchport private-vlan mapping
```

feature vlan classifier

Use this command to enable the feature VLAN classifier.

Use `no` form of this command to disable the feature VLAN classifier.

Command Syntax

```
feature vlan classifier
no feature vlan classifier
```

Parameters

```
classifier      VLAN Classifier Service
```

Default

By default, feature vlan classifier is enable

Command Mode

Configure mode

Applicability

This command was introduced before OcNOS version 1.3.

Example

```
#configure terminal
(config)#feature vlan classifier
(config)#no feature vlan classifier
```

vlan classifier activate

Use this command to activate the VLAN classifier.

Use no form of this command to deactivate the VLAN classifier.

Command Syntax

```
vlan classifier activate <1-16> vlan <2-4096>
no vlan classifier activate <1-16>
```

Parameters

<1-16>	Indicates the VLAN classifier activate identifier.
<2-4094>	VLAN identifier of the primary VLAN.

Default

By default, vlan classifier activate value is 1

Command Mode

Interface mode

Applicability

This command was introduced before OcnOS version 1.3.

Example

```
#configure terminal
(config)#interface eth2
(config-if)#vlan classifier activate 1 vlan 2

(config-if)#no vlan classifier activate 1
```

vlan classifier group

Use this command to create a subnet-based VLAN classifier group. A group indicates a VLAN classifier group ID.

Command Syntax

```
vlan classifier group <1-16> (add | delete) rule <1-256>
no vlan classifier group <1-16>
```

Parameters

add	Adds a rule to a group.
delete	Deletes a rule from a group.
rule	Indicates the VLAN classifier rule identifier <1-256>.

Default

By default, vlan classifier group value is 1

Command Mode

Configure mode

Applicability

This command was introduced before OcnOS version 1.3.

Example

```
#configure terminal
(config)#vlan classifier group 1 delete rule 1
(config)#no vlan classifier group 1
```

vlan classifier rule ipv4

Use this command to create a subnet-based VLAN classifier rule and map it to a specific VLAN.

Use this command to create a MAC-based VLAN classifier rule and map it to a specific VLAN. If the source IP address matches the IP subnet specified in the VLAN classifier rule, received packets are mapped to the designated VLAN.

Command Syntax

```
vlan classifier rule <1-256> ipv4 A.B.C.D/M
no vlan classifier rule <1-256>
```

Parameters

A.B.C.D/M Indicates the IPv4 address classification. Enter the address in A.B.C.D/M format.

Default

By default, vlan classifier rule is VLAN1

Command Mode

Configure mode

Applicability

This command was introduced before OcnOS version 1.3.

Example

```
#configure terminal
(config)#vlan classifier rule 2 ipv4 20.20.20.2/24
(config)#no vlan classifier rule 2
```

vlan classifier rule mac

Use this command to create a MAC-based VLAN classifier rule and map it to a specific VLAN.

If the source MAC address matches the MAC specified in the VLAN classifier rule, received packets are mapped to the designated VLAN.

Command Syntax

```
vlan classifier rule <1-256> mac WORD
no vlan classifier rule <1-256>
```

Parameters

WORD MAC Address in HHHH.HHHH.HHHH format.

Default

By default, vlan classifier rule value is VLAN1

Command Mode

Configure mode

Applicability

This command was introduced before OcnOS version 1.3.

Example

```
#configure terminal
(config)##vlan classifier rule 2 mac 00D0.2331.AA1C
(config)#no vlan classifier rule 2
```

vlan classifier rule proto

Use this command to create an Ethertype-based VLAN classifier rule for a protocol and map it to a specific VLAN. If the source Ethertype matches the Ethertype specified in the VLAN classifier rule, received packets are mapped to the designated VLAN.

Command Syntax

```
vlan classifier rule <1-256> proto
  (ETHERTYPE|ip|x25|arp|g8bpqx25|ieeepup|ieeeaddrtrans|dec|decnadamload|decnare
  moteconsole|decnارouting|declat|decdiagnostics|rarp|atalkddp|atalkaarp|ipx|ipv6
  |atmmulti|pppdiscovery|pppsession|atmtransport)
no vlan classifier rule <1-256>
```

Parameters

ETHERTYPE	Specify an Ethernet protocol number (0x600-0xFFFF)
arp	Address Resolution Protocol (0x0806)
atalkaarp	Appletalk AARP (0x80F3)
atalkddp	Appletalk DDP (0x809B)
atmmulti	MultiProtocol Over ATM (0x884c)
atmtransport	Frame-based ATM Transport (0x8884)
dec	DEC Assigned (0x6000)
decdiagnostics	DEC Diagnostics (0x6005)
decnadamload	DEC DNA Dump/Load (0x6001)
decnaremoteconsole	DEC DNA Remote Console (0x6002)
decnارouting	DEC DNA Routing (0x6003)
declat	DEC LAT (0x6004)
g8bpqx25	G8BPQ AX.25 (0x08FF)
ieeaddrtrans	Xerox IEEE802.3 PUP Address Translation (0x0a01)
ieeepup	Xerox IEEE802.3 PUP (0x0a00)
ip	IP (0x0800)
ipv6	IPv6 (0x86DD)
ipx	IPX (0x8137)
pppdiscovery	PPPoE discovery (0x8863)
pppsession	PPPoE session (0x8864)
rarp	Reverse Address Resolution Protocol (0x8035)
x25	CCITT X.25 (0x0805)

Default

By default, vlan classifier rule value is VLAN1

Command Mode

Configure mode

Applicability

This command was introduced before OcnOS version 1.3.

Example

```
#configure terminal
(config)#vlan classifier rule 2 proto ip
(config)#no vlan classifier rule 2
(config)#vlan classifier rule 3 proto 0x0805
(config)#no vlan classifier rule 3
```

vlan database

Use this command to enter the VLAN configuration mode to add, delete, or modify values associated with a single VLAN.

Command Syntax

```
vlan database
```

Parameters

None

Default

No default value is specified

Command Mode

Configure mode

Applicability

This command was introduced before OcNOS version 1.3.

Example

In the following example, note the change to VLAN configuration mode from Configure mode:

```
#configure terminal
(config)#vlan database
(config-vlan)#
```

vlan VLAN_RANGE bridge

This command allows you to create a single/range of VLAN's on the VLAN aware bridges.

Use the no form of this command to delete the VLAN.

Command Syntax

```
vlan VLAN_RANGE bridge <1-32>
vlan <2-4094> bridge <1-32> (state (enable|disable)|)
vlan VLAN_RANGE bridge <1-32> (name WORD|) state (enable | disable)
no vlan VLAN_RANGE bridge <1-32>
```

Parameters

VLAN_RANGE	The vlan-id or range of vlan-id's separated by ','&'-'
bridge	Specify the bridge group ID in the range <1-32>.
state	Indicates the operational state of the VLAN.
enable	Sets VLAN into an enable state.
disable	Sets VLAN into a disable state.

Default

By default, vlan bridge state is disabled

Command Mode

Configuration Mode

VLAN Configuration mode

Applicability

This command was introduced before OcnOS version 1.3.

Examples

```
(config)#vlan 3-40,56 bridge 4
(config)#no vlan 2-5 bridge 2
```

vlan VLAN_RANGE type customer

This command allows you to create a single/range of VLAN's of the type Customer VLAN in Provider Edge bridges.

Use the `no` form of this command to delete the VLAN.

Command Syntax

```
vlan VLAN_RANGE (type (customer)|) bridge <1-32> (name WORD|) (state
(disable|enable)|)
no vlan VLAN_RANGE type (customer) bridge <1-32>
no vlan VLAN_RANGE bridge <1-32>
```

Parameters

VLAN_RANGE	VLAN ID 2-4094 or range(s): 2-5,10 or 2-5,7-19
bridge	Specify the bridge group ID in the range <1-32>.
WORD	The ascii name of the VLAN
state	Indicates the operational state of the VLAN.
enable	Sets VLAN into an enable state.
disable	Sets VLAN into a disable state.
customer	Customer VLAN

Default

By default, vlan customer state is disabled

Command Mode

Configuration Mode

VLAN Configuration mode

Applicability

This command was introduced before OcnOS version 1.3.

Examples

```
(config-vlan)#vlan 15 type customer bridge 1 name abcde state enable
(config-vlan)#vlan 2-10,15 type customer bridge 1 state enable
(config-vlan)#no vlan 2-10,15 type customer bridge 1
(config-vlan)#
(config)#no vlan 2-10,15 br 1
(config)#end
#
```

vlan VLAN_RANGE type service

This command allows you to create a single/range of VLAN's of the type Service VLAN in Provider Edge & provider network bridges.

Use the no form of this command to delete the VLAN.

Command Syntax

```
vlan VLAN_RANGE type service (point-point|multipoint-multipoint|rooted-multipoint)
  bridge <1-32> (state (disable|enable)|)

vlan VLAN_RANGE type service (point-point|multipoint-multipoint|rooted-multipoint)
  bridge <1-32> name WORD (state (disable|enable)|)

no vlan VLAN_RANGE type service bridge <1-32>
```

Parameters

VLAN_RANGE	VLAN ID 2-4094 or range(s): 2-5,10 or 2-5,7-19
service	service VLAN
multipoint-multipoint	Service Multipoint to Multipoint Service VLAN
point-point	Service Point-to-Point Service VLAN
rooted-multipoint	Service Rooted Multipoint Service VLAN
bridge	Specify the bridge group ID in the range <1-32>.
WORD	The ascii name of the VLAN
state	Operational state of the VLAN
disable	Disable VLAN status on the bridge
enable	Enable VLAN status on the bridge

Default

By default, with the name WORD this can only be given in "vlan database" mode.

Command Mode

Configuration Mode

VLAN Configuration mode

Applicability

This command was introduced before OcnOS version 1.3.

Examples

```
(config)#vlan database
(config-vlan)#vlan 100 type service multipoint-multipoint bridge 1 name xxxx
state enable
(config-vlan)#vlan 101 type service point-point bridge 1 name afsa state
disable
```



```
(config-vlan)#vlan 102 type service rooted-multipoint bridge 1 state enable
(config)#vlan 104-107 type service multipoint-multipoint bridge 1 state enable
(config)#vlan 114-117,119 type service multipoint-multipoint bridge 1 state
enable
(config)#vlan 124-127,129 type service point-point bridge 1 state enable
(config)#no vlan 114-117,119 type service br 1
```

CHAPTER 9 802.1x Commands

This chapter describes the 802.1X commands.

- `auth-mac`
- `auth-mac mode`
- `auth-mac system-auth-ctrl`
- `auth-port`
- `debug dot1x`
- `dot1x mac-auth-bypass`
- `dot1x port-control`
- `dot1x protocol-version`
- `dot1x quiet-period`
- `dot1x reauthentication`
- `dot1x reauthMax`
- `dot1x system-auth-ctrl`
- `dot1x timeout re-authperiod`
- `dot1x timeout server-timeout`
- `dot1x timeout supp-timeout`
- `dot1x timeout tx-period`
- `ip radius source-interface`
- `key-string`
- `key-string encrypted`
- `radius-server dot1x host`
- `retransmit`
- `show debugging dot1x`
- `show dot1x`
- `show mab all`
- `timeout`

auth-mac

Use this command to enable MAC based authentication standalone on the interface level.

Use the `no` form of this command to disable/remove the auth-MAC from interface level.

Command Syntax

```
auth-mac
no auth-mac
```

Parameters

None.

Default

Command message will not be displayed and disabled.

Command Mode

Interface mode

Applicability

This command was introduced before OcNOS version 1.3.

Example

```
#configure terminal
(config)#interface eth0
(config-if)#auth-mac
(config-if)#commit
```

```
#configure terminal
(config)#interface eth0
(config-if)#no auth-mac
(config-if)#commit
(config-if)#end
```

auth-mac mode

Use this command to enable MAC authentication mode on an interface.

Use the `no` parameter with this command to disable MAC authentication mode on an interface.

Command Syntax

```
auth-mac mode (filter|shutdown)
no auth-mac mode
```

Parameters

<code>filter</code>	Filter the frames for the MAC when in an unauthorized state.
<code>shutdown</code>	Shut down the interface when the MAC is unauthenticated.

Default

No default value is specified.

Command Mode

Interface mode

Applicability

This command was introduced before OcnOS version 1.3.

Example

```
#configure terminal
(config)#interface eth0
(config-if)#auth-mac mode filter
(config-if)#commit

#configure terminal
(config)#interface eth0
(config-if)#no auth-mac mode
(config-if)#commit
```

auth-mac system-auth-ctrl

Use this command to enable MAC authentication globally. If MAC authentication is not enabled, other MAC authentication related commands throw an error when issued.

Use the `no` parameter with this command to disable MAC authentication globally.

Command Syntax

```
auth-mac system-auth-ctrl
no auth-mac system-auth-ctrl
```

Parameters

None

Default

Authentication system messages are not displayed.

Command Mode

Configure mode

Applicability

This command was introduced before OcNOS version 1.3.

Examples

```
#configure terminal
(config)#auth-mac system-auth-ctrl

(config)#no auth-mac system-auth-ctrl
```

auth-port

Use this command to specify a port for Radius authentication.

Use the `no` parameter with this command to disable this feature.

Command Syntax

```
auth-port <1-65535>
no auth-port
```

Parameters

<0-65535> Port number.

Default

The default port number is 1812.

Command Mode

Configure Radius server mode

Applicability

This command was introduced in OcNOS version 6.0.0.

Examples

```
#configure terminal
(config)#radius-server dot1x host 1.1.1.1
(config-radius-server)#auth-port 1233
(config-radius-server)#no auth-port
```

debug dot1x

Use this command to turn on or turn off 802.1x debugging at various levels.

Use the `no` parameter with this command to turn off debugging.

Command Syntax

```
debug dot1x (all|)
debug dot1x event
debug dot1x nsm
debug dot1x packet
debug dot1x timer
no debug dot1x (all|)
no debug dot1x event
no debug dot1x nsm
no debug dot1x packet
no debug dot1x timer
```

Parameters

<code>all</code>	Sets debugging for all 802.1x levels.
<code>event</code>	Sets debugging for 802.1x events.
<code>nsm</code>	Sets debugging for 802.1x NSM information.
<code>packet</code>	Sets debugging for 802.1x packets.
<code>timer</code>	Sets debugging for 802.1x timer.

Default

No default value is specified.

Command Mode

Exec, Privileged Exec, and Configure modes

Applicability

This command was introduced before OcnOS version 1.3.

Examples

```
#configure terminal
(config)#debug dot1x all
(config)#debug dot1x event
```

dot1x mac-auth-bypass

Use this command allows you to enable/disable MAC-authentication-bypass as fallback on the interface level which has dot1x configured.

Use the `no` form of this command to remove the MAC-auth-bypass.

Command Syntax

```
dot1x mac-auth-bypass (enable|disable)
no dot1x mac-auth-bypass
```

Parameters

<code>dot1x</code>	IEEE 802.1X Port-Based Access Control
<code>mac-auth-bypass</code>	
	Quiet period in the HELD state (default 60 sec)
<code>disable</code>	Disable MAC authentication bypass
<code>enable</code>	Enable MAC authentication bypass

Default

Command message will not be displayed and disabled.

Command Mode

Interface mode

Applicability

This command was introduced before OcNOS version 5.0

Examples

```
#conf t
Enter configuration commands, one per line.  End with CNTL/Z.
(config)#int xe10
(config-if)#dot1x mac-auth-bypass enable
(config-if)#commit
(config-if)#
(config-if)#no dot1x mac-auth-bypass
(config-if)#commit
(config-if)#end
```

dot1x port-control

Use this command to force a port state.

Use the `no` parameter with this command to remove a port from the 802.1x management.

Command Syntax

```
dot1x port-control (force-unauthorized|force-authorized|auto)
no dot1x port-control
```

Parameters

<code>auto</code>	Specify to enable authentication on port.
<code>force-authorized</code>	Specify to force a port to always be in an authorized state.
<code>force-unauthorized</code>	Specify to force a port to always be in an unauthorized state.

Default

The dot1x port-control default is active.

Command Mode

Interface mode

Applicability

This command was introduced before OcNOS version 1.3.

Examples

```
#configure terminal
(config)#interface eth0
(config-if)#dot1x port-control auto

(config)#interface eth0
(config-if)#no dot1x port-control
```

dot1x protocol-version

Use this command to set the protocol version of dot1x to 1 or 2. The protocol version must be synchronized with the Xsupplicant being used in that interface.

Use the `no` parameter with this command to set the protocol version to the default value (2).

Command Syntax

```
dot1x protocol-version <1-2>
no dot1x protocol-version
```

Parameters

<1-2> Indicates the EAP Over LAN (EAPOL) version.

Default

The default dot1x protocol version is 2.

Command Mode

Interface mode

Applicability

This command was introduced before OcNOS version 1.3.

Example

```
#configure terminal
(config)#interface eth0
(config-if)#dot1x protocol-version 2

(config)#interface eth0
(config-if)#no dot1x protocol-version
```

dot1x quiet-period

Use this command to set the quiet-period time interval.

When a switch cannot authenticate a client, the switch remains idle for a quiet-period interval of time, then tries again. By administratively changing the quiet-period interval, by entering a lower number than the default, a faster response time can be provided.

Use the `no` parameter with this command to set the configured quiet period to the default (60 seconds).

Command Syntax

```
dot1x quiet-period <1-65535>
no dot1x quiet-period
```

Parameter

<1-65535> Seconds between the retrieval of authentication.

Default

The default dot1x quiet-period is 60.

Command Mode

Interface mode

Applicability

This command was introduced before OcnOS version 1.3.

Example

```
#configure terminal
(config)#interface eth0
(config-if)#dot1x quiet-period 200
```

dot1x reauthentication

Use this command to enable reauthentication on a port.

Use the `no` parameter to disable reauthentication on a port.

Command Syntax

```
dot1x reauthentication
no dot1x reauthentication
```

Parameters

None

Default

The dot1x reauthentication default is disabled.

Command Mode

Interface mode

Applicability

This command was introduced before OcNOS version 1.3.

Examples

```
#configure terminal
(config)#interface eth0
(config-if)#dot1x reauthentication
```

dot1x reauthMax

Use this command to set the maximum reauthentication value, which sets the maximum number of reauthentication attempts after which the port will be unauthorized.

Use the `no` parameter with this command to set the reauthentication maximum to the default value (2).

Command Syntax

```
dot1x reauthMax <1-10>
no dot1x reauthMax
```

Parameter

<1-10>	Indicates the maximum number of reauthentication attempts after which the port will be unauthorized.
--------	--

Default

The default is 2.

Command Mode

Interface mode

Applicability

This command was introduced before OcnOS version 1.3.

Examples

The following sets the maximum reauthentication value to 5.

```
#configure terminal
(config)#interface eth0
(config-if)#dot1x reauthMax 5
```

The following sets the reauthentication maximum to the default value.

```
#configure terminal
(config)#interface eth0
(config-if)#no dot1x reauthMax
```

dot1x system-auth-ctrl

Use this command to enable globally authentication.

Use the `no` parameter to disable globally authentication.

Command Syntax

```
dot1x system-auth-ctrl
no dot1x system-auth-ctrl
```

Parameters

None

Default

Authentication is off by default.

Command Mode

Configure mode

Applicability

This command was introduced before OcNOS version 1.3.

Example

```
#configure terminal
(config)#dot1x system-auth-ctrl
```

dot1x timeout re-authperiod

Use this command to set the interval between reauthorization attempts.

Use the `no` parameter to disable the interval between reauthorization attempts.

Command Syntax

```
dot1x timeout re-authperiod <1-4294967295>
no dot1x timeout re-authperiod
```

Parameter

<1-4294967295> Specify the seconds between reauthorization attempts.

Default

Default time is 3600 seconds

Command Mode

Interface mode

Applicability

This command was introduced before OcNOS version 1.3.

Example

```
#configure terminal
(config)#interface eth0
(config-if)#dot1x timeout re-authperiod 25
```

dot1x timeout server-timeout

Use this command to set the authentication sever response timeout.

Use the `no` parameter to disable the authentication sever response timeout.

Command Syntax

```
dot1x timeout server-timeout <1-65535>
no dot1x timeout server-timeout
```

Parameter

<1-65535> Specify the authentication server response timeout.

Default

Default timeout is 30 seconds.

Command Mode

Interface mode

Applicability

This command was introduced before OcNOS version 1.3.

Examples

```
#configure terminal
(config)#interface eth0
(config-if)#dot1x timeout server-timeout 555

(config)#interface eth0
(config-if)#no dot1x timeout server-timeout
```

dot1x timeout supp-timeout

Use this command to set the interval for a supplicant to respond.

Use the `no` parameter to disable the authentication sever response timeout.

Command Syntax

```
dot1x timeout supp-timeout <1-65535>
no dot1x timeout supp-timeout
```

Parameter

<1-65535> Specify the authentication server response timeout.

Default

Default timeout is 30 seconds.

Command Mode

Interface mode

Applicability

This command was introduced before OcNOS version 1.3.

Example

```
#configure terminal
(config)#interface eth0
(config-if)#dot1x timeout supp-timeout 40

(config)#interface eth0
(config-if)#no dot1x timeout supp-timeout
```

dot1x timeout tx-period

Use this command to set the interval between successive attempts to request an ID.

Use the `no` parameter to disable the interval between successive attempts to request an ID.

Command Syntax

```
dot1x timeout tx-period <1-65535>
no dot1x timeout tx-period
```

Parameter

<1-65535> Specify the authentication server response timeout.

Default

Default timeout is 30 seconds.

Command Mode

Interface mode

Applicability

This command was introduced before OcNOS version 1.3.

Examples

```
#configure terminal
(config)#interface eth0
(config-if)#dot1x timeout tx-period 34

(config)#interface eth0
(config-if)#no dot1x timeout tx-period
```

ip radius source-interface

Use this command to set the local address sent in packets to the radius server.

Use the `no` parameter to clear the local address.

Command Syntax

```
ip radius source-interface A.B.C.D <1-65535>
no ip radius source-interface
```

Parameters

A.B.C.D	IPv4 address of the RADIUS server.
<1-65535>	Port number.

Default

The default port number is 1812.

Command Mode

Configure mode

Applicability

This command was introduced before OcnOS version 1.3.

Examples

```
#configure terminal
(config)#ip radius source-interface 12.12.12.1 1812
(config)#no ip radius source-interface
```

key-string

Use this command to define a password in plain text.

The password is stored as encrypted and is displayed in encrypted text when the `show running-config` command is executed.

Use the `no` parameter with this command to disable this feature.

Command Syntax

```
key-string WORD
no key-string
```

Parameter

`WORD` A string of characters to use as a password (1-64 characters).

Default

By default, the password is not configured.

Command Mode

Configure Radius server mode

Applicability

This command was introduced in OcNOS version 6.0.0.

Examples

```
#configure terminal
(config)#radius-server dot1x host 1.1.1.1
(config-radius-server)#key-string 1234567890
(config-radius-server)#no key-string
```

key-string encrypted

Use this command to define a password in encrypted format.

Use the `no` parameter with this command to disable this feature.

Command Syntax

```
key-string encrypted WORD
no key-string
```

Parameter

`WORD` A string of characters to use as a password (18-130 characters).

Default

By default, password is not configured.

Command Mode

Configure Radius server mode

Applicability

This command was introduced in OcNOS version 6.0.0.

Examples

```
#configure terminal
(config)#radius-server dot1x host 1.1.1.1
(config-radius-server)#key-string encrypted 0x16176d21cc1688d995
(config-radius-server)#no key-string
```

radius-server dot1x host

Use this command to specify the IP address of the remote radius server host and assign authentication and accounting destination port numbers. Multiple radius-server host commands can be used to specify multiple hosts. The software searches for hosts in the order they are specified.

If no host-specific [auth-port](#), [timeout](#), [retransmit](#), [key-string](#), or [key-string encrypted](#) values are specified, the global default values apply to that host.

Use the `no` form of the command to unconfigure a specified radius-server.

Command Syntax

```
radius-server dot1x host (A.B.C.D)
no radius-server dot1x host (A.B.C.D)
```

Parameters

<code>dot1x</code>	IEEE 802.1X Port-Based Access Control.
<code>A.B.C.D</code>	IPv4 address of the RADIUS server.

Default

The default value of `auth-port` is 1812.

Command Mode

Configure mode

Applicability

This command was introduced before OcnOS version 1.3.

Examples

```
#configure terminal
(config)#radius-server dot1x host 1.1.1.1
(config-radius-server)#
(config)#no radius-server dot1x host 1.1.1.1
```

retransmit

Use this command to specify the number of times to transmit each Radius request to the server before giving up.

Use the `no` form of this command to disable retransmission.

Command Syntax

```
retransmit <0-100>
no retransmit
```

Parameter

<0-100> Number of times to transmit each Radius request (0-100).

Default

The default value is 3.

Command Mode

Configure Radius server mode

Applicability

This command was introduced in OcNOS version 6.0.0.

Examples

```
#configure terminal
(config)#radius-server dot1x host 1.1.1.1
(config-radius-server)#retransmit 12
(config-radius-server)#no retransmit
```

show debugging dot1x

Use this command to display the status of the debugging of the 802.1x system.

Command Syntax

```
show debugging dot1x
```

Parameters

None

Command Mode

Privileged Exec mode

Applicability

This command was introduced in OcNOS version 6.0.0.

Example

```
#show debugging dot1x  
802.1X debugging status:
```

show dot1x

Use this command to display the state of the whole system.

Command Syntax

```
show dot1x
show dot1x all
show dot1x host
show dot1x diagnostics interface IFNAME
show dot1x interface IFNAME
show dot1x sessionstatistics (interface IFNAME|)
show dot1x statistics interface IFNAME
```

Parameters

all	Display all information.
host	Show operational radius-server dot1x host information for a specific host (IPv4 address) or for all hosts.
diagnostics	Display diagnostics information.
interface	Display diagnostics interface information.
interface	Display interface information.
sessionstatistics	Display session statistics.
interface	Display session statistics interface information.
statistics	Display statistics information.
interface	Display statistics interface information.

Command Mode

Exec mode and Privileged Exec mode

Applicability

This command was introduced before OcNOS version 1.3.

Displayed Output

The following tables describes the output for the show dot1x all command and the show dot1x interface command.

Table 9-24: Port variables

Entry	Description
portEnabled	Interface operational status (Up-true/down-false)
portControl	Current control status of the port for 802.1x control
portStatus	802.1x status of the port (authorized/unauthorized)

Table 9-24: Port variables

Entry	Description
reAuthenticate	Reauthentication enabled/disabled status on port
reAuthPeriod	Value holds meaning only if reAuthentication is enabled

Table 9-25: Supplicant PAE related global variables

Entry	Description
abort	Indicates that authentication should be aborted when set to true
fail	Indicates failed authentication attempt when set to false
start	Indicates authentication should be started when set to true
timeout	Indicates authentication attempt timed out when set to true
success	Indicates authentication successful when set to true

Table 9-26: 802.1x Operational State of Interface

Entry	Description
mode	Configured 802.1x mode
reAuthCount	Reauthentication count
quietperiod	Time between reauthentication attempts
reAuthMax	Maximum reauthentication attempts

Table 9-27: Backend Authentication state machine variables and constants

Entry	Description
state	State of the state machine
reqCount	Count of requests sent to server
suppTimeout	Supplicant timeout
serverTimeout	Server timeout
maxReq	Maximum requests to be sent

Table 9-28: Controlled Directions State machine

Entry	Description
adminControlledDirections	Administrative value (Both/In)

Table 9-28: Controlled Directions State machine

Entry	Description
operControlledDirections	Operational Value (Both/In)

Table 9-29: KR -- Key receive state machine

Entry	Description
rxKey	True when EAPOL-Key message is received by supplicant or authenticator. false when key is transmitted

Table 9-30: Key Transmit State machine

Entry	Description
keyAvailable	False when key has been transmitted by authenticator, true when new key is available for key exchange
keyTxEnabled	Key transmission enabled/disabled status

Applicability

This command was introduced before OcNOS version 1.3.

Example

The following is an output of this command displaying the state of the system.

```
#show dot1x
% 802.1x authentication enabled
% Radius server address: 192.168.1.1.1812
% Radius client address: dhcp128.mySite.com.12103
% Next radius message id: 0
```

The following is an output of this command displaying detailed information for all ports.

```
#show dot1x all
% 802.1x authentication enabled
% Radius server address: 192.168.1.1.1812
% Radius client address: dhcp128.mySite.com.12103
% Next radius message id: 0
% Dot1x info for interface eth1 - 3
% portEnabled: true - portControl: auto
% portStatus: unauthorized - currentId: 11
% reAuthenticate: disabled
% abort:F fail:F start:F timeout:F success:F
% PAE: state: connecting - portMode: auto
% PAE: reAuthCount: 2 - rxRespId: 0
% PAE: quietPeriod: 60 - reauthMax: 2 - txPeriod: 30
% BE: state: idle - reqCount: 0 - idFromServer: 0
% BE: suppTimeout: 30 - serverTimeout: 30 - maxReq: 2
% CD: adminControlledDirections: in - operControlledDirections: in
% CD: bridgeDetected: false
```

```
% KR: rxKey: false
% KT: keyAvailable: false - keyTxEnabled: false
```

show mab all

Use this command to display the DOT1x timer, MAB status enabled/disabled port status (authorized/unauthorized) and last rejected MAC (if any).

Command Syntax

```
show mab all
```

Parameters

None

Default

NA

Command Mode

Exec mode and Privileged Exec mode

Applicability

This command was introduced before OcNOS version 5.0

Examples

```
#sh mab all
Global MAC Authentication Enabled
RADIUS client address: not configured
```

```
MAB info for interface xe10
Dot1x timer: Expired
MAB Authentication Enabled
Status: Unauthorized
Last rejected MAC:
```

```
MAB info for interface xe11
Dot1x timer: Expired
MAB Authentication Disabled
Status: Unknown
Last rejected MAC:
```

timeout

Use this command to specify the number of seconds a router waits for a reply to a Radius request before retransmitting the request.

Use the `no` parameter to use the default value.

Command Syntax

```
timeout <0-60>
no timeout
```

Parameter

<0-60> Timeout period in seconds.

Default

The default value is 5 seconds.

Command Mode

Configure Radius server mode

Applicability

This command was introduced in OcNOS version 6.0.0.

Examples

```
#configure terminal
(config)#radius-server dot1x host 1.1.1.1
(config-radius-server)#timeout 20
(config-radius-server)#no timeout
```

CHAPTER 10 Layer 2 Subinterface Commands

This chapter is a reference for the Layer 2 subinterface commands.

- [bridge-domain](#)
- [cross-connect](#)
- [dot1ad ethertype](#)
- [encapsulation](#)
- [interface switchport](#)
- [no subinterfaces](#)
- [rewrite](#)
- [show bridge-domain](#)
- [show cross-connect](#)

bridge-domain

Use this command to configure bridge-domain and attached sub-interfaces to it.

Use the `no` form of this command to remove the configured bridge-domain.

Command Syntax

```
bridge-domain < bridge domain id >  
no bridge-domain <bridge-domain id>
```

Parameters

<1-2147483647> bridge domain id

Default

None

Command Mode

Configure mode

Applicability

This command was introduced in OcNOS version 3.0.

Example

```
(config)#bridge-domain 1  
(config-bridge-domain)#interface xe10.1  
(config-bridge-domain)#interface xe11.1  
(config-bridge-domain)#exit  
(config)#commit
```

cross-connect

Use this command to create an AC-to-AC cross-connect between the L2 subinterfaces. It creates a separate mode with endpoint1 and endpoint2 being L2 subinterfaces. It is possible to bind L2 subinterface to cross-connect only when encapsulation is configured on it.

Use the `no` form of this command to remove the given cross-connect.

Command Syntax

```
cross-connect <WORD> (interface <IFNAME>) (interface <IFNAME>) (description)
(disable)
no cross-connect <WORD>
```

Parameters

WORD	XC name
IFNAME	AC interface name
description	Characters describing AC cross-connect
disable	disables the cross-connect

Default

None

Command Mode

Configure mode for cross-connect

Cross-connect mode for IFNAME, description and disable

Applicability

This command was introduced in OcNOS version 3.0.

Example

```
(config)#cross-connect c1
(config-xc)#interface xe1.1
(config-xc)#interface xe1.2
(config-xc)#description XC1
(config-xc)#disable
(config-xc)#exit
(config)#no cross-connect c1
(config)#
```

dot1ad ethertype

Use this command to configure the service-tpid value on parent port of a subinterface. By this the tpid used for service tag for a sub-interface may be inherited from the one applied to parent interface.

Use `no` form of this command to revert the value to default.

Note:

- For any dot1ad sub-interface to be functional, `dot1ad ethertype` should be set to desired value as 0x88a8/0x9100/0x9200.
- The `dot1ad ethertype` command is not allowed on MLAG interfaces. Instead, configure this command on a mapped LAG interface.

Command Syntax

```
dot1ad ethertype (0x8100 | 0x88a8 | 0x9100 | 0x9200)
no dot1ad ethertype
```

Parameters

0x8100	IEEE 802.1Q VLAN-tagged frame
0x88a8	IEEE 802.1ad Provider Bridging Service VLAN tag identifier (S-Tag)
0x9100	Supported for interoperability with legacy devices
0x9200	Supported for interoperability with legacy devices

Default

Default value is 0x8100

Command Mode

Interface mode

Applicability

This command was introduced in OcNOS version 3.0.

Example

```
(config)#interface xe1
(config-if)#dot1ad ethertype 0x9100
(config-if)#exit
(config)#interface xe1
(config-if)#no dot1ad ethertype
(config-if)#exit
```

encapsulation

Use this command to configure encapsulation-type for a Layer 2 subinterface. With this command, a Layer 2 subinterface can be configured as single-tagged with single/multiple VLANs or double-tagged, or default or untagged. Operational state of the Layer 2 subinterface is DOWN before configuring the encapsulation and it becomes UP once the encapsulation is configured.

Use the `no` form of this command to remove the encapsulation.

Note:

- For encapsulation with a VLAN range in an inner tag or outer tag, overlapping VLANs either as a single value or a range will not be allowed under same parent port.
- Y.1731 and CFM are not supported on the same physical port when sub-interfaces are configured with untagged encapsulation and default settings.

Command Syntax

```
encapsulation ((dot1q | dot1ad | default | untagged) (vlan-id | vlanid-range)
              (inner-dot1q (vlan-id | vlanid-range)))
no encapsulation ((dot1q | dot1ad | default | untagged) (vlan-id | vlanid-range)
                 (inner-dot1q (vlan-id | vlanid-range)))
```

Parameters

<code>dot1q</code>	IEEE802.1Q VLAN-tagged packets
<code>dot1ad</code>	IEEE802.1ad VLAN-tagged packets
<code>default</code>	IEEE default packets
<code>untagged</code>	IEEE untagged packets
<code>vlan-id</code>	VLAN identifier <2-4094>
<code>vlanid-range</code>	VLAN ID range(s): 2-5 10 or 2-5 7-19
<code>inner-dot1q</code>	Inner-VLAN for double-tagged

Default

None

Command Mode

Interface mode

Applicability

This command was introduced in OcNOS version 3.0.

Inner-VLAN range support was introduced in OcNOS version 4.1.

Multiple encapsulation on a L2 subinterface introduced in OcNOS version 5.0.

The `no` form of this command with parameters introduced in OcNOS version 5.0.

Example

```
(config)#interface xe1.1 switchport
(config-if)#encapsulation dot1q 10
```

```
(config-if)#ex
(config)#interface xe1.2 switchport
(config-if)#encapsulation dot1ad 11
(config-if)#ex
(config)#interface xe1.3 switchport
(config-if)#encapsulation default
(config-if)#ex
(config)#interface xe1.4 switchport
(config-if)#encapsulation untagged
(config-if)#ex
(config)#interface xe1.5 switchport
(config-if)#encapsulation dot1q 15-20
(config-if)#ex
(config)#interface xe1.6 switchport
(config-if)#encapsulation dot1ad 21-25
(config-if)#ex
(config)#interface xe1.7 switchport
(config-if)#encapsulation dot1q 100 inner-dot1q 10
(config-if)#ex
(config)#interface xe1.8 switchport
(config-if)#encapsulation dot1ad 200 inner-dot1q 20
(config-if)#ex
(config)#interface xe1.9 switchport
(config-if)#encapsulation dot1ad 300 inner-dot1q 100-200
(config-if)#ex
(config)#interface xe1.10 switchport
(config-if)#encapsulation dot1q 3999
(config-if)#encapsulation dot1ad 3998
(config-if)#ex
(config)#interface xe1.10 switchport
(config-if)#no encapsulation
(config-if)#ex
(config)#interface xe1.1 switchport
(config-if)#no encapsulation dot1q 10
(config-if)#ex
(config)#interface xe1.2 switchport
(config-if)#no encapsulation dot1ad 11
(config-if)#ex
(config)#interface xe1.3 switchport
(config-if)#no encapsulation default
(config-if)#ex
(config)#interface xe1.4 switchport
(config-if)#no encapsulation untagged
(config-if)#ex
(config)#interface xe1.5 switchport
(config-if)#no encapsulation dot1q 15-20
(config-if)#ex
(config)#interface xe1.6 switchport
(config-if)#no encapsulation dot1ad 21-25
(config-if)#ex
```

```
(config)#interface xe1.7 switchport
(config-if)#no encapsulation dot1q 100 inner-dot1q 10
(config-if)#ex
(config)#interface xe1.8 switchport
(config-if)#no encapsulation dot1ad 200 inner-dot1q 20
(config-if)#ex
(config)#interface xe1.9 switchport
(config-if)#no encapsulation dot1ad 300 inner-dot1q 100-200
(config-if)#ex
```

interface switchport

Use this command to configure a L2 subinterface. An L2 sub-interfaces makes it possible for a logical interface to be created on an Ethernet physical interface as well as on dynamic/static LAG interfaces to handle one slice of its resource. The supported method for this resource slicing is vlan credential based which can be a single tagged or double-tagged or untagged or default along with encapsulation types as either dot1q or dot1ad.

Use `no` form of this command to unconfigure a sub-interface.

Command Syntax

```
interface IFNAME.SUBINTERFACE_ID switchport
no interface IFNAME.SUBINTERFACE_ID
```

Parameters

IFNAME	Interface name, such as xe1, po1 or sa1
SUBINTERFACE_ID	Subinterface identifier <1-2000>
switchport	L2 subinterface

Default

None

Command Mode

Configure mode

Applicability

This command was introduced in OcNOS version 3.0.

Example

```
(config)#interface xe1.1 switchport
(config-if)#exit
(config)#no interface xe1.1
(config)#interface po1.1 switchport
(config-if)#exit
(config)#no interface po1.1
(config)#interface sa1.1 switchport
(config-if)#exit
(config)#no interface sa1.1
(config)#exit
#
```

no subinterfaces

Use this command to unconfigure all the subinterfaces of any type (layer 2 or layer 3) created under a parent port.

Command Syntax

```
no subinterfaces
```

Parameters

None

Command Mode

Interface mode

Applicability

This command was introduced in OcNOS version 3.0.

Example

```
(config)#interface xe1
(config-if)#no subinterfaces
(config-if)#exit
```

rewrite

Use this command to manipulate the VLAN tags in the incoming packet. Supported operations are PUSH, DOUBLE PUSH, POP, DOUBLE POP and TRANSLATE on the VLAN tag with any of this ethertype - 8100/ 88a8/ 9100/ 9200.

Use the `no` form of this command to unconfigure rewrite.

Command Syntax

```
rewrite ((pop| push | translate (1-to-1|1-to-2|2-to-1|2-to-2) (TPID_VALUE)
(VID_RANGE))
rewrite push (TPID_VALUE) (VID_RANGE) inner-dot1q (VID_RANGE)
rewrite pop-2tag
no rewrite
```

Parameters

<code>pop</code>	Pop the outer VID
<code>push</code>	Push the outer VID
<code>translate</code>	Translate the outer VID
<code>1-to-1</code>	Translates the outermost tag to another tag
<code>1-to-2</code>	Translates the outermost tag to two tags (is translate & push)
<code>2-to-1</code>	Translates the outermost two tags to another tag
<code>2-to-2</code>	Translates the outermost two tags to two other tags
<code>TPID_VALUE</code>	Set service TPID value as 0x8100/0x88a8/0x9100/0x9200
<code>VID_RANGE</code>	<2-4094>
<code>inner-dot1q</code>	Inner-VLAN for double-tagged
<code>pop-2tag</code>	Pop both the outer VID and inner VID

Command Mode

Interface mode

Applicability

This command was introduced in OcNOS version 3.0.

Example

```
(config)#interface xe1.1 switchport
(config-if)#rewrite pop
(config-if)#exit

(config)#interface xe1.2 switchport
(config-if)#rewrite push 9100 3
(config-if)#exit

(config)#interface xe1.10 switchport
(config-if)#rewrite translate 9200 4
(config-if)#exit
```



```
(config)#interface xe1.10 switchport
(config-if)#rewrite push 0x8100 200 inner-dot1q 300
(config-if)#exit
```

```
(config)#interface xe1.1 switchport
(config-if)#rewrite pop-2tag
(config-if)#exit
(config)#interface xe1.1 switchport
(config-if)#no rewrite
(config-if)#ex
```

show bridge-domain

Use this command to display bridge-domain ID.

Command Syntax

```
show bridge-domain <bridge domain id>
```

Parameters

```
<1-2147483647>    bridge domain id
```

Command Mode

exec mode

Applicability

This command was introduced in OcNOS version 3.0.

Example

```
OcNOS#show bridge-domain
```

```
Bridge Id  interfaces          Status
-----+-----+-----
1          xe10.1                    UP
           xe11.1                    UP
OcNOS#
```

show cross-connect

Use this command to display the cross-connected subinterfaces along with their status and total number of cross-connects configured in the system.

Command Syntax

```
show cross-connect <WORD>
```

Parameters

WORD Cross-connect name

Default

None

Command Mode

Exec mode

Applicability

This command was introduced in OcNOS version 3.0.

Example

```
#show cross-connect
cross-connect status
XC name                      Ep1                      Ep2                      Status
-----+-----+-----+-----
c1                            xe1.1                    xe1.2                    UP
-----+-----+-----+-----

AC cross-connect summary
Total : 1
Up    : 1
Down  : 0
#show cross-connect c1
cross-connect status
XC name                      Ep1                      Ep2                      Status
-----+-----+-----+-----
c1                            xe1.1                    xe1.2                    UP
-----+-----+-----+-----
```

CHAPTER 11 Port Security Commands

This chapter describes the port security commands.

- [port-security](#)
- [show port-security](#)
- [switchport port-security](#)
- [switchport port-security logging](#)
- [switchport port-security mac-address](#)
- [switchport port-security maximum](#)

port-security

Use this command to enable or disable port security globally.

Command Syntax

```
port-security (enable | disable)
```

Parameters

enable	Enable port security globally
disable	Disable port security globally

Default

By default, port security is enabled globally.

Command Mode

Configure mode

Applicability

This command was introduced in OcNOS version 4.0.

Examples

```
(config)#port-security enable  
(config)#
```

show port-security

Use this command to display the port security configuration for all interfaces or for a particular interface.

Command Syntax

```
show port-security (interface IFNAME |)
```

Parameters

IFNAME	Interface name
--------	----------------

Default

None

Command Mode

Exec mode

Applicability

This command was introduced in OcNOS version 4.0.

Examples

```
#show port-security
Port port-security mode MAC limit CVLAN SVLAN static secure MAC
-----
ge1 dynamic          3          2          0000.0000.1112
                   10          0000.0000.3333
```

```
#show port-security interface ge1
Port Security Mode : Dynamic
Secure MAC limit : 3
Static Secure MAC list :
CVLAN SVLAN MAC Address
-----
2          0000.0000.1112
10         0000.0000.3333
```

switchport port-security

Use this command to enable port security on an interface.

Use the `no` form of this command to disable port security on an interface. This command removes configured secured MAC, if any, on this interface.

Note: This command is supported for physical, LAG, and MLAG (active) interfaces only. Enabling port security on an interface removes learned MAC addresses of interfaces (whether learned by static or dynamic means), and then relearns the secure MAC addresses. Multicast MAC addresses are not considered as part of the MAC learning limit.

Note: This command is ignored when port security is already enabled on an interface.

Command Syntax

```
switchport port-security (static |)
no switchport port-security
```

Parameters

<code>static</code>	Static mode
---------------------	-------------

Default

By default this feature is disabled; the default mode of port security is to dynamically learn. In dynamic mode, devices learn MAC addresses dynamically. You can program static MACs, however, dynamic MAC learning will not be allowed in static mode for port security.

Command Mode

Interface mode

Applicability

This command was introduced in OcNOS version 4.0.

Examples

```
#configure terminal
(config)#interface ge1
(config-if)#switchport
(config-if)#bridge-group 1
(config-if)#switchport mode hybrid
(config-if)#switchport hybrid allowed vlan all
(config-if)#switchport port-security
```

switchport port-security logging

Use this command to enable violated MAC logging on a port security enabled interface.

Use the `disable` parameter with this command to disable violated mac logging on a port security enabled interface.

Note: This command has no impact, as Qumran does not support unsecured MAC address logging.

Command Syntax

```
switchport port-security logging (enable | disable)
```

Parameters

<code>enable</code>	Enable violated MAC logging
<code>disable</code>	Disable violated MAC logging

Default

By default logging is disabled.

Command Mode

Interface mode

Applicability

This command was introduced in OcNOS version 4.0.

Examples

```
#configure terminal
(config)#interface ge1
(config-if)#switchport port-security logging enable
```

switchport port-security mac-address

Use this command to add static secure MAC addresses.

Use the `no` form of this command to remove static secure MAC addresses.

Command Syntax

```
switchport port-security mac-address XXXX.XXXX.XXXX
no switchport port-security mac-address XXXX.XXXX.XXXX
switchport port-security mac-address XXXX.XXXX.XXXX vlanId <2-4094>
no switchport port-security mac-address XXXX.XXXX.XXXX vlanId <2-4094>
switchport port-security mac-address XXXX.XXXX.XXXX svlanId <2-4094>
no switchport port-security mac-address XXXX.XXXX.XXXX svlanId <2-4094>
switchport port-security mac-address XXXX.XXXX.XXXX vlanId <2-4094> svlanId <2-4094>
no switchport port-security mac-address XXXX.XXXX.XXXX vlanId <2-4094> svlanId <2-4094>
```

Parameters

XXXX.XXXX.XXXX	Static secure MAC address
vlanId	VLAN identifier
<2-4094>	VLAN identifier
svlanId	SVLAN identifier
<2-4094>	SVLAN identifier

Default

N/A

Command Mode

Interface mode

Applicability

This command was introduced in OcNOS version 4.0.

Examples

```
#configure terminal
(config)#interface ge1
(config-if)#switchport port-security mac-address 0000.0000.1112 vlan 2
(config-if)# no switchport port-security mac-address 0000.0000.1112 vlan 2
(config)#interface ge2
(config-if)#switchport port-security mac-address 0000.1111.2222
(config-if)#no switchport port-security mac-address 0000.1111.2222
(config)#interface ge3
(config-if)#switchport port-security mac-address 0000.2222.3333 svlan 9
(config-if)#no switchport port-security mac-address 0000.2222.3333 svlan 9
(config)#interface ge4
```

```
(config-if)#switchport port-security mac-address 0000.2222.3333 vlan 23 svlan  
31  
(config-if)#no switchport port-security mac-address 0000.2222.3333 vlan 23  
svlan 31
```

switchport port-security maximum

Use this command to set the MAC address learning limit for an interface.

Note: This command is supported for physical, LAG, and MLAG (active) interfaces only. When a newly configured maximum learn limit is less than the previous value, you must remove/flush-out the unwanted MACs to stop traffic forwarding from the unwanted source MAC addresses. MAC addresses can be removed using the [clear mac address-table](#) command.

Use `no` form cli to set the maximum limit back to default value 1.

Command Syntax

```
switchport port-security maximum <1-1000>
no switchport port-security maximum
```

Parameters

<1-1000> Maximum MAC address learning limit

Default

The default MAC address learning limit is 1.

Command Mode

Interface mode

Applicability

This command was introduced in OcNOS version 4.0.

Examples

```
#configure terminal
(config)#interface ge1
(config-if)#switchport port-security maximum 3
```

```
#configure terminal
(config)#interface po1
(config-if)#switchport port-security maximum 3
```

```
#configure terminal
(config)#interface mlag1
(config-if)#switchport port-security maximum 3
```

CHAPTER 12 Layer 2 Control Protocols Tunneling Commands

This chapter is a reference for the Layer 2 Control Protocols (L2CP) tunneling commands:

- [clear l2protocol interface counters](#)
- [l2protocol](#)
- [l2protocol encapsulation dest-mac](#)
- [show l2protocol interface counters](#)
- [show l2protocol processing interface](#)

clear l2protocol interface counters

This command allows you to clear the counters for numbers of packets peered, discarded and tunneled.

Command Syntax

```
clear l2protocol interface (IFNAME|) counters (peer|discard|tunnel|tunnel-discard|)
```

Parameters

peer	Clear stats for Peer protocol packets.
discard	Clear stats for Tunnel protocol packets.
tunnel	Clear stats for Tunnel protocol packets.
tunnel-discard	Clear stats for Tunnel discard protocol packets.

Command Mode

Exec mode

Applicability

This command was introduced before OcNOS version 3.0.

Examples

```
# clear l2protocol interface xel counters peer
```

I2protocol

This command allows you to change the process of protocol to peer/discard/tunnel.

Command Syntax

```
l2protocol (stp|lacp|efm|elmi|lldp|synce) (peer|discard|tunnel)
```

Parameters

stp	Spanning Tree Protocols.
lacp	Link Aggregation (LACP).
efm	Ethernet first mile (Link OAM).
elmi	Ethernet local management interface.
lldp	Link layer discovery protocol.
synce	Link layer discovery protocol.
peer	Act as peer to the customer Device instance of the protocol.
discard	Discard the protocol data unit.
tunnel	Tunnel the Protocol data unit into the SVLAN.

Default

Default process value is peer.

Command Mode

Interface mode

Applicability

This command was introduced before OcNOS version 3.0.

Examples

```
#configure terminal
(config)#interface xe1
(config-if)#switchport
(config-if)#bridge-group 1
(config-if)#switchport mode customer-edge access
(config-if)#l2protocol stp tunnel
(config-if)#l2protocol stp peer
(config-if)#l2protocol stp discard
```

I2protocol encapsulation dest-mac

Use this command to change destination mac of tunneled I2 protocol packet. Allowed mac are 0100.C2CD.CDD0 or 0104.DFCD.CDD0.

Use the `no` parameter with this command to set default mac 0100.C2CD.CDD0.

Note: This command only applies to provider bridging. For more information, see the *OcNOS Carrier Ethernet Guide*.

Command Syntax

```
bridge <1-32> l2protocol encapsulation dest-mac XXXX.XXXX.XXXX
no bridge <1-32> l2protocol encapsulation dest-mac
```

Parameters

<code>bridge</code>	Bridge group for bridging.
<code><1-32></code>	<code><1-32></code>
<code>l2protocol</code>	Configure Layer2 Protocol Tunneling.
<code>encapsulation</code>	Encapsulation of L2PT packet.
<code>dest-mac</code>	Encapsulation with destination mac.
<code>XXXX.XXXX.XXXX</code>	Destination Mac-address of L2PT tunneling (0100.C2CD.CDD0 or 0104.DFCD.CDD0).

Command Mode

Configuration mode

Applicability

This command is introduced in OcNOS version 3.0.

Examples

```
(config)#bridge 1 l2protocol encapsulation dest-mac ?
XXXX.XXXX.XXXX Destination Mac-address of L2PT tunneling (0100.C2CD.CDD0 or
0104.DFCD.CDD0)
(config)#bridge 1 l2protocol encapsulation dest-mac 0104.DFCD.CDD1
L2PT destination mac should be 0100.C2CD.CDD0 or 0104.DFCD.CDD0
(config)#bridge 1 l2protocol encapsulation dest-mac 0104.DFCD.CDD0
(config)#bridge 1 l2protocol encapsulation dest-mac 0100.C2CD.CDD0
(config)#bridge 1 l2protocol encapsulation dest-mac 0100.C2CD.CDD1
L2PT destination mac should be 0100.C2CD.CDD0 or 0104.DFCD.CDD0
(config)#

(config)#no bridge 1 l2protocol encapsulation dest-mac
(config)#show running-config | in bridge
bridge 1 protocol provider-rstp edge
vlan 2-10 type customer bridge 1 state enable
vlan 11-12 type service point-point bridge 1 state enable
cvlan registration table map1 bridge 1
bridge-group 1
bridge-group 1
(config)#
```

show l2protocol interface counters

This command allows you to display the counters for numbers of packets peered, discarded and tunneled.

Note: In case of Provider-Bridging, tunneling will be done via slow path forwarding (via CPU).

And for other tunneling feature such as L2VPN, EVPN cases, L2protocol will follow hardware forwarding path to be tunneled.

Except Provider-Bridging feature, for other tunneling feature such as L2VPN/EVPN cases, tunnel counters will not be captured. Peering and discarding decision will be taken at CPU, hence, these counters will be captured with this show command.

Command Syntax

```
show l2protocol interface (IFNAME|) counters (peer|discard|tunnel|tunnel-discard|)
```

Parameters

peer	Display stats for Peer protocol packets.
discard	Display stats for Tunnel protocol packets.
tunnel	Display stats for Tunnel protocol packets.
tunnel-discard	Display stats for Tunnel discard protocol packets.

Command Mode

Exec mode

Applicability

This command was introduced before OcnOS version 3.0.

Examples

```
# show l2protocol interface xe1 counters peer
Interface xe1
Peer:      stp:      1

# show l2protocol interface xe1 counters
Interface xe1
Peer:      stp:      1
Discard:   stp:     10
Tunnel:    stp:      5
```

show l2protocol processing interface

This command allows you to display the processing information on Layer 2 protocol interface.

Command Syntax

```
show l2protocol processing interface IFNAME
```

Parameters

IFNAME Interface name

Command Mode

Exec mode and Privileged Exec mode

Applicability

This command is introduced was before OcNOS version 3.0.

Examples

```
#show l2protocol processing interface xe1/1
Bridge            Interface Name                      Protocol                      Processing Status
=====            =====                                              =====
1                xe1/1                                              stp                                      Tunnel
1                xe1/1                                              gmrp                                    Peer
1                xe1/1                                              gvrp                                    Peer
1                xe1/1                                              mmrp                                    Peer
1                xe1/1                                              mvrp                                    Peer
1                xe1/1                                              lacp                                    Peer
1                xe1/1                                              lldp                                    Peer
1                xe1/1                                              efm                                     Peer
1                xe1/1                                              elmi                                    Peer
1                xe1/1                                              ptp                                     Peer
1                xe1/1                                              synce                                   Peer
```

CHAPTER 13 Errdisable Commands

This chapter describes the errdisable commands.

- [errdisable cause](#)
- [errdisable link-flap-setting](#)
- [errdisable storm-control](#)
- [errdisable mac-move-limit](#)
- [errdisable timeout](#)
- [link-flap errdisable](#)
- [show errdisable details](#)
- [show interface errdisable status](#)

errdisable cause

Use this command to globally shut down a port when certain errors happen:

- BPDU guard puts an interface configured for Spanning Tree Protocol (STP) Port Fast into the ErrDisable state upon receipt of a STP BPDU to avoid a potential bridging loop.
- If one side of a link-access group (LAG) is configured as a static LAG and the other side as a dynamic LAG, the ports on the side receiving LACP BPDUs go into the ErrDisable state

Note: When link-flap ErrDisable is enabled globally, then all interfaces are enabled. Link-flap ErrDisable can be enabled globally, but disabled for a specific interface with the `no link-flap errdisable` command.

Note: Stp-Bpdu-Guard is enabled by default on the global level configuration.

Use `no` form of this command to not shut down a port when certain errors happen.

Command Syntax

```
errdisable cause {stp-bpdu-guard|lag-mismatch|link-flap|mac-move-limit}
no errdisable cause {stp-bpdu-guard|lag-mismatch|link-flap|mac-move-limit}
```

Parameters

<code>stp-bpdu-guard</code>	ErrDisable on stp-bpdu-guard
<code>lag-mismatch</code>	ErrDisable on lag-mismatch
<code>link-flap</code>	ErrDisable on link-flap
<code>mac-move-limit</code>	Enable or Disable Mac-Move-Limit

Default

No default value is specified

Command Mode

Configure mode

Applicability

This command was introduced before OcNOS version 1.3.

Examples

```
#configure terminal
(config)#errdisable cause lag-mismatch
```

errdisable link-flap-setting

Use this command to configure the link-flap errdisable feature:

- An interface should change state as up-down to complete one cycle of a link flap.
- The LED does not glow when an interface is in the errdisable state.
- Errdisable is supported only on physical interfaces.
- A LAG interface does not go into the errdisable state when all of its member ports are in the errdisable state
- The error disable computation is based on a sliding window of time. The window size is configurable in seconds. This window is taken as the current time to the last <t> second, where <t> is the configured window size. If the accumulated link flap count reaches the maximum flap count for a particular sliding window, a link flap error disable fault is triggered.

Note: Any previous flapping accumulated is flushed when you execute this command.

Command Syntax

```
errdisable link-flap-setting max-flaps <1-100> time <1-1800>
```

Parameters

<1-100>	Maximum flap count
<1-1800>	Sliding window size in seconds

Default

Five flaps in ten seconds:

Maximum flap count: 5

Sliding window size: 10 seconds

Command Mode

Configure mode

Applicability

This command was introduced before OcNOS version 1.3.

Examples

```
#configure terminal
(config)#errdisable link-flap-setting max-flaps 5 time 20
```

errdisable storm-control

Use this command to configure the storm-control errdisable. Following are the limitation:

- An interface discards BUM traffic during the specified interval to complete one discard-hit cycle.
- The LED does not glow when an interface is in the errdisable state.
- Errdisable is supported only on physical interfaces.
- A LAG interface does not go into the errdisable state when all of its member ports are in the errdisable state.
- The error disable computation is based on a sliding window of time. The window size is configurable in seconds. This window is taken as the current time to the last <t> second, where <t> is the configured window size. Every 5 seconds, a discard hit count increases if there is BUM traffic being discarded in that period. If the accumulated discard hit count reaches the maximum count for a particular configurable sliding window, a storm control error disable fault is triggered.

Note: Any previous discard hits accumulated are flushed when you execute this command.

Command Syntax

```
errdisable storm-control discard-hit <1-100> time <1-1800>
no errdisable cause storm-control
```

Parameters

`discard-hit <1-100>`

The maximum number of times that BUM traffic can hit the configured bandwidth threshold in an interface within a certain time window before disabling the interface. During continuous storm control discards, this counter is increased approximately every 5 seconds. Default value is 1.

`time <1-1800>`

Sliding window size in seconds. The time window in seconds in which to consider storm control threshold hits for the purposes of disabling the interface if the discard-hit is overcome during that time. This value must have a minimum value of 6 times discard-hit. Default value is 5 seconds.

Default

- One hit: ten seconds
- Maximum discard hit count: 1
- Sliding window size: 5 seconds

Command Mode

Configure mode

Applicability

This command was introduced in OcNOS version 6.5.1

Examples

```
#configure terminal
(config)#errdisable storm-control discard-hit 3 time 20
```

errdisable mac-move-limit

Use this command to set the ErrDisable mac movement limit.

Command Syntax

```
errdisable mac-move-limit <1-1000>  
no errdisable mac-move-limit
```

Parameters

<1-1000> Allowed Mac movement in 5 seconds

Default

By default, mac-move-limit is 1000

Command Mode

Configure mode

Applicability

This command was introduced before OcnOS version 3.0.

Examples

```
#configure terminal  
(config)#errdisable mac-move-limit 50  
(config)#no errdisable mac-move-limit
```

errdisable timeout

Use this command to set the ErrDisable auto-recovery timeout interval.

Command Syntax

```
errdisable timeout interval <10-1000000>
```

Parameters

<10-1000000> Timeout interval in seconds

Default

By default, zero: timer is disabled

Command Mode

Configure mode

Applicability

This command was introduced before OcNOS version 1.3.

Examples

```
#configure terminal  
(config)#errdisable timeout interval 1000
```

link-flap errdisable

Use this command to shut down the interface when it continually goes up and down.

The link-flap ErrDisable feature must be enabled globally with the [errdisable cause](#) command.

Note: When link-flap ErrDisable is enabled globally, then all interfaces are enabled. Link-flap ErrDisable can be enabled globally, but disabled for a specific interface with the `no link-flap errdisable` command.

Note: This feature is supported only on physical ports.

Use the `no` form of this command to disable this behavior.

Command Syntax

```
link-flap errdisable
no link-flap errdisable
```

Parameter

None

Default

No default value is specified

Command Mode

Interface mode

Applicability

This command was introduced before OcNOS version 1.3.

Example

```
#configure terminal
(config)#interface xe1/1
(config-if)#link-flap errdisable
```

show errdisable details

Use this command to display ErrDisable settings.

Command Syntax

```
show errdisable details
```

Parameters

None

Default

None

Command Mode

Exec mode and Privileged Exec mode

Applicability

This command was introduced before OcNOS version 1.3.

Example

```
#show errdisable details
```

show interface errdisable status

Use this command to display ErrDisable conditions for an interface.

Command Syntax

```
show interface errdisable status
```

Parameters

None

Default

None

Command Mode

Exec mode and Privileged Exec mode

Applicability

This command was introduced before OcNOS version 1.3.

Example

```
#show interface errdisable status
ge1 lag-mismatch-errdisable
ge2 stp-bpdu-guard-errdisable
```

CHAPTER 14 Unidirectional Link Detection Commands

This section describes the Unidirectional Link Detection (UDLD) commands.

- [udld](#)
- [udld message-time](#)
- [udld mode](#)
- [udld state](#)
- [show udld](#)
- [show udld interface](#)

udld

Use this command to enable the UDLD feature globally.

Use no form of this command to disable the UDLD feature globally.

Command Syntax

```
udld enable
no udld enable
```

Parameters

None

Default

Disabled

Command Mode

Configure mode

Applicability

This command was introduced in OcNOS version 5.0.

Examples

```
(config)#udld enable
(config)#no udld enable
```

udld message-time

Use this command to set the UDLD message interval.

Command Syntax

```
udld message-time <7-90>
```

Parameters

<7-90> Interval time in seconds

Default

15 seconds

Command Mode

Configure mode

Applicability

This command was introduced in OcNOS version 5.0.

Examples

```
config)#udld message-time 50
```

udld mode

Use this command to configure UDLD mode as aggressive or normal.

Command Syntax

```
udld mode (aggressive | normal)
```

Parameters

aggressive	Aggressive mode
normal	Normal mode

Default

N/A

Command Mode

Interface mode

Applicability

This command was introduced in OcNOS version 5.0.

Examples

```
(config-if)#udld mode aggressive
```

udld state

Use this command to enable or disable the UDLD feature for an interface.

Command Syntax

```
udld state (enable | disable)
```

Parameters

None

Default

Disabled

Command Mode

Interface mode

Applicability

This command was introduced in OcNOS version 5.0.

Examples

```
(config)#int xe7  
(config-if)#udld state enable
```

show udld

Use this command to display UDLD statistic for all interface.

Command Syntax

```
show udld
```

Parameters

None

Command Mode

Exec mode

Applicability

This command was introduced in OcNOS version 5.0.

Examples

```
#show udld
UDLD                : Enable
Message Interval(sec) : 15
Port  UDLD Status  Mode                Link-Status
-----
xe7   Enable       Normal                Bi-Directional
```

[Table 14-31](#) explains the output fields.

Table 14-31: show udld output fields

Field	Description
UDLD	Whether UDLD is enabled or disabled
Message Interval	Message interval in seconds
Port	Interface name
UDLD Status	Whether UDLD is enabled or disabled on the interface
Mode	Whether the mode is aggressive or normal
Link-Status	State of the link: Unknown Loop-Back Neighbor Mismatch Unidirectional Undetermined Bi-Directional

show udd interface

Use this command to display UDLD settings for particular interface.

Command Syntax

```
show udd interface IFNAME
```

Parameters

None

Command Mode

Exec mode

Applicability

This command was introduced in OcNOS version 5.0.

Examples

```
#show udd interface xe14
UDLD Status           : Enable
UDLD Mode             : Aggressive
Link-State            : Bi-Directional
#
```

[Table 14-32](#) explains the output fields.

Table 14-32: show udd interface output fields

Field	Description
UDLD Status	Whether UDLD is enabled or disabled
UDLD Mode	Whether the mode is aggressive or normal
Link-State	State of the link: Unknown Loop-Back Neighbor Mismatch Unidirectional Undetermined Bi-Directional

CHAPTER 15 Link Layer Discovery Protocol Commands

This chapter describes the Link Layer Discovery Protocol (LLDP) commands.

- `lldp debug`
- `lldp (disable|enable) default-agent`
- `lldp ip`
- `lldp tlv`
- `set lldp chassis-id-tlv`
- `set lldp disable`
- `set lldp enable`
- `set lldp locally-assigned`
- `set lldp management-address-tlv`
- `set lldp msg-tx-hold`
- `set lldp system-description`
- `set lldp system-name`
- `set lldp timer`
- `set lldp too-many-neighbors`
- `show lldp`
- `snmp restart lldp`

lldp debug

Use this command to set the debugging functions for LLDP.

Use the no form of this command to turn off LLDP debugging functions

Command Syntax

```
lldp debug (event|rx|tx|message)
no lldp debug (event|rx|tx|message)
```

Parameters

event	Enable or disable event debugging
message	Enable or disable NSM message debugging
rx	Enable or disable RX debugging
tx	Enable or disable TX debugging

Command Mode

Exec mode and Privileged Exec mode

Examples

```
#lldp debug event
#lldp debug messages
```

lldp (disable|enable) default-agent

Use this command to exclude interface when LLDP enabled globally

Command Syntax

```
lldp (disable|enable) default-agent
```

Parameters

disable	Disables default LLDP agent
enable	Enables default LLDP agent

Command Mode

Interface mode

Applicability

This command is introduced from OcnOS version 5.0

Example

```
#configure terminal
(config)#interface xe1
(config-if)#lldp disable default-agent
(config-if)#lldp enable default-agent
```

lldp ip

Use this command to set the Link Layer Discovery Protocol with an IP address to be used as a chassis and management ID.

Use the `no` form of this command to remove this value.

Command Syntax

```
lldp ip address A.B.C.D
no lldp ip address
```

Parameters

A.B.C.D Enter the IP address value

Command Mode

Configure mode

Examples

```
#configure terminal
(config)#lldp ip address 1.1.1.1
(config)#no lldp ip address
```

lldp tlv

Use this command to set the TLVs enabled for transmission on a port. Make sure that the complete set of Type Length Values (TLVs) is specified when giving this command, because TLVs not specified are disabled.

Command Syntax

```
lldp tlv {chassis-id|port-id|ttl|port-description|system-name|system-  
description|system-capabilities|management-address|ieee-8021-org-specific|ieee-  
8023-org-specific}
```

Parameters

chassis-id	Chassis ID type length values (TLV)
port-id	Port ID TLV
ttl	Time to live TLV
port-description	Port description TLV
system-name	System name TLV
system-description	System Description
system-capabilities	System capabilities TLV
management-address	Management address TLV
ieee-8021-org-specific	IEEE 802.1 organizationally-specific TLV
ieee-8023-org-specific	IEEE 802.3 organizationally-specific TLV

Command Mode

Interface mode

Example

```
#configure terminal  
(config)#interface eth0  
(config-if)#lldp tlv chassis-id ieee-8021-org-specific ieee-8023-org-specific  
management-address port-description port-id system-capabilities system-  
description system-name ttl
```

set lldp chassis-id-tlv

Use this command to set the chassis ID subtype for the LLDP agent on a port.

Command Syntax

```
set lldp chassis-id-tlv (mac-address | ip-address)
```

Parameters

mac-address	Use the MAC address as the chassis ID
ip-address	Use the management IP address as the chassis ID

Command Mode

Interface mode

Examples

```
#configure terminal
(config)#interface eth0
(config-if)#set lldp chassis-id-tlv ip-address
```

set lldp disable

Use this command to disable the LLDP agent on a port.

Command Syntax

```
set lldp disable
```

Parameters

None

Command Mode

Interface mode

Examples

```
#configure terminal  
(config)#interface eth0  
(config-if)#set lldp disable
```

set lldp enable

Use this command to enables an LLDP agent on a port and specifies its type.

Command Syntax

```
set lldp enable (txonly|txrx|rxonly)
```

Parameters

rxonly	Receive-only
txonly	Transmit-only
txrx	Transmit and receive

Default

By default, no LLDP agent is enabled for a port.

Command Mode

Interface mode

Examples

```
#configure terminal
(config)#interface eth 0
(config-if)#set lldp enable rxonly
```

set lldp locally-assigned

Use this command to locally assign the LLDP Port ID and the Chassis ID TLV parameters.

Command Syntax

```
set lldp locally-assigned NAME
```

Parameters

NAME Name assigned to the port.

Command Mode

Interface mode

Examples

```
#configure terminal
(config)#interface eth 0
(config-if)#set lldp locally-assigned port1
```

set lldp management-address-tlv

Use this command to set the management address subtype for the LLDP agent on a port.

Command Syntax

```
set lldp management-address-tlv (mac-address | ip-address)
```

Parameters

mac-address	Use the MAC address as the chassis ID
ip-address	Use the management IP address as the chassis ID

Command Mode

Interface mode

Examples

```
#configure terminal
(config)#interface eth 0
(config-if)#set lldp management-address-tlv ip-address
```

set lldp msg-tx-hold

Use this command to set the `msg-tx-hold` parameter that determines the Time To Live (TTL) value for LLDPDUs to be transmitted by the port. The value set with this command is multiplied by the `lldp timer msg-tx-interval` value, which determines the final TTL value.

Command Syntax

```
set lldp msg-tx-hold VALUE
```

Parameters

VALUE	Time in seconds of LLDP msg-tx-hold
-------	-------------------------------------

Default

The default value of the `lldp msg-tx-hold` parameter is 4 seconds.

Command Mode

Interface mode

Examples

```
#configure terminal
(config)#interface eth0
(config)#set lldp msg-tx-hold 3
```

set lldp system-description

Use this command to identify the string that describes the LLDP system.

Command Syntax

```
set lldp system-description LINE
```

Parameters

LINE Set the description of the LLDP system.

Default

The default status of Ethernet OAM is disabled.

Command Mode

Configure mode

Example

```
#configure terminal
(config)#set lldp system-description LLDP agent on B1
```

set lldp system-name

Use this command to identify the system name of the LLDP function.

Command Syntax

```
set lldp system-name NAME
```

Parameters

NAME	Name of the LLDP system.
------	--------------------------

Command Mode

Configure mode

Example

```
#configure terminal  
(config)#set lldp system-name LLDP1
```

set lldp timer

Use this command to set the interval at which LLDP frames are transmitted.

Command Syntax

```
set lldp timer msg-tx-interval <5-32768>
set lldp timer reinitDelay VALUE
set lldp timer tx-delay <1-8192>
```

Parameters

msg-tx-interval	
	Set the message transmit interval value
<5-32768>	Set the message transmit interval value
reinitDelay	Set the reinit delay value
VALUE	Set the reinit delay value
tx-delay	Set the transmit delay value
<1-8192>	Set the transmit delay value in range of: (1 <= tx-delay <= ((0.25)* msg-tx-interval)

Default Values

The default value for `msg-tx-interval` is 30 seconds.

The default value for `reinitDelay` is 2 seconds.

The default value of the `tx-delay` is 2 seconds.

Command Mode

Interface mode

Examples

```
#configure terminal
(config)#interface eth0
(config-if)#set lldp timer msg-tx-interval 40

#configure terminal
(config)#interface eth0
(config-if)#set lldp timer reinitDelay 3

#configure terminal
(config)#interface eth0
(config-if)#set lldp timer tx-delay 3
```

set lldp too-many-neighbors

Use this command to set the action to take when the remote table is full.

Command Syntax

```
set lldp too-many-neighbors limit <1-65535> discard received-info timer <1-65535>
set lldp too-many-neighbors limit <1-65535> discard existing-info MAC
timer <1-65535>
```

Parameters

limit	The limit on the number of LLDP neighbors.
<1-65535>	The limit on the number of LLDP neighbors.
received-info	The information received for this neighbor.
timer	The period after which received information is discarded.
<1-65535>	The period in seconds after which received information is discarded.
existing-info	The information for this neighbor.
MAC	Identifies the remote LLDP Agent for which information is discarded.
timer	The period in seconds after which existing information is discarded.
<1-65535>	The period in seconds after which existing information is discarded.

Default Value

No upper limit is enforced for the number of remote LLDP agents.

Command Mode

Interface mode

Examples

```
#configure terminal
(config)#interface eth1
(config-if)#set lldp too-many-neighbors limit 20 disc existing-info 1.1.1.1.1
timer 1

(config)#interface eth1
(config-if)#set lldp too-many-neighbors limit 1 discard received-info timer 1
```

show lldp

Use this command to display LLDP port information.

Command Syntax

```
show lldp port IFNAME
show lldp port IFNAME statistics
```

Parameters

IFNAME	The name of the interface
statistics	Display LLDP port statistics

Command Mode

Exec mode and Privileged Exec mode

Example

The following sample output from this command displays detailed information about an LLDP-enabled port.

```
#show lldp port eth0
Remote LLDP
MAC Address: 01:06:29:CF:79:A1
TTL: 60
Network Address: 192.168.1.0
Interface Name: eth1
Interface Locally Assigned String: Port-a
Interface Description: bridge
Interface Number: 2
Port Vlan ID: 1
Protocol ID: 274242030202
AutoNego Support: Supported
AutoNego Capability: 1
Operational MAU Type: 3
Link Aggregation Status: Capable
Link Aggregation Port ID: 0
Max Frame Size: 128
System name:
System Description: bridge
System Capabilities: 4
System Capabilities Enabled: 4
```

The following sample output from this command displays all LLDP statistics for a selected port.

```
#show lldp port eth0 statistics
LLDP Port statistics for eth0
Frames transmitted: 22
Frames Aged out: 0
Frames Discarded: 0
Frames with Error: 0
Frames Received: 5
TLVs discarded: 0
TLVs unrecognized 0
```

snmp restart lldp

Use this command to restart SNMP in Link Layer Discovery Protocol (LLDP)

Command Syntax

```
snmp restart lldp
```

Parameters

None

Command Mode

Configure mode

Examples

```
#snmp restart lldp
```

Index

Numerics

802.1x Commands

- auth-mac enable 619
- auth-mac system-auth-ctrl 621
- debug dot1x 623
- dot1x port-control 625
- dot1x protocol-version 626
- dot1x quiet-period 627
- dot1x reauthentication 628
- dot1x reauthMax 629
- dot1x system-auth-ctrl 630
- dot1x timeout re-authperiod 631
- dot1x timeout server-timeout 632
- dot1x timeout supp-timeout 633
- dot1x timeout tx-period 634
- ip radius source-interface 635
- radius-server host 638
- show debugging dot1x 640
- show dot1x 641

A

- authentication 155
- auth-mac enable 619
- auth-mac system-auth-ctrl 621

B

- begin modifier 21
- BGP community value
 - command syntax 19
- braces
 - command syntax 18
- bridge acquire 421
- bridge address 422
- bridge ageing-time 424
- bridge cisco-interoperability 451
- Bridge commands
 - bridge acquire 421
 - bridge address 422
 - bridge ageing-time 424
 - bridge protocol mstp 458
 - bridge protocol rstp 459
 - clear mac address-table 437
 - show interface switchport bridge 441
 - switchport 447
- bridge forward-time 426
- bridge instance priority 453
- bridge max-age 428
- bridge max-hops 429
- bridge multiple-spanning-tree enable 456
- bridge priority 430
- bridge protocol mstp 458
- bridge protocol provider-rstp 399

- bridge protocol rstp 459
- bridge rapid-spanning-tree enable 460
- bridge region 461
- bridge revision 462
- bridge shutdown 431
- bridge spanning-tree enable 463
- bridge spanning-tree errdisable-timeout enable 464
- bridge spanning-tree portfast bpdu-filter 467
- bridge te-msti 470
- bridge transmit-holdcount 432
- bridge-group instance 471
- bridge-group instance path-cost 472
- bridge-group path-cost 434
- bridge-group priority 435

C

- clear mac address-table 437
- clear spanning-tree detected protocols 477
- command abbreviations 17
- command completion 17
- command line
 - errors 17
 - help 16
 - keyboard operations 20
- command modes 24
 - configure 24
 - exec 24
 - interface 24
 - privileged exec 24
 - router 24
- command negation 18
- command syntax
 - ? 19
 - . 19
 - () 18
 - { } 18
 - | 18
 - A.B.C.D/M 19
 - AA:NN 19
 - BGP community value 19
 - braces 18
 - conventions 18
 - curly brackets 18
 - HH:MM:SS 19
 - IFNAME 19
 - interface name 19
 - IPv4 address 19
 - IPv6 address 19
 - LINE 19
 - lowercase 18
 - MAC address 19
 - monospaced font 18
 - numeric range 19
 - parentheses 18
 - parenteses 18
 - period 19
 - question mark 19
 - square brackets 19

- time 19
- uppercase 18
- variable placeholders 19
- vertical bars 18
- WORD 19
- X:X::X:X 19
- X:X::X:X/M 19
- XX:XX:XX:XX:XX:XX 19
- common commands
 - errdisable 675
 - errdisable timeout 678, 679
- Common NSM Layer 2 commands
 - storm-control level 513
- configuration
 - disable spanning tree 128
- configure
 - 802.1x authentication 155
 - GMRP 313
 - LACP 157
 - LLDP 28
 - MSTP 112
 - Provider Bridging 53
 - RSTP 102
 - STP 91
- configure mode 24
- curly brackets
 - command syntax 18
- customer-spanning-tree customer-edge path-cost 479
- customer-spanning-tree customer-edge priority 480
- customer-spanning-tree forward-time 481
- customer-spanning-tree hello-time 482
- customer-spanning-tree max-age 483
- customer-spanning-tree priority 484
- customer-spanning-tree provider-edge path-cost 485
- customer-spanning-tree provider-edge priority 486
- customer-spanning-tree transmit-holdcount 487
- cvlan registration table 400
- cvlan svlan 401

D

- debug dot1x 623
- debug lacp command 519
- debug mcec 547
- debug mstp 488
- disable spanning tree
 - configuration 128
 - spanning-tree te-msti configuration 512
- domain hello timeout 548
- domain priority 549
- domain system number 550
- domain-address 546
- dot1x mac-auth-bypass 624
- dot1x port-control 625
- dot1x protocol-version 626
- dot1x quiet-period 627
- dot1x reauthentication 628
- dot1x reauthMax 629
- dot1x system-auth-control 630

- dot1x timeout re-authperiod 631
- dot1x timeout server-timeout 632
- dot1x timeout supp-timeout 633
- dot1x timeout tx-period 634

E

- errdisable 675
- errdisable timeout 678, 679
- exec command mode 24

G

- GARP Multicast Registration Protocol 313
- GMRP
 - configuring 313

I

- IEEE 802.1x 155
- IFNAME 19
- interface mode 24
- interface po 520
- interface sa 521
- intra-domain-link 551
- ip radius source-interface 635
- IPv4 address
 - command syntax 19
- IPv6 address
 - command syntax 19

L

- LACP
 - configuring 157
- LACP Commands
 - debug lacp 519
 - lacp port-priority 524
 - lacp system-priority 525
 - lacp timeout 526
 - show debugging lacp 530
 - show lacp-counter 535
 - show port etherchannel 536
 - static-channel-group 542
- LACP commands
 - port-channel load-balance 527
- lacp destination-mac 522
- lacp discard wrong conversation 523
- lacp port-priority command 524
- lacp system-priority command 525
- lacp timeout command 526
- LINE 19
- LLDP commands
 - lldp system-name 388, 702
 - set lldp disable 378, 696
 - set lldp enable 378, 697
 - set lldp locally-assigned 381, 698
 - set lldp msg-tx-hold 382, 700
 - set lldp msg-tx-interval 384, 388

set lldp too-many-neighbors 389, 704
 show lldp port 390, 705
 lldp system-name 388, 702

M

MAC address
 command syntax 19
 mcec domain configuration 553
 MC-LAG Configuration 209, 244
 mlag 554
 MSTP
 configuring 112

N

NSM Commands
 show router-id 681

P

parantheses
 command syntax 18
 parentheses
 command syntax 18
 period
 command syntax 19
 port 527
 portal-system-number 557
 portal-topology 557
 port-channel load-balance 527
 port-channel min-links 527
 port-conv-id 557
 Private-VLAN commands
 switchport private-vlan host-association 604
 switchport private-vlan mapping 605
 privileged exec mode 24
 Provider Bridging commands
 bridge protocol provider-rstp 399
 cvlan registration table 400
 cvlan svlan 401
 switchport customer-edge 405
 switchport customer-edge hybrid allowed vlan 406
 switchport customer-edge vlan registration 408
 switchport mode customer-edge access 412
 vlan type 418

Q

question mark
 command syntax 19

R

radius-server host 638
 router mode 24

S

set lldp disable 378
 set lldp enable 378, 697
 set lldp locally-assigned 381, 698
 set lldp msg-tx-hold 382, 700
 set lldp msg-tx-interval 384, 388
 set lldp too-many-neighbors 389, 704
 show commands 21
 exclude modifier 22
 include modifier 22
 redirect modifier 23
 show debugging dot1x 640
 show debugging lacp command 530
 show debugging mstp 490
 show dot1x 641
 show errdisable details 681
 show interface errdisable status 682
 show interface switchport bridge 441
 show lacp-counter command 535
 show lldp interface 394
 show lldp port 390, 705
 show mac address-table count bridge 443
 show mlag conversation-id 557
 show mlag detail 557
 show port etherchannel command 536
 show router-id 681
 show spanning-tree 491
 show spanning-tree mst 495
 show spanning-tree statistics 497
 show vlan 589
 show vlan all 589
 show vlan auto 591
 show vlan brief 591
 show vlan classifier 592
 spanning-tree autoedge 500
 spanning-tree edgeport 501
 spanning-tree guard root 502
 spanning-tree hello-time 503
 spanning-tree instance restricted-role 503
 spanning-tree instance restricted-tcn 504
 spanning-tree link-type 505
 spanning-tree mst configuration 506
 spanning-tree restricted-role 510
 spanning-tree restricted-tcn 511
 spanning-tree te-msti configuration 512
 square brackets
 command syntax 19
 static-channel-group 542
 storm-control level 513
 STP
 configuring 91
 STP commands
 bridge cisco-interoperability 451
 bridge forward-time 426
 bridge instance priority 453
 bridge max-age 428
 bridge max-hops 429
 bridge multiple-spanning-tree enable 456

- bridge priority 430
 - bridge rapid-spanning-tree enable 460
 - bridge region 461
 - bridge revision 462
 - bridge shutdown 431
 - bridge spanning-tree enable 463
 - bridge spanning-tree errdisable-timeout enable 464
 - bridge spanning-tree portfast bpdu-filter 467
 - bridge transmit-holdcount 432
 - bridge-group path-cost 434
 - bridge-group priority 435
 - clear spanning-tree detected protocols 477
 - customer-spanning-tree customer-edge path-cost 479
 - customer-spanning-tree customer-edge priority 480
 - customer-spanning-tree forward-time 481
 - customer-spanning-tree hello-time 482
 - customer-spanning-tree max-age 483
 - customer-spanning-tree priority 484
 - customer-spanning-tree provider-edge path-cost 485
 - customer-spanning-tree provider-edge priority 486
 - customer-spanning-tree transmit-holdcount 487
 - debug mstp 488
 - show debugging mstp 490
 - show spanning-tree 491
 - show spanning-tree mst 495
 - show spanning-tree statistics 497
 - spanning-tree autoedge 500
 - spanning-tree edgeport 501
 - spanning-tree guard root 502
 - spanning-tree hello-time 503
 - spanning-tree instance restricted-role 503
 - spanning-tree instance restricted-tcn 504
 - spanning-tree link-type 505
 - spanning-tree mst configuration 506
 - spanning-tree restricted-role 510
 - spanning-tree restricted-tcn 511
 - switchport 447
 - switchport access vlan 594
 - switchport customer-edge 405
 - switchport customer-edge hybrid allowed vlan 406
 - switchport customer-edge vlan registration 408
 - switchport hybrid allowed vlan 595
 - switchport mode customer-edge access 412
 - switchport mode hybrid 597, 598
 - switchport mode trunk 598
 - switchport private-vlan host-association 604
 - switchport private-vlan mapping 605
 - switchport trunk allowed vlan 598
 - switchport trunk native vlan 601
- T**
- time
 - command syntax 19
 - Topology 244
- U**
- UDLD configuration 317
- V**
- vertical bars
 - command syntax 18
 - vlan classifier ipv4 611
 - VLAN commands
 - show vlan 589
 - show vlan all 589
 - show vlan auto 591
 - show vlan brief 591
 - show vlan classifier 592
 - switchport access vlan 594
 - switchport hybrid allowed vlan 595
 - switchport mode hybrid 597, 598
 - switchport mode trunk 598
 - switchport trunk allowed vlan 598
 - switchport trunk native vlan 601
 - vlan classifier ipv4 611
 - vlan database 613
 - vlan database command 613
 - vlan type 418
- W**
- WORD 19