



OcNOS[®]
Open Compute
Network Operating System
for Service Providers
Version 6.5.2

Virtual Extensible LAN Guide

August 2024

© 2024 IP Infusion Inc. All Rights Reserved.

This documentation is subject to change without notice. The software described in this document and this documentation are furnished under a license agreement or nondisclosure agreement. The software and documentation may be used or copied only in accordance with the terms of the applicable agreement. No part of this publication may be reproduced, stored in a retrieval system, or transmitted in any form or any means electronic or mechanical, including photocopying and recording for any purpose other than the purchaser's internal use without the written permission of IP Infusion Inc.

IP Infusion Inc.

3965 Freedom Circle, Suite 200

Santa Clara, CA 95054

+1 408-400-1900

<http://www.ipinfusion.com/>

For support, questions, or comments via E-mail, contact:

support@ipinfusion.com

Trademarks:

IP Infusion and OcNOS are trademarks or registered trademarks of IP Infusion. All other trademarks, service marks, registered trademarks, or registered service marks are the property of their respective owners.

Use of certain software included in this equipment is subject to the IP Infusion, Inc. End User License Agreement at <http://www.ipinfusion.com/license>. By using the equipment, you accept the terms of the End User License Agreement.

Contents

Preface	8
IP Maestro Support	8
Audience	8
Conventions	8
Chapter Organization	8
Related Documentation	8
Feature Availability	9
Migration Guide	9
Support	9
Comments	9
Command Line Interface	10
Overview	10
Command Line Interface Help	10
Command Completion	11
Command Abbreviations	11
Command Line Errors	11
Command Negation	12
Syntax Conventions	12
Variable Placeholders	13
Command Description Format	14
Keyboard Operations	14
Show Command Modifiers	15
String Parameters	18
Command Modes	18
Transaction-based Command-line Interface	20
Virtual Extensible LAN Configuration Guide	21
CHAPTER 1 Overview	22
Terminology	22
VXLAN Architecture	22
CHAPTER 2 VxLAN Unicast Configuration	24
Port Mapping	24
Intermediate Non-VxLAN Router	29
CHAPTER 3 VXLAN-EVPN Configuration	35
Topology	35
LAG as Access Port with ECMP on the Network Side	44
CHAPTER 4 VxLAN EVPN EVC Configuration	58
Overview	58
Topology	58
Configuration	58
Validation	62

CHAPTER 5	VxLAN Hybrid Access Port Configuration	71
	Overview	71
	Topology	71
	Validation.	75
CHAPTER 6	VxLAN Multi-Homing Configuration.	83
	Overview	83
	Topology	84
	VxLAN-EVPN MH Configuration	85
	Static MAC-IP Advertise through Single Home and Multihomed VTEPs.	108
	Dynamic MAC Advertise through Single Home and Multihomed VTEPs	110
CHAPTER 7	VxLAN Quality of Service Configuration	113
	Overview	113
	Topology	114
	COS-DSCP	114
	Validation.	118
CHAPTER 8	VxLAN Tunnel Over SVI	123
	Overview	123
	Topology	123
	Validation.	141
CHAPTER 9	VxLAN-EVPN with IRB	148
	Overview	148
	Topology	148
	Base Configuration - L2 VxLAN	149
	Centralized Gateway	166
	IRB Configuration for Centralized Gateway	166
	Anycast Gateway	170
	Distributed Gateway.	191
	IRB Configuration for Distributed	191
	VxLAN IRB ECMP	198
CHAPTER 10	VxLAN-EVPN with IRB QoS	205
	Overview	205
	Topology	205
	Base Configuration - L2 VxLAN	205
	Centralized Gateway	218
	IRB Configuration for Centralized Gateway	218
	Anycast Gateway	229
	IRB Configuration for Anycast	229
	Distributed Gateway.	255
	IRB QoS Configuration for Distributed	256
CHAPTER 11	EVPN VXLAN E-Tree	275
	Overview	275
	Prerequisites	276
	Configuration.	280
	Implementation Examples.	296

E-Tree CLI Commands	297
Revised CLI Commands	297
Troubleshooting	298
Glossary	298
CHAPTER 12 VxLAN-IRB-Inter-VRF Route Leaking	300
Topology	300
CHAPTER 13 VxLAN Trunk Access Port Configuration	338
CHAPTER 14 DHCP Relay Over IRB Interface	359
Overview	359
Topology	359
CHAPTER 15 VxLAN Eline xConnect Configuration	366
Single-Homed VxLAN Eline xConnect	366
Multi-Homed VxLAN Eline xConnect	371
CHAPTER 16 VxLAN-EVPN Symmetric IRB Support with Connected host	383
Overview	383
Configuration	383
Glossary	389
CHAPTER 17 Single-Home for VxLAN IRB with OSPF or ISIS	390
Overview	390
Prerequisites	390
Topology for OSPF	391
Configuration	391
Topology for ISIS	397
Implementation Examples	405
Validation	405
Abbreviations	422
Glossary	423
CHAPTER 18 Single-Home for VxLAN EVPN IRB with OSPF or ISIS	424
Overview	424
Prerequisites	424
Topology for OSPF	425
Configuration	425
Implementation Examples	436
Validation	436
Abbreviations	446
Glossary	446
Virtual Extensible LAN Command Reference	448
CHAPTER 1 VXLAN Commands	449
access-if-evpn	451
arp-cache disable	452
arp-nd flood-suppress	453
arp-nd refresh timer	454

clear mac address-table dynamic vxlan	455
clear nvo vxlan counters	456
clear nvo vxlan mac-stale-entries	457
description	458
dynamic-learning disable	459
encapsulation	460
evpn esi hold-time	461
evpn	462
evpn irb-forwarding anycast-gateway-mac	463
evpn irb-if-forwarding anycast-gateway-mac	464
evpn multi-homed	465
evpn vxlan multihoming enable	466
evpn-vlan-service	467
hardware-profile filter vxlan	468
hardware-profile filter vxlan-mh	469
hardware-profile filter vxlan-short-pkt	470
interface irb	471
ip address	472
ipv6 address	473
ip dhcp relay uplink	474
l3vni	475
mac	476
mac vrf	477
mac-holdtime	478
map vpn-id	479
nd-cache disable	480
nvo vxlan	481
nvo vxlan access-if	482
nvo vxlan id	484
nvo vxlan irb	486
nvo vxlan mac-ageing-time	487
nvo vxlan vtep-ip-global	488
show bgp l2vpn evpn	489
show bgp l2vpn evpn prefix-route	492
show bgp l2vpn evpn summary	493
show evpn multi-homing all	495
show evpn multihoming-status	496
show interface irb	497
show nvo vxlan	498
show nvo vxlan access-if-config	499
show nvo vxlan arp-cache	500
show nvo vxlan counters access-port	501
show nvo vxlan counters network-port	503
show evpn	505
show nvo vxlan mac-table	506
show nvo vxlan static host state	508
show nvo vxlan tunnel	510

show nvo vxlan route-count	511
show nvo vxlan vni-name	512
show nvo vxlan xconnect	513
show running-config interface irb	515
show running-config nvo vxlan	516
shutdown	518
vxlan host-reachability-protocol evpn-bgp	519
CHAPTER 2 VXLAN Quality of Service Commands	520
clear nvo vxlan tunnels	521
cos queue	522
dscp queue	523
l2 queue dscp	524
l3 dscp dscpEncap	525
map qos-profile	526
map qos-profile cos-to-queue	527
map qos-profile queue-color-to-cos	528
nvo vxlan tunnel qos-map-mode cos-dscp	529
qos profile cos-to-queue	530
qos profile dscp-encap	531
qos profile dscp-to-queue	532
qos profile queue-color-to-cos	533
qos profile queue-color-to-dscp	534
queue cos	535
queue dscp	536
show qos-profile type dscp-encap	537
show running-config interface irb	539
Index	540

Preface

This guide describes how to configure OcNOS.

IP Maestro Support

Monitor devices running OcNOS Release 6.3.4-70 and above using IP Maestro software.

Audience

This guide is intended for network administrators and other engineering professionals who configure OcNOS.

Conventions

[Table P-1](#) shows the conventions used in this guide.

Table P-1: Conventions

Convention	Description
Italics	Emphasized terms; titles of books
Note:	Special instructions, suggestions, or warnings
<code>monospaced type</code>	Code elements such as commands, parameters, files, and directories

Chapter Organization

The chapters in command references are organized as described in [Command Description Format](#).

The chapters in configuration guides are organized into these major sections:

- An overview that explains a configuration in words
 - Topology with a diagram that shows the devices and connections used in the configuration
 - Configuration steps in a table for each device where the left-hand side shows the commands you enter and the right-hand side explains the actions that the commands perform
 - Validation which shows commands and their output that verify the configuration
-

Related Documentation

For information about installing OcNOS, see the *Installation Guide* for your platform.

Feature Availability

The features described in this document that are available depend upon the OcNOS SKU that you purchased. See the *Feature Matrix* for a description of the OcNOS SKUs.

Migration Guide

Check the *Migration Guide* for configuration changes to make when migrating from one version of OcNOS to another.

Support

For support-related questions, contact support@ipinfusion.com.

Comments

If you have comments, or need to report a problem with the content, contact techpubs@ipinfusion.com.

Command Line Interface

This chapter introduces the OcNOS Command Line Interface (CLI) and how to use its features.

Overview

You use the CLI to configure, monitor, and maintain OcNOS devices. The CLI is text-based and each command is usually associated with a specific task.

You can give the commands described in this manual locally from the console of a device running OcNOS or remotely from a terminal emulator such as `putty` or `xterm`. You can also use the commands in scripts to automate configuration tasks.

Command Line Interface Help

You access the CLI help by entering a full or partial command string and a question mark “?”. The CLI displays the command keywords or parameters along with a short description. For example, at the CLI command prompt, type:

```
> show ?
```

The CLI displays this keyword list with short descriptions for each keyword:

```
show ?
  application-priority      Application Priority
  arp                      Internet Protocol (IP)
  bfd                      Bidirectional Forwarding Detection (BFD)
  bgp                      Border Gateway Protocol (BGP)
  bi-lsp                   Bi-directional lsp status and configuration
  bridge                   Bridge group commands
  ce-vlan                  COS Preservation for Customer Edge VLAN
  class-map                Class map entry
  cli                     Show CLI tree of current mode
  clns                     Connectionless-Mode Network Service (CLNS)
  control-adjacency       Control Adjacency status and configuration
  control-channel         Control Channel status and configuration
  cspf                    CSPF Information
  customer                Display Customer spanning-tree
  cvlan                   Display CVLAN information
  debugging               Debugging functions (see also 'undebug')
  etherchannel            LACP etherchannel
  ethernet                Layer-2
  ...
```

If you type the ? in the middle of a keyword, the CLI displays help for that keyword only.

```
> show de?
debugging Debugging functions (see also 'undebug')
```

If you type the ? in the middle of a keyword, but the incomplete keyword matches several other keywords, OcNOS displays help for all matching keywords.

```
> show i? (CLI does not display the question mark).
interface Interface status and configuration
ip IP information
isis ISIS information
```

Command Completion

The CLI can complete the spelling of a command or a parameter. Begin typing the command or parameter and then press the tab key. For example, at the CLI command prompt type `sh`:

```
> sh
```

Press the tab key. The CLI displays:

```
> show
```

If the spelling of a command or parameter is ambiguous, the CLI displays the choices that match the abbreviation. Type `show i` and press the tab key. The CLI displays:

```
> show i
  interface  ip          ipv6          isis
> show i
```

The CLI displays the `interface` and `ip` keywords. Type `n` to select `interface` and press the tab key. The CLI displays:

```
> show in
> show interface
```

Type `?` and the CLI displays the list of parameters for the `show interface` command.

```
> show interface
  IFNAME  Interface name
  |       Output modifiers
  >       Output redirection
  <cr>
```

The CLI displays the only parameter associated with this command, the `IFNAME` parameter.

Command Abbreviations

The CLI accepts abbreviations that uniquely identify a keyword in commands. For example:

```
> sh int xe0
```

is an abbreviation for:

```
> show interface xe0
```

Command Line Errors

Any unknown spelling causes the CLI to display the error `Unrecognized command` in response to the `?`. The CLI displays the command again as last entered.

```
> show dd?
% Unrecognized command
> show dd
```

When you press the Enter key after typing an invalid command, the CLI displays:

```
(config)#router ospf here
                        ^
% Invalid input detected at '^' marker.
```

where the `^` points to the first character in error in the command.

If a command is incomplete, the CLI displays the following message:

```
> show
% Incomplete command.
```

Some commands are too long for the display line and can wrap mid-parameter or mid-keyword, as shown below. This does *not* cause an error and the command performs as expected:

```
area 10.10.0.18 virtual-link 10.10.0.19 authent
ication-key 57393
```

Command Negation

Many commands have a `no` form that resets a feature to its default value or disables the feature. For example:

- The `ip address` command assigns an IPv4 address to an interface
- The `no ip address` command removes an IPv4 address from an interface

Syntax Conventions

[Table P-2](#) describes the conventions used to represent command syntax in this reference.

Table P-2: Syntax conventions

Convention	Description	Example
monospaced font	Command strings entered on a command line	<code>show ip ospf</code>
lowercase	Keywords that you enter exactly as shown in the command syntax.	<code>show ip ospf</code>
UPPERCASE	See Variable Placeholders	IFNAME
()	Optional parameters, from which you must select one. Vertical bars delimit the selections. Do not enter the parentheses or vertical bars as part of the command.	(A.B.C.D <0-4294967295>)
()	Optional parameters, from which you select one or none. Vertical bars delimit the selections. Do not enter the parentheses or vertical bars as part of the command.	(A.B.C.D <0-4294967295>)
()	Optional parameter which you can specify or omit. Do not enter the parentheses or vertical bar as part of the command.	(IFNAME)
{ }	Optional parameters, from which you must select one or more. Vertical bars delimit the selections. Do not enter the braces or vertical bars as part of the command.	{intra-area <1-255> inter-area <1-255> external <1-255>}

Table P-2: Syntax conventions (Continued)

Convention	Description	Example
[]	Optional parameters, from which you select zero or more. Vertical bars delimit the selections. Do not enter the brackets or vertical bars as part of the command.	[<1-65535> AA:NN internet local-AS no-advertise no-export]
?	Nonrepeatable parameter. The parameter that follows a question mark can only appear once in a command string. Do not enter the question mark as part of the command.	?route-map WORD
.	Repeatable parameter. The parameter that follows a period can be repeated more than once. Do not enter the period as part of the command.	set as-path prepend .<1-65535>

Variable Placeholders

Table P-3 shows the tokens used in command syntax use to represent variables for which you supply a value.

Table P-3: Variable placeholders

Token	Description
WORD	A contiguous text string (excluding spaces)
LINE	A text string, including spaces; no other parameters can follow this parameter
IFNAME	Interface name whose format varies depending on the platform; examples are: eth0, Ethernet0, ethernet0, xe0
A.B.C.D	IPv4 address
A.B.C.D/M	IPv4 address and mask/prefix
X:X::X:X	IPv6 address
X:X::X:X/M	IPv6 address and mask/prefix
HH:MM:SS	Time format
AA:NN	BGP community value
XX:XX:XX:XX:XX:XX	MAC address
<1-5> <1-65535> <0-2147483647> <0-4294967295>	Numeric range

Command Description Format

Table P-4 explains the sections used to describe each command in this reference.

Table P-4: Command descriptions

Section	Description
Command Name	The name of the command, followed by what the command does and when should it be used
Command Syntax	The syntax of the command
Parameters	Parameters and options for the command
Default	The state before the command is executed
Command Mode	The mode in which the command runs; see Command Modes
Example	An example of the command being executed

Keyboard Operations

Table P-5 lists the operations you can perform from the keyboard.

Table P-5: Keyboard operations

Key combination	Operation
Left arrow or Ctrl+b	Moves one character to the left. When a command extends beyond a single line, you can press left arrow or Ctrl+b repeatedly to scroll toward the beginning of the line, or you can press Ctrl+a to go directly to the beginning of the line.
Right arrow or Ctrl-f	Moves one character to the right. When a command extends beyond a single line, you can press right arrow or Ctrl+f repeatedly to scroll toward the end of the line, or you can press Ctrl+e to go directly to the end of the line.
Esc, b	Moves back one word
Esc, f	Moves forward one word
Ctrl+e	Moves to end of the line
Ctrl+a	Moves to the beginning of the line
Ctrl+u	Deletes the line
Ctrl+w	Deletes from the cursor to the previous whitespace
Alt+d	Deletes the current word
Ctrl+k	Deletes from the cursor to the end of line
Ctrl+y	Pastes text previously deleted with Ctrl+k, Alt+d, Ctrl+w, or Ctrl+u at the cursor

Table P-5: Keyboard operations (Continued)

Key combination	Operation
Ctrl+t	Transposes the current character with the previous character
Ctrl+c	Ignores the current line and redisplay the command prompt
Ctrl+z	Ends configuration mode and returns to exec mode
Ctrl+l	Clears the screen
Up Arrow or Ctrl+p	Scroll backward through command history
Down Arrow or Ctrl+n	Scroll forward through command history

Show Command Modifiers

You can use two tokens to modify the output of a `show` command. Enter a question mark to display these tokens:

```
# show users ?
  | Output modifiers
  > Output redirection
```

You can type the | (vertical bar character) to use output modifiers. For example:

```
> show rsvp | ?
begin      Begin with the line that matches
exclude    Exclude lines that match
include    Include lines that match
last       Last few lines
redirect   Redirect output
```

Begin Modifier

The `begin` modifier displays the output beginning with the first line that contains the input string (everything typed after the `begin` keyword). For example:

```
# show running-config | begin xe1
...skipping
interface xe1
  ipv6 address fe80::204:75ff:fee6:5393/64
!
interface xe2
  ipv6 address fe80::20d:56ff:fe96:725a/64
!
line con 0
  login
!
end
```

You can specify a regular expression after the `begin` keyword. This example begins the output at a line with either “xe2” or “xe4”:

```
# show running-config | begin xe[2-4]
...skipping
```

```

interface xe2
 shutdown
!
interface xe4
 shutdown
!
interface svlan0.1
 no shutdown
!
route-map myroute permit 2
!
route-map mymap1 permit 10
!
route-map rmap1 permit 2
!
line con 0
 login
line vty 0 4
 login
!
end

```

Include Modifier

The `include` modifier includes only those lines of output that contain the input string. In the output below, all lines containing the word “input” are included:

```

# show interface xe1 | include input
input packets 80434552, bytes 2147483647, dropped 0, multicast packets 0
input errors 0, length 0, overrun 0, CRC 0, frame 0, fifo 1, missed 0

```

You can specify a regular expression after the `include` keyword. This examples includes all lines with “input” or “output”:

```

#show interface xe0 | include (in|out)put
input packets 597058, bytes 338081476, dropped 0, multicast packets 0
input errors 0, length 0, overrun 0, CRC 0, frame 0, fifo 0, missed 0
output packets 613147, bytes 126055987, dropped 0
output errors 0, aborted 0, carrier 0, fifo 0, heartbeat 0, window 0

```

Exclude Modifier

The `exclude` modifier excludes all lines of output that contain the input string. In the following output example, all lines containing the word “input” are excluded:

```

# show interface xe1 | exclude input
Interface xe1
Scope: both
Hardware is Ethernet, address is 0004.75e6.5393
index 3 metric 1 mtu 1500 <UP,BROADCAST,RUNNING,MULTICAST>
VRF Binding: Not bound
Administrative Group(s): None
DSTE Bandwidth Constraint Mode is MAM
inet6 fe80::204:75ff:fee6:5393/64
output packets 4438, bytes 394940, dropped 0
output errors 0, aborted 0, carrier 0, fifo 0, heartbeat 0, window 0
collisions 0

```

You can specify a regular expression after the `exclude` keyword. This example excludes lines with “output” or “input”:

```
# show interface xe0 | exclude (in|out)put
Interface xe0
  Scope: both
  Hardware is Ethernet   Current HW addr: 001b.2139.6c4a
  Physical:001b.2139.6c4a Logical:(not set)
  index 2 metric 1 mtu 1500 duplex-full arp ageing timeout 3000
  <UP,BROADCAST,RUNNING,MULTICAST>
  VRF Binding: Not bound
  Bandwidth 100m
  DHCP client is disabled.
  inet 10.1.2.173/24 broadcast 10.1.2.255
  VRRP Master of : VRRP is not configured on this interface.
  inet6 fe80::21b:21ff:fe39:6c4a/64
  collisions 0
```

Redirect Modifier

The `redirect` modifier writes the output into a file. The output is not displayed.

```
# show cli history | redirect /var/frame.txt
```

The output redirection token (`>`) does the same thing:

```
# show cli history >/var/frame.txt
```

Last Modifier

The `last` modifier displays the output of last few number of lines (As per the user input). The last number ranges from 1 to 9999.

For example:

```
#show running-config | last 10
```

String Parameters

The restrictions in [Table P-6](#) apply for all string parameters used in OcnOS commands, unless some other restrictions are noted for a particular command.

Table P-6: String parameter restrictions

Restriction	Description
Input length	1965 characters or less
Restricted special characters	“?”, “,”, “>”, “ ”, and “=” The “ ” character is allowed only for the <code>description</code> command in interface mode.

Command Modes

Commands are grouped into modes arranged in a hierarchy. Each mode has its own set of commands. [Table P-7](#) lists the command modes common to all protocols.

Table P-7: Common command modes

Name	Description
Executive mode	Also called <i>view</i> mode, this is the first mode to appear after you start the CLI. It is a base mode from where you can perform basic commands such as <code>show</code> , <code>exit</code> , <code>quit</code> , <code>help</code> , and <code>enable</code> .
Privileged executive mode	Also called <i>enable</i> mode, in this mode you can run additional basic commands such as <code>debug</code> , <code>write</code> , and <code>show</code> .
Configure mode	Also called <i>configure terminal</i> mode, in this mode you can run configuration commands and go into other modes such as <code>interface</code> , <code>router</code> , <code>route map</code> , <code>key chain</code> , and <code>address family</code> . Configure mode is single user. Only one user at a time can be in configure mode.
Interface mode	In this mode you can configure protocol-specific settings for a particular interface. Any setting you configure in this mode overrides a setting configured in router mode.
Router mode	This mode is used to configure router-specific settings for a protocol such as BGP or OSPF.

Command Mode Tree

The diagram below shows the common command mode hierarchy.

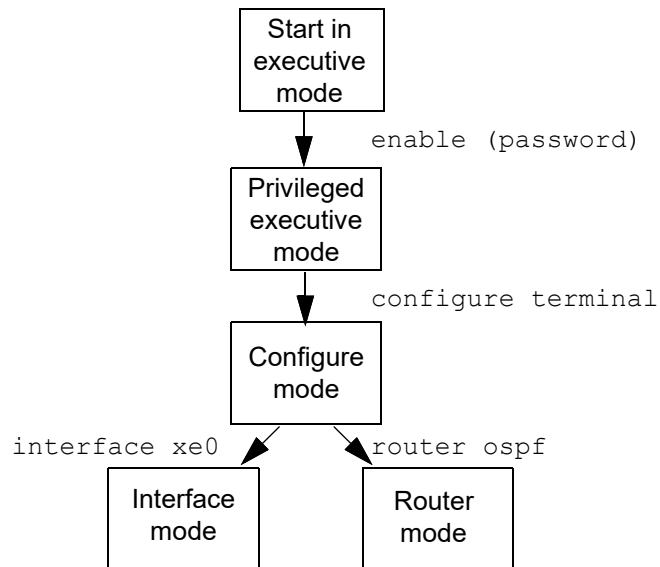

Figure P-1: Common command modes

To change modes:

1. Enter privileged executive mode by entering `enable` in Executive mode.
2. Enter configure mode by entering `configure terminal` in Privileged Executive mode.

The example below shows moving from executive mode to privileged executive mode to configure mode and finally to router mode:

```
> enable mypassword
# configure terminal
Enter configuration commands, one per line. End with CNTL/Z.
(config)# router ospf
(config-router)#
```

Note: Each protocol can have modes in addition to the common command modes. See the command reference for the respective protocol for details.

Transaction-based Command-line Interface

The OcNOS command line interface is transaction based:

- Any changes done in configure mode are stored in a separate *candidate* configuration that you can view with the `show transaction current` command.
- When a configuration is complete, apply the candidate configuration to the running configuration with the `commit` command.
- If a `commit` fails, no configuration is applied as the entire transaction is considered failed. You can continue to change the candidate configuration and then retry the `commit`.
- Discard the candidate configuration with the `abort transaction` command.
- Check the last aborted transaction with the `show transaction last-aborted` command.
- Multiple configurations cannot be removed with a single `commit`. You must remove each configuration followed by a `commit`.

Note: All commands MUST be executed only in the default CML shell (`cmlsh`). If you log in as root and start `imish`, then the system configurations will go out of sync. The `imish` shell is not supported and should not be started manually.

Virtual Extensible LAN Configuration Guide

CHAPTER 1 Overview

This chapter provides an overview of Virtual eXtensible Local Area Network (VXLAN) and its implementation with OcNOS. VXLAN creates LAN segments using a MAC in IP encapsulation. The encapsulation carries the original L2 frame received from a host to the destination in another server using IP tunnels. The endpoints of the virtualized tunnel formed using VXLAN are called VTEPs (VXLAN Tunnel EndPoints). This technology allows the network to support several tenants with minimum changes in the network. The VTEPs carry tenant data in L3 tunnels over the network. The tenant data is not used in routing or switching. This aids in tenant machine movement and allows the tenants to have the same IP or MAC addresses on end devices, hosts/VM's.

OcNOS supports VXLAN IPv4 tunnels, but both IPv4 and IPv6 hosts are supported.

Note: To configure VXLAN mapping to access ports, use one of the following two methods:

- [Enable NVO access-if mode on a physical interface](#): This method is supported in the Qumran1 series platforms.
- [Activate access-if-evpn mode on an L2 sub-interface](#): This method is supported in both Qumran1 and Qumran2 series platforms.
- Due to the BCM limitation on 9600-56DX boards, if TWAMP and VXLAN are used simultaneously, the hardware profile for NVO VXLAN should be configured last.

Terminology

Terms related to VXLAN configuration are defined in the table below.

IGMP	Internet Group Management Protocol
PIM	Protocol Independent Multicast
VLAN	Virtual Local Area Network
VM	Virtual Machine
VNI	VXLAN Network Identifier (or VXLAN Segment ID)
VTEP	VXLAN Tunnel End Point. An entity that originates and/or terminates VXLAN tunnels
VXLAN	Virtual eXtensible Local Area Network
VXLAN Segment	VXLAN Layer 2 overlay network over which VMs communicate
VXLAN Gateway	An entity that forwards traffic between VXLANs

VXLAN Architecture

VXLAN runs over the existing networking infrastructure. It provides a means to “stretch” a Layer 2 network. In short, VXLAN is a Layer 2 overlay scheme on a Layer 3 network.

Each overlay is termed as a VXLAN segment. Only VMs within the same VXLAN segment can communicate with each other. Each VXLAN segment is identified through a 24-bit segment ID termed the “VXLAN Network Identifier (VNI)”. This allows up to 16 million VXLAN segments to coexist within the same administrative domain.

VNI identifies the scope of the inner MAC frame originated by the individual VM. Hence, we can have overlapping MAC addresses across segments but never have traffic “cross over” since the traffic is isolated using the VNI. The VNI is in an outer header that encapsulates the inner MAC frame originated by the VM.

Any packets (including ARP-ND) that are uplifted to the VXLAN CPU queue from any port are rate limited to 500 packets/second. This is done to protect the system and CPU during an ARP storm.

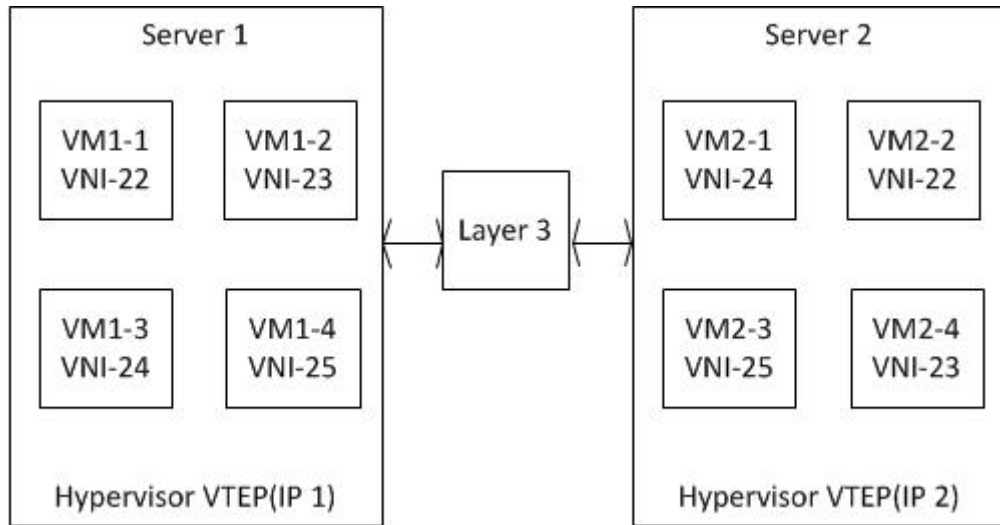

Figure 1-1: VXLAN Deployment - VTEPs across a Layer 3 Network

CHAPTER 2 VxLAN Unicast Configuration

This chapter contains basic Static-VxLAN unicast configuration examples.

Port Mapping

In this example each VTEP (VTEP1 and VTEP2) is a multilayer switch where xe2 is an access port while xe1 is network port.

After we start sending a packet (say untagged ipv4 packet) from VM1, it hits the VTEP1, VTEP1 does encapsulation based on the VNID configured and send it on xe1. Now the packet reaches VTEP2 and it does decapsulation of the packet. Now based on VNID packet is sent out on access port and it reaches destination VM, VM2.

Topology

The procedures in this section use the topology in [Figure 2-2](#)

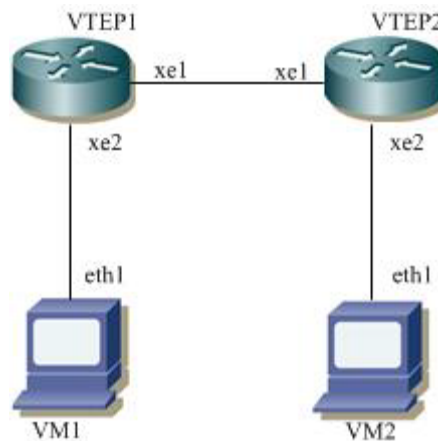

Figure 2-2: VxLAN unicast

VTEP1

#configure terminal	Enter the configure mode
(config)#interface xe2	Enter interface mode
(config-if)#switchport	Configure the interface as switchport
(config-if)#no shutdown	Bring the interface into operation with the no shutdown
(config-if)#exit	Exit interface mode
(config)#interface lo	Enter the configure mode
(config-if)#ip address 1.1.1.1/32 secondary	Configure IP address on the interface xe1
(config-if)#no shutdown	Bring the interface into operation with the no shutdown
(config-if)#exit	Exit interface mode
(config)#interface xe1	Enter the configure mode
(config-if)#ip address 5.5.5.2/24	Configure IP address on the interface xe1

(config-if)#no shutdown	Bring the interface into operation with the no shutdown
(config-if)#exit	Exit interface mode
(config)#ip route 2.2.2.2/32 5.5.5.4	Configure static route
(config)#hardware-profile filter vxlan enable	Enable hardware-profile filter for VxLAN
(config)#nvo vxlan enable	Enable VxLAN globally on this vtep
(config)#interface Tunnel 2	Specify the interface (Tunnel2)to be configured and Enter interface mode
(config-if)#tunnel mode vxlan	Assign this tunnel mode as VxLAN
(config-if)#tunnel source 1.1.1.1	Configure the source IP of this tunnel as an IP address which is configured on the interface xe1 of VTEP1
(config-if)#tunnel destination 2.2.2.2	Configure the destination IP of this tunnel as an IP address which is configured on the interface xe1 of VTEP2.
(config-if)#exit	Exit interface mode
(config-if)#nvo vxlan vtep-ip-global 1.1.1.1	Configure Source vtep-ip-global configuration - Use loopback ip address
(config)#nvo vxlan id 100 ingress-replication inner-vid-disabled	Configure a VNID on this VTEP and enter the nvo mode.
(config-nvo)#vxlan map-network tunnel Tunnel2	Map the tunnel 2 with VNID 2
(config-nvo)#exit	Exit the nvo mode
(config)#nvo vxlan access-if port xe2 10	Map the access port xe2 of this VTEP
(config-nvo-acc-if)#map vnid 100	Map the VNID 2 to access-port xe2
(config-nvo-acc-if)# arp-cache disable	Disable arp-cache - mandatory
(config-nvo-acc-if)#exit	Exit the nvo access-if mode
(config)#commit	Perform commit operation for the changes to take effect.

VTEP2

#configure terminal	Enter the configure mode
(config)#interface xe2	Enter interface mode
(config-if)#switchport	Configure the interface as switchport
(config-if)#no shutdown	Bring the interface into operation with the no shutdown
(config-if)#exit	Exit interface mode
(config)#interface lo	Enter the configure mode
(config-if)#ip address 2.2.2.2/32 secondary	Configure IP address on the interface xe1
(config-if)#no shutdown	Bring the interface into operation with the no shutdown
(config-if)#exit	Exit interface mode
(config)#interface xe1	Enter the configure mode
(config-if)#ip address 5.5.5.4/24	Configure IP address on the interface xe1
(config-if)#no shutdown	Bring the interface into operation with the no shutdown
(config-if)#exit	Exit interface mode
(config)#ip route 1.1.1.1/32 5.5.5.2	Configure static route

(config)#hardware-profile filter vxlan enable	Enable hardware-profile filter for VxLAN
(config)#nvo vxlan enable	Enable VxLAN globally on this vtep
(config)#interface tunnel 2	Specify the interface (Tunnel2)to be configured and Enter interface mode.
(config-if)#tunnel mode vxlan	Assign this tunnel mode as VxLAN
(config-if)#tunnel source 2.2.2.2	Configure the source IP of this tunnel as an IP address which is configured on the interface xe1 of VTEP1.
(config-if)#tunnel destination 1.1.1.1	Configure the destination IP of this tunnel as an IP address which is configured on the interface xe1 of VTEP2.
(config-if)#exit	Exit interface mode.
(config-if)#nvo vxlan vtep-ip-global 2.2.2.2	Configure Source vtep-ip-global configuration - Use loopback ip address
(config)#nvo vxlan id 100 ingress-replication inner-vid-disabled	Configure a VNID on this VTEP and enter the nvo mode.
(config-nvo)#vxlan map-network tunnel Tunnel2	Map the tunnel 4 with VNID 2
(config-nvo)#exit	Exit the nvo mode.
(config)#nvo vxlan access-if port xe2 10	Map the access port xe2 of this VTEP
(config-nvo-acc-if)#map vnid 100	Map the VNID 100 to access-port xe2
(config-nvo-acc-if)# arp-cache disable	Disable arp-cache - mandatory
(config-nvo-acc-if)#exit	Exit the nvo access-if mode
(config)#commit	Perform commit operation for the changes to take effect.

Validation

VTEP1

VTEP1#sh nvo vxlan tunnel

VxLAN Network tunnel Entries

Source	Destination	Status	Up/Down	Update
1.1.1.1	2.2.2.2	Installed	00:04:59	00:04:59

Total number of entries are 1

VTEP1#sh nvo vxlan mac-table

```

=====
VxLAN MAC Entries
=====
VNID      Interface VlanId   In-VlanId Mac-Addr      VTEP-Ip/ESI
  Type                Status      MAC move AccessPortDesc
-----
100      xe2      10      ----      903c.b393.e001 1.1.1.1
         Dynamic Local -----      0      -----
    
```

Total number of entries are : 1

VTEP1#sh nvo vxlan arp-cache
 VxLAN ARP-CACHE Information

```
=====
VNID      Ip-Addr      Mac-Addr      Type      Age-Out      Retries-Left
=====
```

Total number of entries are 0

VTEP1#sh nvo vxlan
 VxLAN Information

```
=====
Codes: NW - Network Port
       AC - Access Port
       (u) - Untagged
```

VNID -Range	VNI-Name DF-Status	VNI-Type Src-Addr	Type Type	Interface Dst-Addr	ESI	VLAN	Vlan
100 ----	----- 1.1.1.1	L2	NW	----- 2.2.2.2	-----		
100 ----	-----	--	AC	xe2	---	Single Homed Port	10
----	----	----		----			

Total number of entries are 2

VTEP1#

VTEP1#sh nvo vxlan access-if brief

Interface	Vlan	Inner vlan	Vlan Range	Ifindex	Vnid	Admin status	Link status
xe2	10	---	---	500000	100	up	up

Total number of entries are 1

VTEP1#

VTEP1#

```
=====
=====
```

VTEP2#

VTEP2#sh nvo vxlan tunnel
 VxLAN Network tunnel Entries

Source	Destination	Status	Up/Down	Update
2.2.2.2	1.1.1.1	Installed	00:05:30	00:05:30

Total number of entries are 1
VTEP2#sh nvo vxlan mac-table

```
=====
VxLAN MAC Entries
=====
```

VNID	Interface Type	VlanId Status	In-VlanId	Mac-Addr	VTEP-Ip/ESI
			MAC move	AccessPortDesc	
100	xe2	10	----	0018.2359.69b7	2.2.2.2
	Dynamic Local	-----	0	-----	

Total number of entries are : 1

VTEP2#sh nvo vxlan
VxLAN Information

```
=====
Codes: NW - Network Port
       AC - Access Port
       (u) - Untagged
```

VNID	VNI-Name	VNI-Type	Type	Interface	ESI	VLAN	Vlan
-Range	DF-Status	Src-Addr	Dst-Addr				
100	----	L2	NW	----	----		----
	2.2.2.2		1.1.1.1				
100	----	--	AC	xe2	---	Single Homed Port	10
	----	----		----			

Total number of entries are 2

VTEP2#sh nvo vxlan access-if brief

Interface	Vlan	Inner vlan	Vlan Range	Ifindex	Vnid	Admin status	Link status
xe2	10	---	---	500000	100	up	up

Total number of entries are 1
VTEP2#

```

=====
=====

host-1#ping 10.10.10.2
Press CTRL+C to exit
PING 10.10.10.2 (10.10.10.2) 56(84) bytes of data.
64 bytes from 10.10.10.2: icmp_seq=1 ttl=64 time=0.392 ms

--- 10.10.10.2 ping statistics ---
1 packets transmitted, 1 received, 0% packet loss, time 0ms
rtt min/avg/max/mdev = 0.392/0.392/0.392/0.000 ms

7015-Host#ping 10.10.10.1
Press CTRL+C to exit
PING 10.10.10.1 (10.10.10.1) 56(84) bytes of data.
64 bytes from 10.10.10.1: icmp_seq=1 ttl=64 time=0.704 ms
64 bytes from 10.10.10.1: icmp_seq=2 ttl=64 time=0.259 ms

```

Intermediate Non-VxLAN Router

This example is same as port mapping but we have an intermediate non VxLAN router. It does forwarding based on IP header.

Topology

The procedures in this section use the topology in [Figure 2-3](#)

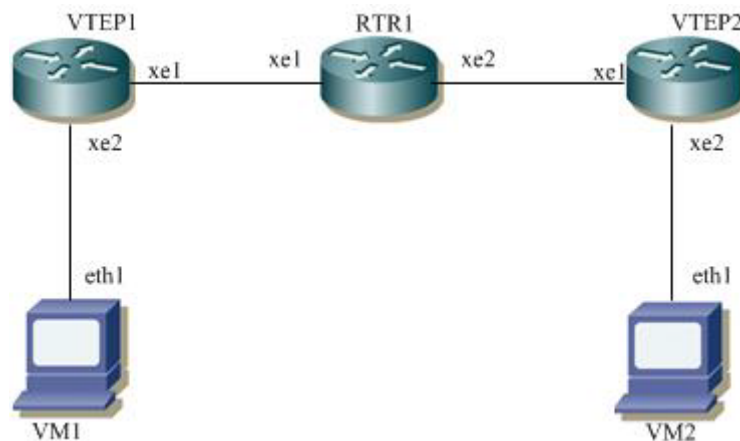

Figure 2-3: VxLAN unicast

VTEP1

#configure terminal	Enter the configure mode.
(config)#interface xe2	Enter interface mode.
(config-if)#switchport	Configure the interface as switchport.
(config-if)#no shutdown	Bring the interface into operation with the no shutdown

(config-if)#exit	Exit interface mode.
(config)#interface xe1	Enter the configure mode.
(config-if)#ip address 2.2.2.4/24	Configure IP address on the interface xe1.
(config-if)#no shutdown	Bring the interface into operation with the no shutdown
(config-if)#exit	Exit interface mode.
(config)#ip route 3.3.3.0/24 2.2.2.1	Configuring static route
(config)#hardware-profile filter vxlan enable	Enable hardware-profile filter for VxLAN
(config)#nvo vxlan enable	Enable VxLAN globally on this vtep.
(config)#interface tunnel 4	Specify the interface (Tunnel4)to be configured and Enter interface mode.
(config-if)#tunnel mode vxlan	Assign this tunnel mode as VxLAN.
(config-if)#tunnel source 2.2.2.4	Configure the source IP of this tunnel as an IP address which is configured on the interface xe1 of VTEP1.
(config-if)#tunnel destination 3.3.3.4	Configure the destination IP of this tunnel as an IP address which is configured on the interface xe1 of VTEP2.
(config-if)#exit	Exit interface mode.
(config)#nvo vxlan id 3	Configure a VNID on this VTEP and enter the nvo mode.
(config-nvo)#vxlan map-network tunnel Tunnel4	Map the tunnel 4 with this VNID
(config-nvo)#vxlan static-entry host-mac 0000.0000.aaaa remote-vtep-ip 3.3.3.4	Configure a static entry for remote VM with MAC address and IP address.
(config)#nvo vxlan access-if port xe2	Map the access port xe2 of this VTEP
(config-nvo-acc-if)#map vnid 3	Map the VNID 2 to access-port xe2
(config-nvo-acc-if)#exit	Exit NVO access-interface mode
(config)#commit	Perform commit operation for the changes to take effect.

RTR1

(config)#interface xe1	Enter the configure mode.
(config-if)#ip address 2.2.2.1/24	Configure IP address on the interface xe1.
(config-if)#no shutdown	Bring the interface into operation with the no shutdown
(config-if)#exit	Exit interface mode.
(config)#interface xe2	Enter the configure mode.
(config-if)#ip address 3.3.3.1/24	Configure IP address on the interface xe2.
(config-if)#no shutdown	Bring the interface into operation with the no shutdown
(config-if)#exit	Exit interface mode.
(config)#commit	Perform commit operation for the changes to take effect.

VTEP2

#configure terminal	Enter the configure mode.
(config)#interface xe2	Enter interface mode.

(config-if)#switchport	Configure the interface as switchport.
(config-if)#no shutdown	Bring the interface into operation with the no shutdown
(config-if)#exit	Exit interface mode.
(config)#interface xe1	Enter the configure mode.
(config-if)#ip address 3.3.3.4/24	Configure IP address on the interface xe1.
(config-if)#no shutdown	Bring the interface into operation with the no shutdown
(config-if)#exit	Exit interface mode.
(config)#ip route 2.2.2.0/24 3.3.3.1	Configuring static route
(config)#hardware-profile filter vxlan enable	Enable hardware-profile filter for VxLAN
(config)#nvo vxlan enable	Enable VxLAN globally on this vtep.
(config)#interface tunnel 4	Specify the interface (Tunnel4)to be configured and Enter interface mode.
(config-if)#tunnel mode vxlan	Assign this tunnel mode as VxLAN.
(config-if)#tunnel source 3.3.3.4	Configure the source IP of this tunnel as an IP address which is configured on the interface xe1 of VTEP1.
(config-if)#tunnel destination 2.2.2.4	Configure the destination IP of this tunnel as an IP address which is configured on the interface xe1 of VTEP2.
(config-if)#exit	Exit interface mode.
(config)#nvo vxlan id 3	Configure a VNID on this VTEP and enter the nvo mode.
(config-nvo)#vxlan map-network tunnel Tunnel4	Map the tunnel 4 with this VNID
(config-nvo)#vxlan static-entry host-mac 0000.0000.bbbb remote-vtep-ip 2.2.2.4	Configure a static entry for remote VM with MAC address and IP address.
(config)#nvo vxlan access-if port xe2	Map the access port xe2 of this VTEP
(config-nvo-acc-if)#map vnid 3	Map the VNID 3 to access-port xe2
(config-nvo-acc-if)#exit	Exit the NVO access interface mode
(config)#commit	Perform commit operation for the changes to take effect.

Validation

VTEP1

```
VTEP1#show nvo vxlan tunnel
VxLAN Network tunnel Entries
```

Source	Destination	Status	Up/Down	Update
--------	-------------	--------	---------	--------

2.2.2.4	3.3.3.4	Installed	00:37:56	00:37:56
---------	---------	-----------	----------	----------

Total number of entries are 1

```
VTEP1#show nvo vxlan
```

```
VxLAN Information
```

```
=====
```

```
Codes: NW - Network Port
```

```
AC - Access Port
```

```
(u) - Untagged
```

VNID	VNI-Name	VNI-Type	Type	Interface	ESI	VLAN	DF-
Status	Src-Addr	Dst-Addr					

3	----	L2	NW	----	-----	----	--
--	2.2.2.4	3.3.3.4					
3	----	AC	xe2		---	Single Homed Port	---

Total number of entries are 2

VTEP1#

VTEP1#show nvo vxlan mac-table

```

=====
=====
=====
                                     VxLAN MAC Entries
=====
=====
=====

```

VNID	Interface	VlanId	Inner-VlanId	Mac-Addr	VTEP-Ip/ESI
Type		Status		AccessPortDesc	
3	----	----	----	0000.0000.aaaa	3.3.3.4
Static	Remote	-----		-----	
3	xe2	----	----	0000.0000.bbbb	Dynamic
Local	-----		-----		

Total number of entries are : 2

VTEP1#sh nvo vxlan mac-table vnid 3

```

=====
=====
=====
                                     VxLAN MAC Entries
=====
=====
=====

```

VNID	Interface	VlanId	Inner-VlanId	Mac-Addr	VTEP-Ip/ESI
Type		Status		AccessPortDesc	
3	----	----	----	0000.0000.aaaa	3.3.3.4
Static	Remote	-----		-----	
3	xe2	----	----	0000.0000.bbbb	Dynamic
Local	-----		-----		

Total number of entries are : 2

VTEP2

VTEP2#show nvo vxlan tunnel

VxLAN Network tunnel Entries

Source	Destination	Status	Up/Down	Update
3.3.3.4	2.2.2.4	Installed	00:34:02	00:34:02

Total number of entries are 1

VTEP2#show nvo vxlan

VxLAN Information

=====

Codes: NW - Network Port
 AC - Access Port
 (u) - Untagged

VNID	VNI-Name	VNI-Type	Type	Interface	ESI	VLAN	DF-
Status	Src-Addr	Dst-Addr					

3	----	L2	NW	----	-----	----	--
--	3.3.3.4	2.2.2.4					
3	----	--	AC	xe1	---	Single Homed Port	---
--	----	----					--

Total number of entries are 2

VTEP2#sh nvo vxlan mac-table

=====

VxLAN MAC Entries

VNID	Interface	VlanId	Inner-VlanId	Mac-Addr	VTEP-Ip/ESI
Type		Status		AccessPortDesc	
3	xe1	----	----	0000.0000.aaaa	
Local	-----		-----		Dynamic
3	----	----	----	0000.0000.bbbb	2.2.2.4
Static	-----	-----		-----	

Total number of entries are : 2

VTEP2#sh nvo vxlan mac-table vnid 3

=====

VxLAN MAC Entries

VNID	Interface	VlanId	Inner-VlanId	Mac-Addr	VTEP-Ip/ESI
Type		Status		AccessPortDesc	

```

3          xe1          ----  ----          0000.0000.aaaa          Dynamic
Local      -----          -----
3          ----          ----  ----          0000.0000.bbbb 2.2.2.4
Static Remote      -----          -----

```

Total number of entries are : 2

CHAPTER 3 VXLAN-EVPN Configuration

This section provides basic VXLAN-EVPN configuration examples.

Virtual eXtended LAN (VXLAN) creates LAN segments using MAC-in-IP encapsulation. The encapsulation carries the original L2 frame received from a host to the destination in another host using IP tunnels. The endpoints of the virtualized tunnel formed using VXLAN are called VXLAN Tunnel End Points (VTEPs). VTEPs carry tenant data in L3 tunnels over the network, allowing the network to support multiple tenants. The tenant data is not used in routing or switching, aiding tenant machine movement and allowing tenants to use the same IP/MAC addresses.

In VXLAN, BGP-MP carries crucial information about the VM to reach the VTEP.

MAC VRF supports both manual RT and auto RT modes.

Note: For port-channel/static-channel interfaces, storm control applies to each member port. For example, if interface eth1 and interface eth2 are part of port-channel po1 with storm control set to 2 Mbps for broadcast traffic, then the storm control settings will apply to each member port, rate limiting broadcast traffic to 2 Mbps per port.

Topology

The procedures in this section use the topology in [Figure 3-4](#).

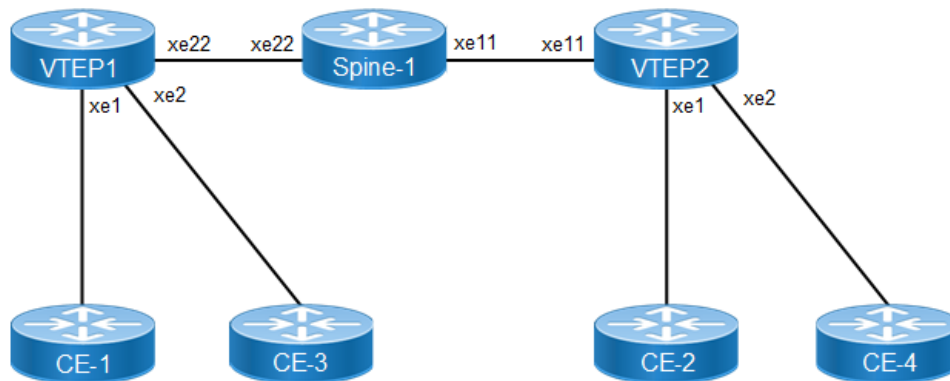

Figure 3-4: VXLAN EVPN

Configure VXLAN mapping to access ports using one of the following two methods:

- Enable NVO access-if mode on a physical interface.
- Activate access-if-evpn mode on an L2 sub-interface.

VTEP1

Enable NVO access-if mode on a physical interface

#configure terminal	Enter configure mode
(config)#interface xe1	Enter interface mode
(config-if)#switchport	Configure the interface as a switch port.
(config-if)#no shutdown	Bring the interface into operation
(config-if)#exit	Exit interface mode
(config)#interface xe2	Enter interface mode

(config-if)#switchport	Configure the interface as switch port.
(config-if)#no shutdown	Bring the interface into operation.
(config-if)#exit	Exit interface mode.
(config)#interface xe22	Enter interface mode.
(config-if)#ip address 10.1.1.1/24	Set an IP address on the interface.
(config-if)#no shutdown	Bring the interface into operation.
(config-if)#exit	Exit interface mode.
(config)#interface lo	Enter interface mode.
(config-if)#ip address 1.1.1.1/32 secondary	Set an IP address on the interface.
(config-if)#no shutdown	Bring the interface into operation.
(config-if)#exit	Exit interface mode.
(config)#router isis ABC	Create an IS-IS routing instance (ABC).
(config-router)#is-type level-1	Configure instance as level-1-only routing.
(config-router)#net 49.0001.1111.1111.1111.00	Set a Network Entity Title for this instance, specifying the area address and the system ID.
(config-router)#exit	Exit router mode.
(config)#interface xe22	Enter interface mode
(config-if)#ip router isis ABC	Enable IS-IS routing on an interface (ABC).
(config-if)#isis circuit-type level-1	Configure instance as level-1-only routing.
(config-if)#exit	Exit interface mode.
(config)#interface lo	Enter interface mode.
(config-if)#ip router isis ABC	Enable IS-IS routing on an interface for area 49 (ABC).
(config-if)#isis circuit-type level-1	Configure instance as level-1-only routing.
(config-if)#exit	Exit interface mode.
(config)#mac vrf vrf_evpn_100	Configure a new VRF named <code>vrf_evpn_100</code> .
(config-vrf)#rd 1.1.1.1:1	Assign the Route Distinguisher value.
(config-vrf)#route-target both 100:1	Configure route target to import and export the routes.
(config-vrf)#exit	Exit VRF mode.
(config)#mac vrf vrf_evpn_200	Configure a new VRF named <code>vrf_evpn_200</code> .
(config-vrf)#rd 1.1.1.1:2	Assign the Route Distinguisher value.
(config-vrf)#route-target both evpn-auto- rt	Configure route target to import and export the routes.
(config-vrf)#exit	Exit VRF mode.
(config)#router bgp 1	Define the routing process. The number 1 specifies the AS number of VTEP1.
(config-router)#bgp router-id 1.1.1.1	Configure router-id for this BGP process.
(config-router)#neighbor 2.2.2.2 remote-as 1	Define BGP neighbor: 2.2.2.2 is the IP address of the neighbor (VTEP2), and 1 is the neighbor's AS number.
(config-router)# neighbor 2.2.2.2 update- source 1.1.1.1	Define BGP neighbor: 1.1.1.1 is the peer interface.
(config-router)#address-family l2vpn evpn	Configure address-family L2VPN EVPN.

(config-router-af)#neighbor 2.2.2.2 activate	Activate the neighbor in the EVPN address family.
(config-router-af)#exit-address-family	Exit the address-family mode.
(config-router)#exit	Exit router mode.
(config)#hardware-profile filter vxlan enable	Enable hardware-profile filter for VXLAN.
(config)#nvo vxlan enable	Enable VXLAN globally on this VTEP.
(config)#nvo vxlan vtep-ip-global 1.1.1.1	Assign a global IP to the VTEP.
(config)#nvo vxlan id 100 ingress-replication	Configure a VNID on this VTEP and enter NVO mode.
(config-nvo)#vxlan host-reachability-protocol evpn-bgp vrf_evpn_100	Configure host-reachability-protocol as BGP-EVPN and associate the VNID with vrf_evpn_100.
(config-nvo)#exit	Exit NVO mode.
(config)#nvo vxlan access-if port-vlan xe1 2	Configure access-port xe1 and map vlan 2
(config-nvo-acc-if)#map vnid 100	Map VNID 100 to access-port xe1.
(config-nvo-acc-if)#exit	Exit NVO access-if mode.
(config)#nvo vxlan id 200 ingress-replication	Configure second VNID on this VTEP and enter NVO mode.
(config-nvo)#vxlan host-reachability-protocol evpn-bgp vrf_evpn_200	Configure host-reachability-protocol as BGP-EVPN and associate the VNID with vrf_evpn_200
(config-nvo)#exit	Exit NVO mode.
(config)#nvo vxlan access-if port-vlan xe2 3	Configure access-port xe2 and map vlan 3
(config-nvo-acc-if)#map vnid 200	Map VNID 200 to access-port xe2.
(config-nvo-acc-if)#exit	Exit NVO access-if mode.
(config)#commit	Commit the configurations

Activate access-if-evpn mode on an L2 sub-interface

(config)#interface xe1.1 switchport	Create L2 subinterface xe1.1
(config-if)#encapsulation dot1q 2	Configure encapsulation dot1q with vlan-id 2
(config-if)#access-if-evpn	Enter access-if-evpn mode
(config-acc-if-evpn)#map vpn-id 100	Map vnid 100 to access interface xe1.1
(config-acc-if-evpn)#exit	Exit access-if-evpn mode
(config)#interface xe2.1 switchport	Create L2 subinterface xe2.1
(config-if)#encapsulation dot1q 3	Configure encapsulation dot1q with vlan-id 3
(config-if)#access-if-evpn	Enter access-if-evpn mode
(config-acc-if-evpn)#map vpn-id 200	Map vnid 200 to access interface xe2.1
(config-acc-if-evpn)#exit	Exit access-if-evpn mode
(config-if)#commit	Commit the configurations

Spine-1

#configure terminal	Enter configure mode.
(config)#interface xe22	Enter interface mode.
(config-if)#ip address 10.1.1.2/24	Set an IP address on the interface.
(config-if)#no shutdown	Bring the interface into operation
(config-if)#exit	Exit interface mode.
(config)#interface xe11	Enter interface mode.
(config-if)#ip address 20.1.1.2/24	Set an IP address on the interface.
(config-if)#no shutdown	Bring the interface into operation
(config-if)#exit	Exit interface mode.
(config)#router isis ABC	Create an IS-IS routing instance (ABC).
(config-router)#is-type level-1	Configure instance as level-1-only routing.
(config-router)#net 49.0001.3333.3333.3333.00	Set a Network Entity Title for this instance, specifying the area address and the system ID.
(config-router)#exit	Exit router mode.
(config)#interface xe22	Enter interface mode.
(config-if)#ip router isis ABC	Enable IS-IS routing on an interface (ABC).
(config-if)#isis circuit-type level-1	Configure instance as level-1-only routing.
(config-if)#exit	Exit interface mode.
(config)#interface xe11	Enter interface mode.
(config-if)#ip router isis ABC	Enable IS-IS routing on an interface (ABC).
(config-if)#isis circuit-type level-1	Configure instance as level-1-only routing.
(config-if)#exit	Exit interface mode.
(config)#commit	Commit the configurations

VTEP2**Enable NVO access-if mode on a physical interface**

#configure terminal	Enter configure mode.
(config)#interface xe1	Enter interface mode.
(config-if)#switchport	Configure the interface as switchport.
(config-if)#no shutdown	Bring the interface into operation
(config-if)#exit	Exit interface mode.
(config)#interface xe2	Enter interface mode.
(config-if)#switchport	Configure the interface as switchport.
(config-if)#no shutdown	Bring the interface into operation
(config-if)#exit	Exit interface mode.
(config)#interface xe11	Enter interface mode.
(config-if)#ip address 20.1.1.1/24	Set an IP address on the interface.
(config-if)#no shutdown	Bring the interface into operation

(config-if)#exit	Exit interface mode.
(config)#interface lo	Enter interface mode.
(config-if)#ip address 2.2.2.2/32 secondary	Set an IP address on the interface.
(config-if)#no shutdown	Bring the interface into operation
(config-if)#exit	Exit interface mode.
(config)#router isis ABC	Create an IS-IS routing instance (ABC).
(config-router)#is-type level-1	Configure instance as level-1-only routing.
(config-router)#net 49.0001.2222.2222.2222.00	Set a Network Entity Title for this instance, specifying the area address and the system ID.
(config-router)#exit	Exit router mode.
(config)#interface xell	Enter interface mode.
(config-if)#ip router isis ABC	Enable IS-IS routing on an interface (ABC).
(config-if)#isis circuit-type level-1	Configure instance as level-1-only routing.
(config-if)#exit	Exit interface mode.
(config)#interface lo	Enter interface mode.
(config-if)#ip router isis ABC	Enable IS-IS routing on an interface for area 49 (ABC).
(config-if)#isis circuit-type level-1	Configure instance as level-1-only routing.
(config-if)#exit	Exit interface mode.
(config)#mac vrf vrf_evpn_100	Configure a new VRF named vrf_evpn_100.
(config-vrf)#rd 2.2.2.2:1	Assign the Route Distinguisher value.
(config-vrf)#route-target both 100:1	Configure route target to import and export the routes.
(config-vrf)#exit	Exit VRF mode.
(config)#mac vrf vrf_evpn_200	Configure a new VRF named vrf_evpn_200.
(config-vrf)#rd 2.2.2.2:2	Assign the Route Distinguisher value.
(config-vrf)#route-target both evpn-auto-rt	Configure route target to import and export the routes.
(config-vrf)#exit	Exit VRF mode.
(config)#router bgp 1	Define the routing process. The number 1 specifies the AS number of VTEP1.
(config-router)#neighbor 1.1.1.1 remote-as 1	Define BGP neighbor: 1.1.1.1 is the IP address of the neighbor (VTEP1), and 1 is the neighbor's AS number.
(config-router)# neighbor 1.1.1.1 update-source 2.2.2.2	Define BGP neighbor: 2.2.2.2 is the peer interface.
(config-router)#address-family l2vpn evpn	Configure address-family L2VPN EVPN.
(config-router-af)#neighbor 1.1.1.1 activate	Activate the neighbor in the EVPN address family.
(config-router-af)#exit-address-family	Exit address-family mode.
(config-router)#exit	Exit router mode.
(config)#hardware-profile filter vxlan enable	Enable hardware-profile filter for VXLAN.
(config)#nvo vxlan enable	Enable VXLAN globally on this VTEP.
(config)#nvo vxlan vtep-ip-global 2.2.2.2	Assign a global IP to the VTEP.
(config)#nvo vxlan id 100 ingress-replication	Configure a VNID on this VTEP and enter NVO mode.

(config-nvo)#vxlan host-reachability-protocol evpn-bgp vrf_evpn_100	Configure host-reachability-protocol as BGP-EVPN and associate the VNID with vrf_evpn_100.
(config-nvo)#exit	Exit NVO mode.
(config)#nvo vxlan access-if port-vlan xe1 2	Configure access-port xe1 and map vlan 2
(config-nvo-acc-if)#map vnid 100	Map VNID 100 to access-port xe1.
(config-nvo-acc-if)#exit	Exit NVO access-if mode.
(config)#nvo vxlan id 200 ingress-replication	Configure second VNID on this VTEP and enter NVO mode.
(config-nvo)#vxlan host-reachability-protocol evpn-bgp vrf_evpn_200	Configure host-reachability-protocol as BGP-EVPN and associate the VNID with vrf_evpn_200.
(config-nvo)#exit	Exit NVO mode.
(config)#nvo vxlan access-if port-vlan xe2 3	Configure access-port xe2 and map vlan 3
(config-nvo-acc-if)#map vnid 200	Map VNID 200 to access-port xe2.
(config-nvo-acc-if)#exit	Exit NVO access-if mode.
(config)#commit	Commit the configurations

Activate access-if-evpn mode on an L2 sub-interface

(config)#interface xe1.1 switchport	Create L2 subinterface xe1.1
(config-if)#encapsulation dot1q 2	Configure encapsulation dot1q with vlan-id 2
(config-if)#access-if-evpn	Enter access-if-evpn mode
(config-acc-if-evpn)#map vpn-id 100	Map vnid 100 to access interface xe1.1
(config-acc-if-evpn)#exit	Exit access-if-evpn mode
(config)#interface xe2.1 switchport	Create L2 subinterface xe2.1
(config-if)#encapsulation dot1q 3	Configure encapsulation dot1q with vlan-id 3
(config-if)#access-if-evpn	Enter access-if-evpn mode
(config-acc-if-evpn)#map vpn-id 200	Map vnid 200 to access interface xe2.1
(config-acc-if-evpn)#exit	Exit access-if-evpn mode
(config-if)#commit	Commit the configurations

Validation

CE1 and CE2 have hosts configured with MAC addresses, IP addresses, and VLAN identifiers as shown below.

		VLAN	IP Address	Mac Address
VTEP1	CE-1	2	12.12.12.10	0000.0000.abab
VTEP2	CE-2	2	12.12.12.20	0000.0000.cdcd

		VLAN	IP Address	Mac Address
VTEP1	CE-1	3	13.13.13.10	0000:0b60:25f2
VTEP2	CE-2	3	13.13.13.20	0000:0b60:25f3

Perform a tagged ping of VLAN 2 from CE1 to CE2 and vice-versa. Also perform a tagged ping of VLAN 3 from CE1 to CE2 and vice-versa.

VTEP Tunnel Status

VTEP1#show nvo vxlan tunnel

VxLAN Network tunnel Entries

Source	Destination	Status	Up/Down	Update
1.1.1.1	2.2.2.2	Installed	00:05:53	00:05:53

Total number of entries are 1

VTEP2#show nvo vxlan tunnel

VxLAN Network tunnel Entries

Source	Destination	Status	Up/Down	Update
2.2.2.2	1.1.1.1	Installed	00:05:46	00:05:46

Total number of entries are 1

VTEP ARP Cache

VTEP1#sh nvo vxlan arp-cache

VxLAN ARP-CACHE Information

=====

ARP Timeout : 300 sec Random-Jitter-Max : 640

VNID	Ip-Addr	Mac-Addr	Type	Age-Out
200	13.13.13.10	0000.0b60.25f2	Dynamic Local	246
200	13.13.13.20	0000.0b60.25f3	Dynamic Remote	-----
100	12.12.12.20	0000.0000.cdcd	Dynamic Remote	-----
100	12.12.12.10	0000.0000.abab	Dynamic Local	246

Total number of entries are 4

VTEP2#sh nvo vxlan arp-cache

VxLAN ARP-CACHE Information

=====

ARP Timeout : 300 sec Random-Jitter-Max : 640

VNID	Ip-Addr	Mac-Addr	Type	Age-
200	13.13.13.10	0000.0b60.25f2	Dynamic Remote	-----
200	13.13.13.20	0000.0b60.25f3	Dynamic Local	257
100	12.12.12.10	0000.0000.abab	Dynamic Remote	-----

```
100      12.12.12.20      0000.0000.cdcd      Dynamic Local      257
2
```

Total number of entries are 4

VTEP MAC Tables

VTEP1#show nvo vxlan mac-table

```
=====
                        VxLAN MAC Entries
=====
VNID   Interface  VlanId  Inner-VlanId  Mac-Addr      VTEP-Ip/ESI  Type
Status AccessPortDesc
-----
100     ----          ----          ----          ----          0000.0000.cdcd  2.2.2.2
Dynamic Remote  -----
100     xe1           2             ----          0000.0000.abab  1.1.1.1
Dynamic Local   -----
200     xe2           3             ----          0000.0b60.25f2  1.1.1.1
Dynamic Local   -----
200     ----          ----          ----          0000.0b60.25f3  2.2.2.2
Dynamic Remote  -----
Total number of entries are : 4
```

VTEP2#show nvo vxlan mac-table

```
=====
                        VxLAN MAC Entries
=====
VNID   Interface  VlanId  Inner-VlanId  Mac-Addr      VTEP-Ip/ESI  Type
Status AccessPortDesc
-----
100     xe1           2             ----          0000.0000.cdcd  2.2.2.2
Dynamic Local   -----
100     ----          ----          ----          0000.0000.abab  1.1.1.1
Dynamic Remote  -----
200     ----          ----          ----          0000.0b60.25f2  1.1.1.1
Dynamic Remote  -----
200     xe2           3             ----          0000.0b60.25f3  2.2.2.2
Dynamic Local   -----
Total number of entries are : 4
```

MAC VRF Manual RT

```
VTEP1#show mac vrf vrf_evpn_100
VRF vrf_evpn_100, FIB ID 4098
  Router ID is not set
Interfaces:
VRF vrf_evpn_100; default RD 1.1.1.1:1
  RT:100:1
Import VPN route-target communities
  RT:100:1
No import route-map
```

```
No export route-map
VPNv4 label allocation mode: per-vrf
VPNv6 label allocation mode: per-vrf
import-vnid: 100
export-vnid: 100
```

MAC VRF Auto RT

```
VTEP1#show mac vrf vrf_evpn_200
VRF vrf_evpn_200, FIB ID 4098
  Router ID is not set
Interfaces:
VRF vrf_evpn_200; default RD 1.1.1.1:2
  Evpn Auto RT:1:268435856
  Evpn Auto RT:1:268435656
Import VPN route-target communities
  Evpn Auto RT:1:268435856
  Evpn Auto RT:1:268435656
No import route-map
No export route-map
VPNv4 label allocation mode: per-vrf
VPNv6 label allocation mode: per-vrf
import-vnid: 200
export-vnid: 200
```

Access IF EVPN Mode on L2 Sub-interface

```
VTEP1#show nvo vxlan mac-table
```

```
=====
                                VXLAN MAC Entries
=====
```

VNID Status	Interface AccessPortDesc	VlanId	Inner-VlanId	Mac-Addr	VTEP-IP/ESI	Type
100 Dynamic Remote	----	-----	----	----	0000.0000.cdcd	2.2.2.2
100 Dynamic Local	xe1.1	-----	2	----	0000.0000.abab	1.1.1.1
200 Dynamic Local	xe2.1	-----	3	----	0000.0b60.25f2	1.1.1.1
200 Dynamic Remote	----	-----	----	----	0000.0b60.25f3	2.2.2.2

Total number of entries are : 4

VTEP MAC-IP BGP EVPN Entries

```
VTEP1#show bgp l2vpn evpn mac-ip
RD[1.1.1.1:1] VRF[vrf_evpn_100]:
```

ESI Nexthop	Eth-Tag GW-Type	Mac-Address	IP-Address	VNID	L3VNID
----------------	--------------------	-------------	------------	------	--------

```

0          100          0000:0000:abab    12.12.12.10    100      0
1.1.1.1    --
0          200          0000:0b60:25f2    13.13.13.10    200      0
1.1.1.1    --

```

RD[2.2.2.2:1]

ESI	Eth-Tag	Mac-Address	IP-Address	VNID	L3VNID	Nexthop
0	100	0000:0000:cdcd	12.12.12.20	100		0
2.2.2.2	--					
0	200	0000:0b60:25f3	13.13.13.20	200		0
2.2.2.2	--					

VTEP2#show bgp l2vpn evpn mac-ip

RD[1.1.1.1:1]

ESI	Eth-Tag	Mac-Address	IP-Address	VNID	L3VNID
0	100	0000:0000:abab	12.12.12.10	100	0
1.1.1.1	--				
0	200	0000:0b60:25f2	13.13.13.10	200	0
1.1.1.1	--				

RD[2.2.2.2:1] VRF[vrf_evpn_100]:

ESI	Eth-Tag	Mac-Address	IP-Address	VNID	L3VNID
0	100	0000:0000:cdcd	12.12.12.20	100	0
2.2.2.2	--				
0	100	0000:0b60:25f2	13.13.13.10	100	0
2.2.2.2	--				

LAG as Access Port with ECMP on the Network Side

This section contains basic VXLAN EVPN configuration with LAG as an access port and ECMP on the network side.

Topology

The procedures in this section use the topology in [Figure 3-5](#).

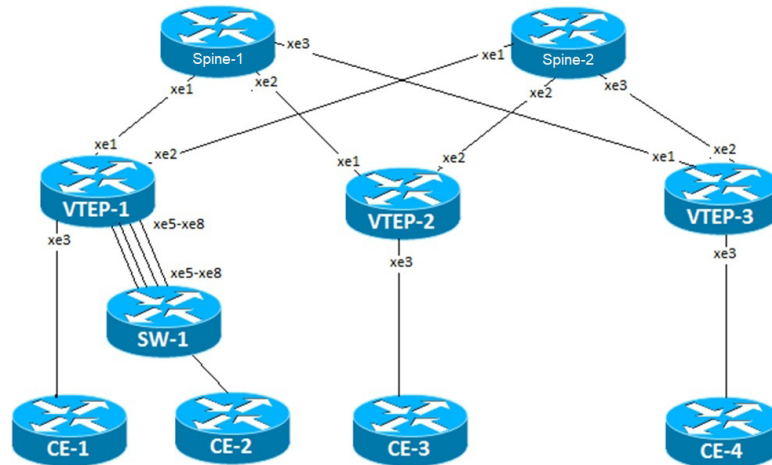

Figure 3-5: VXLAN EVPN with LAG and ECMP

SW-1

#configure terminal	Enter configure mode
(config)#bridge 1 protocol ieee vlan-bridge	Configure IEEE vlan bridge
(config)#vlan database	Enter into the vlan database
(config-vlan)#vlan 2 bridge 1 state enable	Configure vlan 2 and associate with bridge 1
(config-vlan)#vlan 3 bridge 1 state enable	Configure vlan 3 and associate with bridge 1
(config-vlan)#exit	Exit from the vlan database
(config)#interface xe1	Enter interface mode
(config-if)#no shutdown	Make interface admin up
(config-if)#switchport	Set the interface as Layer2 port
(config-if)#bridge-group 1	Associate the Interface with bridge-group.
(config-if)#switchport mode trunk	Set the switching characteristics of this interface to trunk mode
(config-if)#switchport trunk allowed vlan add 2	Configure the VLANs that should be allowed through this interface
(config-if)#switchport trunk allowed vlan add 3	Configure the VLANs that should be allowed through this interface
(config-if)#exit	Exit interface mode.
(config)#interface po1	Enter interface mode
(config-if)#switchport	Set the interface as Layer2 port
(config-if)#exit	Exit interface mode.
(config)#interface xe5	Enter interface mode
(config-if)#switchport	Set the interface as Layer2 port
(config-if)#channel-group 1 mode active	Configure the interface to be part of port channel 1
(config-if)#exit	Exit interface mode.
(config)#interface xe6	Enter interface mode
(config-if)#switchport	Set the interface as Layer2 port
(config-if)#channel-group 1 mode active	Configure the interface to be part of port channel 1

(config-if)#exit	Exit interface mode.
(config)#interface xe7	Enter interface mode
(config-if)#switchport	Set the interface as Layer2 port
(config-if)#channel-group 1 mode active	Configure the interface to be part of port channel 1
(config-if)#exit	Exit interface mode.
(config)#interface xe8	Enter interface mode
(config-if)#switchport	Set the interface as Layer2 port
(config-if)#channel-group 1 mode active	Configure the interface to be part of port channel 1
(config-if)#exit	Exit interface mode.
(config-if)#interface xe2	Enter interface mode
(config-if)#bridge-group 1	Associate the Interface with bridge-group.
(config-if)#switchport mode trunk	Set the switching characteristics of this interface to trunk mode
(config-if)#switchport trunk allowed vlan add 2	Configure the VLANs that should be allowed through this interface
(config-if)#switchport trunk allowed vlan add 3	Configure the VLANs that should be allowed through this interface
(config-if)#exit	Exit interface mode.
(config)#commit	Commit the configurations

VTEP-1

#configure terminal	Enter configure mode
(config)#interface po1	Create interface po1
(config-if)#switchport	Configure the interface as switchport.
(config-if)#exit	Exit interface mode
(config)#interface xe3	Enter interface mode.
(config-if)#switchport	Configure the interface as switchport.
(config-if)#no shutdown	Bring the interface into operation
(config-if)#exit	Exit interface mode
(config)#interface xe5	Enter interface mode
(config-if)#switchport	Configure the interface as switchport.
(config-if)#channel-group 1 mode active	Configure the interface to be part of port channel 1
(config-if)#no shutdown	Bring the interface into operation
(config-if)#exit	Exit interface mode
(config)#interface xe6	Enter interface mode
(config-if)#switchport	Configure the interface as switchport.
(config-if)#channel-group 1 mode active	Configure the interface to be part of port channel 1
(config-if)#no shutdown	Bring the interface into operation
(config-if)#exit	Exit interface mode
(config)#interface xe7	Enter interface mode
(config-if)#switchport	Configure the interface as switchport.

(config-if)#channel-group 1 mode active	Configure the interface to be part of port channel 1
(config-if)#no shutdown	Bring the interface into operation
(config-if)#exit	Exit interface mode
(config)#interface xe8	Enter interface mode
(config-if)#switchport	Configure the interface as switchport.
(config-if)#channel-group 1 mode active	Configure the interface to be part of port channel 1
(config-if)#no shutdown	Bring the interface into operation
(config-if)#exit	Exit interface mode.
(config)#interface xe1	Enter interface mode.
(config-if)#ip address 10.1.1.0/31	Configure IP address on the interface xe1.
(config-if)#no shutdown	Bring the interface into operation
(config-if)#exit	Exit interface mode.
(config)#interface xe2	Enter interface mode.
(config-if)#ip address 10.1.1.2/31	Configure IP address on the interface xe2.
(config-if)#no shutdown	Bring the interface into operation
(config-if)#exit	Exit interface mode.
(config)#interface lo	Enter interface mode.
(config-if)#ip address 1.1.1.1/32 secondary	Configure IP address on the loopback interface.
(config-if)#no shutdown	Bring the interface into operation
(config-if)#exit	Exit interface mode.
(config)#router isis ABC	Create an IS-IS routing instance (ABC).
(config-router)#is-type level-1	Configure instance as level-1-only routing.
(config-router)#net 49.0001.1111.1111.1111.00	Set a Network Entity Title for this instance, specifying the area address and the system ID.
(config-router)#exit	Exit router mode.
(config)#interface xe1	Enter interface mode.
(config-if)#ip router isis ABC	Enable IS-IS routing on an interface (ABC).
(config-if)#isis circuit-type level-1	Configure instance as level-1-only routing.
(config-if)#exit	Exit interface mode.
(config)#interface xe2	Enter interface mode.
(config-if)#ip router isis ABC	Enable IS-IS routing on an interface (ABC).
(config-if)#isis circuit-type level-1	Configure instance as level-1-only routing.
(config-if)#exit	Exit interface mode.
(config)#interface lo	Enter interface mode.
(config-if)#ip router isis ABC	Enable IS-IS routing on an interface for area 49 (ABC).
(config-if)#isis circuit-type level-1	Configure instance as level-1-only routing.
(config-if)#exit	Exit interface mode.
(config)#mac vrf vrf_evpn_100	Configure a new VRF named <code>vrf_evpn_100</code> .
(config-vrf)#rd 1.1.1.1:1	Assign the Route Distinguisher value.
(config-vrf)#route-target both 100:1	Configure route target to import and export the routes.

(config-vrf)#exit	Exit VRF mode.
(config)#router bgp 65535	Define the routing process. The number 65535 specifies the AS number of VTEP-1.
(config-router)#bgp router-id 1.1.1.1	Configure router-id for this BGP process.
(config-router)#neighbor 2.2.2.2 remote-as 65535	Define BGP neighbor: 2.2.2.2 is the IP address of the neighbor (VTEP-2), and 65535 is the neighbor's AS number.
(config-router)# neighbor 2.2.2.2 update-source 1.1.1.1	Define BGP neighbor: 1.1.1.1 is the peer interface.
(config-router)#neighbor 3.3.3.3 remote-as 65535	Define BGP neighbor: 3.3.3.3 is the IP address of the neighbor (VTEP-3), and 65535 is the neighbor's AS number.
(config-router)# neighbor 3.3.3.3 update-source 1.1.1.1	Define BGP neighbor: 1.1.1.1 is the peer interface.
(config-router)#address-family l2vpn evpn	Configure address-family L2VPN EVPN.
(config-router-af)#neighbor 2.2.2.2 activate	Activate the neighbor at VTEP-2 in the EVPN address family.
(config-router-af)#neighbor 3.3.3.3 activate	Activate the neighbor at VTEP-3 in the EVPN address family.
(config-router-af)#exit-adress-family	Exit address-family mode.
(config-router)#exit	Exit router mode.
(config)#hardware-profile filter vxlan enable	Enable hardware-profile filter for VXLAN.
(config)#nvo vxlan enable	Enable VXLAN globally on this VTEP.
(config)#nvo vxlan vtep-ip-global 1.1.1.1	Assign a global IP to the VTEP.
(config)#nvo vxlan id 100001 ingress-replication	Configure a VNID on this VTEP and enter NVO mode.
(config-nvo)#vxlan host-reachability-protocol evpn-bgp vrf_evpn_100	Configure host-reachability-protocol as BGP-EVPN and associate the VNID with VRF vrf_evpn_100.
(config-nvo)#exit	Exit NVO mode.
(config)#nvo vxlan access-if port-vlan xe3 2	Configure access-port xe3 and map vlan 2
(config-nvo-acc-if)#map vnid 100001	Map VNID 100001 to access-port xe3.
(config-nvo-acc-if)#exit	Exit NVO access-if mode.
(config)#nvo vxlan access-if port-vlan po1 2	Configure access-port po1 and map vlan 2
(config-nvo-acc-if)#map vnid 100001	Map VNID 100001 to access-port po1.
(config-nvo-acc-if)#exit	Exit NVO access-if mode.
(config)#nvo vxlan id 200001 ingress-replication	Configure second VNID on this VTEP and enter NVO mode.
(config-nvo)#vxlan host-reachability-protocol evpn-bgp vrf_evpn_100	Configure host-reachability-protocol as BGP-EVPN and associate the VNID with VRF vrf_evpn_100.
(config-nvo)#exit	Exit NVO mode.
(config)#nvo vxlan access-if port-vlan xe3 3	Configure access-port xe3 and map vlan 3
(config-nvo-acc-if)#map vnid 200001	Map VNID 200001 to access-port xe3.
(config-nvo-acc-if)#exit	Exit NVO access-if mode.

(config)#nvo vxlan access-if port-vlan po1 3	Configure access-port po1 and map vlan 3
(config-nvo-acc-if)#map vnid 200001	Map VNID 200001 to access-port xe3.
(config-nvo-acc-if)#exit	Exit NVO access-if mode.
(config)#commit	Commit the configurations

Spine-1

#configure terminal	Enter configure mode.
(config)#interface lo	Enter interface mode
(config-if)#ip address 12.12.12.12/32 secondary	Set an IP address on the interface.
(config-if)#no shutdown	Bring the interface into operation
(config-if)#exit	Exit interface mode.
(config)#interface xe1	Enter interface mode.
(config-if)#ip address 10.1.1.1/31	Configure IP address on the interface xe1.
(config-if)#no shutdown	Bring the interface into operation
(config-if)#exit	Exit interface mode.
(config)#interface xe2	Enter interface mode.
(config-if)#ip address 20.1.1.1/31	Configure IP address on the interface xe2.
(config-if)#no shutdown	Bring the interface into operation
(config-if)#exit	Exit interface mode.
(config)#interface xe3	Enter interface mode.
(config-if)#ip address 30.1.1.1/31	Configure IP address on the interface xe3.
(config-if)#no shutdown	Bring the interface into operation
(config-if)#exit	Exit interface mode.
(config)#router isis ABC	Create an IS-IS routing instance (ABC).
(config-router)#is-type level-1	Configure instance as level-1-only routing.
(config-router)#net 49.0001.4444.4444.4444.00	Set a Network Entity Title for this instance, specifying the area address and the system ID.
(config-router)#exit	Exit router mode.
(config)#interface lo	Enter interface mode.
(config-if)#ip router isis ABC	Enable IS-IS routing on an interface (ABC).
(config-if)#isis circuit-type level-1	Configure instance as level-1-only routing.
(config-if)#exit	Exit interface mode.
(config)#interface xe1	Enter interface mode.
(config-if)#ip router isis ABC	Enable IS-IS routing on an interface (ABC).
(config-if)#isis circuit-type level-1	Configure instance as level-1-only routing.
(config-if)#exit	Exit interface mode.
(config)#interface xe2	Enter interface mode.
(config-if)#ip router isis ABC	Enable IS-IS routing on an interface (ABC).
(config-if)#isis circuit-type level-1	Configure instance as level-1-only routing.

(config-if)#exit	Exit interface mode.
(config)#interface xe3	Enter interface mode.
(config-if)#ip router isis ABC	Enable IS-IS routing on an interface (ABC).
(config-if)#isis circuit-type level-1	Configure instance as level-1-only routing.
(config-if)#exit	Exit interface mode.
(config)#commit	Commit the configurations

Spine-2

#configure terminal	Enter configure mode.
(config)#interface lo	Enter interface mode.
(config-if)#ip address 13.13.13.13/32 secondary	Set an IP address on the interface.
(config-if)#no shutdown	Bring the interface into operation
(config-if)#exit	Exit interface mode.
(config)#interface xe1	Enter interface mode.
(config-if)#ip address 10.1.1.3/31	Configure IP address on the interface xe1.
(config-if)#no shutdown	Bring the interface into operation
(config-if)#exit	Exit interface mode.
(config)#interface xe2	Enter interface mode.
(config-if)#ip address 20.1.1.3/31	Configure IP address on the interface xe2.
(config-if)#no shutdown	Bring the interface into operation
(config-if)#exit	Exit interface mode.
(config)#interface xe3	Enter interface mode.
(config-if)#ip address 30.1.1.3/31	Configure IP address on the interface xe3.
(config-if)#no shutdown	Bring the interface into operation
(config-if)#exit	Exit interface mode.
(config)#router isis ABC	Create an IS-IS routing instance (ABC).
(config-router)#is-type level-1	Configure instance as level-1-only routing.
(config-router)#net 49.0001.5555.5555.5555.00	Set a Network Entity Title for this instance, specifying the area address and the system ID.
(config-router)#exit	Exit router mode.
(config)#interface lo	Enter interface mode.
(config-if)#ip router isis ABC	Enable IS-IS routing on an interface (ABC).
(config-if)#isis circuit-type level-1	Configure instance as level-1-only routing.
(config-if)#exit	Exit interface mode.
(config)#interface xe1	Enter interface mode.
(config-if)#ip router isis ABC	Enable IS-IS routing on an interface (ABC).
(config-if)#isis circuit-type level-1	Configure instance as level-1-only routing.
(config-if)#exit	Exit interface mode.
(config)#interface xe2	Enter interface mode.
(config-if)#ip router isis ABC	Enable IS-IS routing on an interface (ABC).

(config-if)#isis circuit-type level-1	Configure instance as level-1-only routing.
(config-if)#exit	Exit interface mode.
(config)#interface xe3	Enter interface mode.
(config-if)#ip router isis ABC	Enable IS-IS routing on an interface (ABC).
(config-if)#isis circuit-type level-1	Configure instance as level-1-only routing.
(config-if)#exit	Exit interface mode.
(config)#commit	Commit the configurations

VTEP-2

#configure terminal	Enter configure mode
(config)#interface xe3	Enter interface mode
(config-if)#switchport	Configure the interface as switchport.
(config-if)#no shutdown	Bring the interface into operation
(config-if)#exit	Exit interface mode.
(config)#interface xe1	Enter interface mode.
(config-if)#ip address 20.1.1.0/31	Configure IP address on the interface xe1.
(config-if)#no shutdown	Bring the interface into operation
(config-if)#exit	Exit interface mode.
(config)#interface xe2	Enter interface mode.
(config-if)#ip address 20.1.1.2/31	Configure IP address on the interface xe2.
(config-if)#no shutdown	Bring the interface into operation
(config-if)#exit	Exit interface mode.
(config)#interface lo	Enter interface mode.
(config-if)#ip address 2.2.2.2/32 secondary	Configure IP address on the loopback interface.
(config-if)#no shutdown	Bring the interface into operation
(config-if)#exit	Exit interface mode.
(config)#router isis ABC	Create an IS-IS routing instance (ABC).
(config-router)#is-type level-1	Configure instance as level-1-only routing.
(config-router)#net 49.0001.2222.2222.2222.00	Set a Network Entity Title for this instance, specifying the area address and the system ID.
(config-router)#exit	Exit router mode.
(config)#interface xe1	Enter interface mode.
(config-if)#ip router isis ABC	Enable IS-IS routing on an interface (ABC).
(config-if)#isis circuit-type level-1	Configure instance as level-1-only routing.
(config-if)#exit	Exit interface mode.
(config)#interface xe2	Enter interface mode.
(config-if)#ip router isis ABC	Enable IS-IS routing on an interface (ABC).
(config-if)#isis circuit-type level-1	Configure instance as level-1-only routing.
(config-if)#exit	Exit interface mode.
(config)#interface lo	Enter interface mode.

(config-if)#ip router isis ABC	Enable IS-IS routing on an interface for area 49 (ABC).
(config-if)#isis circuit-type level-1	Configure instance as level-1-only routing.
(config-if)#exit	Exit interface mode.
(config)#mac vrf vrf_evpn_100	Configure a new VRF named <code>vrf_evpn_100</code> .
(config-vrf)#rd 1.1.1.1:1	Assign the Route Distinguisher value.
(config-vrf)#route-target both 100:1	Configure route target to import and export the routes.
(config-vrf)#exit	Exit VRF mode.
(config)#router bgp 65535	Define the routing process. The number <code>65535</code> specifies the AS number of VTEP-1.
(config-router)#neighbor 1.1.1.1 remote-as 65535	Define BGP neighbor: 1.1.1.1 is the IP address of the neighbor (VTEP-1), and <code>65535</code> is the neighbor's AS number.
(config-router)#neighbor 1.1.1.1 update-source 2.2.2.2	Define BGP neighbor: 2.2.2.2 is the peer interface.
(config-router)#neighbor 3.3.3.3 remote-as 65535	Define BGP neighbor: 3.3.3.3 is the IP address of the neighbor (VTEP-3), and <code>65535</code> is the neighbor's AS number.
(config-router)#neighbor 3.3.3.3 update-source 2.2.2.2	Define BGP neighbor: 2.2.2.2 is the peer interface.
(config-router)#address-family l2vpn evpn	Configure address-family L2VPN EVPN.
(config-router-af)#neighbor 1.1.1.1 activate	Activate the neighbor at VTEP-1 in the EVPN address family.
(config-router-af)#neighbor 3.3.3.3 activate	Activate the neighbor at VTEP-3 in the EVPN address family.
(config-router-af)#exit-address-family	Exit address-family mode.
(config-router)#exit	Exit router mode.
(config)#hardware-profile filter vxlan enable	Enable hardware-profile filter for VXLAN.
(config)#nvo vxlan enable	Enable VXLAN globally on this VTEP.
(config)#nvo vxlan vtep-ip-global 2.2.2.2	Assign a global IP to the VTEP.
(config)#nvo vxlan id 100001 ingress-replication	Configure a VNID on this VTEP and enter NVO mode.
(config-nvo)#vxlan host-reachability-protocol evpn-bgp vrf_evpn_100	Configure host-reachability-protocol as BGP-EVPN and associate the VNID with VRF <code>vrf_evpn_100</code> .
(config-nvo)#exit	Exit NVO mode.
(config)#nvo vxlan access-if port-vlan xe3 2	Configure access-port <code>xe3</code> and map <code>vlan 2</code>
(config-nvo-acc-if)#map vnid 100001	Map VNID <code>100001</code> to access-port <code>xe3</code> .
(config-nvo-acc-if)#exit	Exit NVO access-if mode.
(config)#nvo vxlan id 200001 ingress-replication	Configure second VNID on this VTEP and enter NVO mode.
(config-nvo)#vxlan host-reachability-protocol evpn-bgp vrf_evpn_100	Configure host-reachability-protocol as BGP-EVPN and associate the VNID with VRF <code>vrf_evpn_100</code> .
(config-nvo)#exit	Exit NVO mode.
(config)#nvo vxlan access-if port-vlan xe3 3	Configure access-port <code>xe3</code> and map <code>vlan 3</code>
(config-nvo-acc-if)#map vnid 200001	Map VNID <code>200001</code> to access-port <code>xe3</code> .

(config-nvo-acc-if)#exit-address-family	Exit NVO access-if mode.
(config)#commit	Commit the configurations

VTEP-3

#configure terminal	Enter configure mode.
(config)#interface xe3	Enter interface mode.
(config-if)#switchport	Configure the interface as switchport.
(config-if)#no shutdown	Bring the interface into operation
(config-if)#exit	Exit interface mode.
(config)#interface xe1	Enter interface mode.
(config-if)#ip address 30.1.1.0/31	Configure IP address on the interface xe1.
(config-if)#no shutdown	Bring the interface into operation
(config-if)#exit	Exit interface mode.
(config)#interface xe2	Enter interface mode.
(config-if)#ip address 30.1.1.2/31	Configure IP address on the interface xe2.
(config-if)#no shutdown	Bring the interface into operation
(config-if)#exit	Exit interface mode.
(config)#interface lo	Enter interface mode.
(config-if)#ip address 3.3.3.3/32 secondary	Configure IP address on the loopback interface.
(config-if)#no shutdown	Bring the interface into operation
(config-if)#exit	Exit interface mode.
(config)#router isis ABC	Create an IS-IS routing instance (ABC).
(config-router)#is-type level-1	Configure instance as level-1-only routing.
(config-router)#net 49.0001.3333.3333.3333.00	Set a Network Entity Title for this instance, specifying the area address and the system ID.
(config-router)#exit	Exit router mode.
(config)#interface xe1	Enter interface mode.
(config-if)#ip router isis ABC	Enable IS-IS routing on an interface (ABC).
(config-if)#isis circuit-type level-1	Configure instance as level-1-only routing.
(config-if)#exit	Exit interface mode.
(config)#interface xe2	Enter interface mode.
(config-if)#ip router isis ABC	Enable IS-IS routing on an interface (ABC).
(config-if)#isis circuit-type level-1	Configure instance as level-1-only routing.
(config-if)#exit	Exit interface mode.
(config)#interface lo	Enter interface mode.
(config-if)#ip router isis ABC	Enable IS-IS routing on an interface for area 49 (ABC).
(config-if)#isis circuit-type level-1	Configure instance as level-1-only routing.
(config-if)#exit	Exit interface mode.
(config)#mac vrf vrf_evpn_100	Configure a new VRF named vrf_evpn_100.
(config-vrf)#rd 1.1.1.1:1	Assign the Route Distinguisher value.

(config-vrf)#route-target both 100:1	Configure route target to import and export the routes.
(config-vrf)#exit	Exit VRF mode.
(config)#router bgp 65535	Define the routing process. The number 65535 specifies the AS number of VTEP-1.
(config-router)#neighbor 1.1.1.1 remote-as 65535	Define BGP neighbor: 1.1.1.1 is the IP address of the neighbor (VTEP-1), and 65535 is the neighbor's AS number.
(config-router)#neighbor 1.1.1.1 update-source 3.3.3.3	Define BGP neighbor: 3.3.3.3 is the peer interface.
(config-router)#neighbor 2.2.2.2 remote-as 65535	Define BGP neighbor: 2.2.2.2 is the IP address of the neighbor (VTEP-3), and 65535 is the neighbor's AS number.
(config-router)#neighbor 2.2.2.2 update-source 3.3.3.3	Define BGP neighbor: 3.3.3.3 is the peer interface.
(config-router)#address-family l2vpn evpn	Configure address-family L2VPN EVPN.
(config-router-af)#neighbor 1.1.1.1 activate	Activate the neighbor at VTEP-1 in the EVPN address family.
(config-router-af)#neighbor 2.2.2.2 activate	Activate the neighbor at VTEP-2 in the EVPN address family.
(config-router-af)#exit-address-family	Exit address-family mode.
(config-router)#exit	Exit router mode.
(config)#hardware-profile filter vxlan enable	Enable hardware-profile filter for VXLAN.
(config)#nvo vxlan enable	Enable VXLAN globally on this VTEP.
(config)#nvo vxlan vtep-ip-global 3.3.3.3	Assign a global IP to the VTEP.
(config)#nvo vxlan id 100001 ingress-replication	Configure a VNID on this VTEP and enter NVO mode.
(config-nvo)#vxlan host-reachability-protocol evpn-bgp vrf_evpn_100	Configure host-reachability-protocol as BGP-EVPN and associate the VNID with VRF vrf_evpn_100.
(config-nvo)#exit	Exit NVO mode.
(config)#nvo vxlan access-if port-vlan xe3 2	Configure access-port xe3 and map vlan 2
(config-nvo-acc-if)#map vnid 100001	Map VNID 100001 to access-port xe3.
(config-nvo-acc-if)#exit-address-family	Exit NVO access-if mode.
(config)#nvo vxlan id 200001 ingress-replication	Configure second VNID on this VTEP and enter NVO mode.
(config-nvo)#vxlan host-reachability-protocol evpn-bgp vrf_evpn_100	Configure host-reachability-protocol as BGP-EVPN and associate the VNID with VRF vrf_evpn_100
(config-nvo)#exit	Exit NVO mode.
(config)#nvo vxlan access-if port-vlan xe3 3	Configure access-port xe3 and map vlan 3
(config-nvo-acc-if)#map vnid 200001	Map VNID 200001 to access-port xe3.
(config-nvo-acc-if)#exit	Exit NVO access-if mode.
(config)#commit	Commit the configurations

Validation

CE1, CE2, CE3, and CE4 have hosts configured with MAC addresses, IP addresses, and VLAN identifiers as shown below.

		VLAN	IP Address	MAC Address
VTEP-1	CE-1	2	12.12.12.10	0000.0000.aaaa
VTEP-1	CE-2	2	12.12.12.20	0000.0000.bbbb
VTEP-2	CE-3	2	12.12.12.30	0000.0000.cccc
VTEP-3	CE-4	2	12.12.12.40	0000.0000.dddd
VTEP-1	CE-1	3	14.14.14.10	0000.058e.2181
VTEP-1	CE-2	3	14.14.14.20	0000.058e.2182
VTEP-2	CE-3	3	14.14.14.30	0000.058e.2183
VTEP-3	CE-4	3	14.14.14.40	0000.058e.2184

Perform a tagged ping of VLAN 2 from CE1 to CE2, CE3 and CE4 and vice-versa. Also perform a tagged ping of VLAN 3 from CE1 to CE2, CE3 and CE4 and vice-versa.

VTEP Tunnel Status

```
VTEP-1#show nvo vxlan tunnel
```

```
VxLAN Network tunnel Entries
```

Source	Destination	Status	Up/Down	Update
1.1.1.1	3.3.3.3	Installed	01:25:20	01:25:20
1.1.1.1	2.2.2.2	Installed	01:35:19	01:35:19

Total number of entries are 2

```
VTEP-2#show nvo vxlan tunnel
```

```
VxLAN Network tunnel Entries
```

Source	Destination	Status	Up/Down	Update
2.2.2.2	1.1.1.1	Installed	01:35:42	01:35:42
2.2.2.2	3.3.3.3	Installed	01:25:43	01:25:43

Total number of entries are 2

```
VTEP-3#show nvo vxlan tunnel
```

```
VxLAN Network tunnel Entries
```

Source	Destination	Status	Up/Down	Update
3.3.3.3	2.2.2.2	Installed	01:25:35	01:25:35
3.3.3.3	1.1.1.1	Installed	01:25:35	01:25:35

Total number of entries are 2

VTEP ARP Tables

Use the following command to validate the ARP-cache details in all VTEPs.

```
VTEP-3#show nvo vxlan arp-cache
```

```
VxLAN ARP-CACHE Information
```

```
=====
```

VNID	Ip-Addr	Mac-Addr	Type	Age-Out	Retries-Left
100001	12.12.12.30	0000.0000.cccc	Dynamic Remote	----	
100001	12.12.12.10	0000.0000.aaaa	Dynamic Remote	----	
100001	12.12.12.20	0000.0000.bbbb	Dynamic Remote	----	
100001	12.12.12.40	0000.0000.dddd	Dynamic Local	----	
200001	14.14.14.20	0000.058e.2182	Dynamic Remote	----	
200001	14.14.14.10	0000.058e.2181	Dynamic Remote	----	
200001	14.14.14.40	0000.058e.2184	Dynamic Local	----	
200001	14.14.14.30	0000.058e.2183	Dynamic Remote	----	

Total number of entries are 8

VTEP MAC-IP BGP EVPN Entries

Use the following command to validate the BGP EVPN entries in all VTEPs.

```
VTEP-3#show bgp l2vpn evpn mac-ip
```

```
RD[1.1.1.1:1] VRF[vrf_evpn_100]:
```

ESI	VNID	L3VNID	Nexthop	Eth-Tag	Mac-Address	IP-Address
0				100001	0000:0000:dddd	--
100001	0		3.3.3.3		--	
0				100001	0000:0000:dddd	12.12.12.40
100001	0		3.3.3.3		--	
0				200001	0000:058e:2184	--
200001	0		3.3.3.3		--	
0				200001	0000:058e:2184	14.14.14.40
200001	0		3.3.3.3		--	

```
RD[1.1.1.1:1]
```

ESI	VNID	L3VNID	Nexthop	Eth-Tag	Mac-Address	IP-Address
0				100001	0000:0000:aaaa	--
100001	0		1.1.1.1		--	
0				100001	0000:0000:aaaa	12.12.12.10
100001	0		1.1.1.1		--	
0				100001	0000:0000:bbbb	--
100001	0		1.1.1.1		--	
0				100001	0000:0000:bbbb	12.12.12.20
100001	0		1.1.1.1		--	
0				100001	0000:0000:cccc	--
100001	0		2.2.2.2		--	
0				100001	0000:0000:cccc	12.12.12.30
100001	0		2.2.2.2		--	
0				200001	0000:058e:2181	--
200001	0		1.1.1.1		--	
0				200001	0000:058e:2181	14.14.14.10
200001	0		1.1.1.1		--	
0				200001	0000:058e:2182	--
200001	0		1.1.1.1		--	

0		200001	0000:058e:2182	14.14.14.20
200001	0	1.1.1.1	--	
0		200001	0000:058e:2183	--
200001	0	2.2.2.2	--	
0		200001	0000:058e:2183	14.14.14.30
200001	0	2.2.2.2	--	

CHAPTER 4 VxLAN EVPN EVC Configuration

This chapter shows how to configure VxLAN EVPN Ethernet Virtual Circuit (EVC) which embeds the functionality of EVPN-VxLAN access ports to allow EVC frames across VTEPs. With this configuration, customers in the same VLAN can communicate even they are placed across distributed data centers.

Overview

An EVC represents a logical relationship between Ethernet User Network Interface (UNI) in a provider-based Ethernet service. An EVC represents the service offered and is carried through the provider network. Each EVC is configured by a unique name across the provider network.

An EVC is an end-to-end representation of a single instance of a Layer 2 service that a service provider offers. An EVC embodies the different parameters based on which the service is offered. EVC prevents data transfer between sites that are not part of the same EVC.

EVC is an A-Z circuit that enables you to pass customer VLANs from one port on a node to another port on another node in the network. EVC represents a Carrier Ethernet service and is an entity that provides end-to-end connection between two or more customer end points.

Topology

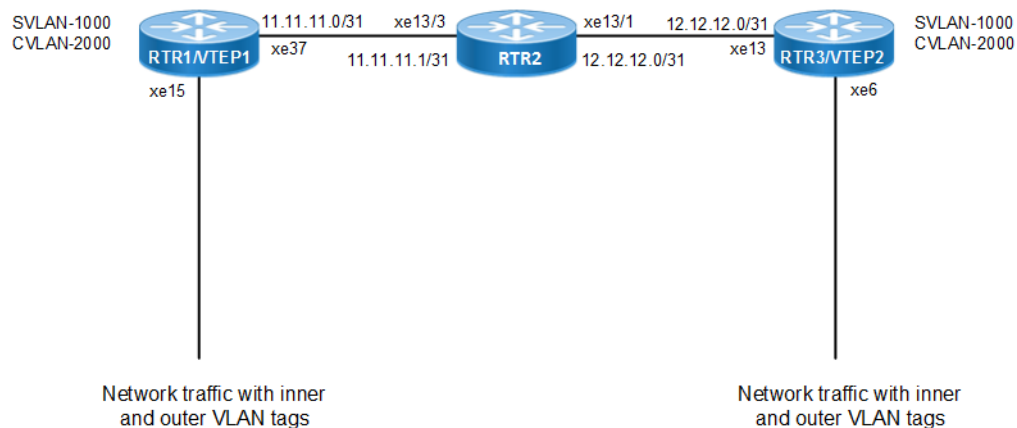

Figure 4-6: VxLAN EVPN EVC

Configuration

RTR1/VTEP1

#configure terminal	Enter configure mode.
(config)#interface lo	Enter interface mode for loopback.
(config-if)#ip address 33.33.33.0/31 secondary	Assign secondary IP address.

(config-if)#exit	Exit interface mode.
(config)#mac vrf vrf1	Create mac routing/forwarding instance with vrf1 name and enter into VRF mode
(config-vrf)# rd 100:11	Assign RD value
(config-vrf)# route-target export 200:11	Assign route-target value for export
(config-vrf)# route-target import 400:11	Assign route-target value for import
(config-vrf)#exit	Exit VRF configuration mode
(config)#interface xe37	Enter interface mode for xe37
(config-if)#ip address 11.11.11.0/31	Assign IP address in /31 mask.
(config-if)#exit	Exit interface mode.
(config)#interface xe15	Enter interface mode for xe15
(config-if)#switchport	Make it L2 interface
(config-if)#exit	Exit interface mode.
(config)#router bgp 100	Enter BGP router mode
(config-router)# bgp router-id 1.1.1.1	Assign BGP router ID
(config-router)#neighbor 11.11.11.1 remote-as 200	Specify a neighbor router with peer IP address and remote-as defined
(config-router)#neighbor 11.11.11.1 fall-over bfd	Configure single-hop BFD session for its BGP peer
(config-router)#address-family ipv4 unicast	Enter into ipv4 unicast address family
(config-router-af)#network 33.33.33.0/31	Advertise loopback network into BGP for VTEP ID reachability
(config-router-af)#exit-address-family	Exit ipv4 unicast address family mode
(config-router)#address-family l2vpn evpn	Enter into l2vpn address family mode
(config-router-af)#neighbor 11.11.11.1 activate	Activate the peer into address family mode
(config-router-af)#exit-address-family	Exit l2vpn address family mode
(config-router)#exit	Exit BGP router mode
(config)# hardware-profile filter vxlan enable	Enable hardware profile for vxlan
(config)#hardware-profile statistics ac-lif enable	Enable ac-lif for VxLAN access-if port counters
(config)#nvo vxlan enable	Enable VxLAN
(config)#nvo vxlan vtep-ip-global 33.33.33.0	Configure Source vtep-ip-global configuration
(config)#nvo vxlan id 1 ingress-replication inner-vid-disabled	Configure VxLAN Network identifier with/without inner-vid-disabled configure and enter into VxLAN tenant mode
(config-nvo)#vxlan host-reachability-protocol evpn-bgp vrf1	Assign VRF for evpn-bgp to carry EVPN route
(config-nvo)#exit	Exit VxLAN tenant mode.
(config)#nvo vxlan access-if port-vlan xe15 1000 inner-vlan 2000	Enable port-vlan mapping i.e. access port to outer-vlan (SVLAN) and inner-vlan (CVLAN) mapping
(config-nvo-acc-if)#map vnid 1	Map VxLAN Identified to access-port for VxLAN
(config-nvo-acc-if)#exit	Exit VxLAN access-interface mode

(config)#commit	Commit the candidate configuration to the running configuration
(config)#exit	Exit configuration mode

RTR2

#configure terminal	Enter configure mode.
(config)#interface xe13/3	Enter interface mode for xe13/3
(config-if)#ip address 11.11.11.1/31	Assign IP address in /31 mask.
(config-if)#exit	Exit interface mode.
(config)#interface xe13/1	Enter interface mode for xe13/1
(config-if)#ip address 12.12.12.1/31	Assign IP address in /31 mask.
(config-if)#exit	Exit interface mode
(config)#router bgp 200	Enter BGP router mode
(config-router)# bgp router-id 2.2.2.2	Assign BGP router ID
(config-router)#neighbor 11.11.11.0 remote-as 100	Specify a neighbor router with peer ip address and remote-as defined
(config-router)#neighbor 11.11.11.0 fall-over bfd	Configure single-hop BFD session for its BGP peer
(config-router)#neighbor 12.12.12.0 remote-as 300	Specify a neighbor router with peer ip address and remote-as defined
(config-router)#neighbor 12.12.12.0 fall-over bfd	Configure single-hop BFD session for its BGP peer
(config-router)#address-family l2vpn evpn	Enter into l2vpn address family mode
(config-router-af)#neighbor 11.11.11.0 activate	Activate the peer into address family mode
(config-router-af)#neighbor 12.12.12.0 activate	Activate the peer into address family mode
(config-router-af)#exit-address-family	Exit l2vpn address family mode
(config-router)#commit	Commit the candidate configuration to the running configuration
(config-router)#exit	Exit BGP router mode

RTR3/VTEP2

#configure terminal	Enter configure mode.
(config)#interface lo	Enter interface mode for loopback.
(config-if)#ip address 34.34.34.0/31 secondary	Assign secondary IP address.
(config-if)#exit	Exit interface mode.
(config)#mac vrf vrf1	Create mac routing/forwarding instance with vrf1 name and enter into vrf mode
(config-vrf)#rd 300:11	Assign RD value
(config-vrf)#route-target export 400:11	Assign route-target value for export
(config-vrf)#route-target import 200:11	Assign route-target value for import

(config-vrf)#exit	Exit vrf configuration mode
(config)#interface xe13	Enter interface mode for xe13
(config-if)#ip address 12.12.12.0/31	Assign IP address in /31 mask.
(config-if)#exit	Exit interface mode.
(config)#interface xe6	Enter interface mode for xe6
(config-if)#switchport	Make it L2 interface
(config-if)#exit	Exit interface mode.
(config)#router bgp 300	Enter BGP router mode
(config-router)# bgp router-id 3.3.3.3	Assign BGP router ID
(config-router)#neighbor 12.12.12.1 remote-as 200	Specify a neighbor router with peer ip address and remote-as defined
(config-router)#neighbor 12.12.12.1 fall-over bfd	Configure single-hop BFD session for its BGP peer
(config-router)#address-family ipv4 unicast	Enter into ipv4 unicast address family
(config-router-af)#network 34.34.34.0/31	Advertise loopback network into BGP for VTEP ID reachability
(config-router-af)#exit-address-family	Exit ipv4 unicast address family mode
(config-router)#address-family l2vpn evpn	Enter into l2vpn address family mode
(config-router-af)#neighbor 12.12.12.1 activate	Activate the peer into address family mode
(config-router-af)#exit-address-family	Exit l2vpn address family mode
(config-router)#exit	Exit BGP router mode
(config)# hardware-profile filter vxlan enable	Enable hardware profile for vxlan
(config)#hardware-profile statistics ac-lif enable	Enable ac-lif for VxLAN access-if port counters
(config)#nvo vxlan enable	Enable VxLAN
(config)#nvo vxlan vtep-ip-global 34.34.34.0	Configure Source vtep-ip-global configuration
(config)#nvo vxlan id 1 ingress-replication inner-vid-disabled	Configure VxLAN Network identifier with/without inner-vid-disabled configure and enter into VxLAN tenant mode
(config-nvo)#vxlan host-reachability-protocol evpn-bgp vrf1	Assign VRF for evpn-bgp to carry EVPN route
(config-nvo)#exit	Exit VxLAN tenant mode.
(config)#nvo vxlan access-if port-vlan xe6 1000 inner-vlan 2000	Enable port-vlan mapping i.e. access port to outer-vlan (SVLAN) and inner-vlan (CVLAN) mapping
(config-nvo-acc-if)#map vnid 1	Map VxLAN Identified to access-port for VxLAN
(config-nvo-acc-if)#exit	Exit VxLAN access-interface mode
(config)#commit	Commit the candidate configuration to the running configuration
(config)#exit	Exit configuration mode

Validation

Retaining SVLAN and CVLAN tags across Data Centers

RTR1/VTEP1

```
VTEP1#show running-config nvo vxlan
!
nvo vxlan enable
!
nvo vxlan vtep-ip-global 33.33.33.0
!
nvo vxlan id 1 ingress-replication inner-vid-disabled
  vxlan host-reachability-protocol evpn-bgp vrf1
!
nvo vxlan access-if port-vlan xe1/1 1000 inner-vlan 2000
map vnid 1
!
!
```

```
VTEP1#show bgp l2vpn evpn summary
BGP router identifier 1.1.1.1, local AS number 100
BGP table version is 8
2 BGP AS-PATH entries
0 BGP community entries
```

Neighbor	V	AS	MsgRcv	MsgSen	TblVer	InQ	OutQ	Up/Dow
n State/PfxRcd	AD	MACIP	MCAST	ESI	PREFIX-ROUTE			
11.11.11.1	4	200	73	73	8	0	0	00:30:41
	2	0	1	1	0	0		

Total number of neighbors 1

Total number of Established sessions 1

```
VTEP1#show bgp l2vpn evpn
BGP table version is 8, local router ID is 1.1.1.1
Status codes: s suppressed, d damped, h history, * valid, > best, i - internal,
               l - labeled, S Stale
Origin codes: i - IGP, e - EGP, ? - incomplete
```

```
[EVPN route type]:[ESI]:[VNID]:[relevent route informantion]
1 - Ethernet Auto-discovery Route
2 - MAC/IP Route
3 - Inclusive Multicast Route
4 - Ethernet Segment Route
5 - Prefix Route
```

Network	Next Hop	Metric	LocPrf	Weight	Path
---------	----------	--------	--------	--------	------

```

Peer          Encap
RD[100:11] VRF[vrf1]:
*      [2]:[0]:[1]:[48,0000.339a.9397]:[0]:[1]
          34.34.34.0          0          100          0          200
300 i  11.11.11.1          VxLAN
*>    [2]:[0]:[1]:[48,0000.339a.9abb]:[0]:[1]
          33.33.33.0          0          100          32768          i  -
-----          VxLAN
*>    [3]:[1]:[32,33.33.33.0]
          33.33.33.0          0          100          32768          i  -----
VxLAN
*      [3]:[1]:[32,34.34.34.0]
          34.34.34.0          0          100          0          200
300 i  11.11.11.1          VxLAN

RD[300:11]
*>    [2]:[0]:[1]:[48,0000.339a.9397]:[0]:[1]
          34.34.34.0          0          100          0          200
300 i  11.11.11.1          VxLAN
*>    [3]:[1]:[32,34.34.34.0]
          34.34.34.0          0          100          0          200
300 i  11.11.11.1          VxLAN

```

Total number of prefixes 6

VTEP1#show ip route

Codes: K - kernel, C - connected, S - static, R - RIP, B - BGP
O - OSPF, IA - OSPF inter area
N1 - OSPF NSSA external type 1, N2 - OSPF NSSA external type 2
E1 - OSPF external type 1, E2 - OSPF external type 2
i - IS-IS, L1 - IS-IS level-1, L2 - IS-IS level-2,
ia - IS-IS inter area, E - EVPN,
v - vrf leaked
* - candidate default

IP Route Table for VRF "default"

```

C      11.11.11.0/31 is directly connected, xe10/1, 00:36:00
C      33.33.33.0/31 is directly connected, lo, 00:37:33
B      34.34.34.0/31 [20/0] via 11.11.11.1, xe10/1, 00:27:03
C      127.0.0.0/8 is directly connected, lo, 23:14:51

```

Gateway of last resort is not set

VTEP1

VTEP1#show nvo vxlan

VxLAN Information

=====

```

Codes: NW - Network Port
       AC - Access Port
       (u) - Untagged

```

```

VNID      VNI-Name      VNI-Type Type Interface      ESI
VLAN DF-Status Src-Addr      Dst-Addr
-----
1         -----      L2      NW      -----
-----      33.33.33.0      34.34.34.0
1         -----      --      AC      xe1/1      --- Single Homed Port ---
1000 -----      -----      -----
Total number of entries are 2
    
```

```

VTEP1#show nvo vxlan tunnel
VxLAN Network tunnel Entries
Source      Destination      Status      Up/Down      Update
=====
=====
33.33.33.0      34.34.34.0      Installed      00:26:27      00:26:27
Total number of entries are 1
VTEP1#show nvo vxlan mac-table
    
```

```

=====
=====
VxLAN MAC Entries
=====
=====
VNID      Interface  VlanId Inner-VlanId Mac-Addr      VTEP-Ip/ESI
Type      Status      AccessPortDesc
-----
1         xe1/1      1000   2000      0000.339a.9abb 33.33.33.0
Dynamic Local      -----
1         -----      -----      -----      0000.339a.9397 34.34.34.0
Dynamic Remote      -----
Total number of entries are : 2
VTEP1#
    
```

RTR3/VTEP2

```

#show running-config nvo vxlan
!
nvo vxlan enable
!
nvo vxlan vtep-ip-global 34.34.34.0
!
nvo vxlan id 1 ingress-replication inner-vid-disabled
vxlan host-reachability-protocol evpn-bgp vrf1
!
    
```



```
nvo vxlan access-if port-vlan xe6 1000 inner-vlan 2000
map vnid 1
!
```

```
VTEP2#show bgp l2vpn evpn summary
BGP router identifier 3.3.3.3, local AS number 300
BGP table version is 7
2 BGP AS-PATH entries
0 BGP community entries
```

Neighbor	V	AS	MsgRcv	MsgSen	TblVer	InQ	OutQ	Up/Dow
n State/PfxRcd	AD	MACIP	MCAST	ESI	PREFIX-ROUTE			
12.12.12.1	4	200	63	64	7	0	0	00:26:54
	2	0	1	1	0	0		

Total number of neighbors 1

Total number of Established sessions 1

```
VTEP2#show bgp l2vpn evpn
BGP table version is 7, local router ID is 3.3.3.3
Status codes: s suppressed, d damped, h history, * valid, > best, i - internal,
               l - labeled, S Stale
Origin codes: i - IGP, e - EGP, ? - incomplete
```

```
[EVPN route type]:[ESI]:[VNID]:[relevent route informantion]
1 - Ethernet Auto-discovery Route
2 - MAC/IP Route
3 - Inclusive Multicast Route
4 - Ethernet Segment Route
5 - Prefix Route
```

Network	Next Hop	Metric	LocPrf	Weight	Path
Peer	Encap				
RD[100:11]					
*>	[2]:[0]:[1]:[48,0000.339a.9abb]:[0]:[1]				
	33.33.33.0	0	100	0	200
100 i	12.12.12.1 VxLAN				
*>	[3]:[1]:[32,33.33.33.0]				
	33.33.33.0	0	100	0	200
100 i	12.12.12.1 VxLAN				
*>	[2]:[0]:[1]:[48,0000.339a.9397]:[0]:[1]				
	34.34.34.0	0	100	32768	i -
-----	VxLAN				
*	[2]:[0]:[1]:[48,0000.339a.9abb]:[0]:[1]				
	33.33.33.0	0	100	0	200
100 i	12.12.12.1 VxLAN				

```
*      [3]:[1]:[32,33.33.33.0]
          33.33.33.0          0          100          0          200
100 i  12.12.12.1          VxLAN
*>    [3]:[1]:[32,34.34.34.0]
          34.34.34.0          0          100          32768      i  -
-----          VxLAN
```

Total number of prefixes 6

#show ip route

Codes: K - kernel, C - connected, S - static, R - RIP, B - BGP
 O - OSPF, IA - OSPF inter area
 N1 - OSPF NSSA external type 1, N2 - OSPF NSSA external type 2
 E1 - OSPF external type 1, E2 - OSPF external type 2
 i - IS-IS, L1 - IS-IS level-1, L2 - IS-IS level-2,
 ia - IS-IS inter area, E - EVPN,
 v - vrf leaked
 * - candidate default

IP Route Table for VRF "default"

```
C      12.12.12.0/31 is directly connected, xe13, 00:28:41
B      33.33.33.0/31 [20/0] via 12.12.12.1, xe13, 00:26:56
C      34.34.34.0/31 is directly connected, lo, 00:29:36
C      127.0.0.0/8 is directly connected, lo, 00:52:46
```

Gateway of last resort is not set

VTEP2#show nvo vxlan

VxLAN Information

=====

Codes: NW - Network Port
 AC - Access Port
 (u) - Untagged

VNID	VNI-Name	VNI-Type	Type	Interface	ESI
VLAN	DF-Status	Src-Addr		Dst-Addr	
1	----	L2	NW	----	-----
----	----	34.34.34.0		33.33.33.0	
1	----	--	AC	xe1/1	--- Single Homed Port ---
1000	----	----		----	

Total number of entries are 2

VTEP1#show nvo vxlan tunnel

VxLAN Network tunnel Entries

Source	Destination	Status	Up/Down	Update
--------	-------------	--------	---------	--------

=====
 =====

33.33.33.0 34.34.34.0 Installed 00:26:27 00:26:27

Total number of entries are 1

VTEP2#show nvo vxlan mac-table

```

=====
=====
                                     VxLAN MAC Entries
=====
=====
VNID      Interface  VlanId Inner-VlanId Mac-Addr      VTEP-Ip/ESI
      Type                Status                AccessPortDesc
-----
1         ----      ----      ----          0000.339a.9abb 33.33.33.0
      Dynamic Remote          -----
1         xe6       1000    2000          0000.339a.9397 34.34.34.0
      Dynamic Local          -----
  
```

Total number of entries are : 2
#

Popping SVLAN and CVLAN Tag

Use the previous configuration on VTEP1 and perform the configuration below on VTEP2.

VTEP2

(config)#nvo vxlan access-if port xe6	Enable port-only mapping for access port
(config-nvo-acc-if)#map vnid 1	Map VxLAN Identified to access-port for VxLAN
(config-nvo-acc-if)#exit	Exit VxLAN access-interface mode
(config)#commit	Commit the candidate configuration to the running configuration
(config)#exit	Exit configuration mode

RTR3/VTEP2

```

#show nvo vxlan
VxLAN Information
=====
Codes: NW - Network Port
AC - Access Port
(u) - Untagged
VNID VNI-Name VNI-Type Type Interface ESI
VLAN DF-Status Src-Addr Dst-Addr
-----
1 ---- L2 NW ---- -----
---- ---- 34.34.34.0 33.33.33.0
1 ---- -- AC xe6 --- Single Homed Port ---
  
```

Total number of entries are 2

VTEP2#show nvo vxlan mac-table

```

=====
VxLAN MAC Entries
=====
VNID      Interface  VlanId  Inner-VlanId  Mac-Addr      VTEP-IP/ESI
      Type                Status                AccessPortDesc
-----
1         -----  -----  -----      0000.339a.9abb 33.33.33.0
      Dynamic Remote          -----

```

Total number of entries are : 1

#

VTEP2#show running-config nvo vxlan

!

nvo vxlan enable

!

nvo vxlan vtep-ip-global 34.34.34.0

!

nvo vxlan id 1 ingress-replication inner-vid-disabled

vxlan host-reachability-protocol evpn-bgp vrf1

!

nvo vxlan access-if port-vlan xe1/1 3000 inner-vlan 2000

map vnid 1

VTEP1#show nvo vxlan tunnel

VxLAN Network tunnel Entries

```

Source          Destination      Status          Up/Down      Update
=====
33.33.33.0      34.34.34.0      Installed       00:26:27     00:26:27

```

Total number of entries are 1

Popping and Later Pushing SVLAN Tag

Use the previous configuration on VTEP1 and perform the configuration below on VTEP2.

(config)#nvo vxlan access-if port-vlan xe6 3000 inner-vlan 2000	Enable port-vlan mapping i.e. access port to outer-vlan (SVLAN) and inner-vlan (CVLAN) mapping
(config-nvo-acc-if)#map vnid 1	Map VxLAN Identified to access-port for VxLAN
(config-nvo-acc-if)#exit	Exit VxLAN access-interface mode

(config)#commit	Commit the candidate configuration to the running configuration
(config)#exit	Exit configuration mode

RTR3/VTEP2

```
#show running-config nvo vxlan
!
nvo vxlan enable
!
nvo vxlan vtep-ip-global 34.34.34.0
!
nvo vxlan id 1 ingress-replication inner-vid-disabled
vxlan host-reachability-protocol evpn-bgp vrf1
!
nvo vxlan access-if port-vlan xe1/1 3000 inner-vlan 2000
map vnid 1
!
```

```
#show nvo vxlan
VxLAN Information
=====
```

```
Codes: NW - Network Port
       AC - Access Port
       (u) - Untagged
```

VNID	VNI-Name	VNI-Type	Type	Interface	ESI
VLAN	DF-Status	Src-Addr		Dst-Addr	
1	----	L2	NW	----	-----
----	----	34.34.34.0		33.33.33.0	
1	----	--	AC	xe6	--- Single Homed Port ---
3000	----	----	----	----	

Total number of entries are 2

```
#show nvo vxlan tunnel
```

```
VxLAN Network tunnel Entries
```

Source	Destination	Status	Up/Down	Update
34.34.34.0	33.33.33.0	Installed	00:06:48	00:06:48

Total number of entries are 1

```
VTEP2#show nvo vxlan mac-table
```

```
=====
=====
```

VxLAN MAC Entries

```
=====
=====
```

VNID	Interface	VlanId	Inner-VlanId	Mac-Addr	VTEP-Ip/ESI
	Type		Status		AccessPortDesc

```
1      ----      ----      ----      0000.339a.9abb 33.33.33.0
      Dynamic Remote      -----      -----
```

Total number of entries are : 1

#

CHAPTER 5 VxLAN Hybrid Access Port Configuration

This chapter shows how to configure a hybrid access port which is a Layer 2 Port (configured switchport) that is part of both a VxLAN domain and a Layer 2 bridge with different VLANs.

Overview

A hybrid VxLAN access port is Layer 2 port that is part of regular Layer 2 bridge (RSTP/MSTP/STP) and a VxLAN bridge at the same time. A switch port cannot be a part of VxLAN domain and Layer 2 Bridge if the VxLAN port is created with “port only” mapping. The same VLAN cannot be a part of both a VxLAN domain and a Layer 2 bridge.

If a port is created with “all” VLANS, then the port should not allow VxLAN access-port configurations. If a VxLAN with a specific VLAN is mapped, then configuring VLAN “all” on the same port does not allow that specified VLAN in a Layer 2 bridge. If the VxLAN access-port configurations are removed, then the specified VLAN is added immediately in a Layer 2 bridge.

Ingress traffic with a VxLAN VLAN does not receive Layer 2 traffic or vice-versa. STP states on the Port P1 do not affect VxLAN traffic.

Topology

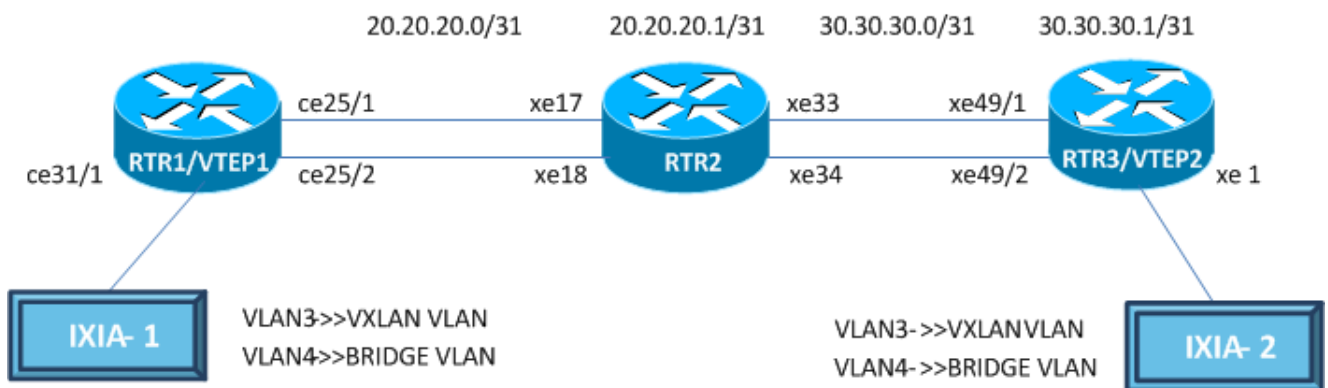

RTR1/VTEP1

#configure terminal	Enter configure mode.
(config)#interface lo	Enter interface mode for loopback.
(config-if)#ip address 10.10.10.10/32 secondary	Assign secondary IP address.
(config-if)#exit	Exit interface mode.
(config)#mac vrf vrf12345	Create mac routing/forwarding instance with vrf12345 name and enter VRF mode.
(config-vrf)#rd 1.1.1.1:1	Assign Rd value.
(config-vrf)#route-target both 10.10.10.10:10	Assign route-target both value.
(config-vrf)#exit	Exit VRF configuration mode.
(config)#bridge 32 protocol ieee vlan-bridge	Configure the ieee vlan-bridge with Id 32.

(config)#vlan 2-5 bridge 32	Configure the vlans 2-5 for the configured bridge Id 32.
(config)#interface ce25/1	Enter interface mode for ce25/1.
(config-if)#ip address 20.20.20.0/31	Assign IP address 20.20.20.0 in /31 mask.
(config-if)#exit	Exit interface mode.
(config)#interface ce25/2	Enter interface mode for ce25/2.
(config-if)#switchport	Make it L2 interface.
(config-if)#bridge-group 32	Associate the bridge-group 32 to the interface.
(config-if)#switchport mode hybrid	Configure the Hybrid mode.
(config-if)# switchport hybrid allowed vlan add 4 egress-tagged enable	Configure hybrid allowed vlan add 4 to support the created vlan in the L2 Bridge.
(config-if)#exit	Exit interface mode.
(config)#interface ce31/1	Enter interface mode for ce31/1.
(config-if)#switchport	Make it L2 interface.
(config-if)#bridge-group 32	Associate the bridge-group 32 to the interface.
(config-if)#switchport mode hybrid	Configure the Hybrid mode.
(config-if)# switchport hybrid allowed vlan add 4 egress-tagged enable	Configure hybrid allowed vlan add 4 to support the created vlan in the L2 Bridge.
(config-if)#exit	Exit interface mode.
(config)#router bgp 64512	Enter BGP router mode.
(config-router)# bgp router-id 1.1.1.1	Assign BGP router ID
(config-router)#neighbor 20.20.20.1 remote-as 64513	Specify a neighbor router with peer ip address and remote-as defined.
(config-router)#address-family ipv4 unicast	Enter into ipv4 unicast address family
(config-router-af)#network 10.10.10.10/32	Advertise loopback network into BGP for VTEP ID reachability
(config-router-af)#exit-address-family	Exit ipv4 unicast address family mode
(config-router)#address-family l2vpn evpn	Enter l2vpn address family mode.
(config-router-af)#neighbor 20.20.20.1 activate	Activate the peer into address family mode.
(config-router-af)#exit-address-family	Exit l2vpn address family mode.
(config-router)#exit	Exit BGP router mode.
(config)# hardware-profile filter vxlan enable	Enable hardware profile for vxlan
(config)#hardware-profile statistics ac-lif enable	Enable ac-lif for VxLAN access-if port counters
(config)#nvo vxlan enable	Enable Vxlan.
(config)#nvo vxlan vtep-ip-global 10.10.10.10	Configure the source Vtep-ip.
(config)#nvo vxlan id 16777215 ingress-replication inner-vid-disabled	Configure Vxlan Network identifier with/without inner-vid-disabled configure and enter Vxlan tenant mode.
(config-nvo)#vxlan host-reachability-protocol evpn-bgp vrf12345	Assign VRF for evpn-bgp to carry evpn route.
(config-nvo)#exit	Exit Vxlan tenant mode.
(config)#nvo vxlan access-if port-vlan ce31/1 3	Enable port-vlan mapping i.e. access port to outer-vlan (SVLAN) mapping.

(config-nvo-acc-if)#map vnid 16777215	Map Vxlan Identifier to access-port.
(config-nvo-acc-if)#exit	Exit Vxlan access-interface mode.
(config)#commit	Commit the candidate configuration to the running configuration

RTR2

#configure terminal	Enter configure mode.
(config)#bridge 32 protocol ieee vlan-bridge	Configure the ieee vlan-bridge with Id 32.
(config)#vlan 2-5 bridge 32	Configure the vlans 2-5 for the configured bridge Id 32.
(config)#interface xe17	Enter interface mode for xe17.
(config-if)#ip address 20.20.20.1/31	Assign IP address 20.20.20.1 in /31 mask.
(config-if)#exit	Exit interface mode.
(config)#interface xe18	Enter interface mode for xe18.
(config-if)#switchport	Make it L2 interface .
(config-if)#bridge-group 32	Associate the bridge-group 32 to the interface.
(config-if)#switchport mode hybrid	Configure the Hybrid mode.
(config-if)#switchport hybrid allowed vlan add 4 egress-tagged enable	Configure hybrid allowed vlan add 4 to support the created vlan in the L2 Bridge.
(config-if)#exit	Exit interface mode.
(config)#interface xe33	Enter interface mode for xe33.
(config-if)#ip address 30.30.30.0/31	Assign IP address 30.30.30.0 in /31 mask.
(config-if)#exit	Exit interface mode.
(config)#interface xe34	Enter interface mode for xe34.
(config-if)#switchport	Make it L2 interface.
(config-if)#bridge-group 32	Associate the bridge-group 32 to the interface.
(config-if)#switchport mode hybrid	Configure the Hybrid mode.
(config-if)#switchport hybrid allowed vlan add 4 egress-tagged enable	Configure hybrid allowed vlan add 4 to support the created vlan in the L2 Bridge.
(config-if)#exit	Exit interface mode.
(config)#router bgp 64513	Enter BGP router mode.
(config-router)# bgp router-id 2.2.2.2	Assign BGP router ID
(config-router)#neighbor 20.20.20.0 remote-as 64512	Specify a neighbor router with peer ip address and remote-as defined.
(config-router)#neighbor 30.30.30.1 remote-as 64514	Specify a neighbor router with peer ip address and remote-as defined.
(config-router)#address-family l2vpn evpn	Enter l2vpn address family mode.
(config-router-af)#neighbor 20.20.20.0 activate	Activate the peer into address family mode.
(config-router-af)#neighbor 30.30.30.1 activate	Activate the peer into address family mode.
(config-router-af)#exit-address-family	Exit l2vpn address family mode.

(config-router)#exit	Exit BGP router mode.
(config)#commit	Commit the candidate configuration to the running configuration

RTR3/VTEP2

#configure terminal	Enter configure mode.
(config)#interface lo	Enter interface mode for loopback.
(config-if)#ip address 40.40.40.40/32 secondary	Assign secondary IP address.
(config-if)#exit	Exit interface mode.
(config)#mac vrf vrf12345	Create mac routing/forwarding instance with vrf12345 name and enter VRF mode.
(config-vrf)#rd 2.2.2.2:2	Assign Rd value.
(config-vrf)#route-target both 10.10.10.10:10	Assign route-target both value.
(config-vrf)#exit	Exit VRF configuration mode.
(config)#bridge 32 protocol ieee vlan-bridge	Configure the ieee vlan-bridge with Id 32.
(config)#vlan 2-5 bridge 32	Configure the vlans 2-5 for the configured bridge Id 32.
(config)#interface xe 49/1	Enter interface mode for xe49/1.
(config-if)#ip address 30.30.30.1/31	Assign Ip address 30.30.30.1 in /31 mask.
(config-if)#exit	Exit interface mode.
(config)#interface xe49/2	Enter interface mode for xe49/2.
(config-if)#switchport	Make it L2 interface .
(config-if)#bridge-group 32	Associate the bridge-group 32 to the interface.
(config-if)#switchport mode hybrid	Configure the Hybrid mode.
(config-if)#switchport hybrid allowed vlan add 4 egress-tagged enable	Configure hybrid allowed vlan add 4 to support the created vlan in the L2 Bridge.
(config-if)#exit	Exit interface mode.
(config)#interface xe1	Enter interface mode for xe1.
(config-if)#switchport	Make it L2 interface .
(config-if)#bridge-group 32	Associate the bridge-group 32 to the interface.
(config-if)#switchport mode hybrid	Configure the Hybrid mode.
(config-if)#switchport hybrid allowed vlan add 4 egress-tagged enable	Configure hybrid allowed vlan add 4 to support the created vlan in the L2 Bridge.
(config-if)#exit	Exit interface mode.
(config)#router bgp 64514	Enter BGP router mode.
(config-router)# bgp router-id 3.3.3.3	Assign BGP router ID
(config-router)#neighbor 30.30.30.0 remote- as 64513	Specify a neighbor router with peer IP address and remote-as defined.
(config-router)#address-family ipv4 unicast	Enter into ipv4 unicast address family
(config-router-af)#network 40.40.40.40/32	Advertise loopback network into BGP for VTEP ID reachability
(config-router-af)#exit-address-family	Exit ipv4 unicast address family mode
(config-router)#address-family l2vpn evpn	Enter l2vpn address family mode.

(config-router-af)#neighbor 30.30.30.0 activate	Activate the peer into address family mode.
(config-router-af)#exit-address-family	Exit I2vpn address family mode.
(config-router)#exit	Exit BGP router mode.
(config)# hardware-profile filter vxlan enable	Enable hardware profile for vxlan
(config)#hardware-profile statistics ac-lif enable	Enable ac-lif for VxLAN access-if port counters
(config)#nvo vxlan enable	Enable Vxlan.
(config)#nvo vxlan vtep-ip-global 40.40.40.40	Configure the source Vtep-ip.
(config)#nvo vxlan id 16777215 ingress-replication inner-vid-disabled	Configure Vxlan Network identifier with/without inner-vid-disabled configure and enter Vxlan tenant mode.
(config-nvo)#vxlan host-reachability-protocol evpn-bgp vrf12345	Assign VRF for evpn-bgp to carry evpn route.
(config-nvo)#exit	Exit Vxlan tenant mode.
(config)#nvo vxlan access-if port-vlan xe1 3	Enable port-vlan mapping i.e. access port to outer-vlan (SVLAN) mapping.
(config-nvo-acc-if)#map vnid 16777215	Map Vxlan Identifier to access-port.
(config-nvo-acc-if)#exit	Exit Vxlan access-interface mode.
(config)#commit	Commit the candidate configuration to the running configuration

Validation

VTEP1

```
#show running-config nvo vxlan
!
nvo vxlan enable
!
nvo vxlan vtep-ip-global 10.10.10.10
!
nvo vxlan id 16777215 ingress-replication inner-vid-disabled
  vxlan host-reachability-protocol evpn-bgp vrf12345
!
nvo vxlan access-if port-vlan ce31/1 3
  map vnid 16777215
!
```

```
VTEP1#show nvo vxlan
VxLAN Information
=====
Codes: NW - Network Port
       AC - Access Port
       (u) - Untagged
```

```

VNID      VNI-Name      VNI-Type Type Interface      ESI      VLAN DF-
Status Src-Addr      Dst-Addr
-----
16777215 ----          L2      NW      ----          -----  ----  --
--      10.10.10.10      40.40.40.40
16777215 ----          --      AC      ce31/1        --- Single Homed Port ---  3    -
----          ----          -----
Total number of entries are 2

```

VTEP1#show nvo vxlan vnid 16777215

VxLAN Information

=====

Codes: NW - Network Port
AC - Access Port
(u) - Untagged

```

VNID      VNI-Name      VNI-Type Type Interface      ESI      VLAN DF-
Status Src-Addr      Dst-Addr
-----
16777215 ----          L2      NW      ----          -----  ----  --
--      10.10.10.10      40.40.40.40
16777215 ----          --      AC      ce31/1        --- Single Homed Port ---  3    -
----          ----          -----
Total number of entries are 2!

```

VTEP1#show ip route

Codes: K - kernel, C - connected, S - static, R - RIP, B - BGP
O - OSPF, IA - OSPF inter area
N1 - OSPF NSSA external type 1, N2 - OSPF NSSA external type 2
E1 - OSPF external type 1, E2 - OSPF external type 2
i - IS-IS, L1 - IS-IS level-1, L2 - IS-IS level-2,
ia - IS-IS inter area, E - EVPN,
v - vrf leaked
* - candidate default

IP Route Table for VRF "default"

```

C      10.10.10.10/32 is directly connected, lo, 01:15:55
C      20.20.20.0/31 is directly connected, xe10/1, 01:07:53
B      40.40.40.40/32 [20/0] via 20.20.20.1, xe10/1, 00:42:54
C      127.0.0.0/8 is directly connected, lo, 1d05h02m

```

Gateway of last resort is not set

VTEP1#show nvo vxlan tunnel

VxLAN Network tunnel Entries

```

Source      Destination      Status      Up/Down      Update
=====
33.33.33.0      34.34.34.0      Installed      00:26:27      00:26:27

```

Total number of entries are 1

```
VTEP1#show bgp l2vpn evpn summary
BGP router identifier 10.10.10.2, local AS number 64512
BGP table version is 10
2 BGP AS-PATH entries
0 BGP community entries
```

Neighbor	AD	MACIP	V	AS	MsgRcv	MsgSen	TblVer	InQ	OutQ	Up/Down	State/
PfxRcd			MCAST	ESI	PREFIX-ROUTE						
20.20.20.1			4	64513	108	109	10	0	0	00:48:14	
3	0	2	1	0	0						

Total number of neighbors 1

Total number of Established sessions 1

```
VTEP1#show bgp l2vpn evpn
BGP table version is 4, local router ID is 10.10.10.10
Status codes: s suppressed, d damped, h history, * valid, > best, i - internal,
               l - labeled, S Stale
Origin codes: i - IGP, e - EGP, ? - incomplete
```

```
[EVPN route type]:[ESI]:[VNID]:[relevent route informantion]
1 - Ethernet Auto-discovery Route
2 - MAC/IP Route
3 - Inclusive Multicast Route
4 - Ethernet Segment Route
5 - Prefix Route
```

Network	Next Hop	Metric	LocPrf	Weight	Path	Peer
Encap						
RD[1.1.1.1:1] VRF[vrf12345]:						
* [2]:[0]:[16777215]:[48,0000.0744.4433]:[0]:[16777215]	40.40.40.40	0	100	0	64513	64514
i 20.20.20.1	VxLAN					
*> [2]:[0]:[16777215]:[48,0000.2222.2222]:[0]:[16777215]	10.10.10.10	0	100	32768	i	-----
-- VxLAN						
*> [3]:[16777215]:[32,10.10.10.10]	10.10.10.10	0	100	32768	i	-----
-- VxLAN						
* [3]:[16777215]:[32,40.40.40.40]	40.40.40.40	0	100	0	64513	64514
i 20.20.20.1	VxLAN					
RD[2.2.2.2:2]						
*> [2]:[0]:[16777215]:[48,0000.0744.4433]:[0]:[16777215]	40.40.40.40	0	100	0	64513	64514
i 20.20.20.1	VxLAN					

```
*> [3]:[16777215]:[32,40.40.40.40]
      40.40.40.40          0          100          0          64513 64514
i 20.20.20.1      VxLAN
```

Total number of prefixes 6

VTEP1#show nvo vxlan mac-table

```
=====
=====
```

VxLAN MAC Entries

```
=====
=====
```

VNID Type	Interface	VlanId Status	Inner-VlanId	Mac-Addr AccessPortDesc	VTEP-Ip/ESI
16777215 Dynamic Local	ce31/1	3 -----	----	0000.2222.2222 -----	10.10.10.10
16777215 Dynamic Remote	----	-----	----	0000.0744.4433 -----	40.40.40.40

Total number of entries are : 2

VTEP1#show nvo vxlan arp-cache

VxLAN ARP-CACHE Information

```
=====
```

VNID	Ip-Addr	Mac-Addr	Type	Age-Out	Retries-Left
------	---------	----------	------	---------	--------------

Total number of entries are 0

#show vlan brief

Bridge	VLAN ID	Name	State	H/W Status	Member ports (u)-Untagged, (t)-Tagged
32	1	default	ACTIVE	Success	ce25/2 (u) ce31/1 (u)
32	2	VLAN0002	ACTIVE	Success	
32	3	VLAN0003	ACTIVE	Success	
32	4	VLAN0004	ACTIVE	Success	ce25/2 (t) ce31/1 (t)
32	5	VLAN0005	ACTIVE	Success	

RTR2

RTR2#show ip route

```
Codes: K - kernel, C - connected, S - static, R - RIP, B - BGP
       O - OSPF, IA - OSPF inter area
       N1 - OSPF NSSA external type 1, N2 - OSPF NSSA external type 2
       E1 - OSPF external type 1, E2 - OSPF external type 2
       i - IS-IS, L1 - IS-IS level-1, L2 - IS-IS level-2,
       ia - IS-IS inter area, E - EVPN,
       v - vrf leaked
       * - candidate default
```

```
IP Route Table for VRF "default"
B    10.10.10.10/32 [20/0] via 20.20.20.0, xe17, 00:29:48
C    20.20.20.0/31 is directly connected, xe17, 02:33:29
C    30.30.30.0/31 is directly connected, xe33, 02:31:56
B    40.40.40.40/32 [20/0] via 30.30.30.1, xe33, 02:23:26
C    127.0.0.0/8 is directly connected, lo, 21:17:41
```

Gateway of last resort is not set

```
RTR2#show bgp l2vpn evpn summary
BGP router identifier 11.11.11.1, local AS number 64513
BGP table version is 10
2 BGP AS-PATH entries
0 BGP community entries
```

Neighbor PfxRcd	AD	MACIP	V MCAST	AS	MsgRcv ESI	MsgSen PREFIX-ROUTE	TblVer	InQ	OutQ	Up/Down	State/
20.20.20.0			4	64512	111	112	10	0	0	00:49:36	
3	0	2	1	0	0						
30.30.30.1			4	64514	101	103	10	0	0	00:45:10	
3	0	2	1	0	0						

Total number of neighbors 2

Total number of Established sessions 2

VTEP2

```
VTEP2#show running-config nvo vxlan
!
nvo vxlan enable
!
nvo vxlan vtep-ip-global 40.40.40.40
!
nvo vxlan id 16777215 ingress-replication inner-vid-disabled
  vxlan host-reachability-protocol evpn-bgp vrf12345
!
nvo vxlan access-if port-vlan xe1 3
  map vnid 16777215
!
```

```
VTEP2#show nvo vxlan
```

VxLAN Information

=====

```
Codes: NW - Network Port
       AC - Access Port
       (u) - Untagged
```

VNID	VNI-Name	VNI-Type	Type	Interface	ESI	VLAN	DF-Status	Src-Addr	Dst-Addr
------	----------	----------	------	-----------	-----	------	-----------	----------	----------

```

16777215 ---- L2 NW ---- ----- ---- --
-- 40.40.40.40 10.10.10.10
16777215 ---- -- AC xe1 --- Single Homed Port --- 3 ----
-----

```

Total number of entries are 2

VTEP2#show ip route

Codes: K - kernel, C - connected, S - static, R - RIP, B - BGP
O - OSPF, IA - OSPF inter area
N1 - OSPF NSSA external type 1, N2 - OSPF NSSA external type 2
E1 - OSPF external type 1, E2 - OSPF external type 2
i - IS-IS, L1 - IS-IS level-1, L2 - IS-IS level-2,
ia - IS-IS inter area, E - EVPN,
v - vrf leaked
* - candidate default

IP Route Table for VRF "default"

```

B 10.10.10.10/32 [20/0] via 30.30.30.0, xe11/1, 00:27:32
C 30.30.30.0/31 is directly connected, xe11/1, 00:30:00
C 40.40.40.40/32 is directly connected, lo, 00:31:00
C 127.0.0.0/8 is directly connected, lo, 06:25:00

```

Gateway of last resort is not set

VTEP2#show nvo vxlan tunnel

VxLAN Network tunnel Entries

Source	Destination	Status	Up/Down	Update
40.40.40.40	10.10.10.10	Installed	00:14:40	00:14:40

Total number of entries are 1

VTEP2#show bgp l2vpn evpn summary

BGP router identifier 33.33.33.33, local AS number 64514
BGP table version is 8
2 BGP AS-PATH entries
0 BGP community entries

Neighbor	AD	MACIP	V AS	MsgRcv	MsgSen	TblVer	InQ	OutQ	Up/Down	State/
PfxRcd			MCAST	ESI	PREFIX-ROUTE					
30.30.30.0			4 64513	267	270	8	0	0	02:09:07	
2	0	1	1 0	0						

Total number of neighbors 1

Total number of Established sessions 1

```
VTEP2#show bgp l2vpn evpn
BGP table version is 8, local router ID is 40.40.40.40
Status codes: s suppressed, d damped, h history, * valid, > best, i - internal,
               l - labeled, S Stale
Origin codes: i - IGP, e - EGP, ? - incomplete
```

```
[EVPN route type]:[ESI]:[VNID]:[relevent route informantion]
1 - Ethernet Auto-discovery Route
2 - MAC/IP Route
3 - Inclusive Multicast Route
4 - Ethernet Segment Route
5 - Prefix Route
```

Network	Next Hop	Metric	LocPrf	Weight	Path	Peer
Encap						
RD[1.1.1.1:1]						
*> [2]:[0]:[16777215]:[48,0000.2222.2222]:[0]:[16777215]	10.10.10.10	0	100	0	64513	64512
i 30.30.30.0	VxLAN					
*> [3]:[16777215]:[32,10.10.10.10]	10.10.10.10	0	100	0	64513	64512
i 30.30.30.0	VxLAN					
RD[2.2.2.2:2] VRF[vrf12345]:						
*> [2]:[0]:[16777215]:[48,0000.0744.4433]:[0]:[16777215]	40.40.40.40	0	100	32768	i	-----
-- VxLAN						
* [2]:[0]:[16777215]:[48,0000.2222.2222]:[0]:[16777215]	10.10.10.10	0	100	0	64513	64512
i 30.30.30.0	VxLAN					
* [3]:[16777215]:[32,10.10.10.10]	10.10.10.10	0	100	0	64513	64512
i 30.30.30.0	VxLAN					
*> [3]:[16777215]:[32,40.40.40.40]	40.40.40.40	0	100	32768	i	-----
-- VxLAN						

Total number of prefixes 6

```
VTEP2#show nvo vxlan mac-table
```

```
=====
VxLAN MAC Entries
=====
```

VNID Type	Interface	VlanId Status	Inner-VlanId	Mac-Addr AccessPortDesc	VTEP-Ip/ESI

```

16777215 ----      ----  ----      0000.2222.2222 10.10.10.10
Dynamic Remote      -----
16777215 xe1      3      ----      0000.0744.4433 40.40.40.40
Dynamic Local      -----

```

Total number of entries are : 2

VTEP2#show vlan brief

Bridge	VLAN ID	Name	State	H/W Status	Member ports (u)-Untagged, (t)-Tagged
32	1	default	ACTIVE	Success	xe1 (u) xe49/2 (u)
32	2	VLAN0002	ACTIVE	Success	
32	3	VLAN0003	ACTIVE	Success	
32	4	VLAN0004	ACTIVE	Success	xe1 (t) xe49/2 (t)
32	5	VLAN0005	ACTIVE	Success	

VTEP2#

CHAPTER 6 VxLAN Multi-Homing Configuration

This chapter contains the configurations for VxLAN Multi-homing feature.

Overview

VxLAN EVPN Multi-homing features enables to connect a CE/Host node to two VTEPs with all-active redundancy mode. A redundant VTEP device can provide network service to the customer site as soon as a failure is detected. The failure can be link or node failure. If one VTEP goes down, other will forward the entire traffic.

Below are Multi-homing concepts:

- Ethernet Segment: Set of links which connect host/CE to two active-active multi-homed VTEP (only two VTEPs are supported) which appears as LACP link for host.
- Ethernet Segment Identifier: Ethernet Segment Identifier (ESI) which is a 10 octet-value, which can be configured in two ways, system MAC is configured as esi in case of Dynamic LAG and 10-octet ESI format configuration is used on physical interface ES.
- Ethernet Segment Route (ES route): When a multi-homed CE is configured as an VxLAN access-port, Ethernet segment route is sent. The main purpose of this route is to discover other VTEPs which share the ES and to perform DF election.
- Ethernet A-D route per ESI: This route is used for Fast Convergence and Split Horizon.
- Ethernet A-D route per EVI: This route is used for load sharing between DF and NON-DF by the remote VTEPs

Topology

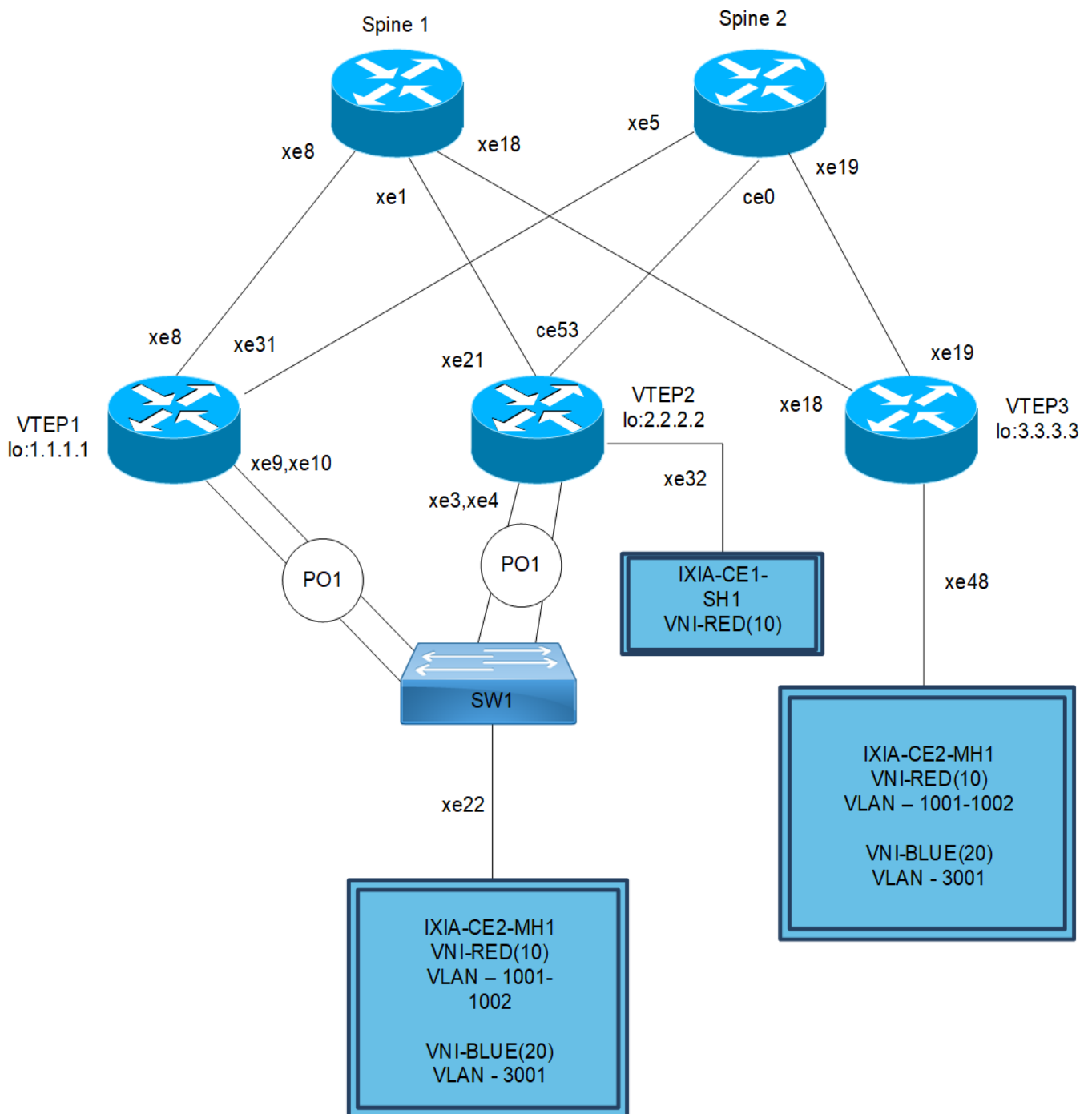

Figure 6-7: VxLAN-Multihoming

Note: Enable VxLAN MUTIHOMING before executing any configurations.

VxLAN-EVPN MH Configuration

ESI can be configured in below two ways

Ethernet Segment through Dynamic LAG interface

#configure terminal	Enter Configure mode.
(config)#interface po1	Enter Interface mode for po1
(config-if)#switchport	Make it L2 interface
(config-if)#evpn multi-homed system-mac 8899.4400.6745	Configure system mac as ESI value for LAG (po1) interface
(config-if)#exit	Exit Interface mode.
(config)#commit	Commit the candidate configuration to the running configuration

OR

Ethernet Segment through Physical or Static LAG interface

#configure terminal	Enter Configure mode.
(config)#interface xe41	Enter Interface mode for xe41
(config-if)#switchport	Make it L2 interface
(config-if)# evpn multi-homed esi 00:01:02:03:04:05:06:07:08	Configure 9-octet ESI value for xe41 interface (in static config, out of 10-octet ESI value, first octet is reserved)
(config-if)#exit	Exit Interface mode.
(config)#commit	Commit the candidate configuration to the running configuration

VTEP1

(Multi-homed group1) – Part of both Multi-homed with po1 (MH1)

Hardware Profile and Generic Configuration

#configure terminal	Enter Configure mode.
(config)#hardware-profile filter vxlan enable	Enable hardware-profile filter for VxLAN.
(config)#hardware-profile filter vxlan-mh enable	Enable hardware-profile filter for VxLAN multi-homing.
(config)#hardware-profile filter egress-ipv4 enable	Enable hardware-profile filter for egress IPv4.
(config)#evpn vxlan multihoming enable	Enable Multihoming, save configs and reboot the board for multihoming to be effective
(config)#hardware-profile statistics ac-lif enable	Enable ac-lif for VxLAN access-if port counters

(config)#qos enable	Enabling QoS
(config)#commit	Commit the candidate configuration to the running configuration

Interface and Loopback Configuration

(config)#interface po1	Enter Interface mode for po1 (MH1)
(config-if)#switchport	Make it L2 interface
(config-if)# evpn multi-homed system-mac 0000.0000.1111	Configure system MAC as ESI value for LAG (po1) interface
(config-if)#exit	Exit Interface mode and return to Configure mode.
(config)#interface xe9	Enter Interface mode for xe9
(config-if)#channel-group 1 mode active	Make it member port of po1
(config-if)#exit	Exit Interface mode and return to Configure mode.
(config)#interface xe10	Enter Interface mode for xe10
(config-if)#channel-group 1 mode active	Make it member port of po1
(config-if)#exit	Exit Interface mode and return to Configure mode.
(config)#interface lo	Enter Interface mode for lo
(config-if)#ip address 1.1.1.1/32 secondary	Configure loopback ip address as 1.1.1.1 for VTEP1
(config-if)#exit	Exit Interface mode and return to Configure mode.
(config)#interface xe8	Enter Interface mode for xe8
(config-if)#ip address 10.10.10.1/24	Configure IP address as 10.10.10.1 on network side of Spine1
(config-if)#exit	Exit Interface mode and return to Configure mode.
(config)#interface xe31	Enter Interface mode for xe31
(config-if)#ip address 20.20.20.1/24	Configure IP address as 20.20.20.1 on network side of Spine2
(config-if)#exit	Exit Interface mode and return to Configure mode.
(config)#commit	Commit the candidate configuration to the running configuration

OSPF Configuration

(config)#router ospf 100	Enter into router OSPF mode
(config-router)#ospf router-id 1.1.1.1	Configure router-id as 1.1.1.1 (lo ip address)
(config-router)#network 1.1.1.1/32 area 0.0.0.0	Add 1.1.1.1 (lo IP address) network into area 0
(config-router)#network 10.10.10.0/24 area 0.0.0.0	Add 10.10.10.0 (Spine1) network into area 0
(config-router)#network 20.20.20.0/24 area 0.0.0.0	Add 20.20.20.0 (Spine2) network into area 0
(config-router)#bfd all-interfaces	Enabling BFD on all OSPF interface for fast convergence
(config-if)#exit	Exit Interface mode and return to Configure mode.
(config)#commit	Commit the candidate configuration to the running configuration

BGP Configuration

(config)#router bgp 500	Enter into Router BGP mode
(config-router)#bgp router-id 1.1.1.1	Configure router-id as 1.1.1.1 (lo IP address)
(config-router)#neighbor 2.2.2.2 remote-as 500	Specify a VTEP2 loopback IP address and remote-as defined
(config-router)#neighbor 2.2.2.2 update-source lo	Configure update as loopback for VTEP2
(config-router)#neighbor 2.2.2.2 advertisement-interval 0	Configure advertisement-interval as 0 for fast convergence for VTEP2
(config-router)#neighbor 3.3.3.3 remote-as 500	Specify a VTEP3 loopback IP address and remote-as defined
(config-router)#neighbor 3.3.3.3 update-source lo	Configure update as loopback for VTEP3
(config-router)#neighbor 3.3.3.3 advertisement-interval 0	Configure advertisement-interval as 0 for fast convergence for VTEP3
(config-router)#address-family ipv4 unicast	Enter into ipv4 unicast address family mode
(config-router-af)#network 1.1.1.1/32	Advertise loopback network into BGP for VTEP ID reachability
(config-router-af)#neighbor 2.2.2.2 activate	Activate 2.2.2.2 (VTEP2) into ipv4 unicast address family mode
(config-router-af)#neighbor 3.3.3.3 activate	Activate 3.3.3.3 (VTEP2) into ipv4 unicast address family mode
(config-router-af)#exit-address-family	Exit from ipv4 unicast address family mode
(config-router)#address-family l2vpn evpn	Enter into L2VPN EVPN address family mode
(config-router-af)#neighbor 2.2.2.2 activate	Activate 2.2.2.2 (VTEP2) into L2VPN evpn address family mode
(config-router-af)#neighbor 3.3.3.3 activate	Activate 3.3.3.3 (VTEP3) into L2VPN evpn address family mode
(config-router-af)#exit-address-family	Exit from L2VPN address family mode
(config-router)#exit	Exit from Router BGP mode and enter into config mode
(config)#commit	Commit the candidate configuration to the running configuration

VRF Configuration

(config)#mac vrf VRF1	Create mac routing/forwarding instance with VRF1 name and enter into VRF mode
(config-vrf)#rd 1.1.1.1:11	Assign RD value
(config-vrf)#route-target both 9.9.9.9:100	Assign route-target value for same for import and export. Should be same on all node for VRF1
(config-vrf)#exit	Exit from VRF mode
(config)#mac vrf VRF2	Create MAC routing/forwarding instance with VRF1 name and enter into VRF mode
(config-vrf)#rd 1.1.1.1:21	Assign RD value
(config-vrf)#route-target both 90.90.90.90:100	Assign route-target value for same for import and export

<code>(config-vrf)#exit</code>	Exit from VRF mode
<code>(config)#commit</code>	Commit the candidate configuration to the running configuration

VxLAN Configuration

<code>(config)#nvo vxlan enable</code>	Enable VxLAN
<code>(config)#evpn esi hold-time 60</code>	Configure ESI hold time to allow tunnel to come up at the time of VxLAN initialization before making the ESI up
<code>(config)#nvo vxlan vtep-ip-global 1.1.1.1</code>	Configure Source VTEP-IP-global configuration
<code>(config)#nvo vxlan id 10 ingress-replication inner-vid-disabled</code>	Configure VxLAN Network identifier with/without inner-VID-disabled configure and enter into VxLAN tenant mode
<code>(config-nvo)#vxlan host-reachability-protocol evpn-bgp VRF1</code>	Assign VRF for EVPN-BGP to carry EVPN route
<code>(config-nvo)#vni-name VNI-RED</code>	Configure VNI-name as VNI-RED
<code>(config-nvo)#exit</code>	Exit from VxLAN tenant mode and enter into configuration mode.
<code>(config)#nvo vxlan id 20 ingress-replication inner-vid-disabled</code>	Configure VxLAN Network identifier with/without inner-VID-disabled configure and enter into VxLAN tenant mode
<code>(config-nvo)#vxlan host-reachability-protocol evpn-bgp VRF2</code>	Assign VRF for EVPN-BGP to carry EVPN route
<code>(config-nvo)#vni-name VNI-BLUE</code>	Configure VNI-name as VNI-BLUE
<code>(config-nvo)#exit</code>	Exit from VxLAN tenant mode and enter into configuration mode.
<code>(config)#nvo vxlan access-if port-vlan po1 1001</code>	Enable port-VLAN mapping i.e. access port to outer-VLAN (SVLAN) - Multihomed access port
<code>(config-nvo-acc-if)#map vni-name VNI-RED</code>	Map VxLAN Identified to access-port for VxLAN
<code>(config-nvo-acc-if)#exit</code>	Exit from VxLAN access-interface mode and enter into configuration mode
<code>(config)#nvo vxlan access-if port-vlan po1 1002</code>	Enable port-VLAN mapping i.e. access port to outer-VLAN (SVLAN) - Multihomed access port
<code>(config-nvo-acc-if)#map vni-name VNI-RED</code>	Map VxLAN Identified to access-port for VxLAN
<code>(config-nvo-acc-if)#exit</code>	Exit from VxLAN access-interface mode and enter into configuration mode
<code>(config)#nvo vxlan access-if port-vlan po1 3001</code>	Enable port-VLAN mapping i.e. access port to outer-VLAN (SVLAN) - Multihomed access port
<code>(config-nvo-acc-if)#map vni-name VNI-BLUE</code>	Map VxLAN Identified to access-port for VxLAN
<code>(config-nvo-acc-if)#exit</code>	Exit from VxLAN access-interface mode and enter into configuration mode
<code>(config)#commit</code>	Commit the candidate configuration to the running configuration
<code>(config)#exit</code>	Exit from configuration mode

VTEP2

(Multi-homed group1) – Part of both Multi-homed with po1 (MH1). And it has xe32 as single home access-if port (SH2)

Hardware Profile and Generic Configuration

#configure terminal	Enter Configure mode.
(config)#hardware-profile filter vxlan enable	Enable hardware-profile filter for VxLAN.
(config)#hardware-profile filter vxlan-mh enable	Enable hardware-profile filter for VxLAN multi-homing.
(config)#hardware-profile filter egress-ipv4 enable	Enable hardware-profile filter for egress IPv4.
(config)#evpn vxlan multihoming enable	Enable Multihoming, save configs and reboot the board for multihoming to be effective
(config)#hardware-profile statistics ac-lif enable	Enable ac-lif for VxLAN access-if port counters
(config)#qos enable	Enabling QoS
(config)#commit	Commit the candidate configuration to the running configuration

Interface and Loopback Configuration

(config)#interface po1	Enter Interface mode for po1 (MH1)
(config-if)#switchport	Make it L2 interface
(config-if)# evpn multi-homed system-mac 0000.0000.1111	Configure system MAC as ESI value for LAG (po1) interface
(config-if)#exit	Exit Interface mode and return to Configure mode.
(config)#interface xe3	Enter Interface mode for xe3
(config-if)#channel-group 1 mode active	Make it member port of po1
(config-if)#exit	Exit Interface mode and return to Configure mode.
(config)#interface xe4	Enter Interface mode for xe4
(config-if)#channel-group 1 mode active	Make it member port of po1
(config-if)#exit	Exit Interface mode and return to Configure mode.
(config)#interface xe32	Enter Interface mode for xe32 (SH2)
(config-if)#switchport	Make it L2 interface
(config-if)#exit	Exit Interface mode and return to Configure mode.
(config)#interface lo	Enter Interface mode for lo
(config-if)#ip address 2.2.2.2/32 secondary	Configure loopback IP address as 2.2.2.2 for VTEP2
(config-if)#exit	Exit Interface mode and return to Configure mode.
(config)#interface xe21	Enter Interface mode for xe21
(config-if)#ip address 30.30.30.1/24	Configure IP address as 30.30.30.1 on network side of Spine1
(config-if)#exit	Exit Interface mode and return to Configure mode.
(config)#interface ce53	Enter Interface mode for ce53
(config-if)#ip address 40.40.40.1/24	Configure IP address as 40.40.40.1 on network side of Spine2
(config-if)#exit	Exit Interface mode and return to Configure mode.
(config)#commit	Commit the candidate configuration to the running configuration

OSPF Configuration

(config)#router ospf 100	Enter into router OSPF mode
(config-router)#ospf router-id 2.2.2.2	Configure router-id as 2.2.2.2 (lo IP address)
(config-router)#network 2.2.2.2/32 area 0.0.0.0	Add 2.2.2.2 (lo IP address) network into area 0
(config-router)#network 30.30.30.0/24 area 0.0.0.0	Add 30.30.30.0 (Spine1) network into area 0
(config-router)#network 40.40.40.0/24 area 0.0.0.0	Add 40.40.40.0 (Spine2) network into area 0
(config-router)#bfd all-interfaces	Enabling BFD on all OSPF interface for fast convergence
(config-if)#exit	Exit Interface mode and return to Configure mode.
(config)#commit	Commit the candidate configuration to the running configuration

BGP Configuration

(config)#router bgp 500	Enter into Router BGP mode
(config-router)#bgp router-id 2.2.2.2	Configure router-id as 2.2.2.2 (lo IP address)
(config-router)#neighbor 1.1.1.1 remote-as 500	Specify a VTEP1 loopback IP address and remote-as defined
(config-router)#neighbor 1.1.1.1 update-source lo	Configure update as loopback for VTEP1
(config-router)#neighbor 1.1.1.1 advertisement-interval 0	Configure advertisement-interval as 0 for fast convergence for VTEP1
(config-router)#neighbor 3.3.3.3 remote-as 500	Specify a VTEP3 loopback IP address and remote-as defined
(config-router)#neighbor 3.3.3.3 update-source lo	Configure update as loopback for VTEP3
(config-router)#neighbor 3.3.3.3 advertisement-interval 0	Configure advertisement-interval as 0 for fast convergence for VTEP3
(config-router)#address-family ipv4 unicast	Enter into ipv4 unicast address family mode
(config-router-af)#network 2.2.2.2/32	Advertise loopback network into BGP for VTEP ID reachability
(config-router-af)#neighbor 1.1.1.1 activate	Activate 1.1.1.1 (VTEP2) into ipv4 unicast address family mode
(config-router-af)#neighbor 3.3.3.3 activate	Activate 3.3.3.3 (VTEP2) into ipv4 unicast address family mode
(config-router-af)#exit-address-family	Exit from ipv4 unicast address family mode
(config-router)#address-family l2vpn evpn	Enter into L2VPN EVPN address family mode
(config-router-af)#neighbor 1.1.1.1 activate	Activate 1.1.1.1(VTEP1) into L2VPN evpn address family mode
(config-router-af)#neighbor 3.3.3.3 activate	Activate 3.3.3.3(VTEP3) into L2VPN evpn address family mode
(config-router-af)#exit-address-family	Exit from L2VPN address family mode
(config-router)#exit	Exit from Router BGP mode and enter into config mode
(config)#commit	Commit the candidate configuration to the running configuration

VRF Configuration

(config)# mac vrf VRF1	Create mac routing/forwarding instance with VRF1 name and enter into VRF mode
(config-vrf)#rd 2.2.2.2:11	Assign RD value
(config-vrf)#route-target both 9.9.9.9:100	Assign route-target value for same for import and export. Should be same on all node for VRF1
(config-vrf)#exit	Exit from VRF mode
(config)#mac vrf VRF2	Create MAC routing/forwarding instance with VRF1 name and enter into VRF mode
(config-vrf)#rd 2.2.2.2:21	Assign RD value
(config-vrf)#route-target both 90.90.90.90:100	Assign route-target value for same for import and export
(config-vrf)#exit	Exit from VRF mode
(config)#commit	Commit the candidate configuration to the running configuration

VxLAN Configuration

(config)#nvo vxlan enable	Enable VxLAN
(config)#evpn esi hold-time 60	Configure ESI hold time to allow tunnel to come up at the time of VxLAN initialization before making the ESI up
(config)#nvo vxlan vtep-ip-global 2.2.2.2	Configure Source VTEP-IP-global configuration
(config)#nvo vxlan id 10 ingress-replication inner-vid-disabled	Configure VxLAN Network identifier with/without inner-VID-disabled configure and enter into VxLAN tenant mode
(config-nvo)#vxlan host-reachability-protocol evpn-bgp VRF1	Assign VRF for EVPN-BGP to carry EVPN route
(config-nvo)#vni-name VNI-RED	Configure VNI-name as VNI-RED
(config-nvo)#exit	Exit from VxLAN tenant mode and enter into configuration mode.
(config)#nvo vxlan id 20 ingress-replication inner-vid-disabled	Configure VxLAN Network identifier with/without inner-VID-disabled configure and enter into VxLAN tenant mode
(config-nvo)#vxlan host-reachability-protocol evpn-bgp VRF2	Assign VRF for EVPN-BGP to carry EVPN route
(config-nvo)#vni-name VNI-BLUE	Configure VNI-name as VNI-BLUE
(config-nvo)#exit	Exit from VxLAN tenant mode and enter into configuration mode.
(config)#nvo vxlan access-if port-vlan po1 1001	Enable port-VLAN mapping i.e. access port to outer-VLAN (SVLAN) - Multihomed access port
(config-nvo-acc-if)#map vni-name VNI-RED	Map VxLAN Identified to access-port for VxLAN
(config-nvo-acc-if)#exit	Exit from VxLAN access-interface mode and enter into configuration mode
(config)#nvo vxlan access-if port-vlan po1 1002	Enable port-VLAN mapping i.e. access port to outer-VLAN (SVLAN) - Multihomed access port
(config-nvo-acc-if)#map vni-name VNI-RED	Map VxLAN Identified to access-port for VxLAN
(config-nvo-acc-if)#exit	Exit from VxLAN access-interface mode and enter into configuration mode

(config)#nvo vxlan access-if port-vlan po1 3001	Enable port-VLAN mapping i.e. access port to outer-VLAN (SVLAN) - Multihomed access port
(config-nvo-acc-if)#map vni-name VNI-BLUE	Map VxLAN Identified to access-port for VxLAN
(config-nvo-acc-if)#exit	Exit from VxLAN access-interface mode and enter into configuration mode
(config)#nvo vxlan access-if port xe32	Enable port-VLAN mapping i.e. access port to outer-VLAN (SVLAN) - Multihomed access port
(config-nvo-acc-if)#map vni-name VNI-RED	Map VxLAN Identified to access-port for VxLAN
(config-nvo-acc-if)#exit	Exit from VxLAN access-interface mode and enter into configuration mode
(config)#exit	Exit from configuration mode
(config)#commit	Commit the candidate configuration to the running configuration

VTEP3

It has xe48 as Single home access-if port (SH2)

Hardware Profile and Generic Configuration

#configure terminal	Enter Configure mode.
(config)#hardware-profile filter vxlan enable	Enable hardware-profile filter for VxLAN.
(config)#hardware-profile filter vxlan-mh enable	Enable hardware-profile filter for VxLAN multi-homing.
(config)#hardware-profile filter egress-ipv4 enable	Enable hardware-profile filter for egress IPv4.
(config)#evpn vxlan multihoming enable	Enable Multihoming, save configs and reboot the board for multihoming to be effective
(config)#hardware-profile statistics ac-lif enable	Enable ac-lif for VxLAN access-if port counters
(config)#qos enable	Enabling QoS
(config)#commit	Commit the candidate configuration to the running configuration

Interface and loopback configuration

(config)#interface xe48	Enter Interface mode for xe48 (SH3)
(config-if)#switchport	Make it L2 interface
(config-if)#exit	Exit Interface mode and return to Configure mode.
(config)#interface lo	Enter Interface mode for lo
(config-if)#ip address 3.3.3.3/32 secondary	Configure loopback IP address as 3.3.3.3 for VTEP3
(config-if)#exit	Exit Interface mode and return to Configure mode.
(config)#interface xe18	Enter Interface mode for xe18
(config-if)#ip address 50.50.50.1/24	Configure IP address as 50.50.50.1 on network side of Spine1
(config-if)#exit	Exit Interface mode and return to Configure mode.

(config)#interface xe19	Enter Interface mode for xe19
(config-if)#ip address 60.60.60.1/24	Configure IP address as 60.60.60.1 on network side of Spine2
(config-if)#exit	Exit Interface mode and return to Configure mode.
(config)#commit	Commit the candidate configuration to the running configuration

OSPF Configuration

(config)#router ospf 100	Enter into router OSPF mode
(config-router)#ospf router-id 3.3.3.3	Configure router-ID as 3.3.3.3 (lo IP address)
(config-router)#network 3.3.3.3/32 area 0.0.0.0	Add 3.3.3.3 (lo IP address) network into area 0
(config-router)#network 50.50.50.0/24 area 0.0.0.0	Add 50.50.50.0 (Spine1) network into area 0
(config-router)#network 60.60.60.0/24 area 0.0.0.0	Add 60.60.60.0 (Spine2) network into area 0
(config-router)#bfd all-interfaces	Enabling BFD on all OSPF interface for fast convergence
(config-if)#exit	Exit Interface mode and return to Configure mode.
(config)#commit	Commit the candidate configuration to the running configuration

BGP Configuration

(config)#router bgp 500	Enter into Router BGP mode
(config-router)#bgp router-id 3.3.3.3	Configure router-ID as 3.3.3.3 (lo ip address)
(config-router)#neighbor 1.1.1.1 remote-as 500	Specify a VTEP1 loopback IP address and remote-as defined
(config-router)#neighbor 1.1.1.1 update-source lo	Configure update as loopback for VTEP1
(config-router)#neighbor 1.1.1.1 advertisement-interval 0	Configure advertisement-interval as 0 for fast convergence for VTEP1
(config-router)#neighbor 2.2.2.2 remote-as 500	Specify a VTEP2 loopback IP address and remote-as defined
(config-router)#neighbor 2.2.2.2 update-source lo	Configure update as loopback for VTEP2
(config-router)#neighbor 2.2.2.2 advertisement-interval 0	Configure advertisement-interval as 0 for fast convergence for VTEP3
(config-router)#address-family ipv4 unicast	Enter into ipv4 unicast address family mode
(config-router-af)#network 3.3.3.3/32	Advertise loopback network into BGP for VTEP ID reachability
(config-router-af)#neighbor 1.1.1.1 activate	Activate 1.1.1.1 (VTEP2) into ipv4 unicast address family mode
(config-router-af)#neighbor 2.2.2.2 activate	Activate 2.2.2.2 (VTEP2) into ipv4 unicast address family mode
(config-router-af)#exit-address-family	Exit from ipv4 unicast address family mode
(config-router)#address-family l2vpn evpn	Enter into L2VPN EVPN address family mode
(config-router-af)#neighbor 1.1.1.1 activate	Activate 1.1.1.1 (VTEP1) into L2VPN evpn address family mode

(config-router-af)#neighbor 2.2.2.2 activate	Activate 2.2.2.2 (VTEP2) into L2VPN evpn address family mode
(config-router-af)#exit-address-family	Exit from L2VPN address family mode
(config-router)#exit	Exit from Router BGP mode and enter into config mode
(config)#commit	Commit the candidate configuration to the running configuration

VRF Configuration

(config)# mac vrf VRF1	Create MAC routing/forwarding instance with VRF1 name and enter into VRF mode
(config-vrf)#rd 3.3.3.3:11	Assign RD value
(config-vrf)#route-target both 9.9.9.9:100	Assign route-target value for same for import and export. Should be same on all node for VRF1
(config-vrf)#exit	Exit from VRF mode
(config)#mac vrf VRF2	Create MAC routing/forwarding instance with VRF2 name and enter into VRF mode
(config-vrf)#rd 3.3.3.3:21	Assign RD value
(config-vrf)#route-target both 90.90.90.90:100	Assign route-target value for same for import and export
(config-vrf)#exit	Exit from VRF
(config)#commit	Commit the candidate configuration to the running configuration

VxLAN Configuration

(config)#nvo vxlan enable	Enable VxLAN
(config)#nvo vxlan vtep-ip-global 3.3.3.3	Configure Source VTEP-IP-global configuration
(config)#nvo vxlan id 10 ingress-replication inner-vid-disabled	Configure VxLAN Network identifier with/without inner-VID-disabled configure and enter into VxLAN tenant mode
(config-nvo)#vxlan host-reachability-protocol evpn-bgp VRF1	Assign VRF for EVPN-BGP to carry EVPN route
(config-nvo)#vni-name VNI-RED	Configure VNI-name as VNI-RED
(config-nvo)#exit	Exit from VxLAN tenant mode and enter into configuration mode.
(config)#nvo vxlan id 20 ingress-replication inner-vid-disabled	Configure VxLAN Network identifier with/without inner-VID-disabled configure and enter into VxLAN tenant mode
(config-nvo)#vxlan host-reachability-protocol evpn-bgp VRF2	Assign VRF for EVPN-BGP to carry EVPN route
(config-nvo)#vni-name VNI-BLUE	Configure VNI-name as VNI-BLUE
(config-nvo)#exit	Exit from VxLAN tenant mode and enter into configuration mode.
(config)#nvo vxlan access-if port-vlan xe48 1001	Enable port-VLAN mapping i.e. access port to outer-VLAN (SVLAN) - Multihomed access port
(config-nvo-acc-if)#map vni-name VNI-RED	Map VxLAN Identified to access-port for VxLAN
(config-nvo-acc-if)#exit	Exit from VxLAN access-interface mode and enter into configuration mode

(config)#nvo vxlan access-if port-vlan xe48 1002	Enable port-VLAN mapping i.e. access port to outer-VLAN (SVLAN) - Multihomed access port
(config-nvo-acc-if)#map vni-name VNI-RED	Map VxLAN Identified to access-port for VxLAN
(config-nvo-acc-if)#exit	Exit from VxLAN access-interface mode and enter into configuration mode
(config)#nvo vxlan access-if port-vlan xe48 3001	Enable port-VLAN mapping i.e. access port to outer-VLAN (SVLAN) - Multihomed access port
(config-nvo-acc-if)#map vni-name VNI-BLUE	Map VxLAN Identified to access-port for VxLAN
(config-nvo-acc-if)#exit	Exit from VxLAN access-interface mode and enter into configuration mode
(config)#commit	Commit the candidate configuration to the running configuration
(config)#exit	Exit from configuration mode

Switch (CE2)

Multihomed to 2-VTEPs (VTEP1 and VTEP2)

#configure terminal	Enter Configure mode.
(config)#bridge 1 protocol ieee vlan-bridge	Configure IEEE VLAN bridge
(config)#vlan 1001-1002 bridge 1 state enable	Configure VLANs from 1001-1002 and associate with bridge 1
(config)#vlan 3001 bridge 1 state enable	Configure VLANs from 3001 and associate with bridge 1
(config)#interface xe22	Enter Interface mode for xe22
(config-if)#switchport	Make xe22 as L2 port by configuring switchport
(config-if)#bridge-group 1	Associate xe22 to bridge 1
(config-if)#switchport mode hybrid	Configure xe22 as hybrid port
(config-if)#switchport hybrid allowed vlan add 1001-1002,3001 egress-tagged enable	Allow 1001-1002 and 3001 configured VLANs on xe22
(config-if)#exit	Exit Interface mode and return to Configure mode.
(config)#interface po1	Enter Interface mode for po1
(config-if)#switchport	Make po1 as L2 port by configuring switchport
(config-if)#bridge-group 1	Associate po1 to bridge 1
(config-if)#switchport mode hybrid	Configure po1 as hybrid port
(config-if)#switchport hybrid allowed vlan add 1001-1002,3001 egress-tagged enable	Allow 1001-1002 and 3001 configured VLANs on po1
(config-if)#exit	Exit Interface mode and return to Configure mode.
(config)#interface xe3	Enter Interface mode for xe3
(config-if)#channel-group 1 mode active	Make it member port of po1
(config-if)#exit	Exit Interface mode and return to Configure mode.
(config)#interface xe4	Enter Interface mode for xe4
(config-if)#channel-group 1 mode active	Make it member port of po1
(config-if)#exit	Exit from configuration mode
(config)#interface xe9	Enter Interface mode for xe9

(config-if)#channel-group 1 mode active	Make it member port of po1
(config)#interface xe10	Enter Interface mode for xe10
(config-if)#channel-group 1 mode active	Make it member port of po1
(config-if)#exit	Exit Interface mode and return to Configure mode.
(config)#commit	Commit the candidate configuration to the running configuration
(config)#exit	Exit from configuration mode

Spine 1

Spine node where all VTEPs are connected

Generic Configuration

#configure terminal	Enter Configure mode.
(config)#qos enable	Enabling QoS
(config)#commit	Commit the candidate configuration to the running configuration

Interface and Loopback Configuration

(config)#interface lo	Enter Interface mode for lo
(config-if)#ip address 11.11.11.11/32 secondary	Configure loopback IP address as 11.11.11.11 for Spine1
(config-if)#exit	Exit Interface mode and return to Configure mode.
(config)#interface xe8	Enter Interface mode for xe8
(config-if)#ip address 10.10.10.2/24	Configure IP address as 10.10.10.2 on network side of VTEP1
(config-if)#exit	Exit Interface mode and return to Configure mode.
(config)#interface xe1	Enter Interface mode for xe1
(config-if)#ip address 30.30.30.2/24	Configure IP address as 30.30.30.2 on network side of VTEP2
(config-if)#exit	Exit Interface mode and return to Configure mode.
(config)#interface xe18	Enter Interface mode for xe18
(config-if)#ip address 50.50.50.2/24	Configure IP address as 50.50.50.2 on network side of VTEP3
(config-if)#exit	Exit Interface mode and return to Configure mode.
(config)#commit	Commit the candidate configuration to the running configuration

OSPF configuration

(config)#router ospf 100	Enter into router OSPF mode
(config-router)#ospf router-id 11.11.11.11	Configure router-ID as 11.11.11.11 (lo IP address)
(config-router)#network 11.11.11.11/32 area 0.0.0.0	Add 11.11.11.11 (lo IP address) network into area 0

(config-router)#network 10.10.10.0/24 area 0.0.0.0	Add 10.10.10.0 (VTEP1) network into area 0
(config-router)#network 30.30.30.0/24 area 0.0.0.0	Add 30.30.30.0 (VTEP2) network into area 0
(config-router)#network 50.50.50.0/24 area 0.0.0.0	Add 50.50.50.0 (VTEP3) network into area 0
(config-router)#bfd all-interfaces	Enabling BFD on all OSPF interface for fast convergence
(config-router)#exit	Exit Interface mode and return to Configure mode.
(config)#commit	Commit the candidate configuration to the running configuration

Spine 2

Spine node where all VTEPs are connected

Generic configuration

#configure terminal	Enter Configure mode.
(config)#qos enable	Enabling QoS
(config)#commit	Commit the candidate configuration to the running configuration

Interface and loopback configuration

(config)#interface lo	Enter Interface mode for lo
(config-if)#ip address 22.22.22.22/32 secondary	Configure loopback IP address as 22.22.22.22 for Spine2
(config-if)#exit	Exit Interface mode and return to Configure mode.
(config)#interface xe5	Enter Interface mode for xe5
(config-if)#ip address 20.20.20.2/24	Configure IP address as 20.20.20.2 on network side of VTEP1
(config-if)#exit	Exit Interface mode and return to Configure mode.
(config)#interface ce0	Enter Interface mode for ce0
(config-if)#ip address 40.40.40.2/24	Configure IP address as 40.40.40.2 on network side of VTEP2
(config-if)#exit	Exit Interface mode and return to Configure mode.
(config)#interface xe19	Enter Interface mode for xe19
(config-if)#ip address 60.60.60.2/24	Configure IP address as 60.60.60.2 on network side of VTEP3
(config-if)#exit	Exit Interface mode and return to Configure mode.
(config)#commit	Commit the candidate configuration to the running configuration

OSPF configuration

(config)#router ospf 100	Enter into router OSPF mode
(config-router)#ospf router-id 22.22.22.22	Configure router-id as 11.11.11.11 (lo IP address)
(config-router)#network 22.22.22.22/32 area 0.0.0.0	Add 22.22.22.22 (lo IP address) network into area 0
(config-router)#network 20.20.20.0/24 area 0.0.0.0	Add 20.20.20.0 (VTEP1) network into area 0
(config-router)#network 40.40.40.0/24 area 0.0.0.0	Add 40.40.40.0 (VTEP2) network into area 0
(config-router)#network 60.60.60.0/24 area 0.0.0.0	Add 60.60.60.0 (VTEP3) network into area 0
(config-router)#bfd all-interfaces	Enabling BFD on all OSPF interface for fast convergence
(config-router)#exit	Exit Interface mode and return to Configure mode.
(config)#commit	Commit the candidate configuration to the running configuration

Validation

VTEP1

```
VTEP1#show nvo vxlan
```

```
VxLAN Information
```

```
=====
Codes: NW - Network Port
       AC - Access Port
       (u) - Untagged
```

VNID	VNI-Name	VNI-Type	Type	Interface	ESI	VLAN	DF-Status	Src-Addr	Dst-Addr
10	VNI-RED	L2	NW	----	----	----	----	1.1.1.1	3.3.3.3
10	VNI-RED	L2	NW	----	----	----	----	1.1.1.1	2.2.2.2
10	VNI-RED	--	AC	po1	00:00:00:00:00:11:11:00:00:00	1001	NON-DF	----	----
10	VNI-RED	--	AC	po1	00:00:00:00:00:11:11:00:00:00	1002	DF	----	----
20	VNI-BLUE	L2	NW	----	----	----	----	1.1.1.1	3.3.3.3
20	VNI-BLUE	L2	NW	----	----	----	----	1.1.1.1	2.2.2.2
20	VNI-BLUE	--	AC	po1	00:00:00:00:00:11:11:00:00:00	3001	NON-DF	----	----

```
Total number of entries are 7
```

```
VTEP1#show nvo vxlan access-if brief
```

Interface	Vlan	Inner vlan	Ifindex	Vnid	Admin status	Link status
po1	1002	---	500001	10	up	up
po1	1001	---	500000	10	up	up
po1	3001	---	500002	20	up	up

```
Total number of entries are 3
```

```
VTEP1#show bgp l2vpn evpn summary
```

```
BGP router identifier 1.1.1.1, local AS number 500
```

```
BGP table version is 6
```

```
1 BGP AS-PATH entries
```

```
0 BGP community entries
```

Neighbor PREFIX-ROUTE	V	AS	MsgRcv	MsgSen	TblVer	InQ	OutQ	Up/Down	State/PfxRcd	AD	MACIP	MCAST	ESI	
2.2.2.2	4	500	161	163	5	0	0	01:05:15	6	3	0	2	1	0
3.3.3.3	4	500	157	161	5	0	0	01:05:07	2	0	0	2	0	0

Total number of neighbors 2

Total number of Established sessions 2

VTEP1#show nvo vxlan tunnel
VxLAN Network tunnel Entries

Source	Destination	Status	Up/Down	Update
1.1.1.1	3.3.3.3	Installed	00:31:11	00:31:11
1.1.1.1	2.2.2.2	Installed	01:05:25	00:31:11

Total number of entries are 2

VTEP1#show bgp l2vpn evpn multihoming es-route

RD[1.1.1.1:1] VRF[evpn-gvrf-1]:

ESI	PE IP-Address	Nexthop IP	Encap
00:00:00:00:00:11:11:00:00:00	1.1.1.1	1.1.1.1	VxLAN
00:00:00:00:00:11:11:00:00:00	2.2.2.2	2.2.2.2	VxLAN

RD[2.2.2.2:1]

ESI	PE IP-Address	Nexthop IP	Encap
00:00:00:00:00:11:11:00:00:00	2.2.2.2	2.2.2.2	VxLAN

VTEP1#show bgp l2vpn evpn multihoming ethernet-ad-per-es

RD[1.1.1.1:1] VRF[evpn-gvrf-1]:

ESI	Eth-Tag	VNID/LABEL	Nexthop IP	Encap
00:00:00:00:00:11:11:00:00:00	4294967295	0	1.1.1.1	VxLAN

RD[1.1.1.1:11] VRF[VRF1]:

ESI	Eth-Tag	VNID/LABEL	Nexthop IP	Encap
00:00:00:00:00:11:11:00:00:00	4294967295	0	2.2.2.2	VxLAN

RD[1.1.1.1:21] VRF[VRF2]:

ESI	Eth-Tag	VNID/LABEL	Nexthop IP	Encap
00:00:00:00:00:11:11:00:00:00	4294967295	0	2.2.2.2	VxLAN

RD[2.2.2.2:1]

ESI	Eth-Tag	VNID/LABEL	Nexthop IP	Encap
00:00:00:00:00:11:11:00:00:00	4294967295	0	2.2.2.2	VxLAN

VTEP1#show bgp l2vpn evpn multihoming ethernet-ad-per-evi

RD[1.1.1.1:11] VRF[VRF1]:

ESI	Eth-Tag	VNID/LABEL	Nexthop IP	Encap
00:00:00:00:00:11:11:00:00:00	10	10	2.2.2.2	VxLAN
00:00:00:00:00:11:11:00:00:00	10	10	1.1.1.1	VxLAN

```
RD[1.1.1.1:21] VRF[VRF2]:
ESI                Eth-Tag    VNID/LABEL    Nexthop IP    Encap
00:00:00:00:00:11:11:00:00:00  20          20          2.2.2.2      VxLAN
00:00:00:00:00:11:11:00:00:00  20          20          1.1.1.1      VxLAN
```

```
RD[2.2.2.2:11]
ESI                Eth-Tag    VNID/LABEL    Nexthop IP    Encap
00:00:00:00:00:11:11:00:00:00  10          10          2.2.2.2      VxLAN
```

```
RD[2.2.2.2:21]
ESI                Eth-Tag    VNID/LABEL    Nexthop IP    Encap
00:00:00:00:00:11:11:00:00:00  20          20          2.2.2.2      VxLAN
```

```
VTEP1#show bgp l2vpn evpn
BGP table version is 6, local router ID is 1.1.1.1
Status codes: s suppressed, d damped, h history, * valid, > best, i - internal,
               l - labeled, S Stale
Origin codes: i - IGP, e - EGP, ? - incomplete
```

```
[EVPN route type]:[ESI]:[VNID]:[relevent route informantion]
1 - Ethernet Auto-discovery Route
2 - MAC/IP Route
3 - Inclusive Multicast Route
4 - Ethernet Segment Route
5 - Prefix Route
```

Network	Next Hop	Metric	LocPrf	Weight	Path	Peer	Encap
RD[1.1.1.1:1] VRF[evpn-gvrf-1]:							
*> [1]:[00:00:00:00:00:11:11:00:00:00]:[4294967295]:[0]	1.1.1.1	0	100	32768	i	-----	VxLAN
*> [4]:[00:00:00:00:00:11:11:00:00:00]:[32,1.1.1.1]	1.1.1.1	0	100	32768	i	-----	VxLAN
* i [4]:[00:00:00:00:00:11:11:00:00:00]:[32,2.2.2.2]	2.2.2.2	0	100	0	i	2.2.2.2	VxLAN
RD[1.1.1.1:11] VRF[VRF1]:							
* i [1]:[00:00:00:00:00:11:11:00:00:00]:[10]:[10]	2.2.2.2	0	100	0	i	2.2.2.2	VxLAN
*> [1]:[00:00:00:00:00:11:11:00:00:00]:[4294967295]:[0]	1.1.1.1	0	100	32768	i	-----	VxLAN
*> [3]:[10]:[32,1.1.1.1]	2.2.2.2	0	100	0	i	2.2.2.2	VxLAN
* i [3]:[10]:[32,1.1.1.1]	1.1.1.1	0	100	32768	i	-----	VxLAN
* i [3]:[10]:[32,2.2.2.2]	2.2.2.2	0	100	0	i	2.2.2.2	VxLAN
* i [3]:[10]:[32,3.3.3.3]	3.3.3.3	0	100	0	i	3.3.3.3	VxLAN
RD[1.1.1.1:21] VRF[VRF2]:							
* i [1]:[00:00:00:00:00:11:11:00:00:00]:[20]:[20]	2.2.2.2	0	100	0	i	2.2.2.2	VxLAN
*> [1]:[00:00:00:00:00:11:11:00:00:00]:[4294967295]:[0]	1.1.1.1	0	100	32768	i	-----	VxLAN
*> [3]:[20]:[32,1.1.1.1]	2.2.2.2	0	100	0	i	2.2.2.2	VxLAN
*> [3]:[20]:[32,1.1.1.1]	1.1.1.1	0	100	32768	i	-----	VxLAN

```

* i [3]:[20]:[32,2.2.2.2]
      2.2.2.2          0          100          0          i 2.2.2.2          VxLAN
* i [3]:[20]:[32,3.3.3.3]
      3.3.3.3          0          100          0          i 3.3.3.3          VxLAN

RD[2.2.2.2:1]
*>i [1]:[00:00:00:00:00:11:11:00:00:00]:[4294967295]:[0]
      2.2.2.2          0          100          0          i 2.2.2.2          VxLAN
*>i [4]:[00:00:00:00:00:11:11:00:00:00]:[32,2.2.2.2]
      2.2.2.2          0          100          0          i 2.2.2.2          VxLAN

RD[2.2.2.2:11]
*>i [1]:[00:00:00:00:00:11:11:00:00:00]:[10]:[10]
      2.2.2.2          0          100          0          i 2.2.2.2          VxLAN
*>i [3]:[10]:[32,2.2.2.2]
      2.2.2.2          0          100          0          i 2.2.2.2          VxLAN

RD[2.2.2.2:21]
*>i [1]:[00:00:00:00:00:11:11:00:00:00]:[20]:[20]
      2.2.2.2          0          100          0          i 2.2.2.2          VxLAN
*>i [3]:[20]:[32,2.2.2.2]
      2.2.2.2          0          100          0          i 2.2.2.2          VxLAN

RD[3.3.3.3:11]
*>i [3]:[10]:[32,3.3.3.3]
      3.3.3.3          0          100          0          i 3.3.3.3          VxLAN

RD[3.3.3.3:21]
*>i [3]:[20]:[32,3.3.3.3]
      3.3.3.3          0          100          0          i 3.3.3.3          VxLAN

```

Total number of prefixes 21

VTEP2

VTEP2#show nvo vxlan

VxLAN Information

=====

Codes: NW - Network Port
AC - Access Port
(u) - Untagged

VNID	VNI-Name	VNI-Type	Type	Interface	ESI	VLAN	DF-Status	Src-Addr	Dst-Addr
10	VNI-RED	L2	NW	----	----	----	----	2.2.2.2	1.1.1.1
10	VNI-RED	L2	NW	----	----	----	----	2.2.2.2	3.3.3.3
10	VNI-RED	--	AC	xe32	---	Single Homed Port	---	----	----
10	VNI-RED	--	AC	po1	00:00:00:00:00:11:11:00:00:00	1001 DF	----	----	
10	VNI-RED	--	AC	po1	00:00:00:00:00:11:11:00:00:00	1002 NON-DF	----	----	
20	VNI-BLUE	L2	NW	----	----	----	----	2.2.2.2	1.1.1.1
20	VNI-BLUE	L2	NW	----	----	----	----	2.2.2.2	3.3.3.3
20	VNI-BLUE	--	AC	po1	00:00:00:00:00:11:11:00:00:00	3001 DF	----	----	

Total number of entries are 8

VTEP2#show nvo vxlan access-if

% Incomplete command.

VTEP2#show nvo vxlan access-if brief

Inner Admin Link

Interface	Vlan	vlan	Ifindex	Vnid	status	status
xe32	---	---	500004	10	up	up
po1	1002	---	500001	10	up	up
po1	1001	---	500000	10	up	up
po1	3001	---	500002	20	up	up

Total number of entries are 4

```
VTEP2#show bgp l2vpn evpn summary
BGP router identifier 2.2.2.2, local AS number 500
BGP table version is 4
1 BGP AS-PATH entries
0 BGP community entries
```

Neighbor PREFIX-ROUTE	V	AS	MsgRcv	MsgSen	TblVer	InQ	OutQ	Up/Down	State/PfxRcd	AD	MACIP	MCAST	ESI
1.1.1.1	4	500	172	171	4	0	0	01:09:28	6	3	0	2	1
3.3.3.3	4	500	165	173	4	0	0	01:09:29	2	0	0	2	0

Total number of neighbors 2

Total number of Established sessions 2

```
VTEP2#show nvo vxlan tunnel
VxLAN Network tunnel Entries
```

Source	Destination	Status	Up/Down	Update
2.2.2.2	1.1.1.1	Installed	01:09:38	00:35:24
2.2.2.2	3.3.3.3	Installed	01:09:39	01:09:39

Total number of entries are 2

```
VTEP2#show bgp l2vpn evpn multihoming es-route
```

```
RD[1.1.1.1:1]
```

ESI	PE IP-Address	Nexthop IP	Encap
00:00:00:00:00:11:11:00:00:00	1.1.1.1	1.1.1.1	VxLAN

```
RD[2.2.2.2:1] VRF[evpn-gvrf-1]:
```

ESI	PE IP-Address	Nexthop IP	Encap
00:00:00:00:00:11:11:00:00:00	1.1.1.1	1.1.1.1	VxLAN
00:00:00:00:00:11:11:00:00:00	2.2.2.2	2.2.2.2	VxLAN

```
VTEP2#show bgp l2vpn evpn multihoming ethernet-ad-per-es
```

```
RD[1.1.1.1:1]
```

ESI	Eth-Tag	VNID/LABEL	Nexthop IP	Encap
00:00:00:00:00:11:11:00:00:00	4294967295	0	1.1.1.1	VxLAN

```
RD[2.2.2.2:1] VRF[evpn-gvrf-1]:
```

ESI	Eth-Tag	VNID/LABEL	Nexthop IP	Encap
00:00:00:00:00:11:11:00:00:00	4294967295	0	2.2.2.2	VxLAN

```
RD[2.2.2.2:11] VRF[VRF1]:
```

ESI	Eth-Tag	VNID/LABEL	Nexthop IP	Encap
00:00:00:00:00:11:11:00:00:00	4294967295	0	1.1.1.1	VxLAN

```
RD[2.2.2.2:21] VRF[VRF2]:
```

ESI	Eth-Tag	VNID/LABEL	Nexthop IP	Encap

```
00:00:00:00:00:11:11:00:00:00 4294967295 0 1.1.1.1 VxLAN
```

```
VTEP2#show bgp l2vpn evpn multihoming ethernet-ad-per-evi
```

```
RD[1.1.1.1:11]
```

ESI	Eth-Tag	VNID/LABEL	Nexthop IP	Encap
00:00:00:00:00:11:11:00:00:00	10	10	1.1.1.1	VxLAN

```
RD[1.1.1.1:21]
```

ESI	Eth-Tag	VNID/LABEL	Nexthop IP	Encap
00:00:00:00:00:11:11:00:00:00	20	20	1.1.1.1	VxLAN

```
RD[2.2.2.2:11] VRF[VRF1]:
```

ESI	Eth-Tag	VNID/LABEL	Nexthop IP	Encap
00:00:00:00:00:11:11:00:00:00	10	10	2.2.2.2	VxLAN
00:00:00:00:00:11:11:00:00:00	10	10	1.1.1.1	VxLAN

```
RD[2.2.2.2:21] VRF[VRF2]:
```

ESI	Eth-Tag	VNID/LABEL	Nexthop IP	Encap
00:00:00:00:00:11:11:00:00:00	20	20	2.2.2.2	VxLAN
00:00:00:00:00:11:11:00:00:00	20	20	1.1.1.1	VxLAN

```
VTEP2# show bgp l2vpn evpn
```

```
BGP table version is 4, local router ID is 2.2.2.2
```

```
Status codes: s suppressed, d damped, h history, * valid, > best, i - internal,  
l - labeled, S Stale
```

```
Origin codes: i - IGP, e - EGP, ? - incomplete
```

```
[EVPN route type]:[ESI]:[VNID]:[relevent route informantion]
```

```
1 - Ethernet Auto-discovery Route
```

```
2 - MAC/IP Route
```

```
3 - Inclusive Multicast Route
```

```
4 - Ethernet Segment Route
```

```
5 - Prefix Route
```

Network	Next Hop	Metric	LocPrf	Weight	Path	Peer	Encap
RD[1.1.1.1:1]							
*>i [1]:[00:00:00:00:00:11:11:00:00:00]:[4294967295]:[0]	1.1.1.1	0	100	0	i	1.1.1.1	VxLAN
*>i [4]:[00:00:00:00:00:11:11:00:00:00]:[32,1.1.1.1]	1.1.1.1	0	100	0	i	1.1.1.1	VxLAN
RD[1.1.1.1:11]							
*>i [1]:[00:00:00:00:00:11:11:00:00:00]:[10]:[10]	1.1.1.1	0	100	0	i	1.1.1.1	VxLAN
*>i [3]:[10]:[32,1.1.1.1]	1.1.1.1	0	100	0	i	1.1.1.1	VxLAN
RD[1.1.1.1:21]							
*>i [1]:[00:00:00:00:00:11:11:00:00:00]:[20]:[20]	1.1.1.1	0	100	0	i	1.1.1.1	VxLAN
*>i [3]:[20]:[32,1.1.1.1]	1.1.1.1	0	100	0	i	1.1.1.1	VxLAN

```
RD[2.2.2.2:1] VRF[evpn-gvrf-1]:
```

```

*> [1]:[00:00:00:00:00:11:11:00:00:00]:[4294967295]:[0]
      2.2.2.2          0          100          32768      i      -----      VxLAN
* i [4]:[00:00:00:00:00:11:11:00:00:00]:[32,1.1.1.1]
      1.1.1.1          0          100          0          i      1.1.1.1      VxLAN
*> [4]:[00:00:00:00:00:11:11:00:00:00]:[32,2.2.2.2]
      2.2.2.2          0          100          32768      i      -----      VxLAN

RD[2.2.2.2:11] VRF[VRF1]:
*> [1]:[00:00:00:00:00:11:11:00:00:00]:[10]:[10]
      2.2.2.2          0          100          32768      i      -----      VxLAN
* i [1]:[00:00:00:00:00:11:11:00:00:00]:[4294967295]:[0]
      1.1.1.1          0          100          0          i      1.1.1.1      VxLAN
* i [3]:[10]:[32,1.1.1.1]
      1.1.1.1          0          100          0          i      1.1.1.1      VxLAN
*> [3]:[10]:[32,2.2.2.2]
      2.2.2.2          0          100          32768      i      -----      VxLAN
* i [3]:[10]:[32,3.3.3.3]
      3.3.3.3          0          100          0          i      3.3.3.3      VxLAN

RD[2.2.2.2:21] VRF[VRF2]:
*> [1]:[00:00:00:00:00:11:11:00:00:00]:[20]:[20]
      2.2.2.2          0          100          32768      i      -----      VxLAN
* i [1]:[00:00:00:00:00:11:11:00:00:00]:[4294967295]:[0]
      1.1.1.1          0          100          0          i      1.1.1.1      VxLAN
* i [3]:[20]:[32,1.1.1.1]
      1.1.1.1          0          100          0          i      1.1.1.1      VxLAN
*> [3]:[20]:[32,2.2.2.2]
      2.2.2.2          0          100          32768      i      -----      VxLAN
* i [3]:[20]:[32,3.3.3.3]
      3.3.3.3          0          100          0          i      3.3.3.3      VxLAN

RD[3.3.3.3:11]
*>i [3]:[10]:[32,3.3.3.3]
      3.3.3.3          0          100          0          i      3.3.3.3      VxLAN

RD[3.3.3.3:21]
*>i [3]:[20]:[32,3.3.3.3]
      3.3.3.3          0          100          0          i      3.3.3.3      VxLAN

```

Total number of prefixes 21

VTEP3

VTEP3# show nvo vxlan

VxLAN Information

=====

Codes: NW - Network Port
AC - Access Port
(u) - Untagged

VNID	VNI-Name	VNI-Type	Type	Interface	ESI	VLAN	DF-Status	Src-Addr	Dst-Addr
10	VNI-RED	L2	NW	----	----	----	----	3.3.3.3	2.2.2.2
10	VNI-RED	L2	NW	----	----	----	----	3.3.3.3	1.1.1.1
10	VNI-RED	--	AC	xe48	--- Single Homed Port ---	1001	----	----	----
10	VNI-RED	--	AC	xe48	--- Single Homed Port ---	1002	----	----	----
20	VNI-BLUE	L2	NW	----	----	----	----	3.3.3.3	2.2.2.2
20	VNI-BLUE	L2	NW	----	----	----	----	3.3.3.3	1.1.1.1
20	VNI-BLUE	--	AC	xe48	--- Single Homed Port ---	3001	----	----	----

Total number of entries are 7

```
VTEP3#show nvo vxlan access-if brief
```

Interface	Vlan	Inner vlan	Ifindex	Vnid	Admin status	Link status
xe48	1002	---	500001	10	up	up
xe48	1001	---	500000	10	up	up
xe48	3001	---	500002	20	up	up

Total number of entries are 3

```
VTEP3#show bgp l2vpn evpn summary
BGP router identifier 3.3.3.3, local AS number 500
BGP table version is 4
1 BGP AS-PATH entries
0 BGP community entries
```

Neighbor PREFIX-ROUTE	V	AS	MsgRcv	MsgSen	TblVer	InQ	OutQ	Up/Down	State/PfxRcd	AD	MACIP	MCAST	ESI	
1.1.1.1	4	500	177	173	3	0	0	01:11:49	6	3	0	2	1	0
2.2.2.2	4	500	177	171	2	0	0	01:11:59	6	3	0	2	1	0

Total number of neighbors 2

Total number of Established sessions 2

```
VTEP3#show nvo vxlan tunnel
```

VxLAN Network tunnel Entries

Source	Destination	Status	Up/Down	Update
3.3.3.3	2.2.2.2	Installed	01:12:10	01:12:10
3.3.3.3	1.1.1.1	Installed	01:12:00	01:12:00

Total number of entries are 2

```
VTEP3#show bgp l2vpn evpn multihoming es-route
```

```
RD[1.1.1.1:1]
ESI
00:00:00:00:00:11:11:00:00:00 1.1.1.1 1.1.1.1 VxLAN
```

```
RD[2.2.2.2:1]
ESI
00:00:00:00:00:11:11:00:00:00 2.2.2.2 2.2.2.2 VxLAN
```

```
VTEP3#show bgp l2vpn evpn multihoming ethernet-ad-per-es
```

```
RD[1.1.1.1:1]
ESI
00:00:00:00:00:11:11:00:00:00 4294967295 0 1.1.1.1 VxLAN
```

```
RD[2.2.2.2:1]
ESI
00:00:00:00:00:11:11:00:00:00 4294967295 0 2.2.2.2 VxLAN
```

```
RD[3.3.3.3:11] VRF[VRF1]:
ESI                Eth-Tag    VNID/LABEL    Nexthop IP    Encap
00:00:00:00:00:11:11:00:00:00 4294967295 0              2.2.2.2       VxLAN
00:00:00:00:00:11:11:00:00:00 4294967295 0              1.1.1.1       VxLAN
```

```
RD[3.3.3.3:21] VRF[VRF2]:
ESI                Eth-Tag    VNID/LABEL    Nexthop IP    Encap
00:00:00:00:00:11:11:00:00:00 4294967295 0              2.2.2.2       VxLAN
00:00:00:00:00:11:11:00:00:00 4294967295 0              1.1.1.1       VxLAN
```

VTEP3#show bgp l2vpn evpn multihoming ethernet-ad-per-evi

```
RD[1.1.1.1:11]
ESI                Eth-Tag    VNID/LABEL    Nexthop IP    Encap
00:00:00:00:00:11:11:00:00:00 10         10            1.1.1.1       VxLAN
```

```
RD[1.1.1.1:21]
ESI                Eth-Tag    VNID/LABEL    Nexthop IP    Encap
00:00:00:00:00:11:11:00:00:00 20         20            1.1.1.1       VxLAN
```

```
RD[2.2.2.2:11]
ESI                Eth-Tag    VNID/LABEL    Nexthop IP    Encap
00:00:00:00:00:11:11:00:00:00 10         10            2.2.2.2       VxLAN
```

```
RD[2.2.2.2:21]
ESI                Eth-Tag    VNID/LABEL    Nexthop IP    Encap
00:00:00:00:00:11:11:00:00:00 20         20            2.2.2.2       VxLAN
```

```
RD[3.3.3.3:11] VRF[VRF1]:
ESI                Eth-Tag    VNID/LABEL    Nexthop IP    Encap
00:00:00:00:00:11:11:00:00:00 10         10            2.2.2.2       VxLAN
00:00:00:00:00:11:11:00:00:00 10         10            1.1.1.1       VxLAN
```

```
RD[3.3.3.3:21] VRF[VRF2]:
ESI                Eth-Tag    VNID/LABEL    Nexthop IP    Encap
00:00:00:00:00:11:11:00:00:00 20         20            2.2.2.2       VxLAN
00:00:00:00:00:11:11:00:00:00 20         20            1.1.1.1       VxLAN
```

VTEP3#show bgp l2vpn evpn

BGP table version is 4, local router ID is 3.3.3.3

Status codes: s suppressed, d damped, h history, * valid, > best, i - internal,
l - labeled, S Stale

Origin codes: i - IGP, e - EGP, ? - incomplete

[EVPN route type]:[ESI]:[VNID]:[relevent route informantion]

- 1 - Ethernet Auto-discovery Route
- 2 - MAC/IP Route
- 3 - Inclusive Multicast Route
- 4 - Ethernet Segment Route
- 5 - Prefix Route

Network	Next Hop	Metric	LocPrf	Weight	Path	Peer	Encap
RD[1.1.1.1:1]							
*>i [1]:[00:00:00:00:00:11:11:00:00:00]:[4294967295]:[0]	1.1.1.1	0	100	0	i	1.1.1.1	VxLAN
*>i [4]:[00:00:00:00:00:11:11:00:00:00]:[32,1.1.1.1]	1.1.1.1	0	100	0	i	1.1.1.1	VxLAN
RD[1.1.1.1:11]							
*>i [1]:[00:00:00:00:00:11:11:00:00:00]:[10]:[10]	1.1.1.1	0	100	0	i	1.1.1.1	VxLAN
*>i [3]:[10]:[32,1.1.1.1]	1.1.1.1	0	100	0	i	1.1.1.1	VxLAN
RD[1.1.1.1:21]							
*>i [1]:[00:00:00:00:00:11:11:00:00:00]:[20]:[20]	1.1.1.1	0	100	0	i	1.1.1.1	VxLAN
*>i [3]:[20]:[32,1.1.1.1]	1.1.1.1	0	100	0	i	1.1.1.1	VxLAN
RD[2.2.2.2:1]							
*>i [1]:[00:00:00:00:00:11:11:00:00:00]:[4294967295]:[0]	2.2.2.2	0	100	0	i	2.2.2.2	VxLAN
*>i [4]:[00:00:00:00:00:11:11:00:00:00]:[32,2.2.2.2]	2.2.2.2	0	100	0	i	2.2.2.2	VxLAN
RD[2.2.2.2:11]							
*>i [1]:[00:00:00:00:00:11:11:00:00:00]:[10]:[10]	2.2.2.2	0	100	0	i	2.2.2.2	VxLAN
*>i [3]:[10]:[32,2.2.2.2]	2.2.2.2	0	100	0	i	2.2.2.2	VxLAN
RD[2.2.2.2:21]							
*>i [1]:[00:00:00:00:00:11:11:00:00:00]:[20]:[20]	2.2.2.2	0	100	0	i	2.2.2.2	VxLAN
*>i [3]:[20]:[32,2.2.2.2]	2.2.2.2	0	100	0	i	2.2.2.2	VxLAN
RD[3.3.3.3:11] VRF[VRF1]:							
* i [1]:[00:00:00:00:00:11:11:00:00:00]:[10]:[10]	2.2.2.2	0	100	0	i	2.2.2.2	VxLAN
* i	1.1.1.1	0	100	0	i	1.1.1.1	VxLAN
* i [1]:[00:00:00:00:00:11:11:00:00:00]:[4294967295]:[0]	2.2.2.2	0	100	0	i	2.2.2.2	VxLAN
* i	1.1.1.1	0	100	0	i	1.1.1.1	VxLAN
* i [3]:[10]:[32,1.1.1.1]	1.1.1.1	0	100	0	i	1.1.1.1	VxLAN
* i [3]:[10]:[32,2.2.2.2]	2.2.2.2	0	100	0	i	2.2.2.2	VxLAN
*> [3]:[10]:[32,3.3.3.3]	3.3.3.3	0	100	32768	i	-----	VxLAN
RD[3.3.3.3:21] VRF[VRF2]:							
* i [1]:[00:00:00:00:00:11:11:00:00:00]:[20]:[20]	2.2.2.2	0	100	0	i	2.2.2.2	VxLAN
* i	1.1.1.1	0	100	0	i	1.1.1.1	VxLAN
* i [1]:[00:00:00:00:00:11:11:00:00:00]:[4294967295]:[0]	2.2.2.2	0	100	0	i	2.2.2.2	VxLAN
* i	1.1.1.1	0	100	0	i	1.1.1.1	VxLAN

```

* i [3]:[20]:[32,1.1.1.1]
      1.1.1.1          0      100      0      i 1.1.1.1      VxLAN
* i [3]:[20]:[32,2.2.2.2]
      2.2.2.2          0      100      0      i 2.2.2.2      VxLAN
*>  [3]:[20]:[32,3.3.3.3]
      3.3.3.3          0      100      32768  i -----      VxLAN

```

Total number of prefixes 22

Static MAC-IP Advertise through Single Home and Multihomed VTEPs

Advertise static MAC IPv4 from MH1 and SH3.

MH1-VTEPs: VTEP1 & VTEP2- same MAC should be configured on both VTEPs under po access-port, configs should be symmetric between MH VTEPs

SH3-VTEP: VTEP3

VTEP1 (MH1)

#configure terminal	Enter Configure mode.
(config)# nvo vxlan access-if port-vlan po1 1001	Enter into VxLAN MH po1 access-port with VLAN 1001
(config-nvo-acc-if)#mac 0000.1111.1001 ip 11.11.10.1	Configure static MAC IP
(config-nvo-acc-if)#exit	Exit from VxLAN access-port config mode
(config)#commit	Commit the candidate configuration to the running configuration
(config)#exit	Exit from configuration mode

VTEP2 (MH1)

#configure terminal	Enter Configure mode.
(config)#nvo vxlan access-if port-vlan po1 1001	Enter into VxLAN MH po1 access-port with vlan 1001
(config-nvo-acc-if)# mac 0000.1111.1001 ip 11.11.10.1	Configure static MAC IP
(config-nvo-acc-if)#exit	Exit from VxLAN access-port config mode
(config)#commit	Commit the candidate configuration to the running configuration
(config)#exit	Exit from configuration mode

VTEP3 (SH)

#configure terminal	Enter Configure mode.
(config)# nvo vxlan access-if port-vlan xe48 1001	Enter into single-homed access-port - xe48 with VLAN 1001
(config-nvo-acc-if)#mac 0000.3333.1001 ip 11.11.10.2	Configure static MAC IP
(config-nvo-acc-if)#exit	Exit from VxLAN access-port config mode
(config)#commit	Commit the candidate configuration to the running configuration
(config)#exit	Exit from configuration mode

Validation

Verify MAC-table in MH VTEPs and Single Home VTEP, MAC will be advertised through ESI value which is advertised from VTEP1 and VTEP2 and VTEP IP from SH VTEP VTEP3.

Verify ARP-cache table in all VTEPs, VTEP1 and VTEP2 will learn VTEP3 IP.

Any ARP request comes for 11.11.10.2, VTEP1/VTEP2 will do proxy-ARP.

VTEP1

VTEP1#show nvo vxlan mac-table

```

=====
                                  VxLAN MAC Entries
=====
VNID      Interface VlanId Inner-VlanId Mac-Addr      VTEP-IP/ESI              Type      Status      AccessPortDesc
-----
10        po1          1001    ----          0000.1111.1001 00:00:00:00:00:11:11:00:00:00 Static Local  -----
10        ----          ----    ----          0000.3333.1001 3.3.3.3                  Static Remote -----

```

Total number of entries are : 2

VTEP1#show nvo vxlan arp-cache

VxLAN ARP-CACHE Information

```

=====
VNID      Ip-Addr      Mac-Addr      Type      Age-Out      Retries-Left
-----
10        11.11.10.1   0000.1111.1001 Static Local  ----
10        11.11.10.2   0000.3333.1001 Static Remote ----

```

Total number of entries are 2

VTEP2

VTEP2#show nvo vxlan mac-table

```

=====
                                  VxLAN MAC Entries
=====
VNID      Interface VlanId Inner-VlanId Mac-Addr      VTEP-IP/ESI              Type      Status      AccessPortDesc
-----
10        po1          1001    ----          0000.1111.1001 00:00:00:00:00:11:11:00:00:00 Static Local  -----
10        ----          ----    ----          0000.3333.1001 3.3.3.3                  Static Remote -----

```

Total number of entries are : 2

```
VTEP2#show nvo vxlan arp-cache
```

```
VxLAN ARP-CACHE Information
```

```
=====
```

VNID	Ip-Addr	Mac-Addr	Type	Age-Out	Retries-Left
------	---------	----------	------	---------	--------------

10	11.11.10.1	0000.1111.1001	Static Local	----	
----	------------	----------------	--------------	------	--

10	11.11.10.2	0000.3333.1001	Static Remote	----	
----	------------	----------------	---------------	------	--

```
Total number of entries are 2
```

VTEP3

```
VTEP3#show nvo vxlan mac-table
```

```
=====
```

VxLAN MAC Entries

```
=====
```

VNID	Interface	VlanId	Inner-VlanId	Mac-Addr	VTEP-IP/ESI	Type	Status	AccessPortDesc
------	-----------	--------	--------------	----------	-------------	------	--------	----------------

10	----	1001	----	0000.1111.1001	00:00:00:00:00:11:11:00:00:00	Static Remote	-----	-----
----	------	------	------	----------------	-------------------------------	---------------	-------	-------

10	xe48	1001	----	0000.3333.1001	3.3.3.3	Static Local	-----	-----
----	------	------	------	----------------	---------	--------------	-------	-------

```
Total number of entries are : 2
```

```
VTEP3#show nvo vxlan arp-cache
```

```
VxLAN ARP-CACHE Information
```

```
=====
```

VNID	Ip-Addr	Mac-Addr	Type	Age-Out	Retries-Left
------	---------	----------	------	---------	--------------

10	11.11.10.1	0000.1111.1001	Static Remote	----	
----	------------	----------------	---------------	------	--

10	11.11.10.2	0000.3333.1001	Static Local	----	
----	------------	----------------	--------------	------	--

```
Total number of entries are 2
```

Dynamic MAC Advertise through Single Home and Multihomed VTEPs

Advertise 2 MAC's through CE1 connected IXIA, dynamic MAC entries and verify MAC-table in all VTEPs.

One MAC will be dynamic local in VTEP1 and same will be remote in VTEP2 and other be dynamic local in VTEP2 and same will be remote in VTEP1.

Both MAC's will be in remote in VTEP3.

VTEP1

```
VTEP1#show nvo vxlan mac-table
```

```
=====
```

VxLAN MAC Entries

```
=====
```

VNID	Interface	VlanId	Inner-VlanId	Mac-Addr	VTEP-IP/ESI	Type	Status	AccessPortDesc
------	-----------	--------	--------------	----------	-------------	------	--------	----------------

10	po1	1001	----	0000.1111.1002	00:00:00:00:00:11:11:00:00:00	Dynamic Local	-----	-----
----	-----	------	------	----------------	-------------------------------	---------------	-------	-------

10	----	1002	----	0000.1111.1003	00:00:00:00:00:11:11:00:00:00	Dynamic Remote	-----	-----
----	------	------	------	----------------	-------------------------------	----------------	-------	-------

```
Total number of entries are : 2
```

```
VTEP1#show nvo vxlan arp-cache
```

```
VxLAN ARP-CACHE Information
```

```

=====
VNID      Ip-Addr      Mac-Addr      Type      Age-Out      Retries-Left
-----
10        21.21.21.1   0000.1111.1002 Dynamic Local ----
10        31.1.31.1    0000.1111.1003 Dynamic Remote ----
Total number of entries are 2
    
```

VTEP2

VTEP2#show nvo vxlan mac-table

```

=====
                                  VxLAN MAC Entries
=====
VNID      Interface VlanId Inner-VlanId Mac-Addr      VTEP-IP/ESI      Type      Status      AccessPortDesc
-----
10        ----      1001      ----      0000.1111.1002 00:00:00:00:00:11:11:00:00:00 Dynamic Remote -----
10        po1       1002      ----      0000.1111.1003 00:00:00:00:00:11:11:00:00:00 Dynamic Local  -----
    
```

Total number of entries are : 2

VTEP2#show nvo vxla arp-cache

VxLAN ARP-CACHE Information

```

=====
VNID      Ip-Addr      Mac-Addr      Type      Age-Out      Retries-Left
-----
10        21.21.21.1   0000.1111.1002 Dynamic Remote ----
10        31.1.31.1    0000.1111.1003 Dynamic Local  ----
    
```

Total number of entries are 2

VTEP3

VTEP3#show nvo vxlan mac-table

```

=====
                                  VxLAN MAC Entries
=====
VNID      Interface VlanId Inner-VlanId Mac-Addr      VTEP-IP/ESI      Type      Status      AccessPortDesc
-----
10        ----      1001      ----      0000.1111.1002 00:00:00:00:00:11:11:00:00:00 Dynamic Remote -----
10        ----      1002      ----      0000.1111.1003 00:00:00:00:00:11:11:00:00:00 Dynamic Remote -----
    
```

Total number of entries are : 2

VTEP3#show nvo vxlan arp-cache

VxLAN ARP-CACHE Information

```

=====
VNID      Ip-Addr      Mac-Addr      Type      Age-Out      Retries-Left
-----
10        21.21.21.1   0000.1111.1002 Dynamic Remote ----
10        31.1.31.1    0000.1111.1003 Dynamic Remote ----
    
```

Total number of entries are 2

Note:

- When VTEP1 tunnel goes down, then traffic from VTEP3 will use VTEP2 for forwarding. But Traffic from Switch to VTEP1 will be lost in VTEP1 itself.

- When DUT is rebooted, access-if will be in hold down state until ESI hold timer value expiry. After ESI hold timer expiry, access-if port will be up and started learning.
- MAC Hold timer will not be applicable on ESI interface, because of mass-withdraw requirement.
- A CE can connect to maximum two nodes for multihoming, more than two nodes in a multihoming group is not supported.
- All configuration (shutdown, disable learning, disable arp/nd cache, disable arp/nd flood, map vnid, qos profiles, encapsulation) on a multihomed access port should be same on both VTEPs sharing the ESI for multihoming functionalities to work properly.
- Multiple ESI values are supported on same VTEP.

CHAPTER 7 VxLAN Quality of Service Configuration

This chapter contains the configurations for VxLAN Quality of Service (QoS).

Overview

VxLAN enables multiple tenants to operate in a data center. Each tenant is assigned a priority group to prioritize their traffic. Cloud carriers want to use quality of service to differentiate different applications.

Data center networks are being increasingly used by telecommunications operators as well as by enterprises. Currently these networks are organized as one large Layer 2 network in a single building. In some cases, such a network is extended geographically using Virtual Local Area Network (VLAN) technologies as an even larger Layer 2 network connecting the virtual machines (VM), each with its own MAC address.

Multiple tenants might want their own isolated network domain. In a data center hosting multiple tenants, each tenant may independently assign MAC addresses and VLAN IDs and this might lead to duplication.

Cloud carriers wish to categorize the traffic based on the application such as voice, video, etc. Based on the type of the application different traffic classes may be identified and different priority levels can be assigned to each. To do so, quality of service marking is needed in VxLAN.

This chapter shows how to mark packet headers with the VxLAN tunnel end point (VTEP) when the frames are introduced by the virtual machines. The (re)marking /setting of QoS field DSCP/TOS in the VxLAN IP header is done with the two modes which are set globally.

Two commands support L2 VxLAN QoS:

- `qos profile dscp-encap`: Use this command to create new profiles or to update "default" profiles for dscp-dscpEncap and Queue to DSCP value. This profile will be mapped to nvo vxlan tunnel at the egress direction of the VTEP. Default Qos profile dscp-encap would take preference than default qos profile queue-color-to dscp when no user-defined qos profile is configured on the nvo vxlan tunnel mode.
- `l2 queue dscp`: Use this command to configure or update user defined mapping for queue to dscp for egress L2 Traffic over VxLAN tunnel.

Topology

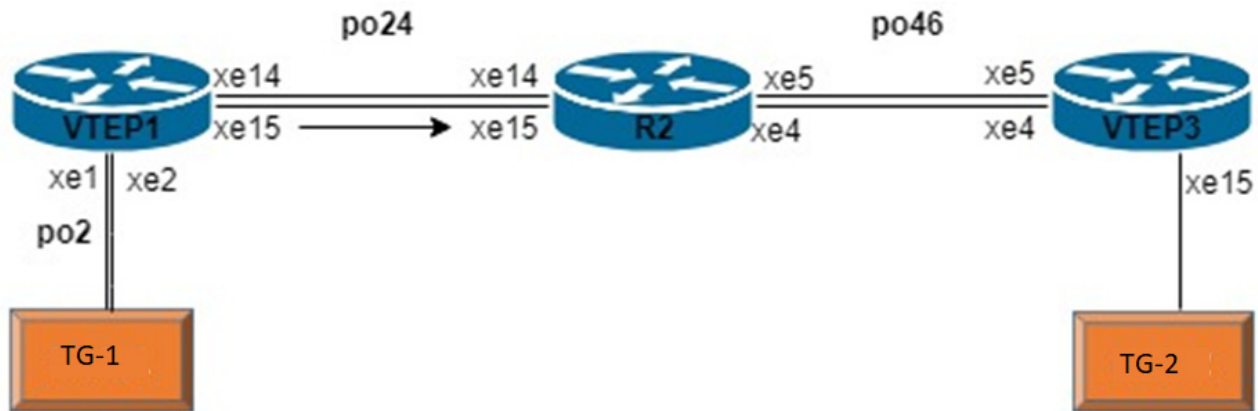

Figure 7-8: VxLAN QoS

COS-DSCP

RTR1/VTEP1

VTEP1#configure terminal	Enter Configure mode.
VTEP1(config)#mac vrf vrf1	Create mac routing/forwarding instance with vrf1 name and enter into vrf mode
VTEP1(config-vrf)#rd 1.1.1.1:11	Assign RD value
VTEP1(config-vrf)#route-target both 10.10.10.10:100	Assign route-target value for import/export
VTEP1(config-vrf)#exit	Exit form vrf mode
VTEP1(config)#hardware-profile filter vxlan enable	Enable hardware profile for vxlan
VTEP1(config)#qos enable	Enable qos
VTEP1(config)#qos profile cos-to-queue COS-QUE	Create qos profile for mapping traffic towards tunnel from access-if.
VTEP1(config-ingress-cos-map)#cos 2 queue 3	Configure particular COS value to the queue value for configured profile.
VTEP1(config-ingress-cos-map)#exit	Exit from qos profile config mode
VTEP1(config)#qos profile queue-color-to-dscp QUE-DSCP	Create qos profile for attaching in vxlan tunnel egress.
OR	
VTEP1(config)#qos profile dscp-encap DSCP-ENCAP	Either one of the qos profile CLI can be configured. Functionality of queue-color-to-dscp and dscp-encap qos profiles remains the same.

VTEP1(config-egress-dscp-map)#queue 3 dscp 16	Configure particular queue value to the dscp value for configured profile.
OR	
VTEP1(config-egress-dscp-encap-map)#12 queue 3 dscp 16	Either one of the qos profile CLI can be configured. Functionality of queue-color-to-dscp and dscp-encap qos profiles remains the same.
VTEP1(config-egress-dscp-encap-map)#exit	Exit from qos profile config mode
VTEP1(config)#interface po2	Create a port channel po2
VTEP1(config-if)#switchport	Configure port as switchport
VTEP1(config-if)#load-interval 30	Set load-interval
VTEP1(config-if)#interface po24	Create a port channel po24
VTEP1(config-if)#load-interval 30	Configure port as switchport
VTEP1(config-if)#ip address 24.1.1.1/30	Set load-interval
VTEP1(config-if)#interface lo	Enter in to loopback interface
VTEP1(config-if)#ip address 1.1.1.1/32 secondary	Configure ip address
VTEP1(config-if)#interface xe1	Enter in to interface mode
VTEP1(config-if)#channel-group 2 mode active	Map to channel-group
VTEP1(config-if)#interface xe2	Enter in to interface mode
VTEP1(config-if)#channel-group 2 mode active	Map to channel-group
VTEP1(config-if)#interface xe14	Enter in to interface mode
VTEP1(config-if)#channel-group 24 mode active	Map to channel-group
VTEP1(config-if)#interface xe15	Enter in to interface mode
VTEP1(config-if)#channel-group 24 mode active	Map to channel-group
VTEP1(config-if)#router ospf 1	Create ospf instance
VTEP1(config-router)#ospf router-id 1.1.1.1	Configure ospf router-id
VTEP1(config-router)#network 1.1.1.1/32 area 0.0.0.0	Configure loopback network address in to ospf
VTEP1(config-router)#network 24.1.1.0/30 area 0.0.0.0	Configure network address in to ospf
VTEP1(config-router)#router bgp 100	Enter into Router BGP mode
VTEP1(config-router)#neighbor 6.6.6.6 remote-as 100	Specify a neighbor router with peer ip address and remote-as defined
VTEP1(config-router)#neighbor 6.6.6.6 update-source lo	Specify the neighbor to use loopback address as source
VTEP1(config-router)#address-family l2vpn evpn	Enter into l2vpn evpn address-family
VTEP1(config-router-af)#neighbor 6.6.6.6 activate	Activate the neighbor to address-family
VTEP1(config-router)#nvo vxlan vtep-ip-global 1.1.1.1	Configure Source vtep-ip-global configuration

VTEP1(config)#nvo vxlan tunnel qos-map-mode cos-dscp egress QUE-DSCP OR VTEP1(config)#nvo vxlan tunnel qos-map-mode cos-dscp egress DSCP-ENCAP	Configure the mapping qos profile in to vxlan tunnel egress Configure the mapping qos profile in to vxlan tunnel egress
VTEP1(config)#nvo vxlan id 1 in-gress-replication inner-vid-disabled	Create vnid 1 and disable inner-vid
VTEP1(config-nvo)#vxlan host-reachability-protocol evpn-bgp vrf1	Assign vrf for evpn-bgp to carry EVPN route
VTEP1(config-nvo)#nvo vxlan access-if port-vlan po2 1001	Create vxlan access-if with vlan 1001
VTEP1(config-nvo-acc-if)#no shutdown	No shut the vxlan access-if
VTEP1(config-nvo-acc-if)#map vnid 1	Map vnid to the vxlan access-if
VTEP1(config-nvo-acc-if)#map qos-profile cos-to-queue COS-QUE	Map qos profile for vxlan access-if ingress traffic from CE
VTEP1(config-nvo-acc-if)#exit	Exit from VxLAN access-interface mode and enter into configuration mode.
VTEP1(config)#commit	Commit the candidate configuration to the running configuration

RTR2

R2#configure terminal	Enter Configure mode.
R2(config)#interface po24	Create port channel
R2(config-if)#load-interval 30	Set load-interval
R2(config-if)#ip address 24.1.1.2/30	Assign ip address
R2(config-if)#interface po46	Create port channel
R2(config-if)#load-interval 30	Set load-interval
R2(config-if)#ip address 46.1.1.1/30	Assign ip address
R2(config-if)#interface lo	Enter in to loopback interface
R2(config-if)#ip address 4.4.4.4/32 secondary	Assign secondary ip address
R2(config-if)#interface xe4	Enter into interface mode
R2(config-if)#channel-group 46 mode active	Map port channel to the interface
R2(config-if)#interface xe5	Enter into interface mode
R2(config-if)#channel-group 46 mode active	Map port channel to the interface
R2(config-if)#interface xe14	Enter into interface mode
R2(config-if)#channel-group 24 mode active	Map port channel to the interface
R2(config-if)#interface xe15	Enter into interface mode
R2(config-if)#channel-group 24 mode active	Map port channel to the interface
R2(config-if)#router ospf 1	Create ospf instance
R2(config-router)#ospf router-id 4.4.4.4	Configure ospf router-id
R2(config-router)#network 4.4.4.4/32 area 0.0.0.0	Configure ospf network address with respective area

R2(config-router)#network 24.1.1.0/30 area 0.0.0.0	Configure ospf network address with respective area
R2(config-router)#network 46.1.1.0/30 area 0.0.0.0	Configure ospf network address with respective area
R2(config-router)#exit	Exit from router mode.
R2(config)#commit	Commit the candidate configuration to the running configuration

RTR3/VTEP2

VTEP3#configure terminal	Enter Configuration mode
VTEP3(config)#mac vrf vrf1	Create mac routing/forwarding instance with vrf1 name and enter into vrf mode
VTEP3(config-vrf)#rd 6.6.6.6:11	Assign RD value
VTEP3(config-vrf)#route-target both 10.10.10.10:100	Assign route-target value for import/export
VTEP1(config-vrf)#exit	Exit from vrf mode
VTEP1(config)#hardware-profile filter vxlan enable	Enable hardware profile for vxlan
VTEP3(config)#qos enable	Enable QOS
VTEP3(config)#qos statistics	Enable QOS statistics
VTEP3(config)#qos profile queue-color-to-cos QUE-COS	Create qos profile for mapping incoming traffic from tunnel to access-if.
VTEP3(config-egress-cos-map)#queue 4 cos 5	Configure particular queue value to the cos value for configured profile.
VTEP3(config-egress-cos-map)#qos profile dscp-to-queue DSCP-QUE	Create qos profile for attaching in vxlan tunnel ingress.
VTEP3(config-ingress-dscp-map)#dscp 16 queue 4	Configure particular dscp value to the queue value for configured profile.
VTEP3(config-egress-dscp-map)#interface po46	Create port channel
VTEP3(config-if)#load-interval 30	Set load interval
VTEP3(config-if)#ip address 46.1.1.2/30	Assign ip address
VTEP3(config-if)#interface lo	Enter into loopback interface
VTEP3(config-if)#ip address 6.6.6.6/32 secondary	Assign secondary ip address
VTEP3(config-if)#interface xe4	Enter into interface mode
VTEP3(config-if)#channel-group 46 mode active	Map channel group into the interface
VTEP3(config-if)#interface xe5	Enter into interface mode
VTEP3(config-if)#channel-group 46 mode active	Map channel group into the interface
VTEP3(config-if)#interface xe15	Enter into interface mode
VTEP3(config-if)#switchport	Make interface as L2 port
VTEP3(config-if)#load-interval 30	Set load interval
VTEP3(config-if)#router ospf 1	Create ospf instance

VTEP3(config-router)#ospf router-id 6.6.6.6	Configure ospf router-id
VTEP3(config-router)#network 6.6.6.6/32 area 0.0.0.0	Configure ospf network address with respective area
VTEP3(config-router)#network 46.1.1.0/30 area 0.0.0.0	Configure ospf network address with respective area
VTEP3(config-router)#router bgp 100	Enter into Router BGP mode
VTEP3(config-router)#neighbor 1.1.1.1 remote-as 100	Specify a neighbor router with peer ip address and remote-as defined
VTEP3(config-router)#neighbor 1.1.1.1 update-source lo	Specify the neighbor to use loopback address as source
VTEP3(config-router)#address-family l2vpn evpn	Enter into l2vpn evpn address-family
VTEP3(config-router-af)#neighbor 1.1.1.1 activate	Activate the neighbor to address-family
VTEP3(config)#nvo vxlan vtep-ip-global 6.6.6.6	Configure Source vtep-ip-global configuration
VTEP3(config)#nvo vxlan tunnel qos-map-mode cos-dscp ingress DSCP-QUE	Configure the mapping qos profile in to vxlan tunnel ingress
VTEP3(config)#nvo vxlan id 1 in-gress-replication inner-vid-disabled	Create vnid 1 and disable inner-vid
VTEP3(config-nvo)#vxlan host-reachability-protocol evpn-bgp vrf1	Assign vrf for evpn-bgp to carry EVPN route
VTEP3(config-nvo)#nvo vxlan access-if port-vlan xe15 1000	Create vxlan access-if with vlan 1000
VTEP3(config-nvo-acc-if)#no shutdown	No shut the vxlan access-if
VTEP3(config-nvo-acc-if)#map vnid 1	Map vnid to the vxlan access-if
VTEP3(config-nvo-acc-if)#map qos-profile queue-color-to-cos QUE-COS	Map qos profile for vxlan access-if egress traffic to CE
VTEP3(config-nvo-acc-if)#exit	Exit from VxLAN access-interface mode and enter into configuration mode
VTEP3(config)#commit	Commit the candidate configuration to the running configuration

Validation

As per the qos configuration, when L2 traffic with cos value 2 sent to VTEP1 access-if, the packets forwarded to queue 3 and packets in queue 3 are mapped with dscp value 16 while egress out of tunnel. At VTEP2, when packets with dscp value 16 ingress at tunnel, it is forwarded to queue 4 and packets of queue 4 are remarked with cos value 5.

RTR1/VTEP1

```
VTEP1#sh run nvo vxlan
!
nvo vxlan enable
!
nvo vxlan vtep-ip-global 1.1.1.1
!
nvo vxlan tunnel qos-map-mode cos-dscp egress QUE-DSCP (OR DSCP-ENCAP)
```

```

!
nvo vxlan id 1 ingress-replication inner-vid-disabled
  vxlan host-reachability-protocol evpn-bgp vrf1
!
nvo vxlan access-if port-vlan po2 1001
  map vnid 1
  map qos-profile cos-to-queue COS-QUE
!
VTEP1#show run qos
qos enable
!
qos profile cos-to-queue COS-QUE
  cos 2 queue 3
!
qos profile queue-color-to-dscp QUE-DSCP
  queue 3 color all dscp 16
!
                                OR
VTEP1#show run qos
qos enable
!
qos profile cos-to-queue COS-QUE
  cos 2 queue 3
!
qos profile dscp-encap DSCP-ENCAP
  12 queue 3 dscp 16
!

```

```

VTEP1#sh int xe14 count queue-stats
E - Egress, I - Ingress, Q-Size is in bytes
+-----+-----+-----+-----+-----+
+-----+
| Queue/Class-map | Q-Size | Tx pkts | Tx bytes | Dropped pkts |
Dropped bytes |
+-----+-----+-----+-----+-----+
+-----+
q0                (E) 12517376 0          0          0          0
q1                (E) 12517376 0          0          0          0
q2                (E) 12517376 0          0          0          0
q3                (E) 12517376 205284588 188040683524 0          0
q4                (E) 12517376 0          0          0          0
q5                (E) 12517376 0          0          0          0
q6                (E) 12517376 0          0          0          0
q7                (E) 12517376 7518       1007412    0          0

```

```

VTEP1#sh int xe15 count queue-stats
E - Egress, I - Ingress, Q-Size is in bytes
+-----+-----+-----+-----+-----+
+-----+
| Queue/Class-map | Q-Size | Tx pkts | Tx bytes | Dropped pkts |
Dropped bytes |
+-----+-----+-----+-----+-----+

```

```

+-----+-----+-----+-----+-----+
+-----+
q0          (E) 12517376 0          0          0          0
q1          (E) 12517376 0          0          0          0
q2          (E) 12517376 0          0          0          0
q3          (E) 12517376 205624494 188352040168 0          0
q4          (E) 12517376 0          0          0          0
q5          (E) 12517376 0          0          0          0
q6          (E) 12517376 0          0          0          0
q7          (E) 12517376 9006      1136741    0          0
  
```

```

VTEP1#
VTEP1#show nvo vxlan
VxLAN Information
=====
  
```

```

Codes: NW - Network Port
       AC - Access Port
       (u) - Untagged
  
```

VNID	VNI-Name	VNI-Type	Type	Interface	ESI	VLAN	DF-Status
Src-Addr	Dst-Addr						
1	-----	L2	NW	-----	-----	-----	-----
1.1.1.1	6.6.6.6						
1	-----	AC	po2	--- Single Hommed port ---	1001	-----	-----

```

Total number of entries are 3
VTEP1#show nvo vxlan mac-table
=====
  
```

VxLAN MAC Entries

VNID	Interface	VlanId	Inner-VlanId	Mac-Addr	VTEP-Ip/ESI
Type		Status		AccessPortDesc	
1	po2	1001	-----	0000.2000.9991	1.1.1.1
Dynamic	Local	-----		-----	

```

Total number of entries are : 1
  
```

```

VTEP1#show nvo vxlan tunnel
VxLAN Network tunnel Entries
  
```

Source	Destination	Status	Up/Down	Update
1.1.1.1	6.6.6.6	Installed	00:11:29	00:11:29

```

Total number of entries are 2
VTEP1#
  
```

RTR3/VTEP3

```

VTEP3#show run nvo vxlan
!
nvo vxlan enable
!
nvo vxlan vtep-ip-global 6.6.6.6
!
nvo vxlan tunnel qos-map-mode cos-dscp ingress DSCP-QUE
!
nvo vxlan id 1 ingress-replication inner-vid-disabled
  vxlan host-reachability-protocol evpn-bgp vrf1
!
nvo vxlan access-if port-vlan xe15 1000
  map vnid 1
  map qos-profile queue-color-to-cos QUE-COS
!
!
VTEP3#sh run qos
qos enable
qos statistics
!
qos profile queue-color-to-cos QUE-COS
  queue 4 color all cos 5
!
qos profile dscp-to-queue DSCP-QUE
  dscp 16 queue 4
!
VTEP3#show nvo vxlan mac-table

```

```

=====
=====
                                     VxLAN MAC Entries
=====
=====
VNID      Interface  VlanId Inner-VlanId Mac-Addr      VTEP-Ip/ESI
Type                               Status        AccessPortDesc
-----
1         ----      ----   ----          0000.2000.9991 1.1.1.1
Dynamic Remote                    -----

```

Total number of entries are : 1

```

VTEP3#show nvo vxlan tunnel
VxLAN Network tunnel Entries
Source          Destination      Status           Up/Down         Update
=====
6.6.6.6         1.1.1.1         Installed        00:09:39       00:09:39

```

Total number of entries are 2

VTEP3#sh nvo vxlan

VxLAN Information

=====

Codes: NW - Network Port
 AC - Access Port
 (u) - Untagged

VNID	VNI-Name	VNI-Type	Type	Interface	ESI	VLAN	DF-Status
Src-Addr	Dst-Addr						
1	-----	L2	NW	-----	-----	-----	-----
6.6.6.6	1.1.1.1						
1	-----	AC	xe15	--- Single Hommed port ---	1000	-----	-----

Total number of entries are 3

VTEP3#

VTEP3#show int xe15 count queue-stats

E - Egress, I - Ingress, Q-Size is in bytes

Queue/Class-map	Q-Size	Tx pkts	Tx bytes	Dropped pkts
q0	(E) 12517376 0	0	0	0
q1	(E) 12517376 0	0	0	0
q2	(E) 12517376 0	0	0	0
q3	(E) 12517376 0	0	0	0
q4	(E) 12517376 37895872	36455829826	0	0
q5	(E) 12517376 0	0	0	0
q6	(E) 12517376 0	0	0	0
q7	(E) 12517376 0	0	0	0

VTEP3#

CHAPTER 8 VxLAN Tunnel Over SVI

This chapter contains the configurations for VxLAN Tunnel Over SVI.

Overview

VxLAN EVPN solution is envisioned to simplify the topology and configurations in Data Centers (DC). In Data Centers, CLOS topology was used, which makes network side pure L3 and uses EBGp as IGP.

VxLAN solution is required for Service Providers (SP) as well to run few of the services or all services in their network over VxLAN. When they choose to run few services over VxLAN, then on the network side there will be a need to run VxLAN over SVI.

Topology

The Topology shown below contains the 3 VTEPS i.e VTEP1 ,VTEP2 and VTEP3 and 3 core nodes P1 ,P2 and P3. Vxlan tunnel will be established between VTEPS over SVI interfaces. OSPF as IGP will be running between VTEPS and the core node to provide the end to end connectivity. Switch is connected between host and VTEP-1, VTEP-2 via dynamic LAG.

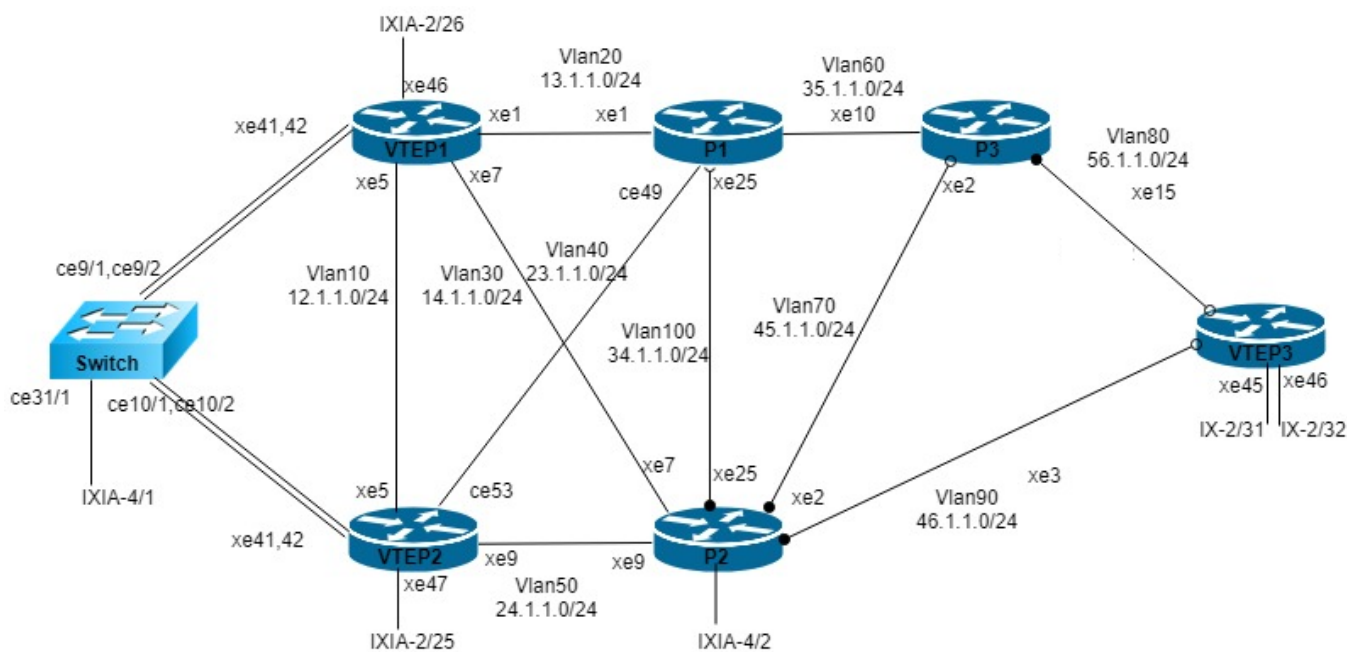

Figure 8-9: VxLAN over SVI

RTR1/VTEP1

VTEP1#configure terminal	Enter configuration terminal
VTEP1(config)#hostname VTEP1	Configure hostname

VTEP1(config)#mac vrf vrf1	Configure mac vrf vrf1
VTEP1(config-vrf)# rd 1.1.1.1:11	Configure RD for vrf1
VTEP1(config-vrf)# route-target both 10.10.10.10:100	Configure RT for vrf1
VTEP1(config-vrf)#mac vrf vrf2	Configure mac vrf vrf2
VTEP1(config-vrf)# rd 1.1.1.1:12	Configure RD for vrf2
VTEP1(config-vrf)# route-target both 10.10.10.10:102	Configure RT for vrf2
VTEP1(config-vrf)#bfd interval 3 minrx 3 multiplier 3	Configure bfd interval globally
VTEP1(config)#hardware-profile filter egress-ipv4 enable	Enable hardware filter for egress ipv4
VTEP1(config)#hardware-profile filter vxlan enable	Enable vxlan in hardware
VTEP1(config)# hardware-profile filter vxlan-mh enable	Enable vxlan-mh in hardware
VTEP1(config)#hardware-profile statistics ac-lif enable	Enable ac-lif for enabling vxlan counters
VTEP1(config)#evpn vxlan multihoming enable	Enable evpn vxlan multihoming
VTEP1(config)#nvo vxlan enable	Enable vxlan
VTEP1(config)#qos enable	Enable qos
VTEP1(config)#qos statistics	Enable qos statistics
VTEP1(config)#bridge 1 protocol ieee vlan-bridge	Configure IEEE vlan bridge
VTEP1(config)#no bridge 1 spanning-tree enable	Disable spanning tree in bridge 1 globally
VTEP1(config)#no igmp snooping	Disable igmp snooping messages globally
VTEP1(config)#vlan database	Enter into the vlan database
VTEP1(config-vlan)# vlan 10-200 bridge 1 state enable	Configure vlan 10-200 and associate with bridge 1
VTEP1(config-vlan)# vlan 4000 bridge 1 state enable	Configure vlan 4000 and associate with bridge 1
VTEP1(config-vlan)#interface po1	Enter interface mode
VTEP1(config-if)# switchport	Set the interface as Layer2 port
VTEP1(config-if)# load-interval 30	Configure load period in multiple of 30 seconds
VTEP1(config-if)# evpn multi-homed system-mac aa22.3344.5566	Configure evpn system-mac
VTEP1(config-if)#interface lo	Enter lo interface mode
VTEP1(config-if)# ip address 1.1.1.1/32 secondary	Assign loopback ip
VTEP1(config-if)#interface vlan1.10	Specify interface vlan1.10 to be configured.
VTEP1(config-if)# ip address 12.1.1.1/24	Assign ip address
VTEP1(config-if)# ip ospf cost 1	Change ospf cost of the link
VTEP1(config-if)#interface vlan1.20	Specify interface vlan1.20 to be configured.
VTEP1(config-if)# ip address 13.1.1.1/24	Assign ip address

VTEP1(config-if)# ip ospf cost 1	Change ospf cost of the link
VTEP1(config-if)#interface vlan1.30	Specify interface vlan1.30 to be configured.
VTEP1(config-if)# ip address 14.1.1.1/24	Assign ip address
VTEP1(config-if)# ip ospf cost 1	Change ospf cost of the link
VTEP1(config-if)#interface xe1	Enter interface mode
VTEP1(config-if)# switchport	Set the interface as Layer2 port
VTEP1(config-if)# bridge-group 1 spanning-tree disable	Associate the interface with bridge group 1 and disable spanning tree
VTEP1(config-if)# switchport mode trunk	Set the switching characteristics of this interface to trunk mode.
VTEP1(config-if)# switchport trunk allowed vlan add 20,29	Enable VLAN's allowed on this interface.
VTEP1(config-if)# switchport trunk native vlan 29	Configure native vlan
VTEP1(config-if)# load-interval 30	Configure load period in multiple of 30 seconds
VTEP1(config-if)# spanning-tree edgeport	Set the port as an edge-port to enable rapid transitions
VTEP1(config-if)#interface xe5	Enter interface mode
VTEP1(config-if)# switchport	Set the interface as Layer2 port
VTEP1(config-if)# bridge-group 1 spanning-tree disable	Associate the interface with bridge group 1 and disable spanning tree
VTEP1(config-if)# switchport mode trunk	Set the switching characteristics of this interface to trunk mode.
VTEP1(config-if)# switchport trunk allowed vlan add 10,19	Enable VLAN's allowed on this interface.
VTEP1(config-if)# switchport trunk native vlan 19	Configure native vlan
VTEP1(config-if)# load-interval 30	Configure load period in multiple of 30 seconds
VTEP1(config-if)# spanning-tree edgeport	Set the port as an edge-port to enable rapid transitions
VTEP1(config-if)#interface xe7	Enter interface mode
VTEP1(config-if)# switchport	Set the interface as Layer2 port
VTEP1(config-if)# bridge-group 1 spanning-tree disable	Associate the interface with bridge group 1 and disable spanning tree
VTEP1(config-if)# switchport mode trunk	Set the switching characteristics of this interface to trunk mode.
VTEP1(config-if)# switchport trunk allowed vlan add 30,39	Enable VLAN's allowed on this interface.
VTEP1(config-if)# switchport trunk native vlan 39	Configure native vlan
VTEP1(config-if)# load-interval 30	Configure load period in multiple of 30 seconds
VTEP1(config-if)# spanning-tree edgeport	Set the port as an edge-port to enable rapid transitions
VTEP1(config-if)#interface xe41	Enter interface mode
VTEP1(config-if)# channel-group 1 mode active	Map this interface to po1
VTEP1(config-if)#interface xe42	Enter interface mode
VTEP1(config-if)# channel-group 1 mode active	Map this interface to po1

VTEP1(config-if)#interface xe46	Enter interface mode
VTEP1(config-if)# switchport	Map this interface to po1
VTEP1(config-if)#router ospf 1	Enter ospf configuration mode
VTEP1(config-router)# ospf router-id 1.1.1.1	Configure ospf router id
VTEP1(config-router)# bfd all-interfaces	Enable bfd in all ospf interfaces
VTEP1(config-router)# network 1.1.1.1/32 area 0.0.0.0	Define the Network on which OSPF runs and associate the area ID (area 0) with the interface.
VTEP1(config-router)# network 12.1.1.0/24 area 0.0.0.0	Define the Network on which OSPF runs and associate the area ID (area 0) with the interface.
VTEP1(config-router)# network 13.1.1.0/24 area 0.0.0.0	Define the Network on which OSPF runs and associate the area ID (area 0) with the interface.
VTEP1(config-router)# network 14.1.1.0/24 area 0.0.0.0	Define the Network on which OSPF runs and associate the area ID (area 0) with the interface.
VTEP1(config-router)#router bgp 100	Enter Router BGP mode and define the AS number 100.
VTEP1(config-router)# address-family ipv4 unicast	Enter address-family ipv4 unicast mode
VTEP1(config-router)# network 1.1.1.1/32	Add the lo network to bgp route
VTEP1(config-router-af)# neighbor 2.2.2.2 activate	Activate neighbors
VTEP1(config-router-af)# neighbor 6.6.6.6 activate	Activate neighbors
VTEP1(config-router-af)#exit-address-family	Exit address-family mode.
VTEP1(config-router)# neighbor 2.2.2.2 remote-as 100	Configure bgp remote-as 100 with neighbor IP
VTEP1(config-router)# neighbor 2.2.2.2 update-source lo	Define BGP neighbors, to update the source routes with lo
(config-router)#neighbor 2.2.2.2 advertisement-interval 0	Configure advertisement-interval as 0 for fast convergence for VTEP2
VTEP1(config-router)# neighbor 6.6.6.6 remote-as 100	Configure bgp remote-as 100 with neighbor IP
VTEP1(config-router)# neighbor 6.6.6.6 update-source lo	Define BGP neighbors, to update the source routes with lo
(config-router)#neighbor 6.6.6.6 advertisement-interval 0	Configure advertisement-interval as 0 for fast convergence for VTEP3
VTEP1(config-router)# address-family l2vpn evpn	Enter in to bgp l2vpn evpn address-family
VTEP1(config-router-af)# neighbor 2.2.2.2 activate	Activate neighbors
VTEP1(config-router-af)# neighbor 6.6.6.6 activate	Activate neighbors
VTEP1(config-router-af)# exit-address- family	Exit from bgp l2vpn evpn address-family
VTEP1(config-router)#nvo vxlan vtep-ip- global 1.1.1.1	Configure vxlan global ip
VTEP1(config)#nvo vxlan id 1 ingress- replication inner-vid-disabled	Create vnid 1
VTEP1(config-nvo)# vxlan host-reachability- protocol evpn-bgp vrf1	Associate vnid with evpn and vrf1

VTEP1(config-nvo)#nvo vxlan id 1000 ingress-replication inner-vid-disabled	Create vnid 1000
VTEP1(config-nvo)# vxlan host-reachability-protocol evpn-bgp vrf2	Associate vnid with evpn and vrf2
VTEP1(config-nvo-acc-if)#nvo vxlan access-if port-vlan po1 2000	Create vxlan access port port-vlan
VTEP1(config-nvo-acc-if)# no shutdown	Unshut the access interface
VTEP1(config-nvo-acc-if)# map vnid 1000	Map the vnid to access-if
VTEP1(config-nvo)#nvo vxlan access-if port xe46	Create vxlan access port
VTEP1(config-nvo-acc-if)# no shutdown	Unshut the access interface
VTEP1(config-nvo-acc-if)# map vnid 1	Map the vnid to access-if
VTEP1(config-nvo-acc-if)#nvo vxlan access-if port-vlan po1 1000	Create vxlan access port port-vlan
VTEP1(config-nvo-acc-if)# no shutdown	Unshut the access interface
VTEP1(config-nvo-acc-if)# map vnid 1	Map the vnid to access-if
VTEP1(config-nvo-acc-if)# mac 0000.1111.1111 ip 100.1.1.100	Configure static mac ip
VTEP1(config-nvo-acc-if)# mac 0000.1111.1112	Configure static mac
VTEP1(config-nvo-acc-if)# mac 0000.1111.1113	Configure static mac
VTEP1(config-nvo-acc-if)# mac 0000.1111.1114	Configure static mac
VTEP1(config-nvo-acc-if)# mac 0000.1111.1115	Configure static mac
VTEP1(config-nvo-acc-if)# commit	Commit the candidate configuration to the running configuration

VTEP2

VTEP2#configure terminal	Enter configuration terminal
VTEP2(config)#hostname VTEP2	Configure hostname
VTEP2(config)#mac vrf vrf1	Configure mac vrf vrf1
VTEP2(config-vrf)# rd 2.2.2.2:11	Configure RD for vrf1
VTEP2(config-vrf)# route-target both 10.10.10.10:100	Configure RT for vrf1
VTEP2(config-vrf)#mac vrf vrf2	Configure mac vrf vrf2
VTEP2(config-vrf)# rd 2.2.2.2:12	Configure RD for vrf2
VTEP2(config-vrf)# route-target both 10.10.10.10:102	Configure RT for vrf2
VTEP2(config)#hardware-profile filter egress-ipv4 enable	Enable hardware filter for egress ipv4
VTEP2(config)#hardware-profile filter vxlan enable	Enable vxlan in hardware
VTEP2(config)#nvo vxlan enable	Enable vxlan
VTEP2(config)# hardware-profile filter vxlan-mh enable	Enable vxlan-mh in hardware
VTEP2(config)#evpn vxlan multihoming enable	Enable evpn vxlan multihoming

VTEP2(config)#hardware-profile statistics ac-lif enable	Enable ac-lif for enabling vxlan counters
VTEP2(config)#qos enable	Enable qos
VTEP2(config)#qos statistics	Enable qos statistics
VTEP2(config)#bridge 1 protocol ieee vlan- bridge	Configure IEEE vlan bridge
VTEP2(config)#no bridge 1 spanning-tree enable	Disable spanning tree in bridge 1 globally
VTEP2(config)#vlan database	Enter into the vlan database
VTEP2(config-vlan)# vlan 10-200 bridge 1 state enable	Configure vlan 10-200 and associate with bridge 1
VTEP2(config-vlan)#interface po1	Enter interface mode
VTEP2(config-if)# switchport	Set the interface as Layer2 port
VTEP2(config-if)# load-interval 30	Configure load period in multiple of 30 seconds
VTEP2(config-if)# evpn multi-homed system- mac aa22.3344.5566	Configure evpn system-mac
VTEP2(config-if)#interface lo	Enter interface mode
VTEP2(config-if)# ip address 2.2.2.2/32 secondary	Configure loopback ip
VTEP2(config-if)#interface vlan1.10	Specify interface vlan1.10 to be configured.
VTEP2(config-if)# ip address 12.1.1.2/24	Assign ip address
VTEP2(config-if)#interface vlan1.40	Specify interface vlan1.40 to be configured.
VTEP2(config-if)# ip address 23.1.1.1/24	Assign ip address
VTEP2(config-if)# ip ospf cost 1	Change ospf cost of the link
VTEP2(config-if)#interface vlan1.50	Specify interface vlan1.50 to be configured.
VTEP2(config-if)# ip address 24.1.1.1/24	Assign ip address
VTEP2(config-if)#interface ce53	Enter interface mode
VTEP2(config-if)# switchport	Set the interface as Layer2 port
VTEP2(config-if)# bridge-group 1 spanning- tree disable	Associate the interface with bridge group 1 and disable spanning tree
VTEP2(config-if)# switchport mode trunk	Set the switching characteristics of this interface to trunk mode.
VTEP2(config-if)# switchport trunk allowed vlan add 40,49	Enable VLAN's allowed on this interface.
VTEP2(config-if)# switchport trunk native vlan 49	Configure native vlan
VTEP2(config-if)# load-interval 30	Configure load period in multiple of 30 seconds
VTEP2(config-if)# spanning-tree edgeport	Set the port as an edge-port to enable rapid transitions
VTEP2(config-if)#interface xe5	Enter interface mode
VTEP2(config-if)# switchport	Set the interface as Layer2 port
VTEP2(config-if)# bridge-group 1 spanning- tree disable	Associate the interface with bridge group 1 and disable spanning tree
VTEP2(config-if)# switchport mode trunk	Set the switching characteristics of this interface to trunk mode

VTEP2(config-if)# switchport trunk allowed vlan add 10,19	Enable VLAN's allowed on this interface
VTEP2(config-if)# switchport trunk native vlan 19	Configure native vlan
VTEP2(config-if)# load-interval 30	Configure load period in multiple of 30 seconds
VTEP2(config-if)# spanning-tree edgeport	Set the port as an edge-port to enable rapid transitions
VTEP2(config-if)#interface xe9	Enter interface mode
VTEP2(config-if)# switchport	Set the interface as Layer2 port
VTEP2(config-if)# bridge-group 1 spanning- tree disable	Associate the interface with bridge group 1 and disable spanning tree
VTEP2(config-if)# switchport mode trunk	Set the switching characteristics of this interface to trunk mode.
VTEP2(config-if)# switchport trunk allowed vlan add 50,59	Enable VLAN's allowed on this interface.
VTEP2(config-if)# switchport trunk native vlan 59	Configure native vlan
VTEP2(config-if)# load-interval 30	Configure load period in multiple of 30 seconds
VTEP2(config-if)# spanning-tree edgeport	Set the port as an edge-port to enable rapid transitions
VTEP2(config-if)#interface xe41	Enter interface mode
VTEP2(config-if)# channel-group 1 mode active	Map the interface to po1
VTEP2(config-if)#interface xe42	Enter interface mode
VTEP2(config-if)# channel-group 1 mode active	Map the interface to po1
VTEP2(config-if)#interface xe47	Enter interface mode
VTEP2(config-if)# switchport	Set the interface as Layer2 port
VTEP2(config-if)#router ospf 1	Enter ospf configuration mode
VTEP2(config-router)# ospf router-id 2.2.2.2	Configure ospf router id
VTEP2(config-router)# network 2.2.2.2/32 area 0.0.0.0	Enable bfd in all ospf interfaces
VTEP2(config-router)# network 12.1.1.0/24 area 0.0.0.0	Define the Network on which OSPF runs and associate the area ID (area 0) with the interface.
VTEP2(config-router)# network 23.1.1.0/24 area 0.0.0.0	Define the Network on which OSPF runs and associate the area ID (area 0) with the interface.
VTEP2(config-router)# network 24.1.1.0/24 area 0.0.0.0	Define the Network on which OSPF runs and associate the area ID (area 0) with the interface.
VTEP2(config-router)# network 25.1.1.0/24 area 0.0.0.0	Define the Network on which OSPF runs and associate the area ID (area 0) with the interface.
VTEP2(config-router)#router bgp 100	Enter Router BGP mode and define the AS number 100.
VTEP2(config-router)# address-family ipv4 unicast	Enter address-family ipv4 unicast mode
VTEP2(config-router)# network 2.2.2.2/32	Add the lo network to bgp route
VTEP2(config-router-af)# neighbor 1.1.1.1 activate	Activate neighbors
VTEP2(config-router-af)# neighbor 6.6.6.6 activate	Activate neighbors
VTEP2(config-router-af)#exit-address-family	Exit address-family mode.

VTEP2(config-router)# neighbor 1.1.1.1 remote-as 100	Configure bgp remote-as 100 with neighbor IP
VTEP2(config-router)#neighbor 1.1.1.1 advertisement-interval 0	Configure advertisement-interval as 0 for fast convergence for VTEP1
VTEP2(config-router)# neighbor 1.1.1.1 update-source lo	Define BGP neighbors, to update the source routes with lo
VTEP2(config-router)# neighbor 6.6.6.6 remote-as 100	Configure bgp remote-as 100 with neighbor IP
VTEP2(config-router)#neighbor 6.6.6.6 advertisement-interval 0	Configure advertisement-interval as 0 for fast convergence for VTEP3
VTEP2(config-router)# neighbor 6.6.6.6 update-source lo	Define BGP neighbors, to update the source routes with lo
VTEP2(config-router)# address-family l2vpn evpn	Enter in to bgp l2vpn evpn address-family
VTEP2(config-router-af)# neighbor 1.1.1.1 activate	Activate neighbors
VTEP2(config-router-af)# neighbor 6.6.6.6 activate	Activate neighbors
VTEP2(config-router-af)# exit-address-family	Exit from bgp l2vpn evpn address-family
VTEP2(config-router)#nvo vxlan vtep-ip-global 2.2.2.2	Configure vxlan global ip
VTEP2(config)#nvo vxlan id 1 ingress-replication inner-vid-disabled	Create vnid 1
VTEP2(config-nvo)# vxlan host-reachability-protocol evpn-bgp vrf1	Associate vnid with evpn and vrf1
VTEP2(config-nvo)#nvo vxlan id 1000 ingress-replication inner-vid-disabled	Create vnid 1000
VTEP2(config-nvo)# vxlan host-reachability-protocol evpn-bgp vrf2	Associate vnid with evpn and vrf2
VTEP2(config-nvo)#nvo vxlan access-if port xe47	Create vxlan access port
VTEP2(config-nvo-acc-if)# map vnid 1	Map the vnid to access-if
VTEP2(config-nvo-acc-if)#nvo vxlan access-if port-vlan po1 2001	Create vxlan access port
VTEP2(config-nvo-acc-if)# map vnid 1000	Map the vnid to access-if
VTEP2(config-nvo-acc-if)#nvo vxlan access-if port-vlan po1 2000	Create vxlan access port
VTEP2(config-nvo-acc-if)# map vnid 1000	Map the vnid to access-if
VTEP2(config-nvo-acc-if)# commit	Commit the candidate configuration to the running configuration

P1

P1#configure terminal	Enter configuration terminal
P1(config)#hostname P1	Configure hostname
P1(config)#bfd interval 3 minrx 3 multiplier 3	Configure bfd interval globally
P1(config)#qos enable	Enable qos

P1(config)#bridge 1 protocol ieee vlan-bridge	Configure IEEE vlan bridge
P1(config)#no bridge 1 spanning-tree enable	Disable spanning tree in bridge 1 globally
P1(config)#no igmp snooping	Disable igmp snooping messages globally
P1(config)#vlan database	Enter into the vlan database
P1(config-vlan)# vlan 10-200 bridge 1 state enable	Configure vlan 10-200 and associate with bridge 1
P1(config-if)#interface lo	Enter loopback interface mode
P1(config-if)# ip address 3.3.3.3/32 secondary	Assign loopback ip
P1(config-if)#interface vlan1.20	Specify interface vlan1.20 to be configured.
P1(config-if)# ip address 13.1.1.2/24	Assign ip address
P1(config-if)# ip ospf cost 1	Change ospf cost of the link
P1(config-if)#interface vlan1.40	Specify interface vlan1.40 to be configured.
P1(config-if)# ip address 23.1.1.2/24	Assign ip address
P1(config-if)#interface vlan1.60	Specify interface vlan1.60 to be configured.
P1(config-if)# ip address 35.1.1.1/24	Assign ip address
P1(config-if)# ip ospf cost 1	Change ospf cost of the link
P1(config-if)#interface vlan1.100	Specify interface vlan1.100 to be configured.
P1(config-if)# ip address 34.1.1.1/24	Assign ip address
P1(config-if)# ip ospf cost 1	Change ospf cost of the link
P1(config-vlan)#interface ce49	Enter interface mode
P1(config-if)# switchport	Set the interface as Layer2 port
P1(config-if)# bridge-group 1 spanning-tree disable	Associate the interface with bridge group 1 and disable spanning tree
P1(config-if)# switchport mode trunk	Set the switching characteristics of this interface to trunk mode.
P1(config-if)# switchport trunk allowed vlan add 40,49	Enable VLAN's allowed on this interface.
P1(config-if)# switchport trunk native vlan 49	Configure native vlan
P1(config-if)# load-interval 30	Configure load period in multiple of 30 seconds
P1(config-if)# spanning-tree edgeport	Set the port as an edge-port to enable rapid transitions
P1(config-if)#interface xe1	Enter interface mode
P1(config-if)# switchport	Set the interface as Layer2 port
P1(config-if)# bridge-group 1 spanning-tree disable	Associate the interface with bridge group 1 and disable spanning tree
P1(config-if)# switchport mode trunk	Set the switching characteristics of this interface to trunk mode.
P1(config-if)# switchport trunk allowed vlan add 20,29	Enable VLAN's allowed on this interface.
P1(config-if)# switchport trunk native vlan 29	Configure native vlan
P1(config-if)# load-interval 30	Configure load period in multiple of 30 seconds
P1(config-if)# mtu 1600	Change the interface mtu value

P1(config-if)# spanning-tree edgeport	Set the port as an edge-port to enable rapid transitions
P1(config-if)#interface xe10	Enter interface mode
P1(config-if)# switchport	Set the interface as Layer2 port
P1(config-if)# bridge-group 1 spanning-tree disable	Associate the interface with bridge group 1 and disable spanning tree
P1(config-if)# switchport mode trunk	Set the switching characteristics of this interface to trunk mode.
P1(config-if)# switchport trunk allowed vlan add 60,69	Enable VLAN's allowed on this interface.
P1(config-if)# switchport trunk native vlan 69	Configure native vlan
P1(config-if)# load-interval 30	Configure load period in multiple of 30 seconds
P1(config-if)# mtu 1600	Change the interface mtu value
P1(config-if)# spanning-tree edgeport	Set the port as an edge-port to enable rapid transitions
P1(config-if)#interface xe25	Enter interface mode
P1(config-if)# switchport	Set the interface as Layer2 port
P1(config-if)# bridge-group 1 spanning-tree disable	Associate the interface with bridge group 1 and disable spanning tree
P1(config-if)# switchport mode trunk	Set the switching characteristics of this interface to trunk mode.
P1(config-if)# switchport trunk allowed vlan add 100,109	Enable VLAN's allowed on this interface.
P1(config-if)# switchport trunk native vlan 109	Configure native vlan
P1(config-if)# load-interval 30	Configure load period in multiple of 30 seconds
P1(config-if)# spanning-tree edgeport	Set the port as an edge-port to enable rapid transitions
P1(config-if)#router ospf 1	Enter ospf configuration mode
P1(config-router)# ospf router-id 3.3.3.3	Configure ospf router id
P1(config-router)# bfd all-interfaces	Enable bfd in all ospf interfaces
P1(config-router)# network 3.3.3.3/32 area 0.0.0.0	Define the Network on which OSPF runs and associate the area ID (area 0) with the interface.
P1(config-router)# network 10.10.10.0/24 area 0.0.0.0	Define the Network on which OSPF runs and associate the area ID (area 0) with the interface.
P1(config-router)# network 13.1.1.0/24 area 0.0.0.0	Define the Network on which OSPF runs and associate the area ID (area 0) with the interface.
P1(config-router)# network 23.1.1.0/24 area 0.0.0.0	Define the Network on which OSPF runs and associate the area ID (area 0) with the interface.
P1(config-router)# network 34.1.1.0/24 area 0.0.0.0	Define the Network on which OSPF runs and associate the area ID (area 0) with the interface.
P1(config-router)# network 35.1.1.0/24 area 0.0.0.0	Define the Network on which OSPF runs and associate the area ID (area 0) with the interface.
P1(config-router)# commit	Commit the candidate configuration to the running configuration

P2

P2#configure terminal	Enter configuration terminal
P2(config)#bfd interval 3 minrx 3 multiplier 3	Configure bfd interval globally
P2(config)#qos enable	Enable qos
P2(config)#hostname P2	Configure hostname
P2(config)#bridge 1 protocol ieee vlan-bridge	Configure IEEE vlan bridge
P2(config)#no bridge 1 spanning-tree enable	Disable spanning tree in bridge 1 globally
P2(config)#no igmp snooping	Disable igmp snooping messages globally
P2(config)#vlan database	Enter into the vlan database
P2(config-vlan)# vlan 10-200 bridge 1 state enable	Configure vlan 10-200 and associate with bridge 1
P2(config-vlan)#interface lo	Enter lo interface mode
P2(config-if)# ip address 4.4.4.4/32 secondary	Assign loopback ip
P2(config-if)#interface vlan1.30	Specify interface vlan1.30 to be configured.
P2(config-if)# ip address 14.1.1.2/24	Assign ip address
P2(config-if)# ip ospf cost 1	Change ospf cost of the link
P2(config-if)#interface vlan1.50	Specify interface vlan1.50 to be configured.
P2(config-if)# ip address 24.1.1.2/24	Assign ip address
P2(config-if)#interface vlan1.70	Specify interface vlan1.70 to be configured.
P2(config-if)# ip address 45.1.1.1/24	Assign ip address
P2(config-if)# ip ospf cost 1	Change ospf cost of the link
P2(config-if)#interface vlan1.90	Specify interface vlan1.90 to be configured.
P2(config-if)# ip address 46.1.1.1/24	Assign ip address
P2(config-if)# ip ospf cost 1	Change ospf cost of the link
P2(config-if)#interface vlan1.100	Specify interface vlan1.100 to be configured.
P2(config-if)# ip address 34.1.1.2/24	Assign ip address
P2(config-if)# ip ospf cost 1	Change ospf cost of the link
P2(config-if)#interface xe2	Enter interface mode
P2(config-if)# switchport	Set the interface as Layer2 port
P2(config-if)# bridge-group 1 spanning-tree disable	Associate the interface with bridge group 1 and disable spanning tree
P2(config-if)# switchport mode trunk	Set the switching characteristics of this interface to trunk mode.
P2(config-if)# switchport trunk allowed vlan add 70,79	Enable VLAN's allowed on this interface.
P2(config-if)# switchport trunk native vlan 79	Configure native vlan
P2(config-if)# load-interval 30	Configure load period in multiple of 30 seconds
P2(config-if)# spanning-tree edgeport	Set the port as an edge-port to enable rapid transitions

P2(config-if)#interface xe3	Enter interface mode
P2(config-if)# switchport	Set the interface as Layer2 port
P2(config-if)# bridge-group 1 spanning-tree disable	Associate the interface with bridge group 1 and disable spanning tree
P2(config-if)# switchport mode trunk	Set the switching characteristics of this interface to trunk mode.
P2(config-if)# switchport trunk allowed vlan add 90,99	Enable VLAN's allowed on this interface.
P2(config-if)# switchport trunk native vlan 99	Configure native vlan
P2(config-if)# load-interval 30	Configure load period in multiple of 30 seconds
P2(config-if)# spanning-tree edgeport	Set the port as an edge-port to enable rapid transitions
P2(config-if)#interface xe7	Enter interface mode
P2(config-if)# switchport	Set the interface as Layer2 port
P2(config-if)# bridge-group 1 spanning-tree disable	Associate the interface with bridge group 1 and disable spanning tree
P2(config-if)# switchport mode trunk	Set the switching characteristics of this interface to trunk mode.
P2(config-if)# switchport trunk allowed vlan add 30,39	Enable VLAN's allowed on this interface.
P2(config-if)# switchport trunk native vlan 39	Configure native vlan
P2(config-if)# load-interval 30	Configure load period in multiple of 30 seconds
P2(config-if)# spanning-tree edgeport	Set the port as an edge-port to enable rapid transitions
P2(config-if)#interface xe9	Enter interface mode
P2(config-if)# switchport	Set the interface as Layer2 port
P2(config-if)# bridge-group 1 spanning-tree disable	Associate the interface with bridge group 1 and disable spanning tree
P2(config-if)# switchport mode trunk	Set the switching characteristics of this interface to trunk mode.
P2(config-if)# switchport trunk allowed vlan add 50,59	Enable VLAN's allowed on this interface.
P2(config-if)# switchport trunk native vlan 59	Configure native vlan
P2(config-if)# load-interval 30	Configure load period in multiple of 30 seconds
P2(config-if)# spanning-tree edgeport	Set the port as an edge-port to enable rapid transitions
P2(config-if)#interface xe25	Enter interface mode
P2(config-if)# switchport	Set the interface as Layer2 port
P2(config-if)# bridge-group 1 spanning-tree disable	Associate the interface with bridge group 1 and disable spanning tree
P2(config-if)# switchport mode trunk	Set the switching characteristics of this interface to trunk mode.
P2(config-if)# switchport trunk allowed vlan add 100,109	Enable VLAN's allowed on this interface.
P2(config-if)# switchport trunk native vlan 109	Configure native vlan
P2(config-if)# load-interval 30	Configure load period in multiple of 30 seconds

P2(config-if)# spanning-tree edgeport	Set the port as an edge-port to enable rapid transitions
P2(config-if)#router ospf 1	Enter ospf configuration mode
P2(config-router)# ospf router-id 4.4.4.4	Configure ospf router id
P2(config-router)# bfd all-interfaces	Enable bfd in all ospf interfaces
P2(config-router)# network 4.4.4.4/32 area 0.0.0.0	Define the Network on which OSPF runs and associate the area ID (area 0) with the interface.
P2(config-router)# network 14.1.1.0/24 area 0.0.0.0	Define the Network on which OSPF runs and associate the area ID (area 0) with the interface.
P2(config-router)# network 24.1.1.0/24 area 0.0.0.0	Define the Network on which OSPF runs and associate the area ID (area 0) with the interface.
P2(config-router)# network 34.1.1.0/24 area 0.0.0.0	Define the Network on which OSPF runs and associate the area ID (area 0) with the interface.
P2(config-router)# network 45.1.1.0/24 area 0.0.0.0	Define the Network on which OSPF runs and associate the area ID (area 0) with the interface.
P2(config-router)# network 46.1.1.0/24 area 0.0.0.0	Define the Network on which OSPF runs and associate the area ID (area 0) with the interface.
P2(config-router)#commit	Commit the candidate configuration to the running configuration

P3

P3(config)#hostname P3	Configure hostname
P3(config)#bfd interval 3 minrx 3 multiplier 3	Configure bfd interval globally
P3(config)#qos enable	Enable qos
P3(config)#bridge 1 protocol ieee vlan-bridge	Configure IEEE vlan bridge
P3(config)#no bridge 1 spanning-tree enable	Disable spanning tree in bridge 1 globally
P3(config)#no igmp snooping	Disable igmp snooping messages globally
P3(config)#vlan database	Enter into the vlan database
P3(config-vlan)# vlan 10-200 bridge 1 state enable	Configure vlan 10-200 and associate with bridge 1
P3(config-vlan)#interface lo	Enter lo interface mode
P3(config-if)# ip address 5.5.5.5/32 secondary	Assign loopback ip
P3(config-if)#interface vlan1.60	Specify interface vlan1.60 to be configured.
P3(config-if)# ip address 35.1.1.2/24	Assign ip address
P3(config-if)# ip ospf cost 1	Change ospf cost of the link
P3(config-if)#interface vlan1.70	Specify interface vlan1.70 to be configured.
P3(config-if)# ip address 45.1.1.2/24	Assign ip address
P3(config-if)# ip ospf cost 1	Change ospf cost of the link
P3(config-if)#interface vlan1.80	Specify interface vlan1.80 to be configured.
P3(config-if)# ip address 56.1.1.1/24	Assign ip address
P3(config-if)# ip ospf cost 1	Change ospf cost of the link
P3(config-if)#interface vlan1.110	Specify interface vlan1.1100 to be configured.

P3(config-if)# ip address 15.1.1.2/24	Assign ip address
P3(config-if)# ip ospf cost 1	Change ospf cost of the link
P3(config-if)#interface vlan1.160	Specify interface vlan1.160 to be configured.
P3(config-if)# ip address 25.1.1.2/24	Assign ip address
P3(config-if)# ip ospf cost 1	Change ospf cost of the link
P3(config-if)#interface xe2	Enter interface mode
P3(config-if)# switchport	Set the interface as Layer2 port
P3(config-if)# bridge-group 1 spanning-tree disable	Associate the interface with bridge group 1 and disable spanning tree
P3(config-if)# switchport mode trunk	Set the switching characteristics of this interface to trunk mode.
P3(config-if)# switchport trunk allowed vlan add 70,79	Enable VLAN's allowed on this interface.
P3(config-if)# switchport trunk native vlan 79	Configure native vlan
P3(config-if)# load-interval 30	Configure load period in multiple of 30 seconds
P3(config-if)# spanning-tree edgeport	Set the port as an edge-port to enable rapid transitions
P3(config-if)#interface xe10	Enter interface mode
P3(config-if)# switchport	Set the interface as Layer2 port
P3(config-if)# bridge-group 1 spanning-tree disable	Associate the interface with bridge group 1 and disable spanning tree
P3(config-if)# switchport mode trunk	Set the switching characteristics of this interface to trunk mode.
P3(config-if)# switchport trunk allowed vlan add 60,69	Enable VLAN's allowed on this interface.
P3(config-if)# switchport trunk native vlan 69	Configure native vlan
P3(config-if)# load-interval 30	Configure load period in multiple of 30 seconds
P3(config-if)# mtu 1600	Change interface mtu value
P3(config-if)# spanning-tree edgeport	Set the port as an edge-port to enable rapid transitions
P3(config-if)#interface xe15	Enter interface mode
P3(config-if)# switchport	Set the interface as Layer2 port
P3(config-if)# bridge-group 1 spanning-tree disable	Associate the interface with bridge group 1 and disable spanning tree
P3(config-if)# switchport mode trunk	Set the switching characteristics of this interface to trunk mode.
P3(config-if)# switchport trunk allowed vlan add 80,89	Enable VLAN's allowed on this interface.
P3(config-if)# switchport trunk native vlan 89	Configure native vlan
P3(config-if)# load-interval 30	Configure load period in multiple of 30 seconds
P3(config-if)# mtu 1600	Change interface mtu value
P3(config-if)# spanning-tree edgeport	Set the port as an edge-port to enable rapid transitions
P3(config-if)#router ospf 1	Enter ospf configuration mode
P3(config-router)# ospf router-id 5.5.5.5	Configure ospf router id

P3(config-router)# bfd all-interfaces	Enable bfd in all ospf interfaces
P3(config-router)# network 5.5.5.5/32 area 0.0.0.0	Define the Network on which OSPF runs and associate the area ID (area 0) with the interface.
P3(config-router)# network 15.1.1.0/24 area 0.0.0.0	Define the Network on which OSPF runs and associate the area ID (area 0) with the interface.
P3(config-router)# network 25.1.1.0/24 area 0.0.0.0	Define the Network on which OSPF runs and associate the area ID (area 0) with the interface.
P3(config-router)# network 35.1.1.0/24 area 0.0.0.0	Define the Network on which OSPF runs and associate the area ID (area 0) with the interface.
P3(config-router)# network 45.1.1.0/24 area 0.0.0.0	Define the Network on which OSPF runs and associate the area ID (area 0) with the interface.
P3(config-router)# network 56.1.1.0/24 area 0.0.0.0	Define the Network on which OSPF runs and associate the area ID (area 0) with the interface.
P3(config-router)#commit	Commit the candidate configuration to the running configuration

VTEP3

VTEP3#configure terminal	Enter configuration terminal
VTEP3(config)#hostname VTEP3	Configure hostname
VTEP3(config)#mac vrf vrf1	Configure mac vrf vrf1
VTEP3(config-vrf)# rd 6.6.6.6:11	Configure RD for vrf1
VTEP3(config-vrf)# route-target both 10.10.10.10:100	Configure RT for vrf1
VTEP3(config-vrf)#mac vrf vrf2	Configure mac vrf vrf2
VTEP3(config-vrf)# rd 6.6.6.6:12	Configure RD for vrf2
VTEP3(config-vrf)# route-target both 10.10.10.10:101	Configure RT for vrf2
VTEP3(config-vrf)# route-target both 10.10.10.10:102	Configure RT for vrf2
VTEP3(config-vrf)#bfd interval 3 minrx 3 multiplier 3	Configure bfd interval globally
VTEP3(config)#load-balance enable	Enable load balancing
VTEP3(config)#load-balance ipv4 dest-ipv4 src-ipv4	Enable load balnce based on souce and destination ip address
VTEP3(config)#hardware-profile filter egress-ipv4 enable	Enable hardware filter for egress ipv4
VTEP3(config)#hardware-profile filter vxlan enable	Enable vxlan-mh in hardware
VTEP3(config)# hardware-profile filter vxlan-mh enable	Enable evpn vxlan multihoming
VTEP3(config)#evpn vxlan multihoming enable	Enable vxlan in hardware
VTEP3(config)#hardware-profile statistics ac-lif enable	Enable statistics on vxlan access interface
VTEP3(config)#nvo vxlan enable	Enable vxlan
VTEP3(config)#qos enable	Enable qos
VTEP3(config)#qos statistics	Enable qos statistics

VTEP3(config)#bridge 1 protocol ieee vlan-bridge	Configure IEEE vlan bridge
VTEP3(config)#no bridge 1 spanning-tree enable	Disable spanning tree in bridge 1 globally
VTEP3(config)#no igmp snooping	Disable igmp snooping messages globally
VTEP3(config)#vlan database	Enter into the vlan database
VTEP3(config-vlan)# vlan 10-200 bridge 1 state enable	Configure vlan 10-200 and associate with bridge 1
VTEP3(config-vlan)#interface lo	Enter lo interface mode
VTEP3(config-if)# ip address 6.6.6.6/32 secondary	Assign loopback ip
VTEP3(config-if)#interface vlan1.80	Specify interface vlan1.80 to be configured.
VTEP3(config-if)# ip address 56.1.1.2/24	Assign ip address
VTEP3(config-if)# ip ospf cost 1	Change ospf cost of the link
VTEP3(config-if)#interface vlan1.90	Specify interface vlan1.90 to be configured.
VTEP3(config-if)# ip address 46.1.1.2/24	Assign ip address
VTEP3(config-if)# ip ospf cost 1	Change ospf cost of the link
VTEP3(config-if)#interface xe3	Enter interface mode
VTEP3(config-if)# switchport	Set the interface as Layer2 port
VTEP3(config-if)# bridge-group 1 spanning-tree disable	Associate the interface with bridge group 1 and disable spanning tree
VTEP3(config-if)# switchport mode trunk	Set the switching characteristics of this interface to trunk mode.
VTEP3(config-if)# switchport trunk allowed vlan add 90,99	Enable VLAN's allowed on this interface.
VTEP3(config-if)# switchport trunk native vlan 99	Configure native vlan
VTEP3(config-if)# load-interval 30	Configure load period in multiple of 30 seconds
VTEP3(config-if)# spanning-tree edgeport	Set the port as an edge-port to enable rapid transitions
VTEP3(config-if)#interface xe15	Enter interface mode
VTEP3(config-if)# switchport	Set the interface as Layer2 port
VTEP3(config-if)# bridge-group 1 spanning-tree disable	Associate the interface with bridge group 1 and disable spanning tree
VTEP3(config-if)# switchport mode trunk	Set the switching characteristics of this interface to trunk mode.
VTEP3(config-if)# switchport trunk allowed vlan add 80,89	Enable VLAN's allowed on this interface.
VTEP3(config-if)# switchport trunk native vlan 89	Configure native vlan
VTEP3(config-if)# load-interval 30	Configure load period in multiple of 30 seconds
VTEP3(config-if)# mtu 1600	Change interface mtu value
VTEP3(config-if)# spanning-tree edgeport	Set the port as an edge-port to enable rapid transitions
VTEP3(config-if)#interface xe45	Enter interface mode
VTEP3(config-if)# switchport	Set the interface as Layer2 port
VTEP3(config-if)# load-interval 30	Configure load period in multiple of 30 seconds

VTEP3(config-if)#interface xe46	Enter interface mode
VTEP3(config-if)# switchport	Set the interface as Layer2 port
VTEP3(config-if)# load-interval 30	Configure load period in multiple of 30 seconds
VTEP3(config-if)#router ospf 1	Enter ospf configuration mode
VTEP3(config-router)# ospf router-id 6.6.6.6	Configure ospf router id
VTEP3(config-router)# bfd all-interfaces	Enable bfd in all ospf interfaces
VTEP3(config-router)# network 6.6.6.6/32 area 0.0.0.0	Define the Network on which OSPF runs and associate the area ID (area 0) with the interface.
VTEP3(config-router)# network 46.1.1.0/24 area 0.0.0.0	Define the Network on which OSPF runs and associate the area ID (area 0) with the interface.
VTEP3(config-router)# network 56.1.1.0/24 area 0.0.0.0	Define the Network on which OSPF runs and associate the area ID (area 0) with the interface.
VTEP3(config-router)#router bgp 100	Enter address-family ipv4 unicast mode
VTEP3(config-router)# address-family ipv4 unicast	Add the lo network to bgp route
VTEP3(config-router)# network 6.6.6.6/32	Activate neighbors
VTEP3(config-router-af)# neighbor 1.1.1.1 activate	Activate neighbors
VTEP3(config-router-af)# neighbor 2.2.2.2 activate	Exit address-family mode.
VTEP3(config-router-af)#exit-address-family	Enter Router BGP mode and define the AS number 100.
VTEP3(config-router)# neighbor 1.1.1.1 remote-as 100	Configure bgp remote-as 100 with neighbor IP
VTEP3(config-router)# neighbor 1.1.1.1 update-source lo	Define BGP neighbors, to update the source routes with lo
VTEP3(config-router)# neighbor 2.2.2.2 remote-as 100	Configure bgp remote-as 100 with neighbor IP
VTEP3(config-router)# neighbor 2.2.2.2 update-source lo	Configure advertisement-interval as 0 for fast convergence for VTEP2
(config-router)#neighbor 2.2.2.2 advertisement-interval 0	Configure advertisement-interval as 0 for fast convergence for VTEP1
(config-router)#neighbor 1.1.1.1 advertisement-interval 0	Define BGP neighbors, to update the source routes with lo
VTEP3(config-router)# address-family l2vpn evpn	Enter in to bgp l2vpn evpn address-family
VTEP3(config-router-af)# neighbor 1.1.1.1 activate	Activate neighbors
VTEP3(config-router-af)# neighbor 2.2.2.2 activate	Activate neighbors
VTEP3(config-router-af)# exit-address- family	Exit from bgp l2vpn evpn address-family
VTEP3(config-router)#nvo vxlan vtep-ip- global 6.6.6.6	Configure vxlan global ip
VTEP3(config)#nvo vxlan id 1 ingress- replication inner-vid-disabled	Create vnid 1
VTEP3(config-nvo)# vxlan host-reachability- protocol evpn-bgp vrf1	Associate vnid with evpn and vrf1

VTEP3(config-nvo)#nvo vxlan id 1000 ingress-replication inner-vid-disabled	Create vnid 1000
VTEP3(config-nvo)# vxlan host-reachability-protocol evpn-bgp vrf2	Associate vnid with evpn and vrf2
VTEP3(config-nvo)#nvo vxlan access-if port-vlan xe45 3001	Create vxlan access port port-vlan
VTEP3(config-nvo-acc-if)# map vnid 1	Map the vnid to access-if
VTEP3(config-nvo-acc-if)#nvo vxlan access-if port xe46	Create vxlan access port
VTEP3(config-nvo-acc-if)# map vnid 1000	Map the vnid to access-if
VTEP3(config-nvo-acc-if)# commit	Commit the candidate configuration to the running configuration

SWITCH

SWITCH#configure terminal	Enter configuration terminal
SWITCH#(config)# bridge 1 protocol rstp vlan-bridge	Configure rstp vlan bridge
SWITCH#(config)#interface po1	Enter interface mode
SWITCH#(config-if)# switchport	Set the interface as Layer2 port
SWITCH#(config-if)# load-interval 30	Configure load period in multiple of 30 seconds
SWITCH#(config-if)#interface ce9/1	Enter interface mode
SWITCH#(config-if)# channel-group 1 mode active	Map this interface to po1
SWITCH#(config-if)#interface ce9/2	Enter interface mode
SWITCH#(config-if)# channel-group 1 mode active	Map this interface to po1
SWITCH#(config-if)#interface ce10/1	Enter interface mode
SWITCH#(config-if)# channel-group 1 mode active	Map this interface to po1
SWITCH#(config-if)#interface ce10/2	Enter interface mode
SWITCH#(config-if)# channel-group 1 mode active	Map this interface to po1
SWITCH#(config-if)#interface ce31/1	Set the port as an edge-port to enable rapid transitions
SWITCH#(config-if)# switchport	Enter interface mode
SWITCH#(config-if)# bridge-group 1 spanning-tree disable	Set the interface as Layer2 port
SWITCH#(config-if)# switchport mode trunk	Associate the interface with bridge group 1 and disable spanning tree
SWITCH#(config-if)# switchport trunk allowed vlan all	Set the switching characteristics of this interface to trunk mode.
SWITCH#(config-if)# load-interval 30	Configure native vlan
SWITCH#(config-if)# commit	Commit the candidate configuration to the running configuration

Validation

VTEP1#sh ip ospf neighbor

Total number of full neighbors: 3

OSPF process 1 VRF(default):

Neighbor ID Instance ID	Pri	State	Dead Time	Address	Interface	
2.2.2.2 0	1	Full/DR	00:00:30	12.1.1.2	vlan1.10	0
3.3.3.3 0	1	Full/DR	00:00:31	13.1.1.2	vlan1.20	0
4.4.4.4 0	1	Full/DR	00:00:33	14.1.1.2	vlan1.30	0

VTEP2#sh ip ospf neighbor

Total number of full neighbors: 3

OSPF process 1 VRF(default):

Neighbor ID Instance ID	Pri	State	Dead Time	Address	Interface	
1.1.1.1 0	1	Full/Backup	00:00:38	12.1.1.1	vlan1.10	
3.3.3.3 0	1	Full/DR	00:00:39	23.1.1.2	vlan1.40	0
4.4.4.4 0	1	Full/DR	00:00:39	24.1.1.2	vlan1.50	0

P1#sh ip ospf neighbor

Total number of full neighbors: 4

OSPF process 1 VRF(default):

Neighbor ID Instance ID	Pri	State	Dead Time	Address	Interface	
1.1.1.1 0	1	Full/Backup	00:00:39	13.1.1.1	vlan1.20	
2.2.2.2 0	1	Full/Backup	00:00:38	23.1.1.1	vlan1.40	
4.4.4.4 0	1	Full/DR	00:00:40	34.1.1.2	vlan1.100	0
5.5.5.5 0	1	Full/DR	00:00:36	35.1.1.2	vlan1.60	0

P2#sh ip ospf neighbor

Total number of full neighbors: 5

OSPF process 1 VRF(default):

Neighbor ID Instance ID	Pri	State	Dead Time	Address	Interface	
1.1.1.1 0	1	Full/Backup	00:00:30	14.1.1.1	vlan1.30	
2.2.2.2 0	1	Full/Backup	00:00:38	24.1.1.1	vlan1.50	
3.3.3.3 0	1	Full/Backup	00:00:33	34.1.1.1	vlan1.100	
5.5.5.5 0	1	Full/DR	00:00:30	45.1.1.2	vlan1.70	0
6.6.6.6 0	1	Full/DR	00:00:34	46.1.1.2	vlan1.90	0

P2#

```
P3#sh ip ospf neighbor
```

```
Total number of full neighbors: 3
```

```
OSPF process 1 VRF(default):
```

Neighbor ID Instance ID	Pri	State	Dead Time	Address	Interface	
3.3.3.3 0	1	Full/Backup	00:00:34	35.1.1.1	vlan1.60	
4.4.4.4 0	1	Full/Backup	00:00:34	45.1.1.1	vlan1.70	
6.6.6.6 0	1	Full/DR	00:00:33	56.1.1.2	vlan1.80	0

```
P3#
```

```
VTEP1#sh bgp l2vpn evpn summary
```

```
BGP router identifier 1.1.1.1, local AS number 100
```

```
BGP table version is 4
```

```
1 BGP AS-PATH entries
```

```
0 BGP community entries
```

Neighbor PfxRcd	AD	MACIP	V MCAST	AS	MsgRcv ESI	MsgSen PREFIX-ROUTE	TblVer	InQ	OutQ	Up/Down	State/
2.2.2.2 2	0	0	4 2	100 0	23 0	22	4	0	0	00:07:34	
6.6.6.6 2	0	0	4 2	100 0	21 0	22	4	0	0	00:07:34	

```
Total number of neighbors 2
```

```
Total number of Established sessions 2
```

```
VTEP1#
```

```
VTEP2#sh bgp l2vpn evpn summary
```

```
BGP router identifier 2.2.2.2, local AS number 100
```

```
BGP table version is 5
```

```
1 BGP AS-PATH entries
```

```
0 BGP community entries
```

Neighbor PfxRcd	AD	MACIP	V MCAST	AS	MsgRcv ESI	MsgSen PREFIX-ROUTE	TblVer	InQ	OutQ	Up/Down	State/
1.1.1.1 2	0	0	4 2	100 0	22 0	24	5	0	0	00:07:41	
6.6.6.6 2	0	0	4 2	100 0	24 0	27	5	0	0	00:08:51	

```
Total number of neighbors 2
```

```
Total number of Established sessions 2
```

```
VTEP2#
```

```
VTEP3#sh bgp l2vpn evpn summary
```

```
BGP router identifier 6.6.6.6, local AS number 100
```

```
BGP table version is 5
```

```
1 BGP AS-PATH entries
```

```
0 BGP community entries
```

Neighbor PfxRcd	AD	MACIP	V MCAST	AS	MsgRcv ESI	MsgSen PREFIX-ROUTE	TblVer	InQ	OutQ	Up/Down	State/
1.1.1.1			4	100	23	21	5	0	0	00:07:44	
2	0	0	2	0	0						
2.2.2.2			4	100	26	24	5	0	0	00:08:54	
2	0	0	2	0	0						

Total number of neighbors 2

Total number of Established sessions 2

VTEP3#

VTEP1#show nvo vxlan mac-table

```

=====
=====
                                     VxLAN MAC Entries
=====
=====

```

VNID Type	Interface	VlanId Status	Inner-VlanId	Mac-Addr AccessPortDesc	VTEP-Ip/ESI
1 Static	po1 Local	1000 -----	----	0000.1111.1111 -----	00:aa:22:33:44:55:66:00:00:00
1 Static	po1 Local	1000 -----	----	0000.1111.1112 -----	00:aa:22:33:44:55:66:00:00:00
1 Static	po1 Local	1000 -----	----	0000.1111.1113 -----	00:aa:22:33:44:55:66:00:00:00
1 Static	po1 Local	1000 -----	----	0000.1111.1114 -----	00:aa:22:33:44:55:66:00:00:00
1 Static	po1 Local	1000 -----	----	0000.1111.1115 -----	00:aa:22:33:44:55:66:00:00:00
1 Dynamic	po1 Local	1000 -----	----	a82b.b57c.4470 -----	00:aa:22:33:44:55:66:00:00:00
1000 Dynamic	---- Remote	-----	----	a82b.b57c.4476 -----	00:aa:22:33:44:55:66:00:00:00

Total number of entries are : 7

VTEP1#

VTEP2#sh nvo vxlan mac-table

```

=====
=====
                                     VxLAN MAC Entries
=====
=====

```

VNID Type	Interface	VlanId Status	Inner-VlanId	Mac-Addr AccessPortDesc	VTEP-Ip/ESI
1 Static	---- Remote	-----	----	0000.1111.1111 -----	00:aa:22:33:44:55:66:00:00:00

```

1      ----      ----      ----      0000.1111.1112 00:aa:22:33:44:55:66:00:00:00
Static Remote      -----
1      ----      ----      ----      0000.1111.1113 00:aa:22:33:44:55:66:00:00:00
Static Remote      -----
1      ----      ----      ----      0000.1111.1114 00:aa:22:33:44:55:66:00:00:00
Static Remote      -----
1      ----      ----      ----      0000.1111.1115 00:aa:22:33:44:55:66:00:00:00
Static Remote      -----
1      ----      ----      ----      a82b.b57c.4470 00:aa:22:33:44:55:66:00:00:00
Dynamic Remote     -----
1000   po1      2000   ----      a82b.b57c.4476 00:aa:22:33:44:55:66:00:00:00
Dynamic Local      -----

```

Total number of entries are : 7

VTEP2#

VTEP3#sh nvo vxlan mac-table

```

=====
VxLAN MAC Entries
=====
VNID      Interface  VlanId  Inner-VlanId  Mac-Addr      VTEP-Ip/ESI
Type                                           AccessPortDesc
-----
1      ----      ----      ----      0000.1111.1111 00:aa:22:33:44:55:66:00:00:00
Static Remote      -----
1      ----      ----      ----      0000.1111.1112 00:aa:22:33:44:55:66:00:00:00
Static Remote      -----
1      ----      ----      ----      0000.1111.1113 00:aa:22:33:44:55:66:00:00:00
Static Remote      -----
1      ----      ----      ----      0000.1111.1114 00:aa:22:33:44:55:66:00:00:00
Static Remote      -----
1      ----      ----      ----      0000.1111.1115 00:aa:22:33:44:55:66:00:00:00
Static Remote      -----
1      ----      ----      ----      a82b.b57c.4470 00:aa:22:33:44:55:66:00:00:00
Dynamic Remote     -----
1000   ----      ----      ----      a82b.b57c.4476 00:aa:22:33:44:55:66:00:00:00
Dynamic Remote     -----

```

Total number of entries are : 7

VTEP3#

VTEP1#show nvo vxlan access-if brief

Interface	Vlan	Inner vlan	Ifindex	Vnid	Admin status	Link status
xe46	---	---	500000	1	up	up
po1	2000	---	500001	1000	up	up
po1	2001	---	500002	1000	up	up

Total number of entries are 2

VTEP1#

VTEP2#show nvo vxlan access-if brief

Interface	Vlan	Inner vlan	Ifindex	Vnid	Admin status	Link status
xe47	---	---	500000	1	up	up
po1	2001	---	500001	1000	up	up
po1	2000	---	500002	1000	up	up

Total number of entries are 3

VTEP2#

VTEP3#show nvo vxlan access-if brief

Interface	Vlan	Inner vlan	Ifindex	Vnid	Admin status	Link status
xe45	3001	---	500000	1	up	up
xe46	---	---	500001	1000	up	up

Total number of entries are 2

VTEP3#

VTEP1#sh nvo vxlan tunnel

VxLAN Network tunnel Entries

Source	Destination	Status	Up/Down	Update
1.1.1.1	6.6.6.6	Installed	00:03:59	00:03:59
1.1.1.1	2.2.2.2	Installed	00:03:59	00:03:59

Total number of entries are 2

VTEP1#sh nvo vxlan

VxLAN Information

=====

Codes: NW - Network Port
 AC - Access Port
 (u) - Untagged

VNID Status	VNI-Name Src-Addr	VNI-Type Dst-Addr	Type	Interface	ESI	VLAN	DF-
1	----	L2	NW	----	----	----	--
--	1.1.1.1	6.6.6.6					
1	----	L2	NW	----	----	----	--
--	1.1.1.1	2.2.2.2					
1000	----	--	AC	po1	--- 00:aa:22:33:44:55:66:00:00:00	2000	DF
----	----	----					
1000	----	--	AC	po1	--- 00:aa:22:33:44:55:66:00:00:00	2001	DF
----	----	----					

```

1000  ---- L2      NW  ----  ----  ---- -
---   1.1.1.1      6.6.6.6
1000  ---- L2      NW  ----  ----  ---- -
---   1.1.1.1      2.2.2.2
1000  ----  --      AC  xe46  --- Single Homed Port ---  ---- -
---   ----          ----

```

Total number of entries are 10
VTEP1#

VTEP2#sh nvo vxlan tunnel

VxLAN Network tunnel Entries

Source	Destination	Status	Up/Down	Update
2.2.2.2	1.1.1.1	Installed	00:03:59	00:03:59
2.2.2.2	6.6.6.6	Installed	00:05:09	00:05:09

Total number of entries are 2

VTEP2#sh nvo vxlan

VxLAN Information

=====

Codes: NW - Network Port
AC - Access Port
(u) - Untagged

VNI-Status	VNI-Name Src-Addr	VNI-Type Dst-Addr	Type	Interface	ESI	VLAN	DF
1	----	L2	NW	----	----	----	----
--	2.2.2.2	1.1.1.1					
1	----	L2	NW	----	----	----	----
--	2.2.2.2	6.6.6.6					
1	----	--	AC	xe47	---	Single Homed Port	---
--	----	----					
1000	----	L2	NW	----	----	----	----
--	2.2.2.2	1.1.1.1					
1000	----	L2	NW	----	----	----	----
--	2.2.2.2	6.6.6.6					
1000 DF	----	--	AC	po1	---	00:aa:22:33:44:55:66:00:00:00	2001 NON-
DF	----	----					
1000 DF	----	--	AC	po1	---	00:aa:22:33:44:55:66:00:00:00	2000 NON-
DF	----	----					

Total number of entries are 11
VTEP2#

VTEP3#sh nvo vxlan tunnel

VxLAN Network tunnel Entries

Source	Destination	Status	Up/Down	Update
6.6.6.6	1.1.1.1	Installed	00:03:58	00:03:58
6.6.6.6	2.2.2.2	Installed	00:05:08	00:04:03

Total number of entries are 2

VTEP3#sh nvo vxlan

VxLAN Information

=====

Codes: NW - Network Port

AC - Access Port

(u) - Untagged

VNID	VNI-Name	VNI-Type	Type	Interface	ESI	VLAN	DF-Status
Src-Addr	Dst-Addr						
1	----	L2	NW	----	----	----	----
6.6.6.6	1.1.1.1						
1	----	L2	NW	----	----	----	----
6.6.6.6	2.2.2.2						
1	----	--	AC	xe45	---	Single Hommed port	---
----	----					3001	----
1000	----	L2	NW	----	----	----	----
6.6.6.6	1.1.1.1						
1000	----	L2	NW	----	----	----	----
6.6.6.6	2.2.2.2						
1000	----	--	AC	xe46	---	Single Homed Port	---
----	----						----

Total number of entries are 10

VTEP3#

CHAPTER 9 VxLAN-EVPN with IRB

Overview

An EVPN-based Integrated Routing and Bridging solution used for forwarding of intra-subnets and inter-subnets traffic. There are 2 modes of IRB.

Symmetric IRB

In this mode, both the ingress and egress VTEPs perform layer-2 and layer-3 lookups (switching and routing). In this case, a given VTEP needs to learn the ARP and MAC-address entries only for tenant systems (TSs) across the tenant VxLAN network belonging to VNIDs attached to that VTEP.

Asymmetric IRB

In this mode, the ingress VTEP perform layer-2 and layer-3 lookups and egress VTEPs perform layer-2 lookups only. The disadvantage of this mode is the need for each VTEP in the tenant network to be configured with all the VNIDs for that tenant irrespective of whether a given VTEP has TS attached for that VNID or not.

Three approaches are available to achieve IRB solution.

- Centralized Gateway
- Anycast Gateway
- Distributed Gateway

Topology

The procedures in this section use the topology in [Figure 9-10](#).

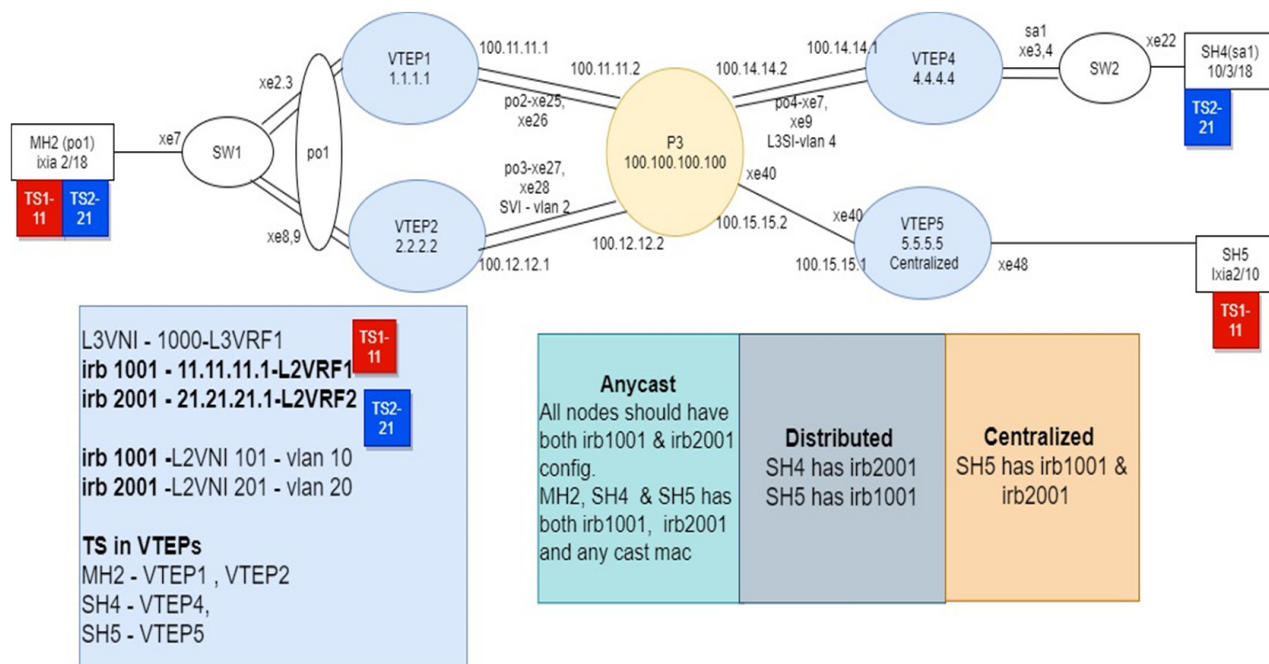

Figure 9-10: VxLAN EVPN IRB

Note: In the above topology TS1, TS2 are the tenant systems. The blue and red color denotes different subnets in the Tenant systems.

Base Configuration - L2 VxLAN

VTEP1

(Multi-homed group1) - Part of both Multi-homed with po1(MH2).

Hardware profile and generic configuration:

#configure terminal	Enter Configure mode.
(config)#hardware-profile filter vxlan enable	Enable hardware-profile filter for VxLAN.
(config)#hardware-profile filter vxlan-mh enable	Enable hardware-profile filter for VxLAN multi-homing.
(config)#hardware-profile filter egress-ipv4 enable	Enable hardware-profile filter for egress IPv4.
(config)#evpn vxlan multihoming enable	Enable Multihoming, save configs and reboot the board for multihoming to be effective
(config)#hardware-profile statistics ac-lif enable	Enable ac-lif for VxLAN access-if port counters
(config)#qos enable	Enabling QoS
(config)#commit	Commit the candidate configuration to running configuration

Interface and loopback configuration:

(config)#interface po1	Enter Interface mode for po1 (MH2)
(config-if)#switchport	Make it L2 interface
(config-if)# evpn multi-homed system-mac 0000.0000.2222	Configure system MAC as ESI value for Lag (po1) interface. VTEP1 and VTEP2 should have same ESI value
(config-if)#exit	Exit Interface mode and return to Configure mode.
(config)#interface xe2	Enter Interface mode for xe2
(config-if)#channel-group 1 mode active	Make it member port of po1
(config-if)#exit	Exit Interface mode and return to Configure mode.
(config)#interface xe3	Enter Interface mode for xe3
(config-if)#channel-group 1 mode active	Make it member port of po1
(config-if)#exit	Exit Interface mode and return to Configure mode.
(config)#interface lo	Enter Interface mode for lo
(config-if)#ip address 1.1.1.1/32 secondary	Configure loopback IP address as 1.1.1.1 for VTEP1
(config-if)#exit	Exit Interface mode and return to Configure mode.
(config)#interface po2	Enter Interface mode for po2
(config-if)#exit	Exit Interface mode and return to Configure mode.
(config)#interface xe25	Enter Interface mode for xe25
(config-if)#channel-group 2 mode active	Make it member port of po2
(config-if)#exit	Exit Interface mode and return to Configure mode.
(config)#interface xe26	Enter Interface mode for xe26
(config-if)#channel-group 2 mode active	Make it member port of po2
(config-if)#exit	Exit Interface mode and return to Configure mode.
(config)#interface po2	Enter Interface mode for po2
(config-if)#ip address 100.11.11.1/24	Configure IP address as 100.11.11.1 on network side of Spine-P3
(config-if)#exit	Exit Interface mode and return to Configure mode.
(config)#commit	Commit the candidate configuration to running configuration

OSPF configuration:

(config)#router ospf 100	Enter into router OSPF mode
(config-router)#ospf router-id 1.1.1.1	Configure router-id as 1.1.1.1 (lo IP address)
(config-router)#network 1.1.1.1/32 area 0.0.0.0	Add 1.1.1.1 (lo IP address) network into area 0
(config-router)#network 100.11.11.0/24 area 0.0.0.0	Add 100.11.11.0 (Spine-P3) network into area 0
(config-router)#bfd all-interfaces	Enabling BFD on all OSPF interface for fast convergence
(config-if)#exit	Exit Interface mode and return to Configure mode.
(config)#commit	Commit the candidate configuration to running configuration

BGP configuration:

(Config)#router bgp 5000	Enter into Router BGP mode
(config-router)#bgp router-id 1.1.1.1	Configure router-id as 1.1.1.1 (lo IP address)
(config-router)#neighbor 2.2.2.2 remote-as 5000	Specify a VTEP2 loopback IP address and remote-as defined
(config-router)#neighbor 2.2.2.2 update-source lo	Configure update as loopback for VTEP2
(config-router)#neighbor 2.2.2.2 advertisement-interval 0	Configure advertisement-interval as 0 for fast convergence for VTEP2
(config-router)#neighbor 4.4.4.4 remote-as 5000	Specify a VTEP4 loopback IP address and remote-as defined
(config-router)#neighbor 4.4.4.4 update-source lo	Configure update as loopback for VTEP4
(config-router)#neighbor 4.4.4.4 advertisement-interval 0	Configure advertisement-interval as 0 for fast convergence for VTEP4
(config-router)#neighbor 5.5.5.5 remote-as 5000	Specify a VTEP5 loopback IP address and remote-as defined
(config-router)#neighbor 5.5.5.5 update-source lo	Configure update as loopback for VTEP5
(config-router)#neighbor 5.5.5.5 advertisement-interval 0	Configure advertisement-interval as 0 for fast convergence for VTEP5
(config-router)#address-family l2vpn evpn	Enter into L2VPN EVPN address family mode
(config-router-af)#neighbor 2.2.2.2 activate	Activate 2.2.2.2(VTEP2) into L2VPN EVPN address family mode
(config-router-af)#neighbor 4.4.4.4 activate	Activate 3.3.3.3(VTEP4) into L2VPN EVPN address family mode
(config-router-af)#neighbor 5.5.5.5 activate	Activate 5.5.5.5(VTEP5) into L2VPN EVPN address family mode
(config-router-af)#exit-address-family	Exit from L2VPN address family mode
(config-router)#exit	Exit from Router BGP mode and enter into config mode
(config)#commit	Commit the candidate configuration to running configuration

L2 MAC VRF Configuration:

(config)#mac vrf L2VRF1	Create MAC routing/forwarding instance with L2VRF1 name and enter into VRF mode
(config-vrf)#rd 1.1.1.1:11	Assign RD value
(config-vrf)#description MAC VRF RED	Give description to L2VRF1 as RED
(config-vrf)#route-target both 9.9.9.9:100	Assign route-target value for same for import and export. Should be same on all node for L2VRF1
(config-vrf)#exit	Exit from VRF mode
(config)#mac vrf L2VRF2	Create MAC routing/forwarding instance with L2VRF2 name and enter into VRF mode
(config-vrf)#rd 1.1.1.1:21	Assign RD value
(config-vrf)#route-target both 90.90.90.90:100	Assign route-target value for same for import and export

(config-vrf)#description MAC VRF BLUE	Give description to L2VRF2 as BLUE
(config-vrf)#exit	Exit from VRF mode
(config)#commit	Commit the candidate configuration to running configuration

L2 VxLAN configuration:

(config)#nvo vxlan enable	Enable VxLAN
(config)#evpn esi hold-time 90	Configure ESI hold time to allow tunnel to come up at the time of VxLAN initialization before making the ESI up. It should be same on both VTEP1 and VTEP2
(config)#nvo vxlan vtep-ip-global 1.1.1.1	Configure Source vtep-ip-global configuration - Use loopback IP address
(config)#nvo vxlan id 101 ingress-replication inner-vid-disabled	Configure VxLAN Network identifier with/without inner-vid-disabled configure and enter into VxLAN tenant mode
(config-nvo)#vxlan host-reachability-protocol evpn-bgp L2VRF1	Assign VRF for EVPN-BGP to carry EVPN route
(config-nvo)#vni-name VNI-101	Configure VNI name as VNI-101
(config-nvo)#exit	Exit from VxLAN tenant mode and enter into configuration mode.
(config)#nvo vxlan id 201 ingress-replication inner-vid-disabled	Configure VxLAN Network identifier with/without inner-vid-disabled configure and enter into VxLAN tenant mode
(config-nvo)#vxlan host-reachability-protocol evpn-bgp L2VRF2	Assign VRF for EVPN-BGP to carry EVPN route
(config-nvo)#vni-name VNI-201	Configure VNI name as VNI-201
(config-nvo)#exit	Exit from VxLAN tenant mode and enter into configuration mode.
(config)#commit	Commit the candidate configuration to running configuration
(config)#nvo vxlan access-if port-vlan po1 10	Enable port-VLAN mapping i.e. access port to outer-VLAN (SVLAN) - Multihomed access port
(config-nvo-acc-if)#map vnid 101	Map VxLAN Identified to access-port for VxLAN
(config-nvo-acc-if)# mac 0000.2222.1010 ip 11.11.11.51	Configure static MAC-IP
(config-nvo-acc-if)#exit	Exit from VxLAN access-interface mode and enter into configuration mode
(config)#nvo vxlan access-if port-vlan po1 20	Enable port-VLAN mapping i.e. access port to outer-VLAN (SVLAN) - Multihomed access port
(config-nvo-acc-if)#map vnid 201	Map VxLAN Identified to access-port for VxLAN
(config-nvo-acc-if)# mac 0000.2222.1020 ip 21.21.21.51	Configure static MAC-IP
(config-nvo-acc-if)#exit	Exit from VxLAN access-interface mode and enter into configuration mode
(config)#exit	Exit from configuration mode
(config)#commit	Commit the candidate configuration to running configuration

VTEP2

(Multi-homed group1) - Part of both Multi-homed with po1(MH1).

Hardware profile and generic configuration:

#configure terminal	Enter Configure mode.
(config)#hardware-profile filter vxlan enable	Enable hardware-profile filter for VxLAN.
(config)#hardware-profile filter vxlan-mh enable	Enable hardware-profile filter for VxLAN multi-homing.
(config)#hardware-profile filter egress-ipv4 enable	Enable hardware-profile filter for egress IPv4.
(config)#evpn vxlan multihoming enable	Enable Multihoming, save configs and reboot the board for multihoming to be effective
(config)#hardware-profile statistics ac-lif enable	Enable ac-lif for VxLAN access-if port counters
(config)#qos enable	Enabling QoS
(config)#commit	Commit the candidate configuration to running configuration

Interface and loopback configuration:

(config)#interface po1	Enter Interface mode for po1 (MH2)
(config-if)#switchport	Make it L2 interface
(config-if)# evpn multi-homed system-mac 0000.0000.2222	Configure system MAC as ESI value for Lag (po1) interface. VTEP1 and VTEP2 should have same ESI value
(config-if)#exit	Exit Interface mode and return to Configure mode.
(config)#interface xe8	Enter Interface mode for xe2
(config-if)#channel-group 1 mode active	Make it member port of po1
(config-if)#exit	Exit Interface mode and return to Configure mode.
(config)#interface xe9	Enter Interface mode for xe3
(config-if)#channel-group 1 mode active	Make it member port of po1
(config-if)#exit	Exit Interface mode and return to Configure mode.
(config)#interface lo	Enter Interface mode for lo
(config-if)#ip address 2.2.2.2/32 secondary	Configure loopback IP address as 2.2.2.2 for VTEP2
(config-if)#exit	Exit Interface mode and return to Configure mode.
(config)#interface po3	Enter Interface mode for po3
(config)#i switchport	Configure po3 as L2 interface
(config-if)#exit	Exit Interface mode and return to Configure mode.
(config)#interface xe27	Enter Interface mode for xe27
(config-if)#channel-group 3 mode active	Make it member port of po3
(config-if)#exit	Exit Interface mode and return to Configure mode.
(config)#interface xe28	Enter Interface mode for xe28
(config-if)#channel-group 3 mode active	Make it member port of po3
(config-if)#exit	Exit Interface mode and return to Configure mode.
(config)# bridge 1 protocol rstp vlan-bridge	Configure bridge 1
(config)# vlan database	Enter into VLAN database mode
(config)#vlan 2 bridge 1 state enable	Configure VLAN 2 as part of bridge 1

(config)#interface po3	Enter Interface mode for po3
(config-if)# bridge-group 1	Configure bridge 1 for po3
(config-if)# switchport mode trunk	Switchport mode as trunk
(config-if)# switchport trunk allowed vlan add 2	Trunk allowed VLAN 2
(config-if)#exit	Exit Interface mode and return to Configure mode.
(config) interface vlan1.2	Enter into SVI port VLAN1.2
(config-if)#ip address 100.12.12.1/24	Configure IP address as 100.12.12.1 on network side of Spine-P3
(config-if)#exit	Exit Interface mode and return to Configure mode.
(config)#commit	Commit the candidate configuration to running configuration

OSPF configuration:

(config)#router ospf 100	Enter into router OSPF mode
(config-router)#ospf router-id 2.2.2.2	Configure router-id as 2.2.2.2 (lo IP address)
(config-router)#network 2.2.2.2/32 area 0.0.0.0	Add 2.2.2.2 (lo IP address) network into area 0
(config-router)#network 100.12.12.0/24 area 0.0.0.0	Add 100.12.12.0(Spine-P3) network into area 0
(config-router)#bfd all-interfaces	Enabling bfd on all ospf interface for fast convergence
(config-if)#exit	Exit Interface mode and return to Configure mode.
(config)#commit	Commit the candidate configuration to running configuration

BGP configuration:

(Config)#router bgp 5000	Enter into Router BGP mode
(config-router)#bgp router-id 2.2.2.2	Configure router-id as 2.2.2.2 (lo IP address)
(config-router)#neighbor 1.1.1.1 remote-as 5000	Specify a VTEP1 loopback IP address and remote-as defined
(config-router)#neighbor 1.1.1.1 update-source lo	Configure update as loopback for VTEP1
(config-router)#neighbor 1.1.1.1 advertisement-interval 0	Configure advertisement-interval as 0 for fast convergence for VTEP1
(config-router)#neighbor 4.4.4.4 remote-as 5000	Specify a VTEP4 loopback IP address and remote-as defined
(config-router)#neighbor 4.4.4.4 update-source lo	Configure update as loopback for VTEP4
(config-router)#neighbor 4.4.4.4 advertisement-interval 0	Configure advertisement-interval as 0 for fast convergence for VTEP4
(config-router)#neighbor 5.5.5.5 remote-as 5000	Specify a VTEP5 loopback IP address and remote-as defined
(config-router)#neighbor 5.5.5.5 update-source lo	Configure update as loopback for VTEP5
(config-router)#neighbor 5.5.5.5 advertisement-interval 0	Configure advertisement-interval as 0 for fast convergence for VTEP5
(config-router)#address-family l2vpn evpn	Enter into L2VPN EVPN address family mode

(config-router-af)#neighbor 1.1.1.1 activate	Activate 1.1.1.1(VTEP1) into L2VPN EVPN address family mode
(config-router-af)#neighbor 4.4.4.4 activate	Activate 4.4.4.4(VTEP4) into L2VPN EVPN address family mode
(config-router-af)#neighbor 5.5.5.5 activate	Activate 5.5.5.5(VTEP5) into L2VPN EVPN address family mode
(config-router-af)#exit-address-family	Exit from L2VPN address family mode
(config-router)#exit	Exit from Router BGP mode and enter into config mode
(config)#commit	Commit the candidate configuration to running configuration

VRF Configuration:

(config)#mac vrf L2VRF1	Create MAC routing/forwarding instance with L2VRF1 name and enter into VRF mode
(config-vrf)#rd 2.2.2.2:11	Assign RD value
(config-vrf)#description MAC VRF RED	Give description to L2VRF1 as RED
(config-vrf)#route-target both 9.9.9.9:100	Assign route-target value for same for import and export. Should be same on all node for L2VRF1
(config-vrf)#exit	Exit from VRF mode
(config)#mac vrf L2VRF2	Create MAC routing/forwarding instance with L2VRF2 name and enter into VRF mode
(config-vrf)#rd 2.2.2.2:21	Assign RD value
(config-vrf)#route-target both 90.90.90.90:100	Assign route-target value for same for import and export
(config-vrf)#description MAC VRF BLUE	Give description to L2VRF2 as BLUE
(config-vrf)#exit	Exit from VRF mode
(config)#commit	Commit the candidate configuration to running configuration

VxLAN configuration:

(config)#nvo vxlan enable	Enable VxLAN
(config)#evpn esi hold-time 90	Configure ESI hold time to allow tunnel to come up at the time of vxlan initialization before making the ESI up.It should be same on both VTEP1 and VTEP2
(config)#nvo vxlan vtep-ip-global 2.2.2.2	Configure Source vtep-IP-global configuration - Use loopback IP address
(config)#nvo vxlan id 101 ingress-replication inner-vid-disabled	Configure VxLAN Network identifier with/without inner-vid-disabled configure and enter into VxLAN tenant mode
(config-nvo)#vxlan host-reachability-protocol evpn-bgp L2VRF1	Assign VRF for EVPN-BGP to carry EVPN route
(config-nvo)# vni-name VNI-101	Configure VNI name as VNI-101
(config-nvo)#exit	Exit from VxLAN tenant mode and enter into configuration mode.
(config)#commit	Commit the candidate configuration to running configuration
(config)#nvo vxlan id 201 ingress-replication inner-vid-disabled	Configure VxLAN Network identifier with/without inner-vid-disabled configure and enter into VxLAN tenant mode

(config-nvo)#vxlan host-reachability-protocol evpn-bgp L2VRF2	Assign VRF for EVPN-BGP to carry EVPN route
(config-nvo)#vni-name VNI-201	Configure VNI name as VNI-201
(config-nvo)#exit	Exit from VxLAN tenant mode and enter into configuration mode.
(config)#nvo vxlan access-if port-vlan po1 10	Enable port-VLAN mapping i.e. access port to outer-vlan (SVLAN) - Multihomed access port
(config-nvo-acc-if)#map vnid 101	Map VxLAN Identified to access-port for VxLAN
(config-nvo-acc-if)#mac 0000.2222.1010 ip 11.11.11.51	Configure static MAC-IP
(config-nvo-acc-if)#exit	Exit from VxLAN access-interface mode and enter into configuration mode
(config)#nvo vxlan access-if port-vlan po1 20	Enable port-VLAN mapping i.e. access port to outer-VLAN (SVLAN) - Multihomed access port
(config-nvo-acc-if)#map vnid 201	Map VxLAN Identified to access-port for VxLAN
(config-nvo-acc-if)#mac 0000.2222.1020 ip 21.21.21.51	Configure static MAC-IP
(config-nvo-acc-if)#exit	Exit from VxLAN access-interface mode and enter into configuration mode
(config)#commit	Commit the candidate configuration to running configuration

VTEP4

Single Home -SH5.

Hardware profile and generic configuration:

#configure terminal	Enter Configure mode.
(config)#hardware-profile filter vxlan enable	Enable hardware-profile filter for VxLAN.
(config)#hardware-profile filter egress-ipv4 enable	Enable hardware-profile filter for egress IPv4.
(config)#hardware-profile statistics ac-lif enable	Enable ac-lif for vxlan access-if port counters
(config)#qos enable	Enabling qos
(config)#commit	Commit the candidate configuration to running configuration

Interface and loopback configuration:

(config)#interface sa1	Enter Interface mode for sa1 (SH5)
(config-if)#switchport	Make it L2 interface
(config-if)#exit	Exit Interface mode and return to Configure mode.
(config)#interface lo	Enter Interface mode for lo
(config-if)#ip address 4.4.4.4/32 secondary	Configure loopback IP address as 4.4.4.4 for VTEP4
(config-if)#exit	Exit Interface mode and return to Configure mode.
(config)#interface po4	Enter Interface mode for po4
(config-if)#exit	Exit Interface mode and return to Configure mode.

(config)#interface xe7	Enter Interface mode for xe7
(config-if)#channel-group 4 mode active	Make it member port of po4
(config-if)#exit	Exit Interface mode and return to Configure mode.
(config)#interface xe9	Enter Interface mode for xe9
(config-if)#channel-group 4 mode active	Make it member port of po4
(config-if)#exit	Exit Interface mode and return to Configure mode.
(config) interface po4.4	Enter L3SI po4.4
(config-if)# encapsulation dot1q 4	Encapsulation as dot1q with VLAN 4
(config-if)#ip address 100.14.14.1/24	Configure IP address as 100.14.14.1 on network side of Spine-P3
(config-if)#exit	Exit Interface mode and return to Configure mode.
(config)#commit	Commit the candidate configuration to running configuration

OSPF configuration:

(config)#router ospf 100	Enter into router OSPF mode
(config-router)#ospf router-id 4.4.4.4	Configure router-id as 4.4.4.4 (lo IP address)
(config-router)#network 4.4.4.4/32 area 0.0.0.0	Add 4.4.4.4 (lo IP address) network into area 0
(config-router)#network 100.14.14.0/24 area 0.0.0.0	Add 100.14.14.0(Spine-P3) network into area 0
(config-router)#bfd all-interfaces	Enabling bfd on all ospf interface for fast convergence
(config-if)#exit	Exit Interface mode and return to Configure mode.
(config)#commit	Commit the candidate configuration to running configuration

BGP configuration:

(Config)#router bgp 5000	Enter into Router BGP mode
(config-router)#bgp router-id 4.4.4.4	Configure router-id as 4.4.4.4 (lo IP address)
(config-router)#neighbor 1.1.1.1 remote-as 5000	Specify a VTEP1 loopback IP address and remote-as defined
(config-router)#neighbor 1.1.1.1 update-source lo	Configure update as loopback for VTEP1
(config-router)#neighbor 1.1.1.1 advertisement-interval 0	Configure advertisement-interval as 0 for fast convergence for VTEP1
(config-router)#neighbor 2.2.2.2 remote-as 5000	Specify a VTEP2 loopback IP address and remote-as defined
(config-router)#neighbor 2.2.2.2 update-source lo	Configure update as loopback for VTEP2
(config-router)#neighbor 2.2.2.2 advertisement-interval 0	Configure advertisement-interval as 0 for fast convergence for VTEP2
(config-router)#neighbor 5.5.5.5 remote-as 5000	Specify a VTEP5 loopback IP address and remote-as defined
(config-router)#neighbor 5.5.5.5 update-source lo	Configure update as loopback for VTEP5

(config-router)#neighbor 5.5.5.5 advertisement-interval 0	Configure advertisement-interval as 0 for fast convergence for VTEP5
(config-router)#address-family l2vpn evpn	Enter into L2VPN EVPN address family mode
(config-router-af)#neighbor 1.1.1.1 activate	Activate 1.1.1.1(VTEP1) into L2VPN EVPN address family mode
(config-router-af)#neighbor 2.2.2.2 activate	Activate 2.2.2.2(VTEP2) into L2VPN EVPN address family mode
(config-router-af)#neighbor 5.5.5.5 activate	Activate 5.5.5.5(VTEP5) into L2VPN EVPN address family mode
(config-router-af)#exit-address-family	Exit from L2VPN address family mode
(config-router)#exit	Exit from Router BGP mode and enter into config mode
(config)#commit	Commit the candidate configuration to running configuration

VRF Configuration:

(config)#mac vrf L2VRF1	Create MAC routing/forwarding instance with L2VRF1 name and enter into VRF mode
(config-vrf)#rd 4.4.4.4:11	Assign RD value
(config-vrf)#description MAC VRF RED	Give description to L2VRF1 as RED
(config-vrf)#route-target both 9.9.9.9:100	Assign route-target value for same for import and export. Should be same on all node for L2VRF1
(config-vrf)#exit	Exit from VRF mode
(config)#mac vrf L2VRF2	Create MAC routing/forwarding instance with L2VRF2 name and enter into VRF mode
(config-vrf)#rd 4.4.4.4:21	Assign RD value
(config-vrf)#route-target both 90.90.90.90:100	Assign route-target value for same for import and export
(config-vrf)#description MAC VRF BLUE	Give description to L2VRF2 as BLUE
(config-vrf)#exit	Exit from VRF mode
(config)#commit	Commit the candidate configuration to running configuration

VxLAN configuration:

(config)#nvo vxlan enable	Enable VxLAN
(config)#nvo vxlan vtep-ip-global 4.4.4.4	Configure Source vtep-IP-global configuration. Use loopback IP address
(config)#nvo vxlan id 101 ingress-replication inner-vid-disabled	Configure VxLAN Network identifier with/without inner-vid-disabled configure and enter into VxLAN tenant mode
(config-nvo)#vxlan host-reachability-protocol evpn-bgp L2VRF1	Assign VRF for EVPN-BGP to carry EVPN route
(config-nvo)# vni-name VNI-101	Configure VNI name as VNI-101
(config-nvo)#exit	Exit from VxLAN tenant mode and enter into configuration mode.
(config)#nvo vxlan id 201 ingress-replication inner-vid-disabled	Configure VxLAN Network identifier with/without inner-vid-disabled configure and enter into VxLAN tenant mode
(config-nvo)#vxlan host-reachability-protocol evpn-bgp L2VRF2	Assign VRF for EVPN-BGP to carry EVPN route

(config-nvo)# vni-name VNI-201	Configure VNI name as VNI-201
(config-nvo)#exit	Exit from VxLAN tenant mode and enter into configuration mode.
(config)#commit	Commit the candidate configuration to running configuration
(config)# nvo vxlan access-if port-vlan sa1 20	Enable port-VLAN mapping i.e. access port to outer-vlan (SVLAN) - Multihomed access port
(config-nvo-acc-if)#map vnid 201	Map VxLAN Identified to access-port for VxLAN
(config-nvo-acc-if)# mac 0000.5555.1020 ip 21.21.21.101	Configure static MAC-IP
(config-nvo-acc-if)#exit	Exit from VxLAN access-interface mode and enter into configuration mode
(config)#exit	Exit from configuration mode
(config)#commit	Commit the candidate configuration to running configuration

VTEP5

Single Home -SH3

Hardware profile and generic configuration:

#configure terminal	Enter Configure mode.
(config)#hardware-profile filter vxlan enable	Enable hardware-profile filter for VxLAN.
(config)#hardware-profile filter egress-ipv4 enable	Enable hardware-profile filter for egress IPv4.
(config)#hardware-profile statistics ac-lif enable	Enable ac-lif for vxlan access-if port counters
(config)#qos enable	Enabling qos
(config)#commit	Commit the candidate configuration to running configuration

Interface and loopback configuration:

(config)#interface xe48	Enter Interface mode for xe48 (SH3)
(config-if)#switchport	Make it L2 interface
(config-if)#exit	Exit Interface mode and return to Configure mode.
(config)#interface lo	Enter Interface mode for lo
(config-if)#ip address 5.5.5.5/32 secondary	Configure loopback IP address as 5.5.5.5 for VTEP5
(config-if)#exit	Exit Interface mode and return to Configure mode.
(config) interface xe40	Enter interface mode
(config-if)#ip address 100.15.15.1/24	Configure IP address as 100.15.15.1 on network side of Spine-P3
(config-if)#exit	Exit Interface mode and return to Configure mode.
(config)#commit	Commit the candidate configuration to running configuration

OSPF configuration:

(config)#router ospf 100	Enter into router OSPF mode
(config-router)#ospf router-id 5.5.5.5	Configure router-id as 5.5.5.5 (lo IP address)
(config-router)#network 5.5.5.5/32 area 0.0.0.0	Add 5.5.5.5 (lo IP address) network into area 0
(config-router)#network 100.15.15.0/24 area 0.0.0.0	Add 100.15.15.0(Spine-P3) network into area 0
(config-router)#bfd all-interfaces	Enabling bfd on all ospf interface for fast convergence
(config-if)#exit	Exit Interface mode and return to Configure mode.
(config)#commit	Commit the candidate configuration to running configuration

BGP configuration:

(Config)#router bgp 5000	Enter into Router BGP mode
(config-router)#bgp router-id 5.5.5.5	Configure router-id as 5.5.5.5(lo IP address)
(config-router)#neighbor 1.1.1.1 remote-as 5000	Specify a VTEP1 loopback IP address and remote-as defined
(config-router)#neighbor 1.1.1.1 update-source lo	Configure update as loopback for VTEP1
(config-router)#neighbor 1.1.1.1 advertisement-interval 0	Configure advertisement-interval as 0 for fast convergence for VTEP1
(config-router)#neighbor 2.2.2.2 remote-as 5000	Specify a VTEP2 loopback IP address and remote-as defined
(config-router)#neighbor 2.2.2.2 update-source lo	Configure update as loopback for VTEP2
(config-router)#neighbor 2.2.2.2 advertisement-interval 0	Configure advertisement-interval as 0 for fast convergence for VTEP2
(config-router)#neighbor 4.4.4.4 remote-as 5000	Specify a VTEP4 loopback IP address and remote-as defined
(config-router)#neighbor 4.4.4.4 update-source lo	Configure update as loopback for VTEP4
(config-router)#neighbor 4.4.4.4 advertisement-interval 0	Configure advertisement-interval as 0 for fast convergence for VTEP4
(config-router)#address-family l2vpn evpn	Enter into L2VPN EVPN address family mode
(config-router-af)#neighbor 1.1.1.1 activate	Activate 1.1.1.1(VTEP1) into L2VPN EVPN address family mode
(config-router-af)#neighbor 2.2.2.2 activate	Activate 2.2.2.2(VTEP2) into L2VPN EVPN address family mode
(config-router-af)#neighbor 4.4.4.4 activate	Activate 4.4.4.4(VTEP4) into L2VPN EVPN address family mode
(config-router-af)#exit-address-family	Exit from L2VPN address family mode
(config-router)#exit	Exit from Router BGP mode and enter into config mode
(config)#commit	Commit the candidate configuration to running configuration

VRF Configuration:

(config)#mac vrf L2VRF1	Create MAC routing/forwarding instance with L2VRF1 name and enter into VRF mode
(config-vrf)#rd 5.5.5.5:11	Assign RD value
(config-vrf)#description MAC VRF RED	Give description to L2VRF1 as RED
(config-vrf)#route-target both 9.9.9.9:100	Assign route-target value for same for import and export. Should be same on all node for L2VRF1
(config-vrf)#exit	Exit from VRF mode
(config)#mac vrf L2VRF2	Create MAC routing/forwarding instance with L2VRF2 name and enter into VRF mode
(config-vrf)#rd 5.5.5.5:21	Assign RD value
(config-vrf)#route-target both 90.90.90.90:100	Assign route-target value for same for import and export
(config-vrf)#description MAC VRF BLUE	Give description to L2VRF2 as BLUE
(config-vrf)#exit	Exit from VRF mode
(config)#commit	Commit the candidate configuration to running configuration

VxLAN configuration:

(config)#nvo vxlan enable	Enable VxLAN
(config)#nvo vxlan vtep-ip-global 5.5.5.5	Configure Source vtep-IP-global configuration. Use loopback IP address
(config)#nvo vxlan id 101 ingress-replication inner-vid-disabled	Configure VxLAN Network identifier with/without inner-vid-disabled configure and enter into VxLAN tenant mode
(config-nvo)#vxlan host-reachability-protocol evpn-bgp L2VRF1	Assign VRF for EVPN-BGP to carry EVPN route
(config-nvo)# vni-name VNI-101	Configure VNI name as VNI-101
(config-nvo)#exit	Exit from VxLAN tenant mode and enter into configuration mode.
(config)#nvo vxlan id 201 ingress-replication inner-vid-disabled	Configure VxLAN Network identifier with/without inner-vid-disabled configure and enter into VxLAN tenant mode
(config-nvo)#vxlan host-reachability-protocol evpn-bgp L2VRF2	Assign vrf for EVPN-BGP to carry EVPN route
(config-nvo)# vni-name VNI-201	Configure VNI name as VNI-201
(config-nvo)#exit	Exit from VxLAN tenant mode and enter into configuration mode.
(config)# nvo vxlan access-if port-vlan xe48 10	Enable port-VLAN mapping i.e. access port to outer-vlan (SVLAN) - Multihomed access port
(config-nvo-acc-if)#map vnid 101	Map VxLAN Identified to access-port for VxLAN
(config-nvo-acc-if)# mac 0000.4444.1010 ip 11.11.11.201	Configure static MAC-IP
(config-nvo-acc-if)#exit	Exit from VxLAN access-interface mode and enter into configuration mode
(config)#commit	Commit the candidate configuration to running configuration

Switch1 (MH2)

Multihomed to 2-VTEPs (VTEP1 and VTEP2). It acts as Tenant system for VLAN1.20.

#configure terminal	Enter Configure mode.
(config)# bridge 1 protocol rstp vlan-bridge	Configure RSTP VLAN bridge
(config)# vlan database	Enter into VLAN database mode
(config)#vlan 2-20 bridge 1 state enable	Configure VLANs from 2-20 and associate with bridge 1
(config)#commit	Commit the candidate configuration to running configuration
(config)#interface xe7	Enter Interface mode for xe7
(config-if)#switchport	Make as L2 port by configuring switchport
(config-if)#bridge-group 1	Associate bridge 1 into interface
(config-if)# bridge-group 1 spanning-tree disable	Configure interface as STP disable
(config-if)# switchport mode trunk	Mode as trunk
(config-if)# switchport trunk allowed vlan add 2,10,20	Trunk allowed VLAN as 2.10.20
(config-if)#switchport trunk native vlan 2	Native VLAN as 2
(config-if)#exit	Exit Interface mode and return to Configure mode.
(config)#interface po1	Enter Interface mode for po1
(config-if)#switchport	Make po1 as L2 port by configuring switchport
(config-if)#bridge-group 1	Associate po1 to bridge 1
(config-if)# bridge-group 1 spanning-tree disable	Configure po1 as STP disable
(config-if)# switchport mode trunk	Mode as trunk
(config-if)# switchport trunk allowed vlan add 2,10,20	Trunk allowed VLAN as 2.10.20
(config-if)#switchport trunk native vlan 2	Native VLAN as 2
(config-if)#exit	Exit Interface mode and return to Configure mode.
(config)#interface xe3	Enter Interface mode for xe3
(config-if)#channel-group 1 mode active	Make it member port of po1
(config)#interface xe4	Enter Interface mode for xe4
(config-if)#channel-group 1 mode active	Make it member port of po1
(config)#exit	Exit from configuration mode
(config)#interface xe9	Enter Interface mode for xe9
(config-if)#channel-group 1 mode active	Make it member port of po1
(config)#interface xe10	Enter Interface mode for xe10
(config-if)#channel-group 1 mode active	Make it member port of po1
(config)#exit	Exit from configuration mode
(config)#interface vlan1.20	Enter Interface mode for VLAN1.20
(config-if)# ip address 21.21.21.2/24	Configure IP address
(config-if)#ipv6 address 21:21::21:2/48	Configure IPv6 address

(config-if)#exit	Exit from configuration mode
(config)#commit	Commit the candidate configuration to running configuration

Switch2 (SH5)

#configure terminal	Enter Configure mode.
(config)# bridge 1 protocol rstp vlan-bridge	Configure RSTP VLAN bridge
(config)# vlan database	
(config)#vlan 2-20 bridge 1 state enable	Configure VLANs from 2-20 and associate with bridge 1
(config)#commit	Commit the candidate configuration to running configuration
(config)#interface xe22	Enter Interface mode for xe22
(config-if)#switchport	Make xe22 as L2 port by configuring switchport
(config-if)#bridge-group 1	Associate xe22 to bridge 1
(config-if)# bridge-group 1 spanning-tree disable	Configure xe22 as STP disable
(config-if)# switchport mode trunk	Mode as trunk
(config-if)# switchport trunk allowed vlan add 6,10,20	Trunk allowed VLAN as 6,.10 &.20
(config-if)#switchport trunk native vlan 6	Native VLAN as 6
(config-if)#exit	Exit Interface mode and return to Configure mode.
(config)#interface sa1	Enter Interface mode for sa11
(config-if)#switchport	Make sa1 as L2 port by configuring switchport
(config-if)#bridge-group 1	Associate sa1 to bridge 1
(config-if)# bridge-group 1 spanning-tree disable	Configure sa1 as STP disable
(config-if)# switchport mode trunk	Mode as trunk
(config-if)# switchport trunk allowed vlan add 6,10,20	Trunk allowed VLAN as 2,.10.& 20
(config-if)#switchport trunk native vlan 6	Native VLAN as 6
(config-if)#exit	Exit Interface mode and return to Configure mode.
(config)#interface xe3	Enter Interface mode for xe3
(config-if)# static-channel-group 1	Make it member port of sa1
(config)#interface xe4	Enter Interface mode for xe4
(config-if)# static-channel-group 1	Make it member port of sa1
(config)#exit	Exit from configuration mode
(config)#interface vlan1.20	Enter Interface mode for VLAN1.20
(config-if)# ip address 21.21.21.3/24	Configure IP address
(config-if)#ipv6 address 21:21::21:3/48	Configure IPv6 address
(config-if)#exit	Exit from configuration mode
(config)#commit	Commit the candidate configuration to running configuration

Spine-P3

Spine node where all VTEPs are connected.

Generic configuration:

#configure terminal	Enter Configure mode.
(config)#qos enable	Enabling qos
(config)#commit	Commit the candidate configuration to running configuration

Interface and loopback configuration:

(config)#interface lo	Enter Interface mode for lo
(config-if)#ip address 100.100.100.100/32 secondary	Configure loopback IP address as 100.100.100.100 for Spine-P3
(config-if)#exit	Exit Interface mode and return to Configure mode.
(config)#interface po2	Enter Interface mode for po2
(config-if)#exit	Exit Interface mode and return to Configure mode.
(config)#interface xe25	Enter Interface mode for xe25
(config-if)#channel-group 2 mode active	Make it member port of po2
(config-if)#exit	Exit Interface mode and return to Configure mode.
(config)#interface xe26	Enter Interface mode for xe26
(config-if)#channel-group 2 mode active	Make it member port of po3
(config-if)#exit	Exit Interface mode and return to Configure mode.
(config)#interface po2	Enter Interface mode for po2
(config-if)#ip address 100.11.11.2/24	Configure IP address as 100.11.11.2 on network side of VTEP1
(config-if)#exit	Exit Interface mode and return to Configure mode.
(config)#interface po3	Enter Interface mode for po3
(config)#i switchport	Configure po3 as L2 interface
(config-if)#exit	Exit Interface mode and return to Configure mode.
(config)#interface xe27	Enter Interface mode for xe27
(config-if)#channel-group 3 mode active	Make it member port of po3
(config-if)#exit	Exit Interface mode and return to Configure mode.
(config)#interface xe28	Enter Interface mode for xe28
(config-if)#channel-group 3 mode active	Make it member port of po3
(config-if)#exit	Exit Interface mode and return to Configure mode.
(config)# bridge 1 protocol rstp vlan-bridge	Configure bridge 1
(config)# vlan database	Enter into VLAN database mode
(config)#vlan 2 bridge 1 state enable	Configure VLAN 2 as part of bridge 1
(config)#interface po3	Enter Interface mode for po3
(config-if)# bridge-group 1	Configure bridge 1 for po3
(config-if)# switchport mode trunk	Switchport mode as trunk
(config-if)# switchport trunk allowed vlan add 2	Trunk allowed VLAN 2
(config-if)#exit	Exit Interface mode and return to Configure mode.
(config) interface vlan1.2	Enter into SVI port VLAN1.2

(config-if)#ip address 100.12.12.2/24	Configure IP address as 100.12.12.2 on network side of VTEP2
(config-if)#exit	Exit Interface mode and return to Configure mode.
(config)#interface po4	Enter Interface mode for po4
(config-if)#exit	Exit Interface mode and return to Configure mode.
(config)#interface xe7	Enter Interface mode for xe7
(config-if)#channel-group 4 mode active	Make it member port of po4
(config-if)#exit	Exit Interface mode and return to Configure mode.
(config)#interface xe9	Enter Interface mode for xe9
(config-if)#channel-group 4 mode active	Make it member port of po4
(config-if)#exit	Exit Interface mode and return to Configure mode.
(config) interface po4.4	Enter L3SI po4.4
(config-if)# encapsulation dot1q 4	Encapsulation as dot1q with VLAN 4
(config-if)#ip address 100.14.14.2/24	Configure IP address as 100.14.14.12 on network side of VTEP4
(config-if)#exit	Exit Interface mode and return to Configure mode.
(config) interface xe40	Enter interface mode
(config-if)#ip address 100.15.15.1/24	Configure IP address as 100.15.15.1 on network side of VTEP5
(config-if)#exit	Exit Interface mode and return to Configure mode.
(config)#commit	Commit the candidate configuration to running configuration

OSPF configuration:

(config)#router ospf 100	Enter into router OSPF mode
(config-router)#ospf router-id 100.100.100.100	Configure router-id as 100.100.100.100 (lo IP address)
(config-router)#network 100.100.100.100/32 area 0.0.0.0	Add 100.100.100.100 (lo IP address) network into area 0
(config-router)#network 100.11.11.0/24 area 0.0.0.0	Add 100.11.11.0 (VTEP1) network into area 0
(config-router)#network 100.12.12.0/24 area 0.0.0.0	Add 100.12.12.0 (VTEP2) network into area 0
(config-router)#network 100.14.14.0/24 area 0.0.0.0	Add 100.14.14.0 (VTEP4) network into area 0
(config-router)#network 100.15.15.0/24 area 0.0.0.0	Add 100.15.15.0 (VTEP5) network into area 0
(config-router)#bfd all-interfaces	Enabling bfd on all ospf interface for fast convergence
(config-if)#exit	Exit Interface mode and return to Configure mode.
(config)#commit	Commit the candidate configuration to running configuration

Centralized Gateway

In Centralized gateway approach, when two TS belonging to two different subnets connected to the same/different VTEP node, wanted to communicate with each other, their traffic needed to be back hauled from the VTEP node to the centralized gateway node where inter- subnet switching is performed and then back to the VTEP node.

IRB Configuration for Centralized Gateway

Configure from Base Configuration-L2 VxLAN section, then configure below commands for centralized gateway approach.

VTEP5

(config)#nvo vxlan irb	Enable VxLAN IRB
(config)#commit	Commit the candidate configuration to running configuration
(config)#ip vrf L3VRF1	Create MAC routing/forwarding instance with L3VRF1 name and enter into VRF mode
(config-vrf)#rd 51000:11	Assign RD value
(config-vrf)# route-target both 100:100	Assign route-target value for same for import and export.
(config-vrf)# l3vni 1000	Configure L3VNI as 1000 for L3VRF1
(config-vrf)#exit	Exit from VRF mode
(config)#commit	Commit the candidate configuration to running configuration
(config)# interface irb1001	Configure IRB interface 1001
(config-if)ip vrf forwarding L3VRF1	Configure L3VRF1
(config-if)ip address 11.11.11.1/24 anycast	Configure IP address
(config-if)ipv6 address 11:11::11:1/48	Configure IPv6 address
(config-if)exit	Exit from interface config mode
(config)#commit	Commit the candidate configuration to running configuration
(config)# interface irb2001	Configure IRB interface 2001
(config-if)ip vrf forwarding L3VRF1	Configure L3VRF1
(config-if)ip address 21.21.21.1/24	Configure IP address
(config-if)ipv6 address 21:21::21:1/48	Configure IPv6 address
(config-if)exit	Exit from interface config mode
(config)router bgp 5000	Enter into BGP router mode
(config-router)#address-family ipv4 vrf L3VRF1	Enter into address-family mode for L3VRF1
(config-router-af)#redistribute connected	Redistribute connected
(config-router-af)#exit-address-family	Exit from address-family
(config-router)#exit	Exit from bgp router configuration mode
(config)#commit	Commit the candidate configuration to running configuration
(config)# nvo vxlan id 101 ingress-replication inner-vid-disabled	Configure VxLAN Network identifier with/without inner-vid-disabled configure and enter into VxLAN tenant mode

(config-nvo)#vxlan host-reachability-protocol evpn-bgp L2VRF1	Assign VRF for EVPN-BGP to carry EVPN route
(config-nvo)# evpn irb1001	Configure IRB1001 under VxLAN ID 101
(config-nvo)#exit	Exit from VxLAN tenant mode and enter into configuration mode.
(config)#nvo vxlan id 201 ingress-replication inner-vid-disabled	Configure VxLAN Network identifier with/without inner-vid-disabled configure and enter into VxLAN tenant mode
(config-nvo)#vxlan host-reachability-protocol evpn-bgp L2VRF2	Assign VRF for EVPN-BGP to carry EVPN route
(config-nvo)# evpn irb2001	Configure IRB2001 under VxLAN ID 201
(config-nvo)#exit	Exit from VxLAN tenant mode and enter into configuration mode.
(config)#commit	Commit the candidate configuration to running configuration

Validation

VTEP5

TB2-VTEP5#show nvo vxlan tunnel

VxLAN Network tunnel Entries

Source	Destination	Status	Up/Down	Update
5.5.5.5	2.2.2.2	Installed	00:26:30	00:26:30
5.5.5.5	4.4.4.4	Installed	00:26:30	00:26:30
5.5.5.5	1.1.1.1	Installed	00:26:30	00:26:30

Total number of entries are 3

TB2-VTEP5#show nvo vxlan

VxLAN Information

```

=====
Codes: NW - Network Port
       AC - Access Port
       (u) - Untagged

```

VNID	VNI-Name	VNI-Type	Type	Interface	ESI	VLAN	DF-Status	Src-Addr	Dst-Addr
101	VNI-101	L2	NW	----	----	----	----	5.5.5.5	2.2.2.2
101	VNI-101	L2	NW	----	----	----	----	5.5.5.5	4.4.4.4
101	VNI-101	L2	NW	----	----	----	----	5.5.5.5	1.1.1.1
101	VNI-101	--	AC	xe48	---	10	----	----	----
201	VNI-201	L2	NW	----	----	----	----	5.5.5.5	2.2.2.2
201	VNI-201	L2	NW	----	----	----	----	5.5.5.5	4.4.4.4
201	VNI-201	L2	NW	----	----	----	----	5.5.5.5	1.1.1.1

Total number of entries are 7

TB2-VTEP5#show nvo vxlan arp-cache

VxLAN ARP-CACHE Information

VNID	Ip-Addr	Mac-Addr	Type	Age-Out	Retries-Left
201	21.21.21.51	0000.2222.1020	Static Remote	----	----
201	21.21.21.1	3c2c.99d6.167a	Static Local	----	----
201	21.21.21.101	0000.4444.1020	Static Remote	----	----
101	11.11.11.51	0000.2222.1010	Static Remote	----	----
101	11.11.11.1	3c2c.99d6.167a	Static Local	----	----
101	11.11.11.201	0000.5555.1010	Static Local	----	----

Total number of entries are 6

TB2-VTEP5#show nvo vxlan nd-cache

VxLAN ND-CACHE Information

VNID	Ip-Addr	Mac-Addr	Type	Age-Out	Retries-Left
201	21:21::21:1	3c2c.99d6.167a	Static Local	----	----

```

101      11:11::1:1          3c2c.99d6.167a Static Local    ----
Total number of entries are 2
TB2-VTEP5#show nvo vxlan l3vni-map
 L3VNI      L2VNI      IRB-interface
=====
 1000      101        irb1001
 1000      201        irb2001

TB2-VTEP5#show ip route vrf L3VRF1
Codes: K - kernel, C - connected, S - static, R - RIP, B - BGP
       O - OSPF, IA - OSPF inter area
       N1 - OSPF NSSA external type 1, N2 - OSPF NSSA external type 2
       E1 - OSPF external type 1, E2 - OSPF external type 2
       i - IS-IS, L1 - IS-IS level-1, L2 - IS-IS level-2,
       ia - IS-IS inter area, E - EVPN,
       v - vrf leaked
       * - candidate default

IP Route Table for VRF "L3VRF1"
C      11.11.11.0/24 is directly connected, irb1001, 00:27:00
C      21.21.21.0/24 is directly connected, irb2001, 00:26:58
C      127.0.0.0/8 is directly connected, lo.L3VRF1, 00:32:53

Gateway of last resort is not set
TB2-VTEP5#show ipv6 route vrf L3VRF1
IPv6 Routing Table
Codes: K - kernel route, C - connected, S - static, R - RIP, O - OSPF,
       IA - OSPF inter area, E1 - OSPF external type 1,
       E2 - OSPF external type 2, E - EVPN N1 - OSPF NSSA external type 1,
       N2 - OSPF NSSA external type 2, i - IS-IS, B - BGP
Timers: Uptime

IP Route Table for VRF "L3VRF1"
C      ::1/128 via ::, lo.L3VRF1, 00:32:53
C      11:11::/48 via ::, irb1001, 00:27:00
C      21:21::/48 via ::, irb2001, 00:26:58
C      fe80::/64 via ::, irb2001, 00:04:38
TB2-VTEP5#show ip route summary

-----
IP routing table name is Default-IP-Routing-Table(0)
-----
IP routing table maximum-paths : 8
Total number of IPv4 routes    : 12
Total number of IPv4 paths    : 12
Pending routes (due to route max reached): 0
Route Source      Networks
connected         3
ospf              9
Total            12
FIB              12

ECMP statistics (active in ASIC):
  Total number of IPv4 ECMP routes : 0
  Total number of IPv4 ECMP paths  : 0
TB2-VTEP5#show ipv6 route summary

-----
IPv6 routing table name is Default-IPv6-Routing-Table(0)
-----
IPv6 routing table maximum-paths : 8
Total number of IPv6 routes      : 2
Total number of IPv6 paths      : 2
Pending routes (due to route max reached): 0
Route Source      Networks
connected         2
Total            2
FIB              2

ECMP statistics (active in ASIC):
  Total number of IPv6 ECMP routes : 0
  Total number of IPv6 ECMP paths  : 0
TB2-VTEP5#show bgp l2vpn evpn

```

BGP table version is 11, local router ID is 5.5.5.5
 Status codes: s suppressed, d damped, h history, * valid, > best, i - internal,
 l - labeled, S Stale
 Origin codes: i - IGP, e - EGP, ? - incomplete

[EVPN route type]:[ESI]:[VNID]:[relevent route informantion]

1 - Ethernet Auto-discovery Route
 2 - MAC/IP Route
 3 - Inclusive Multicast Route
 4 - Ethernet Segment Route
 5 - Prefix Route

Network	Next Hop	Metric	LocPrf	Weight	Path	Peer	Encap
RD[1.1.1.1:1]							
*>i [1]:[00:00:00:00:00:22:22:00:00:00]:[4294967295]:[0]	1.1.1.1	0	100	0	i 1.1.1.1		VxLAN
*>i [4]:[00:00:00:00:00:22:22:00:00:00]:[32,1.1.1.1]	1.1.1.1	0	100	0	i 1.1.1.1		VxLAN
RD[1.1.1.1:11]							
*>i [1]:[00:00:00:00:00:22:22:00:00:00]:[101]:[101]	1.1.1.1	0	100	0	i 1.1.1.1		VxLAN
*>i [2]:[00:00:00:00:00:22:22:00:00:00]:[101]:[48,0000:2222:1010]:[32,11.11.11.51]:[101]	1.1.1.1	0	100	0	i 1.1.1.1		VxLAN
*>i [3]:[101]:[32,1.1.1.1]	1.1.1.1	0	100	0	i 1.1.1.1		VxLAN
RD[1.1.1.1:21]							
*>i [1]:[00:00:00:00:00:22:22:00:00:00]:[201]:[201]	1.1.1.1	0	100	0	i 1.1.1.1		VxLAN
*>i [2]:[00:00:00:00:00:22:22:00:00:00]:[201]:[48,0000:2222:1020]:[32,21.21.21.51]:[201]	1.1.1.1	0	100	0	i 1.1.1.1		VxLAN
*>i [3]:[201]:[32,1.1.1.1]	1.1.1.1	0	100	0	i 1.1.1.1		VxLAN
RD[2.2.2.2:1]							
*>i [1]:[00:00:00:00:00:22:22:00:00:00]:[4294967295]:[0]	2.2.2.2	0	100	0	i 2.2.2.2		VxLAN
*>i [4]:[00:00:00:00:00:22:22:00:00:00]:[32,2.2.2.2]	2.2.2.2	0	100	0	i 2.2.2.2		VxLAN
RD[2.2.2.2:11]							
*>i [1]:[00:00:00:00:00:22:22:00:00:00]:[101]:[101]	2.2.2.2	0	100	0	i 2.2.2.2		VxLAN
*>i [2]:[00:00:00:00:00:22:22:00:00:00]:[101]:[48,0000:2222:1010]:[32,11.11.11.51]:[101]	2.2.2.2	0	100	0	i 2.2.2.2		VxLAN
*>i [3]:[101]:[32,2.2.2.2]	2.2.2.2	0	100	0	i 2.2.2.2		VxLAN
RD[2.2.2.2:21]							
*>i [1]:[00:00:00:00:00:22:22:00:00:00]:[201]:[201]	2.2.2.2	0	100	0	i 2.2.2.2		VxLAN
*>i [2]:[00:00:00:00:00:22:22:00:00:00]:[201]:[48,0000:2222:1020]:[32,21.21.21.51]:[201]	2.2.2.2	0	100	0	i 2.2.2.2		VxLAN
*>i [3]:[201]:[32,2.2.2.2]	2.2.2.2	0	100	0	i 2.2.2.2		VxLAN
RD[4.4.4.4:11]							
*>i [3]:[101]:[32,4.4.4.4]	4.4.4.4	0	100	0	i 4.4.4.4		VxLAN
RD[4.4.4.4:21]							
*>i [2]:[0]:[201]:[48,0000:4444:1020]:[32,21.21.21.101]:[201]	4.4.4.4	0	100	0	i 4.4.4.4		VxLAN
*>i [3]:[201]:[32,4.4.4.4]	4.4.4.4	0	100	0	i 4.4.4.4		VxLAN
RD[5.5.5.5:11] VRF[L2VRF1]:							
* i [1]:[00:00:00:00:00:22:22:00:00:00]:[101]:[101]	1.1.1.1	0	100	0	i 1.1.1.1		VxLAN
* i [1]:[00:00:00:00:00:22:22:00:00:00]:[4294967295]:[0]	2.2.2.2	0	100	0	i 2.2.2.2		VxLAN

```

1.1.1.1          0          100          0          i  1.1.1.1          VxLAN
2.2.2.2          0          100          0          i  2.2.2.2          VxLAN
* i [2]:[00:00:00:00:00:22:22:00:00:00]:[101]:[48,0000:2222:1010]:[32,11.11.11.51]:[101]
1.1.1.1          0          100          0          i  1.1.1.1          VxLAN
* i 2.2.2.2          0          100          0          i  2.2.2.2          VxLAN
*> [2]:[0]:[101]:[48,0000:5555:1010]:[32,11.11.11.201]:[101]
5.5.5.5          0          100          32768         i  -----          VxLAN
*> [2]:[0]:[101]:[48,3c2c:99d6:167a]:[32,11.11.11.1]:[101]
5.5.5.5          0          100          32768         i  -----          VxLAN
*> [2]:[0]:[101]:[48,3c2c:99d6:167a]:[128,11:11::11:1]:[101]
5.5.5.5          0          100          32768         i  -----          VxLAN
* i [3]:[101]:[32,1.1.1.1]
1.1.1.1          0          100          0          i  1.1.1.1          VxLAN
* i [3]:[101]:[32,2.2.2.2]
2.2.2.2          0          100          0          i  2.2.2.2          VxLAN
* i [3]:[101]:[32,4.4.4.4]
4.4.4.4          0          100          0          i  4.4.4.4          VxLAN
*> [3]:[101]:[32,5.5.5.5]
5.5.5.5          0          100          32768         i  -----          VxLAN

RD[5.5.5.5:21] VRF[L2VRF2]:
* i [1]:[00:00:00:00:00:22:22:00:00:00]:[201]:[201]
1.1.1.1          0          100          0          i  1.1.1.1          VxLAN
* i 2.2.2.2          0          100          0          i  2.2.2.2          VxLAN
* i [1]:[00:00:00:00:00:22:22:00:00:00]:[4294967295]:[0]
1.1.1.1          0          100          0          i  1.1.1.1          VxLAN
* i 2.2.2.2          0          100          0          i  2.2.2.2          VxLAN
* i [2]:[00:00:00:00:00:22:22:00:00:00]:[201]:[48,0000:2222:1020]:[32,21.21.21.51]:[201]
1.1.1.1          0          100          0          i  1.1.1.1          VxLAN
* i 2.2.2.2          0          100          0          i  2.2.2.2          VxLAN
* i [2]:[0]:[201]:[48,0000:4444:1020]:[32,21.21.21.101]:[201]
4.4.4.4          0          100          0          i  4.4.4.4          VxLAN
*> [2]:[0]:[201]:[48,3c2c:99d6:167a]:[32,21.21.21.1]:[201]
5.5.5.5          0          100          32768         i  -----          VxLAN
*> [2]:[0]:[201]:[48,3c2c:99d6:167a]:[128,21:21::21:1]:[201]
5.5.5.5          0          100          32768         i  -----          VxLAN
* i [3]:[201]:[32,1.1.1.1]
1.1.1.1          0          100          0          i  1.1.1.1          VxLAN
* i [3]:[201]:[32,2.2.2.2]
2.2.2.2          0          100          0          i  2.2.2.2          VxLAN
* i [3]:[201]:[32,4.4.4.4]
4.4.4.4          0          100          0          i  4.4.4.4          VxLAN
*> [3]:[201]:[32,5.5.5.5]
5.5.5.5          0          100          32768         i  -----          VxLAN

Total number of prefixes 39
TB2-VTEP5#

```

Anycast Gateway

For today's large multi-tenant data center, centralized L3 gateway scheme is very inefficient and sometimes impractical. In order to overcome the drawback of centralized L3GW approach, anycast mode is used.

In Anycast gateway approach, all the VTEPs acts as default gateway for all the VNIDs. We will configure same anycast MAC in all VTEPs.

IRB Configuration for Anycast

Configure from Base Configuration-L2 VxLAN section, then configure below commands for Anycast gateway approach.

VSTEP1

(config)#nvo vxlan irb	Enable VxLAN IRB
(config)#commit	Commit the candidate configuration to running configuration
(config)#ip vrf L3VRF1	Create MAC routing/forwarding instance with L3VRF1 name and enter into VRF mode
(config-vrf)#rd 11000:11	Assign RD value
(config-vrf)# route-target both 100:100	Assign route-target value for same for import and export.
(config-vrf)# l3vni 1000	Configure L3VNI as 1000 for L3VRF1
(config-vrf)#exit	Exit from VRF mode
(config)# evpn irb-forwarding anycast-gateway-mac 0000.0000.1111	Configure anycast MAC address
(config)#commit	Commit the candidate configuration to running configuration
(config)# interface irb1001	Configure IRB interface 1001
(config-if)ip vrf forwarding L3VRF1	Configure L3VRF1
(config-if)ip address 11.11.11.1/24 anycast	Configure IP address
(config-if)ipv6 address 11:11::11:1/48	Configure IPv6 address
(config-if) evpn irb-if-forwarding anycast-gateway-mac	Configure anycast MAC address
(config-if)exit	Exit from interface config mode
(config)# interface irb2001	Configure IRB interface 2001
(config-if)ip vrf forwarding L3VRF1	Configure L3VRF1
(config-if)ip address 21.21.21.1/24 anycast	Configure IP address
(config-if)ipv6 address 21:21::21:1/48	Configure IPv6 address
(config-if) evpn irb-if-forwarding anycast-gateway-mac	Configure anycast MAC address
(config-if)exit	Exit from interface config mode
(config)#commit	Commit the candidate configuration to running configuration
(config)router bgp 5000	Enter into BGP router mode
(config-router)#address-family ipv4 vrf L3VRF1	Enter into address-family mode for L3VRF1
(config-router-af)#redistribute connected	Redistribute connected
(config-router-af)#exit-address-family	Exit from address-family
(config)# nvo vxlan id 101 ingress-replication inner-vid-disabled	Configure VxLAN Network identifier with/without inner-vid-disabled configure and enter into VxLAN tenant mode
(config-nvo)#vxlan host-reachability-protocol evpn-bgp L2VRF1	Assign VRF for EVPN-BGP to carry EVPN route
(config-nvo)# evpn irb1001	Configure IRB1001 under VxLAN ID 101
(config-nvo)#exit	Exit from VxLAN tenant mode and enter into configuration mode.
(config)#nvo vxlan id 201 ingress-replication inner-vid-disabled	Configure VxLAN Network identifier with/without inner-vid-disabled configure and enter into VxLAN tenant mode
(config-nvo)#vxlan host-reachability-protocol evpn-bgp L2VRF2	Assign VRF for EVPN-BGP to carry EVPN route
(config-nvo)# evpn irb2001	Configure IRB2001 under VxLAN ID 201

(config-nvo)#exit	Exit from VxLAN tenant mode and enter into configuration mode.
(config)#commit	Commit the candidate configuration to running configuration

VTEP2

(config)#nvo vxlan irb	Enable VxLAN IRB
(config)#commit	Commit the candidate configuration to running configuration
(config)#ip vrf L3VRF1	Create MAC routing/forwarding instance with L3VRF1 name and enter into VRF mode
(config-vrf)#rd 21000:11	Assign RD value
(config-vrf)# route-target both 100:100	Assign route-target value for same for import and export.
(config-vrf)# l3vni 1000	Configure L3VNI as 1000 for L3VRF1
(config-vrf)#exit	Exit from VRF mode
(config)# evpn irb-forwarding anycast-gateway-mac 0000.0000.1111	Configure anycast MAC address
(config)#commit	Commit the candidate configuration to running configuration
(config)# interface irb1001	Configure IRB interface 1001
(config-if)ip vrf forwarding L3VRF1	Configure L3VRF1
(config-if)ip address 11.11.11.1/24 anycast	Configure IP address
(config-if)ipv6 address 11:11::11:1/48	Configure IPv6 address
(config-if) evpn irb-if-forwarding anycast-gateway-mac	Configure anycast MAC address
(config-if)exit	Exit from interface config mode
(config)# interface irb2001	Configure IRB interface 2001
(config-if)ip vrf forwarding L3VRF1	Configure L3VRF1
(config-if)ip address 21.21.21.1/24 anycast	Configure IP address
(config-if)ipv6 address 21:21::21:1/48	Configure IPv6 address
(config-if) evpn irb-if-forwarding anycast-gateway-mac	Configure anycast MAC address
(config-if)exit	Exit from interface config mode
(config)#commit	Commit the candidate configuration to running configuration
(config)router bgp 5000	Enter into BGP router mode
(config-router)#address-family ipv4 vrf L3VRF1	Enter into address-family mode for L3VRF1
(config-router-af)#redistribute connected	Redistribute connected
(config-router-af)#exit-address-family	Exit from address-family
(config)# nvo vxlan id 101 ingress-replication inner-vid-disabled	Configure VxLAN Network identifier with/without inner-vid-disabled configure and enter into VxLAN tenant mode
(config-nvo)#vxlan host-reachability-protocol evpn-bgp L2VRF1	Assign VRF for EVPN-BGP to carry EVPN route
(config-nvo)# evpn irb1001	Configure IRB1001 under VxLAN ID 101
(config-nvo)#exit	Exit from VxLAN tenant mode and enter into configuration mode.

(config)#nvo vxlan id 201 ingress-replication inner-vid-disabled	Configure VxLAN Network identifier with/without inner-vid-disabled configure and enter into VxLAN tenant mode
(config-nvo)#vxlan host-reachability-protocol evpn-bgp L2VRF2	Assign VRF for EVPN-BGP to carry EVPN route
(config-nvo)# evpn irb2001	Configure IRB2001 under VxLAN ID 201
(config-nvo)#exit	Exit from VxLAN tenant mode and enter into configuration mode.
(config)#commit	Commit the candidate configuration to running configuration

VTEP4

(config)#nvo vxlan irb	Enable VxLAN IRB
(config)#commit	Commit the candidate configuration to running configuration
(config)#ip vrf L3VRF1	Create MAC routing/forwarding instance with L3VRF1 name and enter into VRF mode
(config-vrf)#rd 41000:11	Assign RD value
(config-vrf)# route-target both 100:100	Assign route-target value for same for import and export.
(config-vrf)# l3vni 1000	Configure L3VNI as 1000 for L3VRF1
(config-vrf)#exit	Exit from VRF mode
(config)# evpn irb-forwarding anycast-gateway-mac 0000.0000.1111	Configure anycast MAC address
(config)#commit	Commit the candidate configuration to running configuration
(config)# interface irb1001	Configure IRB interface 1001
(config-if)ip vrf forwarding L3VRF1	Configure L3VRF1
(config-if)ip address 11.11.11.1/24 anycast	Configure IP address
(config-if)ipv6 address 11:11::11:1/48	Configure IPv6 address
(config-if) evpn irb-if-forwarding anycast-gateway-mac	Configure anycast MAC address
(config-if)exit	Exit from interface config mode
(config)# interface irb2001	Configure IRB interface 2001
(config-if)ip vrf forwarding L3VRF1	Configure L3VRF1
(config-if)ip address 21.21.21.1/24 anycast	Configure IP address
(config-if)ipv6 address 21:21::21:1/48	Configure IPv6 address
(config-if) evpn irb-if-forwarding anycast-gateway-mac	Configure anycast MAC address
(config-if)exit	Exit from interface config mode
(config)#commit	Commit the candidate configuration to running configuration
(config)router bgp 5000	Enter into BGP router mode
(config-router)#address-family ipv4 vrf L3VRF1	Enter into address-family mode for L3VRF1
(config-router-af)#redistribute connected	Redistribute connected
(config-router-af)#exit-address-family	Exit from address-family
(config)# nvo vxlan id 101 ingress-replication inner-vid-disabled	Configure VxLAN Network identifier with/without inner-vid-disabled configure and enter into VxLAN tenant mode

(config-nvo)#vxlan host-reachability-protocol evpn-bgp L2VRF1	Assign VRF for EVPN-BGP to carry EVPN route
(config-nvo)# evpn irb1001	Configure IRB1001 under VxLAN ID 101
(config-nvo)#exit	Exit from VxLAN tenant mode and enter into configuration mode.
(config)#nvo vxlan id 201 ingress-replication inner-vid-disabled	Configure VxLAN Network identifier with/without inner-vid-disabled configure and enter into VxLAN tenant mode
(config-nvo)#vxlan host-reachability-protocol evpn-bgp L2VRF2	Assign VRF for EVPN-BGP to carry EVPN route
(config-nvo)# evpn irb2001	Configure IRB2001 under VxLAN ID 201
(config-nvo)#exit	Exit from VxLAN tenant mode and enter into configuration mode.
(config)#commit	Commit the candidate configuration to running configuration

VTEP5

(config)#nvo vxlan irb	Enable VxLAN IRB
(config)#commit	Commit the candidate configuration to running configuration
(config)#ip vrf L3VRF1	Create MAC routing/forwarding instance with L3VRF1 name and enter into VRF mode
(config-vrf)#rd 51000:11	Assign RD value
(config-vrf)# route-target both 100:100	Assign route-target value for same for import and export.
(config-vrf)# l3vni 1000	Configure L3VNI as 1000 for L3VRF1
(config-vrf)#exit	Exit from VRF mode
(config)# evpn irb-forwarding anycast-gateway-mac 0000.0000.1111	Configure anycast MAC address
(config)#commit	Commit the candidate configuration to running configuration
(config)# interface irb1001	Configure IRB interface 1001
(config-if)ip vrf forwarding L3VRF1	Configure L3VRF1
(config-if)ip address 11.11.11.1/24 anycast	Configure IP address
(config-if)ipv6 address 11:11::11:1/48	Configure IPv6 address
(config-if) evpn irb-if-forwarding anycast-gateway-mac	Configure anycast MAC address
(config-if)exit	Exit from interface config mode
(config)# interface irb2001	Configure IRB interface 2001
(config-if)ip vrf forwarding L3VRF1	Configure L3VRF1
(config-if)ip address 21.21.21.1/24 anycast	Configure IP address
(config-if)ipv6 address 21:21::21:1/48	Configure IPv6 address
(config-if) evpn irb-if-forwarding anycast-gateway-mac	Configure anycast MAC address
(config-if)exit	Exit from interface config mode
(config)#commit	Commit the candidate configuration to running configuration
(config)router bgp 5000	Enter into BGP router mode
(config-router)#address-family ipv4 vrf L3VRF1	Enter into address-family mode for L3VRF1

(config-router-af)#redistribute connected	Redistribute connected
(config-router-af)#exit-address-family	Exit from address-family
(config)# nvo vxlan id 101 ingress-replication inner-vid-disabled	Configure VxLAN Network identifier with/without inner-vid-disabled configure and enter into VxLAN tenant mode
(config-nvo)#vxlan host-reachability-protocol evpn-bgp L2VRF1	Assign VRF for EVPN-BGP to carry EVPN route
(config-nvo)# evpn irb1001	Configure IRB1001 under VxLAN ID 101
(config-nvo)#exit	Exit from VxLAN tenant mode and enter into configuration mode.
(config)#commit	Commit the candidate configuration to running configuration
(config)#nvo vxlan id 201 ingress-replication inner-vid-disabled	Configure VxLAN Network identifier with/without inner-vid-disabled configure and enter into VxLAN tenant mode
(config-nvo)#vxlan host-reachability-protocol evpn-bgp L2VRF2	Assign VRF for EVPN-BGP to carry EVPN route
(config-nvo)# evpn irb2001	Configure IRB2001 under VxLAN ID 201
(config-nvo)#exit	Exit from VxLAN tenant mode and enter into configuration mode.
(config)#commit	Commit the candidate configuration to running configuration

Validations

VTEP1

TB2-VTEP1#show nvo vxlan tunnel

VxLAN Network tunnel Entries

Source	Destination	Status	Up/Down	Update
1.1.1.1	5.5.5.5	Installed	00:13:05	00:13:05
1.1.1.1	4.4.4.4	Installed	00:18:33	00:18:33
1.1.1.1	2.2.2.2	Installed	00:18:34	00:18:34

Total number of entries are 3

TB2-VTEP1#show nvo vxlan

VxLAN Information

=====

Codes: NW - Network Port
AC - Access Port
(u) - Untagged

VNID	VNI-Name	VNI-Type	Type	Interface	ESI	VLAN	DF-Status	Src-Addr	Dst-Addr
101	VNI-101	L2	NW	----	----	----	----	1.1.1.1	5.5.5.5
101	VNI-101	L2	NW	----	----	----	----	1.1.1.1	4.4.4.4
101	VNI-101	L2	NW	----	----	----	----	1.1.1.1	2.2.2.2
101	VNI-101	--	AC	po1	00:00:00:00:00:22:22:00:00:00	10	DF	----	----
201	VNI-201	L2	NW	----	----	----	----	1.1.1.1	5.5.5.5
201	VNI-201	L2	NW	----	----	----	----	1.1.1.1	4.4.4.4
201	VNI-201	L2	NW	----	----	----	----	1.1.1.1	2.2.2.2
201	VNI-201	--	AC	po1	00:00:00:00:00:22:22:00:00:00	20	DF	----	----

Total number of entries are 8

TB2-VTEP1#show nvo vxlan arp-cache

VxLAN ARP-CACHE Information

=====

VNID	Ip-Addr	Mac-Addr	Type	Age-Out	Retries-Left
201	21.21.21.51	0000.2222.1020	Static Local	----	----
201	21.21.21.1	0000.0000.1111	Static Local	----	----
201	21.21.21.101	0000.4444.1020	Static Remote	----	----
101	11.11.11.51	0000.2222.1010	Static Local	----	----

```

101      11.11.11.1      0000.0000.1111 Static Local ----
101      11.11.11.201    0000.5555.1010 Static Remote ----

```

Total number of entries are 6

TB2-VTEP1#show nvo vxlan nd-cache

VxLAN ND-CACHE Information

=====

VNID	Ip-Addr	Mac-Addr	Type	Age-Out	Retries-Left
201	21:21::21:1	0000.0000.1111	Static Local	----	
101	11:11::11:1	0000.0000.1111	Static Local	----	

Total number of entries are 2

TB2-VTEP1#show nvo vxlan l3vni-map

L3VNI L2VNI IRB-interface

=====

1000	101	irb1001
1000	201	irb2001

TB2-VTEP1#show ip route vrf L3VRF1

Codes: K - kernel, C - connected, S - static, R - RIP, B - BGP

O - OSPF, IA - OSPF inter area

N1 - OSPF NSSA external type 1, N2 - OSPF NSSA external type 2

E1 - OSPF external type 1, E2 - OSPF external type 2

i - IS-IS, L1 - IS-IS level-1, L2 - IS-IS level-2,

ia - IS-IS inter area, E - EVPN,

v - vrf leaked

* - candidate default

IP Route Table for VRF "L3VRF1"

```

C      11.11.11.0/24 is directly connected, irb1001, 00:19:26
C      21.21.21.0/24 is directly connected, irb2001, 00:19:26
C      127.0.0.0/8 is directly connected, lo.L3VRF1, 00:19:28

```

Gateway of last resort is not set

TB2-VTEP1#show ipv6 route vrf L3VRF1

IPv6 Routing Table

Codes: K - kernel route, C - connected, S - static, R - RIP, O - OSPF,

IA - OSPF inter area, E1 - OSPF external type 1,

E2 - OSPF external type 2, E - EVPN N1 - OSPF NSSA external type 1,

N2 - OSPF NSSA external type 2, i - IS-IS, B - BGP

Timers: Uptime

IP Route Table for VRF "L3VRF1"

```

C      ::1/128 via ::, lo.L3VRF1, 00:19:28
C      11:11::/48 via ::, irb1001, 00:19:26
C      21:21::/48 via ::, irb2001, 00:19:26
C      fe80::/64 via ::, irb2001, 00:19:25

```

TB2-VTEP1#show ip route summary

IP routing table name is Default-IP-Routing-Table(0)

```

IP routing table maximum-paths : 8
Total number of IPv4 routes : 12
Total number of IPv4 paths : 12
Pending routes (due to route max reached): 0
Route Source Networks
connected 3
ospf 9
Total 12
FIB 12

```

ECMP statistics (active in ASIC):

Total number of IPv4 ECMP routes : 0

Total number of IPv4 ECMP paths : 0

TB2-VTEP1#show ipv6 route summary

IPv6 routing table name is Default-IPv6-Routing-Table(0)

```

IPv6 routing table maximum-paths : 8
Total number of IPv6 routes : 2
Total number of IPv6 paths : 2
Pending routes (due to route max reached): 0

```



```

Route Source   Networks
connected      2
Total          2
FIB            2

```

ECMP statistics (active in ASIC):

```

Total number of IPv6 ECMP routes   : 0
Total number of IPv6 ECMP paths    : 0

```

```
TB2-VTEP1#show bgp l2vpn evpn
```

```
BGP table version is 6, local router ID is 1.1.1.1
```

```

Status codes: s suppressed, d damped, h history, * valid, > best, i - internal,
               l - labeled, S Stale

```

```
Origin codes: i - IGP, e - EGP, ? - incomplete
```

```
[EVPN route type]:[ESI]:[VNID]:[relevant route information]
```

```
1 - Ethernet Auto-discovery Route
```

```
2 - MAC/IP Route
```

```
3 - Inclusive Multicast Route
```

```
4 - Ethernet Segment Route
```

```
5 - Prefix Route
```

Network	Next Hop	Metric	LocPrf	Weight	Path	Peer	Encap
RD[21000:11]							
*>i [5]:[0]:[1000]:[24]:[11.11.11.0]:[0.0.0.0]:[1000]	2.2.2.2	0	100	0	?	2.2.2.2	VxLAN
*>i [5]:[0]:[1000]:[24]:[21.21.21.0]:[0.0.0.0]:[1000]	2.2.2.2	0	100	0	?	2.2.2.2	VxLAN
RD[41000:11]							
*>i [5]:[0]:[1000]:[24]:[11.11.11.0]:[0.0.0.0]:[1000]	4.4.4.4	0	100	0	?	4.4.4.4	VxLAN
*>i [5]:[0]:[1000]:[24]:[21.21.21.0]:[0.0.0.0]:[1000]	4.4.4.4	0	100	0	?	4.4.4.4	VxLAN
RD[51000:11]							
*>i [5]:[0]:[1000]:[24]:[11.11.11.0]:[0.0.0.0]:[1000]	5.5.5.5	0	100	0	?	5.5.5.5	VxLAN
*>i [5]:[0]:[1000]:[24]:[21.21.21.0]:[0.0.0.0]:[1000]	5.5.5.5	0	100	0	?	5.5.5.5	VxLAN
RD[1.1.1.1:1] VRF[evpn-gvrf-1]:							
*> [1]:[00:00:00:00:00:22:22:00:00:00]:[4294967295]:[0]	1.1.1.1	0	100	32768	i	-----	VxLAN
*> [4]:[00:00:00:00:00:22:22:00:00:00]:[32,1.1.1.1]	1.1.1.1	0	100	32768	i	-----	VxLAN
* i [4]:[00:00:00:00:00:22:22:00:00:00]:[32,2.2.2.2]	2.2.2.2	0	100	0	i	2.2.2.2	VxLAN
RD[1.1.1.1:11] VRF[L2VRF1]:							
*> [1]:[00:00:00:00:00:22:22:00:00:00]:[101]:[101]	1.1.1.1	0	100	32768	i	-----	VxLAN
* i [1]:[00:00:00:00:00:22:22:00:00:00]:[4294967295]:[0]	2.2.2.2	0	100	0	i	2.2.2.2	VxLAN
* i [2]:[0]:[101]:[48,0000:0000:1111]:[32,11.11.11.1]:[101]	5.5.5.5	0	100	0	i	5.5.5.5	VxLAN
* i [2]:[0]:[101]:[48,0000:0000:1111]:[32,11.11.11.1]:[101]	4.4.4.4	0	100	0	i	4.4.4.4	VxLAN
* i [2]:[0]:[101]:[48,0000:0000:1111]:[32,11.11.11.1]:[101]	2.2.2.2	0	100	0	i	2.2.2.2	VxLAN
*> [2]:[0]:[101]:[48,0000:0000:1111]:[128,11:11::11:1]:[101]	5.5.5.5	0	100	0	i	5.5.5.5	VxLAN
* i [2]:[0]:[101]:[48,0000:0000:1111]:[128,11:11::11:1]:[101]	4.4.4.4	0	100	0	i	4.4.4.4	VxLAN
* i [2]:[0]:[101]:[48,0000:0000:1111]:[128,11:11::11:1]:[101]	2.2.2.2	0	100	0	i	2.2.2.2	VxLAN
*> [2]:[00:00:00:00:00:22:22:00:00:00]:[101]:[48,0000:2222:1010]:[32,11.11.11.51]:[101]	1.1.1.1	0	100	32768	i	-----	VxLAN
* i [2]:[00:00:00:00:00:22:22:00:00:00]:[101]:[48,0000:2222:1010]:[32,11.11.11.51]:[101]	2.2.2.2	0	100	0	i	2.2.2.2	VxLAN
* i [2]:[0]:[101]:[48,0000:5555:1010]:[32,11.11.11.201]:[101]	5.5.5.5	0	100	0	i	5.5.5.5	VxLAN
*> [3]:[101]:[32,1.1.1.1]	1.1.1.1	0	100	32768	i	-----	VxLAN
* i [3]:[101]:[32,2.2.2.2]							

```

                2.2.2.2                0        100        0        i  2.2.2.2        VxLAN
* i  [3]:[101]:[32,4.4.4.4]
                4.4.4.4                0        100        0        i  4.4.4.4        VxLAN
* i  [3]:[101]:[32,5.5.5.5]
                5.5.5.5                0        100        0        i  5.5.5.5        VxLAN

RD[1.1.1.1:21] VRF[L2VRF2]:
*> [1]:[00:00:00:00:00:22:22:00:00:00]:[201]:[201]
                1.1.1.1                0        100        32768    i  -----        VxLAN
* i                2.2.2.2                0        100        0        i  2.2.2.2        VxLAN
* i  [1]:[00:00:00:00:00:22:22:00:00:00]:[4294967295]:[0]
                2.2.2.2                0        100        0        i  2.2.2.2        VxLAN
* i  [2]:[0]:[201]:[48,0000:0000:1111]:[32,21.21.21.1]:[201]
                5.5.5.5                0        100        0        i  5.5.5.5        VxLAN
* i                4.4.4.4                0        100        0        i  4.4.4.4        VxLAN
* i                2.2.2.2                0        100        0        i  2.2.2.2        VxLAN
*>                1.1.1.1                0        100        32768    i  -----        VxLAN
* i  [2]:[0]:[201]:[48,0000:0000:1111]:[128,21:21::21:1]:[201]
                5.5.5.5                0        100        0        i  5.5.5.5        VxLAN
* i                4.4.4.4                0        100        0        i  4.4.4.4        VxLAN
* i                2.2.2.2                0        100        0        i  2.2.2.2        VxLAN
*>                1.1.1.1                0        100        32768    i  -----        VxLAN
* i  [2]:[00:00:00:00:00:22:22:00:00:00]:[201]:[48,0000:2222:1020]:[32,21.21.21.51]:[201]
                1.1.1.1                0        100        32768    i  -----        VxLAN
* i                2.2.2.2                0        100        0        i  2.2.2.2        VxLAN
* i  [2]:[0]:[201]:[48,0000:4444:1020]:[32,21.21.21.101]:[201]
                4.4.4.4                0        100        0        i  4.4.4.4        VxLAN
*> [3]:[201]:[32,1.1.1.1]
                1.1.1.1                0        100        32768    i  -----        VxLAN
* i  [3]:[201]:[32,2.2.2.2]
                2.2.2.2                0        100        0        i  2.2.2.2        VxLAN
* i  [3]:[201]:[32,4.4.4.4]
                4.4.4.4                0        100        0        i  4.4.4.4        VxLAN
* i  [3]:[201]:[32,5.5.5.5]
                5.5.5.5                0        100        0        i  5.5.5.5        VxLAN

RD[2.2.2.2:1]
*>i [1]:[00:00:00:00:00:22:22:00:00:00]:[4294967295]:[0]
                2.2.2.2                0        100        0        i  2.2.2.2        VxLAN
*>i [4]:[00:00:00:00:00:22:22:00:00:00]:[32,2.2.2.2]
                2.2.2.2                0        100        0        i  2.2.2.2        VxLAN

RD[2.2.2.2:11]
*>i [1]:[00:00:00:00:00:22:22:00:00:00]:[101]:[101]
                2.2.2.2                0        100        0        i  2.2.2.2        VxLAN
*>i [2]:[0]:[101]:[48,0000:0000:1111]:[32,11.11.11.1]:[101]
                2.2.2.2                0        100        0        i  2.2.2.2        VxLAN
*>i [2]:[0]:[101]:[48,0000:0000:1111]:[128,11:11::11:1]:[101]
                2.2.2.2                0        100        0        i  2.2.2.2        VxLAN
*>i [2]:[00:00:00:00:00:22:22:00:00:00]:[101]:[48,0000:2222:1010]:[32,11.11.11.51]:[101]
                2.2.2.2                0        100        0        i  2.2.2.2        VxLAN
*>i [3]:[101]:[32,2.2.2.2]
                2.2.2.2                0        100        0        i  2.2.2.2        VxLAN

RD[2.2.2.2:21]
*>i [1]:[00:00:00:00:00:22:22:00:00:00]:[201]:[201]
                2.2.2.2                0        100        0        i  2.2.2.2        VxLAN
*>i [2]:[0]:[201]:[48,0000:0000:1111]:[32,21.21.21.1]:[201]
                2.2.2.2                0        100        0        i  2.2.2.2        VxLAN
*>i [2]:[0]:[201]:[48,0000:0000:1111]:[128,21:21::21:1]:[201]
                2.2.2.2                0        100        0        i  2.2.2.2        VxLAN
*>i [2]:[00:00:00:00:00:22:22:00:00:00]:[201]:[48,0000:2222:1020]:[32,21.21.21.51]:[201]
                2.2.2.2                0        100        0        i  2.2.2.2        VxLAN
*>i [3]:[201]:[32,2.2.2.2]
                2.2.2.2                0        100        0        i  2.2.2.2        VxLAN

RD[4.4.4.4:11]
*>i [2]:[0]:[101]:[48,0000:0000:1111]:[32,11.11.11.1]:[101]
                4.4.4.4                0        100        0        i  4.4.4.4        VxLAN
*>i [2]:[0]:[101]:[48,0000:0000:1111]:[128,11:11::11:1]:[101]
                4.4.4.4                0        100        0        i  4.4.4.4        VxLAN
*>i [3]:[101]:[32,4.4.4.4]
                4.4.4.4                0        100        0        i  4.4.4.4        VxLAN

```

```
RD[4.4.4.4:21]
*>i [2]:[0]:[201]:[48,0000:0000:1111]:[32,21.21.21.1]:[201]
    4.4.4.4          0          100      0    i  4.4.4.4          VxLAN
*>i [2]:[0]:[201]:[48,0000:0000:1111]:[128,21:21::21:1]:[201]
    4.4.4.4          0          100      0    i  4.4.4.4          VxLAN
*>i [2]:[0]:[201]:[48,0000:4444:1020]:[32,21.21.21.101]:[201]
    4.4.4.4          0          100      0    i  4.4.4.4          VxLAN
*>i [3]:[201]:[32,4.4.4.4]
    4.4.4.4          0          100      0    i  4.4.4.4          VxLAN
```

```
RD[5.5.5.5:11]
*>i [2]:[0]:[101]:[48,0000:0000:1111]:[32,11.11.11.1]:[101]
    5.5.5.5          0          100      0    i  5.5.5.5          VxLAN
*>i [2]:[0]:[101]:[48,0000:0000:1111]:[128,11:11::11:1]:[101]
    5.5.5.5          0          100      0    i  5.5.5.5          VxLAN
*>i [2]:[0]:[101]:[48,0000:5555:1010]:[32,11.11.11.201]:[101]
    5.5.5.5          0          100      0    i  5.5.5.5          VxLAN
*>i [3]:[101]:[32,5.5.5.5]
    5.5.5.5          0          100      0    i  5.5.5.5          VxLAN
```

```
RD[5.5.5.5:21]
*>i [2]:[0]:[201]:[48,0000:0000:1111]:[32,21.21.21.1]:[201]
    5.5.5.5          0          100      0    i  5.5.5.5          VxLAN
*>i [2]:[0]:[201]:[48,0000:0000:1111]:[128,21:21::21:1]:[201]
    5.5.5.5          0          100      0    i  5.5.5.5          VxLAN
*>i [3]:[201]:[32,5.5.5.5]
    5.5.5.5          0          100      0    i  5.5.5.5          VxLAN
```

Total number of prefixes 55
TB2-VTEP1#

```
TB2-VTEP2#show nvo vxlan tunnel
VxLAN Network tunnel Entries
Source          Destination    Status          Up/Down         Update
=====
2.2.2.2         4.4.4.4       Installed       00:18:42        00:18:42
2.2.2.2         1.1.1.1       Installed       00:18:43        00:18:43
2.2.2.2         5.5.5.5       Installed       00:13:14        00:13:14
```

Total number of entries are 3
TB2-VTEP2#show nvo vxlan

```
VxLAN Information
=====
Codes: NW - Network Port
       AC - Access Port
       (u) - Untagged
```

VNID	VNI-Name	VNI-Type	Type	Interface	ESI	VLAN	DF-Status	Src-Addr	Dst-Addr
101	VNI-101	L2	NW	----	----	----	----	2.2.2.2	4.4.4.4
101	VNI-101	L2	NW	----	----	----	----	2.2.2.2	1.1.1.1
101	VNI-101	L2	NW	----	----	----	----	2.2.2.2	5.5.5.5
101	VNI-101	--	AC	po1	00:00:00:00:00:22:22:00:00:00	10	NON-DF	----	----
201	VNI-201	L2	NW	----	----	----	----	2.2.2.2	4.4.4.4
201	VNI-201	L2	NW	----	----	----	----	2.2.2.2	1.1.1.1
201	VNI-201	L2	NW	----	----	----	----	2.2.2.2	5.5.5.5
201	VNI-201	--	AC	po1	00:00:00:00:00:22:22:00:00:00	20	NON-DF	----	----

Total number of entries are 8
TB2-VTEP2#show nvo vxlan arp-cache

```
VxLAN ARP-CACHE Information
=====
VNID  Ip-Addr          Mac-Addr          Type          Age-Out          Retries-Left
-----
201   21.21.21.51     0000.2222.1020   Static Local   ----
201   21.21.21.1      0000.0000.1111   Static Local   ----
201   21.21.21.101    0000.4444.1020   Static Remote  ----
101   11.11.11.51     0000.2222.1010   Static Local   ----
101   11.11.11.1      0000.0000.1111   Static Local   ----
101   11.11.11.201    0000.5555.1010   Static Remote  ----
```

```

Total number of entries are 6
TB2-VTEP2#show nvo vxlan nd-cache
VxLAN ND-CACHE Information
=====
VNID      Ip-Addr                Mac-Addr      Type      Age-Out  Retries-Left
-----
201      21:21::21:1          0000.0000.1111 Static Local  ----
101      11:11::11:1          0000.0000.1111 Static Local  ----
Total number of entries are 2
TB2-VTEP2#show nvo vxlan l3vni-map
L3VNI      L2VNI      IRB-interface
=====
1000      101        irb1001
1000      201        irb2001

TB2-VTEP2#show ip route vrf L3VRF1
Codes: K - kernel, C - connected, S - static, R - RIP, B - BGP
       O - OSPF, IA - OSPF inter area
       N1 - OSPF NSSA external type 1, N2 - OSPF NSSA external type 2
       E1 - OSPF external type 1, E2 - OSPF external type 2
       i - IS-IS, L1 - IS-IS level-1, L2 - IS-IS level-2,
       ia - IS-IS inter area, E - EVPN,
       v - vrf leaked
       * - candidate default

IP Route Table for VRF "L3VRF1"
C      11.11.11.0/24 is directly connected, irb1001, 00:19:37
C      21.21.21.0/24 is directly connected, irb2001, 00:19:37
C      127.0.0.0/8 is directly connected, lo.L3VRF1, 00:19:40

Gateway of last resort is not set
TB2-VTEP2#show ipv6 route vrf L3VRF1
IPv6 Routing Table
Codes: K - kernel route, C - connected, S - static, R - RIP, O - OSPF,
       IA - OSPF inter area, E1 - OSPF external type 1,
       E2 - OSPF external type 2, E - EVPN N1 - OSPF NSSA external type 1,
       N2 - OSPF NSSA external type 2, i - IS-IS, B - BGP
Timers: Uptime

IP Route Table for VRF "L3VRF1"
C      ::1/128 via ::, lo.L3VRF1, 00:19:40
C      11:11::/48 via ::, irb1001, 00:19:37
C      21:21::/48 via ::, irb2001, 00:19:37
C      fe80::/64 via ::, irb2001, 00:19:36
TB2-VTEP2#show ip route summary

-----
IP routing table name is Default-IP-Routing-Table(0)
-----
IP routing table maximum-paths : 8
Total number of IPv4 routes : 12
Total number of IPv4 paths : 12
Pending routes (due to route max reached): 0
Route Source      Networks
connected         3
ospf              9
Total            12
FIB               12

ECMP statistics (active in ASIC):
  Total number of IPv4 ECMP routes : 0
  Total number of IPv4 ECMP paths : 0
TB2-VTEP2#show ipv6 route summary

-----
IPv6 routing table name is Default-IPv6-Routing-Table(0)
-----
IPv6 routing table maximum-paths : 8
Total number of IPv6 routes : 2
Total number of IPv6 paths : 2
Pending routes (due to route max reached): 0
Route Source      Networks
connected         2

```

Total 2
 FIB 2

ECMP statistics (active in ASIC):

Total number of IPv6 ECMP routes : 0
 Total number of IPv6 ECMP paths : 0

TB2-VTEP2#show bgp l2vpn evpn

BGP table version is 6, local router ID is 2.2.2.2

Status codes: s suppressed, d damped, h history, * valid, > best, i - internal,
 l - labeled, S Stale

Origin codes: i - IGP, e - EGP, ? - incomplete

[EVPN route type]:[ESI]:[VNID]:[relevent route informantion]

- 1 - Ethernet Auto-discovery Route
- 2 - MAC/IP Route
- 3 - Inclusive Multicast Route
- 4 - Ethernet Segment Route
- 5 - Prefix Route

Network	Next Hop	Metric	LocPrf	Weight	Path	Peer	Encap
RD[11000:11]							
*>i[5]:[0]:[1000]:[24]:[11.11.11.0]:[0.0.0.0]:[1000]	1.1.1.1	0	100	0	?	1.1.1.1	VxLAN
*>i[5]:[0]:[1000]:[24]:[21.21.21.0]:[0.0.0.0]:[1000]	1.1.1.1	0	100	0	?	1.1.1.1	VxLAN
RD[41000:11]							
*>i[5]:[0]:[1000]:[24]:[11.11.11.0]:[0.0.0.0]:[1000]	4.4.4.4	0	100	0	?	4.4.4.4	VxLAN
*>i[5]:[0]:[1000]:[24]:[21.21.21.0]:[0.0.0.0]:[1000]	4.4.4.4	0	100	0	?	4.4.4.4	VxLAN
RD[51000:11]							
*>i[5]:[0]:[1000]:[24]:[11.11.11.0]:[0.0.0.0]:[1000]	5.5.5.5	0	100	0	?	5.5.5.5	VxLAN
*>i[5]:[0]:[1000]:[24]:[21.21.21.0]:[0.0.0.0]:[1000]	5.5.5.5	0	100	0	?	5.5.5.5	VxLAN
RD[1.1.1.1:1]							
*>i[1]:[00:00:00:00:00:22:22:00:00:00]:[4294967295]:[0]	1.1.1.1	0	100	0	i	1.1.1.1	VxLAN
*>i[4]:[00:00:00:00:00:22:22:00:00:00]:[32,1.1.1.1]	1.1.1.1	0	100	0	i	1.1.1.1	VxLAN
RD[1.1.1.1:11]							
*>i[1]:[00:00:00:00:00:22:22:00:00:00]:[101]:[101]	1.1.1.1	0	100	0	i	1.1.1.1	VxLAN
*>i[2]:[0]:[101]:[48,0000:0000:1111]:[32,11.11.11.1]:[101]	1.1.1.1	0	100	0	i	1.1.1.1	VxLAN
*>i[2]:[0]:[101]:[48,0000:0000:1111]:[128,11:11::11:1]:[101]	1.1.1.1	0	100	0	i	1.1.1.1	VxLAN
*>i[2]:[00:00:00:00:00:22:22:00:00:00]:[101]:[48,0000:2222:1010]:[32,11.11.11.51]:[101]	1.1.1.1	0	100	0	i	1.1.1.1	VxLAN
*>i[3]:[101]:[32,1.1.1.1]	1.1.1.1	0	100	0	i	1.1.1.1	VxLAN
RD[1.1.1.1:21]							
*>i[1]:[00:00:00:00:00:22:22:00:00:00]:[201]:[201]	1.1.1.1	0	100	0	i	1.1.1.1	VxLAN
*>i[2]:[0]:[201]:[48,0000:0000:1111]:[32,21.21.21.1]:[201]	1.1.1.1	0	100	0	i	1.1.1.1	VxLAN
*>i[2]:[0]:[201]:[48,0000:0000:1111]:[128,21:21::21:1]:[201]	1.1.1.1	0	100	0	i	1.1.1.1	VxLAN
*>i[2]:[00:00:00:00:00:22:22:00:00:00]:[201]:[48,0000:2222:1020]:[32,21.21.21.51]:[201]	1.1.1.1	0	100	0	i	1.1.1.1	VxLAN
*>i[3]:[201]:[32,1.1.1.1]	1.1.1.1	0	100	0	i	1.1.1.1	VxLAN
RD[2.2.2.2:1] VRF[evpn-gvrf-1]:							
*> [1]:[00:00:00:00:00:22:22:00:00:00]:[4294967295]:[0]	2.2.2.2	0	100	32768	i	-----	VxLAN
* i[4]:[00:00:00:00:00:22:22:00:00:00]:[32,1.1.1.1]							

```

1.1.1.1          0          100          0          i  1.1.1.1          VxLAN
*> [4]:[00:00:00:00:00:22:22:00:00:00]:[32,2.2.2.2]
2.2.2.2          0          100          32768         i  -----          VxLAN

RD[2.2.2.2:11] VRF[L2VRF1]:
* i[1]:[00:00:00:00:00:22:22:00:00:00]:[101]:[101]
1.1.1.1          0          100          0          i  1.1.1.1          VxLAN
*> 2.2.2.2          0          100          32768         i  -----          VxLAN
* i[1]:[00:00:00:00:00:22:22:00:00:00]:[4294967295]:[0]
1.1.1.1          0          100          0          i  1.1.1.1          VxLAN
* i[2]:[0]:[101]:[48,0000:0000:1111]:[32,11.11.11.1]:[101]
5.5.5.5          0          100          0          i  5.5.5.5          VxLAN
* i 4.4.4.4          0          100          0          i  4.4.4.4          VxLAN
* i 1.1.1.1          0          100          0          i  1.1.1.1          VxLAN
*> 2.2.2.2          0          100          32768         i  -----          VxLAN
* i[2]:[0]:[101]:[48,0000:0000:1111]:[128,11:11::11:1]:[101]
5.5.5.5          0          100          0          i  5.5.5.5          VxLAN
* i 4.4.4.4          0          100          0          i  4.4.4.4          VxLAN
* i 1.1.1.1          0          100          0          i  1.1.1.1          VxLAN
*> 2.2.2.2          0          100          32768         i  -----          VxLAN
* i[2]:[00:00:00:00:00:22:22:00:00:00]:[101]:[48,0000:2222:1010]:[32,11.11.11.51]:[101]
1.1.1.1          0          100          0          i  1.1.1.1          VxLAN
*> 2.2.2.2          0          100          32768         i  -----          VxLAN
* i[2]:[0]:[101]:[48,0000:5555:1010]:[32,11.11.11.201]:[101]
5.5.5.5          0          100          0          i  5.5.5.5          VxLAN
* i[3]:[101]:[32,1.1.1.1]
1.1.1.1          0          100          0          i  1.1.1.1          VxLAN
*> [3]:[101]:[32,2.2.2.2]
2.2.2.2          0          100          32768         i  -----          VxLAN
* i[3]:[101]:[32,4.4.4.4]
4.4.4.4          0          100          0          i  4.4.4.4          VxLAN
* i[3]:[101]:[32,5.5.5.5]
5.5.5.5          0          100          0          i  5.5.5.5          VxLAN

RD[2.2.2.2:21] VRF[L2VRF2]:
* i[1]:[00:00:00:00:00:22:22:00:00:00]:[201]:[201]
1.1.1.1          0          100          0          i  1.1.1.1          VxLAN
*> 2.2.2.2          0          100          32768         i  -----          VxLAN
* i[1]:[00:00:00:00:00:22:22:00:00:00]:[4294967295]:[0]
1.1.1.1          0          100          0          i  1.1.1.1          VxLAN
* i[2]:[0]:[201]:[48,0000:0000:1111]:[32,21.21.21.1]:[201]
5.5.5.5          0          100          0          i  5.5.5.5          VxLAN
* i 4.4.4.4          0          100          0          i  4.4.4.4          VxLAN
* i 1.1.1.1          0          100          0          i  1.1.1.1          VxLAN
*> 2.2.2.2          0          100          32768         i  -----          VxLAN
* i[2]:[0]:[201]:[48,0000:0000:1111]:[128,21:21::21:1]:[201]
5.5.5.5          0          100          0          i  5.5.5.5          VxLAN
* i 4.4.4.4          0          100          0          i  4.4.4.4          VxLAN
* i 1.1.1.1          0          100          0          i  1.1.1.1          VxLAN
*> 2.2.2.2          0          100          32768         i  -----          VxLAN
* i[2]:[00:00:00:00:00:22:22:00:00:00]:[201]:[48,0000:2222:1020]:[32,21.21.21.51]:[201]
1.1.1.1          0          100          0          i  1.1.1.1          VxLAN
*> 2.2.2.2          0          100          32768         i  -----          VxLAN
* i[2]:[0]:[201]:[48,0000:4444:1020]:[32,21.21.21.101]:[201]
4.4.4.4          0          100          0          i  4.4.4.4          VxLAN
* i[3]:[201]:[32,1.1.1.1]
1.1.1.1          0          100          0          i  1.1.1.1          VxLAN
*> [3]:[201]:[32,2.2.2.2]
2.2.2.2          0          100          32768         i  -----          VxLAN
* i[3]:[201]:[32,4.4.4.4]
4.4.4.4          0          100          0          i  4.4.4.4          VxLAN
* i[3]:[201]:[32,5.5.5.5]
5.5.5.5          0          100          0          i  5.5.5.5          VxLAN

RD[4.4.4.4:11]
*>i[2]:[0]:[101]:[48,0000:0000:1111]:[32,11.11.11.1]:[101]
4.4.4.4          0          100          0          i  4.4.4.4          VxLAN
*>i[2]:[0]:[101]:[48,0000:0000:1111]:[128,11:11::11:1]:[101]
4.4.4.4          0          100          0          i  4.4.4.4          VxLAN
*>i[3]:[101]:[32,4.4.4.4]
4.4.4.4          0          100          0          i  4.4.4.4          VxLAN

RD[4.4.4.4:21]

```

```

*>i[2]:[0]:[201]:[48,0000:0000:1111]:[32,21.21.21.1]:[201]
    4.4.4.4          0          100      0    i  4.4.4.4          VxLAN
*>i[2]:[0]:[201]:[48,0000:0000:1111]:[128,21:21::21:1]:[201]
    4.4.4.4          0          100      0    i  4.4.4.4          VxLAN
*>i[2]:[0]:[201]:[48,0000:4444:1020]:[32,21.21.21.101]:[201]
    4.4.4.4          0          100      0    i  4.4.4.4          VxLAN
*>i[3]:[201]:[32,4.4.4.4]
    4.4.4.4          0          100      0    i  4.4.4.4          VxLAN

RD[5.5.5.5:11]
*>i[2]:[0]:[101]:[48,0000:0000:1111]:[32,11.11.11.1]:[101]
    5.5.5.5          0          100      0    i  5.5.5.5          VxLAN
*>i[2]:[0]:[101]:[48,0000:0000:1111]:[128,11:11::11:1]:[101]
    5.5.5.5          0          100      0    i  5.5.5.5          VxLAN
*>i[2]:[0]:[101]:[48,0000:5555:1010]:[32,11.11.11.201]:[101]
    5.5.5.5          0          100      0    i  5.5.5.5          VxLAN
*>i[3]:[101]:[32,5.5.5.5]
    5.5.5.5          0          100      0    i  5.5.5.5          VxLAN

RD[5.5.5.5:21]
*>i[2]:[0]:[201]:[48,0000:0000:1111]:[32,21.21.21.1]:[201]
    5.5.5.5          0          100      0    i  5.5.5.5          VxLAN
*>i[2]:[0]:[201]:[48,0000:0000:1111]:[128,21:21::21:1]:[201]
    5.5.5.5          0          100      0    i  5.5.5.5          VxLAN
*>i[3]:[201]:[32,5.5.5.5]
    5.5.5.5          0          100      0    i  5.5.5.5          VxLAN

Total number of prefixes 55
TB2-VTEP2#

```

VTEP4

TB2-VTEP4#show nvo vxlan tunnel

VxLAN Network tunnel Entries

Source	Destination	Status	Up/Down	Update
4.4.4.4	2.2.2.2	Installed	00:18:55	00:18:55
4.4.4.4	1.1.1.1	Installed	00:18:55	00:18:55
4.4.4.4	5.5.5.5	Installed	00:13:27	00:13:27

Total number of entries are 3

TB2-VTEP4#show nvo vxlan

VxLAN Information

=====

Codes: NW - Network Port
 AC - Access Port
 (u) - Untagged

VNID	VNI-Name	VNI-Type	Type	Interface	ESI	VLAN	DF-Status	Src-Addr	Dst-Addr
101	VNI-101	L2	NW	----	----	----	----	4.4.4.4	2.2.2.2
101	VNI-101	L2	NW	----	----	----	----	4.4.4.4	1.1.1.1
101	VNI-101	L2	NW	----	----	----	----	4.4.4.4	5.5.5.5
201	VNI-201	L2	NW	----	----	----	----	4.4.4.4	2.2.2.2
201	VNI-201	L2	NW	----	----	----	----	4.4.4.4	1.1.1.1
201	VNI-201	L2	NW	----	----	----	----	4.4.4.4	5.5.5.5
201	VNI-201	--	AC	sa1	---	Single Homed Port	---	20	----

Total number of entries are 7

TB2-VTEP4#show nvo vxlan arp-cache

VxLAN ARP-CACHE Information

=====

VNID	Ip-Addr	Mac-Addr	Type	Age-Out	Retries-Left
201	21.21.21.51	0000.2222.1020	Static Remote	----	----
201	21.21.21.1	0000.0000.1111	Static Local	----	----
201	21.21.21.101	0000.4444.1020	Static Local	----	----
101	11.11.11.51	0000.2222.1010	Static Remote	----	----
101	11.11.11.1	0000.0000.1111	Static Local	----	----
101	11.11.11.201	0000.5555.1010	Static Remote	----	----

```

Total number of entries are 6
TB2-VTEP4#show nvo vxlan nd-cache
VxLAN ND-CACHE Information
=====
VNID      Ip-Addr                Mac-Addr      Type      Age-Out  Retries-Left
-----
201      21:21::21:1          0000.0000.1111 Static Local  ----
101      11:11::11:1          0000.0000.1111 Static Local  ----
Total number of entries are 2
TB2-VTEP4#show nvo vxlan l3vni-map
L3VNI      L2VNI      IRB-interface
=====
1000      101        irb1001
1000      201        irb2001

TB2-VTEP4#show ip route vrf L3VRF1
Codes: K - kernel, C - connected, S - static, R - RIP, B - BGP
       O - OSPF, IA - OSPF inter area
       N1 - OSPF NSSA external type 1, N2 - OSPF NSSA external type 2
       E1 - OSPF external type 1, E2 - OSPF external type 2
       i - IS-IS, L1 - IS-IS level-1, L2 - IS-IS level-2,
       ia - IS-IS inter area, E - EVPN,
       v - vrf leaked
       * - candidate default

IP Route Table for VRF "L3VRF1"
C      11.11.11.0/24 is directly connected, irb1001, 00:19:46
C      21.21.21.0/24 is directly connected, irb2001, 00:19:46
C      127.0.0.0/8 is directly connected, lo.L3VRF1, 00:19:49

Gateway of last resort is not set
TB2-VTEP4#show ipv6 route vrf L3VRF1
IPv6 Routing Table
Codes: K - kernel route, C - connected, S - static, R - RIP, O - OSPF,
       IA - OSPF inter area, E1 - OSPF external type 1,
       E2 - OSPF external type 2, E - EVPN N1 - OSPF NSSA external type 1,
       N2 - OSPF NSSA external type 2, i - IS-IS, B - BGP
Timers: Uptime

IP Route Table for VRF "L3VRF1"
C      ::1/128 via ::, lo.L3VRF1, 00:19:49
C      11:11::/48 via ::, irb1001, 00:19:46
C      21:21::/48 via ::, irb2001, 00:19:46
C      fe80::/64 via ::, irb2001, 00:19:46
TB2-VTEP4#show ip route summary

-----
IP routing table name is Default-IP-Routing-Table(0)
-----
IP routing table maximum-paths : 8
Total number of IPv4 routes : 12
Total number of IPv4 paths : 12
Pending routes (due to route max reached): 0
Route Source      Networks
connected         3
ospf              9
Total            12
FIB              12

ECMP statistics (active in ASIC):
Total number of IPv4 ECMP routes : 0
Total number of IPv4 ECMP paths : 0
TB2-VTEP4#show ipv6 route summary

-----
IPv6 routing table name is Default-IPv6-Routing-Table(0)
-----
IPv6 routing table maximum-paths : 8
Total number of IPv6 routes : 2
Total number of IPv6 paths : 2
Pending routes (due to route max reached): 0
Route Source      Networks
connected         2

```



```
Total      2
FIB        2
```

ECMP statistics (active in ASIC):

```
Total number of IPv6 ECMP routes : 0
Total number of IPv6 ECMP paths  : 0
```

```
TB2-VTEP4#show bgp l2vpn evpn
```

```
BGP table version is 4, local router ID is 4.4.4.4
```

```
Status codes: s suppressed, d damped, h history, * valid, > best, i - internal,
               l - labeled, S Stale
```

```
Origin codes: i - IGP, e - EGP, ? - incomplete
```

```
[EVPN route type]:[ESI]:[VNID]:[relevant route information]
```

```
1 - Ethernet Auto-discovery Route
2 - MAC/IP Route
3 - Inclusive Multicast Route
4 - Ethernet Segment Route
5 - Prefix Route
```

Network	Next Hop	Metric	LocPrf	Weight	Path	Peer	Encap
RD[11000:11]							
*>i [5]:[0]:[1000]:[24]:[11.11.11.0]:[0.0.0.0]:[1000]	1.1.1.1	0	100	0	?	1.1.1.1	VxLAN
*>i [5]:[0]:[1000]:[24]:[21.21.21.0]:[0.0.0.0]:[1000]	1.1.1.1	0	100	0	?	1.1.1.1	VxLAN
RD[21000:11]							
*>i [5]:[0]:[1000]:[24]:[11.11.11.0]:[0.0.0.0]:[1000]	2.2.2.2	0	100	0	?	2.2.2.2	VxLAN
*>i [5]:[0]:[1000]:[24]:[21.21.21.0]:[0.0.0.0]:[1000]	2.2.2.2	0	100	0	?	2.2.2.2	VxLAN
RD[51000:11]							
*>i [5]:[0]:[1000]:[24]:[11.11.11.0]:[0.0.0.0]:[1000]	5.5.5.5	0	100	0	?	5.5.5.5	VxLAN
*>i [5]:[0]:[1000]:[24]:[21.21.21.0]:[0.0.0.0]:[1000]	5.5.5.5	0	100	0	?	5.5.5.5	VxLAN
RD[1.1.1.1:1]							
*>i [1]:[00:00:00:00:00:22:22:00:00:00]:[4294967295]:[0]	1.1.1.1	0	100	0	i	1.1.1.1	VxLAN
*>i [4]:[00:00:00:00:00:22:22:00:00:00]:[32,1.1.1.1]	1.1.1.1	0	100	0	i	1.1.1.1	VxLAN
RD[1.1.1.1:11]							
*>i [1]:[00:00:00:00:00:22:22:00:00:00]:[101]:[101]	1.1.1.1	0	100	0	i	1.1.1.1	VxLAN
*>i [2]:[0]:[101]:[48,0000:0000:1111]:[32,11.11.11.1]:[101]	1.1.1.1	0	100	0	i	1.1.1.1	VxLAN
*>i [2]:[0]:[101]:[48,0000:0000:1111]:[128,11:11::11:1]:[101]	1.1.1.1	0	100	0	i	1.1.1.1	VxLAN
*>i [2]:[00:00:00:00:00:22:22:00:00:00]:[101]:[48,0000:2222:1010]:[32,11.11.11.51]:[101]	1.1.1.1	0	100	0	i	1.1.1.1	VxLAN
*>i [3]:[101]:[32,1.1.1.1]	1.1.1.1	0	100	0	i	1.1.1.1	VxLAN
RD[1.1.1.1:21]							
*>i [1]:[00:00:00:00:00:22:22:00:00:00]:[201]:[201]	1.1.1.1	0	100	0	i	1.1.1.1	VxLAN
*>i [2]:[0]:[201]:[48,0000:0000:1111]:[32,21.21.21.1]:[201]	1.1.1.1	0	100	0	i	1.1.1.1	VxLAN
*>i [2]:[0]:[201]:[48,0000:0000:1111]:[128,21:21::21:1]:[201]	1.1.1.1	0	100	0	i	1.1.1.1	VxLAN
*>i [2]:[00:00:00:00:00:22:22:00:00:00]:[201]:[48,0000:2222:1020]:[32,21.21.21.51]:[201]	1.1.1.1	0	100	0	i	1.1.1.1	VxLAN
*>i [3]:[201]:[32,1.1.1.1]	1.1.1.1	0	100	0	i	1.1.1.1	VxLAN
RD[2.2.2.2:1]							
*>i [1]:[00:00:00:00:00:22:22:00:00:00]:[4294967295]:[0]	2.2.2.2	0	100	0	i	2.2.2.2	VxLAN
*>i [4]:[00:00:00:00:00:22:22:00:00:00]:[32,2.2.2.2]							

```

                2.2.2.2                0                100                0                i 2.2.2.2                VxLAN

RD[2.2.2.2:11]
*>i [1]:[00:00:00:00:00:22:22:00:00:00]:[101]:[101]
                2.2.2.2                0                100                0                i 2.2.2.2                VxLAN
*>i [2]:[0]:[101]:[48,0000:0000:1111]:[32,11.11.11.1]:[101]
                2.2.2.2                0                100                0                i 2.2.2.2                VxLAN
*>i [2]:[0]:[101]:[48,0000:0000:1111]:[128,11:11::11:1]:[101]
                2.2.2.2                0                100                0                i 2.2.2.2                VxLAN
*>i [2]:[00:00:00:00:00:22:22:00:00:00]:[101]:[48,0000:2222:1010]:[32,11.11.11.51]:[101]
                2.2.2.2                0                100                0                i 2.2.2.2                VxLAN
*>i [3]:[101]:[32,2.2.2.2]
                2.2.2.2                0                100                0                i 2.2.2.2                VxLAN

RD[2.2.2.2:21]
*>i [1]:[00:00:00:00:00:22:22:00:00:00]:[201]:[201]
                2.2.2.2                0                100                0                i 2.2.2.2                VxLAN
*>i [2]:[0]:[201]:[48,0000:0000:1111]:[32,21.21.21.1]:[201]
                2.2.2.2                0                100                0                i 2.2.2.2                VxLAN
*>i [2]:[0]:[201]:[48,0000:0000:1111]:[128,21:21::21:1]:[201]
                2.2.2.2                0                100                0                i 2.2.2.2                VxLAN
*>i [2]:[00:00:00:00:00:22:22:00:00:00]:[201]:[48,0000:2222:1020]:[32,21.21.21.51]:[201]
                2.2.2.2                0                100                0                i 2.2.2.2                VxLAN
*>i [3]:[201]:[32,2.2.2.2]
                2.2.2.2                0                100                0                i 2.2.2.2                VxLAN

RD[4.4.4.4:11] VRF[L2VRF1]:
* i [1]:[00:00:00:00:00:22:22:00:00:00]:[101]:[101]
                1.1.1.1                0                100                0                i 1.1.1.1                VxLAN
* i [1]:[00:00:00:00:00:22:22:00:00:00]:[4294967295]:[0]
                2.2.2.2                0                100                0                i 2.2.2.2                VxLAN
* i [1]:[00:00:00:00:00:22:22:00:00:00]:[4294967295]:[0]
                1.1.1.1                0                100                0                i 1.1.1.1                VxLAN
* i [1]:[00:00:00:00:00:22:22:00:00:00]:[4294967295]:[0]
                2.2.2.2                0                100                0                i 2.2.2.2                VxLAN
* i [2]:[0]:[101]:[48,0000:0000:1111]:[32,11.11.11.1]:[101]
                5.5.5.5                0                100                0                i 5.5.5.5                VxLAN
* i [2]:[0]:[101]:[48,0000:0000:1111]:[32,11.11.11.1]:[101]
                1.1.1.1                0                100                0                i 1.1.1.1                VxLAN
* i [2]:[0]:[101]:[48,0000:0000:1111]:[32,11.11.11.1]:[101]
                2.2.2.2                0                100                0                i 2.2.2.2                VxLAN
*> [2]:[0]:[101]:[48,0000:0000:1111]:[128,11:11::11:1]:[101]
                4.4.4.4                0                100                32768                i -----                VxLAN
* i [2]:[0]:[101]:[48,0000:0000:1111]:[128,11:11::11:1]:[101]
                5.5.5.5                0                100                0                i 5.5.5.5                VxLAN
* i [2]:[0]:[101]:[48,0000:0000:1111]:[128,11:11::11:1]:[101]
                1.1.1.1                0                100                0                i 1.1.1.1                VxLAN
* i [2]:[0]:[101]:[48,0000:0000:1111]:[128,11:11::11:1]:[101]
                2.2.2.2                0                100                0                i 2.2.2.2                VxLAN
*> [2]:[0]:[101]:[48,0000:0000:1111]:[128,11:11::11:1]:[101]
                4.4.4.4                0                100                32768                i -----                VxLAN
* i [2]:[00:00:00:00:00:22:22:00:00:00]:[101]:[48,0000:2222:1010]:[32,11.11.11.51]:[101]
                1.1.1.1                0                100                0                i 1.1.1.1                VxLAN
* i [2]:[00:00:00:00:00:22:22:00:00:00]:[101]:[48,0000:2222:1010]:[32,11.11.11.51]:[101]
                2.2.2.2                0                100                0                i 2.2.2.2                VxLAN
* i [2]:[0]:[101]:[48,0000:5555:1010]:[32,11.11.11.201]:[101]
                5.5.5.5                0                100                0                i 5.5.5.5                VxLAN
* i [3]:[101]:[32,1.1.1.1]
                1.1.1.1                0                100                0                i 1.1.1.1                VxLAN
* i [3]:[101]:[32,2.2.2.2]
                2.2.2.2                0                100                0                i 2.2.2.2                VxLAN
*> [3]:[101]:[32,4.4.4.4]
                4.4.4.4                0                100                32768                i -----                VxLAN
* i [3]:[101]:[32,5.5.5.5]
                5.5.5.5                0                100                0                i 5.5.5.5                VxLAN

RD[4.4.4.4:21] VRF[L2VRF2]:
* i [1]:[00:00:00:00:00:22:22:00:00:00]:[201]:[201]
                1.1.1.1                0                100                0                i 1.1.1.1                VxLAN
* i [1]:[00:00:00:00:00:22:22:00:00:00]:[4294967295]:[0]
                2.2.2.2                0                100                0                i 2.2.2.2                VxLAN
* i [1]:[00:00:00:00:00:22:22:00:00:00]:[4294967295]:[0]
                1.1.1.1                0                100                0                i 1.1.1.1                VxLAN
* i [1]:[00:00:00:00:00:22:22:00:00:00]:[4294967295]:[0]
                2.2.2.2                0                100                0                i 2.2.2.2                VxLAN
* i [2]:[0]:[201]:[48,0000:0000:1111]:[32,21.21.21.1]:[201]
                5.5.5.5                0                100                0                i 5.5.5.5                VxLAN
* i [2]:[0]:[201]:[48,0000:0000:1111]:[32,21.21.21.1]:[201]
                1.1.1.1                0                100                0                i 1.1.1.1                VxLAN
* i [2]:[0]:[201]:[48,0000:0000:1111]:[32,21.21.21.1]:[201]
                2.2.2.2                0                100                0                i 2.2.2.2                VxLAN
*> [2]:[0]:[201]:[48,0000:0000:1111]:[128,21:21::21:1]:[201]
                4.4.4.4                0                100                32768                i -----                VxLAN
* i [2]:[0]:[201]:[48,0000:0000:1111]:[128,21:21::21:1]:[201]
                5.5.5.5                0                100                0                i 5.5.5.5                VxLAN
* i [2]:[0]:[201]:[48,0000:0000:1111]:[128,21:21::21:1]:[201]
                1.1.1.1                0                100                0                i 1.1.1.1                VxLAN
* i [2]:[0]:[201]:[48,0000:0000:1111]:[128,21:21::21:1]:[201]
                2.2.2.2                0                100                0                i 2.2.2.2                VxLAN

```

```

*> 4.4.4.4 0 100 32768 i ----- VxLAN
*i [2]:[00:00:00:00:00:22:22:00:00:00]:[201]:[48,0000:2222:1020]:[32,21.21.21.51]:[201]
  1.1.1.1 0 100 0 i 1.1.1.1 VxLAN
*i 2.2.2.2 0 100 0 i 2.2.2.2 VxLAN
*> [2]:[0]:[201]:[48,0000:4444:1020]:[32,21.21.21.101]:[201]
  4.4.4.4 0 100 32768 i ----- VxLAN
*i [3]:[201]:[32,1.1.1.1]
  1.1.1.1 0 100 0 i 1.1.1.1 VxLAN
*i [3]:[201]:[32,2.2.2.2]
  2.2.2.2 0 100 0 i 2.2.2.2 VxLAN
*> [3]:[201]:[32,4.4.4.4]
  4.4.4.4 0 100 32768 i ----- VxLAN
*i [3]:[201]:[32,5.5.5.5]
  5.5.5.5 0 100 0 i 5.5.5.5 VxLAN

RD[5.5.5.5:11]
*>i [2]:[0]:[101]:[48,0000:0000:1111]:[32,11.11.11.1]:[101]
  5.5.5.5 0 100 0 i 5.5.5.5 VxLAN
*>i [2]:[0]:[101]:[48,0000:0000:1111]:[128,11:11::11:1]:[101]
  5.5.5.5 0 100 0 i 5.5.5.5 VxLAN
*>i [2]:[0]:[101]:[48,0000:5555:1010]:[32,11.11.11.201]:[101]
  5.5.5.5 0 100 0 i 5.5.5.5 VxLAN
*>i [3]:[101]:[32,5.5.5.5]
  5.5.5.5 0 100 0 i 5.5.5.5 VxLAN

RD[5.5.5.5:21]
*>i [2]:[0]:[201]:[48,0000:0000:1111]:[32,21.21.21.1]:[201]
  5.5.5.5 0 100 0 i 5.5.5.5 VxLAN
*>i [2]:[0]:[201]:[48,0000:0000:1111]:[128,21:21::21:1]:[201]
  5.5.5.5 0 100 0 i 5.5.5.5 VxLAN
*>i [3]:[201]:[32,5.5.5.5]
  5.5.5.5 0 100 0 i 5.5.5.5 VxLAN

```

Total number of prefixes 57
TB2-VTEP4#

VTEP5

TB2-VTEP5#show nvo vxlan tunnel

VxLAN Network tunnel Entries

Source	Destination	Status	Up/Down	Update
5.5.5.5	2.2.2.2	Installed	00:13:36	00:13:36
5.5.5.5	4.4.4.4	Installed	00:13:36	00:13:36
5.5.5.5	1.1.1.1	Installed	00:13:36	00:13:36

Total number of entries are 3

TB2-VTEP5#show nvo vxlan

VxLAN Information
 =====
 Codes: NW - Network Port
 AC - Access Port
 (u) - Untagged

VNID	VNI-Name	VNI-Type	Type	Interface	ESI	VLAN	DF-Status	Src-Addr	Dst-Addr
101	VNI-101	L2	NW	----	----	----	----	5.5.5.5	2.2.2.2
101	VNI-101	L2	NW	----	----	----	----	5.5.5.5	4.4.4.4
101	VNI-101	L2	NW	----	----	----	----	5.5.5.5	1.1.1.1
101	VNI-101	--	AC	xe48	---	Single Homed Port	---	10	----
201	VNI-201	L2	NW	----	----	----	----	5.5.5.5	2.2.2.2
201	VNI-201	L2	NW	----	----	----	----	5.5.5.5	4.4.4.4
201	VNI-201	L2	NW	----	----	----	----	5.5.5.5	1.1.1.1

Total number of entries are 7

TB2-VTEP5#show nvo vxlan arp-cache

VxLAN ARP-CACHE Information
 =====

VNID	Ip-Addr	Mac-Addr	Type	Age-Out	Retries-Left
201	21.21.21.51	0000.2222.1020	Static Remote	----	----

```

201      21.21.21.1      0000.0000.1111 Static Local ----
201      21.21.21.101    0000.4444.1020 Static Remote ----
101      11.11.11.51     0000.2222.1010 Static Remote ----
101      11.11.11.1      0000.0000.1111 Static Local ----
101      11.11.11.201    0000.5555.1010 Static Local ----

```

Total number of entries are 6

TB2-VTEP5#show nvo vxlan nd-cache

VxLAN ND-CACHE Information

=====

VNID	Ip-Addr	Mac-Addr	Type	Age-Out	Retries-Left
201	21:21::21:1	0000.0000.1111	Static Local	----	
101	11:11::11:1	0000.0000.1111	Static Local	----	

Total number of entries are 2

TB2-VTEP5#show nvo vxlan l3vni-map

L3VNI L2VNI IRB-interface

=====

1000	101	irb1001
1000	201	irb2001

TB2-VTEP5#show ip route vrf L3VRF1

Codes: K - kernel, C - connected, S - static, R - RIP, B - BGP

O - OSPF, IA - OSPF inter area

N1 - OSPF NSSA external type 1, N2 - OSPF NSSA external type 2

E1 - OSPF external type 1, E2 - OSPF external type 2

i - IS-IS, L1 - IS-IS level-1, L2 - IS-IS level-2,

ia - IS-IS inter area, E - EVPN,

v - vrf leaked

* - candidate default

IP Route Table for VRF "L3VRF1"

```

C      11.11.11.0/24 is directly connected, irb1001, 00:14:07
C      21.21.21.0/24 is directly connected, irb2001, 00:14:05
C      127.0.0.0/8 is directly connected, lo.L3VRF1, 00:20:00

```

Gateway of last resort is not set

TB2-VTEP5#show ipv6 route vrf L3VRF1

IPv6 Routing Table

Codes: K - kernel route, C - connected, S - static, R - RIP, O - OSPF,

IA - OSPF inter area, E1 - OSPF external type 1,

E2 - OSPF external type 2, E - EVPN N1 - OSPF NSSA external type 1,

N2 - OSPF NSSA external type 2, i - IS-IS, B - BGP

Timers: Uptime

IP Route Table for VRF "L3VRF1"

```

C      ::1/128 via ::, lo.L3VRF1, 00:20:00
C      11:11::/48 via ::, irb1001, 00:14:07
C      21:21::/48 via ::, irb2001, 00:14:05
C      fe80::/64 via ::, irb2001, 00:14:05

```

TB2-VTEP5#show ip route summary

IP routing table name is Default-IP-Routing-Table(0)

```

IP routing table maximum-paths : 8
Total number of IPv4 routes : 12
Total number of IPv4 paths : 12
Pending routes (due to route max reached): 0
Route Source Networks
connected 3
ospf 9
Total 12
FIB 12

```

ECMP statistics (active in ASIC):

Total number of IPv4 ECMP routes : 0

Total number of IPv4 ECMP paths : 0

TB2-VTEP5#show ipv6 route summary

IPv6 routing table name is Default-IPv6-Routing-Table(0)

IPv6 routing table maximum-paths : 8

```

Total number of IPv6 routes      : 2
Total number of IPv6 paths      : 2
Pending routes (due to route max reached): 0
Route Source   Networks
connected      2
Total          2
FIB            2

```

ECMP statistics (active in ASIC):

```

Total number of IPv6 ECMP routes : 0
Total number of IPv6 ECMP paths  : 0

```

TB2-VTEP5#show bgp l2vpn evpn

BGP table version is 7, local router ID is 5.5.5.5

Status codes: s suppressed, d damped, h history, * valid, > best, i - internal,
l - labeled, S Stale

Origin codes: i - IGP, e - EGP, ? - incomplete

[EVPN route type]:[ESI]:[VNID]:[relevent route informantion]

1 - Ethernet Auto-discovery Route

2 - MAC/IP Route

3 - Inclusive Multicast Route

4 - Ethernet Segment Route

5 - Prefix Route

Network	Next Hop	Metric	LocPrf	Weight	Path	Peer	Encap
RD[11000:11]							
*>i [5]:[0]:[1000]:[24]:[11.11.11.0]:[0.0.0.0]:[1000]	1.1.1.1	0	100	0	?	1.1.1.1	VxLAN
*>i [5]:[0]:[1000]:[24]:[21.21.21.0]:[0.0.0.0]:[1000]	1.1.1.1	0	100	0	?	1.1.1.1	VxLAN
RD[21000:11]							
*>i [5]:[0]:[1000]:[24]:[11.11.11.0]:[0.0.0.0]:[1000]	2.2.2.2	0	100	0	?	2.2.2.2	VxLAN
*>i [5]:[0]:[1000]:[24]:[21.21.21.0]:[0.0.0.0]:[1000]	2.2.2.2	0	100	0	?	2.2.2.2	VxLAN
RD[41000:11]							
*>i [5]:[0]:[1000]:[24]:[11.11.11.0]:[0.0.0.0]:[1000]	4.4.4.4	0	100	0	?	4.4.4.4	VxLAN
*>i [5]:[0]:[1000]:[24]:[21.21.21.0]:[0.0.0.0]:[1000]	4.4.4.4	0	100	0	?	4.4.4.4	VxLAN
RD[1.1.1.1:1]							
*>i [1]:[00:00:00:00:00:22:22:00:00:00]:[4294967295]:[0]	1.1.1.1	0	100	0	i	1.1.1.1	VxLAN
*>i [4]:[00:00:00:00:00:22:22:00:00:00]:[32,1.1.1.1]	1.1.1.1	0	100	0	i	1.1.1.1	VxLAN
RD[1.1.1.1:11]							
*>i [1]:[00:00:00:00:00:22:22:00:00:00]:[101]:[101]	1.1.1.1	0	100	0	i	1.1.1.1	VxLAN
*>i [2]:[0]:[101]:[48,0000:0000:1111]:[32,11.11.11.1]:[101]	1.1.1.1	0	100	0	i	1.1.1.1	VxLAN
*>i [2]:[0]:[101]:[48,0000:0000:1111]:[128,11:11::11:1]:[101]	1.1.1.1	0	100	0	i	1.1.1.1	VxLAN
*>i [2]:[00:00:00:00:00:22:22:00:00:00]:[101]:[48,0000:2222:1010]:[32,11.11.11.51]:[101]	1.1.1.1	0	100	0	i	1.1.1.1	VxLAN
*>i [3]:[101]:[32,1.1.1.1]	1.1.1.1	0	100	0	i	1.1.1.1	VxLAN
RD[1.1.1.1:21]							
*>i [1]:[00:00:00:00:00:22:22:00:00:00]:[201]:[201]	1.1.1.1	0	100	0	i	1.1.1.1	VxLAN
*>i [2]:[0]:[201]:[48,0000:0000:1111]:[32,21.21.21.1]:[201]	1.1.1.1	0	100	0	i	1.1.1.1	VxLAN
*>i [2]:[0]:[201]:[48,0000:0000:1111]:[128,21:21::21:1]:[201]	1.1.1.1	0	100	0	i	1.1.1.1	VxLAN
*>i [2]:[00:00:00:00:00:22:22:00:00:00]:[201]:[48,0000:2222:1020]:[32,21.21.21.51]:[201]	1.1.1.1	0	100	0	i	1.1.1.1	VxLAN
*>i [3]:[201]:[32,1.1.1.1]	1.1.1.1	0	100	0	i	1.1.1.1	VxLAN

```

RD[2.2.2.2:1]
*>i [1]:[00:00:00:00:00:22:22:00:00:00]:[4294967295]:[0]
      2.2.2.2          0          100      0      i  2.2.2.2          VxLAN
*>i [4]:[00:00:00:00:00:22:22:00:00:00]:[32,2.2.2.2]
      2.2.2.2          0          100      0      i  2.2.2.2          VxLAN

RD[2.2.2.2:11]
*>i [1]:[00:00:00:00:00:22:22:00:00:00]:[101]:[101]
      2.2.2.2          0          100      0      i  2.2.2.2          VxLAN
*>i [2]:[0]:[101]:[48,0000:0000:1111]:[32,11.11.11.1]:[101]
      2.2.2.2          0          100      0      i  2.2.2.2          VxLAN
*>i [2]:[0]:[101]:[48,0000:0000:1111]:[128,11:11::11:1]:[101]
      2.2.2.2          0          100      0      i  2.2.2.2          VxLAN
*>i [2]:[00:00:00:00:00:22:22:00:00:00]:[101]:[48,0000:2222:1010]:[32,11.11.11.51]:[101]
      2.2.2.2          0          100      0      i  2.2.2.2          VxLAN
*>i [3]:[101]:[32,2.2.2.2]
      2.2.2.2          0          100      0      i  2.2.2.2          VxLAN

RD[2.2.2.2:21]
*>i [1]:[00:00:00:00:00:22:22:00:00:00]:[201]:[201]
      2.2.2.2          0          100      0      i  2.2.2.2          VxLAN
*>i [2]:[0]:[201]:[48,0000:0000:1111]:[32,21.21.21.1]:[201]
      2.2.2.2          0          100      0      i  2.2.2.2          VxLAN
*>i [2]:[0]:[201]:[48,0000:0000:1111]:[128,21:21::21:1]:[201]
      2.2.2.2          0          100      0      i  2.2.2.2          VxLAN
*>i [2]:[00:00:00:00:00:22:22:00:00:00]:[201]:[48,0000:2222:1020]:[32,21.21.21.51]:[201]
      2.2.2.2          0          100      0      i  2.2.2.2          VxLAN
*>i [3]:[201]:[32,2.2.2.2]
      2.2.2.2          0          100      0      i  2.2.2.2          VxLAN

RD[4.4.4.4:11]
*>i [2]:[0]:[101]:[48,0000:0000:1111]:[32,11.11.11.1]:[101]
      4.4.4.4          0          100      0      i  4.4.4.4          VxLAN
*>i [2]:[0]:[101]:[48,0000:0000:1111]:[128,11:11::11:1]:[101]
      4.4.4.4          0          100      0      i  4.4.4.4          VxLAN
*>i [3]:[101]:[32,4.4.4.4]
      4.4.4.4          0          100      0      i  4.4.4.4          VxLAN

RD[4.4.4.4:21]
*>i [2]:[0]:[201]:[48,0000:0000:1111]:[32,21.21.21.1]:[201]
      4.4.4.4          0          100      0      i  4.4.4.4          VxLAN
*>i [2]:[0]:[201]:[48,0000:0000:1111]:[128,21:21::21:1]:[201]
      4.4.4.4          0          100      0      i  4.4.4.4          VxLAN
*>i [2]:[0]:[201]:[48,0000:4444:1020]:[32,21.21.21.101]:[201]
      4.4.4.4          0          100      0      i  4.4.4.4          VxLAN
*>i [3]:[201]:[32,4.4.4.4]
      4.4.4.4          0          100      0      i  4.4.4.4          VxLAN

RD[5.5.5.5:11] VRF[L2VRF1]:
* i [1]:[00:00:00:00:00:22:22:00:00:00]:[101]:[101]
      1.1.1.1          0          100      0      i  1.1.1.1          VxLAN
* i [1]:[00:00:00:00:00:22:22:00:00:00]:[4294967295]:[0]
      2.2.2.2          0          100      0      i  2.2.2.2          VxLAN
* i [1]:[00:00:00:00:00:22:22:00:00:00]:[4294967295]:[0]
      1.1.1.1          0          100      0      i  1.1.1.1          VxLAN
* i [1]:[00:00:00:00:00:22:22:00:00:00]:[4294967295]:[0]
      2.2.2.2          0          100      0      i  2.2.2.2          VxLAN
*> [2]:[0]:[101]:[48,0000:0000:1111]:[32,11.11.11.1]:[101]
      5.5.5.5          0          100      32768  i  -----          VxLAN
* i [2]:[0]:[101]:[48,0000:0000:1111]:[32,11.11.11.1]:[101]
      4.4.4.4          0          100      0      i  4.4.4.4          VxLAN
* i [2]:[0]:[101]:[48,0000:0000:1111]:[32,11.11.11.1]:[101]
      2.2.2.2          0          100      0      i  2.2.2.2          VxLAN
* i [2]:[0]:[101]:[48,0000:0000:1111]:[32,11.11.11.1]:[101]
      1.1.1.1          0          100      0      i  1.1.1.1          VxLAN
*> [2]:[0]:[101]:[48,0000:0000:1111]:[128,11:11::11:1]:[101]
      5.5.5.5          0          100      32768  i  -----          VxLAN
* i [2]:[0]:[101]:[48,0000:0000:1111]:[128,11:11::11:1]:[101]
      4.4.4.4          0          100      0      i  4.4.4.4          VxLAN
* i [2]:[0]:[101]:[48,0000:0000:1111]:[128,11:11::11:1]:[101]
      2.2.2.2          0          100      0      i  2.2.2.2          VxLAN
* i [2]:[0]:[101]:[48,0000:0000:1111]:[128,11:11::11:1]:[101]
      1.1.1.1          0          100      0      i  1.1.1.1          VxLAN
* i [2]:[00:00:00:00:00:22:22:00:00:00]:[101]:[48,0000:2222:1010]:[32,11.11.11.51]:[101]
      1.1.1.1          0          100      0      i  1.1.1.1          VxLAN
* i [2]:[00:00:00:00:00:22:22:00:00:00]:[101]:[48,0000:2222:1010]:[32,11.11.11.51]:[101]
      2.2.2.2          0          100      0      i  2.2.2.2          VxLAN
*> [2]:[0]:[101]:[48,0000:5555:1010]:[32,11.11.11.201]:[101]
      5.5.5.5          0          100      32768  i  -----          VxLAN
* i [3]:[101]:[32,1.1.1.1]
      1.1.1.1          0          100      0      i  1.1.1.1          VxLAN

```

```

* i [3]:[101]:[32,2.2.2.2]
    2.2.2.2          0      100      0      i  2.2.2.2      VxLAN
* i [3]:[101]:[32,4.4.4.4]
    4.4.4.4          0      100      0      i  4.4.4.4      VxLAN
*> [3]:[101]:[32,5.5.5.5]
    5.5.5.5          0      100      32768 i  -----      VxLAN

RD[5.5.5.5:21] VRF[L2VRF2]:
* i [1]:[00:00:00:00:00:22:22:00:00:00]:[201]:[201]
    1.1.1.1          0      100      0      i  1.1.1.1      VxLAN
* i [1]:[00:00:00:00:00:22:22:00:00:00]:[4294967295]:[0]
    2.2.2.2          0      100      0      i  2.2.2.2      VxLAN
* i [1]:[00:00:00:00:00:22:22:00:00:00]:[4294967295]:[0]
    1.1.1.1          0      100      0      i  1.1.1.1      VxLAN
* i [1]:[00:00:00:00:00:22:22:00:00:00]:[4294967295]:[0]
    2.2.2.2          0      100      0      i  2.2.2.2      VxLAN
*> [2]:[0]:[201]:[48,0000:0000:1111]:[32,21.21.21.1]:[201]
    5.5.5.5          0      100      32768 i  -----      VxLAN
* i [2]:[0]:[201]:[48,0000:0000:1111]:[32,21.21.21.1]:[201]
    4.4.4.4          0      100      0      i  4.4.4.4      VxLAN
* i [2]:[0]:[201]:[48,0000:0000:1111]:[32,21.21.21.1]:[201]
    2.2.2.2          0      100      0      i  2.2.2.2      VxLAN
* i [2]:[0]:[201]:[48,0000:0000:1111]:[32,21.21.21.1]:[201]
    1.1.1.1          0      100      0      i  1.1.1.1      VxLAN
*> [2]:[0]:[201]:[48,0000:0000:1111]:[128,21:21::21:1]:[201]
    5.5.5.5          0      100      32768 i  -----      VxLAN
* i [2]:[0]:[201]:[48,0000:0000:1111]:[128,21:21::21:1]:[201]
    4.4.4.4          0      100      0      i  4.4.4.4      VxLAN
* i [2]:[0]:[201]:[48,0000:0000:1111]:[128,21:21::21:1]:[201]
    2.2.2.2          0      100      0      i  2.2.2.2      VxLAN
* i [2]:[0]:[201]:[48,0000:0000:1111]:[128,21:21::21:1]:[201]
    1.1.1.1          0      100      0      i  1.1.1.1      VxLAN
* i [2]:[00:00:00:00:00:22:22:00:00:00]:[201]:[48,0000:2222:1020]:[32,21.21.21.51]:[201]
    1.1.1.1          0      100      0      i  1.1.1.1      VxLAN
* i [2]:[00:00:00:00:00:22:22:00:00:00]:[201]:[48,0000:2222:1020]:[32,21.21.21.51]:[201]
    2.2.2.2          0      100      0      i  2.2.2.2      VxLAN
* i [2]:[0]:[201]:[48,0000:4444:1020]:[32,21.21.21.101]:[201]
    4.4.4.4          0      100      0      i  4.4.4.4      VxLAN
* i [3]:[201]:[32,1.1.1.1]
    1.1.1.1          0      100      0      i  1.1.1.1      VxLAN
* i [3]:[201]:[32,2.2.2.2]
    2.2.2.2          0      100      0      i  2.2.2.2      VxLAN
* i [3]:[201]:[32,4.4.4.4]
    4.4.4.4          0      100      0      i  4.4.4.4      VxLAN
*> [3]:[201]:[32,5.5.5.5]
    5.5.5.5          0      100      32768 i  -----      VxLAN

```

Total number of prefixes 57
TB2-VTEP5#

Distributed Gateway

In distributed gateway approach, VTEP will act as default gateways for one or more VNIDs, Each VTEP having its own default gateway IP and MAC configuration for a given VNID.

IRB Configuration for Distributed

Configure from Base Configuration-L2 VxLAN section, then configure below commands for centralized distributed approach.

VTEP4

(config)#nvo vxlan irb	Enable VxLAN irb
(config)#commit	Commit the candidate configuration to running configuration
(config)#ip vrf L3VRF1	Create MAC routing/forwarding instance with L3VRF1 name and enter into VRF mode
(config-vrf)#rd 41000:11	Assign RD value
(config-vrf)# route-target both 100:100	Assign route-target value for same for import and export.

(config-vrf)# l3vni 1000	Configure L3VNI as 1000 for L3VRF1
(config-vrf)#exit	Exit from VRF mode
(config)# interface irb2001	Configure IRB interface 2001
(config-if)ip vrf forwarding L3VRF1	Configure L3VRF1
(config-if)ip address 21.21.21.1/24	Configure IP address
(config-if)ipv6 address 21:21::21:1/48	Configure IPv6 address
(config-if)exit	Exit from interface config mode
(config)#commit	Commit the candidate configuration to running configuration
(config)router bgp 5000	Enter into BGP router mode
(config-router)#address-family ipv4 vrf L3VRF1	Enter into address-family mode for L3VRF1
(config-router-af)#redistribute connected	Redistribute connected
(config-router-af)#exit-address-family	Exit from address-family
(config)#nvo vxlan id 201 ingress-replication inner-vid-disabled	Configure VxLAN Network identifier with/without inner-vid-disabled configure and enter into VxLAN tenant mode
(config-nvo)#vxlan host-reachability-protocol evpn-bgp L2VRF2	Assign VRF for EVPN-BGP to carry EVPN route
(config-nvo)# evpn irb2001	Configure IRB2001 under VxLAN id 201
(config-nvo)#exit	Exit from VxLAN tenant mode and enter into configuration mode.
(config)#commit	Commit the candidate configuration to running configuration

VTEP5

Unconfigure vnid 201 from nvo vxlan.

(config)#nvo vxlan irb	Enable VxLAN IRB
(config)#commit	Commit the candidate configuration to running configuration
(config)#ip vrf L3VRF1	Create mac routing/forwarding instance with L3VRF1 name and enter into VRF mode
(config-vrf)#rd 51000:11	Assign RD value
(config-vrf)# route-target both 100:100	Assign route-target value for same for import and export.
(config-vrf)# l3vni 1000	Configure L3VNI as 1000 for L3VRF1
(config-vrf)#exit	Exit from VRF mode
(config)# interface irb1001	Configure IRB interface 1001
(config-if)ip vrf forwarding L3VRF1	Configure L3VRF1
(config-if)ip address 11.11.11.1/24	Configure IP address
(config-if)ipv6 address 11:11::11:1/48	Configure IPv6 address
(config-if)exit	Exit from interface config mode
(config)#commit	Commit the candidate configuration to running configuration
(config)router bgp 5000	Enter into BGP router mode
(config-router)#address-family ipv4 vrf L3VRF1	Enter into address-family mode for L3VRF1
(config-router-af)#redistribute connected	Redistribute connected

(config-router-af)#exit-address-family	Exit from address-family
(config)# nvo vxlan id 101 ingress-replication inner-vid-disabled	Configure VxLAN Network identifier with/without inner-vid-disabled configure and enter into VxLAN tenant mode
(config-nvo)#vxlan host-reachability-protocol evpn-bgp L2VRF1	Assign VRF for EVPN-BGP to carry EVPN route
(config-nvo)# evpn irb1001	Configure IRB under VxLAN id 101
(config-nvo)#exit	Exit from VxLAN tenant mode and enter into configuration mode.
(config)#commit	Commit the candidate configuration to running configuration

Validations

VTEP4

TB2-VTEP4#show nvo vxlan tunnel

Source	Destination	Status	Up/Down	Update
4.4.4.4	2.2.2.2	Installed	00:01:17	00:01:17
4.4.4.4	1.1.1.1	Installed	00:01:17	00:01:17
4.4.4.4	5.5.5.5	Installed	00:02:22	00:02:22

Total number of entries are 3

TB2-VTEP4#show nvo vxlan

VxLAN Information
 =====
 Codes: NW - Network Port
 AC - Access Port
 (u) - Untagged

VNIID	VNI-Name	VNI-Type	Type	Interface	ESI	VLAN	DF-Status	Src-Addr	Dst-Addr
201	VNI-201	L2	NW	----	----	----	----	4.4.4.4	2.2.2.2
201	VNI-201	L2	NW	----	----	----	----	4.4.4.4	1.1.1.1
201	VNI-201	--	AC	sa1	---	Single Homed Port	---	----	----
1000	----	L3	NW	----	----	----	----	4.4.4.4	5.5.5.5

Total number of entries are 4

TB2-VTEP4#show nvo vxlan arp-cache

VxLAN ARP-CACHE Information
 =====

VNIID	Ip-Addr	Mac-Addr	Type	Age-Out	Retries-Left
201	21.21.21.51	0000.2222.1020	Static Remote	----	----
201	21.21.21.1	3c2c.99c7.077a	Static Local	----	----
201	21.21.21.101	0000.4444.1020	Static Local	----	----

Total number of entries are 3

TB2-VTEP4#show nvo vxlan l3vni-map

L3VNI	L2VNI	IRB-interface
1000	201	irb2001

TB2-VTEP4#show ip route vrf L3VRF1

Codes: K - kernel, C - connected, S - static, R - RIP, B - BGP
 O - OSPF, IA - OSPF inter area
 N1 - OSPF NSSA external type 1, N2 - OSPF NSSA external type 2
 E1 - OSPF external type 1, E2 - OSPF external type 2
 i - IS-IS, L1 - IS-IS level-1, L2 - IS-IS level-2,
 ia - IS-IS inter area, E - EVPN,
 v - vrf leaked
 * - candidate default

IP Route Table for VRF "L3VRF1"

B 5.5.5.5/32 [0/0] is directly connected, tunvxlan2, 00:02:23
 B 11.11.11.0/24 [200/0] via 5.5.5.5 (recursive is directly connected, tunvxlan2), 00:01:26

```
C      21.21.21.0/24 is directly connected, irb2001, 00:01:18
C      127.0.0.0/8 is directly connected, lo.L3VRF1, 00:02:23
```

```
Gateway of last resort is not set
TB2-VTEP4#show ip route summary
```

```
-----
IP routing table name is Default-IP-Routing-Table(0)
-----
```

```
IP routing table maximum-paths   : 8
Total number of IPv4 routes      : 12
Total number of IPv4 paths      : 12
Pending routes (due to route max reached): 0
Route Source   Networks
connected      3
ospf           9
Total          12
FIB            12
```

```
ECMP statistics (active in ASIC):
```

```
Total number of IPv4 ECMP routes : 0
Total number of IPv4 ECMP paths  : 0
```

```
TB2-VTEP4#show bgp l2vpn evpn
```

```
BGP table version is 13, local router ID is 4.4.4.4
```

```
Status codes: s suppressed, d damped, h history, * valid, > best, i - internal,
               l - labeled, S Stale
```

```
Origin codes: i - IGP, e - EGP, ? - incomplete
```

```
[EVPN route type]:[ESI]:[VNID]:[relevent route informantion]
```

```
1 - Ethernet Auto-discovery Route
2 - MAC/IP Route
3 - Inclusive Multicast Route
4 - Ethernet Segment Route
5 - Prefix Route
```

Network	Next Hop	Metric	LocPrf	Weight	Path	Peer	Encap
RD[51000:11]							
*>i [5]:[0]:[1000]:[24]:[11.11.11.0]:[0.0.0.0]:[1000]	5.5.5.5	0	100	0	? 5.5.5.5		VxLAN
RD[1.1.1.1:1]							
*>i [1]:[00:00:00:00:00:22:22:00:00:00]:[4294967295]:[0]	1.1.1.1	0	100	0	i 1.1.1.1		VxLAN
*>i [4]:[00:00:00:00:00:22:22:00:00:00]:[32,1.1.1.1]	1.1.1.1	0	100	0	i 1.1.1.1		VxLAN
RD[1.1.1.1:11]							
*>i [1]:[00:00:00:00:00:22:22:00:00:00]:[101]:[101]	1.1.1.1	0	100	0	i 1.1.1.1		VxLAN
*>i [2]:[00:00:00:00:00:22:22:00:00:00]:[101]:[48,0000:2222:1010]:[32,11.11.11.51]:[101]	1.1.1.1	0	100	0	i 1.1.1.1		VxLAN
*>i [3]:[101]:[32,1.1.1.1]	1.1.1.1	0	100	0	i 1.1.1.1		VxLAN
RD[1.1.1.1:21]							
*>i [1]:[00:00:00:00:00:22:22:00:00:00]:[201]:[201]	1.1.1.1	0	100	0	i 1.1.1.1		VxLAN
*>i [2]:[00:00:00:00:00:22:22:00:00:00]:[201]:[48,0000:2222:1020]:[32,21.21.21.51]:[201]	1.1.1.1	0	100	0	i 1.1.1.1		VxLAN
*>i [3]:[201]:[32,1.1.1.1]	1.1.1.1	0	100	0	i 1.1.1.1		VxLAN
RD[2.2.2.2:1]							
*>i [1]:[00:00:00:00:00:22:22:00:00:00]:[4294967295]:[0]	2.2.2.2	0	100	0	i 2.2.2.2		VxLAN
*>i [4]:[00:00:00:00:00:22:22:00:00:00]:[32,2.2.2.2]	2.2.2.2	0	100	0	i 2.2.2.2		VxLAN
RD[2.2.2.2:11]							
*>i [1]:[00:00:00:00:00:22:22:00:00:00]:[101]:[101]	2.2.2.2	0	100	0	i 2.2.2.2		VxLAN

```

*>i [2]:[00:00:00:00:00:22:22:00:00:00]:[101]:[48,0000:2222:1010]:[32,11.11.11.51]:[101]
      2.2.2.2          0          100          0          i 2.2.2.2          VxLAN
*>i [3]:[101]:[32,2.2.2.2]
      2.2.2.2          0          100          0          i 2.2.2.2          VxLAN

RD[2.2.2.2:21]
*>i [1]:[00:00:00:00:00:22:22:00:00:00]:[201]:[201]
      2.2.2.2          0          100          0          i 2.2.2.2          VxLAN
*>i [2]:[00:00:00:00:00:22:22:00:00:00]:[201]:[48,0000:2222:1020]:[32,21.21.21.51]:[201]
      2.2.2.2          0          100          0          i 2.2.2.2          VxLAN
*>i [3]:[201]:[32,2.2.2.2]
      2.2.2.2          0          100          0          i 2.2.2.2          VxLAN

RD[4.4.4.4:11] VRF[L2VRF1]:
* i [1]:[00:00:00:00:00:22:22:00:00:00]:[101]:[101]
      1.1.1.1          0          100          0          i 1.1.1.1          VxLAN
* i [1]:[00:00:00:00:00:22:22:00:00:00]:[4294967295]:[0]
      2.2.2.2          0          100          0          i 2.2.2.2          VxLAN
* i [1]:[00:00:00:00:00:22:22:00:00:00]:[4294967295]:[0]
      1.1.1.1          0          100          0          i 1.1.1.1          VxLAN
* i [1]:[00:00:00:00:00:22:22:00:00:00]:[4294967295]:[0]
      2.2.2.2          0          100          0          i 2.2.2.2          VxLAN
* i [2]:[00:00:00:00:00:22:22:00:00:00]:[101]:[48,0000:2222:1010]:[32,11.11.11.51]:[101]
      1.1.1.1          0          100          0          i 1.1.1.1          VxLAN
* i [2]:[00:00:00:00:00:22:22:00:00:00]:[101]:[48,0000:2222:1010]:[32,11.11.11.51]:[101]
      2.2.2.2          0          100          0          i 2.2.2.2          VxLAN
* i [2]:[0]:[101]:[48,0000:5555:1010]:[32,11.11.11.201]:[101]
      5.5.5.5          0          100          0          i 5.5.5.5          VxLAN
* i [2]:[0]:[101]:[48,3c2c:99d6:167a]:[32,11.11.11.1]:[101]
      5.5.5.5          0          100          0          i 5.5.5.5          VxLAN
* i [2]:[0]:[101]:[48,3c2c:99d6:167a]:[128,11:11::11:1]:[101]
      5.5.5.5          0          100          0          i 5.5.5.5          VxLAN
* i [3]:[101]:[32,1.1.1.1]
      1.1.1.1          0          100          0          i 1.1.1.1          VxLAN
* i [3]:[101]:[32,2.2.2.2]
      2.2.2.2          0          100          0          i 2.2.2.2          VxLAN
* i [3]:[101]:[32,5.5.5.5]
      5.5.5.5          0          100          0          i 5.5.5.5          VxLAN

RD[4.4.4.4:21] VRF[L2VRF2]:
* i [1]:[00:00:00:00:00:22:22:00:00:00]:[201]:[201]
      1.1.1.1          0          100          0          i 1.1.1.1          VxLAN
* i [1]:[00:00:00:00:00:22:22:00:00:00]:[201]:[201]
      2.2.2.2          0          100          0          i 2.2.2.2          VxLAN
* i [1]:[00:00:00:00:00:22:22:00:00:00]:[4294967295]:[0]
      1.1.1.1          0          100          0          i 1.1.1.1          VxLAN
* i [1]:[00:00:00:00:00:22:22:00:00:00]:[4294967295]:[0]
      2.2.2.2          0          100          0          i 2.2.2.2          VxLAN
* i [2]:[00:00:00:00:00:22:22:00:00:00]:[201]:[48,0000:2222:1020]:[32,21.21.21.51]:[201]
      1.1.1.1          0          100          0          i 1.1.1.1          VxLAN
* i [2]:[00:00:00:00:00:22:22:00:00:00]:[201]:[48,0000:2222:1020]:[32,21.21.21.51]:[201]
      2.2.2.2          0          100          0          i 2.2.2.2          VxLAN
*> [2]:[0]:[201]:[48,0000:4444:1020]:[32,21.21.21.101]:[201]
      4.4.4.4          0          100          32768      i -----          VxLAN
*> [2]:[0]:[201]:[48,3c2c:99c7:077a]:[32,21.21.21.1]:[201]
      4.4.4.4          0          100          32768      i -----          VxLAN
*> [2]:[0]:[201]:[48,3c2c:99c7:077a]:[128,21:21::21:1]:[201]
      4.4.4.4          0          100          32768      i -----          VxLAN
* i [3]:[201]:[32,1.1.1.1]
      1.1.1.1          0          100          0          i 1.1.1.1          VxLAN
* i [3]:[201]:[32,2.2.2.2]
      2.2.2.2          0          100          0          i 2.2.2.2          VxLAN
*> [3]:[201]:[32,4.4.4.4]
      4.4.4.4          0          100          32768      i -----          VxLAN

RD[5.5.5.5:11]
*>i [2]:[0]:[101]:[48,0000:5555:1010]:[32,11.11.11.201]:[101]
      5.5.5.5          0          100          0          i 5.5.5.5          VxLAN
*>i [2]:[0]:[101]:[48,3c2c:99d6:167a]:[32,11.11.11.1]:[101]
      5.5.5.5          0          100          0          i 5.5.5.5          VxLAN
*>i [2]:[0]:[101]:[48,3c2c:99d6:167a]:[128,11:11::11:1]:[101]
      5.5.5.5          0          100          0          i 5.5.5.5          VxLAN
*>i [3]:[101]:[32,5.5.5.5]
      5.5.5.5          0          100          0          i 5.5.5.5          VxLAN

```

Total number of prefixes 39
TB2-VTEP4#

VTEP5

TB2-VTEP5#show nvo vxlan tunnel

VxLAN Network tunnel Entries

Source	Destination	Status	Up/Down	Update
5.5.5.5	2.2.2.2	Installed	00:34:13	00:34:13
5.5.5.5	4.4.4.4	Installed	00:01:26	00:01:26
5.5.5.5	1.1.1.1	Installed	00:34:13	00:34:13

Total number of entries are 3

TB2-VTEP5#show nvo vxlan

VxLAN Information

```

=====
Codes: NW - Network Port
       AC - Access Port
       (u) - Untagged
    
```

VNID	VNI-Name	VNI-Type	Type	Interface	ESI	VLAN	DF-Status	Src-Addr	Dst-Addr
101	VNI-101	L2	NW	----	----	----	----	5.5.5.5	2.2.2.2
101	VNI-101	L2	NW	----	----	----	----	5.5.5.5	1.1.1.1
101	VNI-101	--	AC	xe48	---	10	----	----	----
1000	----	L3	NW	----	----	----	----	5.5.5.5	4.4.4.4

Total number of entries are 4

TB2-VTEP5#show nvo vxlan arp-cache

VxLAN ARP-CACHE Information

```

=====
VNID      Ip-Addr      Mac-Addr      Type      Age-Out      Retries-Left
-----
101      11.11.11.51  0000.2222.1010 Static Remote ----
101      11.11.11.1   3c2c.99d6.167a Static Local  ----
101      11.11.11.201 0000.5555.1010 Static Local  ----
    
```

Total number of entries are 3

Total number of entries are 1

TB2-VTEP5#show nvo vxlan l3vni-map

```

L3VNI      L2VNI      IRB-interface
-----
1000      101        irb1001
    
```

TB2-VTEP5#show ip route vrf L3VRF1

```

Codes: K - kernel, C - connected, S - static, R - RIP, B - BGP
       O - OSPF, IA - OSPF inter area
       N1 - OSPF NSSA external type 1, N2 - OSPF NSSA external type 2
       E1 - OSPF external type 1, E2 - OSPF external type 2
       i - IS-IS, L1 - IS-IS level-1, L2 - IS-IS level-2,
       ia - IS-IS inter area, E - EVPN,
       v - vrf leaked
       * - candidate default
    
```

IP Route Table for VRF "L3VRF1"

```

B      4.4.4.4/32 [0/0] is directly connected, tunvxlan2, 00:01:26
C      11.11.11.0/24 is directly connected, irb1001, 00:34:43
B      21.21.21.0/24 [200/0] via 4.4.4.4 (recursive is directly connected, tunvxlan2), 00:01:26
C      127.0.0.0/8 is directly connected, lo.L3VRF1, 00:40:36
    
```

Gateway of last resort is not set

TB2-VTEP5#show ip route summary

```

-----
IP routing table name is Default-IP-Routing-Table(0)
-----
    
```

```

IP routing table maximum-paths : 8
Total number of IPv4 routes : 12
Total number of IPv4 paths : 12
Pending routes (due to route max reached): 0
Route Source      Networks
connected         3
ospf              9
Total            12
FIB              12
    
```

ECMP statistics (active in ASIC):

Total number of IPv4 ECMP routes : 0

Total number of IPv4 ECMP paths : 0

TB2-VTEP5#show bgp l2vpn evpn

BGP table version is 13, local router ID is 5.5.5.5

Status codes: s suppressed, d damped, h history, * valid, > best, i - internal,

l - labeled, S Stale

Origin codes: i - IGP, e - EGP, ? - incomplete

[EVPN route type]:[ESI]:[VNID]:[relevant route information]

1 - Ethernet Auto-discovery Route

2 - MAC/IP Route

3 - Inclusive Multicast Route

4 - Ethernet Segment Route

5 - Prefix Route

Network	Next Hop	Metric	LocPrf	Weight	Path	Peer	Encap
RD[41000:11]							
*>i [5]:[0]:[1000]:[24]:[21.21.21.0]:[0.0.0.0]:[1000]	4.4.4.4	0	100	0	?	4.4.4.4	VxLAN
RD[1.1.1.1:1]							
*>i [1]:[00:00:00:00:00:22:22:00:00:00]:[4294967295]:[0]	1.1.1.1	0	100	0	i	1.1.1.1	VxLAN
*>i [4]:[00:00:00:00:00:22:22:00:00:00]:[32,1.1.1.1]	1.1.1.1	0	100	0	i	1.1.1.1	VxLAN
RD[1.1.1.1:11]							
*>i [1]:[00:00:00:00:00:22:22:00:00:00]:[101]:[101]	1.1.1.1	0	100	0	i	1.1.1.1	VxLAN
*>i [2]:[00:00:00:00:00:22:22:00:00:00]:[101]:[48,0000:2222:1010]:[32,11.11.11.51]:[101]	1.1.1.1	0	100	0	i	1.1.1.1	VxLAN
*>i [3]:[101]:[32,1.1.1.1]	1.1.1.1	0	100	0	i	1.1.1.1	VxLAN
RD[1.1.1.1:21]							
*>i [1]:[00:00:00:00:00:22:22:00:00:00]:[201]:[201]	1.1.1.1	0	100	0	i	1.1.1.1	VxLAN
*>i [2]:[00:00:00:00:00:22:22:00:00:00]:[201]:[48,0000:2222:1020]:[32,21.21.21.51]:[201]	1.1.1.1	0	100	0	i	1.1.1.1	VxLAN
*>i [3]:[201]:[32,1.1.1.1]	1.1.1.1	0	100	0	i	1.1.1.1	VxLAN
RD[2.2.2.2:1]							
*>i [1]:[00:00:00:00:00:22:22:00:00:00]:[4294967295]:[0]	2.2.2.2	0	100	0	i	2.2.2.2	VxLAN
*>i [4]:[00:00:00:00:00:22:22:00:00:00]:[32,2.2.2.2]	2.2.2.2	0	100	0	i	2.2.2.2	VxLAN
RD[2.2.2.2:11]							
*>i [1]:[00:00:00:00:00:22:22:00:00:00]:[101]:[101]	2.2.2.2	0	100	0	i	2.2.2.2	VxLAN
*>i [2]:[00:00:00:00:00:22:22:00:00:00]:[101]:[48,0000:2222:1010]:[32,11.11.11.51]:[101]	2.2.2.2	0	100	0	i	2.2.2.2	VxLAN
*>i [3]:[101]:[32,2.2.2.2]	2.2.2.2	0	100	0	i	2.2.2.2	VxLAN
RD[2.2.2.2:21]							
*>i [1]:[00:00:00:00:00:22:22:00:00:00]:[201]:[201]	2.2.2.2	0	100	0	i	2.2.2.2	VxLAN
*>i [2]:[00:00:00:00:00:22:22:00:00:00]:[201]:[48,0000:2222:1020]:[32,21.21.21.51]:[201]	2.2.2.2	0	100	0	i	2.2.2.2	VxLAN
*>i [3]:[201]:[32,2.2.2.2]	2.2.2.2	0	100	0	i	2.2.2.2	VxLAN
RD[4.4.4.4:21]							
*>i [2]:[0]:[201]:[48,0000:4444:1020]:[32,21.21.21.101]:[201]	4.4.4.4	0	100	0	i	4.4.4.4	VxLAN
*>i [2]:[0]:[201]:[48,3c2c:99c7:077a]:[32,21.21.21.1]:[201]	4.4.4.4	0	100	0	i	4.4.4.4	VxLAN
*>i [2]:[0]:[201]:[48,3c2c:99c7:077a]:[128,21:21::21:1]:[201]							

```

4.4.4.4          0          100      0      i  4.4.4.4          VxLAN
*>i  [3]:[201]:[32,4.4.4.4]
4.4.4.4          0          100      0      i  4.4.4.4          VxLAN

RD[5.5.5.5:11] VRF[L2VRF1]:
* i  [1]:[00:00:00:00:00:22:22:00:00:00]:[101]:[101]
1.1.1.1          0          100      0      i  1.1.1.1          VxLAN
* i  2.2.2.2          0          100      0      i  2.2.2.2          VxLAN
* i  [1]:[00:00:00:00:00:22:22:00:00:00]:[4294967295]:[0]
1.1.1.1          0          100      0      i  1.1.1.1          VxLAN
* i  2.2.2.2          0          100      0      i  2.2.2.2          VxLAN
* i  [2]:[00:00:00:00:00:22:22:00:00:00]:[101]:[48,0000:2222:1010]:[32,11.11.11.51]:[101]
1.1.1.1          0          100      0      i  1.1.1.1          VxLAN
* i  2.2.2.2          0          100      0      i  2.2.2.2          VxLAN
*>  [2]:[0]:[101]:[48,0000:5555:1010]:[32,11.11.11.201]:[101]
5.5.5.5          0          100      32768  i  -----          VxLAN
*>  [2]:[0]:[101]:[48,3c2c:99d6:167a]:[32,11.11.11.1]:[101]
5.5.5.5          0          100      32768  i  -----          VxLAN
*>  [2]:[0]:[101]:[48,3c2c:99d6:167a]:[128,11:11::11:1]:[101]
5.5.5.5          0          100      32768  i  -----          VxLAN
* i  [3]:[101]:[32,1.1.1.1]
1.1.1.1          0          100      0      i  1.1.1.1          VxLAN
* i  [3]:[101]:[32,2.2.2.2]
2.2.2.2          0          100      0      i  2.2.2.2          VxLAN
*>  [3]:[101]:[32,5.5.5.5]
5.5.5.5          0          100      32768  i  -----          VxLAN

RD[5.5.5.5:21] VRF[L2VRF2]:
* i  [1]:[00:00:00:00:00:22:22:00:00:00]:[201]:[201]
1.1.1.1          0          100      0      i  1.1.1.1          VxLAN
* i  2.2.2.2          0          100      0      i  2.2.2.2          VxLAN
* i  [1]:[00:00:00:00:00:22:22:00:00:00]:[4294967295]:[0]
1.1.1.1          0          100      0      i  1.1.1.1          VxLAN
* i  2.2.2.2          0          100      0      i  2.2.2.2          VxLAN
* i  [2]:[00:00:00:00:00:22:22:00:00:00]:[201]:[48,0000:2222:1020]:[32,21.21.21.51]:[201]
1.1.1.1          0          100      0      i  1.1.1.1          VxLAN
* i  2.2.2.2          0          100      0      i  2.2.2.2          VxLAN
* i  [2]:[0]:[201]:[48,0000:4444:1020]:[32,21.21.21.101]:[201]
4.4.4.4          0          100      0      i  4.4.4.4          VxLAN
* i  [2]:[0]:[201]:[48,3c2c:99c7:077a]:[32,21.21.21.1]:[201]
4.4.4.4          0          100      0      i  4.4.4.4          VxLAN
* i  [2]:[0]:[201]:[48,3c2c:99c7:077a]:[128,21:21::21:1]:[201]
4.4.4.4          0          100      0      i  4.4.4.4          VxLAN
* i  [3]:[201]:[32,1.1.1.1]
1.1.1.1          0          100      0      i  1.1.1.1          VxLAN
* i  [3]:[201]:[32,2.2.2.2]
2.2.2.2          0          100      0      i  2.2.2.2          VxLAN
* i  [3]:[201]:[32,4.4.4.4]
4.4.4.4          0          100      0      i  4.4.4.4          VxLAN

```

Total number of prefixes 39
TB2-VTEP5#

VxLAN IRB ECMP

In multihoming, anycast-IP and the same subnet is configured on the multihomed devices within the same VPN on IRB interfaces connected to the multihomed CE. Both VTEP's will advertise same connected prefix route, remote VTEP need to understand this and treat the traffic destined to multihomed CE as ECMP traffic i.e Routed traffic should loadshare to both the VTEP's.

IRB ECMP Configuration

Configure from base configuration-L2 VxLAN section and perform commit after configuration, then configure below commands for ECMP approach.

VTEP1

Configure max-path ibgp 2 on VTEP1 under BGP IPv4 VRF address family.

(config)router bgp 5000	Enter into BGP router mode
(config-router)#address-family ipv4 vrf L3VRF1	Enter into address-family mode for L3VRF1
(config-router)# max-paths ibgp 2	Configure BGP max-path .
(config-router-af)#redistribute connected	Redistribute connected
(config-router-af)#exit-address-family	Exit form address-family
(config-router-af)#commit	Commit the transaction

VTEP1 IRB configuration

(config)#nvo vxlan irb	Enable VxLAN IRB
(config)#commit	Commit the candidate configuration to running configuration
(config)#ip vrf L3VRF1	Create MAC routing/forwarding instance with L3VRF1 name and enter into VRF mode
(config-vrf)#rd 11000:11	Assign RD value
(config-vrf)# route-target both 100:100	Assign route-target value for same for import and export.
(config-vrf)# l3vni 1000	Configure L3VNI as 1000 for L3VRF1
(config-vrf)#exit	Exit from VRF mode
(config)# evpn irb-forwarding anycast-gateway-mac 0000.0000.1111	Configure anycast MAC address
(config)#commit	Commit the candidate configuration to running configuration
(config)# interface irb1001	Configure IRV interface 1001
(config-if)ip vrf forwarding L3VRF1	Configure L3VRF1
(config-if)ip address 11.11.11.1/24 anycast	Configure IP address
(config-if)ipv6 address 11:11::11:1/48	Configure IPv6 address
(config-if) evpn irb-if-forwarding anycast-gateway-mac	Configure anycast MAC address
(config-if)exit	Exit from interface config mode
(config)# interface irb 2001	Configure IRB interface 2001
(config-if)ip vrf forwarding L3VRF1	Configure L3VRF1
(config-if)ip address 21.21.21.1/24 anycast	Configure IP address
(config-if)ipv6 address 21:21::21:1/48	Configure IPv6 address
(config-if) evpn irb-if-forwarding anycast-gateway-mac	Configure anycast MAC address
(config-if)exit	Exit from interface config mode
(config)#commit	Commit the candidate configuration to running configuration
(config)router bgp 5000	Enter into BGP router mode
(config-router)#address-family ipv4 vrf L3VRF1	Enter into address-family mode for L3VRF1
(config-router-af)#redistribute connected	Redistribute connected

(config-router-af)#exit-address-family	Exit form address-family
(config)# nvo vxlan id 101 ingress-replication inner-vid-disabled	Configure VxLAN Network identifier with/without inner-vid-disabled configure and enter into VxLAN tenant mode
(config-nvo)#vxlan host-reachability-protocol evpn-bgp L2VRF1	Assign VRF for evpn-bgp to carry EVPN route
(config-nvo)# evpn irb1001	Configure IRB1001 under VxLAN ID 101
(config-nvo)#exit	Exit from VxLAN tenant mode and enter into configuration mode.
(config)#nvo vxlan id 201 ingress-replication inner-vid-disabled	Configure VxLAN Network identifier with/without inner-vid-disabled configure and enter into VxLAN tenant mode
(config-nvo)#vxlan host-reachability-protocol evpn-bgp L2VRF2	Assign VRF for evpn-bgp to carry EVPN route
(config-nvo)# evpn irb2001	Configure irb2001 under VxLAN ID 201
(config-nvo)#exit	Exit from VxLAN tenant mode and enter into configuration mode.
(config)#commit	Commit the candidate configuration to running configuration

VTEP2

Configure max-path ibgp 2 on VTEP1 under BGP IPv4 VRF address family.

(config)router bgp 5000	Enter into BGP router mode
(config-router)#address-family ipv4 vrf L3VRF1	Enter into address-family mode for L3VRF1
(config-router-af)# max-paths ibgp 2	Configure BGP max-path .
(config-router-af)#redistribute connected	Redistribute connected
(config-router-af)#exit-address-family	Exit form address-family
(config-router-af)#commit	Commit the transaction

VTEP2 IRB configuration

(config)#nvo vxlan irb	Enable VxLAN irb
(config)#commit	Commit the candidate configuration to running configuration
(config)#ip vrf L3VRF1	Create MAC routing/forwarding instance with L3VRF1 name and enter into VRF mode
(config-vrf)#rd 21000:11	Assign RD value
(config-vrf)# route-target both 100:100	Assign route-target value for same for import and export.
(config-vrf)# l3vni 1000	Configure L3VNI as 1000 for L3VRF1
(config-vrf)#exit	Exit from VRF mode
(config)# evpn irb-forwarding anycast-gateway-mac 0000.0000.1111	Configure anycast MAC address
(config)#commit	Commit the candidate configuration to running configuration
(config)# interface irb 1001	Configure IRB interface 1001
(config-if)ip vrf forwarding L3VRF1	Configure L3VRF1
(config-if)ip address 11.11.11.1/24 anycast	Configure IP address
(config-if)ipv6 address 11:11::11:1/48	Configure IPv6 address

(config-if) evpn irb-if-forwarding anycast-gateway-mac	Configure anycast MAC address
(config-if)exit	Exit from interface config mode
(config)# interface irb 2001	Configure IRB interface 2001
(config-if)ip vrf forwarding L3VRF1	Configure L3VRF1
(config-if)ip address 21.21.21.1/24 anycast	Configure IP address
(config-if)ipv6 address 21:21::21:1/48	Configure IPv6 address
(config-if) evpn irb-if-forwarding anycast-gateway-mac	Configure anycast MAC address
(config-if)exit	Exit from interface config mode
(config)#commit	Commit the candidate configuration to running configuration
(config)router bgp 5000	Enter into BGP router mode
(config-router)#address-family ipv4 vrf L3VRF1	Enter into address-family mode for L3VRF1
(config-router-af)#redistribute connected	Redistribute connected
(config-router-af)#exit-address-family	Exit form address-family
(config)# nvo vxlan id 101 ingress-replication inner-vid-disabled	Configure VxLAN Network identifier with/without inner-vid-disabled configure and enter into VxLAN tenant mode
(config-nvo)#vxlan host-reachability-protocol evpn-bgp L2VRF1	Assign VRF for evpn-bgp to carry EVPN route
(config-nvo)# evpn irb1001	Configure irb1001 under VxLAN ID 101
(config-nvo)#exit	Exit from VxLAN tenant mode and enter into configuration mode.
(config)#nvo vxlan id 201 ingress-replication inner-vid-disabled	Configure VxLAN Network identifier with/without inner-vid-disabled configure and enter into VxLAN tenant mode
(config-nvo)#vxlan host-reachability-protocol evpn-bgp L2VRF2	Assign VRF for evpn-bgp to carry EVPN route
(config-nvo)# evpn irb2001	Configure irb2001 under VxLAN id 201
(config-nvo)#exit	Exit from VxLAN tenant mode and enter into configuration mode.
(config)#commit	Commit the candidate configuration to running configuration

VTEP5

Unconfigure - evpn irb-forwarding anycast-gateway-mac and assign different IP address and IPv6 address to IRB interfaces on VTEP1. Resolve the ARP on Traffic generator and verify the learnt MAC is same as IRB interface MAC not the anycast MAC (0000.0000.1111). Configure BGP max-path under BGP process.

Enable VxLAN Multihoming on VTEP5 and reboot the node to apply the Multihoming configuration to hardware.

(config)#hardware-profile filter vxlan enable	Enable hardware-profile filter for VxLAN.
(config)#hardware-profile filter vxlan-mh enable	Enable hardware-profile filter for VxLAN multi-homing.
(config)#hardware-profile filter egress-ipv4 enable	Enable hardware-profile filter for egress IPv4.
(config)#commit	Commit the transaction

(config)#evpn vxlan multihoming enable	Enable Multihoming, save configs and reboot the board for multihoming to be effective
(config)#commit	Commit the transaction
(config)#nvo vxlan irb	Enable VxLAN IRB
(config)#commit	Commit the transaction
(config)#ip vrf L3VRF1	Create MAC routing/forwarding instance with L3VRF1 name and enter into VRF mode
(config-vrf)#rd 51000:11	Assign RD value
(config-vrf)# route-target both 100:100	Assign route-target value for same for import and export.
(config-vrf)# l3vni 1000	Configure L3VNI as 1000 for L3VRF1
(config-vrf)#commit	Commit the transaction
(config)# no evpn irb-forwarding anycast-gateway-mac	Delete EVPN irb-forwarding anycast-gateway-MAC address
(config)#commit	Commit the transaction
(config)# interface irb1001	Configure IRB interface 1001
(config-irb-if)ip vrf forwarding L3VRF1	Configure L3VRF1
(config-irb-if)ip address 101.11.11.1/24	Configure IP address
(config-irb-if)ipv6 address 101:11::11:1/48	Configure IPv6 address
(config-irb-if)#commit	Commit the transaction
(config)router bgp 5000	Enter into BGP router mode
(config-router)#address-family ipv4 vrf L3VRF1	Enter into address-family mode for L3VRF1
(config-router-af)# max-paths ibgp 2	Configure BGP max-path .
(config-router-af)#redistribute connected	Redistribute connected
(config-router-af)#exit-address-family	Exit form address-family
(config-router-af)#commit	Commit the transaction
(config)# nvo vxlan id 101 ingress-replication inner-vid-disabled	Configure VxLAN Network identifier with/without inner-vid-disabled configure and enter into VxLAN tenant mode
(config-nvo)#vxlan host-reachability-protocol evpn-bgp L2VRF1	Assign VRF for evpn-bgp to carry EVPN route
(config-nvo)# evpn irb1001	Configure irb1001 under VxLAN ID 101
(config-nvo)#exit	Exit from VxLAN tenant mode and enter into configuration mode.
(config-nvo)#commit	Commit the transaction

Validations

On VTEP5, verify that in the VRF routing table , ECMP path for the IRB address (11.11.11.1) is via VTEP1 - 1.1.1.1 and VTEP2 -2.2.2.2 . Send the Traffic from VTEP5 Single homed to Multihomed. Traffic should be forwarded via VTEP1 and VTEP2 and is load shared between the Multihome VTEPs.

VTEP5

```
TB2-VTEP5#show nvo vxlan tunnel
```

```
VxLAN Network tunnel Entries
```

```
Source          Destination      Status          Up/Down         Update
```

```
=====
```

5.5.5.5	2.2.2.2	Installed	00:34:13	00:34:13
5.5.5.5	4.4.4.4	Installed	00:01:26	00:01:26
5.5.5.5	1.1.1.1	Installed	00:34:13	00:34:13

Total number of entries are 3

```
TB2-VTEP5#show nvo vxlan
VxLAN Information
=====
```

```
Codes: NW - Network Port
       AC - Access Port
       (u) - Untagged
```

VNID	VNI-Name	VNI-Type	Type	Interface	ESI	VLAN	DF-Status	Src-Addr	Dst-Addr
101	VNI-101	L2	NW	----	----	----	----	5.5.5.5	2.2.2.2
101	VNI-101	L2	NW	----	----	----	----	5.5.5.5	1.1.1.1
101	VNI-101	--	AC	xe48	--- Single Homed Port ---	10	----	----	----
1000	----	L3	NW	----	----	----	----	5.5.5.5	4.4.4.4

Total number of entries are 4

```
TB2-VTEP5#show nvo vxlan arp-cache
VxLAN ARP-CACHE Information
=====
```

VNID	Ip-Addr	Mac-Addr	Type	Age-Out	Retries-Left
101	11.11.11.1	0000.0000.1111	Static Remote	----	
101	101.11.11.1	3c2c.99d6.168a	Static Local	----	
101	11.11.11.201	0000.5555.1010	Static Local	----	

Total number of entries are 3

Total number of entries are 1

```
TB2-VTEP5#show nvo vxlan l3vni-map
L3VNI      L2VNI      IRB-interface
=====
1000      101        irb1001
```

```
TB2-VTEP5#show ip route vrf L3VRF1
Codes: K - kernel, C - connected, S - static, R - RIP, B - BGP
       O - OSPF, IA - OSPF inter area
       N1 - OSPF NSSA external type 1, N2 - OSPF NSSA external type 2
       E1 - OSPF external type 1, E2 - OSPF external type 2
       i - IS-IS, L1 - IS-IS level-1, L2 - IS-IS level-2,
       ia - IS-IS inter area, E - EVPN,
       v - vrf leaked
       * - candidate default
```

```
IP Route Table for VRF "L3VRF1"
C      101.11.11.0/24 is directly connected, irb1001, 00:34:43
B      11.11.11.0/24 [200/0] via 1.1.1.1 (recursive is directly connected, tunvxlan1001), 00:01:26
       [200/0] via 2.2.2.2 (recursive is directly connected, tunvxlan1001), 00:01:26
C      127.0.0.0/8 is directly connected, lo.L3VRF1, 00:40:36
```

Gateway of last resort is not set

Send 10000 pps from VTEP5 (Traffic generator- SH5) and verify the counters on VTEP5, VTEP1, VTEP2 and Switch

```
TB2-VTEP5#show interface counter rate mbps
```

```

+-----+-----+-----+-----+-----+
| Interface | Rx mbps | Rx pps | Tx mbps | Tx pps |
+-----+-----+-----+-----+-----+

```

```

xe48          100          10000          0.01          8
xe40          0.00          0          106.76         10000

```

On VTEP1 and VTEP2, verify that traffic is load-balanced on ECMP path from VTEP5.

VTEP1

```
TB2-VTEP1#show interface counter rate mbps
```

```

+-----+-----+-----+-----+
| Interface | Rx mbps | Rx pps | Tx mbps | Tx pps |
+-----+-----+-----+-----+
po2          62.75    5000    0.01     8
po1          0.00         0    62.98   5000
xe25        31.98    2500     0         0
xe26        30.95    2501     0         0
xe2          0.00         0    31.53   2500
xe3          0.00         0    30.53   2500

```

VTEP2

```
TB2-VTEP2#show interface counter rate mbps
```

```

+-----+-----+-----+-----+
| Interface | Rx mbps | Rx pps | Tx mbps | Tx pps |
+-----+-----+-----+-----+
po3          62.75    5000    0.01     8
po1          0.00         0    62.98   5000
xe27        31.98    2500     0         0
xe28        30.95    2501     0         0
xe8          0.00         0    31.53   2500
xe9          0.00         0    30.53   2500

```

Verify the Traffic on Multihomed Switch :

SW1(Multihomed)

```
TB2-SW1#show interface counter rate mbps
```

```

+-----+-----+-----+-----+
| Interface | Rx mbps | Rx pps | Tx mbps | Tx pps |
+-----+-----+-----+-----+
po1          100          10000    0.01     8
xe7          0.00         0        100    10000
xe8          25.01    2501     0         0
xe9          24.99    2499     0         0
xe2          24.98    2499     0         0
xe3          25.02    2501     0         0

```

CHAPTER 10 VxLAN-EVPN with IRB QoS

Overview

An EVPN-based Integrated Routing and Bridging solution used for forwarding of intra-subnets and inter-subnets traffic. Here QoS is applied on IRB solution for L3 packets.

VxLAN quality of service (QoS) provides differentiated service in VxLAN applications. A device implements mapping between QoS priorities in original packets, internal priorities (local precedence assigned by the device to differentiate service classes of packets), and priorities of encapsulated packets. In this way, the switch provides the differentiated QoS service based on original packets.

Topology

The procedures in this section use the topology in [Figure 10-11](#)

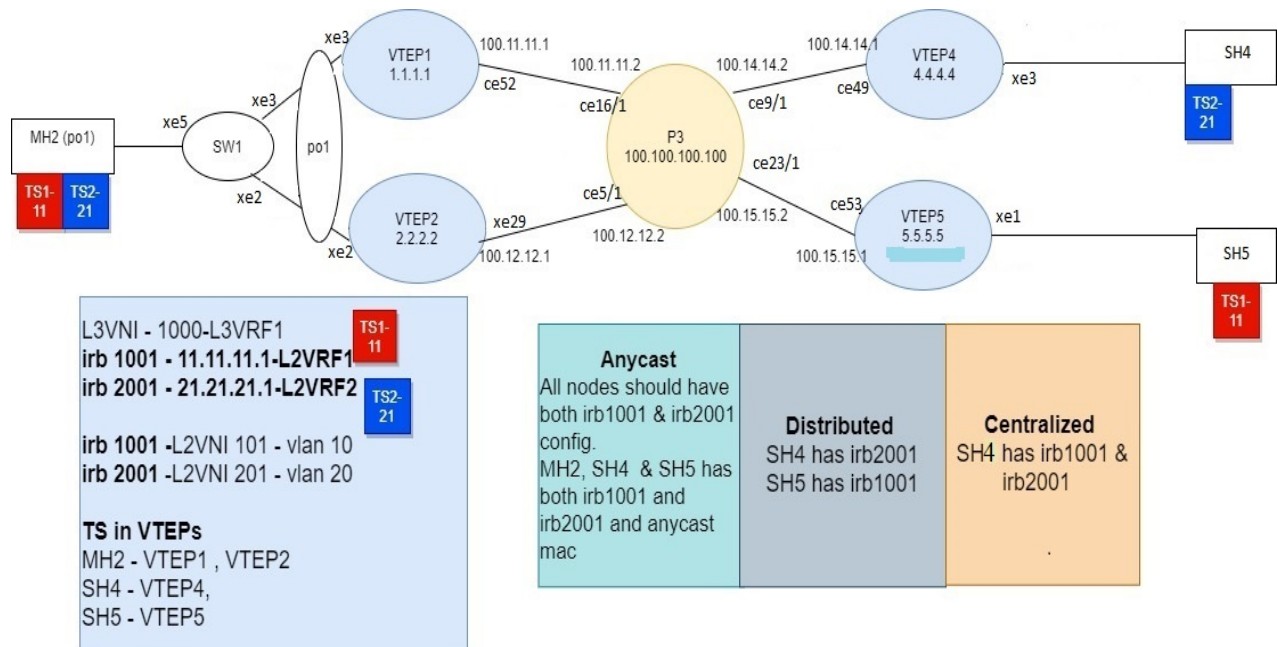

Figure 10-11: VxLAN_EVPN_IRB

Note: In the above topology TS1, TS2 are the tenant systems. The blue and red color denotes different subnets in the Tenant systems.

Base Configuration - L2 VxLAN

VTEP1

(Multi-homed group1) - Part of both Multi-homed with po1(MH2).

Hardware profile and generic configuration:

#configure terminal	Enter Configure mode.
(config)#hardware-profile filter vxlan enable	Enable hardware-profile filter for VxLAN.
(config)#hardware-profile filter vxlan-mh enable	Enable hardware-profile filter for VxLAN multi-homing.
(config)#hardware-profile filter egress-ipv4 enable	Enable hardware-profile filter for egress IPv4.
(config)#evpn vxlan multihoming enable	Enable Multihoming, save configs and reboot the board for multihoming to be effective
(config)#hardware-profile statistics ac-lif enable	Enable ac-lif for vxlan access-if port counters
(config)#qos enable	Enabling qos

Interface and loopback configuration:

(config)#interface po1	Enter Interface mode for po1 (MH2)
(config-if)#switchport	Make it L2 interface
(config-if)# evpn multi-homed system-mac 0000.0000.2222	Configure system mac as ESI value for Lag (po1) interface. VTEP1 and VTEP2 should have same ESI value
(config-if)#exit	Exit Interface mode and return to Configure mode.
(config)#interface xe3	Enter Interface mode for xe3
(config-if)#channel-group 1 mode active	Make it member port of po1
(config-if)#exit	Exit Interface mode and return to Configure mode.
(config)#interface lo	Enter Interface mode for lo
(config-if)#ip address 1.1.1.1/32 secondary	Configure loopback ip address as 1.1.1.1 for VTEP1
(config-if)#exit	Exit Interface mode and return to Configure mode.
(config)#interface ce52	Enter Interface mode for network side port
(config-if)#ip address 100.11.11.1/24	Configure ip address as 100.11.11.1 on network side of Spine-P3
(config-if)#exit	Exit Interface mode and return to Configure mode.

OSPF configuration:

(config)#router ospf 100	Enter into router OSPF mode
(config-router)#ospf router-id 1.1.1.1	Configure router-id as 1.1.1.1 (lo ip address)
(config-router)#network 1.1.1.1/32 area 0.0.0.0	Add 1.1.1.1 (lo ip address) network into area 0
(config-router)#network 100.11.11.0/24 area 0.0.0.0	Add 100.11.11.0(Spine-P3) network into area 0
(config-router)#bfd all-interfaces	Enabling bfd on all ospf interface for fast convergence
(config-if)#exit	Exit Interface mode and return to Configure mode.

BGP configuration:

(config)#router bgp 5000	Enter into Router BGP mode
(config-router)#bgp router-id 1.1.1.1	Configure router-id as 1.1.1.1 (lo ip address)
(config-router)#neighbor 2.2.2.2 remote-as 5000	Specify a VTEP2 loopback ip address and remote-as defined
(config-router)#neighbor 2.2.2.2 update-source lo	Configure update as loopback for VTEP2
(config-router)#neighbor 2.2.2.2 advertisement-interval 0	Configure advertisement-interval as 0 for fast convergence for VTEP2
(config-router)#neighbor 4.4.4.4 remote-as 5000	Specify a VTEP4 loopback ip address and remote-as defined
(config-router)#neighbor 4.4.4.4 update-source lo	Configure update as loopback for VTEP4
(config-router)#neighbor 4.4.4.4 advertisement-interval 0	Configure advertisement-interval as 0 for fast convergence for VTEP4
(config-router)#neighbor 5.5.5.5 remote-as 5000	Specify a VTEP5 loopback ip address and remote-as defined
(config-router)#neighbor 5.5.5.5 update-source lo	Configure update as loopback for VTEP5
(config-router)#neighbor 5.5.5.5 advertisement-interval 0	Configure advertisement-interval as 0 for fast convergence for VTEP5
(config-router)#address-family l2vpn evpn	Enter into l2vpn EVPN address family mode
(config-router-af)#neighbor 2.2.2.2 activate	Activate 2.2.2.2(VTEP2) into l2vpn evpn address family mode
(config-router-af)#neighbor 4.4.4.4 activate	Activate 3.3.3.3(VTEP4) into l2vpn evpn address family mode
(config-router-af)#neighbor 5.5.5.5 activate	Activate 5.5.5.5(VTEP5) into l2vpn evpn address family mode
(config-router-af)#exit-address-family	Exit from l2vpn address family mode
(config-router)#exit	Exit from Router BGP mode and enter into config mode

L2 MAC VRF Configuration:

(config)#mac vrf L2VRF1	Create mac routing/forwarding instance with L2VRF1 name and enter into vrf mode
(config-vrf)#rd 1.1.1.1:11	Assign RD value
(config-vrf)#description MAC VRF RED	Give description to L2VRF1 as RED
(config-vrf)#route-target both 9.9.9.9:100	Assign route-target value for same for import and export. Should be same on all node for L2VRF1
(config-vrf)#exit	Exit from vrf mode
(config)#mac vrf L2VRF2	Create mac routing/forwarding instance with L2VRF2 name and enter into vrf mode
(config-vrf)#rd 1.1.1.1:21	Assign RD value
(config-vrf)#route-target both 90.90.90.90:100	Assign route-target value for same for import and export
(config-vrf)#description MAC VRF BLUE	Give description to L2VRF2 as BLUE
(config-vrf)#exit	Exit from vrf mode

L2 VxLAN configuration:

(config)#nvo vxlan enable	Enable VxLAN
(config)#evpn esi hold-time 90	Configure ESI hold time to allow tunnel to come up at the time of vxlan initialization before making the ESI up. It should be same on both VTEP1 and VTEP2
(config)#nvo vxlan vtep-ip-global 1.1.1.1	Configure Source vtep-ip-global configuration - Use loopback ip address
(config)#nvo vxlan id 101 ingress-replication inner-vid-disabled	Configure VxLAN Network identifier with/without inner-vid-disabled configure and enter into VxLAN tenant mode
(config-nvo)#vxlan host-reachability-protocol evpn-bgp L2VRF1	Assign vrf for evpn-bgp to carry EVPN route
(config-nvo)# vni-name VNI-101	Configure VNI name as VNI-101
(config-nvo)#exit	Exit from VxLAN tenant mode and enter into configuration mode.
(config)#nvo vxlan id 201 ingress-replication inner-vid-disabled	Configure VxLAN Network identifier with/without inner-vid-disabled configure and enter into VxLAN tenant mode
(config-nvo)#vxlan host-reachability-protocol evpn-bgp L2VRF2	Assign vrf for evpn-bgp to carry EVPN route
(config-nvo)# vni-name VNI-201	Configure VNI name as VNI-201
(config-nvo)#exit	Exit from VxLAN tenant mode and enter into configuration mode.
(config)#nvo vxlan access-if port-vlan po1 10	Enable port-vlan mapping i.e. access port to outer-vlan (SVLAN) - Multihomed access port
(config-nvo-acc-if)#map vnid 101	Map VxLAN Identified to access-port for VxLAN
(config-nvo-acc-if)# mac 0000.2222.1010 ip 11.11.11.51	Configure static mac-ip
(config-nvo-acc-if)#exit	Exit from VxLAN access-interface mode and enter into configuration mode
(config)#nvo vxlan access-if port-vlan po1 20	Enable port-vlan mapping i.e. access port to outer-vlan (SVLAN) - Multihomed access port
(config-nvo-acc-if)#map vnid 201	Map VxLAN Identified to access-port for VxLAN
(config-nvo-acc-if)# mac 0000.2222.1020 ip 21.21.21.51	Configure static mac-ip
(config-nvo-acc-if)#commit	Commit the candidate configuration to the running configuration
(config-nvo-acc-if)#exit	Exit from VxLAN access-interface mode and enter into configuration mode
(config)#exit	Exit from configuration mode

VTEP2

(Multi-homed group1) - Part of both Multi-homed with po1(MH1).

Hardware profile and generic configuration:

#configure terminal	Enter Configure mode.
(config)#hardware-profile filter vxlan enable	Enable hardware-profile filter for VxLAN.

(config)#hardware-profile filter vxlan-mh enable	Enable hardware-profile filter for VxLAN multi-homing.
(config)#hardware-profile filter egress-ipv4 enable	Enable hardware-profile filter for egress IPv4.
(config)#evpn vxlan multihoming enable	Enable Multihoming, save configs and reboot the board for multihoming to be effective
(config)#hardware-profile statistics ac-lif enable	Enable ac-lif for vxlan access-if port counters
(config)#qos enable	Enabling qos

Interface and loopback configuration:

(config)#interface po1	Enter Interface mode for po1 (MH2)
(config-if)#switchport	Make it L2 interface
(config-if)# evpn multi-homed system-mac 0000.0000.2222	Configure system mac as ESI value for Lag (po1) interface. VTEP1 and VTEP2 should have same ESI value
(config-if)#exit	Exit Interface mode and return to Configure mode.
(config)#interface xe2	Enter Interface mode for xe2
(config-if)#channel-group 1 mode active	Make it member port of po1
(config-if)#exit	Exit Interface mode and return to Configure mode.
(config)#interface lo	Enter Interface mode for lo
(config-if)#ip address 2.2.2.2/32 secondary	Configure loopback ip address as 2.2.2.2 for VTEP2
(config-if)#exit	Exit Interface mode and return to Configure mode.
(config) interface xe29	Enter into network side interface
(config-if)#ip address 100.12.12.1/24	Configure ip address as 100.12.12.1 on network side of Spine-P3
(config-if)#exit	Exit Interface mode and return to Configure mode.

OSPF configuration:

(config)#router ospf 100	Enter into router OSPF mode
(config-router)#ospf router-id 2.2.2.2	Configure router-id as 2.2.2.2 (lo ip address)
(config-router)#network 2.2.2.2/32 area 0.0.0.0	Add 2.2.2.2 (lo ip address) network into area 0
(config-router)#network 100.12.12.0/24 area 0.0.0.0	Add 100.12.12.0(Spine-P3) network into area 0
(config-router)#bfd all-interfaces	Enabling bfd on all ospf interface for fast convergence
(config-if)#exit	Exit Interface mode and return to Configure mode.

BGP configuration:

(config)#router bgp 5000	Enter into Router BGP mode
(config-router)#bgp router-id 2.2.2.2	Configure router-id as 2.2.2.2 (lo ip address)
(config-router)#neighbor 1.1.1.1 remote-as 5000	Specify a VTEP1 loopback ip address and remote-as defined

(config-router)#neighbor 1.1.1.1 update-source lo	Configure update as loopback for VTEP1
(config-router)#neighbor 1.1.1.1 advertisement-interval 0	Configure advertisement-interval as 0 for fast convergence for VTEP1
(config-router)#neighbor 4.4.4.4 remote-as 5000	Specify a VTEP4 loopback ip address and remote-as defined
(config-router)#neighbor 4.4.4.4 update-source lo	Configure update as loopback for VTEP4
(config-router)#neighbor 4.4.4.4 advertisement-interval 0	Configure advertisement-interval as 0 for fast convergence for VTEP4
(config-router)#neighbor 5.5.5.5 remote-as 5000	Specify a VTEP5 loopback ip address and remote-as defined
(config-router)#neighbor 5.5.5.5 update-source lo	Configure update as loopback for VTEP5
(config-router)#neighbor 5.5.5.5 advertisement-interval 0	Configure advertisement-interval as 0 for fast convergence for VTEP5
(config-router)#address-family l2vpn evpn	Enter into l2vpn EVPN address family mode
(config-router-af)#neighbor 1.1.1.1 activate	Activate 1.1.1.1(VTEP1) into l2vpn evpn address family mode
(config-router-af)#neighbor 4.4.4.4 activate	Activate 4.4.4.4(VTEP4) into l2vpn evpn address family mode
(config-router-af)#neighbor 5.5.5.5 activate	Activate 5.5.5.5(VTEP5) into l2vpn evpn address family mode
(config-router-af)#exit-address-family	Exit from l2vpn address family mode
(config-router)#exit	Exit from Router BGP mode and enter into config mode

VRF Configuration:

(config)#mac vrf L2VRF1	Create mac routing/forwarding instance with L2VRF1 name and enter into vrf mode
(config-vrf)#rd 2.2.2.2:11	Assign RD value
(config-vrf)#description MAC VRF RED	Give description to L2VRF1 as RED
(config-vrf)#route-target both 9.9.9.9:100	Assign route-target value for same for import and export. Should be same on all node for L2VRF1
(config-vrf)#exit	Exit from vrf mode
(config)#mac vrf L2VRF2	Create mac routing/forwarding instance with L2VRF2 name and enter into vrf mode
(config-vrf)#rd 2.2.2.2:21	Assign RD value
(config-vrf)#route-target both 90.90.90.90:100	Assign route-target value for same for import and export
(config-vrf)#description MAC VRF BLUE	Give description to L2VRF2 as BLUE
(config-vrf)#exit	Exit from vrf mode

VxLAN configuration:

(config)#nvo vxlan enable	Enable VxLAN
(config)#evpn esi hold-time 90	Configure ESI hold time to allow tunnel to come up at the time of vxlan initialization before making the ESI up.It should be same on both VTEP1 and VTEP2

(config)#nvo vxlan vtep-ip-global 2.2.2.2	Configure Source vtep-ip-global configuration - Use loopback ip address
(config)#nvo vxlan id 101 ingress-replication inner-vid-disabled	Configure VxLAN Network identifier with/without inner-vid-disabled configure and enter into VxLAN tenant mode
(config-nvo)#vxlan host-reachability-protocol evpn-bgp L2VRF1	Assign vrf for evpn-bgp to carry EVPN route
(config-nvo)# vni-name VNI-101	Configure VNI name as VNI-101
(config-nvo)#exit	Exit from VxLAN tenant mode and enter into configuration mode.
(config)#nvo vxlan id 201 ingress-replication inner-vid-disabled	Configure VxLAN Network identifier with/without inner-vid-disabled configure and enter into VxLAN tenant mode
(config-nvo)#vxlan host-reachability-protocol evpn-bgp L2VRF2	Assign vrf for evpn-bgp to carry EVPN route
(config-nvo)# vni-name VNI-201	Configure VNI name as VNI-201
(config-nvo)#exit	Exit from VxLAN tenant mode and enter into configuration mode.
(config)#nvo vxlan access-if port-vlan po1 10	Enable port-vlan mapping i.e. access port to outer-vlan (SVLAN) - Multihomed access port
(config-nvo-acc-if)#map vnid 101	Map VxLAN Identified to access-port for VxLAN
(config-nvo-acc-if)# mac 0000.2222.1010 ip 11.11.11.51	Configure static mac-ip
(config-nvo-acc-if)#exit	Exit from VxLAN access-interface mode and enter into configuration mode
(config)#nvo vxlan access-if port-vlan po1 20	Enable port-vlan mapping i.e. access port to outer-vlan (SVLAN) - Multihomed access port
(config-nvo-acc-if)#map vnid 201	Map VxLAN Identified to access-port for VxLAN
(config-nvo-acc-if)# mac 0000.2222.1020 ip 21.21.21.51	Configure static mac-ip
(config-nvo-acc-if)#commit	Commit the candidate configuration to the running configuration
(config-nvo-acc-if)#exit	Exit from VxLAN access-interface mode and enter into configuration mode
(config)#exit	Exit from configuration mode

VTEP4

Single Home -SH5.

Hardware profile and generic configuration:

#configure terminal	Enter Configure mode.
(config)#hardware-profile filter vxlan enable	Enable hardware-profile filter for VxLAN.
(config)#hardware-profile filter vxlan-mh enable	Enable hardware profile mh in SH VTEP also
(config)#hardware-profile filter egress-ipv4 enable	Enable hardware-profile filter for egress IPv4.
(config)#hardware-profile statistics ac-lif enable	Enable ac-lif for vxlan access-if port counters

(config)#evpn vxlan multihoming enable	Enable Multihoming, save configs and reboot the board for multihoming to be effective
(config)#qos enable	Enabling qos

Interface and loopback configuration:

(config)#interface xe3	Enter Interface mode for xe3
(config-if)#switchport	Make it L2 interface
(config-if)#exit	Exit Interface mode and return to Configure mode.
(config)#interface lo	Enter Interface mode for lo
(config-if)#ip address 4.4.4.4/32 secondary	Configure loopback ip address as 4.4.4.4 for VTEP4
(config-if)#exit	Exit Interface mode and return to Configure mode.
(config) interface ce49	Enter interface towards network side
(config-if)#ip address 100.14.14.1/24	Configure ip address as 100.14.14.1 on network side of Spine-P3
(config-if)#exit	Exit Interface mode and return to Configure mode.

OSPF configuration:

(config)#router ospf 100	Enter into router OSPF mode
(config-router)#ospf router-id 4.4.4.4	Configure router-id as 4.4.4.4 (lo ip address)
(config-router)#network 4.4.4.4/32 area 0.0.0.0	Add 4.4.4.4 (lo ip address) network into area 0
(config-router)#network 100.14.14.0/24 area 0.0.0.0	Add 100.14.14.0(Spine-P3) network into area 0
(config-router)#bfd all-interfaces	Enabling bfd on all ospf interface for fast convergence
(config-if)#exit	Exit Interface mode and return to Configure mode.

BGP configuration:

(config)#router bgp 5000	Enter into Router BGP mode
(config-router)#bgp router-id 4.4.4.4	Configure router-id as 4.4.4.4 (lo ip address)
(config-router)#neighbor 1.1.1.1 remote-as 5000	Specify a VTEP1 loopback ip address and remote-as defined
(config-router)#neighbor 1.1.1.1 update-source lo	Configure update as loopback for VTEP1
(config-router)#neighbor 1.1.1.1 advertisement-interval 0	Configure advertisement-interval as 0 for fast convergence for VTEP1
(config-router)#neighbor 2.2.2.2 remote-as 5000	Specify a VTEP2 loopback ip address and remote-as defined
(config-router)#neighbor 2.2.2.2 update-source lo	Configure update as loopback for VTEP2
(config-router)#neighbor 2.2.2.2 advertisement-interval 0	Configure advertisement-interval as 0 for fast convergence for VTEP2

(config-router)#neighbor 5.5.5.5 remote-as 5000	Specify a VTEP5 loopback ip address and remote-as defined
(config-router)#neighbor 5.5.5.5 update-source lo	Configure update as loopback for VTEP5
(config-router)#neighbor 5.5.5.5 advertisement-interval 0	Configure advertisement-interval as 0 for fast convergence for VTEP5
(config-router)#address-family l2vpn evpn	Enter into l2vpn EVPN address family mode
(config-router-af)#neighbor 1.1.1.1 activate	Activate 1.1.1.1(VTEP1) into l2vpn evpn address family mode
(config-router-af)#neighbor 2.2.2.2 activate	Activate 2.2.2.2(VTEP2) into l2vpn evpn address family mode
(config-router-af)#neighbor 5.5.5.5 activate	Activate 5.5.5.5(VTEP5) into l2vpn evpn address family mode
(config-router-af)#exit-address-family	Exit from l2vpn address family mode
(config-router)#exit	Exit from Router BGP mode and enter into config mode

VRF Configuration:

(config)#mac vrf L2VRF1	Create mac routing/forwarding instance with L2VRF1 name and enter into vrf mode
(config-vrf)#rd 4.4.4.4:11	Assign RD value
(config-vrf)#description MAC VRF RED	Give description to L2VRF1 as RED
(config-vrf)#route-target both 9.9.9.9:100	Assign route-target value for same for import and export. Should be same on all node for L2VRF1
(config-vrf)#exit	Exit from vrf mode
(config)#mac vrf L2VRF2	Create mac routing/forwarding instance with L2VRF2 name and enter into vrf mode
(config-vrf)#rd 4.4.4.4:21	Assign RD value
(config-vrf)#route-target both 90.90.90.90:100	Assign route-target value for same for import and export
(config-vrf)#description MAC VRF BLUE	Give description to L2VRF2 as BLUE
(config-vrf)#exit	Exit from vrf mode

VxLAN configuration:

(config)#nvo vxlan enable	Enable VxLAN
(config)#nvo vxlan vtep-ip-global 4.4.4.4	Configure Source vtep-ip-global configuration. Use loopback ip address
(config)#nvo vxlan id 101 ingress-replication inner-vid-disabled	Configure VxLAN Network identifier with/without inner-vid-disabled configure and enter into VxLAN tenant mode
(config-nvo)#vxlan host-reachability-protocol evpn-bgp L2VRF1	Assign vrf for evpn-bgp to carry EVPN route
(config-nvo)# vni-name VNI-101	Configure VNI name as VNI-101
(config-nvo)#exit	Exit from VxLAN tenant mode and enter into configuration mode.
(config)#nvo vxlan id 201 ingress-replication inner-vid-disabled	Configure VxLAN Network identifier with/without inner-vid-disabled configure and enter into VxLAN tenant mode
(config-nvo)#vxlan host-reachability-protocol evpn-bgp L2VRF2	Assign vrf for evpn-bgp to carry EVPN route
(config-nvo)# vni-name VNI-201	Configure VNI name as VNI-201

(config-nvo)#exit	Exit from VxLAN tenant mode and enter into configuration mode.
(config)# nvo vxlan access-if port-vlan xe3 20	Enable port-vlan mapping i.e. access port to outer-vlan (SVLAN)
(config-nvo-acc-if)#map vnid 201	Map VxLAN Identified to access-port for VxLAN
(config-nvo-acc-if)# mac 0000.5555.1020 ip 21.21.21.101	Configure static mac-ip
(config-nvo-acc-if)#commit	Commit the candidate configuration to the running configuration
(config-nvo-acc-if)#exit	Exit from VxLAN access-interface mode and enter into configuration mode
(config)#exit	Exit from configuration mode

VTEP5

Single Home -SH3

Hardware profile and generic configuration:

#configure terminal	Enter Configure mode.
(config)#hardware-profile filter vxlan enable	Enable hardware-profile filter for VxLAN.
(config)#hardware-profile filter vxlan-mh enable	Enable hardware profile mh in SH VTEP also
(config)#hardware-profile filter egress-ipv4 enable	Enable hardware-profile filter for egress IPv4.
(config)#hardware-profile statistics ac-lif enable	Enable ac-lif for vxlan access-if port counters
(config)#evpn vxlan multihoming enable	Enable Multihoming, save configs and reboot the board for multihoming to be effective
(config)#qos enable	Enabling qos

Interface and loopback configuration:

(config)#interface xe1	Enter Interface mode for xe1 (SH5)
(config-if)#switchport	Make it L2 interface
(config-if)#exit	Exit Interface mode and return to Configure mode.
(config)#interface lo	Enter Interface mode for lo
(config-if)#ip address 5.5.5.5/32 secondary	Configure loopback ip address as 5.5.5.5 for VTEP5
(config-if)#exit	Exit Interface mode and return to Configure mode.
(config) interface ce53	Enter interface mode
(config-if)#ip address 100.15.15.1/24	Configure ip address as 100.15.15.1 on network side of Spine-P3
(config-if)#exit	Exit Interface mode and return to Configure mode.

OSPF configuration:

(config)#router ospf 100	Enter into router OSPF mode
(config-router)#ospf router-id 5.5.5.5	Configure router-id as 5.5.5.5 (lo ip address)
(config-router)#network 5.5.5.5/32 area 0.0.0.0	Add 5.5.5.5 (lo ip address) network into area 0
(config-router)#network 100.15.15.0/24 area 0.0.0.0	Add 100.15.15.0(Spine-P3) network into area 0
(config-router)#bfd all-interfaces	Enabling bfd on all ospf interface for fast convergence
(config-if)#exit	Exit Interface mode and return to Configure mode.

BGP configuration:

(config)#router bgp 5000	Enter into Router BGP mode
(config-router)#bgp router-id 5.5.5.5	Configure router-id as 5.5.5.5(lo ip address)
(config-router)#neighbor 1.1.1.1 remote-as 5000	Specify a VTEP1 loopback ip address and remote-as defined
(config-router)#neighbor 1.1.1.1 update-source lo	Configure update as loopback for VTEP1
(config-router)#neighbor 1.1.1.1 advertisement-interval 0	Configure advertisement-interval as 0 for fast convergence for VTEP1
(config-router)#neighbor 2.2.2.2 remote-as 5000	Specify a VTEP2 loopback ip address and remote-as defined
(config-router)#neighbor 2.2.2.2 update-source lo	Configure update as loopback for VTEP2
(config-router)#neighbor 2.2.2.2 advertisement-interval 0	Configure advertisement-interval as 0 for fast convergence for VTEP2
(config-router)#neighbor 4.4.4.4 remote-as 5000	Specify a VTEP4 loopback ip address and remote-as defined
(config-router)#neighbor 4.4.4.4 update-source lo	Configure update as loopback for VTEP4
(config-router)#neighbor 4.4.4.4 advertisement-interval 0	Configure advertisement-interval as 0 for fast convergence for VTEP4
(config-router)#address-family l2vpn evpn	Enter into l2vpn EVPN address family mode
(config-router-af)#neighbor 1.1.1.1 activate	Activate 1.1.1.1(VTEP1) into l2vpn evpn address family mode
(config-router-af)#neighbor 2.2.2.2 activate	Activate 2.2.2.2(VTEP2) into l2vpn evpn address family mode
(config-router-af)#neighbor 4.4.4.4 activate	Activate 4.4.4.4(VTEP4) into l2vpn evpn address family mode
(config-router-af)#exit-address-family	Exit from l2vpn address family mode
(config-router)#exit	Exit from Router BGP mode and enter into config mode

VRF Configuration:

(config)#mac vrf L2VRF1	Create mac routing/forwarding instance with L2VRF1 name and enter into vrf mode
(config-vrf)#rd 5.5.5.5:11	Assign RD value
(config-vrf)#description MAC VRF RED	Give description to L2VRF1 as RED

(config-vrf)#route-target both 9.9.9.9:100	Assign route-target value for same for import and export. Should be same on all node for L2VRF1
(config-vrf)#exit	Exit from vrf mode
(config)#mac vrf L2VRF2	Create mac routing/forwarding instance with L2VRF2 name and enter into vrf mode
(config-vrf)#rd 5.5.5.5:21	Assign RD value
(config-vrf)#route-target both 90.90.90.90:100	Assign route-target value for same for import and export
(config-vrf)#description MAC VRF BLUE	Give description to L2VRF2 as BLUE
(config-vrf)#exit	Exit from vrf mode

VxLAN configuration:

(config)#nvo vxlan enable	Enable VxLAN
(config)#nvo vxlan vtep-ip-global 5.5.5.5	Configure Source vtep-ip-global configuration. Use loopback ip address
(config)#nvo vxlan id 101 ingress-replication inner-vid-disabled	Configure VxLAN Network identifier with/without inner-vid-disabled configure and enter into VxLAN tenant mode
(config-nvo)#vxlan host-reachability-protocol evpn-bgp L2VRF1	Assign vrf for evpn-bgp to carry EVPN route
(config-nvo)# vni-name VNI-101	Configure VNI name as VNI-101
(config-nvo)#exit	Exit from VxLAN tenant mode and enter into configuration mode.
(config)#nvo vxlan id 201 ingress-replication inner-vid-disabled	Configure VxLAN Network identifier with/without inner-vid-disabled configure and enter into VxLAN tenant mode
(config-nvo)#vxlan host-reachability-protocol evpn-bgp L2VRF2	Assign vrf for evpn-bgp to carry EVPN route
(config-nvo)# vni-name VNI-201	Configure VNI name as VNI-201
(config-nvo)#exit	Exit from VxLAN tenant mode and enter into configuration mode.
(config)# nvo vxlan access-if port-vlan xe1 10	Enable port-vlan mapping i.e. access port to outer-vlan (SVLAN)
(config-nvo-acc-if)#map vnid 101	Map VxLAN Identified to access-port for VxLAN
(config-nvo-acc-if)# mac 0000.4444.1010 ip 11.11.11.201	Configure static mac-ip
(config-nvo-acc-if)#commit	Commit the candidate configuration to the running configuration
(config-nvo-acc-if)#exit	Exit from VxLAN access-interface mode and enter into configuration mode
(config)#exit	Exit from configuration mode

Switch1 (MH2)

Multihomed to 2-VTEPs (VTEP1 and VTEP2). It acts as Tenant system for vlan1.20.

#configure terminal	Enter Configure mode.
(config)# bridge 1 protocol rstp vlan-bridge	Configure rstp vlan bridge
(config)# vlan database	Enter vlan database config mode

(config)#vlan 2-20 bridge 1 state enable	Configure vlans from 2-20 and associate with bridge 1
(config)#interface xe5	Enter Interface mode for xe5 which is connected to TG
(config-if)#switchport	Make as L2 port by configuring switchport
(config-if)#bridge-group 1	Associate bridge 1 into interface
(config-if)# bridge-group 1 spanning-tree disable	Configure interface as stp disable
(config-if)# switchport mode trunk	Mode as trunk
(config-if)# switchport trunk allowed vlan add 10,20	Trunk allowed vlan as 10.20
(config-if)#exit	Exit Interface mode and return to Configure mode.
(config)#interface po1	Enter Interface mode for po1
(config-if)#switchport	Make po1 as L2 port by configuring switchport
(config-if)#bridge-group 1	Associate po1 to bridge 1
(config-if)# bridge-group 1 spanning-tree disable	Configure po1 as stp disable
(config-if)# switchport mode trunk	Mode as trunk
(config-if)# switchport trunk allowed vlan add 10,20	Trunk allowed vlan as 2.10.20
(config-if)#exit	Exit Interface mode and return to Configure mode.
(config)#interface xe3	Enter Interface mode for xe3
(config-if)#channel-group 1 mode active	Make it member port of po1
(config)#interface xe2	Enter Interface mode for xe2
(config-if)#channel-group 1 mode active	Make it member port of po1
(config-if)#commit	Commit the candidate configuration to the running configuration
(config-if)#exit	Exit from configuration mode

Spine-P3

Spine node where all VTEPs are connected.

Generic configuration:

#configure terminal	Enter Configure mode.
(Config)#qos enable	Enabling qos

Interface and loopback configuration:

(config)#interface lo	Enter Interface mode for lo
(config-if)#ip address 100.100.100.100/32 secondary	Configure loopback ip address as 100.100.100.100 for Spine-P3
(config-if)#exit	Exit Interface mode and return to Configure mode.
(config)#interface ce16/1	Enter Interface mode for ce16/1
(config-if)#ip address 100.11.11.2/24	Configure ip address as 100.11.11.2 on network side of VTEP1
(config-if)#exit	Exit Interface mode and return to Configure mode.

(config) interface ce5/1	Enter into ce5/1 interface mode
(config-if)#ip address 100.12.12.2/24	Configure ip address as 100.12.12.2 on network side of VTEP2
(config-if)#exit	Exit Interface mode and return to Configure mode.
(config) interface ce9/1	Enter ce9/1 interface mode
(config-if)#ip address 100.14.14.2/24	Configure ip address as 100.14.14.12 on network side of VTEP4
(config-if)#exit	Exit Interface mode and return to Configure mode.
(config) interface ce23/1	Enter interface mode
(config-if)#ip address 100.15.15.1/24	Configure ip address as 100.15.15.1 on network side of VTEP5
(config-if)#exit	Exit Interface mode and return to Configure mode.

OSPF configuration:

(config)#router ospf 100	Enter into router OSPF mode
(config-router)#ospf router-id 100.100.100.100	Configure router-id as 100.100.100.100 (lo ip address)
(config-router)#network 100.100.100.100/32 area 0.0.0.0	Add 100.100.100.100 (lo ip address) network into area 0
(config-router)#network 100.11.11.0/24 area 0.0.0.0	Add 100.11.11.0 (VTEP1) network into area 0
(config-router)#network 100.12.12.0/24 area 0.0.0.0	Add 100.12.12.0 (VTEP2) network into area 0
(config-router)#network 100.14.14.0/24 area 0.0.0.0	Add 100.14.14.0 (VTEP4) network into area 0
(config-router)#network 100.15.15.0/24 area 0.0.0.0	Add 100.15.15.0 (VTEP5) network into area 0
(config-router)#bfd all-interfaces	Enabling bfd on all ospf interface for fast convergence
(config-router)#commit	Commit the candidate configuration to the running configuration
(config-router)#exit	Exit Interface mode and return to Configure mode.

Centralized Gateway

In Centralized gateway approach, when two TS belonging to two different subnets connected to the same/different VTEP node, wanted to communicate with each other, their traffic needed to be back hauled from the VTEP node to the centralized gateway node where inter-subnet switching is performed and then back to the VTEP node.

IRB Configuration for Centralized Gateway

Configure from Base Configuration-L2 VxLAN section, then configure below commands for centralized gateway approach. Here VTEP4 is the centralized GW. In VTEP4, dscp-to-queue qos profile should be applied on the particular incoming L2VNID IRB interface and dscp-encap qos profile should be applied on vxlan tunnel egress.

Note: For L3 traffic, when L2VNID is sent in the traffic, then dscp-to-queue qos profile mapped at IRB interface of that particular L2VNID takes effect.

VSTEP1

(config)#qos profile cos-to-queue COS_QUEUE	Create QoS profile for mapping traffic towards tunnel from access-if
(config-ingress-cos-map)#cos 1 queue 5	Configure particular COS value to queue value for the profile
(config-ingress-cos-map)#exit	Exit from qos profile mode
(config)#qos profile queue-color-to-dscp QUEUE_DSCP	Create QoS profile for attaching in vxlan tunnel egress
(config-egress-dscp-map)#queue 5 dscp 34	Configure queue value to DSCP value for the profile
(config)#nvo vxlan tunnel qos-map-mode cos-dscp egress QUEUE_DSCP	Map the configured QoS profile to vxlan tunnel egress
(config)#nvo vxlan access-if port-vlan po1 20	Enter into vxlan access port mode
(config-nvo-acc-if)#map qos-profile cos-to-queue COS_QUEUE	Map the qos profile in vxlan access-if
(config-nvo-acc-if)#commit	Commit the candidate configuration to the running configuration
(config-nvo-acc-if)#end	Exit from vxlan access port

VSTEP2

(config)#qos profile cos-to-queue COS_QUEUE	Create QoS profile for mapping traffic towards tunnel from access-if
(config-ingress-cos-map)#cos 1 queue 5	Configure particular COS value to queue value for the profile
(config-ingress-cos-map)#exit	Exit from qos profile mode
(config)#qos profile queue-color-to-dscp QUEUE_DSCP	Create QoS profile for attaching in vxlan tunnel egress
(config-egress-dscp-map)#queue 5 dscp 34	Configure queue value to DSCP value for the profile
(config)#nvo vxlan tunnel qos-map-mode cos-dscp egress QUEUE_DSCP	Map the configured QoS profile to vxlan tunnel egress
(config)#nvo vxlan access-if port-vlan po1 20	Enter into vxlan access port mode
(config-nvo-acc-if)#map qos-profile cos-to-queue COS_QUEUE	Map the qos profile in vxlan access-if
(config-nvo-acc-if)#commit	Commit the candidate configuration to the running configuration
(config-nvo-acc-if)#end	Exit from vxlan access port

VSTEP4

(config)#nvo vxlan irb	Enable VxLAN irb
(config)#ip vrf L3VRF1	Create mac routing/forwarding instance with L3VRF1 name and enter into vrf mode
(config-vrf)#rd 51000:11	Assign RD value
(config-vrf)# route-target both 100:100	Assign route-target value for same for import and export.
(config-vrf)# l3vni 1000	Configure L3VNI as 1000 for L3VRF1
(config-vrf)#exit	Exit from vrf mode

(config)# interface irb1001	Configure IRB interface 1001
(config-if) ip vrf forwarding L3VRF1	Configure L3VRF1
(config-if) ip address 11.11.11.1/24	Configure ip address
(config-if) ipv6 address 1111::1/64	Configure ipv6 address
(config-if) exit	Exit from interface config mode
(config)# interface irb2001	Configure IRB interface 2001
(config-if) ip vrf forwarding L3VRF1	Configure L3VRF1
(config-if) ip address 21.21.21.1/24	Configure ip address
(config-if) ipv6 address 2121::1/64	Configure ipv6 address
(config-if) exit	Exit from interface config mode
(config)# nvo vxlan id 101 ingress-replication inner-vid-disabled	Configure VxLAN Network identifier with/without inner-vid-disabled configure and enter into VxLAN tenant mode
(config-nvo)# vxlan host-reachability-protocol evpn-bgp L2VRF1	Assign vrf for evpn-bgp to carry EVPN route
(config-nvo)# evpn irb1001	Configure irb1001 under vxlan id 101
(config-nvo)# exit	Exit from VxLAN tenant mode and enter into configuration mode.
(config)# nvo vxlan id 201 ingress-replication inner-vid-disabled	Configure VxLAN Network identifier with/without inner-vid-disabled configure and enter into VxLAN tenant mode
(config-nvo)# vxlan host-reachability-protocol evpn-bgp L2VRF2	Assign vrf for evpn-bgp to carry EVPN route
(config-nvo)# evpn irb2001	Configure irb2001 under vxlan id 201
(config-nvo)# exit	Exit from VxLAN tenant mode and enter into configuration mode.
(config)# qos profile dscp-to-queue DSCP_QUEUE	Configure the QoS profile to match the inner dscp value of the traffic at the IRB interface
(config-ingress-dscp-map)# dscp 20 queue 1	Configure particular dscp to a queue value. Configure particular dscp to a queue value. Here classification at the IRB L3 interface is based on customer dscp value.
(config-ingress-dscp-map)# exit	Exit from qos profile config mode
(config)# qos profile dscp-encap DSCP_ENCAP	Configure the QoS profile to remark the overlay dscp value of the traffic in vxlan tunnel egress.
(config-egress-dscp-encap-map)# 13 dscp 20 dscpEncap 56	Egress remarking of the customer dscp packet to overlay dscp. Here classification at the egress vtep is based on customer dscp value
(config-egress-dscp-encap-map)# exit	Exit from qos profile mode
config)# int irb2001	Enter IRB L3 interface mode
(config-irb-if)# qos map-profile dscp-to-queue DSCP_QUEUE	Map the qos profile in the IRB interface
(config-irb-if)# exit	Exit from interface mode
(config)# nvo vxlan tunnel qos-map-mode cos-dscp egress DSCP_ENCAP	Map the qos profile in vxlan tunnel egress
(config)# commit	Commit the candidate configuration to the running configuration
(config)# end	Exit from global config mode

VTEP5

(config)#qos profile queue-color-to-cos QUEUE_COS	Create QoS profile for remark the queue value to COS value
VTEP5(config-egress-cos-map)#queue 2 cos 5	Configure particular queue value to COS value for the profile
(config-ingress-cos-map)#exit	Exit from qos profile mode
(config)# qos profile dscp-to-queue DSCP_QUEUE	Create QoS profile for attaching in vxlan tunnel ingress
(config-ingress-dscp-map)#dscp 56 queue 2	Configure DSCP value to queue value for the profile
(config)#nvo vxlan tunnel qos-map-mode cos-dscp ingress DSCP_QUEUE	Map the configured QoS profile to vxlan tunnel ingress
(config)#nvo vxlan access-if port-vlan xe1 10	Enter into vxlan access port mode
(config-nvo-acc-if)#map qos-profile queue-color-to-cos QUEUE_COS	Map the qos profile in vxlan access-if
(config-nvo-acc-if)#commit	Commit the candidate configuration to the running configuration
(config-nvo-acc-if)#end	Exit from vxlan access port

Validation

Send traffic from TS2-21 to MH2 access-if with dscp value 20 and COS value 1(vlan20) and verify traffic received at TS1-11 with dscp value 32 and COS value 5(vlan10) at the VTEP5 access-if.

VTEP1

```
VTEP1#show running-config qos
qos enable
!
qos profile cos-to-queue COS_QUEUE
  cos 1 queue 5
!
qos profile queue-color-to-dscp QUEUE_DSCP
  queue 5 color all dscp 34
!
!
!
VTEP1#show running-config nvo vxlan
!
nvo vxlan enable
!
evpn vxlan multihoming enable
!
nvo vxlan vtep-ip-global 1.1.1.1
!
nvo vxlan tunnel qos-map-mode cos-dscp egress QUEUE_DSCP
!
nvo vxlan id 101 ingress-replication inner-vid-disabled
  vxlan host-reachability-protocol evpn-bgp L2VRF1
  vni-name VNI-101
!
nvo vxlan id 201 ingress-replication inner-vid-disabled
  vxlan host-reachability-protocol evpn-bgp L2VRF2
  vni-name VNI-201
!
nvo vxlan access-if port-vlan po1 10
  map vnid 101
  mac 0000.2222.1010 ip 11.11.11.51
!
```

```
nvo vxlan access-if port-vlan po1 20
map vnid 201
mac 0000.2222.1020 ip 21.21.21.51
map qos-profile cos-to-queue COS_QUEUE
!
```

```
VTEP1#show nvo vxlan tunnel
VxLAN Network tunnel Entries
```

Source	Destination	Status	Up/Down	Update
1.1.1.1	5.5.5.5	Installed	01:15:13	01:15:13
1.1.1.1	4.4.4.4	Installed	01:15:28	01:15:28
1.1.1.1	2.2.2.2	Installed	01:11:40	01:11:40

```
Total number of entries are 3
VTEP1#show interface ce52 counters queue-stats
E - Egress, I - Ingress, Q-Size is in bytes
```

Queue/Class-map	Q-Size	Tx pkts	Tx bytes	Dropped pkts	Dropped bytes
q0	(E) 125304832	0	0	0	0
q1	(E) 125304832	0	0	0	0
q2	(E) 125304832	0	0	0	0
q3	(E) 125304832	0	0	0	0
q4	(E) 125304832	0	0	0	0
q5	(E) 125304832	1316880	1316879000	0	0
q6	(E) 125304832	0	0	0	0
q7	(E) 125304832	0	0	0	0

```
VTEP1#show qos-profile COS_QUEUE
profile name: COS_QUEUE
profile type: cos-to-queue
profile attached to 1 instances
configured mapping:
cos 1 queue 5
Detailed mapping:
```

INPUT				OUTPUT			
COS	DEI	Queue	Color	COS	DEI	Queue	Color
0	0	0	green	0	1	0	yellow
1	0	5	green	1	1	5	yellow
2	0	2	green	2	1	2	yellow
3	0	3	green	3	1	3	yellow
4	0	4	green	4	1	4	yellow
5	0	5	green	5	1	5	yellow
6	0	6	green	6	1	6	yellow
7	0	7	green	7	1	7	yellow

```
VTEP1#show qos-profile QUEUE_DSCP
profile name: QUEUE_DSCP
profile type: queue-color-to-dscp
profile attached to 1 instances
configured mapping:
queue 5 color all dscp 34
Detailed mapping:
```

INPUT			OUTPUT			INPUT			OUTPUT		
Queue	Color	DSCP	Queue	Color	DSCP	Queue	Color	DSCP	Queue	Color	DSCP
0	green	0	0	yellow	0	0	red	0	0	red	0
1	green	10	1	yellow	12	1	red	14	1	red	14
2	green	18	2	yellow	20	2	red	22	2	red	22
3	green	26	3	yellow	28	3	red	30	3	red	30
4	green	34	4	yellow	36	4	red	38	4	red	38
5	green	34	5	yellow	34	5	red	34	5	red	34
6	green	48	6	yellow	48	6	red	48	6	red	48
7	green	56	7	yellow	56	7	red	56	7	red	56

VTEP4

```

VTEP4#show running-config qos
qos enable
!
qos profile dscp-to-queue DSCP_QUEUE
  dscp 20 queue 1
!
qos profile dscp-encap DSCP_ENCAP
  13 dscp 20 dscpEncap 56
!
!
!
interface irb2001
  qos map-profile dscp-to-queue DSCP_QUEUE
!
VTEP4#show running-config nvo vxlan
!
nvo vxlan enable
!
nvo vxlan irb
!
evpn vxlan multihoming enable
!
nvo vxlan vtep-ip-global 4.4.4.4
!
nvo vxlan tunnel qos-map-mode cos-dscp egress DSCP_ENCAP
!
nvo vxlan id 101 ingress-replication inner-vid-disabled
  vxlan host-reachability-protocol evpn-bgp L2VRF1
  evpn irb1001
  vni-name VNI-101
!
nvo vxlan id 201 ingress-replication inner-vid-disabled
  vxlan host-reachability-protocol evpn-bgp L2VRF2
  evpn irb2001
  vni-name VNI-201
!
nvo vxlan access-if port-vlan xe3 20
  map vnid 201
  mac 0000.5555.1020 ip 21.21.21.101
!
!

```

```

VTEP4#show nvo vxlan tunnel
VxLAN Network tunnel Entries
Source          Destination    Status          Up/Down         Update
=====
4.4.4.4         2.2.2.2       Installed       00:08:40        00:08:40
4.4.4.4         1.1.1.1       Installed       00:12:28        00:12:28
4.4.4.4         5.5.5.5       Installed       00:12:13        00:12:13

```

Total number of entries are 3

```

VTEP4#show nvo vxlan
VxLAN Information
=====

```

```

Codes: NW - Network Port
       AC - Access Port
       (u) - Untagged

```

VNID	VNI-Name	VNI-Type	Type	Interface	ESI	VLAN	DF-Status	Src-Addr	Dst-Addr
101	VNI-101	L2	NW	----	----	----	----	4.4.4.4	2.2.2.2
101	VNI-101	L2	NW	----	----	----	----	4.4.4.4	1.1.1.1
101	VNI-101	L2	NW	----	----	----	----	4.4.4.4	5.5.5.5
201	VNI-201	L2	NW	----	----	----	----	4.4.4.4	2.2.2.2
201	VNI-201	L2	NW	----	----	----	----	4.4.4.4	1.1.1.1
201	VNI-201	L2	NW	----	----	----	----	4.4.4.4	5.5.5.5
201	VNI-201	--	AC	xe3	---	Single Homed Port	---	20	----

Total number of entries are 7

```

VTEP4#show nvo vxlan arp-cache

```

VxLAN ARP-CACHE Information

```

=====
VNID      Ip-Addr      Mac-Addr      Type      Age-Out      Retries-Left
-----
201      21.21.21.51  0000.2222.1020 Static Remote ----
201      21.21.21.1   3c2c.991a.da7a Static Local  ----
201      21.21.21.101 0000.5555.1020 Static Local  ----
101      11.11.11.51  0000.2222.1010 Static Remote ----
101      11.11.11.1   3c2c.991a.da7a Static Local  ----
101      11.11.11.201 0000.4444.1010 Static Remote ----
    
```

Total number of entries are 6

VTEP4#show nvo vxlan nd-cache

VxLAN ND-CACHE Information

```

=====
VNID      Ip-Addr      Mac-Addr      Type      Age-Out      Retries-Left
-----
201      2121::1      3c2c.991a.da7a Static Local  ----
101      1111::1      3c2c.991a.da7a Static Local  ----
    
```

Total number of entries are 2

VTEP4#show nvo vxlan l3vni-map

```

L3VNI      L2VNI      IRB-interface
-----
1000      101        irb1001
1000      201        irb2001
    
```

VTEP4#show ipv4 route vrf L3VRF1

```

Codes: K - kernel, C - connected, S - static, R - RIP, B - BGP
       O - OSPF, IA - OSPF inter area
       N1 - OSPF NSSA external type 1, N2 - OSPF NSSA external type 2
       E1 - OSPF external type 1, E2 - OSPF external type 2
       i - IS-IS, L1 - IS-IS level-1, L2 - IS-IS level-2,
       ia - IS-IS inter area, E - EVPN,
       v - vrf leaked
       * - candidate default
    
```

IP Route Table for VRF "L3VRF1"

```

C      11.11.11.0/24 is directly connected, irb1001, 00:01:35
C      21.21.21.0/24 is directly connected, irb2001, 00:01:16
C      127.0.0.0/8 is directly connected, lo.L3VRF1, 00:06:12
    
```

Gateway of last resort is not set

VTEP4#show ipv6 route vrf L3VRF1

IPv6 Routing Table

```

Codes: K - kernel route, C - connected, S - static, D- DHCP, R - RIP,
       O - OSPF, IA - OSPF inter area, E1 - OSPF external type 1,
       E2 - OSPF external type 2, E - EVPN N1 - OSPF NSSA external type 1,
       N2 - OSPF NSSA external type 2, i - IS-IS, B - BGP,
       v - vrf leaked
    
```

Timers: Uptime

IP Route Table for VRF "L3VRF1"

```

C      ::1/128 via ::, lo.L3VRF1, 00:06:29
C      1111::/64 via ::, irb1001, 00:01:52
C      2121::/64 via ::, irb2001, 00:01:33
C      fe80::/64 via ::, irb2001, 00:01:33
    
```

VTEP4#show interface ce49 counters queue-stats

E - Egress, I - Ingress, Q-Size is in bytes

```

+-----+-----+-----+-----+-----+-----+
| Queue/Class-map | Q-Size | Tx pkts | Tx bytes | Dropped pkts | Dropped bytes |
+-----+-----+-----+-----+-----+-----+
q0      (E) 125304832 0          0          0          0
q1      (E) 125304832 1422755    1488201730 0          0
q2      (E) 125304832 0          0          0          0
q3      (E) 125304832 0          0          0          0
q4      (E) 125304832 0          0          0          0
q5      (E) 125304832 0          0          0          0
q6      (E) 125304832 0          0          0          0
q7      (E) 125304832 0          0          0          0
    
```

VTEP4#show qos-profile DSCP_QUEUE

```

profile name: DSCP_QUEUE
profile type: dscp-to-queue
profile attached to 1 instances
configured mapping:
    
```

dscp 20 queue 1
Detailed mapping:

INPUT OUTPUT				INPUT OUTPUT				INPUT OUTPUT				INPUT OUTPUT		
DSCP Queue	Color	Out DSCP	Out DSCP	DSCP Queue	Color	Out DSCP	Out DSCP	DSCP Queue	Color	Out DSCP	Out DSCP	DSCP Queue	Color	Out DSCP
0 green	0 48	green	0	16 2	green	16	16	32 4	green	32	32	48 6		
1 green	0 49	green	1	17 2	green	17	17	33 4	green	33	33	49 6		
2 green	0 50	green	2	18 2	green	18	18	34 4	green	34	34	50 6		
3 green	0 51	green	3	19 2	green	19	19	35 4	green	35	35	51 6		
4 green	0 52	green	4	20 1	yellow	20	20	36 4	yellow	36	36	52 6		
5 green	0 53	green	5	21 2	green	21	21	37 4	green	37	37	53 6		
6 green	0 54	green	6	22 2	yellow	22	22	38 4	yellow	38	38	54 6		
7 green	0 55	green	7	23 2	green	23	23	39 4	green	39	39	55 6		
8 green	1 56	green	8	24 3	green	24	24	40 5	green	40	40	56 7		
9 green	1 57	green	9	25 3	green	25	25	41 5	green	41	41	57 7		
10 green	1 58	green	10	26 3	green	26	26	42 5	green	42	42	58 7		
11 green	1 59	green	11	27 3	green	27	27	43 5	green	43	43	59 7		
12 green	1 60	yellow	12	28 3	yellow	28	28	44 5	green	44	44	60 7		
13 green	1 61	green	13	29 3	green	29	29	45 5	green	45	45	61 7		
14 green	1 62	yellow	14	30 3	yellow	30	30	46 5	green	46	46	62 7		
15 green	1 63	green	15	31 3	green	31	31	47 5	green	47	47	63 7		

VTEP4#show qos-profile DSCP_ENCAP
profile name: DSCP_ENCAP
profile type: dscp-encap
profile attached to 1 instances
configured mapping:
13 dscp 20 dscpEncap 56

Detailed mapping:

L3 DSCP to DSCP-ENCAP

INPUT OUTPUT		INPUT OUTPUT		INPUT OUTPUT		INPUT OUTPUT	
DSCP	DSCP	DSCP	DSCP	DSCP	DSCP	DSCP	DSCP
0	0	16	16	32	32	48	48
1	1	17	17	33	33	49	49
2	2	18	18	34	34	50	50
3	3	19	19	35	35	51	51
4	4	20	56	36	36	52	52
5	5	21	21	37	37	53	53
6	6	22	22	38	38	54	54
7	7	23	23	39	39	55	55
8	8	24	24	40	40	56	56
9	9	25	25	41	41	57	57
10	10	26	26	42	42	58	58
11	11	27	27	43	43	59	59
12	12	28	28	44	44	60	60
13	13	29	29	45	45	61	61
14	14	30	30	46	46	62	62
15	15	31	31	47	47	63	63

L2 Queue + Color to DSCP-ENCAP

INPUT OUTPUT		INPUT OUTPUT		INPUT OUTPUT		INPUT OUTPUT	
--------------	--	--------------	--	--------------	--	--------------	--

INPUT			OUTPUT			INPUT			OUTPUT		
Queue	Color	DSCP	Queue	Color	DSCP	Queue	Color	DSCP	Queue	Color	DSCP
0	green	0	0	yellow	0	0	red	0			
1	green	8	1	yellow	8	1	red	8			
2	green	16	2	yellow	16	2	red	16			
3	green	24	3	yellow	24	3	red	24			
4	green	32	4	yellow	32	4	red	32			
5	green	40	5	yellow	40	5	red	40			
6	green	48	6	yellow	48	6	red	48			
7	green	56	7	yellow	56	7	red	56			

```
VTEP4#show qos-profile interface irb2001
profile name: DSCP_QUEUE
profile type: dscp-to-queue (Ingress)
mapping:
```

INPUT				OUTPUT				INPUT				OUTPUT			
DSCP	Queue	Color	Out DSCP	DSCP	Queue	Color	Out DSCP	DSCP	Queue	Color	Out DSCP	DSCP	Queue	Color	Out DSCP
0	0	green	0	16	2	green	16	32	4	green	32	48	6		
1	0	green	1	17	2	green	17	33	4	green	33	49	6		
2	0	green	2	18	2	green	18	34	4	green	34	50	6		
3	0	green	3	19	2	green	19	35	4	green	35	51	6		
4	0	green	4	20	1	yellow	20	36	4	yellow	36	52	6		
5	0	green	5	21	2	green	21	37	4	green	37	53	6		
6	0	green	6	22	2	yellow	22	38	4	yellow	38	54	6		
7	0	green	7	23	2	green	23	39	4	green	39	55	6		
8	1	green	8	24	3	green	24	40	5	green	40	56	7		
9	1	green	9	25	3	green	25	41	5	green	41	57	7		
10	1	green	10	26	3	green	26	42	5	green	42	58	7		
11	1	green	11	27	3	green	27	43	5	green	43	59	7		
12	1	yellow	12	28	3	yellow	28	44	5	green	44	60	7		
13	1	green	13	29	3	green	29	45	5	green	45	61	7		
14	1	yellow	14	30	3	yellow	30	46	5	green	46	62	7		
15	1	green	15	31	3	green	31	47	5	green	47	63	7		

```
profile name: default
profile type: dscp-to-dscp (Egress)
Status: Inactive
mapping:
```

INPUT			OUTPUT			INPUT			OUTPUT		
DSCP	Color	Out DSCP	DSCP	Color	Out DSCP	DSCP	Color	Out DSCP	DSCP	Color	Out DSCP
0	green	0	0	yellow	0	0	red	0			
1	green	1	1	yellow	1	1	red	1			
2	green	2	2	yellow	2	2	red	2			
3	green	3	3	yellow	3	3	red	3			
4	green	4	4	yellow	4	4	red	4			
5	green	5	5	yellow	5	5	red	5			
6	green	6	6	yellow	6	6	red	6			
7	green	7	7	yellow	7	7	red	7			

8	green	8		8	yellow	8		8	red	8
9	green	9		9	yellow	9		9	red	9
10	green	10		10	yellow	12		10	red	14
11	green	11		11	yellow	11		11	red	11
12	green	12		12	yellow	12		12	red	14
13	green	13		13	yellow	13		13	red	13
14	green	14		14	yellow	14		14	red	14
15	green	15		15	yellow	15		15	red	15
16	green	16		16	yellow	16		16	red	16
17	green	17		17	yellow	17		17	red	17
18	green	18		18	yellow	20		18	red	22
19	green	19		19	yellow	19		19	red	19
20	green	20		20	yellow	20		20	red	22
21	green	21		21	yellow	21		21	red	21
22	green	22		22	yellow	22		22	red	22
23	green	23		23	yellow	23		23	red	23
24	green	24		24	yellow	24		24	red	24
25	green	25		25	yellow	25		25	red	25
26	green	26		26	yellow	28		26	red	30
27	green	27		27	yellow	27		27	red	27
28	green	28		28	yellow	28		28	red	30
29	green	29		29	yellow	29		29	red	29
30	green	30		30	yellow	30		30	red	30
31	green	31		31	yellow	31		31	red	31
32	green	32		32	yellow	32		32	red	32
33	green	33		33	yellow	33		33	red	33
34	green	34		34	yellow	36		34	red	38
35	green	35		35	yellow	35		35	red	35
36	green	36		36	yellow	36		36	red	38
37	green	37		37	yellow	37		37	red	37
38	green	38		38	yellow	38		38	red	38
39	green	39		39	yellow	39		39	red	39
40	green	40		40	yellow	40		40	red	40
41	green	41		41	yellow	41		41	red	41
42	green	42		42	yellow	42		42	red	42
43	green	43		43	yellow	43		43	red	43
44	green	44		44	yellow	44		44	red	44
45	green	45		45	yellow	45		45	red	45
46	green	46		46	yellow	46		46	red	46
47	green	47		47	yellow	47		47	red	47
48	green	48		48	yellow	48		48	red	48
49	green	49		49	yellow	49		49	red	49
50	green	50		50	yellow	50		50	red	50
51	green	51		51	yellow	51		51	red	51
52	green	52		52	yellow	52		52	red	52
53	green	53		53	yellow	53		53	red	53
54	green	54		54	yellow	54		54	red	54
55	green	55		55	yellow	55		55	red	55
56	green	56		56	yellow	56		56	red	56
57	green	57		57	yellow	57		57	red	57
58	green	58		58	yellow	58		58	red	58
59	green	59		59	yellow	59		59	red	59
60	green	60		60	yellow	60		60	red	60
61	green	61		61	yellow	61		61	red	61
62	green	62		62	yellow	62		62	red	62
63	green	63		63	yellow	63		63	red	63

VTEP5

```

VTEP5#show running-config qos
qos enable
!
qos profile queue-color-to-cos QUEUE_COS
  queue 2 color all cos 5
!
qos profile dscp-to-queue DSCP_QUEUE
  dscp 56 queue 2
!
!
!
VTEP5#show running-config nvo vxlan
!

```

```
nvo vxlan enable
!
evpn vxlan multihoming enable
!
nvo vxlan vtep-ip-global 5.5.5.5
!
nvo vxlan tunnel qos-map-mode cos-dscp ingress DSCP_QUEUE
!
nvo vxlan id 101 ingress-replication inner-vid-disabled
vxlan host-reachability-protocol evpn-bgp L2VRF1
vni-name VNI-101
!
nvo vxlan id 201 ingress-replication inner-vid-disabled
vxlan host-reachability-protocol evpn-bgp L2VRF2
vni-name VNI-201
!
nvo vxlan access-if port-vlan xel 10
map vnid 101
mac 0000.4444.1010 ip 11.11.11.201
map qos-profile queue-color-to-cos QUEUE_COS
!
!
VTEP5#show nvo vxlan tunnel
VxLAN Network tunnel Entries
Source          Destination      Status          Up/Down         Update
=====
5.5.5.5         2.2.2.2         Installed       01:11:17        01:11:17
5.5.5.5         4.4.4.4         Installed       01:14:50        01:14:50
5.5.5.5         1.1.1.1         Installed       01:14:50        01:14:50
```

```
Total number of entries are 3
VTEP5#show interface xel counters queue-stats
E - Egress, I - Ingress, Q-Size is in bytes
```

Queue/Class-map	Q-Size	Tx pkts	Tx bytes	Dropped pkts	Dropped bytes
q0	(E) 12517376	0	0	0	0
q1	(E) 12517376	0	0	0	0
q2	(E) 12517376	1005800	1052066800	0	0
q3	(E) 12517376	0	0	0	0
q4	(E) 12517376	0	0	0	0
q5	(E) 12517376	0	0	0	0
q6	(E) 12517376	0	0	0	0
q7	(E) 12517376	0	0	0	0

```
VTEP5#sh qos-profile QUEUE_COS
profile name: QUEUE_COS
profile type: queue-color-to-cos
profile attached to 1 instances
configured mapping:
queue 2 color all cos 5
Detailed mapping:
```

INPUT			OUTPUT			INPUT			OUTPUT		
Queue	Color	COS	Queue	Color	COS	Queue	Color	COS	Queue	Color	COS
0	green	0	0	yellow	0	0	red	0			
1	green	1	1	yellow	1	1	red	1			
2	green	5	2	yellow	5	2	red	5			
3	green	3	3	yellow	3	3	red	3			
4	green	4	4	yellow	4	4	red	4			
5	green	5	5	yellow	5	5	red	5			
6	green	6	6	yellow	6	6	red	6			
7	green	7	7	yellow	7	7	red	7			

```
VTEP5#show qos-profile DSCP_QUEUE
profile name: DSCP_QUEUE
profile type: dscp-to-queue
profile attached to 1 instances
configured mapping:
dscp 56 queue 2
Detailed mapping:
```

INPUT OUTPUT				INPUT OUTPUT				INPUT OUTPUT				INPUT	
DSCP	Queue	Color	Out DSCP	DSCP	Queue	Color	Out DSCP	DSCP	Queue	Color	Out DSCP	DSCP	
0	0	green	0	16	2	green	16	32	4	green	32	48	6
green	48												
1	0	green	1	17	2	green	17	33	4	green	33	49	6
green	49												
2	0	green	2	18	2	green	18	34	4	green	34	50	6
green	50												
3	0	green	3	19	2	green	19	35	4	green	35	51	6
green	51												
4	0	green	4	20	2	yellow	20	36	4	yellow	36	52	6
green	52												
5	0	green	5	21	2	green	21	37	4	green	37	53	6
green	53												
6	0	green	6	22	2	yellow	22	38	4	yellow	38	54	6
green	54												
7	0	green	7	23	2	green	23	39	4	green	39	55	6
green	55												
8	1	green	8	24	3	green	24	40	5	green	40	56	2
green	56												
9	1	green	9	25	3	green	25	41	5	green	41	57	7
green	57												
10	1	green	10	26	3	green	26	42	5	green	42	58	7
green	58												
11	1	green	11	27	3	green	27	43	5	green	43	59	7
green	59												
12	1	yellow	12	28	3	yellow	28	44	5	green	44	60	7
green	60												
13	1	green	13	29	3	green	29	45	5	green	45	61	7
green	61												
14	1	yellow	14	30	3	yellow	30	46	5	green	46	62	7
green	62												
15	1	green	15	31	3	green	31	47	5	green	47	63	7
green	63												

Anycast Gateway

For today's large multi-tenant data center, centralized L3 gateway scheme is very inefficient and sometimes impractical. In order to overcome the drawback of centralized L3GW approach, anycast mode is used.

In Anycast gateway approach, all the VTEPs acts as default gateway for all the VNIDs. We will configure same anycast mac in all VTEPs.

IRB Configuration for Anycast

Configure from Base Configuration-L2 VxLAN section, then configure below commands for Anycast gateway approach.

Note: For L2 traffic, always dscp-to-queue qos profile at tunnel ingress takes effect.

Note: For L3 traffic in the local VTEP, routing is done at IRB level and also QoS applied at the IRB interface and it sends with l2vnid.

VTEP1

(config)#nvo vxlan irb	Enable VxLAN irb
(config)#ip vrf L3VRF1	Create mac routing/forwarding instance with L3VRF1 name and enter into vrf mode

(config-vrf)#rd 11000:11	Assign RD value
(config-vrf)# route-target both 100:100	Assign route-target value for same for import and export.
(config-vrf)# l3vni 1000	Configure L3VNI as 1000 for L3VRF1
(config-vrf)#exit	Exit from vrf mode
(config)# evpn irb-forwarding anycast-gateway-mac 0000.0000.1111	Configure anycast mac address
(config)# interface irb1001	Configure IRB interface 1001
(config-if)ip vrf forwarding L3VRF1	Configure L3VRF1
(config-if)ip address 11.11.11.1/24	Configure ip address
(config-if)ipv6 address 1111::1/64	Configure ipv6 address
(config-if) evpn irb-if-forwarding anycast-gateway-mac	Configure anycast mac address
(config-if)exit	Exit from interface config mode
(config)# interface irb2001	Configure IRB interface 2001
(config-if)ip vrf forwarding L3VRF1	Configure L3VRF1
(config-if)ip address 21.21.21.1/24	Configure ip address
(config-if)ipv6 address 2121::1/64	Configure ipv6 address
(config-if) evpn irb-if-forwarding anycast-gateway-mac	Configure anycast mac address
(config-if)exit	Exit from interface config mode
(config)# nvo vxlan id 101 ingress-replication inner-vid-disabled	Configure VxLAN Network identifier with/without inner-vid-disabled configure and enter into VxLAN tenant mode
(config-nvo)#vxlan host-reachability-protocol evpn-bgp L2VRF1	Assign vrf for evpn-bgp to carry EVPN route
(config-nvo)# evpn irb1001	Configure irb1001 under vxlan id 101
(config-nvo)#exit	Exit from VxLAN tenant mode and enter into configuration mode.
(config)#nvo vxlan id 201 ingress-replication inner-vid-disabled	Configure VxLAN Network identifier with/without inner-vid-disabled configure and enter into VxLAN tenant mode
(config-nvo)#vxlan host-reachability-protocol evpn-bgp L2VRF2	Assign vrf for evpn-bgp to carry EVPN route
(config-nvo)# evpn irb2001	Configure irb2001 under vxlan id 201
(config-nvo)#exit	Exit from VxLAN tenant mode and enter into configuration mode.
(config)#qos profile dscp-to-queue DSCP_QUEUE	Configure QoS profile to remark the traffic received from access-if
(config-ingress-dscp-map)#dscp 20 queue 4	Configure particular dscp value to queue value in the profile
(config-ingress-dscp-map)#exit	Exit from qos profile mode
(config)#qos profile dscp-encap DSCP_ENCAP	Configure the qos profile to map the overlay dscp value at tunnel egress
(config-egress-dscp-encap-map)#13 dscp 20 dscpEncap 34	Egress remarking of the customer dscp packet to overlay dscp
(config-egress-dscp-encap-map)#exit	Exit from the qos profile mode
(config)#int irb2001	Enter IRB L3 interface

(config-irb-if)#qos map-profile dscp-to-queue DSCP_QUEUE	Map the qos profile
(config-irb-if)#exit	Exit from interface mode
(config)#nvo vxlan tunnel qos-map-mode cos-dscp egress DSCP_ENCAP	Map the qos profile at vxlan tunnel egress
(config)#commit	Commit the candidate configuration to the running configuration
(config)#end	Exit from global config mode

VSTEP2

(config)#nvo vxlan irb	Enable VxLAN IRB
(config)#ip vrf L3VRF1	Create mac routing/forwarding instance with L3VRF1 name and enter into vrf mode
(config-vrf)#rd 21000:11	Assign RD value
(config-vrf)# route-target both 100:100	Assign route-target value for same for import and export.
(config-vrf)# l3vni 1000	Configure L3VNI as 1000 for L3VRF1
(config-vrf)#exit	Exit from vrf mode
(config)# evpn irb-forwarding anycast-gateway-mac 0000.0000.1111	Configure anycast mac address
(config)# interface irb1001	Configure IRB interface 1001
(config-if)ip vrf forwarding L3VRF1	Configure L3VRF1
(config-if)ip address 11.11.11.1/24	Configure ip address
(config-if)ipv6 address 1111::1/64	Configure ipv6 address
(config-if) evpn irb-if-forwarding anycast-gateway-mac	Configure anycast mac address
(config-if)exit	Exit from interface config mode
(config)# interface irb2001	Configure IRB interface 2001
(config-if)ip vrf forwarding L3VRF1	Configure L3VRF1
(config-if)ip address 21.21.21.1/24	Configure ip address
(config-if)ipv6 address 2121::1/64	Configure ipv6 address
(config-if) evpn irb-if-forwarding anycast-gateway-mac	Configure anycast mac address
(config-if)exit	Exit from interface config mode
(config)# nvo vxlan id 101 ingress-replication inner-vid-disabled	Configure VxLAN Network identifier with/without inner-vid-disabled configure and enter into VxLAN tenant mode
(config-nvo)#vxlan host-reachability-protocol evpn-bgp L2VRF1	Assign vrf for evpn-bgp to carry EVPN route
(config-nvo)# evpn irb1001	Configure irb1001 under vxlan id 101
(config-nvo)#exit	Exit from VxLAN tenant mode and enter into configuration mode.
(config)#nvo vxlan id 201 ingress-replication inner-vid-disabled	Configure VxLAN Network identifier with/without inner-vid-disabled configure and enter into VxLAN tenant mode
(config-nvo)#vxlan host-reachability-protocol evpn-bgp L2VRF2	Assign vrf for evpn-bgp to carry EVPN route
(config-nvo)# evpn irb2001	Configure irb2001 under vxlan id 201

(config-nvo)#exit	Exit from VxLAN tenant mode and enter into configuration mode.
(config)#qos profile dscp-to-queue DSCP_QUEUE	Configure QoS profile to remark the traffic at remote vtep at the ingress tunnel.
(config-ingress-dscp-map)#dscp 20 queue 4	Configure particular dscp value to queue value in the profile
(config-ingress-dscp-map)#exit	Exit from qos profile mode
(config)#qos profile dscp-encap DSCP_ENCAP	Configure the qos profile to map the overlay dscp value at tunnel egress
(config-egress-dscp-encap-map)#13 dscp 20 dscpEncap 34	Egress remarking of the customer dscp packet to overlay dscp
(config-egress-dscp-encap-map)#exit	Exit from the qos profile mode
(config)#int irb2001	Enter IRB L3 interface
(config-irb-if)#qos map-profile dscp-to-queue DSCP_QUEUE	Map the qos profile
(config-irb-if)#exit	Exit from interface mode
(config)#nvo vxlan tunnel qos-map-mode cos-dscp egress DSCP_ENCAP	Map the qos profile at vxlan tunnel egress
(config)#commit	Commit the candidate configuration to the running configuration
(config)#end	Exit from global config mode

VSTEP4

(config)#nvo vxlan irb	Enable VxLAN IRB
(config)#ip vrf L3VRF1	Create mac routing/forwarding instance with L3VRF1 name and enter into vrf mode
(config-vrf)#rd 41000:11	Assign RD value
(config-vrf)# route-target both 100:100	Assign route-target value for same for import and export.
(config-vrf)# l3vni 1000	Configure L3VNI as 1000 for L3VRF1
(config-vrf)#exit	Exit from vrf mode
(config)# evpn irb-forwarding anycast-gateway-mac 0000.0000.1111	Configure anycast mac address
(config)# interface irb1001	Configure IRB interface 1001
(config-if)ip vrf forwarding L3VRF1	Configure L3VRF1
(config-if)ip address 11.11.11.1/24	Configure ip address
(config-if)ipv6 address 1111::1/64	Configure ipv6 address
(config-if) evpn irb-if-forwarding anycast-gateway-mac	Configure anycast mac address
(config-if)exit	Exit from interface config mode
(config)# interface irb2001	Configure IRB interface 2001
(config-if)ip vrf forwarding L3VRF1	Configure L3VRF1
(config-if)ip address 21.21.21.1/24	Configure ip address
(config-if)ipv6 address 2121::1/64	Configure ipv6 address
(config-if) evpn irb-if-forwarding anycast-gateway-mac	Configure anycast mac address

(config-if)exit	Exit from interface config mode
(config)# nvo vxlan id 101 ingress-replication inner-vid-disabled	Configure VxLAN Network identifier with/without inner-vid-disabled configure and enter into VxLAN tenant mode
(config-nvo)#vxlan host-reachability-protocol evpn-bgp L2VRF1	Assign vrf for evpn-bgp to carry EVPN route
(config-nvo)# evpn irb1001	Configure irb1001 under vxlan id 101
(config-nvo)#exit	Exit from VxLAN tenant mode and enter into configuration mode.
(config)#nvo vxlan id 201 ingress-replication inner-vid-disabled	Configure VxLAN Network identifier with/without inner-vid-disabled configure and enter into VxLAN tenant mode
(config-nvo)#vxlan host-reachability-protocol evpn-bgp L2VRF2	Assign vrf for evpn-bgp to carry EVPN route
(config-nvo)# evpn irb2001	Configure irb2001 under vxlan id 201
(config-nvo)#commit	Commit the candidate configuration to the running configuration
(config-nvo)#exit	Exit from VxLAN tenant mode and enter into configuration mode.

VTEP5

(config)#nvo vxlan irb	Enable VxLAN IRB
(config)#ip vrf L3VRF1	Create mac routing/forwarding instance with L3VRF1 name and enter into vrf mode
(config-vrf)#rd 51000:11	Assign RD value
(config-vrf)# route-target both 100:100	Assign route-target value for same for import and export.
(config-vrf)# l3vni 1000	Configure L3VNI as 1000 for L3VRF1
(config-vrf)#exit	Exit from vrf mode
(config)# evpn irb-forwarding anycast-gateway-mac 0000.0000.1111	Configure anycast mac address
(config)# interface irb1001	Configure IRB interface 1001
(config-if)ip vrf forwarding L3VRF1	Configure L3VRF1
(config-if)ip address 11.11.11.1/24	Configure ip address
(config-if)ipv6 address 1111::1/64	Configure ipv6 address
(config-if) evpn irb-if-forwarding anycast-gateway-mac	Configure anycast mac address
(config-if)exit	Exit from interface config mode
(config)# interface irb2001	Configure IRB interface 2001
(config-if)ip vrf forwarding L3VRF1	Configure L3VRF1
(config-if)ip address 21.21.21.1/24	Configure ip address
(config-if)ipv6 address 2121::1/64	Configure ipv6 address
(config-if) evpn irb-if-forwarding anycast-gateway-mac	Configure anycast mac address
(config-if)exit	Exit from interface config mode
(config)# nvo vxlan id 101 ingress-replication inner-vid-disabled	Configure VxLAN Network identifier with/without inner-vid-disabled configure and enter into VxLAN tenant mode

(config-nvo)#vxlan host-reachability-protocol evpn-bgp L2VRF1	Assign vrf for evpn-bgp to carry EVPN route
(config-nvo)# evpn irb1001	Configure irb1001 under vxlan id 101
(config-nvo)#exit	Exit from VxLAN tenant mode and enter into configuration mode.
(config)#nvo vxlan id 201 ingress-replication inner-vid-disabled	Configure VxLAN Network identifier with/without inner-vid-disabled configure and enter into VxLAN tenant mode
(config-nvo)#vxlan host-reachability-protocol evpn-bgp L2VRF2	Assign vrf for evpn-bgp to carry EVPN route
(config-nvo)# evpn irb2001	Configure irb2001 under vxlan id 201
(config-nvo)#exit	Exit from VxLAN tenant mode and enter into configuration mode.
(config)#qos profile dscp-to-queue DSCP_QUEUE	Configure the qos profile to remark outer dscp to queue of the the ingress tunnel traffic. Here classification at the ingress vtep is based on overlay dscp value.
(config-ingress-dscp-map)#dscp 34 queue 2	Configure particular dscp value to queue value in the profile. Here dscp to <queue, dscp> is not applicable. I.e ingress remarking of dscp at the ingress tunnel is not applicable.
(config-ingress-dscp-map)#exit	Exit from qos profile mode
(config)#qos profile queue-color-to-cos QUEUE_COS	Configure qos profile to remark the queue value to COS value
(config-egress-cos-map)#queue 2 cos 6	Configure particular queue value to COS value
(config-egress-cos-map)#exit	Exit from qos profile config mode
(config)#nvo vxlan tunnel qos-map-mode cos-dscp ingress DSCP_QUEUE	Map the qos profile in tunnel ingress
(config)#nvo vxlan access-if port-vlan xe1 10	Enter to vxlan access port config mode
(config-nvo-acc-if)#map qos-profile queue-color-to-cos QUEUE_COS	Map the qos profile in vxlan access port
(config-nvo-acc-if)#commit	Commit the candidate configuration to the running configuration
(config-nvo-acc-if)#end	Exit from config mode

Validations

Send traffic from TS2-21 to MH2 access-if with dscp value 20 and COS value 1(vlan20) and verify traffic received at TS1-11 with dscp value 20 and COS value 6(vlan10) at the VTEP5 access-if.

VTEP1

```
VTEP1#show running-config qos
qos enable
!
qos profile dscp-to-queue DSCP_QUEUE
  dscp 20 queue 4
!
qos profile dscp-encap DSCP_ENCAP
  13 dscp 20 dscpEncap 34
!
!
```

```

!
!
interface irb2001
  qos map-profile dscp-to-queue DSCP_QUEUE
!
VTEP1#show running-config nvo vxlan
!
nvo vxlan enable
!
nvo vxlan irb
!
evpn vxlan multihoming enable
!
evpn irb-forwarding anycast-gateway-mac 0000.0000.1111
!
nvo vxlan vtep-ip-global 1.1.1.1
!
nvo vxlan tunnel qos-map-mode cos-dscp egress DSCP_ENCAP
!
nvo vxlan id 101 ingress-replication inner-vid-disabled
  vxlan host-reachability-protocol evpn-bgp L2VRF1
  evpn irb1001
  vni-name VNI-101
!
nvo vxlan id 201 ingress-replication inner-vid-disabled
  vxlan host-reachability-protocol evpn-bgp L2VRF2
  evpn irb2001
  vni-name VNI-201
!
nvo vxlan access-if port-vlan po1 10
  map vnid 101
  mac 0000.2222.1010 ip 11.11.11.51
!
nvo vxlan access-if port-vlan po1 20
  map vnid 201
  mac 0000.2222.1020 ip 21.21.21.51
!
!
VTEP1#show nvo vxlan tunnel
VxLAN Network tunnel Entries
Source          Destination      Status           Up/Down          Update
=====
1.1.1.1         5.5.5.5         Installed        01:15:13        01:15:13
1.1.1.1         4.4.4.4         Installed        01:15:28        01:15:28
1.1.1.1         2.2.2.2         Installed        01:11:40        01:11:40

Total number of entries are 3
VTEP1#show nvo vxlan
VxLAN Information
=====

```

Codes: NW - Network Port
 AC - Access Port
 (u) - Untagged

VNID	VNI-Name	VNI-Type	Type	Interface	ESI	VLAN	DF-Status
Src-Addr	Dst-Addr						
101	VNI-101	L2	NW	----	----	----	----
1.1.1.1	5.5.5.5						
101	VNI-101	L2	NW	----	----	----	----
1.1.1.1	4.4.4.4						
101	VNI-101	L2	NW	----	----	----	----
1.1.1.1	2.2.2.2						
101	VNI-101	--	AC	po1	00:00:00:00:00:22:22:00:00:00	10	DF
----	----						
201	VNI-201	L2	NW	----	----	----	----
1.1.1.1	5.5.5.5						
201	VNI-201	L2	NW	----	----	----	----
1.1.1.1	4.4.4.4						
201	VNI-201	L2	NW	----	----	----	----
1.1.1.1	2.2.2.2						
201	VNI-201	--	AC	po1	00:00:00:00:00:22:22:00:00:00	20	DF
----	----						

Total number of entries are 8

VTEP1#show nvo vxlan arp-cache

VxLAN ARP-CACHE Information

=====

VNID	Ip-Addr	Mac-Addr	Type	Age-Out	Retries-Left
201	21.21.21.51	0000.2222.1020	Static Local	----	
201	21.21.21.1	0000.0000.1111	Static Local	----	
201	21.21.21.101	0000.5555.1020	Static Remote	----	
101	11.11.11.51	0000.2222.1010	Static Local	----	
101	11.11.11.10	0010.9400.0002	Dynamic Remote	----	
101	11.11.11.1	0000.0000.1111	Static Local	----	
101	11.11.11.201	0000.4444.1010	Static Remote	----	

Total number of entries are 7

VTEP1#show nvo vxlan nd-cache

VxLAN ND-CACHE Information

=====

VNID	Ip-Addr	Mac-Addr	Type	Age-Out
201	2121::1	0000.0000.1111	Static Local	----
101	1111::10	0010.9400.0002	Dynamic Remote	----
101	1111::1	0000.0000.1111	Static Local	----

Total number of entries are 3

VTEP1#show ipv4 route vrf L3VRF1

Codes: K - kernel, C - connected, S - static, R - RIP, B - BGP

O - OSPF, IA - OSPF inter area

N1 - OSPF NSSA external type 1, N2 - OSPF NSSA external type 2
 E1 - OSPF external type 1, E2 - OSPF external type 2
 i - IS-IS, L1 - IS-IS level-1, L2 - IS-IS level-2,
 ia - IS-IS inter area, E - EVPN,
 v - vrf leaked
 * - candidate default

IP Route Table for VRF "L3VRF1"

```
C          11.11.11.0/24 is directly connected, irb1001, 00:13:19
C          21.21.21.0/24 is directly connected, irb2001, 00:12:56
C          127.0.0.0/8 is directly connected, lo.L3VRF1, 00:17:13
```

Gateway of last resort is not set

VTEP1#show ipv6 route vrf L3VRF1

IPv6 Routing Table

Codes: K - kernel route, C - connected, S - static, D- DHCP, R - RIP,
 O - OSPF, IA - OSPF inter area, E1 - OSPF external type 1,
 E2 - OSPF external type 2, E - EVPN N1 - OSPF NSSA external type 1,
 N2 - OSPF NSSA external type 2, i - IS-IS, B - BGP,
 v - vrf leaked

Timers: Uptime

IP Route Table for VRF "L3VRF1"

```
C          ::1/128 via ::, lo.L3VRF1, 00:17:23
C          1111::/64 via ::, irb1001, 00:13:29
C          2121::/64 via ::, irb2001, 00:13:06
C          fe80::/64 via ::, irb2001, 00:13:06
```

VTEP1#show interface ce52 counters queue-stats

E - Egress, I - Ingress, Q-Size is in bytes

Queue/Class-map	Q-Size	Tx pkts	Tx bytes	Dropped pkts	Dropped bytes
q0	(E) 125304832	0	0	0	0
q1	(E) 125304832	0	0	0	0
q2	(E) 125304832	0	0	0	0
q3	(E) 125304832	0	0	0	0
q4	(E) 125304832	0	0	0	0
q5	(E) 125304832	0	0	0	0
q6	(E) 125304832	0	0	0	0
q7	(E) 125304832	0	0	0	0

VTEP1#show nvo vxlan l3vni-map

L3VNI	L2VNI	IRB-interface
1000	101	irb1001
1000	201	irb2001

VTEP1#show qos-profile DSCP_QUEUE

profile name: DSCP_QUEUE
 profile type: dscp-to-queue
 profile attached to 1 instances
 configured mapping:
 dscp 20 queue 4
 Detailed mapping:

INPUT OUTPUT				INPUT OUTPUT				INPUT	
DSCP	Queue	Color	Out DSCP	DSCP	Queue	Color	Out DSCP	DSCP	
0	0	green	0	16	2	green	16	32	4
green	32		48	6	green	48			
1	0	green	1	17	2	green	17	33	4
green	33		49	6	green	49			
2	0	green	2	18	2	green	18	34	4
green	34		50	6	green	50			
3	0	green	3	19	2	green	19	35	4
green	35		51	6	green	51			
4	0	green	4	20	4	yellow	20	36	4
yellow	36		52	6	green	52			
5	0	green	5	21	2	green	21	37	4
green	37		53	6	green	53			
6	0	green	6	22	2	yellow	22	38	4
yellow	38		54	6	green	54			
7	0	green	7	23	2	green	23	39	4
green	39		55	6	green	55			
8	1	green	8	24	3	green	24	40	5
green	40		56	7	green	56			
9	1	green	9	25	3	green	25	41	5
green	41		57	7	green	57			
10	1	green	10	26	3	green	26	42	5
green	42		58	7	green	58			
11	1	green	11	27	3	green	27	43	5
green	43		59	7	green	59			
12	1	yellow	12	28	3	yellow	28	44	5
green	44		60	7	green	60			
13	1	green	13	29	3	green	29	45	5
green	45		61	7	green	61			
14	1	yellow	14	30	3	yellow	30	46	5
green	46		62	7	green	62			
15	1	green	15	31	3	green	31	47	5
green	47		63	7	green	63			

VTEP1#show qos-profile DSCP_ENCAP
 profile name: DSCP_ENCAP
 profile type: dscp-encap
 profile attached to 1 instances
 configured mapping:
 13 dscp 20 dscpEncap 34

Detailed mapping:

L3 DSCP to DSCP-ENCAP

INPUT		OUTPUT		INPUT		OUTPUT		INPUT		OUTPUT	
DSCP	DSCP	DSCP	DSCP	DSCP	DSCP	DSCP	DSCP	DSCP	DSCP	DSCP	
0	0	16	16	32	32	48	48				
1	1	17	17	33	33	49	49				
2	2	18	18	34	34	50	50				
3	3	19	19	35	35	51	51				
4	4	20	34	36	36	52	52				
5	5	21	21	37	37	53	53				
6	6	22	22	38	38	54	54				
7	7	23	23	39	39	55	55				
8	8	24	24	40	40	56	56				
9	9	25	25	41	41	57	57				
10	10	26	26	42	42	58	58				
11	11	27	27	43	43	59	59				
12	12	28	28	44	44	60	60				
13	13	29	29	45	45	61	61				
14	14	30	30	46	46	62	62				
15	15	31	31	47	47	63	63				

L2 Queue + Color to DSCP-ENCAP

INPUT			OUTPUT			INPUT			OUTPUT		
Queue	Color	DSCP	Queue	Color	DSCP	Queue	Color	DSCP	Queue	Color	DSCP
0	green	0	0	yellow	0	0	red	0			
1	green	8	1	yellow	8	1	red	8			
2	green	16	2	yellow	16	2	red	16			
3	green	24	3	yellow	24	3	red	24			
4	green	32	4	yellow	32	4	red	32			
5	green	40	5	yellow	40	5	red	40			
6	green	48	6	yellow	48	6	red	48			
7	green	56	7	yellow	56	7	red	56			

VTEP1#show qos-profile interface irb2001

profile name: DSCP_QUEUE

profile type: dscp-to-queue (Ingress)

mapping:

INPUT		OUTPUT		INPUT		OUTPUT		INPUT	
Queue	Color	Queue	Color	Queue	Color	Queue	Color	Queue	Color
DSCP	Queue	Color	Out DSCP	DSCP	Queue	Color	Out DSCP	DSCP	Queue
Queue	Color	Out DSCP	DSCP	Queue	Color	Out DSCP	DSCP	Queue	Color

0	0	green	0	6	16	2	green	16	32	4
green	32		48	6	green	48				
1	0	green	1	6	17	2	green	17	33	4
green	33		49	6	green	49				
2	0	green	2	6	18	2	green	18	34	4
green	34		50	6	green	50				
3	0	green	3	6	19	2	green	19	35	4
green	35		51	6	green	51				
4	0	green	4	6	20	4	yellow	20	36	4
yellow	36		52	6	green	52				
5	0	green	5	6	21	2	green	21	37	4
green	37		53	6	green	53				
6	0	green	6	6	22	2	yellow	22	38	4
yellow	38		54	6	green	54				
7	0	green	7	6	23	2	green	23	39	4
green	39		55	6	green	55				
8	1	green	8	7	24	3	green	24	40	5
green	40		56	7	green	56				
9	1	green	9	7	25	3	green	25	41	5
green	41		57	7	green	57				
10	1	green	10	7	26	3	green	26	42	5
green	42		58	7	green	58				
11	1	green	11	7	27	3	green	27	43	5
green	43		59	7	green	59				
12	1	yellow	12	7	28	3	yellow	28	44	5
green	44		60	7	green	60				
13	1	green	13	7	29	3	green	29	45	5
green	45		61	7	green	61				
14	1	yellow	14	7	30	3	yellow	30	46	5
green	46		62	7	green	62				
15	1	green	15	7	31	3	green	31	47	5
green	47		63	7	green	63				

profile name: default
 profile type: dscp-to-dscp (Egress)
 Status: Inactive
 mapping:

INPUT			OUTPUT			INPUT			OUTPUT		
DSCP	Color	Out DSCP	DSCP	Color	Out DSCP	DSCP	Color	Out DSCP	DSCP	Color	Out DSCP
0	green	0	0	yellow	0	0	red	0			
1	green	1	1	yellow	1	1	red	1			
2	green	2	2	yellow	2	2	red	2			
3	green	3	3	yellow	3	3	red	3			
4	green	4	4	yellow	4	4	red	4			
5	green	5	5	yellow	5	5	red	5			
6	green	6	6	yellow	6	6	red	6			
7	green	7	7	yellow	7	7	red	7			

8	green	8		8	yellow	8		8	red	8
9	green	9		9	yellow	9		9	red	9
10	green	10		10	yellow	12		10	red	14
11	green	11		11	yellow	11		11	red	11
12	green	12		12	yellow	12		12	red	14
13	green	13		13	yellow	13		13	red	13
14	green	14		14	yellow	14		14	red	14
15	green	15		15	yellow	15		15	red	15
16	green	16		16	yellow	16		16	red	16
17	green	17		17	yellow	17		17	red	17
18	green	18		18	yellow	20		18	red	22
19	green	19		19	yellow	19		19	red	19
20	green	20		20	yellow	20		20	red	22
21	green	21		21	yellow	21		21	red	21
22	green	22		22	yellow	22		22	red	22
23	green	23		23	yellow	23		23	red	23
24	green	24		24	yellow	24		24	red	24
25	green	25		25	yellow	25		25	red	25
26	green	26		26	yellow	28		26	red	30
27	green	27		27	yellow	27		27	red	27
28	green	28		28	yellow	28		28	red	30
29	green	29		29	yellow	29		29	red	29
30	green	30		30	yellow	30		30	red	30
31	green	31		31	yellow	31		31	red	31
32	green	32		32	yellow	32		32	red	32
33	green	33		33	yellow	33		33	red	33
34	green	34		34	yellow	36		34	red	38
35	green	35		35	yellow	35		35	red	35
36	green	36		36	yellow	36		36	red	38
37	green	37		37	yellow	37		37	red	37
38	green	38		38	yellow	38		38	red	38
39	green	39		39	yellow	39		39	red	39
40	green	40		40	yellow	40		40	red	40
41	green	41		41	yellow	41		41	red	41
42	green	42		42	yellow	42		42	red	42
43	green	43		43	yellow	43		43	red	43
44	green	44		44	yellow	44		44	red	44
45	green	45		45	yellow	45		45	red	45
46	green	46		46	yellow	46		46	red	46
47	green	47		47	yellow	47		47	red	47
48	green	48		48	yellow	48		48	red	48
49	green	49		49	yellow	49		49	red	49
50	green	50		50	yellow	50		50	red	50
51	green	51		51	yellow	51		51	red	51
52	green	52		52	yellow	52		52	red	52
53	green	53		53	yellow	53		53	red	53
54	green	54		54	yellow	54		54	red	54
55	green	55		55	yellow	55		55	red	55
56	green	56		56	yellow	56		56	red	56
57	green	57		57	yellow	57		57	red	57

58	green	58		58	yellow	58		58	red	58
59	green	59		59	yellow	59		59	red	59
60	green	60		60	yellow	60		60	red	60
61	green	61		61	yellow	61		61	red	61
62	green	62		62	yellow	62		62	red	62
63	green	63		63	yellow	63		63	red	63

VTEP2

VTEP2#show running-config qos

qos enable

!

qos profile dscp-to-queue DSCP_QUEUE

dscp 20 queue 4

!

qos profile dscp-encap DSCP_ENCAP

13 dscp 20 dscpEncap 34

!

!

!

!

interface irb2001

qos map-profile dscp-to-queue DSCP_QUEUE

!

VTEP2#show running-config nvo vxlan

!

nvo vxlan enable

!

nvo vxlan irb

!

evpn esi hold-time 90

!

evpn vxlan multihoming enable

!

evpn irb-forwarding anycast-gateway-mac 0000.0000.1111

!

nvo vxlan vtep-ip-global 2.2.2.2

!

nvo vxlan tunnel qos-map-mode cos-dscp egress DSCP_ENCAP

!

nvo vxlan id 101 ingress-replication inner-vid-disabled

vxlan host-reachability-protocol evpn-bgp L2VRF1

evpn irb1001

vni-name VNI-101

!

nvo vxlan id 201 ingress-replication inner-vid-disabled

vxlan host-reachability-protocol evpn-bgp L2VRF2

evpn irb2001

vni-name VNI-201

!

```

nvo vxlan access-if port-vlan po1 10
  map vnid 101
  mac 0000.2222.1010 ip 11.11.11.51
!
nvo vxlan access-if port-vlan po1 20
  map vnid 201
  mac 0000.2222.1020 ip 21.21.21.51
!
!

```

VTEP2#show nvo vxlan tunnel

VxLAN Network tunnel Entries

Source	Destination	Status	Up/Down	Update
2.2.2.2	4.4.4.4	Installed	01:13:43	01:13:43
2.2.2.2	1.1.1.1	Installed	01:13:43	01:13:43
2.2.2.2	5.5.5.5	Installed	01:13:43	01:13:43

Total number of entries are 3

VTEP2#show nvo vxlan

VxLAN Information

=====

Codes: NW - Network Port
AC - Access Port
(u) - Untagged

VNID	VNI-Name	VNI-Type	Type	Interface	ESI	VLAN	DF-Status
Src-Addr	Dst-Addr						
101	VNI-101	L2	NW	----	----	----	----
2.2.2.2		4.4.4.4					
101	VNI-101	L2	NW	----	----	----	----
2.2.2.2		1.1.1.1					
101	VNI-101	L2	NW	----	----	----	----
2.2.2.2		5.5.5.5					
101	VNI-101	--	AC	po1	00:00:00:00:00:22:22:00:00:00	10	NON-DF
----	----	----					
201	VNI-201	L2	NW	----	----	----	----
2.2.2.2		4.4.4.4					
201	VNI-201	L2	NW	----	----	----	----
2.2.2.2		1.1.1.1					
201	VNI-201	L2	NW	----	----	----	----
2.2.2.2		5.5.5.5					
201	VNI-201	--	AC	po1	00:00:00:00:00:22:22:00:00:00	20	NON-DF
----	----	----					

Total number of entries are 8

VTEP2#show nvo vxlan arp-cache

VxLAN ARP-CACHE Information

=====

VNID	Ip-Addr	Mac-Addr	Type	Age-Out	Retries-Left
201	21.21.21.51	0000.2222.1020	Static Local	----	

```

201      21.21.21.1      0000.0000.1111 Static Local  ----
201      21.21.21.101    0000.5555.1020 Static Remote ----
101      11.11.11.51     0000.2222.1010 Static Local  ----
101      11.11.11.10     0010.9400.0002 Dynamic Remote ----
101      11.11.11.1      0000.0000.1111 Static Local  ----
101      11.11.11.201    0000.4444.1010 Static Remote ----

```

Total number of entries are 7

VTEP2#show nvo vxlan nd-cache

VxLAN ND-CACHE Information

=====

VNID	Ip-Addr	Mac-Addr	Type	Age-Out
Retries-Left				

```

-----
201      2121::1          0000.0000.1111 Static Local  ----
101      1111::10         0010.9400.0002 Dynamic Remote ----
101      1111::1          0000.0000.1111 Static Local  ----

```

Total number of entries are 3

VTEP2#show ipv4 route vrf L3VRF1

Codes: K - kernel, C - connected, S - static, R - RIP, B - BGP

O - OSPF, IA - OSPF inter area

N1 - OSPF NSSA external type 1, N2 - OSPF NSSA external type 2

E1 - OSPF external type 1, E2 - OSPF external type 2

i - IS-IS, L1 - IS-IS level-1, L2 - IS-IS level-2,

ia - IS-IS inter area, E - EVPN,

v - vrf leaked

* - candidate default

IP Route Table for VRF "L3VRF1"

```

C          11.11.11.0/24 is directly connected, irb1001, 00:10:20
C          21.21.21.0/24 is directly connected, irb2001, 00:09:55
C          127.0.0.0/8  is directly connected, lo.L3VRF1, 00:13:30

```

Gateway of last resort is not set

VTEP2#show ipv6 route vrf L3VRF1

IPv6 Routing Table

Codes: K - kernel route, C - connected, S - static, D- DHCP, R - RIP,

O - OSPF, IA - OSPF inter area, E1 - OSPF external type 1,

E2 - OSPF external type 2, E - EVPN N1 - OSPF NSSA external type 1,

N2 - OSPF NSSA external type 2, i - IS-IS, B - BGP,

v - vrf leaked

Timers: Uptime

IP Route Table for VRF "L3VRF1"

```

C          ::1/128 via ::, lo.L3VRF1, 00:13:36
C          1111::/64 via ::, irb1001, 00:10:26
C          2121::/64 via ::, irb2001, 00:10:01
C          fe80::/64 via ::, irb2001, 00:10:01

```

VTEP2#show nvo vxlan l3vni-map

L3VNI	L2VNI	IRB-interface
=====		

=====

```
1000      101      irb1001
1000      201      irb2001
```

VTEP2#show interface xe29 counters queue-stats

E - Egress, I - Ingress, Q-Size is in bytes

Queue/Class-map	Q-Size	Tx pkts	Tx bytes	Dropped pkts
q0	(E) 12517376	0	0	0
q1	(E) 12517376	0	0	0
q2	(E) 12517376	0	0	0
q3	(E) 12517376	0	0	0
q4	(E) 12517376	2998022	2998045000	0
q5	(E) 12517376	0	0	0
q6	(E) 12517376	0	0	0
q7	(E) 12517376	0	0	0

VTEP2#show qos-profile DSCP_QUEUE

profile name: DSCP_QUEUE

profile type: dscp-to-queue

profile attached to 1 instances

configured mapping:

dscp 20 queue 4

Detailed mapping:

INPUT	OUTPUT	INPUT	OUTPUT	INPUT	OUTPUT
0	0	16	2	32	4
green	32	green	48		
1	0	17	2	33	4
green	33	green	49		
2	0	18	2	34	4
green	34	green	50		
3	0	19	2	35	4
green	35	green	51		
4	0	20	4	36	4
yellow	36	green	52		
5	0	21	2	37	4
green	37	green	53		
6	0	22	2	38	4
yellow	38	green	54		
7	0	23	2	39	4
green	39	green	55		

8	1	green	8	7		24	3	56	green	24		40	5
green	40		56	7		green	56						
9	1	green	9	7		25	3	57	green	25		41	5
green	41		57	7		green	57						
10	1	green	10	7		26	3	58	green	26		42	5
green	42		58	7		green	58						
11	1	green	11	7		27	3	59	green	27		43	5
green	43		59	7		green	59						
12	1	yellow	12	7		28	3	60	yellow	28		44	5
green	44		60	7		green	60						
13	1	green	13	7		29	3	61	green	29		45	5
green	45		61	7		green	61						
14	1	yellow	14	7		30	3	62	yellow	30		46	5
green	46		62	7		green	62						
15	1	green	15	7		31	3	63	green	31		47	5
green	47		63	7		green	63						

VTEP2#show qos-profile DSCP_ENCAP

profile name: DSCP_ENCAP

profile type: dscp-encap

profile attached to 1 instances

configured mapping:

l3 dscp 20 dscpEncap 34

Detailed mapping:

L3 DSCP to DSCP-ENCAP

INPUT		OUTPUT	INPUT		OUTPUT	INPUT		OUTPUT	INPUT		OUTPUT
DSCP	DSCP		DSCP	DSCP		DSCP	DSCP		DSCP	DSCP	
0	0		16	16		32	32		48	48	
1	1		17	17		33	33		49	49	
2	2		18	18		34	34		50	50	
3	3		19	19		35	35		51	51	
4	4		20	34		36	36		52	52	
5	5		21	21		37	37		53	53	
6	6		22	22		38	38		54	54	
7	7		23	23		39	39		55	55	
8	8		24	24		40	40		56	56	
9	9		25	25		41	41		57	57	
10	10		26	26		42	42		58	58	
11	11		27	27		43	43		59	59	
12	12		28	28		44	44		60	60	
13	13		29	29		45	45		61	61	
14	14		30	30		46	46		62	62	
15	15		31	31		47	47		63	63	

L2 Queue + Color to DSCP-ENCAP

INPUT			OUTPUT	INPUT			OUTPUT	INPUT			OUTPUT
Queue	Color	DSCP		Queue	Color	DSCP		Queue	Color	DSCP	

0	green	0		0	yellow	0		0	red	0
1	green	8		1	yellow	8		1	red	8
2	green	16		2	yellow	16		2	red	16
3	green	24		3	yellow	24		3	red	24
4	green	32		4	yellow	32		4	red	32
5	green	40		5	yellow	40		5	red	40
6	green	48		6	yellow	48		6	red	48
7	green	56		7	yellow	56		7	red	56

VTEP2#show qos-profile interface irb2001

profile name: DSCP_QUEUE

profile type: dscp-to-queue (Ingress)

mapping:

INPUT		OUTPUT		INPUT		OUTPUT		INPUT	
OUTPUT		INPUT		OUTPUT		OUTPUT		OUTPUT	
DSCP	Queue	Color	Out DSCP	DSCP	Queue	Color	Out DSCP	DSCP	Queue
Queue	Color	Out DSCP	DSCP	Queue	Color	Out DSCP	DSCP	Queue	Color
0	0	green	0	16	2	green	16	32	4
green	32	48	6	green	48				
1	0	green	1	17	2	green	17	33	4
green	33	49	6	green	49				
2	0	green	2	18	2	green	18	34	4
green	34	50	6	green	50				
3	0	green	3	19	2	green	19	35	4
green	35	51	6	green	51				
4	0	green	4	20	4	yellow	20	36	4
yellow	36	52	6	green	52				
5	0	green	5	21	2	green	21	37	4
green	37	53	6	green	53				
6	0	green	6	22	2	yellow	22	38	4
yellow	38	54	6	green	54				
7	0	green	7	23	2	green	23	39	4
green	39	55	6	green	55				
8	1	green	8	24	3	green	24	40	5
green	40	56	7	green	56				
9	1	green	9	25	3	green	25	41	5
green	41	57	7	green	57				
10	1	green	10	26	3	green	26	42	5
green	42	58	7	green	58				
11	1	green	11	27	3	green	27	43	5
green	43	59	7	green	59				
12	1	yellow	12	28	3	yellow	28	44	5
green	44	60	7	green	60				
13	1	green	13	29	3	green	29	45	5
green	45	61	7	green	61				
14	1	yellow	14	30	3	yellow	30	46	5
green	46	62	7	green	62				

```

15      1      green  15      | 31      3      green  31      | 47      5
green  47      | 63      7      | green  63      |

```

```

profile name: default
profile type: dscp-to-dscp (Egress)
Status: Inactive

```

mapping:

-----+-----			-----+-----			-----+-----					
INPUT			OUTPUT			INPUT			OUTPUT		
DSCP	Color	Out DSCP	DSCP	Color	Out DSCP	DSCP	Color	Out DSCP	DSCP	Color	Out DSCP
-----+-----			-----+-----			-----+-----			-----+-----		
0	green	0	0	yellow	0	0	red	0			
1	green	1	1	yellow	1	1	red	1			
2	green	2	2	yellow	2	2	red	2			
3	green	3	3	yellow	3	3	red	3			
4	green	4	4	yellow	4	4	red	4			
5	green	5	5	yellow	5	5	red	5			
6	green	6	6	yellow	6	6	red	6			
7	green	7	7	yellow	7	7	red	7			
8	green	8	8	yellow	8	8	red	8			
9	green	9	9	yellow	9	9	red	9			
10	green	10	10	yellow	12	10	red	14			
11	green	11	11	yellow	11	11	red	11			
12	green	12	12	yellow	12	12	red	14			
13	green	13	13	yellow	13	13	red	13			
14	green	14	14	yellow	14	14	red	14			
15	green	15	15	yellow	15	15	red	15			
16	green	16	16	yellow	16	16	red	16			
17	green	17	17	yellow	17	17	red	17			
18	green	18	18	yellow	20	18	red	22			
19	green	19	19	yellow	19	19	red	19			
20	green	20	20	yellow	20	20	red	22			
21	green	21	21	yellow	21	21	red	21			
22	green	22	22	yellow	22	22	red	22			
23	green	23	23	yellow	23	23	red	23			
24	green	24	24	yellow	24	24	red	24			
25	green	25	25	yellow	25	25	red	25			
26	green	26	26	yellow	28	26	red	30			
27	green	27	27	yellow	27	27	red	27			
28	green	28	28	yellow	28	28	red	30			
29	green	29	29	yellow	29	29	red	29			
30	green	30	30	yellow	30	30	red	30			
31	green	31	31	yellow	31	31	red	31			
32	green	32	32	yellow	32	32	red	32			
33	green	33	33	yellow	33	33	red	33			
34	green	34	34	yellow	36	34	red	38			
35	green	35	35	yellow	35	35	red	35			

36	green	36		36	yellow	36		36	red	38
37	green	37		37	yellow	37		37	red	37
38	green	38		38	yellow	38		38	red	38
39	green	39		39	yellow	39		39	red	39
40	green	40		40	yellow	40		40	red	40
41	green	41		41	yellow	41		41	red	41
42	green	42		42	yellow	42		42	red	42
43	green	43		43	yellow	43		43	red	43
44	green	44		44	yellow	44		44	red	44
45	green	45		45	yellow	45		45	red	45
46	green	46		46	yellow	46		46	red	46
47	green	47		47	yellow	47		47	red	47
48	green	48		48	yellow	48		48	red	48
49	green	49		49	yellow	49		49	red	49
50	green	50		50	yellow	50		50	red	50
51	green	51		51	yellow	51		51	red	51
52	green	52		52	yellow	52		52	red	52
53	green	53		53	yellow	53		53	red	53
54	green	54		54	yellow	54		54	red	54
55	green	55		55	yellow	55		55	red	55
56	green	56		56	yellow	56		56	red	56
57	green	57		57	yellow	57		57	red	57
58	green	58		58	yellow	58		58	red	58
59	green	59		59	yellow	59		59	red	59
60	green	60		60	yellow	60		60	red	60
61	green	61		61	yellow	61		61	red	61
62	green	62		62	yellow	62		62	red	62
63	green	63		63	yellow	63		63	red	63

VTEP4

```
VTEP4#show nvo vxlan tunnel
```

```
VxLAN Network tunnel Entries
```

Source	Destination	Status	Up/Down	Update
4.4.4.4	2.2.2.2	Installed	01:14:47	01:14:47
4.4.4.4	1.1.1.1	Installed	01:18:35	01:18:35
4.4.4.4	5.5.5.5	Installed	01:18:20	01:18:20

```
Total number of entries are 3
```

```
VTEP4#show nvo vxlan
```

```
VxLAN Information
```

```
=====
```

```
Codes: NW - Network Port
```

```
AC - Access Port
```

```
(u) - Untagged
```

```
VNID      VNI-Name      VNI-Type Type Interface ESI      VLAN DF-Status
Src-Addr      Dst-Addr
```

101	VNI-101	L2	NW	----	----	----	----
4.4.4.4		2.2.2.2					
101	VNI-101	L2	NW	----	----	----	----
4.4.4.4		1.1.1.1					
101	VNI-101	L2	NW	----	----	----	----
4.4.4.4		5.5.5.5					
201	VNI-201	L2	NW	----	----	----	----
4.4.4.4		2.2.2.2					
201	VNI-201	L2	NW	----	----	----	----
4.4.4.4		1.1.1.1					
201	VNI-201	L2	NW	----	----	----	----
4.4.4.4		5.5.5.5					
201	VNI-201	--	AC	xe3	---	Single Homed Port	---
----		----				20	----

Total number of entries are 7

VTEP4#show nvo vxlan arp-cache

VxLAN ARP-CACHE Information

=====

VNID	Ip-Addr	Mac-Addr	Type	Age-Out	Retries-Left
201	21.21.21.51	0000.2222.1020	Static Remote	----	
201	21.21.21.1	0000.0000.1111	Static Local	----	
201	21.21.21.101	0000.5555.1020	Static Local	----	
101	11.11.11.51	0000.2222.1010	Static Remote	----	
101	11.11.11.10	0010.9400.0002	Dynamic Remote	----	
101	11.11.11.1	0000.0000.1111	Static Local	----	
101	11.11.11.201	0000.4444.1010	Static Remote	----	

Total number of entries are 7

VTEP4#show nvo vxlan nd-cache

VxLAN ND-CACHE Information

=====

VNID	Ip-Addr	Mac-Addr	Type	Age-Out	Retries-Left
201	2121::1	0000.0000.1111	Static Local	----	
101	1111::10	0010.9400.0002	Dynamic Remote	----	
101	1111::1	0000.0000.1111	Static Local	----	

Total number of entries are 3

VTEP4#show ipv4 route vrf L3VRF1

Codes: K - kernel, C - connected, S - static, R - RIP, B - BGP

O - OSPF, IA - OSPF inter area

N1 - OSPF NSSA external type 1, N2 - OSPF NSSA external type 2

E1 - OSPF external type 1, E2 - OSPF external type 2

i - IS-IS, L1 - IS-IS level-1, L2 - IS-IS level-2,

ia - IS-IS inter area, E - EVPN,

v - vrf leaked

* - candidate default

IP Route Table for VRF "L3VRF1"

```
C          11.11.11.0/24 is directly connected, irb1001, 00:07:24
C          21.21.21.0/24 is directly connected, irb2001, 00:07:14
C          127.0.0.0/8 is directly connected, lo.L3VRF1, 00:10:16
```

Gateway of last resort is not set

```
VTEP4#show ipv6 route vrf L3VRF1
```

IPv6 Routing Table

```
Codes: K - kernel route, C - connected, S - static, D- DHCP, R - RIP,
       O - OSPF, IA - OSPF inter area, E1 - OSPF external type 1,
       E2 - OSPF external type 2, E - EVPN  N1 - OSPF NSSA external type 1,
       N2 - OSPF NSSA external type 2, i - IS-IS, B - BGP,
       v - vrf leaked
```

Timers: Uptime

IP Route Table for VRF "L3VRF1"

```
C          ::1/128 via ::, lo.L3VRF1, 00:10:21
C          1111::/64 via ::, irb1001, 00:07:29
C          2121::/64 via ::, irb2001, 00:07:19
C          fe80::/64 via ::, irb2001, 00:07:19
```

```
VTEP4#show nvo vxlan l3vni-map
```

L3VNI	L2VNI	IRB-interface
1000	101	irb1001
1000	201	irb2001

VTEP5

```
VTEP5#show running-config qos
```

```
qos enable
```

```
!
```

```
qos profile queue-color-to-cos QUEUE_COS
```

```
  queue 2 color all cos 6
```

```
!
```

```
qos profile dscp-to-queue DSCP_QUEUE
```

```
  dscp 34 queue 2
```

```
!
```

```
!
```

```
!
```

```
VTEP5#show running-config nvo vxlan
```

```
!
```

```
nvo vxlan enable
```

```
!
```

```
nvo vxlan irb
```

```
!
```

```
evpn vxlan multihoming enable
```

```
!
```

```
evpn irb-forwarding anycast-gateway-mac 0000.0000.1111
```

```
!
```

```
nvo vxlan vtep-ip-global 5.5.5.5
```

```
!
```

```
nvo vxlan tunnel qos-map-mode cos-dscp ingress DSCP_QUEUE
!
nvo vxlan id 101 ingress-replication inner-vid-disabled
  vxlan host-reachability-protocol evpn-bgp L2VRF1
  evpn irb1001
  vni-name VNI-101
!
nvo vxlan id 201 ingress-replication inner-vid-disabled
  vxlan host-reachability-protocol evpn-bgp L2VRF2
  evpn irb2001
  vni-name VNI-201
!
nvo vxlan access-if port-vlan xe1 10
  map vnid 101
  mac 0000.4444.1010 ip 11.11.11.201
  map qos-profile queue-color-to-cos QUEUE_COS
!
!
```

VTEP5#show nvo vxlan tunnel

VxLAN Network tunnel Entries

Source	Destination	Status	Up/Down	Update
5.5.5.5	2.2.2.2	Installed	01:11:17	01:11:17
5.5.5.5	4.4.4.4	Installed	01:14:50	01:14:50
5.5.5.5	1.1.1.1	Installed	01:14:50	01:14:50

Total number of entries are 3

VTEP5#sh nvo vxlan

VxLAN Information

=====

Codes: NW - Network Port
 AC - Access Port
 (u) - Untagged

VNID Src-Addr	VNI-Name Dst-Addr	VNI-Type	Type	Interface	ESI	VLAN	DF-Status
101 5.5.5.5	VNI-101 2.2.2.2	L2	NW	----	----	----	----
101 5.5.5.5	VNI-101 4.4.4.4	L2	NW	----	----	----	----
101 5.5.5.5	VNI-101 1.1.1.1	L2	NW	----	----	----	----
101 ----	VNI-101 ----	--	AC	xe1	---	Single Homed Port	--- 10 ----
201 5.5.5.5	VNI-201 2.2.2.2	L2	NW	----	----	----	----
201 5.5.5.5	VNI-201 4.4.4.4	L2	NW	----	----	----	----
201 5.5.5.5	VNI-201 1.1.1.1	L2	NW	----	----	----	----

Total number of entries are 7
VTEP5#show nvo vxlan arp-cache
VxLAN ARP-CACHE Information

```
=====
```

VNID	Ip-Addr	Mac-Addr	Type	Age-Out	Retries-Left
201	21.21.21.51	0000.2222.1020	Static Remote	----	
201	21.21.21.1	0000.0000.1111	Static Local	----	
201	21.21.21.101	0000.5555.1020	Static Remote	----	
101	11.11.11.51	0000.2222.1010	Static Remote	----	
101	11.11.11.10	0010.9400.0002	Dynamic Local	----	
101	11.11.11.1	0000.0000.1111	Static Local	----	
101	11.11.11.201	0000.4444.1010	Static Local	----	

Total number of entries are 7
VTEP5#show nvo vxlan nd-cache
VxLAN ND-CACHE Information

```
=====
```

VNID	Ip-Addr	Mac-Addr	Type	Age-Out	Retries-Left
201	2121::1	0000.0000.1111	Static Local	----	
101	1111::10	0010.9400.0002	Dynamic Local	----	
101	1111::1	0000.0000.1111	Static Local	----	

Total number of entries are 3

VTEP5#show ipv4 route vrf L3VRF1

Codes: K - kernel, C - connected, S - static, R - RIP, B - BGP
O - OSPF, IA - OSPF inter area
N1 - OSPF NSSA external type 1, N2 - OSPF NSSA external type 2
E1 - OSPF external type 1, E2 - OSPF external type 2
i - IS-IS, L1 - IS-IS level-1, L2 - IS-IS level-2,
ia - IS-IS inter area, E - EVPN,
v - vrf leaked
* - candidate default

IP Route Table for VRF "L3VRF1"

```
C          11.11.11.0/24 is directly connected, irb1001, 00:05:08
C          21.21.21.0/24 is directly connected, irb2001, 00:04:57
C          127.0.0.0/8 is directly connected, lo.L3VRF1, 00:07:30
```

Gateway of last resort is not set

VTEP5#show ipv6 route vrf L3VRF1

IPv6 Routing Table

Codes: K - kernel route, C - connected, S - static, D- DHCP, R - RIP,
O - OSPF, IA - OSPF inter area, E1 - OSPF external type 1,
E2 - OSPF external type 2, E - EVPN N1 - OSPF NSSA external type 1,
N2 - OSPF NSSA external type 2, i - IS-IS, B - BGP,
v - vrf leaked

Timers: Uptime

```
IP Route Table for VRF "L3VRF1"
C      ::1/128 via ::, lo.L3VRF1, 00:07:35
C      1111::/24 via ::, irb1001, 00:05:13
C      2121::/64 via ::, irb2001, 00:05:02
C      fe80::/64 via ::, irb2001, 00:05:02
```

```
VTEP5#show nvo vxlan l3vni-map
L3VNI      L2VNI      IRB-interface
=====
1000      101      irb1001
1000      201      irb2001
```

```
VTEP5#show interface xel counters queue-stats
```

E - Egress, I - Ingress, Q-Size is in bytes

```
+-----+-----+-----+-----+-----+
+-----+
| Queue/Class-map | Q-Size | Tx pkts | Tx bytes | Dropped pkts |
Dropped bytes |
+-----+-----+-----+-----+-----+
+-----+
q0      (E) 12517376 0      0      0      0
q1      (E) 12517376 0      0      0      0
q2      (E) 12517376 1170696 1224549062 0      0
q3      (E) 12517376 0      0      0      0
q4      (E) 12517376 0      0      0      0
q5      (E) 12517376 0      0      0      0
q6      (E) 12517376 0      0      0      0
q7      (E) 12517376 0      0      0      0
```

```
VTEP5#show qos-profile QUEUE_COS
```

```
profile name: QUEUE_COS
profile type: queue-color-to-cos
profile attached to 1 instances
configured mapping:
queue 2 color all cos 6
Detailed mapping:
```

INPUT			OUTPUT			INPUT			OUTPUT		
Queue	Color	COS	Queue	Color	COS	Queue	Color	COS	Queue	Color	COS
0	green	0	0	yellow	0	0	red	0	0	red	0
1	green	1	1	yellow	1	1	red	1	1	red	1
2	green	6	2	yellow	6	2	red	6	2	red	6
3	green	3	3	yellow	3	3	red	3	3	red	3
4	green	4	4	yellow	4	4	red	4	4	red	4
5	green	5	5	yellow	5	5	red	5	5	red	5
6	green	6	6	yellow	6	6	red	6	6	red	6
7	green	7	7	yellow	7	7	red	7	7	red	7

```
VTEP5#show qos-profile DSCP_QUEUE
```

```
profile name: DSCP_QUEUE
```

```

profile type: dscp-to-queue
profile attached to 1 instances
configured mapping:
  dscp 34 queue 2
Detailed mapping:

```

INPUT OUTPUT				INPUT OUTPUT				INPUT OUTPUT			
DSCP	Queue	Color	Out DSCP	DSCP	Queue	Color	Out DSCP	DSCP	Queue	Color	Out DSCP
0	0	green	0	16	2	green	16	32	4		
green	32		48	6	green	48					
1	0	green	1	17	2	green	17	33	4		
green	33		49	6	green	49					
2	0	green	2	18	2	green	18	34	2		
green	34		50	6	green	50					
3	0	green	3	19	2	green	19	35	4		
green	35		51	6	green	51					
4	0	green	4	20	2	yellow	20	36	4		
yellow	36		52	6	green	52					
5	0	green	5	21	2	green	21	37	4		
green	37		53	6	green	53					
6	0	green	6	22	2	yellow	22	38	4		
yellow	38		54	6	green	54					
7	0	green	7	23	2	green	23	39	4		
green	39		55	6	green	55					
8	1	green	8	24	3	green	24	40	5		
green	40		56	7	green	56					
9	1	green	9	25	3	green	25	41	5		
green	41		57	7	green	57					
10	1	green	10	26	3	green	26	42	5		
green	42		58	7	green	58					
11	1	green	11	27	3	green	27	43	5		
green	43		59	7	green	59					
12	1	yellow	12	28	3	yellow	28	44	5		
green	44		60	7	green	60					
13	1	green	13	29	3	green	29	45	5		
green	45		61	7	green	61					
14	1	yellow	14	30	3	yellow	30	46	5		
green	46		62	7	green	62					
15	1	green	15	31	3	green	31	47	5		
green	47		63	7	green	63					

Distributed Gateway

In distributed gateway approach, VTEP will act as default gateways for one or more VNIDs, Each VTEP having its own default gateway IP and MAC configuration for a given VNID.

IRB QoS Configuration for Distributed

Configure from Base Configuration-L2 VxLAN section, then configure below commands for centralized distributed approach.

Note: For L3 traffic, when l3vni is sent in the traffic, then dscp-to-queue qos profile mapped at tunnel ingress takes effect.

VTEP4

Unconfigure vniid 101 from nvo vxlan.

(config)#nvo vxlan irb	Enable VxLAN irb
(config)#ip vrf L3VRF1	Create mac routing/forwarding instance with L3VRF1 name and enter into vrf mode
(config-vrf)#rd 41000:11	Assign RD value
(config-vrf)# route-target both 100:100	Assign route-target value for same for import and export.
(config-vrf)# l3vni 1000	Configure L3VNI as 1000 for L3VRF1
(config-vrf)#exit	Exit from vrf mode
(config)# interface irb2001	Configure IRB interface 2001
(config-if)ip vrf forwarding L3VRF1	Configure L3VRF1
(config-if)ip address 21.21.21.1/24	Configure ip address
(config-if)ipv6 address 2121::1/64	Configure ipv6 address
(config-if)exit	Exit from interface config mode
(config)router bgp 5000	Enter into bgp router mode
(config-router)#address-family ipv4 vrf L3VRF1	Enter into address-family mode for L3VRF1
(config-router-af)#redistribute connected	Redistribute connected
(config-router-af)#exit-address-family	Exit form address-family
(config-router)#address-family ipv6 vrf L3VRF1	Enter into address-family mode for L3VRF1
(config-router-af)#redistribute connected	Redistribute connected
(config-router-af)#exit-address-family	Exit form address-family
(config)#nvo vxlan id 201 ingress-replication inner-vid-disabled	Configure VxLAN Network identifier with/without inner-vid-disabled configure and enter into VxLAN tenant mode
(config-nvo)#vxlan host-reachability-protocol evpn-bgp L2VRF2	Assign vrf for evpn-bgp to carry EVPN route
(config-nvo)# evpn irb2001	Configure irb2001 under vxlan id 201
(config-nvo)#exit	Exit from VxLAN tenant mode and enter into configuration mode.
(config)#qos remark dscp	Enable qos dscp remark for dscp-to-dscp mapping if required
(config)#qos profile dscp-to-queue DSCP_QUEUE	Configure qos profile to remark at vxlan ingress tunnel. Here dscp to <queue, dscp> is not applicable. I.e ingress remarking of dscp at the ingress tunnel is not applicable.

(config-ingress-dscp-map)#dscp 56 queue 6	Configure particular outer dscp value to queue value. Here classification at the ingress vtep is based on overlay dscp value
(config-ingress-dscp-map)#exit	Exit from qos profile config mode
(config)#qos profile dscp-to-dscp DSCP_DSCP	Configure qos profile for dscp value remark if required. Here classification at the egress vtep is based on customer dscp value
(config-egress-dscp-map)#dscp 20 dscp 32	Configure particular dscp value to dscp value
(config-egress-dscp-map)#exit	Exit from qos profile config mode
(config)#qos profile queue-color-to-cos QUEUE_COS	Configure qos profile for remark at vxlan access-if
(config-egress-cos-map)#queue 6 cos 2	Configure particular queue value to COS value
(config-egress-cos-map)#exit	Exit from qos profile config mode
(config)#nvo vxlan tunnel qos-map-mode cos-dscp ingress DSCP_QUEUE	Map the qos profile to vxlan tunnel ingress
(config)#int irb2001	Enter IRB interface mode
(config-irb-if)#qos map-profile dscp-to-dscp DSCP_DSCP	Map Qos profile for dscp remark if required
(config-irb-if)#exit	Exit from interface mode
(config)#nvo vxlan access-if port-vlan xe3 20	Enter vxlan access-if mode
(config-nvo-acc-if)#map qos-profile queue-color-to-cos QUEUE_COS	Map qos profile
(config-nvo-acc-if)#commit	Commit the candidate configuration to the running configuration
(config-nvo-acc-if)#end	Exit from global configuration mode

VTEP5

Unconfigure vnid 201 from nvo vxlan.

(config)#nvo vxlan irb	Enable VxLAN IRB
(config)#ip vrf L3VRF1	Create mac routing/forwarding instance with L3VRF1 name and enter into vrf mode
(config-vrf)#rd 51000:11	Assign RD value
(config-vrf)# route-target both 100:100	Assign route-target value for same for import and export.
(config-vrf)# l3vni 1000	Configure L3VNI as 1000 for L3VRF1
(config-vrf)#exit	Exit from vrf mode
(config)# interface irb1001	Configure IRB interface 1001
(config-if)ip vrf forwarding L3VRF1	Configure L3VRF1
(config-if)ip address 11.11.11.1/24	Configure ip address
(config-if)ipv6 address 1111::1/64	Configure ipv6 address
(config-if)exit	Exit from interface config mode
(config)router bgp 5000	Enter into bgp router mode
(config-router)#address-family ipv4 vrf L3VRF1	Enter into address-family mode for L3VRF1

(config-router-af)#redistribute connected	Redistribute connected
(config-router-af)#exit-address-family	Exit form address-family
(config-router)#address-family ipv6 vrf L3VRF1	Enter into address-family mode for L3VRF1
(config-router-af)#redistribute connected	Redistribute connected
(config-router-af)#exit-address-family	Exit form address-family
(config)# nvo vxlan id 101 ingress-replication inner-vid-disabled	Configure VxLAN Network identifier with/without inner-vid-disabled configure and enter into VxLAN tenant mode
(config-nvo)#vxlan host-reachability-protocol evpn-bgp L2VRF1	Assign vrf for evpn-bgp to carry EVPN route
(config-nvo)# evpn irb1001	Configure irb1001 under vxlan id 101
(config-nvo)#exit	Exit from VxLAN tenant mode and enter into configuration mode.
(config)#qos profile dscp-to-queue DSCP_QUEUE	Configure qos profile for dscp to queue for ingress traffic
(config-ingress-dscp-map)# dscp 20 queue 4	Configure particular dscp value to queue value
(config-ingress-dscp-map)#qos profile dscp-encap DSCP_ENCAP	Configure qos profile for overlay dscp remark in vxlan tunnel egress
(config-egress-dscp-encap-map)# 13 dscp 20 dscpEncap 56	Egress remarking of the customer dscp packet to overlay dscp
(config-egress-dscp-encap-map)#exit	Exit from qos profile config mode
(config)#nvo vxlan tunnel qos-map-mode cos-dscp egress DSCP_ENCAP	Map the qos profile in vxlan tunnel egress
(config)#interface irb1001	Enter IRB L3 interface
(config-irb-if)#qos map-profile dscp-to-queue DSCP_QUEUE	Map qos profile
(config-irb-if)#commit	Commit the candidate configuration to the running configuration
(config-irb-if)#end	Exit from global conf mode

Validations

Send traffic from TS1-11 to VTEP5 access-if with dscp value 20 COS value 1(vlan10) and verify traffic received at TS2-21 with dscp value 32 and COS value 2(vlan20) at the VTEP4 access-if.

VTEP5

```
VTEP5#show running-config qos
qos enable
!
qos profile dscp-to-queue DSCP_QUEUE
  dscp 20 queue 4
!
qos profile dscp-encap DSCP_ENCAP
  13 dscp 20 dscpEncap 56
!
!
```

```

!
!
interface irb1001
  qos map-profile dscp-to-queue DSCP_QUEUE
!
VTEP5#show run nvo vxlan
!
nvo vxlan enable
!
nvo vxlan irb
!
evpn vxlan multihoming enable
!
nvo vxlan vtep-ip-global 5.5.5.5
!
nvo vxlan tunnel qos-map-mode cos-dscp egress DSCP_ENCAP
!
nvo vxlan id 101 ingress-replication inner-vid-disabled
  vxlan host-reachability-protocol evpn-bgp L2VRF1
  evpn irb1001
  vni-name VNI-101
!
nvo vxlan id 201 ingress-replication inner-vid-disabled
  vxlan host-reachability-protocol evpn-bgp L2VRF2
  vni-name VNI-201
!
nvo vxlan access-if port-vlan xe1 10
  map vnid 101
  mac 0000.4444.1010 ip 11.11.11.201
!
!

```

```
VTEP5#show nvo vxlan tunnel
```

```
VxLAN Network tunnel Entries
```

Source	Destination	Status	Up/Down	Update
5.5.5.5	2.2.2.2	Installed	00:29:54	00:29:54
5.5.5.5	4.4.4.4	Installed	00:29:54	00:29:54
5.5.5.5	1.1.1.1	Installed	00:29:54	00:29:54

```
Total number of entries are 3
```

```
VTEP5#show nvo vxlan
```

```
VxLAN Information
```

```
=====
```

```

Codes: NW - Network Port
       AC - Access Port
       (u) - Untagged

```

VNID	VNI-Name	VNI-Type	Type	Interface	ESI	VLAN	DF-Status
Src-Addr	Dst-Addr						

101	VNI-101	L2	NW	----	----	----	----
5.5.5.5		2.2.2.2					
101	VNI-101	L2	NW	----	----	----	----
5.5.5.5		4.4.4.4					
101	VNI-101	L2	NW	----	----	----	----
5.5.5.5		1.1.1.1					
101	VNI-101	--	AC	xe1	---	Single Homed Port	---
----	----	----				10	----
201	VNI-201	L2	NW	----	----	----	----
5.5.5.5		2.2.2.2					
201	VNI-201	L2	NW	----	----	----	----
5.5.5.5		4.4.4.4					
201	VNI-201	L2	NW	----	----	----	----
5.5.5.5		1.1.1.1					
1000	----	L3	NW	----	----	----	----
5.5.5.5		4.4.4.4					

Total number of entries are 8

VTEP5#show nvo vxlan arp-cache

VxLAN ARP-CACHE Information

=====

VNID	Ip-Addr	Mac-Addr	Type	Age-Out	Retries-Left
201	21.21.21.51	0000.2222.1020	Static Remote	----	
201	21.21.21.1	3c2c.991a.da7a	Static Remote	----	
201	21.21.21.101	0000.5555.1020	Static Remote	----	
101	11.11.11.51	0000.2222.1010	Static Remote	----	
101	11.11.11.1	04f8.f82f.8eee	Static Local	----	
101	11.11.11.201	0000.4444.1010	Static Local	----	

Total number of entries are 6

VTEP5#show nvo vxlan nd-cache

VxLAN ND-CACHE Information

=====

VNID	Ip-Addr	Mac-Addr	Type	Age-Out
201	2121::1	3c2c.991a.da7a	Static Remote	----
101	1111::1	04f8.f82f.8eee	Static Local	----

Total number of entries are 2

VTEP5#show nvo vxlan l3vni-map

L3VNI L2VNI IRB-interface

=====

1000	101	irb1001
------	-----	---------

VTEP5#show ipv4 route vrf L3VRF1

Codes: K - kernel, C - connected, S - static, R - RIP, B - BGP

O - OSPF, IA - OSPF inter area

N1 - OSPF NSSA external type 1, N2 - OSPF NSSA external type 2

E1 - OSPF external type 1, E2 - OSPF external type 2

i - IS-IS, L1 - IS-IS level-1, L2 - IS-IS level-2,

ia - IS-IS inter area, E - EVPN,

v - vrf leaked

* - candidate default

IP Route Table for VRF "L3VRF1"

```
B          4.4.4.4/32 [0/0] is directly connected, tunvxlan1000, 00:04:09
C          11.11.11.0/24 is directly connected, irb1001, 00:02:38
B          21.21.21.0/24 [200/0] via 4.4.4.4 (recursive is directly connected,
tunvxlan1000), 00:04:09
C          127.0.0.0/8 is directly connected, lo.L3VRF1, 00:04:46
```

Gateway of last resort is not set

VTEP5#show ipv6 route vrf L3VRF1

IPv6 Routing Table

Codes: K - kernel route, C - connected, S - static, D- DHCP, R - RIP,
O - OSPF, IA - OSPF inter area, E1 - OSPF external type 1,
E2 - OSPF external type 2, E - EVPN N1 - OSPF NSSA external type 1,
N2 - OSPF NSSA external type 2, i - IS-IS, B - BGP,
v - vrf leaked

Timers: Uptime

IP Route Table for VRF "L3VRF1"

```
C          ::1/128 via ::, lo.L3VRF1, 00:04:50
B          ::ffff:404:404/128 [0/0] via ::, tunvxlan1000, 00:04:13
C          1111::/64 via ::, irb1001, 00:02:42
B          2121::/64 [200/0] via ::ffff:404:404 (recursive via ::, unknown), 00:04:13
C          fe80::/64 via ::, irb1001, 00:02:42
```

VTEP5#show interface ce53 counter queue-stats

E - Egress, I - Ingress, Q-Size is in bytes

Queue/Class-map	Q-Size	Tx pkts	Tx bytes	Dropped pkts	Dropped bytes
q0	(E) 50069504	0	0	0	0
q1	(E) 50069504	0	0	0	0
q2	(E) 50069504	0	0	0	0
q3	(E) 50069504	0	0	0	0
q4	(E) 50069504	498796	698314400	0	0
q5	(E) 50069504	0	0	0	0
q6	(E) 50069504	0	0	0	0
q7	(E) 50069504	0	0	0	0

VTEP5#show qos-profile DSCP_QUEUE

```
profile name: DSCP_QUEUE
profile type: dscp-to-queue
profile attached to 1 instances
configured mapping:
  dscp 20 queue 4
Detailed mapping:
```

DSCP	Queue
20	4

INPUT OUTPUT				OUTPUT INPUT				INPUT OUTPUT			
DSCP	Queue	Color	Out DSCP	DSCP	Queue	Color	Out DSCP	DSCP	Queue	Color	Out DSCP
0	0	green	0	16	2	green	16	32	4		
green	32	48	6	green	2	48					
1	0	green	1	17	2	green	17	33	4		
green	33	49	6	green	2	49					
2	0	green	2	18	2	green	18	34	4		
green	34	50	6	green	2	50					
3	0	green	3	19	2	green	19	35	4		
green	35	51	6	green	2	51					
4	0	green	4	20	4	yellow	20	36	4		
yellow	36	52	6	green	4	52					
5	0	green	5	21	2	green	21	37	4		
green	37	53	6	green	2	53					
6	0	green	6	22	2	yellow	22	38	4		
yellow	38	54	6	green	2	54					
7	0	green	7	23	2	green	23	39	4		
green	39	55	6	green	2	55					
8	1	green	8	24	3	green	24	40	5		
green	40	56	7	green	3	56					
9	1	green	9	25	3	green	25	41	5		
green	41	57	7	green	3	57					
10	1	green	10	26	3	green	26	42	5		
green	42	58	7	green	3	58					
11	1	green	11	27	3	green	27	43	5		
green	43	59	7	green	3	59					
12	1	yellow	12	28	3	yellow	28	44	5		
green	44	60	7	green	3	60					
13	1	green	13	29	3	green	29	45	5		
green	45	61	7	green	3	61					
14	1	yellow	14	30	3	yellow	30	46	5		
green	46	62	7	green	3	62					
15	1	green	15	31	3	green	31	47	5		
green	47	63	7	green	3	63					

```
VTEP5#show qos-profile DSCP_ENCAP
profile name: DSCP_ENCAP
profile type: dscp-encap
profile attached to 1 instances
configured mapping:
 13 dscp 20 dscpEncap 56
Detailed mapping:
L3 DSCP to DSCP-ENCAP
```

INPUT OUTPUT		INPUT OUTPUT		INPUT OUTPUT		INPUT OUTPUT	
DSCP	DSCP	DSCP	DSCP	DSCP	DSCP	DSCP	DSCP
0	0	16	16	32	32	48	48

1	1		17	17		33	33		49	49
2	2		18	18		34	34		50	50
3	3		19	19		35	35		51	51
4	4		20	56		36	36		52	52
5	5		21	21		37	37		53	53
6	6		22	22		38	38		54	54
7	7		23	23		39	39		55	55
8	8		24	24		40	40		56	56
9	9		25	25		41	41		57	57
10	10		26	26		42	42		58	58
11	11		27	27		43	43		59	59
12	12		28	28		44	44		60	60
13	13		29	29		45	45		61	61
14	14		30	30		46	46		62	62
15	15		31	31		47	47		63	63

L2 Queue + Color to DSCP-ENCAP

INPUT			OUTPUT			INPUT			OUTPUT		
Queue	Color	DSCP	Queue	Color	DSCP	Queue	Color	DSCP	Queue	Color	DSCP
0	green	0	0	yellow	0	0	red	0			
1	green	8	1	yellow	8	1	red	8			
2	green	16	2	yellow	16	2	red	16			
3	green	24	3	yellow	24	3	red	24			
4	green	32	4	yellow	32	4	red	32			
5	green	40	5	yellow	40	5	red	40			
6	green	48	6	yellow	48	6	red	48			
7	green	56	7	yellow	56	7	red	56			

VTEP5#show qos-profile interface irb1001

profile name: DSCP_QUEUE

profile type: dscp-to-queue (Ingress)

mapping:

INPUT		OUTPUT		INPUT		OUTPUT		INPUT	
Queue	Color	Queue	Color	Queue	Color	Queue	Color	Queue	Color
0	green	0	green	16	2	green	16	32	4
1	green	8	green	17	2	green	17	33	4
2	green	16	green	18	2	green	18	34	4

3	0	green	3	6		19	2	51	green	19		35	4
green	35		51	6		green	51						
4	0	green	4	6		20	4	52	yellow	20		36	4
yellow	36		52	6		green	52						
5	0	green	5	6		21	2	53	green	21		37	4
green	37		53	6		green	53						
6	0	green	6	6		22	2	54	yellow	22		38	4
yellow	38		54	6		green	54						
7	0	green	7	6		23	2	55	green	23		39	4
green	39		55	6		green	55						
8	1	green	8	7		24	3	56	green	24		40	5
green	40		56	7		green	56						
9	1	green	9	7		25	3	57	green	25		41	5
green	41		57	7		green	57						
10	1	green	10	7		26	3	58	green	26		42	5
green	42		58	7		green	58						
11	1	green	11	7		27	3	59	green	27		43	5
green	43		59	7		green	59						
12	1	yellow	12	7		28	3	60	yellow	28		44	5
green	44		60	7		green	60						
13	1	green	13	7		29	3	61	green	29		45	5
green	45		61	7		green	61						
14	1	yellow	14	7		30	3	62	yellow	30		46	5
green	46		62	7		green	62						
15	1	green	15	7		31	3	63	green	31		47	5
green	47		63	7		green	63						

profile name: default
 profile type: dscp-to-dscp (Egress)
 Status: Inactive
 mapping:

INPUT			OUTPUT			INPUT			OUTPUT			INPUT			OUTPUT			
DSCP	Color	Out DSCP	DSCP	Color	Out DSCP	DSCP	Color	Out DSCP	DSCP	Color	Out DSCP	DSCP	Color	Out DSCP	DSCP	Color	Out DSCP	
0	green	0		0	yellow	0		0	red	0		0	red	0		0	red	0
1	green	1		1	yellow	1		1	red	1		1	red	1		1	red	1
2	green	2		2	yellow	2		2	red	2		2	red	2		2	red	2
3	green	3		3	yellow	3		3	red	3		3	red	3		3	red	3
4	green	4		4	yellow	4		4	red	4		4	red	4		4	red	4
5	green	5		5	yellow	5		5	red	5		5	red	5		5	red	5
6	green	6		6	yellow	6		6	red	6		6	red	6		6	red	6
7	green	7		7	yellow	7		7	red	7		7	red	7		7	red	7
8	green	8		8	yellow	8		8	red	8		8	red	8		8	red	8
9	green	9		9	yellow	9		9	red	9		9	red	9		9	red	9
10	green	10		10	yellow	12		10	red	14		10	red	14		10	red	14
11	green	11		11	yellow	11		11	red	11		11	red	11		11	red	11
12	green	12		12	yellow	12		12	red	14		12	red	14		12	red	14
13	green	13		13	yellow	13		13	red	13		13	red	13		13	red	13
14	green	14		14	yellow	14		14	red	14		14	red	14		14	red	14

15	green	15		15	yellow	15		15	red	15
16	green	16		16	yellow	16		16	red	16
17	green	17		17	yellow	17		17	red	17
18	green	18		18	yellow	20		18	red	22
19	green	19		19	yellow	19		19	red	19
20	green	20		20	yellow	20		20	red	22
21	green	21		21	yellow	21		21	red	21
22	green	22		22	yellow	22		22	red	22
23	green	23		23	yellow	23		23	red	23
24	green	24		24	yellow	24		24	red	24
25	green	25		25	yellow	25		25	red	25
26	green	26		26	yellow	28		26	red	30
27	green	27		27	yellow	27		27	red	27
28	green	28		28	yellow	28		28	red	30
29	green	29		29	yellow	29		29	red	29
30	green	30		30	yellow	30		30	red	30
31	green	31		31	yellow	31		31	red	31
32	green	32		32	yellow	32		32	red	32
33	green	33		33	yellow	33		33	red	33
34	green	34		34	yellow	36		34	red	38
35	green	35		35	yellow	35		35	red	35
36	green	36		36	yellow	36		36	red	38
37	green	37		37	yellow	37		37	red	37
38	green	38		38	yellow	38		38	red	38
39	green	39		39	yellow	39		39	red	39
40	green	40		40	yellow	40		40	red	40
41	green	41		41	yellow	41		41	red	41
42	green	42		42	yellow	42		42	red	42
43	green	43		43	yellow	43		43	red	43
44	green	44		44	yellow	44		44	red	44
45	green	45		45	yellow	45		45	red	45
46	green	46		46	yellow	46		46	red	46
47	green	47		47	yellow	47		47	red	47
48	green	48		48	yellow	48		48	red	48
49	green	49		49	yellow	49		49	red	49
50	green	50		50	yellow	50		50	red	50
51	green	51		51	yellow	51		51	red	51
52	green	52		52	yellow	52		52	red	52
53	green	53		53	yellow	53		53	red	53
54	green	54		54	yellow	54		54	red	54
55	green	55		55	yellow	55		55	red	55
56	green	56		56	yellow	56		56	red	56
57	green	57		57	yellow	57		57	red	57
58	green	58		58	yellow	58		58	red	58
59	green	59		59	yellow	59		59	red	59
60	green	60		60	yellow	60		60	red	60
61	green	61		61	yellow	61		61	red	61
62	green	62		62	yellow	62		62	red	62
63	green	63		63	yellow	63		63	red	63

VTEP4

```
VTEP4#show run qos
qos enable
qos remark dscp
!
!
qos profile queue-color-to-cos QUEUE_COS
  queue 6 color all cos 2
!
qos profile dscp-to-queue DSCP_QUEUE
  dscp 56 queue 6
!
qos profile dscp-to-dscp DSCP_DSCP
  dscp 20 color all dscp 32
!
!
!
!
interface irb2001
  qos map-profile dscp-to-dscp DSCP_DSCP
!
VTEP4#show run nvo vxlan
!
nvo vxlan enable
!
nvo vxlan irb
!
evpn vxlan multihoming enable
!
nvo vxlan vtep-ip-global 4.4.4.4
!
nvo vxlan tunnel qos-map-mode cos-dscp ingress DSCP_QUEUE
!
nvo vxlan id 101 ingress-replication inner-vid-disabled
  vxlan host-reachability-protocol evpn-bgp L2VRF1
  vni-name VNI-101
!
nvo vxlan id 201 ingress-replication inner-vid-disabled
  vxlan host-reachability-protocol evpn-bgp L2VRF2
  evpn irb2001
  vni-name VNI-201
!
nvo vxlan access-if port-vlan xe3 20
  map vnid 201
  mac 0000.5555.1020 ip 21.21.21.101
  map qos-profile queue-color-to-cos QUEUE_COS
!
!
VTEP4#show nvo vxlan tunnel
VxLAN Network tunnel Entries
```

Source	Destination	Status	Up/Down	Update
4.4.4.4	2.2.2.2	Installed	00:28:32	00:28:32
4.4.4.4	1.1.1.1	Installed	00:28:38	00:28:38
4.4.4.4	5.5.5.5	Installed	00:28:31	00:28:31

Total number of entries are 3

VTEP4#show nvo vxlan

VxLAN Information

=====

Codes: NW - Network Port
 AC - Access Port
 (u) - Untagged

VNID	VNI-Name	VNI-Type	Type	Interface	ESI	VLAN	DF-Status
Src-Addr	Dst-Addr						
101	VNI-101	L2	NW	----	----	----	----
4.4.4.4	2.2.2.2						
101	VNI-101	L2	NW	----	----	----	----
4.4.4.4	1.1.1.1						
101	VNI-101	L2	NW	----	----	----	----
4.4.4.4	5.5.5.5						
201	VNI-201	L2	NW	----	----	----	----
4.4.4.4	2.2.2.2						
201	VNI-201	L2	NW	----	----	----	----
4.4.4.4	1.1.1.1						
201	VNI-201	L2	NW	----	----	----	----
4.4.4.4	5.5.5.5						
201	VNI-201	--	AC	xe3	---	Single Homed Port	---
----	----	----				20	----
1000	----	L3	NW	----	----	----	----
4.4.4.4	5.5.5.5						

Total number of entries are 8

VTEP4#show nvo vxlan arp-cache

VxLAN ARP-CACHE Information

=====

VNID	Ip-Addr	Mac-Addr	Type	Age-Out	Retries-Left
201	21.21.21.51	0000.2222.1020	Static Remote	----	
201	21.21.21.1	3c2c.991a.da7a	Static Local	----	
201	21.21.21.101	0000.5555.1020	Static Local	----	
101	11.11.11.51	0000.2222.1010	Static Remote	----	
101	11.11.11.1	04f8.f82f.8eee	Static Remote	----	
101	11.11.11.201	0000.4444.1010	Static Remote	----	

Total number of entries are 6

VTEP4#show nvo vxlan nd-cache

VxLAN ND-CACHE Information

=====

VNID	Ip-Addr	Mac-Addr	Type	Age-Out
Retries-Left				

```

201      2121::1          3c2c.991a.da7a Static Local   ----
101      1111::1          04f8.f82f.8eee Static Remote  ----

```

Total number of entries are 2

VTEP4#show ipv4 route vrf L3VRF1

```

Codes: K - kernel, C - connected, S - static, R - RIP, B - BGP
       O - OSPF, IA - OSPF inter area
       N1 - OSPF NSSA external type 1, N2 - OSPF NSSA external type 2
       E1 - OSPF external type 1, E2 - OSPF external type 2
       i - IS-IS, L1 - IS-IS level-1, L2 - IS-IS level-2,
       ia - IS-IS inter area, E - EVPN,
       v - vrf leaked
       * - candidate default

```

IP Route Table for VRF "L3VRF1"

```

B      5.5.5.5/32 [0/0] is directly connected, tunvxlan1000, 00:01:03
B      11.11.11.0/24 [200/0] via 5.5.5.5 (recursive is directly connected,
tunvxlan1000), 00:01:03
C      21.21.21.0/24 is directly connected, irb2001, 00:03:31
C      127.0.0.0/8 is directly connected, lo.L3VRF1, 00:15:13

```

Gateway of last resort is not set

VTEP4#show ipv6 route vrf L3VRF1

IPv6 Routing Table

```

Codes: K - kernel route, C - connected, S - static, D- DHCP, R - RIP,
       O - OSPF, IA - OSPF inter area, E1 - OSPF external type 1,
       E2 - OSPF external type 2, E - EVPN  N1 - OSPF NSSA external type 1,
       N2 - OSPF NSSA external type 2, i - IS-IS, B - BGP,
       v - vrf leaked

```

Timers: Uptime

IP Route Table for VRF "L3VRF1"

```

C      ::1/128 via ::, lo.L3VRF1, 00:15:18
B      ::ffff:505:505/128 [0/0] via ::, tunvxlan1000, 00:01:08
B      1111::/64 [200/0] via ::ffff:505:505 (recursive via ::, unknown), 00:01:08
C      2121::/64 via ::, irb2001, 00:03:36
C      fe80::/64 via ::, irb2001, 00:03:36

```

VTEP4#show nvo vxlan l3vni-map

```

L3VNI      L2VNI      IRB-interface
=====
1000      201      irb2001

```

VTEP4#show interface xe3 counter queue-stats

E - Egress, I - Ingress, Q-Size is in bytes

```

+-----+-----+-----+-----+-----+
+-----+
| Queue/Class-map | Q-Size | Tx pkts | Tx bytes | Dropped pkts |
Dropped bytes |
+-----+-----+-----+-----+-----+
+-----+

```

q0	(E)	12517376	0	0	0	0
q1	(E)	12517376	0	0	0	0
q2	(E)	12517376	0	0	0	0
q3	(E)	12517376	0	0	0	0
q4	(E)	12517376	0	0	0	0
q5	(E)	12517376	0	0	0	0
q6	(E)	12517376	2219303	3209162748	0	0
q7	(E)	12517376	0	0	0	0

```
VTEP4#show qos-profile QUEUE_COS
profile name: QUEUE_COS
profile type: queue-color-to-cos
profile attached to 1 instances
configured mapping:
  queue 6 color all cos 2
Detailed mapping:
```

INPUT			OUTPUT			INPUT			OUTPUT			INPUT			OUTPUT		
Queue	Color	COS	Queue	Color	COS	Queue	Color	COS	Queue	Color	COS	Queue	Color	COS	Queue	Color	COS
0	green	0	0	yellow	0	0	red	0	0	red	0	0	red	0	0	red	0
1	green	1	1	yellow	1	1	red	1	1	red	1	1	red	1	1	red	1
2	green	2	2	yellow	2	2	red	2	2	red	2	2	red	2	2	red	2
3	green	3	3	yellow	3	3	red	3	3	red	3	3	red	3	3	red	3
4	green	4	4	yellow	4	4	red	4	4	red	4	4	red	4	4	red	4
5	green	5	5	yellow	5	5	red	5	5	red	5	5	red	5	5	red	5
6	green	2	6	yellow	2	6	red	2	6	red	2	6	red	2	6	red	2
7	green	7	7	yellow	7	7	red	7	7	red	7	7	red	7	7	red	7

```
VTEP4#show qos-profile DSCP_QUEUE
profile name: DSCP_QUEUE
profile type: dscp-to-queue
profile attached to 1 instances
configured mapping:
  dscp 56 queue 6
Detailed mapping:
```

INPUT				OUTPUT				INPUT				OUTPUT			
DSCP	Queue	Color	Out DSCP	DSCP	Queue	Color	Out DSCP	DSCP	Queue	Color	Out DSCP	DSCP	Queue	Color	Out DSCP
0	0	green	0	16	2	green	16	32	4	16	2	green	16	32	4
green	32		48	6	green	48	6	17	2	green	17	33	4	17	2
1	0	green	1	17	2	green	17	33	4	17	2	green	17	33	4
green	33		49	6	green	49	6								

2	0	green	2	6		18	2	50	green	18		34	4
green	34		50	6		green	50						
3	0	green	3	6		19	2	51	green	19		35	4
green	35		51	6		green	51						
4	0	green	4	6		20	2	52	yellow	20		36	4
yellow	36		52	6		green	52						
5	0	green	5	6		21	2	53	green	21		37	4
green	37		53	6		green	53						
6	0	green	6	6		22	2	54	yellow	22		38	4
yellow	38		54	6		green	54						
7	0	green	7	6		23	2	55	green	23		39	4
green	39		55	6		green	55						
8	1	green	8	6		24	3	56	green	24		40	5
green	40		56	6		green	56						
9	1	green	9	7		25	3	57	green	25		41	5
green	41		57	7		green	57						
10	1	green	10	7		26	3	58	green	26		42	5
green	42		58	7		green	58						
11	1	green	11	7		27	3	59	green	27		43	5
green	43		59	7		green	59						
12	1	yellow	12	7		28	3	60	yellow	28		44	5
green	44		60	7		green	60						
13	1	green	13	7		29	3	61	green	29		45	5
green	45		61	7		green	61						
14	1	yellow	14	7		30	3	62	yellow	30		46	5
green	46		62	7		green	62						
15	1	green	15	7		31	3	63	green	31		47	5
green	47		63	7		green	63						

```
VTEP4#show qos-profile DSCP_DSCP
profile name: DSCP_DSCP
profile type: dscp-to-dscp
profile attached to 1 instances
configured mapping:
  dscp 20 color all dscp 32
Detailed mapping:
```

-----+-----			-----+-----			-----+-----				
INPUT	OUTPUT		INPUT	OUTPUT		INPUT	OUTPUT			
-----+-----			-----+-----			-----+-----				
DSCP	Color	Out DSCP	DSCP	Color	Out DSCP	DSCP	Color	Out DSCP		
-----+-----			-----+-----			-----+-----				
0	green	0		0	yellow	0		0	red	0
1	green	1		1	yellow	1		1	red	1
2	green	2		2	yellow	2		2	red	2
3	green	3		3	yellow	3		3	red	3
4	green	4		4	yellow	4		4	red	4
5	green	5		5	yellow	5		5	red	5
6	green	6		6	yellow	6		6	red	6
7	green	7		7	yellow	7		7	red	7
8	green	8		8	yellow	8		8	red	8
9	green	9		9	yellow	9		9	red	9

10	green	10		10	yellow	12		10	red	14
11	green	11		11	yellow	11		11	red	11
12	green	12		12	yellow	12		12	red	14
13	green	13		13	yellow	13		13	red	13
14	green	14		14	yellow	14		14	red	14
15	green	15		15	yellow	15		15	red	15
16	green	16		16	yellow	16		16	red	16
17	green	17		17	yellow	17		17	red	17
18	green	18		18	yellow	20		18	red	22
19	green	19		19	yellow	19		19	red	19
20	green	32		20	yellow	32		20	red	32
21	green	21		21	yellow	21		21	red	21
22	green	22		22	yellow	22		22	red	22
23	green	23		23	yellow	23		23	red	23
24	green	24		24	yellow	24		24	red	24
25	green	25		25	yellow	25		25	red	25
26	green	26		26	yellow	28		26	red	30
27	green	27		27	yellow	27		27	red	27
28	green	28		28	yellow	28		28	red	30
29	green	29		29	yellow	29		29	red	29
30	green	30		30	yellow	30		30	red	30
31	green	31		31	yellow	31		31	red	31
32	green	32		32	yellow	32		32	red	32
33	green	33		33	yellow	33		33	red	33
34	green	34		34	yellow	36		34	red	38
35	green	35		35	yellow	35		35	red	35
36	green	36		36	yellow	36		36	red	38
37	green	37		37	yellow	37		37	red	37
38	green	38		38	yellow	38		38	red	38
39	green	39		39	yellow	39		39	red	39
40	green	40		40	yellow	40		40	red	40
41	green	41		41	yellow	41		41	red	41
42	green	42		42	yellow	42		42	red	42
43	green	43		43	yellow	43		43	red	43
44	green	44		44	yellow	44		44	red	44
45	green	45		45	yellow	45		45	red	45
46	green	46		46	yellow	46		46	red	46
47	green	47		47	yellow	47		47	red	47
48	green	48		48	yellow	48		48	red	48
49	green	49		49	yellow	49		49	red	49
50	green	50		50	yellow	50		50	red	50
51	green	51		51	yellow	51		51	red	51
52	green	52		52	yellow	52		52	red	52
53	green	53		53	yellow	53		53	red	53
54	green	54		54	yellow	54		54	red	54
55	green	55		55	yellow	55		55	red	55
56	green	56		56	yellow	56		56	red	56
57	green	57		57	yellow	57		57	red	57
58	green	58		58	yellow	58		58	red	58
59	green	59		59	yellow	59		59	red	59

60	green	60		60	yellow	60		60	red	60
61	green	61		61	yellow	61		61	red	61
62	green	62		62	yellow	62		62	red	62
63	green	63		63	yellow	63		63	red	63

VTEP4#show qos-profile interface irb2001

profile name: default

profile type: dscp-to-queue (Ingress)

mapping:

INPUT		OUTPUT		INPUT		OUTPUT		INPUT	
OUTPUT		INPUT		OUTPUT		INPUT		OUTPUT	
DSCP	Queue	Color	Out DSCP	DSCP	Queue	Color	Out DSCP	DSCP	Queue
Queue	Color	Out DSCP	DSCP	Queue	Color	Out DSCP	DSCP	Queue	Color
0	0	green	0	16	2	green	16	32	4
green	32	48	6	green	2	48	16	32	4
1	0	green	1	17	2	green	17	33	4
green	33	49	6	green	2	49	17	33	4
2	0	green	2	18	2	green	18	34	4
green	34	50	6	green	2	50	18	34	4
3	0	green	3	19	2	green	19	35	4
green	35	51	6	green	2	51	19	35	4
4	0	green	4	20	2	yellow	20	36	4
yellow	36	52	6	green	2	52	20	36	4
5	0	green	5	21	2	green	21	37	4
green	37	53	6	green	2	53	21	37	4
6	0	green	6	22	2	yellow	22	38	4
yellow	38	54	6	green	2	54	22	38	4
7	0	green	7	23	2	green	23	39	4
green	39	55	6	green	2	55	23	39	4
8	1	green	8	24	3	green	24	40	5
green	40	56	7	green	3	56	24	40	5
9	1	green	9	25	3	green	25	41	5
green	41	57	7	green	3	57	25	41	5
10	1	green	10	26	3	green	26	42	5
green	42	58	7	green	3	58	26	42	5
11	1	green	11	27	3	green	27	43	5
green	43	59	7	green	3	59	27	43	5
12	1	yellow	12	28	3	yellow	28	44	5
green	44	60	7	green	3	60	28	44	5
13	1	green	13	29	3	green	29	45	5
green	45	61	7	green	3	61	29	45	5
14	1	yellow	14	30	3	yellow	30	46	5
green	46	62	7	green	3	62	30	46	5
15	1	green	15	31	3	green	31	47	5
green	47	63	7	green	3	63	31	47	5

profile name: DSCP_DSCP

profile type: dscp-to-dscp (Egress)

Status: Active

mapping:

INPUT			OUTPUT			INPUT			OUTPUT			INPUT			OUTPUT		
DSCP	Color	Out DSCP	DSCP	Color	Out DSCP	DSCP	Color	Out DSCP	DSCP	Color	Out DSCP	DSCP	Color	Out DSCP	DSCP	Color	Out DSCP
0	green	0	0	yellow	0	0	red	0	0	red	0	0	red	0	0	red	0
1	green	1	1	yellow	1	1	red	1	1	red	1	1	red	1	1	red	1
2	green	2	2	yellow	2	2	red	2	2	red	2	2	red	2	2	red	2
3	green	3	3	yellow	3	3	red	3	3	red	3	3	red	3	3	red	3
4	green	4	4	yellow	4	4	red	4	4	red	4	4	red	4	4	red	4
5	green	5	5	yellow	5	5	red	5	5	red	5	5	red	5	5	red	5
6	green	6	6	yellow	6	6	red	6	6	red	6	6	red	6	6	red	6
7	green	7	7	yellow	7	7	red	7	7	red	7	7	red	7	7	red	7
8	green	8	8	yellow	8	8	red	8	8	red	8	8	red	8	8	red	8
9	green	9	9	yellow	9	9	red	9	9	red	9	9	red	9	9	red	9
10	green	10	10	yellow	12	10	red	14	10	red	14	10	red	14	10	red	14
11	green	11	11	yellow	11	11	red	11	11	red	11	11	red	11	11	red	11
12	green	12	12	yellow	12	12	red	14	12	red	14	12	red	14	12	red	14
13	green	13	13	yellow	13	13	red	13	13	red	13	13	red	13	13	red	13
14	green	14	14	yellow	14	14	red	14	14	red	14	14	red	14	14	red	14
15	green	15	15	yellow	15	15	red	15	15	red	15	15	red	15	15	red	15
16	green	16	16	yellow	16	16	red	16	16	red	16	16	red	16	16	red	16
17	green	17	17	yellow	17	17	red	17	17	red	17	17	red	17	17	red	17
18	green	18	18	yellow	20	18	red	22	18	red	22	18	red	22	18	red	22
19	green	19	19	yellow	19	19	red	19	19	red	19	19	red	19	19	red	19
20	green	32	20	yellow	32	20	red	32	20	red	32	20	red	32	20	red	32
21	green	21	21	yellow	21	21	red	21	21	red	21	21	red	21	21	red	21
22	green	22	22	yellow	22	22	red	22	22	red	22	22	red	22	22	red	22
23	green	23	23	yellow	23	23	red	23	23	red	23	23	red	23	23	red	23
24	green	24	24	yellow	24	24	red	24	24	red	24	24	red	24	24	red	24
25	green	25	25	yellow	25	25	red	25	25	red	25	25	red	25	25	red	25
26	green	26	26	yellow	28	26	red	30	26	red	30	26	red	30	26	red	30
27	green	27	27	yellow	27	27	red	27	27	red	27	27	red	27	27	red	27
28	green	28	28	yellow	28	28	red	30	28	red	30	28	red	30	28	red	30
29	green	29	29	yellow	29	29	red	29	29	red	29	29	red	29	29	red	29
30	green	30	30	yellow	30	30	red	30	30	red	30	30	red	30	30	red	30
31	green	31	31	yellow	31	31	red	31	31	red	31	31	red	31	31	red	31
32	green	32	32	yellow	32	32	red	32	32	red	32	32	red	32	32	red	32
33	green	33	33	yellow	33	33	red	33	33	red	33	33	red	33	33	red	33
34	green	34	34	yellow	36	34	red	38	34	red	38	34	red	38	34	red	38
35	green	35	35	yellow	35	35	red	35	35	red	35	35	red	35	35	red	35
36	green	36	36	yellow	36	36	red	38	36	red	38	36	red	38	36	red	38
37	green	37	37	yellow	37	37	red	37	37	red	37	37	red	37	37	red	37
38	green	38	38	yellow	38	38	red	38	38	red	38	38	red	38	38	red	38
39	green	39	39	yellow	39	39	red	39	39	red	39	39	red	39	39	red	39
40	green	40	40	yellow	40	40	red	40	40	red	40	40	red	40	40	red	40
41	green	41	41	yellow	41	41	red	41	41	red	41	41	red	41	41	red	41

42	green	42		42	yellow	42		42	red	42
43	green	43		43	yellow	43		43	red	43
44	green	44		44	yellow	44		44	red	44
45	green	45		45	yellow	45		45	red	45
46	green	46		46	yellow	46		46	red	46
47	green	47		47	yellow	47		47	red	47
48	green	48		48	yellow	48		48	red	48
49	green	49		49	yellow	49		49	red	49
50	green	50		50	yellow	50		50	red	50
51	green	51		51	yellow	51		51	red	51
52	green	52		52	yellow	52		52	red	52
53	green	53		53	yellow	53		53	red	53
54	green	54		54	yellow	54		54	red	54
55	green	55		55	yellow	55		55	red	55
56	green	56		56	yellow	56		56	red	56
57	green	57		57	yellow	57		57	red	57
58	green	58		58	yellow	58		58	red	58
59	green	59		59	yellow	59		59	red	59
60	green	60		60	yellow	60		60	red	60
61	green	61		61	yellow	61		61	red	61
62	green	62		62	yellow	62		62	red	62
63	green	63		63	yellow	63		63	red	63

CHAPTER 11 EVPN VXLAN E-Tree

Overview

Ethernet VPN Ethernet-Tree (EVPN E-Tree), is a networking solution designed to manage communication within broadcast domains, incorporating redundancy through multi-homing in a network. It optimizes traffic routing and control, especially in scenarios where specific services or devices need controlled communication. It categorizes network nodes based on predefined definitions of EVPN Instances as Leaf or Root, allowing or restricting communication between them.

Feature Characteristics

Implemented Scenario 1 of the EVPN E-Tree solution, as defined by RFC-8317, designates each Provider Edge (PE) node as either a Leaf or a Root site per Virtual Private Network (VPN) for VXLAN and MPLS EVPN in OcNOS.

Scenario 1: Leaf or Root Site(s) per PE

The explanation of scenario 1 is based on the provided topology diagram, which consists of three PE nodes labeled PE-1, PE-2, and PE-3 and two Multi-Homed (MH) nodes labeled MH-1 and MH-2. Within this setup, PE-3 functions as the Root node, while PE-1 and PE-2 serve as Leaf nodes. Also, PE-1 and PE-2 are part of a single home access-if port (SH1 and SH2).

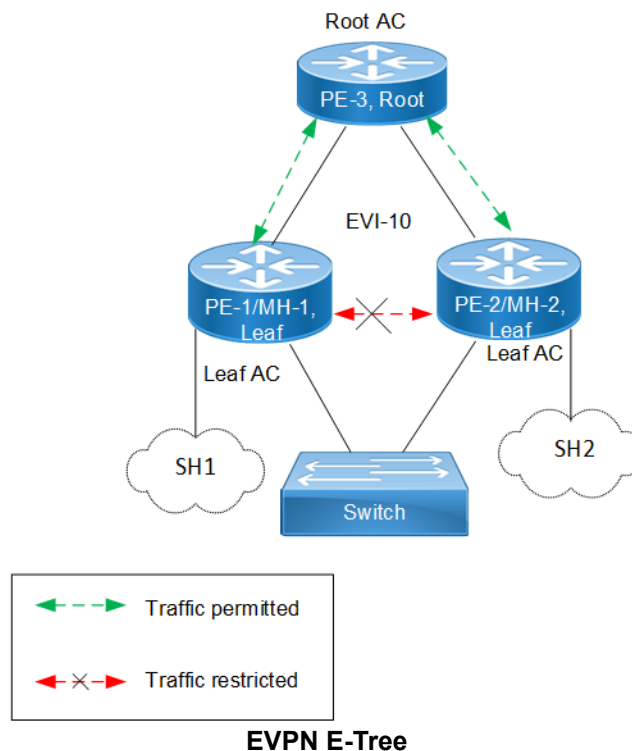

The classification ensures that communication follows specific rules:

- Communication between Leaf hosts is restricted, as indicated by red dotted lines with a cross mark (X) in the topology diagram. However, communication between Leaf and Root nodes, as well as between Root nodes, is permitted, marked by green dotted lines.

- Leaf nodes within PE-1 and PE-2 are isolated from each other, preventing intra-PE communication.

The scenario 1 is achieved through two main concepts:

1. Inter-PE Communication

- The inter-PE Route Target (RT) Constraint Method is applicable only to Single-Homing (SH) devices. Two RTs per broadcast domain are utilized, with Leaf PEs exporting Leaf RTs and Root nodes exporting Root RTs. Leaf nodes import only Root RTs, allowing communication with Root PEs while preventing communication with other Leaf nodes. RT constraints limit the import of specific EVPN routes (MAC-IP and IMET routes) to designated paths for inter-PE communication.
- IPI employs a proprietary method to support inter-PE connectivity for both SH and MH devices, using BGP extended community to advertise Leaf Indication in BGP routes and influence traffic flow for both Unicast and BUM traffic. This method enables implementation of ARP or ND cache suppression and MAC mobility sub-features specified in RFC-7432.

2. Intra-PE communication: Local Split Horizon controls intra-PE communication between Attachment Circuits (ACs) within Leaf PE nodes, ensuring that traffic between ACs does not egress to other Leaf ACs.

Note: This functionality depends on hardware capabilities.

Benefits

EVPN E-Tree offers benefits in networking environments by providing efficient traffic control, enhanced security, scalability, and improved performance.

Efficient Traffic Control: EVPN E-Tree allows for efficient control over traffic within network broadcast domains. By segregating nodes into Leaf and Root categories, it enables precise management of communication flows, ensuring the traffic is directed only where needed.

Enhanced Security: The isolation of Leaf hosts from each other adds a layer of security to the network. This prevents unauthorized communication between devices within the same broadcast domain, reducing the risk of data breaches and unauthorized access.

Scalability: EVPN E-Tree is scalable, making it suitable for networks of various sizes and complexities. Whether deploying in small-scale environments or large enterprise networks, EVPN E-Tree offers flexibility and scalability to meet evolving business needs.

Improved Performance: By controlling communication paths and optimizing traffic flows, EVPN E-Tree can improve network performance. This ensures that critical data packets are delivered efficiently, reducing latency and enhancing overall network performance.

Prerequisites

In setting up a VXLAN EVPN network, certain prerequisites are essential to ensure proper functionality and connectivity.

Ensure VXLAN EVPN Configuration: Confirm that VXLAN, EVPN VXLAN, and VXLAN filtering are already enabled in the network as they are required for VXLAN EVPN Multihoming.

Define Interfaces and Loopback Addresses: Configure Layer 2 interfaces, like port channel interfaces (e.g., po1), and assign specific system MAC addresses (Ethernet Segment Identifier (ESI) values) for proper identification and routing. Additionally, assign loopback IP addresses to establish essential points of connectivity. These configurations establish the efficient network routing and communication.

Configure OSPF and BGP for Dynamic Routing: Enable OSPF to facilitate dynamic routing within the network. Define OSPF router IDs to match loopback IP addresses and add network segments to OSPF areas for proper route

distribution. Additionally, establish BGP sessions to advertise routes between different nodes. Set up neighbor relationships using loopback IP addresses, ensuring efficient route advertisement and convergence for optimal network performance.

Leaf Node

1. Enable VXLAN and EVPN MH

Enable features like VXLAN and EVPN Multihoming, VXLAN filtering, and quality of service (QoS) capabilities on all Leaf nodes.

```
!
hardware-profile filter vxlan enable
hardware-profile filter vxlan-mh enable
!
nvo vxlan enable
!
evpn vxlan multihoming enable
!
qos enable
!
```

2. Configure Interfaces and Loopback

Define a port channel interface (po1) as an L2 interface and assign the system MAC (0000.0000.1111) as the ESI value. Designate an interface (xe7) as a member port of po1. Assign the loopback IP address (1.1.1.1) to Leaf node, and set IP addresses (10.10.10.1 and 10.10.11.1) to interfaces (xe45 and xe49/2), respectively, for connectivity with Spine nodes.

```
!
interface po1
  switchport
  evpn multi-homed system-mac 0000.0000.1111
!
interface lo
  ip address 1.1.1.1/32 secondary
!
interface xe7
  channel-group 1 mode active
!
interface xe45
  ip address 10.10.10.1/24
!
interface xe49/2
  ip address 10.10.11.1/24
  exit
!
```

3. Configure OSPF

In OSPF router mode, set the router ID (1.1.1.1), to match the loopback IP address. Add the loopback network (1.1.1.1/32) and networks (10.10.10.0/24 and 10.10.11.0/24) connected to Spine nodes in OSPF area 0. Enable Bidirectional Forwarding Detection (BFD) on all OSPF interfaces for faster convergence.

```
!
router ospf 100
  ospf router-id 1.1.1.1
  bfd all-interfaces
  network 1.1.1.1/32 area 0.0.0.0
```

```

network 10.10.10.0/24 area 0.0.0.0
network 10.10.11.0/24 area 0.0.0.0
!
```

4. Configure BGP

In BGP router mode, set the router ID (1.1.1.1) to match the loopback IP address. Specify the loopback IP address of each Leaf node as neighbors with their respective remote AS numbers. Configure the loopback as the update source for each neighbor and set the advertisement interval (0) for rapid convergence. In L2VPN EVPN address family mode, activate each Leaf node (2.2.2.2, 3.3.3.3, 4.4.4.4) to establish connections within the EVPN address family.

```

!
router bgp 100
  bgp router-id 1.1.1.1
  neighbor 2.2.2.2 remote-as 100
  neighbor 3.3.3.3 remote-as 100
  neighbor 4.4.4.4 remote-as 100
  neighbor 2.2.2.2 update-source lo
  neighbor 2.2.2.2 advertisement-interval 0
  neighbor 3.3.3.3 update-source lo
  neighbor 3.3.3.3 advertisement-interval 0
  neighbor 4.4.4.4 update-source lo
  neighbor 4.4.4.4 advertisement-interval 0
!
address-family l2vpn evpn
  neighbor 2.2.2.2 activate
  neighbor 3.3.3.3 activate
  neighbor 4.4.4.4 activate
exit-address-family
!
exit
!
```

5. Configure VRF

In VRF mode, create a MAC routing or forwarding instance (VRF1). Assign the Route Distinguisher (RD) value (1.1.1.1:100) and set both import and export route-target value (100:100). Ensure that the same route-target value is configured on all Leaf nodes for MAC VRF to maintain consistency.

```

!
mac vrf VRF1
  rd 1.1.1.1:100
  route-target both 100:100
!
```

Spine Node

1. Configure Interfaces and Loopback

Enable QoS and assign specific IP addresses to loopback interfaces. Configure IP addresses for interfaces connected to each Leaf node.

```

!
qos enable
!
interface ce1/2
  ip address 40.40.40.2/24
!
interface ce1/4
```

```

    ip address 10.10.10.2/24
    !
interface ce24/1
    ip address 30.30.30.2/24
    !
interface ce27/1
    ip address 20.20.20.2/24
    !
interface lo
    ip address 5.5.5.5/32 secondary
    !

```

2. Configure OSPF

In OSPF router mode, set the router ID (5.5.5.5), to match the loopback IP address. Add the loopback network (5.5.5.5/32) and networks (10.10.10.0/24, 20.20.20.0/24, 30.30.30.0/24, and 40.40.40.0/24) connected to Leaf nodes in OSPF area 0. Enable BFD on all OSPF interfaces for faster convergence.

```

!
router ospf 100
    ospf router-id 5.5.5.5
    bfd all-interfaces
    network 5.5.5.5/32 area 0.0.0.0
    network 10.10.10.0/24 area 0.0.0.0
    network 20.20.20.0/24 area 0.0.0.0
    network 30.30.30.0/24 area 0.0.0.0
    network 40.40.40.0/24 area 0.0.0.0
!

```

Configure Switch

Set up an IEEE VLAN bridge, enabling VLANs and associating them with bridge 1. Configure interfaces (xe57, po1, xe46, xe47) to be part of bridge 1, setting them as hybrid ports with VLAN (1000) allowed and egress-tagged enabled. Designate interfaces connected to Leaf nodes (xe46 and xe47) as member ports of po1.

```

!
bridge 1 protocol ieee vlan-bridge
!
vlan database
    vlan-reservation 4000-4094
    vlan 1000 bridge 1 state enable
!
interface po1
    switchport
    bridge-group 1
    switchport mode hybrid
    switchport mode hybrid acceptable-frame-type all
    switchport hybrid allowed vlan add 1000 egress-tagged enable
!
interface xe46
    channel-group 1 mode active
!
interface xe47
    channel-group 1 mode active
!
interface xe57
    switchport
    bridge-group 1

```

```
switchport mode hybrid
switchport mode hybrid acceptable-frame-type all
switchport hybrid allowed vlan add 1000 egress-tagged enable
!
```

Configuration

Configure various nodes within the topology to set up a VXLAN EVPN E-Tree network.

Topology

The sample topology includes Leaf Nodes (VTEP1, VTEP2, VTEP3, and VTEP4), Spine Nodes (SPINE1 and SPINE2), and Switches (SWITCH1 and SWITCH2).

Within this setup, VTEP1 and VTEP2 are part of Multi-homed group1, where VTEP1 is Multi-homed with po1 (MH1), and VTEP2 is Multi-homed with po1, also featuring an interface as a single home access-if port (SH1). Similarly, VTEP3 and VTEP4 are part of a Multi-homed group2, with VTEP3 Multi-homed with po2 (MH2) and VTEP4 Multi-homed with po2, along with an interface as a single home access-if port (SH2). These nodes connect to Spine nodes (SPINE1 and SPINE2), where all VTEPs are linked. Additionally, SWITCH1 and SWITCH2 are configured to be multihomed to two Leaf nodes each, with SWITCH1 connecting to VTEP1 and VTEP2 and SWITCH2 connecting to VTEP3 and VTEP4.

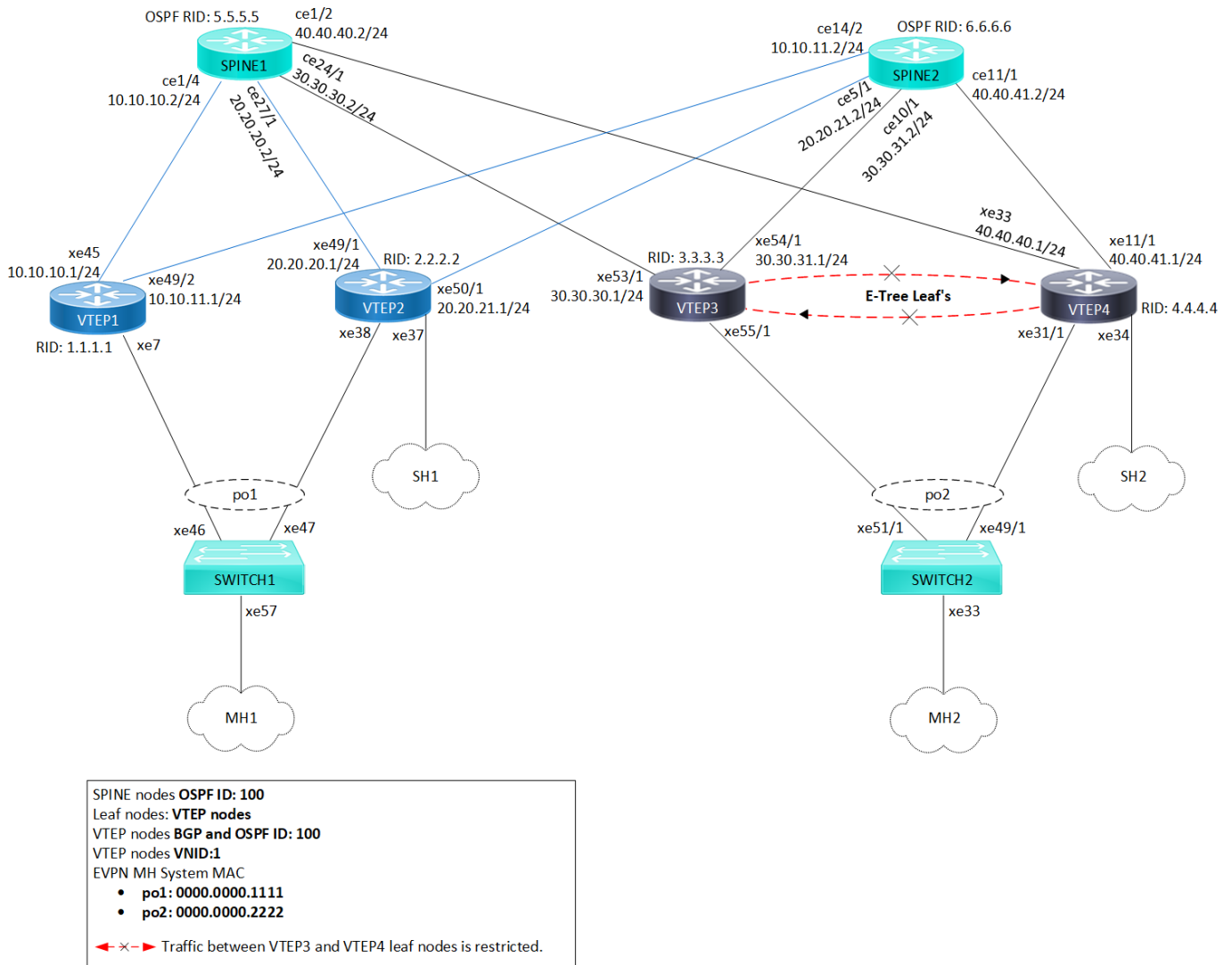

VXLAN EVPN E-Tree Topology

Note: Before configuring E-Tree, meet all [Prerequisites](#) for the following nodes:

- Leaf nodes: VTEP1, VTEP2, VTEP3, and VTEP4
- Spine nodes: SPINE1 and SPINE2
- Switches: SWITCH1 and SWITCH2

Enable EVPN E-Tree

The following E-Tree configurations applies to the VTEP nodes within the VXLAN network.

1. Enable EVPN E-Tree on VTEP3 and VTEP4 nodes, allowing them to participate in E-Tree functionality within the VXLAN network, controlling traffic and establishing hierarchical connections between Leaf nodes in the network architecture.

```
(config)#evpn etree enable
```
2. Set the ESI hold time (90 seconds) on all VTEP nodes to allow the tunnel to establish during VXLAN initialization before bringing up the ESI. Configure the source VTEP IP address (3.3.3.3) which serves as the global identifier for VXLAN encapsulation and decapsulation within the network, facilitating proper communication and tunnel establishment.

```
(config)#evpn esi hold-time 90
(config)#nvo vxlan vtep-ip-global 3.3.3.3
```

- Define VXLAN identifier (10) with ingress replication and disabled inner VLAN ID (VID) for **E-Tree leaf nodes** (VTEP3 and VTEP4) to support hierarchical connectivity and traffic control within the VXLAN network. This configuration allows for efficient replication of traffic at the ingress point and ensures that inner VLAN IDs are disabled, optimizing the functionality of E-Tree leaf nodes within the network architecture. On the VXLAN tenant node, assign VRF (VRF1) to EVPN-BGP for carrying EVPN routes within the VXLAN network.

```
(config)#nvo vxlan id 10 ingress-replication inner-vid-disabled etree-leaf
(config-nvo)#vxlan host-reachability-protocol evpn-bgp VRF1
(config-nvo)#exit
```

- Enable port-VLAN mapping (po2) with VLAN ID (1000) to facilitate multi-homed access on all VTEP nodes. Map VXLAN identifier (10) to the access port for VXLAN connectivity.

```
(config)#nvo vxlan access-if port-vlan po2 1000
(config-nvo-acc-if)#map vnid 10
(config-nvo-acc-if)#exit
(config)#commit
```

Validation

Use the show commands described in this section to verify the network for proper VXLAN EVPN E-Tree configuration.

Verify OSPF sessions between the VTEP nodes and the SPINES within the VXLAN network using the `show ip ospf neighbor` command. This command displays OSPF neighbor details, including the state of the OSPF neighbor relationship. A State of Full/DR indicates a fully adjacent and operational state between the routers, confirming proper OSPF connectivity within the network.

```
VTEP1#show ip ospf neighbor
```

```
Total number of full neighbors: 2
OSPF process 100 VRF(default):
```

Neighbor ID	Pri	State	Dead Time	Address	Interface	Instance ID
5.5.5.5	1	Full/DR	00:00:32	10.10.10.2	xe45	0
6.6.6.6	1	Full/DR	00:00:30	10.10.11.2	xe49/2	0

Verify the BGP session status between VTEPs, using the `show bgp l2vpn evpn summary` command output. The Up/Down field indicates the duration for which the BGP session has been up or down.

```
VTEP1#show bgp l2vpn evpn summary
BGP router identifier 1.1.1.1, local AS number 100
BGP table version is 9
1 BGP AS-PATH entries
0 BGP community entries
```

Neighbor	V	AS	MsgRcv	MsgSen	TblVer	InQ	OutQ	Up/Down	State/PfxRcd	AD	MACIP	MCAST	ESI	PREFIX-ROUTE
2.2.2.2	4	100	34	28	7	0	0	00:07:37	9	3	4	1	1	0
3.3.3.3	4	100	30	33	8	0	0	00:07:34	6	3	2	1	0	0
4.4.4.4	4	100	31	28	7	0	0	00:07:37	8	3	4	1	0	0

```
Total number of neighbors 3
```

```
Total number of Established sessions 3
```

To validate the BGP L2VPN output on VTEPs and check MAC-IP routes and ESI information, use the `show bgp l2vpn evpn` command output. This command verifies routes with status code `i` (internal) and EVPN route types 2 and 4, displaying detailed information for each VTEP nodes.

```
VTEP1#show bgp l2vpn evpn
BGP table version is 9, local router ID is 1.1.1.1
Status codes: s suppressed, d damped, h history, a add-path, b back-up, * valid, > best, i - internal,
l - labeled, S Stale
```

Origin codes: i - IGP, e - EGP, ? - incomplete

[EVPN route type]:[ESI]:[VNID]:[relevant route information]

- 1 - Ethernet Auto-discovery Route
- 2 - MAC/IP Route
- 3 - Inclusive Multicast Route
- 4 - Ethernet Segment Route
- 5 - Prefix Route

Network	Next Hop	Metric	LocPrf	Weight	Path	Peer	Encap
RD[1.1.1.1:100] VRF[VRF1]:							
*> [1]:[00:00:00:00:00:11:11:00:00:00]:[10]:[10]							
	1.1.1.1	0	100	32768	i	-----	VXLAN
* i	2.2.2.2	0	100	0	i	2.2.2.2	VXLAN
*> [1]:[00:00:00:00:00:11:11:00:00:00]:[4294967295]:[0]							
	1.1.1.1	0	100	32768	i	-----	VXLAN
* i	2.2.2.2	0	100	0	i	2.2.2.2	VXLAN
* i	2.2.2.2	0	100	0	i	2.2.2.2	VXLAN
* i[1]:[00:00:00:00:00:22:22:00:00:00]:[10]:[10]							
	3.3.3.3	0	100	0	i	3.3.3.3	VXLAN
* i	4.4.4.4	0	100	0	i	4.4.4.4	VXLAN
* i[1]:[00:00:00:00:00:22:22:00:00:00]:[4294967295]:[0]							
	3.3.3.3	0	100	0	i	3.3.3.3	VXLAN
* i	3.3.3.3	0	100	0	i	3.3.3.3	VXLAN
* i	4.4.4.4	0	100	0	i	4.4.4.4	VXLAN
* i	4.4.4.4	0	100	0	i	4.4.4.4	VXLAN
*> [2]:[00:00:00:00:00:11:11:00:00:00]:[10]:[48,0000:1000:1000]:[32,100.100.100.1]:[10]							
	1.1.1.1	0	100	32768	i	-----	VXLAN
* i	2.2.2.2	0	100	0	i	2.2.2.2	VXLAN
*> [2]:[00:00:00:00:00:11:11:00:00:00]:[10]:[48,0000:1000:1001]:[128,1000::1][10]							
	1.1.1.1	0	100	32768	i	-----	VXLAN
* i	2.2.2.2	0	100	0	i	2.2.2.2	VXLAN
* i[2]:[0]:[10]:[48,0000:2000:2000]:[32,200.200.1]:[10]							
	2.2.2.2	0	100	0	i	2.2.2.2	VXLAN
* i[2]:[0]:[10]:[48,0000:2000:2001]:[128,2000::1][10]		0	100	0	i	2.2.2.2	VXLAN
* i[2]:[00:00:00:00:00:22:22:00:00:00]:[10]:[48,0000:3000:3000]:[32,103.103.103.1]:[10]		0	100	0	i	3.3.3.3	VXLAN
* i	3.3.3.3	0	100	0	i	3.3.3.3	VXLAN
* i	4.4.4.4	0	100	0	i	4.4.4.4	VXLAN
* i[2]:[00:00:00:00:00:22:22:00:00:00]:[10]:[48,0000:3000:3001]:[128,1003::1][10]							
	3.3.3.3	0	100	0	i	3.3.3.3	VXLAN
* i	4.4.4.4	0	100	0	i	4.4.4.4	VXLAN
* i[2]:[0]:[10]:[48,0000:4000:4000]:[32,104.104.104.1]:[10]							
	4.4.4.4	0	100	0	i	4.4.4.4	VXLAN
* i[2]:[0]:[10]:[48,0000:4000:4001]:[128,1004::1][10]		0	100	0	i	4.4.4.4	VXLAN
	4.4.4.4	0	100	0	i	4.4.4.4	VXLAN
*> [3]:[10]:[32,1.1.1.1]							
	1.1.1.1	0	100	32768	i	-----	VXLAN
* i[3]:[10]:[32,2.2.2.2]		0	100	0	i	2.2.2.2	VXLAN
	2.2.2.2	0	100	0	i	2.2.2.2	VXLAN
* i[3]:[10]:[32,3.3.3.3]		0	100	0	i	3.3.3.3	VXLAN
	3.3.3.3	0	100	0	i	3.3.3.3	VXLAN
* i[3]:[10]:[32,4.4.4.4]		0	100	0	i	4.4.4.4	VXLAN
	4.4.4.4	0	100	0	i	4.4.4.4	VXLAN
RD[1.1.1.1:64512] VRF[evpn-gvrf-1]:							
*> [1]:[00:00:00:00:00:11:11:00:00:00]:[4294967295]:[0]							
	1.1.1.1	0	100	32768	i	-----	VXLAN
*> [4]:[00:00:00:00:00:11:11:00:00:00]:[32,1.1.1.1]							
	1.1.1.1	0	100	32768	i	-----	VXLAN
* i[4]:[00:00:00:00:00:11:11:00:00:00]:[32,2.2.2.2]		0	100	0	i	2.2.2.2	VXLAN
	2.2.2.2	0	100	0	i	2.2.2.2	VXLAN
RD[2.2.2.2:100]							
*>i[1]:[00:00:00:00:00:11:11:00:00:00]:[10]:[10]							
	2.2.2.2	0	100	0	i	2.2.2.2	VXLAN
*>i[1]:[00:00:00:00:00:11:11:00:00:00]:[4294967295]:[0]							
	2.2.2.2	0	100	0	i	2.2.2.2	VXLAN
*>i[2]:[00:00:00:00:00:11:11:00:00:00]:[10]:[48,0000:1000:1000]:[32,100.100.100.1]:[10]		0	100	0	i	2.2.2.2	VXLAN
	2.2.2.2	0	100	0	i	2.2.2.2	VXLAN
*>i[2]:[00:00:00:00:00:11:11:00:00:00]:[10]:[48,0000:1000:1001]:[128,1000::1][10]		0	100	0	i	2.2.2.2	VXLAN
	2.2.2.2	0	100	0	i	2.2.2.2	VXLAN

```

*>i[2]:[0]:[10]:[48,0000:2000:2000]:[32,200.200.200.1]:[10]
    2.2.2.2          0          100      0    i  2.2.2.2      VXLAN
*>i[2]:[0]:[10]:[48,0000:2000:2001]:[128,2000::1][10]
    2.2.2.2          0          100      0    i  2.2.2.2      VXLAN
*>i[3]:[10]:[32,2.2.2.2]
    2.2.2.2          0          100      0    i  2.2.2.2      VXLAN

RD[2.2.2.2:64512]
*>i[1]:[00:00:00:00:00:11:11:00:00:00]:[4294967295]:[0]
    2.2.2.2          0          100      0    i  2.2.2.2      VXLAN
*>i[4]:[00:00:00:00:00:11:11:00:00:00]:[32,2.2.2.2]
    2.2.2.2          0          100      0    i  2.2.2.2      VXLAN

RD[3.3.3.3:100]
*>i[1]:[00:00:00:00:00:22:22:00:00:00]:[10]:[10]
    3.3.3.3          0          100      0    i  3.3.3.3      VXLAN
*>i[1]:[00:00:00:00:00:22:22:00:00:00]:[4294967295]:[0]
    3.3.3.3          0          100      0    i  3.3.3.3      VXLAN
*>i[2]:[00:00:00:00:00:22:22:00:00:00]:[10]:[48,0000:3000:3000]:[32,103.103.103.1]:[10]
    3.3.3.3          0          100      0    i  3.3.3.3      VXLAN
*>i[2]:[00:00:00:00:00:22:22:00:00:00]:[10]:[48,0000:3000:3001]:[128,1003::1][10]
    3.3.3.3          0          100      0    i  3.3.3.3      VXLAN
*>i[3]:[10]:[32,3.3.3.3]
    3.3.3.3          0          100      0    i  3.3.3.3      VXLAN

RD[3.3.3.3:64512]
*>i[1]:[00:00:00:00:00:22:22:00:00:00]:[4294967295]:[0]
    3.3.3.3          0          100      0    i  3.3.3.3      VXLAN

RD[4.4.4.4:100]
*>i[1]:[00:00:00:00:00:22:22:00:00:00]:[10]:[10]
    4.4.4.4          0          100      0    i  4.4.4.4      VXLAN
*>i[1]:[00:00:00:00:00:22:22:00:00:00]:[4294967295]:[0]
    4.4.4.4          0          100      0    i  4.4.4.4      VXLAN
*>i[2]:[00:00:00:00:00:22:22:00:00:00]:[10]:[48,0000:3000:3000]:[32,103.103.103.1]:[10]
    4.4.4.4          0          100      0    i  4.4.4.4      VXLAN
*>i[2]:[00:00:00:00:00:22:22:00:00:00]:[10]:[48,0000:3000:3001]:[128,1003::1][10]
    4.4.4.4          0          100      0    i  4.4.4.4      VXLAN
*>i[2]:[0]:[10]:[48,0000:4000:4000]:[32,104.104.104.1]:[10]
    4.4.4.4          0          100      0    i  4.4.4.4      VXLAN
*>i[2]:[0]:[10]:[48,0000:4000:4001]:[128,1004::1][10]
    4.4.4.4          0          100      0    i  4.4.4.4      VXLAN
*>i[3]:[10]:[32,4.4.4.4]
    4.4.4.4          0          100      0    i  4.4.4.4      VXLAN

RD[4.4.4.4:64512]
*>i[1]:[00:00:00:00:00:22:22:00:00:00]:[4294967295]:[0]
    4.4.4.4          0          100      0    i  4.4.4.4      VXLAN

```

Total number of prefixes 42

Validate the LAG interfaces (po1 and po2) are up for MH1 and MH2 by reviewing the show etherchannel summary output. Check the Link and sync fields, where link displays the port channel interface and ID number, and sync indicates whether MAC address synchronization is enabled to forward Layer 3 packets arriving on these interfaces.

```

VTEP1#show etherchannel summary
  Aggregator po1 100001
  Aggregator Type: Layer2
  Admin Key: 0001 - Oper Key 0001
  Link: xe7 (5005) sync: 1

```

Validate the status of NVO VXLAN on VTEPs by examining the output of the show nvo vxlan command. The DF-Status field displays the forwarding status of VXLAN tunnels as a Designated Forwarder (DF) or Non-Designated Forwarder (Non-DF).

```

VTEP1#show nvo vxlan
VXLAN Information
=====

```

Codes: NW - Network Port
 AC - Access Port
 (u) - Untagged

VNID	VNI-Name	VNI-Type	Type	Interface	ESI	VLAN	DF-Status	Src-Addr	Dst-Addr
10	----	L2	NW	----	----	----	----	1.1.1.1	4.4.4.4
10	----	L2	NW	----	----	----	----	1.1.1.1	3.3.3.3
10	----	L2	NW	----	----	----	----	1.1.1.1	2.2.2.2
10	----	--	AC	po1	00:00:00:00:00:11:11:00:00:00	1000	DF	----	----

Total number of entries are 4

VTEP2#show nvo vxlan
 VXLAN Information

Codes: NW - Network Port
 AC - Access Port
 (u) - Untagged

VNID	VNI-Name	VNI-Type	Type	Interface	ESI	VLAN	DF-Status	Src-Addr	Dst-Addr
10	----	L2	NW	----	----	----	----	2.2.2.2	4.4.4.4
10	----	L2	NW	----	----	----	----	2.2.2.2	1.1.1.1
10	----	L2	NW	----	----	----	----	2.2.2.2	3.3.3.3
10	----	--	AC	xe37	--- Single Homed Port ---	1000	----	----	----
10	----	--	AC	po1	00:00:00:00:00:11:11:00:00:00	1000	NON-DF	----	----

Total number of entries are 5

VTEP3#show nvo vxlan
 VXLAN Information

Codes: NW - Network Port
 AC - Access Port
 (u) - Untagged

VNID	VNI-Name	VNI-Type	Type	Interface	ESI	VLAN	DF-Status	Src-Addr	Dst-Addr
10	----	L2	NW	----	----	----	----	3.3.3.3	2.2.2.2
10	----	L2	NW	----	----	----	----	3.3.3.3	1.1.1.1
10	----	L2	NW	----	----	----	----	3.3.3.3	4.4.4.4
10	----	--	AC	po2	00:00:00:00:00:22:22:00:00:00	1000	DF	----	----

Total number of entries are 4

VTEP4#show nvo vxlan
 VXLAN Information

Codes: NW - Network Port
 AC - Access Port
 (u) - Untagged

VNID	VNI-Name	VNI-Type	Type	Interface	ESI	VLAN	DF-Status	Src-Addr	Dst-Addr
10	----	L2	NW	----	----	----	----	4.4.4.4	2.2.2.2
10	----	L2	NW	----	----	----	----	4.4.4.4	3.3.3.3
10	----	L2	NW	----	----	----	----	4.4.4.4	1.1.1.1
10	----	--	AC	xe34	--- Single Homed Port ---	1000	----	----	----
10	----	--	AC	po2	00:00:00:00:00:22:22:00:00:00	1000	NON-DF	----	----

Total number of entries are 5

Validate the NVO VXLAN tunnel status on VTEPs by reviewing the output of the `show nvo vxlan tunnel` command. The `Status` field indicates the current status of each tunnel. In this case, all three tunnels between VTEPs and their respective destinations are marked as `Installed`, confirming that these tunnels are successfully established and operating.

VTEP1#show nvo vxlan tunnel
 VXLAN Network tunnel Entries

Source	Destination	Status	Up/Down	Update
--------	-------------	--------	---------	--------

```
=====
1.1.1.1      4.4.4.4      Installed      00:02:26      00:01:58
1.1.1.1      3.3.3.3      Installed      00:02:26      00:01:55
1.1.1.1      2.2.2.2      Installed      00:02:25      00:01:55
```

Total number of entries are 3

Validate the VXLAN access interface status on VTEPs by examining the output of the `show nvo vxlan access-if brief` command. The `up admin` and `link status` confirms that the access port associated with VXLAN is active and functioning properly on the VTEP nodes.

```
VTEP1#show nvo vxlan access-if brief
```

```

          Inner
Interface  Vlan      vlan  Ifindex  Vnid      Admin  Link
          status status
-----
po1        1000     ---   0x7a120  10        up     up

```

Total number of entries are 1

Static MAC-IP Advertisement

Configure static MAC-IP advertisement through SH and MH VTEPs from Root and Leaf nodes. Advertise static MAC addresses for IPv4 and IPv6 from MH1, MH2, SH1, and SH2 VTEPs. Ensure that VTEP1 and VTEP2 in MH1 have the same MAC addresses configured under the port-channel access port. Symmetrical configurations between MH VTEPs should be maintained.

Configure MH1 and MH2 VTEPs

Configure static MAC addresses for IPv4 (100.100.100.1) and IPv6 (1000::1) under the VXLAN MH access-port (po1) with VLAN ID (1000). Ensure that identical MAC addresses are set up within the MH1-VTEPs for advertisement. Apply similar configurations to MH2-VTEPs for static MAC-IP advertisement.

```

!
nvo vxlan access-if port-vlan po1 1000
  map vnid 10
  mac 0000.1000.1000 ip 100.100.100.1
  mac 0000.1000.1001 ipv6 1000::1
!
```

Configure SH1 and SH2 VTEPs

Configure static MAC addresses for IPv4 (200.200.200.1) and IPv6 (2000::1) under the VXLAN SH access-port (xe37) with VLAN ID (1000) on SH1 (VTEP2). This setup ensures that SH1 advertises these static MAC addresses over the specified VXLAN access-port. Repeat similar configurations for SH2 (VTEP4) using different static MAC addresses for both IPv4 and IPv6.

```

!
nvo vxlan access-if port-vlan xe37 1000
  map vnid 10
  mac 0000.2000.2000 ip 200.200.200.1
  mac 0000.2000.2001 ipv6 2000::1
!
```

Validation

Verify the MAC table entries on MH VTEPs (MH1 and MH2) and the SH VTEPs (VTEP2 and VTEP4). The MAC addresses are advertised using the ESI values from VTEP1 and VTEP2 for MH1, and from VTEP3 and VTEP4 for MH2. Additionally, verify the VTEP IP addresses associated with SH VTEP2 and VTEP4 for MAC advertisement.

In the output of the `show nvo vxlan mac-table` command on all VTEP nodes, the MAC entries advertised from Leaf VTEPs will have the `LeafFlag` field status `set`.

Note:

- MAC IPv4 or IPv6 configured under SH Leaf VTEP access port will be advertised to the Root VTEP and other Leaf VTEPs.
- MAC IPv4 or IPv6 configured under an MH Leaf VTEP access port must be symmetric and will be advertised to both the Root VTEP and other leaf VTEPs.
- MAC IPv4 or IPv6 configured under either SH or MH Root VTEP will be advertised to both the Root VTEP and the Leaf VTEPs.
- The Leaf-to-Leaf communication will display MAC status and tunnel status per VNI as Leaf type. The MAC will be in the discard state in the BCM shell.

VTEP1#show nvo vxlan mac-table

```
=====
                                VXLAN MAC Entries
=====
VNID Interface VlanId  In-VlanId Mac-Addr          VTEP-Ip/ESI          Type  Status  MAC move AccessPortDesc LeafFlag
-----
10  po1      1000    ----    0000.1000.1000    00:00:00:00:00:11:11:00:00:00 Static Local  ----- 0 -----  ----
10  po1      1000    ----    0000.1000.1001    00:00:00:00:00:11:11:00:00:00 Static Local  ----- 0 -----  ----
10  ----     ----     ----    0000.2000.2000    2.2.2.2              Static Remote ----- 0 -----  ----
10  ----     ----     ----    0000.2000.2001    2.2.2.2              Static Remote ----- 0 -----  ----
10  ----     ----     ----    0000.3000.3000    00:00:00:00:00:22:22:00:00:00 Static Remote ----- 0 -----  set
10  ----     ----     ----    0000.3000.3001    00:00:00:00:00:22:22:00:00:00 Static Remote ----- 0 -----  set
10  ----     ----     ----    0000.4000.4000    4.4.4.4              Static Remote ----- 0 -----  set
10  ----     ----     ----    0000.4000.4001    4.4.4.4              Static Remote ----- 0 -----  set
```

Total number of entries are : 8

VTEP3#show nvo vxlan mac-table

```
=====
                                VXLAN MAC Entries
=====
VNID Interface VlanId  In-VlanId Mac-Addr          VTEP-Ip/ESI          Type  Status  MAC move AccessPortDesc LeafFlag
-----
10  ----     ----     ----    0000.1000.1000    00:00:00:00:00:11:11:00:00:00 Static Remote ----- 0 -----  ----
10  ----     ----     ----    0000.1000.1001    00:00:00:00:00:11:11:00:00:00 Static Remote ----- 0 -----  ----
10  ----     ----     ----    0000.2000.2000    2.2.2.2              Static Remote ----- 0 -----  ----
10  ----     ----     ----    0000.2000.2001    2.2.2.2              Static Remote ----- 0 -----  ----
10  po2      1000    ----    0000.3000.3000    00:00:00:00:00:22:22:00:00:00 Static Local  ----- 0 -----  set
10  po2      1000    ----    0000.3000.3001    00:00:00:00:00:22:22:00:00:00 Static Local  ----- 0 -----  set
10  ----     ----     ----    0000.4000.4000    4.4.4.4              Static Remote ----- 0 -----  set
10  ----     ----     ----    0000.4000.4001    4.4.4.4              Static Remote ----- 0 -----  set
```

Total number of entries are : 8

Use the `show nvo vxlan arp-cache` command to verify the Address Resolution Protocol (ARP) cache information on all VTEP nodes. This command displays entries that map IPv4 addresses to MAC addresses within the specified VXLAN VNID network.

VTEP1#show nvo vxlan arp-cache

VXLAN ARP-CACHE Information

```
=====
VNID      Ip-Addr          Mac-Addr          Type          Age-Out  Retries-Left
-----
10        100.100.100.1    0000.1000.1000    Static        Local    -----
```

```

10      103.103.103.1    0000.3000.3000 Static      Remote      ----
10      104.104.104.1    0000.4000.4000 Static      Remote      ----
10      200.200.200.1    0000.2000.2000 Static      Remote      ----
Total number of entries are 4

```

```

VTEP3#show nvo vxlan arp-cache
VXLAN ARP-CACHE Information
=====

```

VNID	Ip-Addr	Mac-Addr	Type	Age-Out	Retries-Left
10	100.100.100.1	0000.1000.1000	Static Remote	----	
10	103.103.103.1	0000.3000.3000	Static Local	----	
10	104.104.104.1	0000.4000.4000	Static Remote	----	
10	200.200.200.1	0000.2000.2000	Static Remote	----	

Total number of entries are 4

Use the `show nvo vxlan nd-cache` command to verify the Neighbor Discovery (ND) cache information on all VTEP nodes. This command displays entries that map IPv6 addresses to MAC addresses within the specified VXLAN VNID network.

```

VTEP1#show nvo vxlan nd-cache
VXLAN ND-CACHE Information
=====

```

VNID	Ip-Addr	Mac-Addr	Type	Age-Out	Retries-Left
10	1000::1	0000.1000.1001	Static Local	----	
10	1003::1	0000.3000.3001	Static Remote	----	
10	1004::1	0000.4000.4001	Static Remote	----	
10	2000::1	0000.2000.2001	Static Remote	----	

Total number of entries are 4

```

VTEP3#show nvo vxlan nd-cache
VXLAN ND-CACHE Information
=====

```

VNID	Ip-Addr	Mac-Addr	Type	Age-Out	Retries-Left
10	1000::1	0000.1000.1001	Static Remote	----	
10	1003::1	0000.3000.3001	Static Local	----	
10	1004::1	0000.4000.4001	Static Remote	----	
10	2000::1	0000.2000.2001	Static Remote	----	

Total number of entries are 4

Network Topology Snippet Configurations

Here are the snippet configurations for all nodes in the given network topology.

VTEP1

```

!
hardware-profile filter vxlan enable
hardware-profile filter vxlan-mh enable
!

```



```
nvo vxlan enable
!
evpn esi hold-time 90
!
evpn vxlan multihoming enable
!
mac vrf VRF1
  rd 1.1.1.1:100
  route-target both 100:100
!
nvo vxlan vtep-ip-global 1.1.1.1
!
nvo vxlan id 10 ingress-replication inner-vid-disabled
  vxlan host-reachability-protocol evpn-bgp VRF1
!
qos enable
!
hardware-profile filter vxlan enable
hardware-profile filter vxlan-mh enable
!
interface po1
  switchport
  evpn multi-homed system-mac 0000.0000.1111
!
interface lo
  ip address 1.1.1.1/32 secondary
!
interface xe7
  channel-group 1 mode active
!
interface xe45
  ip address 10.10.10.1/24
!
interface xe49/2
  ip address 10.10.11.1/24
!
exit
!

router ospf 100
  ospf router-id 1.1.1.1
  bfd all-interfaces
  network 1.1.1.1/32 area 0.0.0.0
  network 10.10.10.0/24 area 0.0.0.0
  network 10.10.11.0/24 area 0.0.0.0
!
router bgp 100
  bgp router-id 1.1.1.1
  neighbor 2.2.2.2 remote-as 100
  neighbor 3.3.3.3 remote-as 100
  neighbor 4.4.4.4 remote-as 100
  neighbor 2.2.2.2 update-source lo
  neighbor 2.2.2.2 advertisement-interval 0
  neighbor 3.3.3.3 update-source lo
  neighbor 3.3.3.3 advertisement-interval 0
  neighbor 4.4.4.4 update-source lo
  neighbor 4.4.4.4 advertisement-interval 0
```

```

!
address-family l2vpn evpn
neighbor 2.2.2.2 activate
neighbor 3.3.3.3 activate
neighbor 4.4.4.4 activate
exit-address-family
!
exit
!
nvo vxlan access-if port-vlan pol 1000
map vnid 10
mac 0000.1000.1000 ip 100.100.100.1
mac 0000.1000.1001 ipv6 1000::1
!

```

VTEP2

```

!
hardware-profile filter vxlan enable
hardware-profile filter vxlan-mh enable
!
nvo vxlan enable
!
evpn esi hold-time 90
!
evpn vxlan multihoming enable
!
mac vrf VRF1
rd 2.2.2.2:100
route-target both 100:100
!
nvo vxlan vtep-ip-global 2.2.2.2
!
nvo vxlan id 10 ingress-replication inner-vid-disabled
vxlan host-reachability-protocol evpn-bgp VRF1
!
qos enable
!
hardware-profile filter vxlan enable
hardware-profile filter vxlan-mh enable
!
interface pol
switchport
evpn multi-homed system-mac 0000.0000.1111
!
interface lo
ip address 2.2.2.2/32 secondary
!
interface xe38
channel-group 1 mode active
!
interface xe49/1
ip address 20.20.20.1/24
!
interface xe50/1
ip address 20.20.21.1/24

```

```

!
exit
!

router ospf 100
ospf router-id 2.2.2.2
bfd all-interfaces
network 2.2.2.2/32 area 0.0.0.0
network 20.20.20.0/24 area 0.0.0.0
network 20.20.21.0/24 area 0.0.0.0
!
router bgp 100
bgp router-id 2.2.2.2
neighbor 1.1.1.1 remote-as 100
neighbor 3.3.3.3 remote-as 100
neighbor 4.4.4.4 remote-as 100
neighbor 1.1.1.1 update-source lo
neighbor 1.1.1.1 advertisement-interval 0
neighbor 3.3.3.3 update-source lo
neighbor 3.3.3.3 advertisement-interval 0
neighbor 4.4.4.4 update-source lo
neighbor 4.4.4.4 advertisement-interval 0
!
address-family l2vpn evpn
neighbor 1.1.1.1 activate
neighbor 3.3.3.3 activate
neighbor 4.4.4.4 activate
exit-address-family
!
exit
!
nvo vxlan access-if port-vlan xe37 1000
map vnid 10
mac 0000.2000.2000 ip 200.200.200.1
mac 0000.2000.2001 ipv6 2000::1
!
nvo vxlan access-if port-vlan po1 1000
map vnid 10
mac 0000.1000.1000 ip 100.100.100.1
mac 0000.1000.1001 ipv6 1000::1
!

```

VTEP3

```

!
hardware-profile filter vxlan enable
hardware-profile filter vxlan-mh enable
!
nvo vxlan enable
!
evpn esi hold-time 90
!
evpn vxlan multihoming enable
!
evpn etree enable
!

```

```
mac vrf VRF1
  rd 3.3.3.3:100
  route-target both 100:100
!
nvo vxlan vtep-ip-global 3.3.3.3
!
nvo vxlan id 10 ingress-replication inner-vid-disabled etree-leaf
  vxlan host-reachability-protocol evpn-bgp VRF1
!
qos enable
!
interface po2
  switchport
  evpn multi-homed system-mac 0000.0000.2222
!
interface lo
  ip address 3.3.3.3/32 secondary
!
interface xe53/1
  ip address 30.30.30.1/24
!
interface xe54/1
  ip address 30.30.31.1/24
!
interface xe55/1
  channel-group 2 mode active
!
exit
!
router ospf 100
  ospf router-id 3.3.3.3
  bfd all-interfaces
  network 3.3.3.3/32 area 0.0.0.0
  network 30.30.30.0/24 area 0.0.0.0
  network 30.30.31.0/24 area 0.0.0.0
!
router bgp 100
  bgp router-id 3.3.3.3
  neighbor 1.1.1.1 remote-as 100
  neighbor 2.2.2.2 remote-as 100
  neighbor 4.4.4.4 remote-as 100
  neighbor 1.1.1.1 update-source lo
  neighbor 1.1.1.1 advertisement-interval 0
  neighbor 2.2.2.2 update-source lo
  neighbor 2.2.2.2 advertisement-interval 0
  neighbor 4.4.4.4 update-source lo
  neighbor 4.4.4.4 advertisement-interval 0
!
  address-family l2vpn evpn
  neighbor 1.1.1.1 activate
  neighbor 2.2.2.2 activate
  neighbor 4.4.4.4 activate
  exit-address-family
!
exit
!
!
```

```
nvo vxlan access-if port-vlan po2 1000
  map vnid 10
  mac 0000.3000.3000 ip 103.103.103.1
  mac 0000.3000.3001 ipv6 1003::1
!
```

VTEP4

```
!
hardware-profile filter vxlan enable
hardware-profile filter vxlan-mh enable
!
nvo vxlan enable
!
evpn esi hold-time 90
!
evpn vxlan multihoming enable
!
evpn etree enable
!
mac vrf VRF1
  rd 4.4.4.4:100
  route-target both 100:100
!
nvo vxlan vtep-ip-global 4.4.4.4
!
nvo vxlan id 10 ingress-replication inner-vid-disabled etree-leaf
  vxlan host-reachability-protocol evpn-bgp VRF1
!
qos enable
!
interface po2
  switchport
  evpn multi-homed system-mac 0000.0000.2222
!
interface lo
  ip address 4.4.4.4/32 secondary
!
interface xe11/1
  ip address 40.40.41.1/24
!
interface xe31/1
  channel-group 2 mode active
!
interface xe33
  ip address 40.40.40.1/24
!
interface xe34
  switchport
!
exit
!
router ospf 100
  ospf router-id 4.4.4.4
  bfd all-interfaces
  network 4.4.4.4/32 area 0.0.0.0
```

```
network 40.40.40.0/24 area 0.0.0.0
network 40.40.41.0/24 area 0.0.0.0
!
router bgp 100
  bgp router-id 4.4.4.4
  neighbor 1.1.1.1 remote-as 100
  neighbor 2.2.2.2 remote-as 100
  neighbor 3.3.3.3 remote-as 100
  neighbor 1.1.1.1 update-source lo
  neighbor 1.1.1.1 advertisement-interval 0
  neighbor 2.2.2.2 update-source lo
  neighbor 2.2.2.2 advertisement-interval 0
  neighbor 3.3.3.3 update-source lo
  neighbor 3.3.3.3 advertisement-interval 0
!
  address-family l2vpn evpn
  neighbor 1.1.1.1 activate
  neighbor 2.2.2.2 activate
  neighbor 3.3.3.3 activate
  exit-address-family
!
exit
!
nvo vxlan access-if port-vlan xe34 1000
  map vnid 10
  mac 0000.4000.4000 ip 104.104.104.1
  mac 0000.4000.4001 ipv6 1004::1
!
nvo vxlan access-if port-vlan po2 1000
  map vnid 10
  mac 0000.3000.3000 ip 103.103.103.1
  mac 0000.3000.3001 ipv6 1003::1
!
```

SPINE1

```
!
qos enable
!
interface ce1/2
  ip address 40.40.40.2/24
!
interface ce1/4
  ip address 10.10.10.2/24
!
interface ce24/1
  ip address 30.30.30.2/24
!
interface ce27/1
  ip address 20.20.20.2/24
!
interface lo
  ip address 5.5.5.5/32 secondary
!
exit
!
```

```
router ospf 100
  ospf router-id 5.5.5.5
  bfd all-interfaces
  network 5.5.5.5/32 area 0.0.0.0
  network 10.10.10.0/24 area 0.0.0.0
  network 20.20.20.0/24 area 0.0.0.0
  network 30.30.30.0/24 area 0.0.0.0
  network 40.40.40.0/24 area 0.0.0.0
!
```

SPINE2

```
!
qos enable
!
interface ce5/1
  ip address 20.20.21.2/24
!
interface ce10/1
  ip address 30.30.31.2/24
!
interface ce11/1
  ip address 40.40.41.2/24
!
interface ce14/2
  ip address 10.10.11.2/24
!
interface lo
  ip address 6.6.6.6/32 secondary
!
exit
!
router ospf 100
  ospf router-id 6.6.6.6
  bfd all-interfaces
  network 6.6.6.6/32 area 0.0.0.0
  network 10.10.11.0/24 area 0.0.0.0
  network 20.20.21.0/24 area 0.0.0.0
  network 30.30.31.0/24 area 0.0.0.0
  network 40.40.41.0/24 area 0.0.0.0
!
```

SWITCH1

```
!
bridge 1 protocol ieee vlan-bridge
!
vlan database
  vlan-reservation 4000-4094
  vlan 1000 bridge 1 state enable
!
interface po1
  switchport
  bridge-group 1
  switchport mode hybrid
  switchport mode hybrid acceptable-frame-type all
```

```

    switchport hybrid allowed vlan add 1000 egress-tagged enable
    !
interface xe46
    channel-group 1 mode active
    !
interface xe47
    channel-group 1 mode active
    !
interface xe57
    switchport
    bridge-group 1
    switchport mode hybrid
    switchport mode hybrid acceptable-frame-type all
    switchport hybrid allowed vlan add 1000 egress-tagged enable
    !
    exit
    !

```

SWITCH2

```

    !
bridge 1 protocol ieee vlan-bridge
    !
vlan database
    vlan-reservation 4000-4094
    vlan 1000 bridge 1 state enable
    !
interface po2
    switchport
    bridge-group 1
    switchport mode hybrid
    switchport mode hybrid acceptable-frame-type all
    switchport hybrid allowed vlan add 1000 egress-tagged enable
    !
interface xe33
    switchport
    bridge-group 1
    switchport mode hybrid
    switchport mode hybrid acceptable-frame-type all
    switchport hybrid allowed vlan add 1000 egress-tagged enable
    !
interface xe49/1
    channel-group 2 mode active
    !
interface xe51/1
    channel-group 2 mode active
    !
    exit
    !

```

Implementation Examples

Here is an example scenario and a solution for implementing EVPN E-Tree.

Scenario 1: Specific traffic isolation and control measures are essential in a network of EVPN L2VPN services or instances. Within a broadcast domain, services communicating with each other may result in flooding BUM traffic to all services within the domain. Moreover, hosts are learned and advertised between different sites/services.

Use Case 1: Implementing an EVPN E-Tree solution defines the network topology with distinct Root and Leaf classifications, BUM traffic flooding can be minimized, and traffic isolation can be achieved. This ensures efficient communication between services while preventing unnecessary traffic propagation and maintaining network integrity.

Scenario 2: An Internet Service Provider (ISP) provides services to multiple subscribers and aims to facilitate communication with them. However, the ISP needs to ensure that subscribers exclusively communicate with the ISP and not among themselves.

Use Case 2: Implementing EVPN E-Tree is essential to fulfill this requirement. By categorizing ISP services as Root and subscribers as Leaf, traffic isolation can be enforced. This configuration enables the ISP to communicate with subscribers while preventing inter-subscriber communication. As a result, network security is enhanced, and the ISP maintains control over communication within its network.

E-Tree CLI Commands

The EVPN E-Tree introduces the following configuration commands in OcnOS.

evpn etree

Use this command to enable E-Tree functionality within the EVPN configuration.

Command Syntax

```
evpn etree enable
```

Parameters

None

Default

Disabled

Command Mode

Configure mode

Applicability

Introduced in OcnOS version 6.5.1.

Example

The following example illustrates how to activate E-Tree functionality for EVPN:

```
OcnOS#configure terminal
OcnOS(config)#evpn etree enable
```

Revised CLI Commands

The following is the revised command for configuring VXLAN EVPN E-Tree

nvo vxlan id

- The existing syntax now includes the newly added parameter for E-Tree, namely `etree-leaf`.
- The command `nvo vxlan id <VNID> ingress-replication inner-vid-disabled etree-leaf` allows users to tailor VXLAN behavior on a network device, specifying VXLAN parameters and indicating its participation as a leaf node in an E-Tree deployment. For more details, refer to the [nvo vxlan id](#) command in the [VXLAN Commands](#) chapter in the *OcNOS VXLAN Guide*.

Troubleshooting

1. When traffic, whether unicast (UC) or broadcast, is passed to the Intra Leaf site:
 - Check the sub-interface or physical interface counters to monitor traffic throughput and potential issues.
 - Verify the Leaf status of the corresponding VNI to ensure proper functionality.
 - Use packet sniffing tools to analyze packets in the egress direction for any anomalies or errors.
 - MAC entries learned via leaf access port should include the `set` keyword in the MAC table output.
2. If UC traffic is routed within inter-PE leaf sites:
 - Check the Leaf status of the VNI at both participating PE devices to confirm operational status.
 - Check if the advertised MAC is in discard or non-discard status using the `show mac table` command and `l2 show` in the BCM shell.
3. Verify if BUM traffic is transmitted between Leaf sites inter-PE:
 - Ensure that a BUM tunnels are not established between inter-PE devices.
 - Validate this by examining the Multicast ingress group, using the `show evpn mpls tunnel` command. For EVPN MPLS, confirm that BUM tunnels are not created.
4. Investigate UC traffic drops from the Root to MH Leaf PE:
 - Check if MAC addresses are not installed in discard status within the MH peer's access port. This status could indicate issues with MAC learning or forwarding.
5. Evaluate traffic between Root and Leaf:
 - Confirm the establishment of both UC and BUM tunnels.
 - Ensure that unicast MAC addresses are not marked with a discard status in the MAC table.
6. Validate the exchange of routes between two BGP L2VPN peers:
 - Monitor BGP (Border Gateway Protocol) sessions to verify successful route exchange and propagation between the peers.
7. Convergence: Assess convergence by checking BFD configuration between BGP sessions.

Glossary

The following provides definitions for key terms or abbreviations and their meanings used throughout this document:

Key Terms/Acronym	Description
EVPN E-Tree (Ethernet VPN Ethernet-Tree)	A networking solution designed to manage communication within broadcast domains, incorporating redundancy through multi-homing in a network. It optimizes traffic routing and control, categorizing network nodes based on predefined definitions of EVPN Instances as Leaf or Root, allowing or restricting communication between them.
Virtual Extensible LAN (VXLAN)	A technology that provides encapsulation techniques to create virtualized Layer 2 networks over Layer 3 infrastructure, facilitating scalable and flexible network designs.
EVPN (Ethernet Virtual Private Network)	A Layer 2 VPN technology that extends Ethernet services across data centers and wide-area networks using BGP.
Multi-homing (MH)	The ability of a device to connect to multiple network segments simultaneously to increase network availability and redundancy.
Provider Edge (PE) Node	A device at the edge of a service provider network that connects to customer premises equipment (CE) and participates in providing services to customers.
Leaf Node	In the context of EVPN E-Tree, a network node categorized to handle communication within specific broadcast domains and may connect to Root nodes.
Root Node	A network node within EVPN E-Tree that serves as the central point of communication and handles BUM traffic distribution.
Ethernet Segment Identifier (ESI)	A unique identifier used to identify Ethernet segments within a VXLAN network.

CHAPTER 12 VxLAN-IRB-Inter-VRF Route Leaking

A VRF is a mechanism used to provide logical separation between routing tables on the same router. It is locally significant to the router. Each interface on a router can only be assigned to one VRF, but a VRF can have multiple interfaces. VRF route leaking can be done using route-target import/export.

The routes of VRF catering shared services shall be leaked to tenant VRFs. The leaking of routes shall be possible over one overlay VRF to another overlay VRF. By doing so shared services like Internet access through gateway routes can be made possible. Introduction of this feature shall cater various use cases of shared services like storage / Internet access etc.

Topology

The procedures in this section use the topology in [Figure 12-12](#).

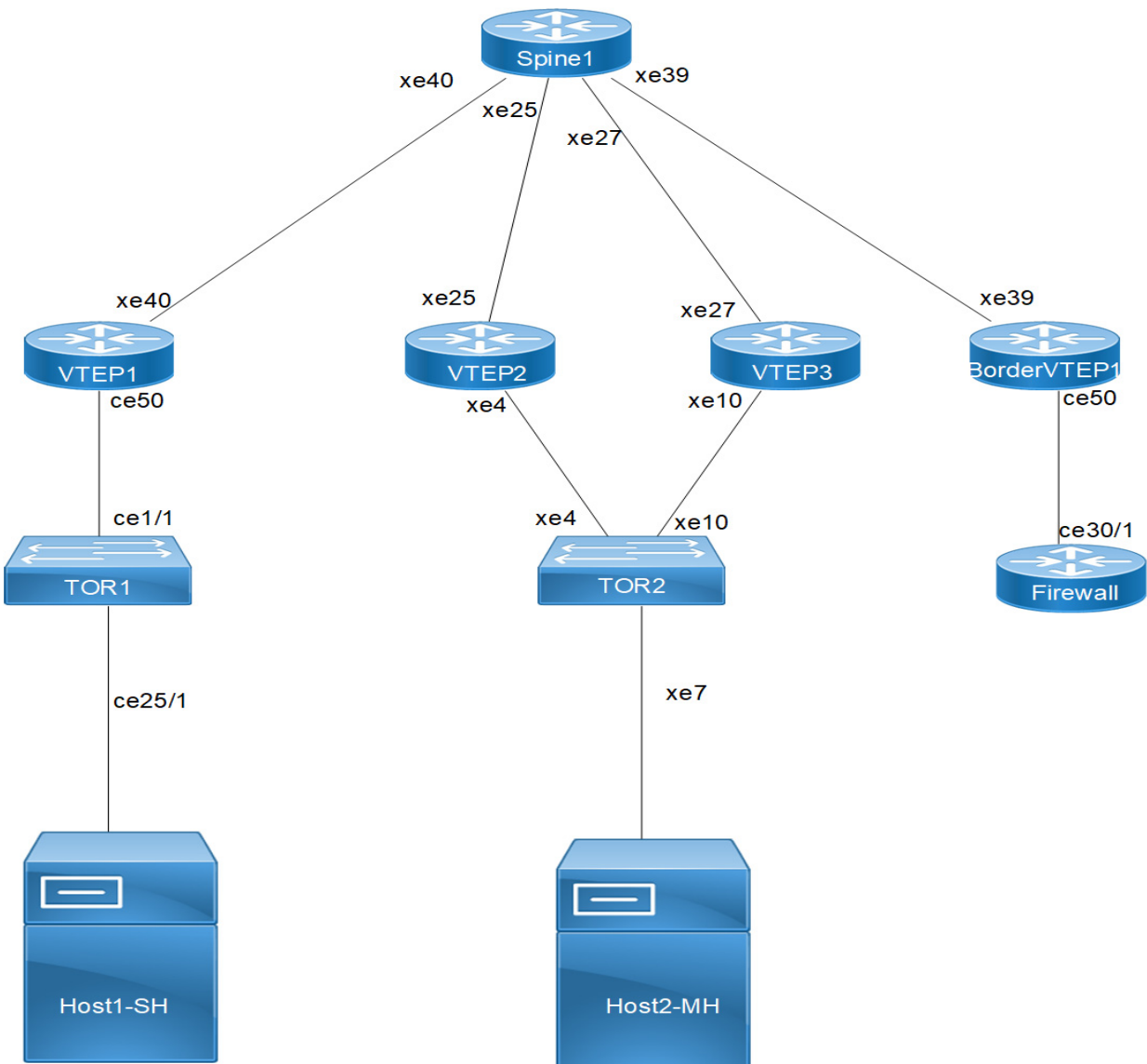

Figure 12-12: VxLAN_EVPN_IVRF

Note: SH means Single homing host and MH means Multihoming host.

VTEP1

Single Home -SH

Hardware profile and generic configuration:

#configure terminal	Enter Configure mode.
(config)#hardware-profile filter vxlan enable	Enable hardware-profile filter for VxLAN.
(config)#hardware-profile filter vxlan-mh enable	Enable hardware-profile filter for VxLAN multi-homing.
(config)#nvo vxlan enable	Enable VxLAN
(config)#nvo vxlan irb	Enable VxLAN irb
(config)#hardware-profile filter egress-ipv4 enable	Enable hardware-profile filter for egress IPv4.
(config)#hardware-profile statistics ac-lif enable	Enable ac-lif for vxlan access-if port counters
(config)#qos enable	Enabling qos
(Config)# bfd interval 3 minrx 3 multiplier 3	Configure bfd
(config)#commit	Commit the candidate configuration to running configuration

Interface and loopback configuration:

(config)#interface ce50	Enter Interface mode for ce50 (SH1)
(config-if)# description ***Connected to TOR1***	Interface description
(config-if)#switchport	Make it L2 interface
(config-if)#exit	Exit Interface mode and return to Configure mode.
(config)#interface lo	Enter Interface mode for lo
(config-if)#ip address 51.51.51.51/32 secondary	Configure loopback ip address
(config-if)#exit	Exit Interface mode and return to Configure mode.
(config) interface xe40	Enter interface mode
(config-if)# description ***Connected to Spine2***	Interface description
(config-if)# ip address 10.10.10.1/31	Configure ip address on network side of Spine1
(config-if)#exit	Exit Interface mode and return to Configure mode.
(config)#commit	Commit the candidate configuration to running configuration

OSPF configuration:

(config)#router ospf 100	Enter into router OSPF mode
(config-router)#ospf router-id 51.51.51.51	Configure router-id as lo ip address

(config-router)#network 51.51.51.51/32 area 0.0.0.0	Add lo ip address network into area 0
(config-router)#network 10.10.10.0/24 area 0.0.0.0	Add Spine-connected network into area 0
(config-router)#bfd all-interfaces	Enabling bfd on all ospf interface for fast convergence
(config-if)#exit	Exit Interface mode and return to Configure mode.
(config)#commit	Commit the candidate configuration to running configuration

BGP configuration:

(config)#router bgp 500	Enter into Router BGP mode
(config-router)#bgp router-id 51.51.51.51	Configure router-id as lo ip address
(config-router)#neighbor 66.66.66.66 remote-as 500	Specify a BorderVTEP1 loopback ip address and remote-as defined
(config-router)#neighbor 66.66.66.66 update-source lo	Configure update as loopback for BorderVTEP1
(config-router)#neighbor 66.66.66.66 advertisement-interval 0	Configure advertisement-interval as 0 for fast convergence for BorderVTEP1
(config-router)# no bgp default ipv4-unicast	It will avoid default ipv4 unicast routing
(config-router)# address-family ipv4 unicast	Enter into IPV4 unicast address family mode
(config-router-af)# neighbor 66.66.66.66 activate	Activate BorderVTEP1 into ipv4 unicast family
(config-router-af)# exit-address-family	Exit from IPV4 unicast address family
(config-router)#address-family l2vpn evpn	Enter into l2vpn EVPN address family mode
(config-router-af)#neighbor 66.66.66.66 activate	Activate BorderVTEP1 into l2vpn evpn address family mode
(config-router-af)#exit-address-family	Exit from l2vpn address family mode
(config-router)#exit	Exit from Router BGP mode and enter into config mode
(config)#commit	Commit the candidate configuration to running configuration

L2 VRF Configuration:

(config)# mac vrf RED	Create mac routing/forwarding instance with RED name and enter into vrf mode
(config-vrf)# rd 2.3.4.5:1	Assign RD value
(config-vrf)# route-target both 6000:6000	Assign route-target value for same for import and export. Should be same on all node for RED
(config-vrf)#exit	Exit from vrf mode
(config)#commit	Commit the candidate configuration to running configuration

L3 VRF and BGP Configuration:

(config)# ip vrf FAX	Create mac routing/forwarding instance with FAX name and enter into vrf mode
(config-vrf)# rd 51.51.51.51:1050	Assign RD value
(config-vrf)# route-target both 1050:1050	Assign route-target value for same for import and export.

(config-vrf)# l3vni 10502	Configure L3VNI as 10502 for FAX vrf
(config-vrf)#exit	Exit from vrf mode
(config)# interface irb 1050	Configure irb interface 1050
(config-if)ip vrf forwarding FAX	Configure FAX
(config-if) ip address 10.12.32.1/24	Configure ip address
(config-if)exit	Exit from interface config mode
(config)#commit	Commit the candidate configuration to running configuration
(config)router bgp 500	Enter into bgp router mode
(config-router)#address-family ipv4 vrf FAX	Enter into address-family mode for FAX
(config-router-af)#redistribute connected	Redistribute connected
(config-router-af)#exit-address-family	Exit form address-family
(config-router)#exit	Exit from router bgp configuration mode
(config)#commit	Commit the candidate configuration to running configuration

VxLAN configuration:

(config)#nvo vxlan vtep-ip-global 51.51.51.51	Configure Source vtep-ip-global configuration. Use loopback ip address
(config)#nvo vxlan id 1050 ingress-replication inner-vid-disabled	Configure VxLAN Network identifier with/without inner-vid-disabled configure and enter into VxLAN tenant mode
(config-nvo)#vxlan host-reachability-protocol evpn-bgp RED	Assign vrf for evpn-bgp to carry EVPN route
(config-nvo)# evpn irb1050	Configure irb1050 under vxlan id 1050
(config)# nvo vxlan access-if port-vlan ce50 1050	Enable port-vlan mapping i.e. access port to outer-vlan (SVLAN)
(config-nvo-acc-if)# map vnid 1050	Map VxLAN Identified to access-port for VxLAN
(config-nvo-acc-if)# mac 0000.3333.1050 ip 10.12.32.10	Configure static mac-ip
(config-nvo-acc-if)#exit	Exit from VxLAN access-interface mode and enter into configuration mode
(config)#commit	Commit the candidate configuration to running configuration

VTEP2

(Multi-homed group) - Part of both Multi-homed with po1000(MH).

Hardware profile and generic configuration:

#configure terminal	Enter Configure mode.
(config)#hardware-profile filter vxlan enable	Enable hardware-profile filter for VxLAN.
(config)#hardware-profile filter vxlan-mh enable	Enable hardware-profile filter for VxLAN multi-homing.
(config)#nvo vxlan enable	Enable VxLAN
(config)#nvo vxlan irb	Enable VxLAN irb

(config)# evpn irb-forwarding anycast-gateway-mac 0000.2222.3333	Configure Anycast gateway mac
(config)#hardware-profile filter egress-ipv4 enable	Enable hardware-profile filter for egress IPv4.
(Config)#hardware-profile statistics ac-lif enable	Enable ac-lif for vxlan access-if port counters
(Config)#qos enable	Enabling qos
(Config)# bfd interval 3 minrx 3 multiplier 3	Configure bfd
(config)#commit	Commit the candidate configuration to running configuration

Interface and loopback configuration:

(config)#interface xe4	Enter Interface mode for xe4(MH)
(config-if)# description ***Connected to TOR2***	Interface description
(config-if)# channel-group 1000 mode active	Make it member of po1000
(config-if)#exit	Exit Interface mode and return to Configure mode.
(config)# interface po1000	Enter into po1000 mode
(config-if)# switchport	Configure L2 mode
(config-if)# evpn multi-homed system-mac 0000.4444.5555	Configure System mac
(config)#interface lo	Enter Interface mode for lo
(config-if)#ip address 60.60.60.60/32	Configure loopback ip address
(config-if)#exit	Exit Interface mode and return to Configure mode.
(config) interface xe25	Enter interface mode
(config-if)# description ***Connected to Spine1***	Interface description
(config-if)# ip address ip address 10.10.12.1/31	Configure ip address on network side of Spine1
(config-if)#exit	Exit Interface mode and return to Configure mode.
(config)#commit	Commit the candidate configuration to running configuration

OSPF configuration:

(config)#router ospf 100	Enter into router OSPF mode
(config-router)#ospf router-id 60.60.60.60	Configure router-id as lo ip address
(config-router)#network 60.60.60.60/32 area 0.0.0.0	Add lo ip address network into area 0
(config-router)#network 10.10.12.0/24 area 0.0.0.0	Add Spine-connected network into area 0
(config-router)#bfd all-interfaces	Enabling bfd on all ospf interface for fast convergence
(config-if)#exit	Exit Interface mode and return to Configure mode.
(config)#commit	Commit the candidate configuration to running configuration

BGP configuration:

(config)#router bgp 500	Enter into Router BGP mode
(config-router)#bgp router-id 60.60.60.60	Configure router-id as lo ip address
(config-router)#neighbor 66.66.66.66 remote-as 500	Specify a BorderVTEP1 loopback ip address and remote-as defined
(config-router)#neighbor 66.66.66.66 update-source lo	Configure update as loopback for BorderVTEP1
(config-router)#neighbor 66.66.66.66 advertisement-interval 0	Configure advertisement-interval as 0 for fast convergence for BorderVTEP1
(config-router)#neighbor 76.76.76.76 remote-as 500	Specify a VTEP3 loopback ip address and remote-as defined
(config-router)#neighbor 76.76.76.76 update-source lo	Configure update as loopback for VTEP3
(config-router)#neighbor 76.76.76.76 advertisement-interval 0	Configure advertisement-interval as 0 for fast convergence for VTEP3
(config-router)# no bgp default ipv4-unicast	It will avoid default ipv4 unicast routing
(config-router)# address-family ipv4 unicast	Enter into IPV4 unicast address family mode
(config-router-af)# neighbor 66.66.66.66 activate	Activate BorderVTEP1 into ipv4 unicast family
(config-router-af)# neighbor 76.76.76.76 activate	Activate VTEP3 into ipv4 unicast family
(config-router-af)# exit-address-family	Exit from IPV4 unicast address family
(config-router)#address-family l2vpn evpn	Enter into l2vpn EVPN address family mode
(config-router-af)#neighbor 66.66.66.66 activate	Activate BorderVTEP1 into l2vpn evpn address family mode
(config-router-af)#neighbor 76.76.76.76 activate	Activate VTEP3 into l2vpn evpn address family mode
(config-router-af)#exit-address-family	Exit from l2vpn address family mode
(config-router)#exit	Exit from Router BGP mode and enter into config mode
(config)#commit	Commit the candidate configuration to running configuration

L2 VRF Configuration:

(config)# mac vrf RED	Create mac routing/forwarding instance with RED name and enter into vrf mode
(config-vrf)# rd 2.3.4.5:2	Assign RD value
(config-vrf)# route-target both 6000:6000	Assign route-target value for same for import and export. Should be same on all node for RED
(config-vrf)#exit	Exit from vrf mode
(config)#commit	Commit the candidate configuration to running configuration

L3 VRF and BGP Configuration:

(config)# ip vrf SMS	Create mac routing/forwarding instance with SMS name and enter into vrf mode
(config-vrf)# rd 60.60.60.60:1040	Assign RD value

(config-vrf)# route-target both 1040:1040	Assign route-target value for same for import and export.
(config-vrf)# l3vni 10402	Configure L3VNI as 10402 for SMS vrf
(config-vrf)#exit	Exit from vrf mode
(config)# interface irb 1060	Configure irb interface 1060
(config-if) ip vrf forwarding SMS	Configure ip vrf forwarding
(config-if) ip address 10.240.38.1/24	Configure ip address
(config-if) evpn irb-if-forwarding anycast-gateway-mac	Anycast mac configured
(config-if)exit	Exit from interface config mode
(config)#commit	Commit the candidate configuration to running configuration
(config)router bgp 500	Enter into bgp router mode
(config-router)#address-family ipv4 vrf SMS	Enter into address-family mode for SMS
(config-router-af)#redistribute connected	Redistribute connected
(config-router-af)#exit-address-family	Exit form address-family
(config)#commit	Commit the candidate configuration to running configuration

VxLAN configuration:

(config)#nvo vxlan vtep-ip-global 60.60.60.60	Configure Source vtep-ip-global configuration. Use loopback ip address
(config)#nvo vxlan id 1060 ingress-replication inner-vid-disabled	Configure VxLAN Network identifier with/without inner-vid-disabled configure and enter into VxLAN tenant mode
(config-nvo)#vxlan host-reachability-protocol evpn-bgp RED	Assign vrf for evpn-bgp to carry EVPN route
(config-nvo)# evpn irb1060	Configure irb1060 under vxlan id 1060
(config)# nvo vxlan access-if port-vlan po1000 1060	Enable port-vlan mapping i.e. access port to outer-vlan (SVLAN) - Multihomed access port
(config-nvo-acc-if)# map vnid 1060	Map VxLAN Identified to access-port for VxLAN
(config-nvo-acc-if)# mac 0000.2222.1060 ip 10.240.38.10	Configure static mac-ip
(config-nvo-acc-if)#exit	Exit from VxLAN access-interface mode and enter into configuration mode
(config)#commit	Commit the candidate configuration to running configuration

VTEP3

(Multi-homed group) - Part of both Multi-homed with po1000(MH).

Hardware profile and generic configuration:

#configure terminal	Enter Configure mode.
(config)#hardware-profile filter vxlan enable	Enable hardware-profile filter for VxLAN.
(config)#hardware-profile filter vxlan-mh enable	Enable hardware-profile filter for VxLAN multi-homing.
(config)#nvo vxlan enable	Enable VxLAN

(config)#nvo vxlan irb	Enable VxLAN irb
(config)#commit	Commit the candidate configuration to running configuration
(config)# evpn irb-forwarding anycast-gateway-mac 0000.2222.3333	Configure Anycast gateway mac
(config)#hardware-profile filter egress-ipv4 enable	Enable hardware-profile filter for egress IPv4.
(config)#hardware-profile statistics ac-lif enable	Enable ac-lif for vxlan access-if port counters
(config)#qos enable	Enabling qos
(config)# bfd interval 3 minrx 3 multiplier 3	Configure bfd
(config)#commit	Commit the candidate configuration to running configuration

Interface and loopback configuration:

(config)#interface xe10	Enter Interface mode for xe10(MH)
(config-if)# description ***Connected to TOR2***	Interface description
(config-if)# channel-group 1000 mode active	Make it member of po1000
(config-if)#exit	Exit Interface mode and return to Configure mode.
(config)# interface po1000	Enter into po1000 mode
(config-if)# switchport	Configure L2 mode
(config-if)# evpn multi-homed system-mac 0000.4444.5555	Configure System mac
(config)#interface lo	Enter Interface mode for lo
(config-if)#ip address 76.76.76.76/32	Configure loopback ip address
(config-if)#exit	Exit Interface mode and return to Configure mode.
(config)#commit	Commit the candidate configuration to running configuration
(config) interface xe27	Enter interface mode
(config-if)# description ***Connected to Spine1***	Interface description
(config-if)# ip address ip address 10.10.24.1/31	Configure ip address on network side of Spine1
(config-if)#exit	Exit Interface mode and return to Configure mode.
(config)#commit	Commit the candidate configuration to running configuration

OSPF configuration:

(config)#router ospf 100	Enter into router OSPF mode
(config-router)#ospf router-id 76.76.76.76	Configure router-id as lo ip address
(config-router)#network 76.76.76.76/32 area 0.0.0.0	Add lo ip address network into area 0
(config-router)#network 10.10.24.0/24 area 0.0.0.0	Add Spine-connected network into area 0
(config-router)#bfd all-interfaces	Enabling bfd on all ospf interface for fast convergence

(config-if)#exit	Exit Interface mode and return to Configure mode.
(config)#commit	Commit the candidate configuration to running configuration

BGP configuration:

(config)#router bgp 500	Enter into Router BGP mode
(config-router)#bgp router-id 76.76.76.76	Configure router-id as lo ip address
(config-router)#neighbor 66.66.66.66 remote-as 500	Specify a BorderVTEP1 loopback ip address and remote-as defined
(config-router)#neighbor 66.66.66.66 update-source lo	Configure update as loopback for BorderVTEP1
(config-router)#neighbor 66.66.66.66 advertisement-interval 0	Configure advertisement-interval as 0 for fast convergence for BorderVTEP1
(config-router)#neighbor 60.60.60.60 remote-as 500	Specify a VTEP2 loopback ip address and remote-as defined
(config-router)#neighbor 60.60.60.60 update-source lo	Configure update as loopback for VTEP2
(config-router)#neighbor 60.60.60.60 advertisement-interval 0	Configure advertisement-interval as 0 for fast convergence for VTEP2
(config-router)# no bgp default ipv4-unicast	It will avoid default ipv4 unicast routing
(config-router)# address-family ipv4 unicast	Enter into IPV4 unicast address family mode
(config-router-af)# neighbor 66.66.66.66 activate	Activate BorderVTEP1 into ipv4 unicast family
(config-router-af)# neighbor 60.60.60.60 activate	Activate VTEP2 into ipv4 unicast family
(config-router-af)# exit-address-family	Exit from IPV4 unicast address family
(config-router)#address-family l2vpn evpn	Enter into l2vpn EVPN address family mode
(config-router-af)#neighbor 66.66.66.66 activate	Activate BorderVTEP1 into l2vpn evpn address family mode
(config-router-af)#neighbor 60.60.60.60 activate	Activate VTEP2 into l2vpn evpn address family mode
(config-router-af)#exit-address-family	Exit from l2vpn address family mode
(config-router)#exit	Exit from Router BGP mode and enter into config mode
(config)#commit	Commit the candidate configuration to running configuration

L2 VRF Configuration:

(config)# mac vrf RED	Create mac routing/forwarding instance with RED name and enter into vrf mode
(config-vrf)# rd 2.3.4.6:2	Assign RD value
(config-vrf)# route-target both 6000:6000	Assign route-target value for same for import and export. Should be same on all node for RED
(config-vrf)#exit	Exit from vrf mode
(config)#commit	Commit the candidate configuration to running configuration

L3 VRF and BGP Configuration:

(config)# ip vrf SMS	Create mac routing/forwarding instance with SMS name and enter into vrf mode
(config-vrf)# rd 76.76.76.76:1040	Assign RD value
(config-vrf)# route-target both 1040:1040	Assign route-target value for same for import and export.
(config-vrf)# l3vni 10402	Configure L3VNI as 10402 for SMS vrf
(config-vrf)#exit	Exit from vrf mode
(config)# interface irb 1060	Configure irb interface 1060
(config-if)ip vrf forwarding SMS	Configure ip vrf forwarding
(config-if) ip address 10.240.38.1/24	Configure ip address
(config-if) evpn irb-if-forwarding anycast-gateway-mac	Anycast mac configured
(config-if)exit	Exit from interface config mode
(config)#commit	Commit the candidate configuration to running configuration
(config)router bgp 500	Enter into bgp router mode
(config-router)#address-family ipv4 vrf SMS	Enter into address-family mode for SMS
(config-router-af)#redistribute connected	Redistribute connected
(config-router-af)#exit-address-family	Exit form address-family
(config)#commit	Commit the candidate configuration to running configuration

VxLAN configuration:

(config)#nvo vxlan vtep-ip-global 76.76.76.76	Configure Source vtep-ip-global configuration. Use loopback ip address
(config)#nvo vxlan id 1060 ingress-replication inner-vid-disabled	Configure VxLAN Network identifier with/without inner-vid-disabled configure and enter into VxLAN tenant mode
(config-nvo)#vxlan host-reachability-protocol evpn-bgp RED	Assign vrf for evpn-bgp to carry EVPN route
(config-nvo)# evpn irb1060	Configure irb1060 under vxlan id 1060
(config)# nvo vxlan access-if port-vlan po1000 1060	Enable port-vlan mapping i.e. access port to outer-vlan (SVLAN) - Multihomed access port
(config-nvo-acc-if)# map vnid 1060	Map VxLAN Identified to access-port for VxLAN
(config-nvo-acc-if)# mac 0000.2222.1060 ip 10.240.38.10	Configure static mac-ip
(config-nvo-acc-if)#exit	Exit from VxLAN access-interface mode and enter into configuration mode
(config)#commit	Commit the candidate configuration to running configuration

BorderVTEP1**Hardware profile and generic configuration:**

#configure terminal	Enter Configure mode.
(config)#hardware-profile filter vxlan enable	Enable hardware-profile filter for VxLAN.

(config)#hardware-profile filter vxlan-mh enable	Enable hardware-profile filter for VxLAN multi-homing.
(config)#nvo vxlan enable	Enable VxLAN
(config)#nvo vxlan irb	Enable VxLAN irb
(config)#hardware-profile filter egress-ipv4 enable	Enable hardware-profile filter for egress IPv4.
(Config)#hardware-profile statistics ac-lif enable	Enable ac-lif for vxlan access-if port counters
(Config)#qos enable	Enabling qos
(Config)# bfd interval 3 minrx 3 multiplier 3	Configure bfd
(config)#commit	Commit the candidate configuration to running configuration

Interface and loopback configuration:

(config)#interface ce50	Enter Interface mode
(config-if)# description ***Connected to FW***	Interface description
(config-if)# switchport	Configure L2 mode
(config)#interface lo	Enter Interface mode for lo
(config-if)#ip address 66.66.66.66/32	Configure loopback ip address
(config-if)#exit	Exit Interface mode and return to Configure mode.
(config) interface xe39	Enter interface mode
(config-if)# description ***Connected to Spine1***	Interface description
(config-if)# ip address ip address 10.10.14.1/31	Configure ip address on network side of Spine1
(config-if)#exit	Exit Interface mode and return to Configure mode.
(config)#commit	Commit the candidate configuration to running configuration

OSPF configuration:

(config)#router ospf 100	Enter into router OSPF mode
(config-router)#ospf router-id 66.66.66.66	Configure router-id as lo ip address
(config-router)#network 66.66.66.66/32 area 0.0.0.0	Add lo ip address network into area 0
(config-router)#network 10.10.24.0/24 area 0.0.0.0	Add Spine-connected network into area 0
(config-router)#bfd all-interfaces	Enabling bfd on all ospf interface for fast convergence
(config-if)#exit	Exit Interface mode and return to Configure mode.
(config)#commit	Commit the candidate configuration to running configuration

BGP configuration:

(config)#router bgp 500	Enter into Router BGP mode
(config-router)#bgp router-id 66.66.66.66	Configure router-id as lo ip address

(config-router)#neighbor 51.51.51.51 remote-as 500	Specify a VTEP1 loopback ip address and remote-as defined
(config-router)#neighbor 51.51.51.51 update-source lo	Configure update as loopback for VTEP1
(config-router)#neighbor 51.51.51.51 advertisement-interval 0	Configure advertisement-interval as 0 for fast convergence for VTEP1
(config-router)#neighbor 60.60.60.60 remote-as 500	Specify a VTEP2 loopback ip address and remote-as defined
(config-router)#neighbor 60.60.60.60 update-source lo	Configure update as loopback for VTEP2
(config-router)#neighbor 60.60.60.60 advertisement-interval 0	Configure advertisement-interval as 0 for fast convergence for VTEP2
(config-router)#neighbor 76.76.76.76 remote-as 500	Specify a VTEP3 loopback ip address and remote-as defined
(config-router)#neighbor 76.76.76.76 update-source lo	Configure update as loopback for VTEP3
(config-router)#neighbor 76.76.76.76 advertisement-interval 0	Configure advertisement-interval as 0 for fast convergence for VTEP3
(config-router)# no bgp default ipv4-unicast	It will avoid default ipv4 unicast routing
(config-router)# address-family ipv4 unicast	Enter into IPV4 unicast address family mode
(config-router-af)# neighbor 51.51.51.51 activate	Activate VTEP1 into ipv4 unicast family
(config-router-af)# neighbor 60.60.60.60 activate	Activate VTEP2 into ipv4 unicast family
(config-router-af)# neighbor 76.76.76.76 activate	Activate VTEP3 into ipv4 unicast family
(config-router-af)# exit-address-family	Exit from IPV4 unicast address family
(config-router)#address-family l2vpn evpn	Enter into l2vpn EVPN address family mode
(config-router-af)#neighbor 51.51.51.51 activate	Activate VTEP1 into l2vpn evpn address family mode
(config-router-af)#neighbor 60.60.60.60 activate	Activate VTEP2 into l2vpn evpn address family mode
(config-router-af)#neighbor 76.76.76.76 activate	Activate VTEP3 into l2vpn evpn address family mode
(config-router-af)#exit-address-family	Exit from l2vpn address family mode
(config-router)#exit	Exit from Router BGP mode and enter into config mode
(config)#commit	Commit the candidate configuration to running configuration

L2 VRF Configuration:

(config)# mac vrf RED	Create mac routing/forwarding instance with RED name and enter into vrf mode
(config-vrf)# rd 2.2.4.4:4	Assign RD value
(config-vrf)# route-target both 6000:6000	Assign route-target value for same for import and export. Should be same on all node for RED
(config-vrf)#exit	Exit from vrf mode
(config)#commit	Commit the candidate configuration to running configuration

L3 VRF and BGP Configuration:

(config)# ip vrf gvrif	Create mac routing/forwarding instance with gvrif name and enter into vrf mode
(config-vrf)# rd 4.5.6.8:6	Assign RD value
(config-vrf)# route-target import 100:100	Assign route-target value for import from FAX vrf
(config-vrf)# route-target import 300:300	Assign route-target value for import from SMS vrf
(config-vrf)# route-target export 1000:1000	Assign route-target value for export from gvrif
(config-vrf)# l3vni 500	Configure L3VNI as 500 for gvrif vrf
(config-vrf)#exit	Exit from vrf mode
(config)# interface irb 1067	Configure irb interface 1060
(config-if) ip vrf forwarding gvrif	Configure ip vrf forwarding
(config-if) ip address 10.10.18.1/24	
	Configure ip address
(config-if)exit	Exit from interface config mode
(config)# ip vrf FAX	Create mac routing/forwarding instance with FAX name and enter into vrf mode
(config-vrf)# rd 66.66.66.66:1050	Assign RD value
(config-vrf)# route-target both 1050:1050	Assign route-target value for same for import and export.
(config-vrf)# route-target export 100:100	Assign route-target value export from FAX
(config-vrf)# route-target import 1000:1000	Assign route-target value for import from gvrif
(config-vrf)# l3vni 10502	Configure L3VNI as 10502 for FAX vrf
(config-vrf)#exit	Exit from vrf mode
(config)# ip vrf SMS	Create mac routing/forwarding instance with SMS name and enter into vrf mode
(config-vrf)# rd 66.66.66.66:1060	Assign RD value
(config-vrf)# route-target both 1040:1040	Assign route-target value for same for import and export.
(config-vrf)# route-target export 300:300	Assign route-target value export from SMS
(config-vrf)# route-target import 1000:1000	Assign route-target value for import from gvrif
(config-vrf)# l3vni 10402	Configure L3VNI as 10402 for SMS vrf
(config-vrf)#exit	Exit from vrf mode
(config)router bgp 500	Enter into bgp router mode
(config-router)#address-family ipv4 vrf gvrif	Enter into address-family mode for gvrif
(config-router-af)#redistribute connected	Redistribute connected
(config-router-af)# neighbor 10.10.18.2 remote-as 64603	Add Firewall as neighbor
(config-router-af)# neighbor 10.10.18.2 fall-over bfd	Configure bfd for better convergence
(config-router-af)# neighbor 10.10.18.2 activate	Activate the neighbor
(config-router-af)# neighbor 10.10.18.2 advertisement-interval 0	Configure interval 0 for better convergence
(config-router-af)#exit-address-family	Exit form address-family

(config-router)#exit	Exit router mode.
(config)#commit	Commit the candidate configuration to running configuration

VxLAN configuration:

(config)#nvo vxlan vtep-ip-global 66.66.66.66	Configure Source vtep-ip-global configuration. Use loopback ip address
(config)# nvo vxlan id 1067 ingress- replication inner-vid-disabled	Configure VxLAN Network identifier with/without inner-vid- disabled configure and enter into VxLAN tenant mode
(config-nvo)#vxlan host-reachability- protocol evpn-bgp RED	Assign vrf for evpn-bgp to carry EVPN route
(config-nvo)# evpn irb1067	Configure irb1067 under vxlan id 1067
(config)# nvo vxlan access-if port-vlan ce50 1067	Enable port-vlan mapping i.e. access port to outer-vlan (SVLAN) - Multihomed access port
(config-nvo-acc-if)# map vnid 1067	Map VxLAN Identified to access-port for VxLAN
(config-nvo-acc-if)#exit	Exit from VxLAN access-interface mode and enter into configuration mode
(config)#commit	Commit the candidate configuration to running configuration

Firewall**Hardware profile and generic configuration:**

#configure terminal	Enter Configure mode.
(Config)#qos enable	Enabling qos
(Config)#bfd interval 3 minrx 3 multiplier 3	Configure bfd
(config)#commit	Commit the candidate configuration to running configuration

Interface and loopback configuration:

#configure terminal	Enter Configure mode.
(config)# bridge 1 protocol rstp vlan-bridge	Configure rstp vlan bridge
(config)# vlan database	
(config)#vlan 1067 bridge 1 state enable	Configure vlans from 1067 and associate with bridge 1
(config)#interface ce30/1	Enter Interface mode for ce30/1
(config-if)# description ***Connected to BorderVTEP1***	Interface description
(config-if)#bridge-group 1	Associate to bridge 1
(config-if)# bridge-group 1 spanning-tree disable	Configure stp disable
(config-if)# switchport mode trunk	Mode as trunk
(config-if)# switchport trunk allowed vlan add 1067	Trunk allowed vlan as 1067
(config-if)#exit	Exit Interface mode and return to Configure mode.
(config)#interface vlan1.1067	Enter Interface mode
(config-if)# ip address 10.10.18.2/24	Configure ip address

(config-if)#exit	Exit Interface mode and return to Configure mode.
(config)#interface ce1/1	Enter Interface mode
(config-if)#ip address 10.10.20.1/24	Configure ip address to advertise
(config-if)#exit	Exit Interface mode and return to Configure mode.
(config)#commit	Commit the candidate configuration to running configuration

BGP configuration:

(Config)#router bgp 64603	Enter into Router BGP mode
(config-router)# neighbor 10.10.18.1 remote-as 500	Specify a BorderVTEP1 gvrf ip address and remote-as defined
(config-router)# neighbor 10.10.18.1 fall-over bfd	Configure fall-over bfd for fast convergence
(config-router)#neighbor 10.10.18.1 advertisement-interval 0	Configure advertisement-interval as 0 for fast convergence
(config-router)# address-family ipv4 unicast	Enter into IPV4 unicast address family mode
(config-router-af)# network 10.10.20.0/24	Add lo adders as network for advertise
(config-router-af)# max-paths ebgp 8	Add max path
(config-router-af)# neighbor 10.10.18.1 default-originate	Do default originate
(config-router-af)# exit-address-family	Exit from IPV4 unicast address family
(config-router)#exit	
(config)#commit	Commit the candidate configuration to running configuration

TOR1 (SH)

#configure terminal	Enter Configure mode.
(config)# bridge 1 protocol rstp vlan-bridge	Configure rstp vlan bridge
(config)# vlan database	
(config)#vlan 1050 bridge 1 state enable	Configure vlans from 1050 and associate with bridge 1
(config)#interface ce1/1	Enter Interface mode for ce1/1
(config-if)#switchport	Make as L2 port by configuring switchport
(config-if)#bridge-group 1	Associate to bridge 1
(config-if)# bridge-group 1 spanning-tree disable	Configure stp disable
(config-if)# switchport mode trunk	Mode as trunk
(config-if)# switchport trunk allowed vlan add 1050	Trunk allowed vlan as 1050
(config-if)#exit	Exit Interface mode and return to Configure mode.
(config)#interface ce25/1	Enter Interface mode for ce25/1
(config-if)#switchport	Make as L2 port by configuring switchport
(config-if)#bridge-group 1	Associate to bridge 1
(config-if)# bridge-group 1 spanning-tree disable	Configure stp disable

(config-if)# switchport mode trunk	Mode as trunk
(config-if)# switchport trunk allowed vlan add 1050	Trunk allowed vlan as 1050
(config-if)#exit	Exit Interface mode and return to Configure mode.
(config)#commit	Commit the candidate configuration to running configuration

TOR2 (MH)

Multihomed to 2-VTEPs (VTEP2 and VTEP3).

#configure terminal	Enter Configure mode.
(config)# bridge 1 protocol rstp vlan-bridge	Configure rstp vlan bridge
(config)# vlan database	
(config)#vlan 1060 bridge 1 state enable	Configure vlans from 1060 and associate with bridge 1
(config)#interface po1000	Enter Interface mode for po1000
(config-if)#switchport	Make as L2 port by configuring switchport
(config-if)#bridge-group 1	Associate to bridge 1
(config-if)# bridge-group 1 spanning-tree disable	Configure stp disable
(config-if)# switchport mode trunk	Mode as trunk
(config-if)# switchport trunk allowed vlan add 1060	Trunk allowed vlan as 1060
(config-if)#exit	Exit Interface mode and return to Configure mode.
(config)#interface xe4	Enter Interface mode for xe4
(config-if)# channel-group 1000 mode active	Make it member of po1000
(config-if)#exit	Exit Interface mode and return to Configure mode.
(config)#interface xe7	Enter Interface mode for xe7
(config-if)# channel-group 1000 mode active	Make it member of po1000
(config-if)#exit	Exit Interface mode and return to Configure mode.
(config)#interface xe7	Enter Interface mode for ce25/1
(config-if)#switchport	Make as L2 port by configuring switchport
(config-if)#bridge-group 1	Associate to bridge 1
(config-if)# bridge-group 1 spanning-tree disable	Configure stp disable
(config-if)# switchport mode trunk	Mode as trunk
(config-if)# switchport trunk allowed vlan add 1060	Trunk allowed vlan as 1060
(config-if)#exit	Exit Interface mode and return to Configure mode.
(config)#commit	Commit the candidate configuration to running configuration

Spine1

Spine node where all VTEPs are connected.

Generic configuration:

#configure terminal	Enter Configure mode.
(Config)#qos enable	Enabling qos
(Config)# bfd interval 3 minrx 3 multiplier 3	Configure bfd
(config)#commit	Commit the candidate configuration to running configuration

Interface and loopback configuration:

(config)#interface lo	Enter Interface mode for lo
(config-if)#ip address 62.62.62.62/32 secondary	Configure loopback ip address
(config-if)#exit	Exit Interface mode and return to Configure mode.
(config)#interface xe40	Enter Interface mode
(config-if)# description ***Connected to VTEP1***	Description of interface
(config-if)#ip address ip address 10.10.10.2/31	Configure ip address on network side of VTEP1
(config-if)#exit	Exit Interface mode and return to Configure mode.
(config)#interface xe25	Enter Interface mode
(config-if)# description ***Connected to VTEP2***	Description of interface
(config-if)#ip address ip address 10.10.12.2/31	Configure ip address on network side of VTEP2
(config-if)#exit	Exit Interface mode and return to Configure mode.
(config)#interface xe27	Enter Interface mode
(config-if)# description ***Connected to VTEP3***	Description of interface
(config-if)#ip address ip address 10.10.24.2/31	Configure ip address on network side of VTEP3
(config-if)#exit	Exit Interface mode and return to Configure mode.
(config)#interface xe39	Enter Interface mode
(config-if)# description ***Connected to BorderVTEP1***	Description of interface
(config-if)#ip address ip address 10.10.14.2/31	Configure ip address on network side of BorderVTEP1
(config-if)#exit	Exit Interface mode and return to Configure mode.
(config)#commit	Commit the candidate configuration to running configuration

OSPF configuration:

(config)#router ospf 100	Enter into router OSPF mode
(config-router)#ospf router-id 62.62.62.62	Configure router-id as lo ip address
(config-router)#network 62.62.62.62/32 area 0.0.0.0	Add lo ip address network into area 0

(config-router)#network 10.10.10.0/24 area 0.0.0.0	Add VTEP1 network into area 0
(config-router)#network 10.10.12.0/24 area 0.0.0.0	Add VTEP2 network into area 0
(config-router)#network 10.10.14.0/24 area 0.0.0.0	Add VTEP4 network into area 0
(config-router)#bfd all-interfaces	Enabling bfd on all ospf interface for fast convergence
(config-if)#exit	Exit Interface mode and return to Configure mode.
(config)#commit	Commit the candidate configuration to running configuration

Validations

Firewall

=====

```
Firewall#show ip bgp summary
BGP router identifier 10.10.19.2, local AS number 64603
BGP table version is 3
2 BGP AS-PATH entries
0 BGP community entries
8 Configured ebgp ECMP multipath: Currently set at 8
```

Neighbor	V	AS	MsgRcv	MsgSen	TblVer	InQ	OutQ	Up/Dow
n State/PfxRcd								
10.10.18.1	4	500	46	58	3	0	0	00:17:36
	3							

Total number of neighbors 1

Total number of Established sessions 1

```
Firewall#show ip roy
Firewall#show ip route vrf all
Codes: K - kernel, C - connected, S - static, R - RIP, B - BGP
O - OSPF, IA - OSPF inter area
N1 - OSPF NSSA external type 1, N2 - OSPF NSSA external type 2
E1 - OSPF external type 1, E2 - OSPF external type 2
i - IS-IS, L1 - IS-IS level-1, L2 - IS-IS level-2,
ia - IS-IS inter area, E - EVPN,
v - vrf leaked
* - candidate default
```

IP Route Table for VRF "default"

```
C      10.10.18.0/24 is directly connected, vlan1.1067, 00:19:40
C      10.10.20.0/24 is directly connected, ce1/1, 00:00:13
B      10.12.32.0/24 [20/0] via 10.10.18.1, vlan1.1067, 00:17:43
B      10.240.38.0/24 [20/0] via 10.10.18.1, vlan1.1067, 00:17:43
C      127.0.0.0/8 is directly connected, lo, 00:52:18
```

IP Route Table for VRF "management"

```
C      10.12.85.0/24 is directly connected, eth0, 00:52:07
C      127.0.0.0/8 is directly connected, lo.management, 00:52:18
```

Gateway of last resort is not set
FW#

BorderVTEP1
=====

BorderVTEP1#show nvo vxlan
VxLAN Information
=====

Codes: NW - Network Port
AC - Access Port
(u) - Untagged

VNID	VNI-Name	VNI-Type	Type	Interface	ESI	VLAN	DF-Status
Src-Addr	Dst-Addr						
1067	----	--	AC	ce50	---	Single Homed Port	----
10402	----	L3	NW	----	----		----
66.66.66.66	60.60.60.60						
10402	----	L3	NW	----	----		----
66.66.66.66	76.76.76.76						
10502	----	L3	NW	----	----		----
66.66.66.66	51.51.51.51						

Total number of entries are 4
BorderVTEP1#show nvo vxlan tunnel
VxLAN Network tunnel Entries

Source	Destination	Status	Up/Down	Update
66.66.66.66	51.51.51.51	Installed	00:22:36	00:22:36
66.66.66.66	60.60.60.60	Installed	00:22:36	00:22:36
66.66.66.66	76.76.76.76	Installed	00:22:36	00:22:36

Total number of entries are 3
BorderVTEP1#show ip route vrf all
Codes: K - kernel, C - connected, S - static, R - RIP, B - BGP
O - OSPF, IA - OSPF inter area
N1 - OSPF NSSA external type 1, N2 - OSPF NSSA external type 2
E1 - OSPF external type 1, E2 - OSPF external type 2
i - IS-IS, L1 - IS-IS level-1, L2 - IS-IS level-2,
ia - IS-IS inter area, E - EVPN,
v - vrf leaked
* - candidate default

IP Route Table for VRF "default"
O 10.10.10.0/31 [110/2] via 10.10.14.0, xe39, 00:22:44
O 10.10.12.0/31 [110/2] via 10.10.14.0, xe39, 00:22:44
C 10.10.14.0/31 is directly connected, xe39, 00:23:29
O 10.10.24.0/31 [110/2] via 10.10.14.0, xe39, 00:22:44

```

O          51.51.51.51/32 [110/3] via 10.10.14.0, xe39, 00:22:44
O          60.60.60.60/32 [110/3] via 10.10.14.0, xe39, 00:22:44
C          66.66.66.66/32 is directly connected, lo, 00:23:32
O          76.76.76.76/32 [110/3] via 10.10.14.0, xe39, 00:22:44
C          127.0.0.0/8 is directly connected, lo, 00:24:12
IP Route Table for VRF "management"
C          10.12.86.0/24 is directly connected, eth0, 00:23:38
C          127.0.0.0/8 is directly connected, lo.management, 00:24:12
IP Route Table for VRF "gvrf"
Gateway of last resort is 10.10.18.2 to network 0.0.0.0

B*         0.0.0.0/0 [20/0] via 10.10.18.2, irb1067, 00:21:31
C          10.10.18.0/24 is directly connected, irb1067, 00:23:30
B          10.10.20.0/24 [20/0] via 10.10.18.2, irb1067, 00:04:01
B v        10.12.32.0/24 [200/0] via 51.51.51.51 (recursive is directly connected,
tunvxlan3), 00:22:39
B v        10.240.38.0/24 [200/0] via 60.60.60.60 (recursive is directly connected,
tunvxlan4), 00:22:40
C          127.0.0.0/8 is directly connected, lo.gvrf, 00:23:36
IP Route Table for VRF "SMS"
Gateway of last resort is 10.10.18.2 to network 0.0.0.0

B* v       0.0.0.0/0 [20/0] via 10.10.18.2, irb1067, 00:21:31
B v        10.10.18.0/24 [20/0] is directly connected, irb1067, 00:23:30
B v        10.10.20.0/24 [20/0] via 10.10.18.2, irb1067, 00:04:01
B          10.240.38.0/24 [200/0] via 60.60.60.60 (recursive is directly connected,
tunvxlan4), 00:22:40
B          60.60.60.60/32 [0/0] is directly connected, tunvxlan4, 00:22:39
B          76.76.76.76/32 [0/0] is directly connected, tunvxlan4, 00:22:39
C          127.0.0.0/8 is directly connected, lo.SMS, 00:23:35
IP Route Table for VRF "FAX"
Gateway of last resort is 10.10.18.2 to network 0.0.0.0

B* v       0.0.0.0/0 [20/0] via 10.10.18.2, irb1067, 00:21:31
B v        10.10.18.0/24 [20/0] is directly connected, irb1067, 00:23:30
B v        10.10.20.0/24 [20/0] via 10.10.18.2, irb1067, 00:04:01
B          10.12.32.0/24 [200/0] via 51.51.51.51 (recursive is directly connected,
tunvxlan3), 00:22:39
B          51.51.51.51/32 [0/0] is directly connected, tunvxlan3, 00:22:39
C          127.0.0.0/8 is directly connected, lo.FAX, 00:23:35
IP Route Table for VRF "SMM"
C          127.0.0.0/8 is directly connected, lo.SMM, 00:23:35

Gateway of last resort is not set
BorderVTEP1# show bgp l2vpn evpn summary
BGP router identifier 66.66.66.66, local AS number 500
BGP table version is 6
2 BGP AS-PATH entries
0 BGP community entries

```

Neighbor PfxRcd	AD	MACIP	V MCAST	AS	MsgRcv ESI	MsgSen PREFIX-ROUTE	TblVer	InQ	OutQ	Up/Down	State/
51.51.51.51			4	500	62	71	6	0	0	00:22:50	
7 0	5		1	0	1						
60.60.60.60			4	500	65	71	6	0	0	00:22:50	
8 2	3		1	1	1						
76.76.76.76			4	500	65	70	6	0	0	00:22:50	
9 2	4		1	1	1						

Total number of neighbors 3

Total number of Established sessions 3

BorderVTEP1# show bgp l2vpn evpn

BGP table version is 6, local router ID is 66.66.66.66

Status codes: s suppressed, d damped, h history, * valid, > best, i - internal, l - labeled, S Stale

Origin codes: i - IGP, e - EGP, ? - incomplete

[EVPN route type]:[ESI]:[VNID]:[relevent route informantion]

- 1 - Ethernet Auto-discovery Route
- 2 - MAC/IP Route
- 3 - Inclusive Multicast Route
- 4 - Ethernet Segment Route
- 5 - Prefix Route

Network Encap	Next Hop	Metric	LocPrf	Weight	Path	Peer
---------------	----------	--------	--------	--------	------	------

RD[2.2.4.4:4] VRF[RED]:

* i [1]:[00:00:00:44:44:55:55:00:00:00]:[1060]:[1060]	76.76.76.76	0	100	0	i 76.76.76.76	VxLAN
* i [1]:[00:00:00:44:44:55:55:00:00:00]:[4294967295]:[0]	60.60.60.60	0	100	0	i 60.60.60.60	VxLAN
* i [2]:[0]:[1050]:[48,0000:0e8d:561a]:[0]:[1050]	76.76.76.76	0	100	0	i 76.76.76.76	VxLAN
* i [2]:[0]:[1050]:[48,0000:0e8d:561a]:[32,10.12.32.11]:[1050]	60.60.60.60	0	100	0	i 60.60.60.60	VxLAN
* i [2]:[0]:[1050]:[48,0000:3333:1050]:[32,10.12.32.10]:[1050]	51.51.51.51	0	100	0	i 51.51.51.51	VxLAN
* i [2]:[0]:[1050]:[48,0000:0e8d:561a]:[32,10.12.32.11]:[1050]	51.51.51.51	0	100	0	i 51.51.51.51	VxLAN
* i [2]:[0]:[1050]:[48,3c2c:99d6:167a]:[128,2401::1]:[1050]	51.51.51.51	0	100	0	i 51.51.51.51	VxLAN
* i [2]:[00:00:00:44:44:55:55:00:00:00]:[1060]:[48,0000:0e8d:5619]:[0]:[1060]	51.51.51.51	0	100	0	i 51.51.51.51	VxLAN
* i [2]:[00:00:00:44:44:55:55:00:00:00]:[1060]:[48,0000:2222:1060]:[32,10.240.38.10]:[1060]	76.76.76.76	0	100	0	i 76.76.76.76	VxLAN
* i [2]:[00:00:00:44:44:55:55:00:00:00]:[1060]:[48,0000:2222:3333]:[32,10.240.38.1]:[1060]	76.76.76.76	0	100	0	i 76.76.76.76	VxLAN
* i [2]:[00:00:00:44:44:55:55:00:00:00]:[1060]:[48,0000:2222:1060]:[32,10.240.38.10]:[1060]	60.60.60.60	0	100	0	i 60.60.60.60	VxLAN
* i [2]:[0]:[1060]:[48,0000:2222:3333]:[32,10.240.38.1]:[1060]	60.60.60.60	0	100	0	i 60.60.60.60	VxLAN

```

76.76.76.76      0      100      0      i  76.76.76.76      VxLAN
* i      60.60.60.60      0      100      0      i  60.60.60.60      VxLAN
* i  [2]:[0]:[1060]:[48,0000:2222:3333]:[128,1601::1]:[1060]
76.76.76.76      0      100      0      i  76.76.76.76      VxLAN
* i      60.60.60.60      0      100      0      i  60.60.60.60      VxLAN
*>  [2]:[0]:[1067]:[48,3c2c:991c:dc7a]:[32,10.10.18.1]:[1067]
66.66.66.66      0      100      32768      i  -----
VxLAN
*>  [2]:[0]:[1067]:[48,a82b:b5cf:f806]:[32,10.10.18.2]:[1067]
66.66.66.66      0      100      32768      i  -----
VxLAN
* i  [3]:[1050]:[32,51.51.51.51]
51.51.51.51      0      100      0      i  51.51.51.51      VxLAN
* i  [3]:[1060]:[32,60.60.60.60]
60.60.60.60      0      100      0      i  60.60.60.60      VxLAN
* i  [3]:[1060]:[32,76.76.76.76]
76.76.76.76      0      100      0      i  76.76.76.76      VxLAN
*>  [3]:[1067]:[32,66.66.66.66]
66.66.66.66      0      100      32768      i  -----
VxLAN

RD[2.3.4.5:1]
*>i  [2]:[0]:[1050]:[48,0000:0e8d:561a]:[0]:[1050]
51.51.51.51      0      100      0      i  51.51.51.51      VxLAN
*>i  [2]:[0]:[1050]:[48,0000:0e8d:561a]:[32,10.12.32.11]:[1050]
51.51.51.51      0      100      0      i  51.51.51.51      VxLAN
*>i  [2]:[0]:[1050]:[48,0000:3333:1050]:[32,10.12.32.10]:[1050]
51.51.51.51      0      100      0      i  51.51.51.51      VxLAN
*>i  [2]:[0]:[1050]:[48,3c2c:99d6:167a]:[32,10.12.32.1]:[1050]
51.51.51.51      0      100      0      i  51.51.51.51      VxLAN
*>i  [2]:[0]:[1050]:[48,3c2c:99d6:167a]:[128,2401::1]:[1050]
51.51.51.51      0      100      0      i  51.51.51.51      VxLAN
*>i  [3]:[1050]:[32,51.51.51.51]
51.51.51.51      0      100      0      i  51.51.51.51      VxLAN

RD[2.3.4.5:2]
*>i  [1]:[00:00:00:44:44:55:55:00:00:00]:[1060]:[1060]
60.60.60.60      0      100      0      i  60.60.60.60      VxLAN
*>i
[2]:[00:00:00:44:44:55:55:00:00:00]:[1060]:[48,0000:2222:1060]:[32,10.240.38.10]:[1060]
60.60.60.60      0      100      0      i  60.60.60.60      VxLAN
*>i  [2]:[0]:[1060]:[48,0000:2222:3333]:[32,10.240.38.1]:[1060]
60.60.60.60      0      100      0      i  60.60.60.60      VxLAN
*>i  [2]:[0]:[1060]:[48,0000:2222:3333]:[128,1601::1]:[1060]
60.60.60.60      0      100      0      i  60.60.60.60      VxLAN
*>i  [3]:[1060]:[32,60.60.60.60]
60.60.60.60      0      100      0      i  60.60.60.60      VxLAN

RD[2.3.4.6:2]
*>i  [1]:[00:00:00:44:44:55:55:00:00:00]:[1060]:[1060]
76.76.76.76      0      100      0      i  76.76.76.76      VxLAN

```

```
*>i [2]:[00:00:00:44:44:55:55:00:00:00]:[1060]:[48,0000:0e8d:5619]:[0]:[1060]
      76.76.76.76      0      100      0      i 76.76.76.76      VxLAN
*>i
[2]:[00:00:00:44:44:55:55:00:00:00]:[1060]:[48,0000:2222:1060]:[32,10.240.38.10]:[1060]
      76.76.76.76      0      100      0      i 76.76.76.76      VxLAN
*>i [2]:[0]:[1060]:[48,0000:2222:3333]:[32,10.240.38.1]:[1060]
      76.76.76.76      0      100      0      i 76.76.76.76      VxLAN
*>i [2]:[0]:[1060]:[48,0000:2222:3333]:[128,1601::1]:[1060]
      76.76.76.76      0      100      0      i 76.76.76.76      VxLAN
*>i [3]:[1060]:[32,76.76.76.76]
      76.76.76.76      0      100      0      i 76.76.76.76      VxLAN
```

RD[51.51.51.51:1050]

```
*>i [5]:[0]:[10502]:[24]:[10.12.32.0]:[0.0.0.0]:[10502]
      51.51.51.51      0      100      0      ? 51.51.51.51      VxLAN
```

RD[60.60.60.60:1]

```
*>i [1]:[00:00:00:44:44:55:55:00:00:00]:[4294967295]:[0]
      60.60.60.60      0      100      0      i 60.60.60.60      VxLAN
*>i [4]:[00:00:00:44:44:55:55:00:00:00]:[32,60.60.60.60]
      60.60.60.60      0      100      0      i 60.60.60.60      VxLAN
```

RD[60.60.60.60:1040]

```
*>i [5]:[0]:[10402]:[24]:[10.240.38.0]:[0.0.0.0]:[10402]
      60.60.60.60      0      100      0      ? 60.60.60.60      VxLAN
```

RD[76.76.76.76:1]

```
*>i [1]:[00:00:00:44:44:55:55:00:00:00]:[4294967295]:[0]
      76.76.76.76      0      100      0      i 76.76.76.76      VxLAN
*>i [4]:[00:00:00:44:44:55:55:00:00:00]:[32,76.76.76.76]
      76.76.76.76      0      100      0      i 76.76.76.76      VxLAN
```

RD[76.76.76.76:1040]

```
*>i [5]:[0]:[10402]:[24]:[10.240.38.0]:[0.0.0.0]:[10402]
      76.76.76.76      0      100      0      ? 76.76.76.76      VxLAN
```

Total number of prefixes 41

BorderVTEP1#

BorderVTEP1#show bgp l2vpn evpn prefix-route

RD[51.51.51.51:1050]

ESI IPAddress	Eth-Tag	Prefix-Length L3VNID	IP-Address NextHop	Encap	Router-Mac	GW-
0	10502	24	10.12.32.0	0.0.0.0		
10502	51.51.51.51	VxLAN	3c2c:99d6:167a			

RD[60.60.60.60:1040]

ESI IPAddress	Eth-Tag	Prefix-Length L3VNID	IP-Address NextHop	Encap	Router-Mac	GW-

```

0          10402 24          10.240.38.0          0.0.0.0
10402     60.60.60.60      VxLAN      3c2c:99d1:117a
    
```

RD[76.76.76.76:1040]

```

ESI          Eth-Tag Prefix-Length  IP-Address  GW-
IPAddress    L3VNID  Nexthop      Router-Mac
0          10402 24          10.240.38.0  0.0.0.0
10402     76.76.76.76  VxLAN      3c2c:99de:1e7a
    
```

VTEP3

=====

VTEP3#show nvo vxlan
VxLAN Information

=====

Codes: NW - Network Port
AC - Access Port
(u) - Untagged

VNID	VNI-Name	VNI-Type	Type	Interface	ESI	VLAN	DF-Status
Src-Addr	Dst-Addr						
1060	----	L2	NW	----	----	----	----
76.76.76.76	60.60.60.60						
1060	----	--	AC	po1000	00:00:00:44:44:55:55:00:00:00	1060	NON-DF
----	----						
10402	----	L3	NW	----	----	----	----
76.76.76.76	66.66.66.66						

Total number of entries are 3

VTEP3#show nvo vxlan tunnel
VxLAN Network tunnel Entries

Source	Destination	Status	Up/Down	Update
76.76.76.76	66.66.66.66	Installed	00:24:35	00:24:35
76.76.76.76	60.60.60.60	Installed	00:54:40	00:54:40

Total number of entries are 2

VTEP3#show ip route vrf all

Codes: K - kernel, C - connected, S - static, R - RIP, B - BGP
O - OSPF, IA - OSPF inter area
N1 - OSPF NSSA external type 1, N2 - OSPF NSSA external type 2
E1 - OSPF external type 1, E2 - OSPF external type 2
i - IS-IS, L1 - IS-IS level-1, L2 - IS-IS level-2,
ia - IS-IS inter area, E - EVPN,
v - vrf leaked
* - candidate default

IP Route Table for VRF "default"

```

O      10.10.10.0/31 [110/2] via 10.10.24.1, xe27, 00:54:56
O      10.10.12.0/31 [110/2] via 10.10.24.1, xe27, 00:54:56
O      10.10.14.0/31 [110/2] via 10.10.24.1, xe27, 00:25:31
C      10.10.24.0/31 is directly connected, xe27, 00:55:37
O      51.51.51.51/32 [110/3] via 10.10.24.1, xe27, 00:54:47
O      60.60.60.60/32 [110/3] via 10.10.24.1, xe27, 00:54:45
O      66.66.66.66/32 [110/3] via 10.10.24.1, xe27, 00:24:46
C      76.76.76.76/32 is directly connected, lo, 00:55:38
C      127.0.0.0/8 is directly connected, lo, 00:55:39
IP Route Table for VRF "management"
C      10.12.20.0/24 is directly connected, eth0, 00:55:10
C      127.0.0.0/8 is directly connected, lo.management, 00:55:39
IP Route Table for VRF "SMS"
Gateway of last resort is 66.66.66.66 to network 0.0.0.0

B*     0.0.0.0/0 [200/0] via 66.66.66.66 (recursive is directly connected,
tunvxlan2), 00:23:33
B      10.10.18.0/24 [200/0] via 66.66.66.66 (recursive is directly connected,
tunvxlan2), 00:24:41
B      10.10.20.0/24 [200/0] via 66.66.66.66 (recursive is directly connected,
tunvxlan2), 00:06:03
C      10.240.38.0/24 is directly connected, irb1060, 00:55:38
B      66.66.66.66/32 [0/0] is directly connected, tunvxlan2, 00:24:41
C      127.0.0.0/8 is directly connected, lo.SMS, 00:55:39
VTEP3# show bgp l2vpn evpn summary
BGP router identifier 76.76.76.76, local AS number 500
BGP table version is 8
2 BGP AS-PATH entries
0 BGP community entries

Neighbor      AD  MACIP  V   AS  MsgRcv  MsgSen  TblVer  InQ  OutQ  Up/Down  State/
PfxRcd
60.60.60.60   2   3      4   500  144    140     7    0    0  00:54:55
8
66.66.66.66  0   2      4   500  127    125     7    0    0  00:24:51
12

Total number of neighbors 2

Total number of Established sessions 2
VTEP3# show bgp l2vpn evpn
BGP table version is 8, local router ID is 76.76.76.76
Status codes: s suppressed, d damped, h history, * valid, > best, i - internal,
l - labeled, S Stale
Origin codes: i - IGP, e - EGP, ? - incomplete

[EVPN route type]:[ESI]:[VNID]:[relevent route informantion]
1 - Ethernet Auto-discovery Route
2 - MAC/IP Route
3 - Inclusive Multicast Route
4 - Ethernet Segment Route
5 - Prefix Route

```

Network Encap	Next Hop	Metric	LocPrf	Weight	Path	Peer
RD[2.2.4.4:4]						
*>i [2]:[0]:[1067]:[48,3c2c:991c:dc7a]:[32,10.10.18.1]:[1067]	66.66.66.66	0	100	0	i 66.66.66.66	VxLAN
*>i [2]:[0]:[1067]:[48,a82b:b5cf:f806]:[32,10.10.18.2]:[1067]	66.66.66.66	0	100	0	i 66.66.66.66	VxLAN
*>i [3]:[1067]:[32,66.66.66.66]	66.66.66.66	0	100	0	i 66.66.66.66	VxLAN
RD[2.3.4.5:2]						
*>i [1]:[00:00:00:44:44:55:55:00:00:00]:[1060]:[1060]	60.60.60.60	0	100	0	i 60.60.60.60	VxLAN
*>i [2]:[00:00:00:44:44:55:55:00:00:00]:[1060]:[48,0000:2222:1060]:[32,10.240.38.10]:[1060]	60.60.60.60	0	100	0	i 60.60.60.60	VxLAN
*>i [2]:[0]:[1060]:[48,0000:2222:3333]:[32,10.240.38.1]:[1060]	60.60.60.60	0	100	0	i 60.60.60.60	VxLAN
*>i [2]:[0]:[1060]:[48,0000:2222:3333]:[128,1601::1]:[1060]	60.60.60.60	0	100	0	i 60.60.60.60	VxLAN
*>i [3]:[1060]:[32,60.60.60.60]	60.60.60.60	0	100	0	i 60.60.60.60	VxLAN
RD[2.3.4.6:2] VRF[RED]:						
*> [1]:[00:00:00:44:44:55:55:00:00:00]:[1060]:[1060]	76.76.76.76	0	100	32768	i -----	
VxLAN						
* i 60.60.60.60	60.60.60.60	0	100	0	i 60.60.60.60	VxLAN
* i [1]:[00:00:00:44:44:55:55:00:00:00]:[4294967295]:[0]	60.60.60.60	0	100	0	i 60.60.60.60	VxLAN
*> [2]:[00:00:00:44:44:55:55:00:00:00]:[1060]:[48,0000:0e8d:5619]:[0]:[1060]	76.76.76.76	0	100	32768	i -----	
VxLAN						
*> [2]:[00:00:00:44:44:55:55:00:00:00]:[1060]:[48,0000:2222:1060]:[32,10.240.38.10]:[1060]	76.76.76.76	0	100	32768	i -----	
VxLAN						
* i 60.60.60.60	60.60.60.60	0	100	0	i 60.60.60.60	VxLAN
* i [2]:[0]:[1060]:[48,0000:2222:3333]:[32,10.240.38.1]:[1060]	60.60.60.60	0	100	0	i 60.60.60.60	VxLAN
*> 76.76.76.76	76.76.76.76	0	100	32768	i -----	
VxLAN						
* i [2]:[0]:[1060]:[48,0000:2222:3333]:[128,1601::1]:[1060]	60.60.60.60	0	100	0	i 60.60.60.60	VxLAN
*> 76.76.76.76	76.76.76.76	0	100	32768	i -----	
VxLAN						
* i [2]:[0]:[1067]:[48,3c2c:991c:dc7a]:[32,10.10.18.1]:[1067]	66.66.66.66	0	100	0	i 66.66.66.66	VxLAN
* i [2]:[0]:[1067]:[48,a82b:b5cf:f806]:[32,10.10.18.2]:[1067]	66.66.66.66	0	100	0	i 66.66.66.66	VxLAN

```

* i [3]:[1060]:[32,60.60.60.60]
      60.60.60.60      0      100      0      i 60.60.60.60      VxLAN
*> [3]:[1060]:[32,76.76.76.76]
      76.76.76.76      0      100      32768 i -----
VxLAN
* i [3]:[1067]:[32,66.66.66.66]
      66.66.66.66      0      100      0      i 66.66.66.66      VxLAN

RD[4.5.6.8:6]
*>i [5]:[0]:[500]:[0]:[0.0.0.0]:[0.0.0.0]:[500]
      66.66.66.66      0      100      0      64603 i 66.66.66.66
VxLAN
*>i [5]:[0]:[500]:[24]:[10.10.18.0]:[0.0.0.0]:[500]
      66.66.66.66      0      100      0      ? 66.66.66.66      VxLAN
*>i [5]:[0]:[500]:[24]:[10.10.20.0]:[0.0.0.0]:[500]
      66.66.66.66      0      100      0      64603 i 66.66.66.66
VxLAN

RD[60.60.60.60:1]
*>i [1]:[00:00:00:44:44:55:55:00:00:00]:[4294967295]:[0]
      60.60.60.60      0      100      0      i 60.60.60.60      VxLAN
*>i [4]:[00:00:00:44:44:55:55:00:00:00]:[32,60.60.60.60]
      60.60.60.60      0      100      0      i 60.60.60.60      VxLAN

RD[60.60.60.60:1040]
*>i [5]:[0]:[10402]:[24]:[10.240.38.0]:[0.0.0.0]:[10402]
      60.60.60.60      0      100      0      ? 60.60.60.60      VxLAN

RD[66.66.66.66:1050]
*>i [5]:[0]:[500]:[0]:[0.0.0.0]:[0.0.0.0]:[500]
      66.66.66.66      0      100      0      64603 i 66.66.66.66
VxLAN
*>i [5]:[0]:[500]:[24]:[10.10.18.0]:[0.0.0.0]:[500]
      66.66.66.66      0      100      0      ? 66.66.66.66      VxLAN
*>i [5]:[0]:[500]:[24]:[10.10.20.0]:[0.0.0.0]:[500]
      66.66.66.66      0      100      0      64603 i 66.66.66.66
VxLAN

RD[66.66.66.66:1060]
*>i [5]:[0]:[500]:[0]:[0.0.0.0]:[0.0.0.0]:[500]
      66.66.66.66      0      100      0      64603 i 66.66.66.66
VxLAN
*>i [5]:[0]:[500]:[24]:[10.10.18.0]:[0.0.0.0]:[500]
      66.66.66.66      0      100      0      ? 66.66.66.66      VxLAN
*>i [5]:[0]:[500]:[24]:[10.10.20.0]:[0.0.0.0]:[500]
      66.66.66.66      0      100      0      64603 i 66.66.66.66
VxLAN

RD[76.76.76.76:1] VRF[evpn-gvrf-1]:
*> [1]:[00:00:00:44:44:55:55:00:00:00]:[4294967295]:[0]
      76.76.76.76      0      100      32768 i -----
VxLAN

```

```
* i [4]:[00:00:00:44:44:55:55:00:00:00]:[32,60.60.60.60]
      60.60.60.60      0      100      0      i 60.60.60.60      VxLAN
* > [4]:[00:00:00:44:44:55:55:00:00:00]:[32,76.76.76.76]
      76.76.76.76      0      100      32768      i -----
VxLAN
```

Total number of prefixes 34

VTEP3#

VTEP3#show bgp l2vpn evpn prefix-route

RD[4.5.6.8:6]

ESI IPAddress	Eth-Tag	Prefix-Length L3VNID	IP-Address Nexthop	Encap	Router-Mac	GW-
0	500 0	0.0.0.0		0.0.0.0		
500	66.66.66.66 VxLAN	3c2c:991c:dc7a				
0	500 24	10.10.18.0		0.0.0.0		
500	66.66.66.66 VxLAN	3c2c:991c:dc7a				
0	500 24	10.10.20.0		0.0.0.0		
500	66.66.66.66 VxLAN	3c2c:991c:dc7a				

RD[60.60.60.60:1040]

ESI IPAddress	Eth-Tag	Prefix-Length L3VNID	IP-Address Nexthop	Encap	Router-Mac	GW-
0	10402 24	10.240.38.0		0.0.0.0		
10402	60.60.60.60 VxLAN	3c2c:99d1:117a				

RD[66.66.66.66:1050]

ESI IPAddress	Eth-Tag	Prefix-Length L3VNID	IP-Address Nexthop	Encap	Router-Mac	GW-
0	500 0	0.0.0.0		0.0.0.0		
500	66.66.66.66 VxLAN	3c2c:991c:dc7a				
0	500 24	10.10.18.0		0.0.0.0		
500	66.66.66.66 VxLAN	3c2c:991c:dc7a				
0	500 24	10.10.20.0		0.0.0.0		
500	66.66.66.66 VxLAN	3c2c:991c:dc7a				

RD[66.66.66.66:1060]

ESI IPAddress	Eth-Tag	Prefix-Length L3VNID	IP-Address Nexthop	Encap	Router-Mac	GW-
0	500 0	0.0.0.0		0.0.0.0		
500	66.66.66.66 VxLAN	3c2c:991c:dc7a				
0	500 24	10.10.18.0		0.0.0.0		
500	66.66.66.66 VxLAN	3c2c:991c:dc7a				
0	500 24	10.10.20.0		0.0.0.0		
500	66.66.66.66 VxLAN	3c2c:991c:dc7a				

VTEP2

=====

VTEP2#show nvo vxlan

VxLAN Information

=====

Codes: NW - Network Port

AC - Access Port
(u) - Untagged

VNID	VNI-Name	VNI-Type	Type	Interface	ESI	VLAN	DF-Status
Src-Addr	Dst-Addr						
1060	----	L2	NW	----	----	----	----
60.60.60.60	76.76.76.76						
1060	----	--	AC	po1000	00:00:00:44:44:55:55:00:00:00	1060	DF
----	----						
10402	----	L3	NW	----	----	----	----
60.60.60.60	66.66.66.66						

Total number of entries are 3

VTEP2#show nvo vxlan tunnel

VxLAN Network tunnel Entries

Source	Destination	Status	Up/Down	Update
60.60.60.60	66.66.66.66	Installed	00:26:50	00:26:50
60.60.60.60	76.76.76.76	Installed	00:56:51	00:56:51

Total number of entries are 2

VTEP2#show ip route vrf all

Codes: K - kernel, C - connected, S - static, R - RIP, B - BGP
 O - OSPF, IA - OSPF inter area
 N1 - OSPF NSSA external type 1, N2 - OSPF NSSA external type 2
 E1 - OSPF external type 1, E2 - OSPF external type 2
 i - IS-IS, L1 - IS-IS level-1, L2 - IS-IS level-2,
 ia - IS-IS inter area, E - EVPN,
 v - vrf leaked
 * - candidate default

IP Route Table for VRF "default"

```
O      10.10.10.0/31 [110/2] via 10.10.12.0, xe25, 00:57:13
C      10.10.12.0/31 is directly connected, xe25, 00:57:57
O      10.10.14.0/31 [110/2] via 10.10.12.0, xe25, 00:27:47
O      10.10.16.0/31 [110/2] via 10.10.12.0, xe25, 00:57:13
O      10.10.24.0/31 [110/2] via 10.10.12.0, xe25, 00:57:13
O      51.51.51.51/32 [110/3] via 10.10.12.0, xe25, 00:57:03
C      60.60.60.60/32 is directly connected, lo, 00:57:59
O      66.66.66.66/32 [110/3] via 10.10.12.0, xe25, 00:27:02
O      76.76.76.76/32 [110/3] via 10.10.12.0, xe25, 00:57:13
C      127.0.0.0/8 is directly connected, lo, 00:58:00
```

IP Route Table for VRF "management"

```
C      10.12.20.0/24 is directly connected, eth0, 00:57:29
C      127.0.0.0/8 is directly connected, lo.management, 00:58:00
```

IP Route Table for VRF "SMS"

Gateway of last resort is 66.66.66.66 to network 0.0.0.0

```
B*      0.0.0.0/0 [200/0] via 66.66.66.66 (recursive is directly connected,
tunvxlan2), 00:25:49
```



```

B      10.10.18.0/24 [200/0] via 66.66.66.66 (recursive is directly connected,
tunvxlan2), 00:26:58
B      10.10.20.0/24 [200/0] via 66.66.66.66 (recursive is directly connected,
tunvxlan2), 00:08:19
C      10.240.38.0/24 is directly connected, irb1060, 00:57:58
B      66.66.66.66/32 [0/0] is directly connected, tunvxlan2, 00:26:58
C      127.0.0.0/8 is directly connected, lo.SMS, 00:58:00
  
```

```

VTEP2#show bgp l2vpn evpn sum
BGP router identifier 60.60.60.60, local AS number 500
BGP table version is 12
2 BGP AS-PATH entries
0 BGP community entries
  
```

Neighbor PfxRcd	AD	MACIP	V MCAST	AS	MsgRcv ESI	MsgSen PREFIX-ROUTE	TblVer	InQ	OutQ	Up/Down	State/
66.66.66.66			4	500	135	133	11	0	0	00:27:29	
12	0	2	1	0	9						
76.76.76.76			4	500	146	150	11	0	0	00:57:30	
9	2	4	1	1	1						

Total number of neighbors 2

Total number of Established sessions 2

```

VTEP2#show bgp l2vpn evpn
BGP table version is 12, local router ID is 60.60.60.60
Status codes: s suppressed, d damped, h history, * valid, > best, i - internal,
               l - labeled, S Stale
Origin codes: i - IGP, e - EGP, ? - incomplete
  
```

```

[EVPN route type]:[ESI]:[VNID]:[relevent route informantion]
1 - Ethernet Auto-discovery Route
2 - MAC/IP Route
3 - Inclusive Multicast Route
4 - Ethernet Segment Route
5 - Prefix Route
  
```

Network Encap	Next Hop	Metric	LocPrf	Weight	Path	Peer
RD[2.2.4.4:4]						
*>i [2]:[0]:[1067]:[48,3c2c:991c:dc7a]:[32,10.10.18.1]:[1067]	66.66.66.66	0	100	0	i 66.66.66.66	VxLAN
*>i [2]:[0]:[1067]:[48,a82b:b5cf:f806]:[32,10.10.18.2]:[1067]	66.66.66.66	0	100	0	i 66.66.66.66	VxLAN
*>i [3]:[1067]:[32,66.66.66.66]	66.66.66.66	0	100	0	i 66.66.66.66	VxLAN
RD[2.3.4.5:2] VRF[RED]:						
* i [1]:[00:00:00:44:44:55:55:00:00:00]:[1060]:[1060]	76.76.76.76	0	100	0	i 76.76.76.76	VxLAN

```

*>          60.60.60.60          0          100          32768 i -----
VxLAN
* i  [1]:[00:00:00:44:44:55:55:00:00:00]:[4294967295]:[0]
          76.76.76.76          0          100          0 i 76.76.76.76 VxLAN
* i  [2]:[00:00:00:44:44:55:55:00:00:00]:[1060]:[48,0000:0e8d:5619]:[0]:[1060]
          76.76.76.76          0          100          0 i 76.76.76.76 VxLAN
* i
[2]:[00:00:00:44:44:55:55:00:00:00]:[1060]:[48,0000:2222:1060]:[32,10.240.38.10]:[1060]
          76.76.76.76          0          100          0 i 76.76.76.76 VxLAN
*>          60.60.60.60          0          100          32768 i -----
VxLAN
* i  [2]:[0]:[1060]:[48,0000:2222:3333]:[32,10.240.38.1]:[1060]
          76.76.76.76          0          100          0 i 76.76.76.76 VxLAN
*>          60.60.60.60          0          100          32768 i -----
VxLAN
* i  [2]:[0]:[1060]:[48,0000:2222:3333]:[128,1601::1]:[1060]
          76.76.76.76          0          100          0 i 76.76.76.76 VxLAN
*>          60.60.60.60          0          100          32768 i -----
VxLAN
* i  [2]:[0]:[1067]:[48,3c2c:991c:dc7a]:[32,10.10.18.1]:[1067]
          66.66.66.66          0          100          0 i 66.66.66.66 VxLAN
* i  [2]:[0]:[1067]:[48,a82b:b5cf:f806]:[32,10.10.18.2]:[1067]
          66.66.66.66          0          100          0 i 66.66.66.66 VxLAN
*>  [3]:[1060]:[32,60.60.60.60]
          60.60.60.60          0          100          32768 i -----
VxLAN
* i  [3]:[1060]:[32,76.76.76.76]
          76.76.76.76          0          100          0 i 76.76.76.76 VxLAN
* i  [3]:[1067]:[32,66.66.66.66]
          66.66.66.66          0          100          0 i 66.66.66.66 VxLAN

RD[2.3.4.6:2]
*>i  [1]:[00:00:00:44:44:55:55:00:00:00]:[1060]:[1060]
          76.76.76.76          0          100          0 i 76.76.76.76 VxLAN
*>i  [2]:[00:00:00:44:44:55:55:00:00:00]:[1060]:[48,0000:0e8d:5619]:[0]:[1060]
          76.76.76.76          0          100          0 i 76.76.76.76 VxLAN
*>i
[2]:[00:00:00:44:44:55:55:00:00:00]:[1060]:[48,0000:2222:1060]:[32,10.240.38.10]:[1060]
          76.76.76.76          0          100          0 i 76.76.76.76 VxLAN
*>i  [2]:[0]:[1060]:[48,0000:2222:3333]:[32,10.240.38.1]:[1060]
          76.76.76.76          0          100          0 i 76.76.76.76 VxLAN
*>i  [2]:[0]:[1060]:[48,0000:2222:3333]:[128,1601::1]:[1060]
          76.76.76.76          0          100          0 i 76.76.76.76 VxLAN
*>i  [3]:[1060]:[32,76.76.76.76]
          76.76.76.76          0          100          0 i 76.76.76.76 VxLAN

RD[4.5.6.8:6]
*>i  [5]:[0]:[500]:[0]:[0.0.0.0]:[0.0.0.0]:[500]
          66.66.66.66          0          100          0 64603 i 66.66.66.66
VxLAN
*>i  [5]:[0]:[500]:[24]:[10.10.18.0]:[0.0.0.0]:[500]
          66.66.66.66          0          100          0 ? 66.66.66.66 VxLAN

```

```

*>i [5]:[0]:[500]:[24]:[10.10.20.0]:[0.0.0.0]:[500]
      66.66.66.66      0      100      0      64603 i 66.66.66.66
VxLAN

RD[60.60.60.60:1] VRF[evpn-gvrf-1]:
*> [1]:[00:00:00:44:44:55:55:00:00:00]:[4294967295]:[0]
      60.60.60.60      0      100      32768 i -----
VxLAN
*> [4]:[00:00:00:44:44:55:55:00:00:00]:[32,60.60.60.60]
      60.60.60.60      0      100      32768 i -----
VxLAN
* i [4]:[00:00:00:44:44:55:55:00:00:00]:[32,76.76.76.76]
      76.76.76.76      0      100      0      i 76.76.76.76      VxLAN

RD[66.66.66.66:1050]
*>i [5]:[0]:[500]:[0]:[0.0.0.0]:[0.0.0.0]:[500]
      66.66.66.66      0      100      0      64603 i 66.66.66.66
VxLAN
*>i [5]:[0]:[500]:[24]:[10.10.18.0]:[0.0.0.0]:[500]
      66.66.66.66      0      100      0      ? 66.66.66.66      VxLAN
*>i [5]:[0]:[500]:[24]:[10.10.20.0]:[0.0.0.0]:[500]
      66.66.66.66      0      100      0      64603 i 66.66.66.66
VxLAN

RD[66.66.66.66:1060]
*>i [5]:[0]:[500]:[0]:[0.0.0.0]:[0.0.0.0]:[500]
      66.66.66.66      0      100      0      64603 i 66.66.66.66
VxLAN
*>i [5]:[0]:[500]:[24]:[10.10.18.0]:[0.0.0.0]:[500]
      66.66.66.66      0      100      0      ? 66.66.66.66      VxLAN
*>i [5]:[0]:[500]:[24]:[10.10.20.0]:[0.0.0.0]:[500]
      66.66.66.66      0      100      0      64603 i 66.66.66.66
VxLAN

RD[76.76.76.76:1]
*>i [1]:[00:00:00:44:44:55:55:00:00:00]:[4294967295]:[0]
      76.76.76.76      0      100      0      i 76.76.76.76      VxLAN
*>i [4]:[00:00:00:44:44:55:55:00:00:00]:[32,76.76.76.76]
      76.76.76.76      0      100      0      i 76.76.76.76      VxLAN

RD[76.76.76.76:1040]
*>i [5]:[0]:[10402]:[24]:[10.240.38.0]:[0.0.0.0]:[10402]
      76.76.76.76      0      100      0      ? 76.76.76.76      VxLAN

```

```

Total number of prefixes 35
VTEP2#
VTEP22#show bgp l2vpn evpn prefix-route

```

```

RD[4.5.6.8:6]
ESI                               Eth-Tag Prefix-Length IP-Address          GW-
IPAddress                         L3VNID  Nexthop             Router-Mac

```

```

0          500  0          0.0.0.0          0.0.0.0
500       66.66.66.66    VxLAN    3c2c:991c:dc7a
0          500  24         10.10.18.0        0.0.0.0
500       66.66.66.66    VxLAN    3c2c:991c:dc7a
0          500  24         10.10.20.0        0.0.0.0
500       66.66.66.66    VxLAN    3c2c:991c:dc7a
    
```

RD[66.66.66.66:1050]

ESI IPAddress	Eth-Tag	Prefix-Length	IP-Address L3VNID	IP-Address Nexthop	Encap	Router-Mac	GW-
0	500	0	0.0.0.0		0.0.0.0		
500	66.66.66.66	VxLAN	3c2c:991c:dc7a				
0	500	24	10.10.18.0		0.0.0.0		
500	66.66.66.66	VxLAN	3c2c:991c:dc7a				
0	500	24	10.10.20.0		0.0.0.0		
500	66.66.66.66	VxLAN	3c2c:991c:dc7a				

RD[66.66.66.66:1060]

ESI IPAddress	Eth-Tag	Prefix-Length	IP-Address L3VNID	IP-Address Nexthop	Encap	Router-Mac	GW-
0	500	0	0.0.0.0		0.0.0.0		
500	66.66.66.66	VxLAN	3c2c:991c:dc7a				
0	500	24	10.10.18.0		0.0.0.0		
500	66.66.66.66	VxLAN	3c2c:991c:dc7a				
0	500	24	10.10.20.0		0.0.0.0		
500	66.66.66.66	VxLAN	3c2c:991c:dc7a				

RD[76.76.76.76:1040]

ESI IPAddress	Eth-Tag	Prefix-Length	IP-Address L3VNID	IP-Address Nexthop	Encap	Router-Mac	GW-
0	10402	24	10.240.38.0		0.0.0.0		
10402	76.76.76.76	VxLAN	3c2c:99de:1e7a				

VTEP2#

VTEP1

=====

VTEP1#show nvo vxlan

VxLAN Information

=====

Codes: NW - Network Port
 AC - Access Port
 (u) - Untagged

VNID Src-Addr	VNI-Name Dst-Addr	VNI-Type	Type	Interface	ESI	VLAN	DF-Status
1050	----	--	AC	ce50	---	Single Homed Port	---
10502	----	L3	NW	----	----		----
51.51.51.51	66.66.66.66						

Total number of entries are 2

```
VTEP1#show nvo vxlan tunnel
VxLAN Network tunnel Entries
Source          Destination      Status           Up/Down          Update
=====
51.51.51.51     66.66.66.66     Installed        00:28:13        00:28:13
```

Total number of entries are 1

```
VTEP1#show ip route vrf all
```

```
Codes: K - kernel, C - connected, S - static, R - RIP, B - BGP
       O - OSPF, IA - OSPF inter area
       N1 - OSPF NSSA external type 1, N2 - OSPF NSSA external type 2
       E1 - OSPF external type 1, E2 - OSPF external type 2
       i - IS-IS, L1 - IS-IS level-1, L2 - IS-IS level-2,
       ia - IS-IS inter area, E - EVPN,
       v - vrf leaked
       * - candidate default
```

```
IP Route Table for VRF "default"
```

```
C          10.10.10.0/31 is directly connected, xe40, 00:59:46
O          10.10.12.0/31 [110/2] via 10.10.10.0, xe40, 00:59:01
O          10.10.14.0/31 [110/2] via 10.10.10.0, xe40, 00:29:45
O          10.10.24.0/31 [110/2] via 10.10.10.0, xe40, 00:59:01
C          51.51.51.51/32 is directly connected, lo, 00:59:47
O          60.60.60.60/32 [110/3] via 10.10.10.0, xe40, 00:59:01
O          66.66.66.66/32 [110/3] via 10.10.10.0, xe40, 00:29:00
O          76.76.76.76/32 [110/3] via 10.10.10.0, xe40, 00:59:01
C          127.0.0.0/8 is directly connected, lo, 00:59:49
```

```
IP Route Table for VRF "management"
```

```
C          10.12.20.0/24 is directly connected, eth0, 00:59:22
C          127.0.0.0/8 is directly connected, lo.management, 00:59:49
```

```
IP Route Table for VRF "FAX"
```

```
Gateway of last resort is 66.66.66.66 to network 0.0.0.0
```

```
B*         0.0.0.0/0 [200/0] via 66.66.66.66 (recursive is directly connected,
tunvxlan2), 00:27:47
B          10.10.18.0/24 [200/0] via 66.66.66.66 (recursive is directly connected,
tunvxlan2), 00:28:55
B          10.10.20.0/24 [200/0] via 66.66.66.66 (recursive is directly connected,
tunvxlan2), 00:10:17
C          10.12.32.0/24 is directly connected, irb1050, 00:59:47
B          66.66.66.66/32 [0/0] is directly connected, tunvxlan2, 00:28:55
C          127.0.0.0/8 is directly connected, lo.FAX, 00:59:48
```

```
VTEP1# show bgp l2vpn evpn summary
```

```
BGP router identifier 51.51.51.51, local AS number 500
```

```
BGP table version is 9
```

```
2 BGP AS-PATH entries
```

```
0 BGP community entries
```

```
Neighbor      V  AS  MsgRcv  MsgSen  TblVer  InQ  OutQ  Up/Down  State/
PfxRcd      AD  MACIP  MCAST  ESI  PREFIX-ROUTE
```

```
66.66.66.66      4  500 138      132      8      0      0 00:29:07
12      0      2      1      0      9
```

Total number of neighbors 1

Total number of Established sessions 1

VTEP1# show bgp l2vpn evpn

BGP table version is 9, local router ID is 51.51.51.51

Status codes: s suppressed, d damped, h history, * valid, > best, i - internal,
l - labeled, S Stale

Origin codes: i - IGP, e - EGP, ? - incomplete

[EVPN route type]:[ESI]:[VNID]:[relevent route informantion]

1 - Ethernet Auto-discovery Route

2 - MAC/IP Route

3 - Inclusive Multicast Route

4 - Ethernet Segment Route

5 - Prefix Route

Network	Next Hop	Metric	LocPrf	Weight	Path	Peer
RD[2.2.4.4:4]						
*>i [2]:[0]:[1067]:[48,3c2c:991c:dc7a]:[32,10.10.18.1]:[1067]	66.66.66.66	0	100	0	i 66.66.66.66	VxLAN
*>i [2]:[0]:[1067]:[48,a82b:b5cf:f806]:[32,10.10.18.2]:[1067]	66.66.66.66	0	100	0	i 66.66.66.66	VxLAN
*>i [3]:[1067]:[32,66.66.66.66]	66.66.66.66	0	100	0	i 66.66.66.66	VxLAN
RD[2.3.4.5:1] VRF[RED]:						
*> [2]:[0]:[1050]:[48,0000:0e8d:561a]:[0]:[1050]	51.51.51.51	0	100	32768	i -----	
VxLAN						
*> [2]:[0]:[1050]:[48,0000:0e8d:561a]:[32,10.12.32.11]:[1050]	51.51.51.51	0	100	32768	i -----	
VxLAN						
*> [2]:[0]:[1050]:[48,0000:3333:1050]:[32,10.12.32.10]:[1050]	51.51.51.51	0	100	32768	i -----	
VxLAN						
*> [2]:[0]:[1050]:[48,3c2c:99d6:167a]:[32,10.12.32.1]:[1050]	51.51.51.51	0	100	32768	i -----	
VxLAN						
*> [2]:[0]:[1050]:[48,3c2c:99d6:167a]:[128,2401::1]:[1050]	51.51.51.51	0	100	32768	i -----	
VxLAN						
* i [2]:[0]:[1067]:[48,3c2c:991c:dc7a]:[32,10.10.18.1]:[1067]	66.66.66.66	0	100	0	i 66.66.66.66	VxLAN
* i [2]:[0]:[1067]:[48,a82b:b5cf:f806]:[32,10.10.18.2]:[1067]	66.66.66.66	0	100	0	i 66.66.66.66	VxLAN
*> [3]:[1050]:[32,51.51.51.51]						

```

51.51.51.51          0          100          32768 i -----
VxLAN
* i  [3]:[1067]:[32,66.66.66.66]
          66.66.66.66          0          100          0 i 66.66.66.66 VxLAN

RD[4.5.6.8:6]
*>i  [5]:[0]:[500]:[0]:[0.0.0.0]:[0.0.0.0]:[500]
          66.66.66.66          0          100          0 64603 i 66.66.66.66
VxLAN
*>i  [5]:[0]:[500]:[24]:[10.10.18.0]:[0.0.0.0]:[500]
          66.66.66.66          0          100          0 ? 66.66.66.66 VxLAN
*>i  [5]:[0]:[500]:[24]:[10.10.20.0]:[0.0.0.0]:[500]
          66.66.66.66          0          100          0 64603 i 66.66.66.66
VxLAN

RD[66.66.66.66:1050]
*>i  [5]:[0]:[500]:[0]:[0.0.0.0]:[0.0.0.0]:[500]
          66.66.66.66          0          100          0 64603 i 66.66.66.66
VxLAN
*>i  [5]:[0]:[500]:[24]:[10.10.18.0]:[0.0.0.0]:[500]
          66.66.66.66          0          100          0 ? 66.66.66.66 VxLAN
*>i  [5]:[0]:[500]:[24]:[10.10.20.0]:[0.0.0.0]:[500]
          66.66.66.66          0          100          0 64603 i 66.66.66.66
VxLAN

RD[66.66.66.66:1060]
*>i  [5]:[0]:[500]:[0]:[0.0.0.0]:[0.0.0.0]:[500]
          66.66.66.66          0          100          0 64603 i 66.66.66.66
VxLAN
*>i  [5]:[0]:[500]:[24]:[10.10.18.0]:[0.0.0.0]:[500]
          66.66.66.66          0          100          0 ? 66.66.66.66 VxLAN
*>i  [5]:[0]:[500]:[24]:[10.10.20.0]:[0.0.0.0]:[500]
          66.66.66.66          0          100          0 64603 i 66.66.66.66
VxLAN

```

Total number of prefixes 21
VTEP1#

VTEP1#show ip route vrf FAX

```

Codes: K - kernel, C - connected, S - static, R - RIP, B - BGP
       O - OSPF, IA - OSPF inter area
       N1 - OSPF NSSA external type 1, N2 - OSPF NSSA external type 2
       E1 - OSPF external type 1, E2 - OSPF external type 2
       i - IS-IS, L1 - IS-IS level-1, L2 - IS-IS level-2,
       ia - IS-IS inter area, E - EVPN,
       v - vrf leaked
       * - candidate default

```

IP Route Table for VRF "FAX"

Gateway of last resort is 66.66.66.66 to network 0.0.0.0

```

B*      0.0.0.0/0 [200/0] via 66.66.66.66 (recursive is directly connected,
tunvxlan2), 00:29:26
B       10.10.18.0/24 [200/0] via 66.66.66.66 (recursive is directly connected,
tunvxlan2), 00:30:34
B       10.10.20.0/24 [200/0] via 66.66.66.66 (recursive is directly connected,
tunvxlan2), 00:11:56
C       10.12.32.0/24 is directly connected, irb1050, 01:01:26
B       66.66.66.66/32 [0/0] is directly connected, tunvxlan2, 00:30:34
C       127.0.0.0/8 is directly connected, lo.FAX, 01:01:27

```

VTEP1#show bgp l2vpn evpn prefix-route

RD[4.5.6.8:6]

ESI IPAddress	Eth-Tag	Prefix-Length L3VNID	IP-Address Nexthop	Encap	Router-Mac	GW-
0	500 0	0.0.0.0		0.0.0.0		
500	66.66.66.66 VxLAN	3c2c:991c:dc7a				
0	500 24	10.10.18.0		0.0.0.0		
500	66.66.66.66 VxLAN	3c2c:991c:dc7a				
0	500 24	10.10.20.0		0.0.0.0		
500	66.66.66.66 VxLAN	3c2c:991c:dc7a				

RD[66.66.66.66:1050]

ESI IPAddress	Eth-Tag	Prefix-Length L3VNID	IP-Address Nexthop	Encap	Router-Mac	GW-
0	500 0	0.0.0.0		0.0.0.0		
500	66.66.66.66 VxLAN	3c2c:991c:dc7a				
0	500 24	10.10.18.0		0.0.0.0		
500	66.66.66.66 VxLAN	3c2c:991c:dc7a				
0	500 24	10.10.20.0		0.0.0.0		
500	66.66.66.66 VxLAN	3c2c:991c:dc7a				

RD[66.66.66.66:1060]

ESI IPAddress	Eth-Tag	Prefix-Length L3VNID	IP-Address Nexthop	Encap	Router-Mac	GW-
0	500 0	0.0.0.0		0.0.0.0		
500	66.66.66.66 VxLAN	3c2c:991c:dc7a				
0	500 24	10.10.18.0		0.0.0.0		
500	66.66.66.66 VxLAN	3c2c:991c:dc7a				
0	500 24	10.10.20.0		0.0.0.0		
500	66.66.66.66 VxLAN	3c2c:991c:dc7a				

Ping to 10.10.20.1 network which is advertised by Firewall from VTEP1 FAX vrf

```

VTEP1# ping 10.10.20.1 vrf FAX
Press CTRL+C to exit
PING 10.10.20.1 (10.10.20.1) 56(84) bytes of data.
64 bytes from 10.10.20.1: icmp_seq=1 ttl=63 time=0.446 ms
64 bytes from 10.10.20.1: icmp_seq=2 ttl=63 time=0.413 ms
64 bytes from 10.10.20.1: icmp_seq=3 ttl=63 time=0.373 ms

--- 10.10.20.1 ping statistics ---
3 packets transmitted, 3 received, 0% packet loss, time 73ms

```



```
rtt min/avg/max/mdev = 0.373/0.410/0.446/0.037 ms  
VTEP1#
```

CHAPTER 13 VxLAN Trunk Access Port Configuration

In VxLAN, most of the use cases demand to carry the complete traffic received on the access interface to another VTEP access-port. Hence this support of accepting all tagged and untagged traffic received on the mapped physical port.

Topology

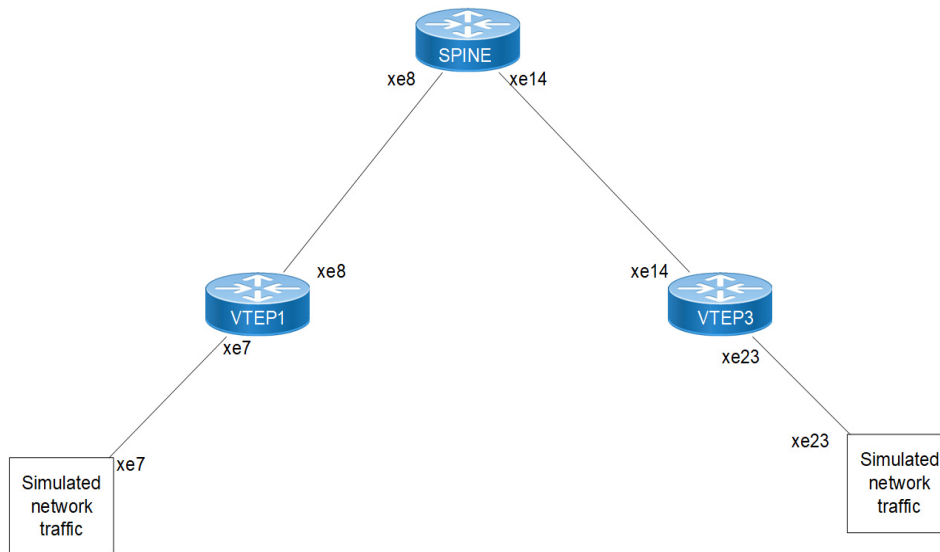

Figure 13-13: VxLAN Trunk Access Port Configuration topology

Base Configuration - L2 VxLAN

VTEP1

Hardware profile and generic configuration:

#configure terminal	Enter Configure mode.
(config)#hardware-profile filter vxlan enable	Enable hardware-profile filter for VxLAN.
(config)#hardware-profile filter egress-ipv4 enable	Enable hardware-profile filter for egress IPv4.
(config)#hardware-profile statistics ac-lif enable	Enable ac-lif for vxlan access-if port counters
(config)#qos enable	Enable qos
(config)#commit	Committing the configurations

Interface and loopback configuration:

(config)#interface xe7	Enter Interface mode for xe7
(config-if)#switchport	Make it L2 interface

(config-if)#exit	Exit Interface mode and return to Configure mode.
(config)#interface xe8	Enter Interface mode for xe8
(config-if)#ip add 10.10.10.1/24	Configuring the ip address in the network side
(config-if)#exit	Exit Interface mode and return to Configure mode.
(config)#interface lo	Enter Interface mode for lo
(config-if)#ip address 1.1.1.1/32 secondary	Configure loopback ip address as 1.1.1.1 for VTEP1
(config-if)#exit	Exit Interface mode and return to Configure mode.
(config)#commit	Committing the interface configurations

OSPF configuration:

(config)#router ospf 1	Enter into router OSPF mode
(config-router)#ospf router-id 1.1.1.1	Configure router-id as 1.1.1.1 (lo ip address)
(config-router)#network 1.1.1.1/32 area 0.0.0.0	Add 1.1.1.1 (lo ip address) network into area 0
(config-router)#network 10.10.10.0/24 area 0.0.0.0	Add 10.10.10.0(Spine) network into area 0
(config-router)#bfd all-interfaces	Enabling bfd on all ospf interface for fast convergence
(config-router)#exit	Exit Interface mode and return to Configure mode.
(config)#commit	Committing the ospf configurations

BGP configuration:

(config)#router bgp 1	Enter into Router BGP mode
(config-router)#bgp router-id 1.1.1.1	Configure router-id as 1.1.1.1 (lo ip address)
(config-router)#neighbor 2.2.2.2 remote-as 1	Specify a VTEP2 loopback ip address and remote-as defined
(config-router)#neighbor 2.2.2.2 update-source lo	Configure update as loopback for VTEP2
(config-router)#neighbor 2.2.2.2 advertisement-interval 0	Configure advertisement-interval as 0 for fast convergence for VTEP2
(config-router)#address-family l2vpn evpn	Enter into l2vpn EVPN address family mode
(config-router-af)#neighbor 2.2.2.2 activate	Activate 2.2.2.2(VTEP2) into l2vpn evpn address family mode
(config-router-af)#exit-address-family	Exit from l2vpn address family mode
(config-router)#exit	Exit from Router BGP mode and enter into config mode
(config)#commit	Committing the bgp configurations

L2 MAC VRF Configuration:

(config)#mac vrf L2VRF1	Create mac routing/forwarding instance with L2VRF1 name and enter into vrf mode
(config-vrf)#rd 1.1.1.1:1	Assign RD value
(config-vrf)#route-target both 1:1	Assign route-target value for same for import and export. Should be same on all node for L2VRF1

(config-vrf)#exit	Exit from vrf mode
(config)#commit	Committing the vrf configurations

L2 VxLAN configuration:

(config)#nvo vxlan enable	Enable VxLAN
(config)#nvo vxlan vtep-ip-global 1.1.1.1	Configure Source vtep-ip-global configuration - Use loopback ip address
(config)#nvo vxlan id 100 ingress-replication	Configure VxLAN Network identifier without inner-vid-disabled configured for vxlan trunk access port and enter into VxLAN tenant mode
(config-nvo)#vxlan host-reachability-protocol evpn-bgp L2VRF1	Assign vrf for evpn-bgp to carry EVPN route
(config-nvo)#exit	Exit from VxLAN tenant mode and enter into configuration mode.
(config)#commit	Committing the vxlan configurations

VTEP2**Hardware profile and generic configuration:**

#configure terminal	Enter Configure mode.
(config)#hardware-profile filter vxlan enable	Enable hardware-profile filter for VxLAN.
(config)#hardware-profile filter egress-ipv4 enable	Enable hardware-profile filter for egress IPv4.
(config)#hardware-profile statistics ac-lif enable	Enable ac-lif for vxlan access-if port counters
(config)#qos enable	Enable qos
(config)#commit	Committing the configurations

Interface and loopback configuration:

(config)#interface xe23	Enter Interface mode for xe23
(config-if)#switchport	Make it L2 interface
(config-if)#exit	Exit Interface mode and return to Configure mode.
(config)#interface xe14	Enter Interface mode for xe14
(config-if)#ip add 20.20.20.1/24	Configuring the ip address in the network side
(config-if)#exit	Exit Interface mode and return to Configure mode.
(config)#interface lo	Enter Interface mode for lo
(config-if)#ip address 2.2.2.2/32 secondary	Configure loopback ip address as 2.2.2.2 for VTEP2
(config-if)#exit	Exit Interface mode and return to Configure mode.
(config)#commit	Committing the interface configurations

OSPF configuration:

(config)#router ospf 1	Enter into router OSPF mode
(config-router)#ospf router-id 2.2.2.2	Configure router-id as 2.2.2.2 (lo ip address)
(config-router)#network 2.2.2.2/32 area 0.0.0.0	Add 2.2.2.2 (lo ip address) network into area 0
(config-router)#network 20.20.20.0/24 area 0.0.0.0	Add 20.20.20.0(Spine) network into area 0
(config-router)#bfd all-interfaces	Enabling bfd on all ospf interface for fast convergence
(config-router)#exit	Exit Interface mode and return to Configure mode.
(config)#commit	Committing the ospf configurations

BGP configuration:

(config)#router bgp 1	Enter into Router BGP mode
(config-router)#bgp router-id 2.2.2.2	Configure router-id as 2.2.2.2 (lo ip address)
(config-router)#neighbor 1.1.1.1 remote-as 1	Specify a VTEP1 loopback ip address and remote-as defined
(config-router)#neighbor 1.1.1.1 update-source lo	Configure update as loopback for VTEP2
(config-router)#neighbor 1.1.1.1 advertisement-interval 0	Configure advertisement-interval as 0 for fast convergence for VTEP1
(config-router)#address-family l2vpn evpn	Enter into l2vpn EVPN address family mode
(config-router-af)#neighbor 1.1.1.1 activate	Activate 1.1.1.1(VTEP1) into l2vpn evpn address family mode
(config-router-af)#exit-address-family	Exit from l2vpn address family mode
(config-router)#exit	Exit from Router BGP mode and enter into config mode
(config)#commit	Committing the bgp configurations

L2 MAC VRF Configuration:

(config)#mac vrf L2VRF1	Create mac routing/forwarding instance with L2VRF1 name and enter into vrf mode
(config-vrf)#rd 2.2.2.2:1	Assign RD value
(config-vrf)#route-target both 1:1	Assign route-target value for same for import and export. Should be same on all node for L2VRF1
(config-vrf)#exit	Exit from vrf mode
(config)#commit	Committing the vrf configurations

L2 VxLAN configuration:

(config)#nvo vxlan enable	Enable VxLAN
(config)#nvo vxlan vtep-ip-global 2.2.2.2	Configure Source vtep-ip-global configuration - Use loopback ip address
(config)#nvo vxlan id 100 ingress-replication	Configure VxLAN Network identifier without inner-vid-disabled configured for vxlan trunk access port and enter into VxLAN tenant mode

(config-nvo)#vxlan host-reachability-protocol evpn-bgp L2VRF1	Assign vrf for evpn-bgp to carry EVPN route
(config-nvo)#exit	Exit from VxLAN tenant mode and enter into configuration mode.
(config)#commit	Committing the vxlan configurations

SPINE

Spine node where all VTEPs are connected.

Generic configuration:

#configure terminal	Enter Configure mode.
(config)#qos enable	Enabling qos
(config)#commit	Committing the configuration

Interface configuration:

(config)#interface xe8	Enter Interface mode for xe8
(config-if)#ip address 10.10.10.2/24	Configure ip address as 10.10.10.2 on network side of VTEP1
(config-if)#exit	Exit Interface mode and return to Configure mode.
(config) interface xe14	Enter into ce5/1 interface mode
(config-if)#ip address 20.20.20.2/24	Configure ip address as 20.20.20.2 on network side of VTEP2
(config-if)#exit	Exit Interface mode and return to Configure mode.
(config) commit	Committing the configuration

OSPF configuration:

(config)#router ospf 1	Enter into router OSPF mode
(config-router)#ospf router-id 3.3.3.3	Configure router-id as 3.3.3.3
(config-router)#network 10.10.10.0/24 area 0.0.0.0	Add 10.10.10.0 (VTEP1) network into area 0
(config-router)#network 20.20.20.0/24 area 0.0.0.0	Add 20.20.20.0 (VTEP2) network into area 0
(config-router)#bfd all-interfaces	Enabling bfd on all ospf interface for fast convergence
(config-if)#exit	Exit Interface mode and return to Configure mode.
(config) commit	Committing the ospf configuration

VxLAN Trunk Access port as default

In VxLAN, most of the use cases demand to carry the complete traffic received on the access interface to another VTEP access-port. Hence this support of accepting all tagged and untagged traffic received on the mapped physical port.

VTEP1

(config)#nvo vxlan access-if port xe7 default	Configuring the vxlan access port as default to receive untagged, single and double tagged traffic
(config-nvo-acc-if)#map vnid 100	Map VxLAN Identified to access-port for VxLAN
(config-nvo-acc-if)#arp-cache disable	Disable arp-cache - mandatory
(config-nvo-acc-if)#nd-cache disable	Disable nd-cache - mandatory
(config-nvo-acc-if)# mac 0000.1111.0001	Configure static mac-only
(config-nvo-acc-if)#exit	Exit from VxLAN access-interface mode and enter into configuration mode
(config)#commit	Committing the vxlan configuration

VTEP2

(config)#nvo vxlan access-if port xe23 default	Configuring the vxlan access port as default to receive untagged, single and double tagged traffic
(config-nvo-acc-if)#map vnid 100	Map VxLAN Identified to access-port for VxLAN
(config-nvo-acc-if)#arp-cache disable	Disable arp-cache - mandatory
(config-nvo-acc-if)#nd-cache disable	Disable nd-cache - mandatory
(config-nvo-acc-if)# mac 0000.2222.0001	Configure static mac-only
(config-nvo-acc-if)#exit	Exit from VxLAN access-interface mode and enter into configuration mode
(config)#commit	Committing the vxlan configuration

Validation**VTEP1**

```
VTEP1#sh run nvo vxlan
!
nvo vxlan enable
!
nvo vxlan vtep-ip-global 1.1.1.1
!
nvo vxlan id 100 ingress-replication
  vxlan host-reachability-protocol evpn-bgp L2VRF1
!
nvo vxlan access-if port xe7 default
  map vnid 100
  arp-cache disable
  nd-cache disable
  mac 0000.1111.0001
!
!
VTEP1#sh nvo vxlan tunnel
VxLAN Network tunnel Entries
Source          Destination      Status          Up/Down         Update
```

```
=====
1.1.1.1          2.2.2.2          Installed          00:02:49          00:02:49
```

Total number of entries are 1
VTEP1#sh nvo vxlan mac-table

```
=====
VxLAN MAC Entries
=====
```

VNID Type	Interface	VlanId Status	Vlan-RangeId AccessPortDesc	Inner-VlanId	Mac-Addr	VTEP-Ip/ESI
100 Static Local	xe7	----	----	----	0000.1111.0001	1.1.1.1
100 Static Remote	----	----	----	0000.2222.0001	2.2.2.2	
100 Dynamic Local	xe7	----	----	----	b0da.1d10.6496	1.1.1.1

Total number of entries are : 3

VTEP1#sh nvo vxlan mac-table hardware

```
=====
VxLAN MAC Entries
=====
```

VNID Type	Interface	VlanId Status	Vlan-RangeId Time-out	Inner-VlanId AccessPortDesc	Mac-Addr	VTEP-Ip/ESI
100 Static Local	xe7	----	----	----	0000.1111.0001	1.1.1.1
100 Remote	---	----	----	----	0000.2222.0001	2.2.2.2
100 Dynamic Local	xe7	----	300	----	b0da.1d10.6496	1.1.1.1

Total number of entries are 3

VTEP1#show nvo vxlan

VxLAN Information

```
=====
Codes: NW - Network Port
       AC - Access Port
       (u) - Untagged
```

VNID Src-Addr	VNI-Name Dst-Addr	VNI-Type	Type	Interface	ESI	VLAN DF-Status
---------------	-------------------	----------	------	-----------	-----	----------------

```

100      ----      L2      NW      ----      ----      ----      ----
1.1.1.1      2.2.2.2
100      ----      --      AC      xe7      --- Single Homed Port ---      ----      ----
-----

```

Total number of entries are 2
VTEP1#sh nvo vxlan route-count
VxLAN Active route count information
=====

```

Max route count      : 32768
Active route count: 3

```

```

-----
  VNID      Total      MACONLY  MACIPv4  MACIPv6
-----
  100      3      3      0      0
-----

```

Total number of entries are 1
VTEP1#sh nvo vxlan access-if-config
nvo vxlan access-if port xe7 default
map vnid 100
arp-cache disable
nd-cache disable
mac 0000.1111.0001

!
VTEP1#sh nvo vxlan access-if brief

```

          Inner          Admin  Link
Interface Vlan  vlan  Ifindex  Vnid      status  status
-----
xe7      ---  ---  500000  100      up      up

```

Total number of entries are 1
VTEP1#sh bgp l2vpn evpn summary
BGP router identifier 1.1.1.1, local AS number 1
BGP table version is 2
1 BGP AS-PATH entries
0 BGP community entries

```

Neighbor      V  AS  MsgRcv  MsgSen  TblVer  InQ  OutQ  Up/Down  State/
PfxRcd      AD  MACIP  MCAST  ESI  PREFIX-ROUTE
2.2.2.2      4  1  15      17      2      0      0  00:04:52
2      0      1      1      0      0

```

Total number of neighbors 1

Total number of Established sessions 1
VTEP1#sh bgp l2vpn evpn
BGP table version is 2, local router ID is 1.1.1.1
Status codes: s suppressed, d damped, h history, a add-path, * valid, > best, i - internal,

1 - labeled, S Stale
 Origin codes: i - IGP, e - EGP, ? - incomplete

[EVPN route type]:[ESI]:[VNID]:[relevent route informantion]
 1 - Ethernet Auto-discovery Route
 2 - MAC/IP Route
 3 - Inclusive Multicast Route
 4 - Ethernet Segment Route
 5 - Prefix Route

Network Encap	Next Hop	Metric	LocPrf	Weight	Path	Peer
RD[1.1.1.1:1] VRF[L2VRF1]:						
*> [2]:[0]:[100]:[48,0000:1111:0001]:[0]:[100]	1.1.1.1	0	100	32768	i	-----
VxLAN						
* i [2]:[0]:[100]:[48,0000:2222:0001]:[0]:[100]	2.2.2.2	0	100	0	i 2.2.2.2	VxLAN
*> [2]:[0]:[100]:[48,b0da:1d10:6496]:[0]:[100]	1.1.1.1	0	100	32768	i	-----
VxLAN						
*> [3]:[100]:[32,1.1.1.1]	1.1.1.1	0	100	32768	i	-----
VxLAN						
* i [3]:[100]:[32,2.2.2.2]	2.2.2.2	0	100	0	i 2.2.2.2	VxLAN
RD[2.2.2.2:1]						
*>i [2]:[0]:[100]:[48,0000:2222:0001]:[0]:[100]	2.2.2.2	0	100	0	i 2.2.2.2	VxLAN
*>i [3]:[100]:[32,2.2.2.2]	2.2.2.2	0	100	0	i 2.2.2.2	VxLAN

Total number of prefixes 7
 VTEP1#sh nvo vxlan arp-cache
 VxLAN ARP-CACHE Information

VNID	Ip-Addr	Mac-Addr	Type	Age-Out	Retries-Left
------	---------	----------	------	---------	--------------

Total number of entries are 0

VTEP1#sh nvo vxlan nd-cache
 VxLAN ND-CACHE Information

VNID	Ip-Addr	Mac-Addr	Type	Age-Out
------	---------	----------	------	---------

Total number of entries are 0

VTEP1#

VTEP2

```
VTEP2#sh run nvo vxlan
!
nvo vxlan enable
!
nvo vxlan vtep-ip-global 2.2.2.2
!
nvo vxlan id 100 ingress-replication
  vxlan host-reachability-protocol evpn-bgp L2VRF1
!
nvo vxlan access-if port xe23 default
  map vnid 100
  arp-cache disable
  nd-cache disable
  mac 0000.2222.0001
!
```

```
VTEP2#sh nvo vxlan tunnel
VxLAN Network tunnel Entries
Source          Destination      Status           Up/Down          Update
=====
2.2.2.2         1.1.1.1         Installed        00:05:47        00:05:47
```

Total number of entries are 1

```
VTEP2#sh nvo vxlan
```

VxLAN Information

=====

```
Codes: NW - Network Port
       AC - Access Port
       (u) - Untagged
```

VNID	VNI-Name	VNI-Type	Type	Interface	ESI	VLAN	DF-Status
Src-Addr	Dst-Addr						
100	----	L2	NW	----	----	----	----
2.2.2.2	1.1.1.1						
100	----	--	AC	xe23	--- Single Homed Port ---	----	----
----	----						

Total number of entries are 2

```
VTEP2#sh nvo vxlan mac-table
```

=====

VxLAN MAC Entries

=====

VNID	Interface	VlanId	Vlan-RangeId	Inner-VlanId	Mac-Addr	VTEP-Ip/ESI
Type	Status		AccessPortDesc			

=====

```

100      ----      ----      ----      0000.1111.0001 1.1.1.1
Static Remote -----
100      xe23      ----      ----      ----      0000.2222.0001 2.2.2.2
Static Local -----
100      ----      ----      ----      b0da.1d10.6496 1.1.1.1
Dynamic Remote -----
    
```

Total number of entries are : 3

VTEP2#sh nvo vxlan mac-table hardware

```

=====
=====
                                     VxLAN MAC Entries
=====
=====
VNID      Interface VlanId Vlan-RangeId Inner-VlanId Mac-Addr      VTEP-Ip/ESI
Type              Status      Time-out  AccessPortDesc
-----
100      ---      ----      ----      0000.1111.0001 1.1.1.1
Remote
100      xe23      ----      ----      0000.2222.0001 2.2.2.2
Static Local
100      ---      ----      ----      b0da.1d10.6496 1.1.1.1
Remote
    
```

Total number of entries are 3

VTEP2#sh nvo vxlan route-count

VxLAN Active route count information

```

=====
Max route count      : 32768
Active route count: 3
    
```

```

-----
VNID      Total      MACONLY  MACIPv4  MACIPv6
-----
100      3          3          0          0
    
```

Total number of entries are 1

VTEP2#sh nvo vxlan access-if br

```

          Inner      Admin      Link
Interface Vlan  vlan  Ifindex  Vnid      status      status
-----
xe23      ---  ---  500000  100      up          up
    
```

Total number of entries are 1

```

VTEP2#sh nvo vxlan access-if-config
nvo vxlan access-if port xe23 default
map vnid 100
arp-cache disable
    
```

```
nd-cache disable
mac 0000.2222.0001
!
```

```
VTEP2#sh nvo vxlan arp-cache
VxLAN ARP-CACHE Information
```

```
=====
VNID      Ip-Addr      Mac-Addr      Type      Age-Out      Retries-Left
```

Total number of entries are 0

```
VTEP2#sh nvo vxlan nd-cache
VxLAN ND-CACHE Information
```

```
=====
VNID      Ip-Addr      Mac-Addr      Type      Age-Out
Retries-Left
```

Total number of entries are 0

```
VTEP2#
VTEP2#sh bgp l2vpn evpn summary
BGP router identifier 2.2.2.2, local AS number 1
BGP table version is 2
1 BGP AS-PATH entries
0 BGP community entries
```

Neighbor	PfxRcd	AD	MACIP	V	AS	MsgRcv	MsgSen	TblVer	InQ	OutQ	Up/Down	State/
				MCAST		ESI	PREFIX-ROUTE					
1.1.1.1				4	1	27	27	1	0	0	00:09:54	
3	0	2	1		0	0						

Total number of neighbors 1

```
Total number of Established sessions 1
VTEP2#sh bgp l2vpn evpn
BGP table version is 2, local router ID is 2.2.2.2
Status codes: s suppressed, d damped, h history, a add-path, * valid, > best, i -
internal,
                l - labeled, S Stale
Origin codes: i - IGP, e - EGP, ? - incomplete
```

```
[EVPN route type]:[ESI]:[VNID]:[relevent route informantion]
1 - Ethernet Auto-discovery Route
2 - MAC/IP Route
3 - Inclusive Multicast Route
4 - Ethernet Segment Route
5 - Prefix Route
```

Network	Next Hop	Metric	LocPrf	Weight	Path	Peer
---------	----------	--------	--------	--------	------	------

Encap

```
RD[1.1.1.1:1]
*>i [2]:[0]:[100]:[48,0000:1111:0001]:[0]:[100]
```

```

1.1.1.1      0      100      0      i  1.1.1.1      VxLAN
*>i  [2]:[0]:[100]:[48,b0da:1d10:6496]:[0]:[100]
1.1.1.1      0      100      0      i  1.1.1.1      VxLAN
*>i  [3]:[100]:[32,1.1.1.1]
1.1.1.1      0      100      0      i  1.1.1.1      VxLAN

RD[2.2.2.2:1] VRF[L2VRF1]:
* i  [2]:[0]:[100]:[48,0000:1111:0001]:[0]:[100]
1.1.1.1      0      100      0      i  1.1.1.1      VxLAN
*>  [2]:[0]:[100]:[48,0000:2222:0001]:[0]:[100]
2.2.2.2      0      100      32768  i  -----
VxLAN
* i  [2]:[0]:[100]:[48,b0da:1d10:6496]:[0]:[100]
1.1.1.1      0      100      0      i  1.1.1.1      VxLAN
* i  [3]:[100]:[32,1.1.1.1]
1.1.1.1      0      100      0      i  1.1.1.1      VxLAN
*>  [3]:[100]:[32,2.2.2.2]
2.2.2.2      0      100      32768  i  -----
VxLAN

Total number of prefixes 8
VTEP2#

```

VxLAN Trunk access port with vlan range

When an access port with a specific vlan range configured, all the traffic in that specific range are accepted and forwarded.

VTEP1

(config)#nvo vxlan access-if port-vlan xe7 2-100	Configuring the vxlan access port with vlan range 2-100 where traffic in the vlan range 2-100 are accepted
(config-nvo-acc-if)#map vnid 100	Map VxLAN Identified to access-port for VxLAN
(config-nvo-acc-if)#arp-cache disable	Disable arp-cache - mandatory
(config-nvo-acc-if)#nd-cache disable	Disable nd-cache - mandatory
(config-nvo-acc-if)# mac 0000.1111.0001	Configure static mac-only
(config-nvo-acc-if)#exit	Exit from VxLAN access-interface mode and enter into configuration mode
(config)#commit	Committing the vxlan configuration

VTEP2

(config)#nvo vxlan access-if port-vlan xe23 2-100	Configuring the vxlan access port with vlan range 2-100 where traffic in the vlan range 2-100 are accepted
(config-nvo-acc-if)#map vnid 100	Map VxLAN Identified to access-port for VxLAN
(config-nvo-acc-if)#arp-cache disable	Disable arp-cache - mandatory
(config-nvo-acc-if)#nd-cache disable	Disable nd-cache - mandatory
(config-nvo-acc-if)# mac 0000.2222.0001	Configure static mac-only

(config-nvo-acc-if)#exit	Exit from VxLAN access-interface mode and enter into configuration mode
(config)#commit	Committing the vxlan configuration

Validations

VTEP1

```
VTEP1#sh run nvo vx
!
nvo vxlan enable
!
nvo vxlan vtep-ip-global 1.1.1.1
!
nvo vxlan id 100 ingress-replication
  vxlan host-reachability-protocol evpn-bgp L2VRF1
!
nvo vxlan access-if port-vlan xe7 2-100
  map vnid 100
  arp-cache disable
  nd-cache disable
  mac 0000.1111.0001
!
!
VTEP1#
VTEP1#sh nvo vxlan tunnel summary
```

Total number of entries: 1 [Installed: 1, Resolved: 0, Unresolved: 0]

Total number of entries are 1

```
VTEP1#sh nvo vxlan tunnel
VxLAN Network tunnel Entries
Source          Destination      Status           Up/Down          Update
=====
1.1.1.1         2.2.2.2         Installed        00:20:10        00:20:10
```

Total number of entries are 1

```
VTEP1#sh nvo vx
VxLAN Information
=====
Codes: NW - Network Port
       AC - Access Port
       (u) - Untagged
```

VNID	VNI-Name	VNI-Type	Type	Interface	ESI	VLAN	DF-Status
Src-Addr	Dst-Addr						
100	----	L2	NW	----	----	----	----
1.1.1.1	2.2.2.2						

```
100      ----      --      AC   xe7      --- Single Homed Port ---      2      ----
-----      -----
```

Total number of entries are 2

VTEP1#sh nvo vxlan mac-table

```
=====
=====
```

VxLAN MAC Entries

```
=====
=====
```

VNID Type	Interface	VlanId Status	Vlan-RangeId AccessPortDesc	Inner-VlanId	Mac-Addr	VTEP-Ip/ESI
-----------	-----------	---------------	-----------------------------	--------------	----------	-------------

100 Static Local	xe7	-----	2-100	----	0000.1111.0001	1.1.1.1
100 Static Remote	----	-----	----		0000.2222.0001	2.2.2.2
100 Dynamic Local	xe7	-----	2-100	----	b0da.1d10.6496	1.1.1.1

Total number of entries are : 3

VTEP1#sh nvo vxlan mac-table hardware

```
=====
=====
```

VxLAN MAC Entries

```
=====
=====
```

VNID Type	Interface	VlanId Status	Vlan-RangeId Time-out	Inner-VlanId AccessPortDesc	Mac-Addr	VTEP-Ip/ESI
-----------	-----------	---------------	-----------------------	-----------------------------	----------	-------------

100 Static Local	xe7	-----	2-100	----	0000.1111.0001	1.1.1.1
100 Remote	---	-----	----		0000.2222.0001	2.2.2.2
100 Dynamic Local	xe7	-----	2-100	----	b0da.1d10.6496	1.1.1.1

Total number of entries are 3

VTEP1#sh nvo vxlan arp-cache

VxLAN ARP-CACHE Information

```
=====
```

VNID	Ip-Addr	Mac-Addr	Type	Age-Out	Retries-Left
------	---------	----------	------	---------	--------------

Total number of entries are 0

VTEP1#sh nvo vxlan nd-cache

VxLAN ND-CACHE Information

```
=====
```

VNID	Ip-Addr	Mac-Addr	Type	Age-Out
------	---------	----------	------	---------

Retries-Left

```

Total number of entries are 0
VTEP1#sh nvo vxlan access-if-config
nvo vxlan access-if port-vlan xe7 2-100
  map vnid 100
  arp-cache disable
  nd-cache disable
  mac 0000.1111.0001
!
VTEP1#sh nvo vxlan access-if brief

```

Interface	Vlan	Inner vlan	Ifindex	Vnid	Admin status	Link status
xe7	2	---	500000	100	up	up

```

Total number of entries are 1
VTEP1#
VTEP1#sh nvo vxlan route-count
VxLAN Active route count information
=====
Max route count      : 32768
Active route count: 3

```

VNID	Total	MACONLY	MACIPv4	MACIPv6
100	3	3	0	0

```

Total number of entries are 1
VTEP1#sh bgp l2vpn evpn summary
BGP router identifier 1.1.1.1, local AS number 1
BGP table version is 5
1 BGP AS-PATH entries
0 BGP community entries

```

Neighbor PfxRcd	AD	MACIP	V MCAST	AS	MsgRcv ESI	MsgSen PREFIX-ROUTE	TblVer	InQ	OutQ	Up/Down	State/
2.2.2.2			4	1	58	61	5	0	0	00:22:05	
2	0	1	1	0	0						

Total number of neighbors 1

```

Total number of Established sessions 1
VTEP1#sh bgp l2vpn evpn
BGP table version is 5, local router ID is 1.1.1.1
Status codes: s suppressed, d damped, h history, a add-path, * valid, > best, i -
internal,
                l - labeled, S Stale
Origin codes: i - IGP, e - EGP, ? - incomplete

```

[EVPN route type]:[ESI]:[VNID]:[relevent route informantion]

- 1 - Ethernet Auto-discovery Route
- 2 - MAC/IP Route
- 3 - Inclusive Multicast Route
- 4 - Ethernet Segment Route
- 5 - Prefix Route

Network	Next Hop	Metric	LocPrf	Weight	Path	Peer
Encap						
RD[1.1.1.1:1] VRF[L2VRF1]:						
*> [2]:[0]:[100]:[48,0000:1111:0001]:[0]:[100]	1.1.1.1	0	100	32768	i	-----
VxLAN						
* i [2]:[0]:[100]:[48,0000:2222:0001]:[0]:[100]	2.2.2.2	0	100	0	i 2.2.2.2	VxLAN
*> [2]:[0]:[100]:[48,b0da:1d10:6496]:[0]:[100]	1.1.1.1	0	100	32768	i	-----
VxLAN						
*> [3]:[100]:[32,1.1.1.1]	1.1.1.1	0	100	32768	i	-----
VxLAN						
* i [3]:[100]:[32,2.2.2.2]	2.2.2.2	0	100	0	i 2.2.2.2	VxLAN
RD[2.2.2.2:1]						
*>i [2]:[0]:[100]:[48,0000:2222:0001]:[0]:[100]	2.2.2.2	0	100	0	i 2.2.2.2	VxLAN
*>i [3]:[100]:[32,2.2.2.2]	2.2.2.2	0	100	0	i 2.2.2.2	VxLAN

Total number of prefixes 7

VTEP2

```
VTEP2#sh run nvo vxlan
!
nvo vxlan enable
!
nvo vxlan vtep-ip-global 2.2.2.2
!
nvo vxlan id 100 ingress-replication
  vxlan host-reachability-protocol evpn-bgp L2VRF1
!
nvo vxlan access-if port-vlan xe23 2-100
  map vnid 100
  arp-cache disable
  nd-cache disable
  mac 0000.2222.0001
!
```

```

!
VTEP2#sh nvo vxlan tunnel
VxLAN Network tunnel Entries
Source          Destination      Status          Up/Down         Update
=====
2.2.2.2         1.1.1.1         Installed       00:19:28       00:19:28
    
```

Total number of entries are 1

```

VTEP2#sh nvo vxlan tunnel
VxLAN Network tunnel Entries
Source          Destination      Status          Up/Down         Update
=====
2.2.2.2         1.1.1.1         Installed       00:21:06       00:21:06
    
```

Total number of entries are 1

```

VTEP2#sh nvo vxlan
VxLAN Information
=====
Codes: NW - Network Port
       AC - Access Port
       (u) - Untagged
    
```

VNID	VNI-Name	VNI-Type	Type	Interface	ESI	VLAN	DF-Status
Src-Addr	Dst-Addr						
100	----	L2	NW	----	----	----	----
2.2.2.2	1.1.1.1						
100	----	--	AC	xe23	--- Single Homed Port ---	2	----
----	----						

Total number of entries are 2

```

VTEP2#sh nvo vxlan mac-table
=====
    
```

VxLAN MAC Entries

VNID	Interface	VlanId	Vlan-RangeId	Inner-VlanId	Mac-Addr	VTEP-Ip/ESI
Type	Status	AccessPortDesc				
100	----	----	----		0000.1111.0001	1.1.1.1
Static Remote	-----	-----				
100	xe23	-----	2-100	----	0000.2222.0001	2.2.2.2
Static Local	-----	-----				
100	----	----	----		b0da.1d10.6496	1.1.1.1
Dynamic Remote	-----	-----				

Total number of entries are : 3

```

VTEP2#sh nvo vxlan mac-table hardware
    
```

VxLAN MAC Entries

VNID Type	Interface	VlanId Status	Vlan-RangeId Time-out	Inner-VlanId AccessPortDesc	Mac-Addr	VTEP-Ip/ESI
100 Remote	---	----	----		0000.1111.0001	1.1.1.1
100 Static Local	xe23	-----	2-100	----	0000.2222.0001	2.2.2.2
100 Remote	---	----	----		b0da.1d10.6496	1.1.1.1

Total number of entries are 3
VTEP2#sh nvo vxlan route-count
VxLAN Active route count information
=====

Max route count : 32768
Active route count: 3

VNID	Total	MACONLY	MACIPv4	MACIPv6
100	3	3	0	0

Total number of entries are 1
VTEP2#sh nvo vxlan arp-cache
VxLAN ARP-CACHE Information
=====

VNID	Ip-Addr	Mac-Addr	Type	Age-Out	Retries-Left
------	---------	----------	------	---------	--------------

Total number of entries are 0
VTEP2#sh nvo vxlan nd-cache
VxLAN ND-CACHE Information
=====

VNID	Ip-Addr	Mac-Addr	Type	Age-Out
------	---------	----------	------	---------

Total number of entries are 0
VTEP2#
VTEP2#
VTEP2#sh nvo vxlan access-if brief

Interface	Vlan	Inner vlan	Ifindex	Vnid	Admin status	Link status
xe23	2	---	500000	100	up	up

Total number of entries are 1
VTEP2#sh nvo vxlan access-if-config
nvo vxlan access-if port-vlan xe23 2-100
map vnid 100
arp-cache disable
nd-cache disable
mac 0000.2222.0001
!

VTEP2#sh bgp l2vpn evpn summary
BGP router identifier 2.2.2.2, local AS number 1
BGP table version is 4
1 BGP AS-PATH entries
0 BGP community entries

Neighbor PfxRcd	AD	MACIP	V MCAST	AS	MsgRcv ESI	MsgSen PREFIX-ROUTE	TblVer	InQ	OutQ	Up/Down	State/
1.1.1.1			4	1	59	57	3	0	0	00:21:48	
3	0	2	1	0	0						

Total number of neighbors 1

Total number of Established sessions 1

VTEP2#sh bgp l2vpn evpn
BGP table version is 4, local router ID is 2.2.2.2
Status codes: s suppressed, d damped, h history, a add-path, * valid, > best, i - internal,
l - labeled, S Stale
Origin codes: i - IGP, e - EGP, ? - incomplete

[EVPN route type]:[ESI]:[VNID]:[relevent route informantion]
1 - Ethernet Auto-discovery Route
2 - MAC/IP Route
3 - Inclusive Multicast Route
4 - Ethernet Segment Route
5 - Prefix Route

Network Encap	Next Hop	Metric	LocPrf	Weight	Path	Peer
RD[1.1.1.1:1]						
*>i [2]:[0]:[100]:[48,0000:1111:0001]:[0]:[100]	1.1.1.1	0	100	0	i 1.1.1.1	VxLAN
*>i [2]:[0]:[100]:[48,b0da:1d10:6496]:[0]:[100]	1.1.1.1	0	100	0	i 1.1.1.1	VxLAN
*>i [3]:[100]:[32,1.1.1.1]	1.1.1.1	0	100	0	i 1.1.1.1	VxLAN
RD[2.2.2.2:1] VRF[L2VRF1]:						
* i [2]:[0]:[100]:[48,0000:1111:0001]:[0]:[100]	1.1.1.1	0	100	0	i 1.1.1.1	VxLAN

```

*> [2]:[0]:[100]:[48,0000:2222:0001]:[0]:[100]
      2.2.2.2          0          100          32768 i -----
VxLAN
* i [2]:[0]:[100]:[48,b0da:1d10:6496]:[0]:[100]
      1.1.1.1          0          100          0 i 1.1.1.1          VxLAN
* i [3]:[100]:[32,1.1.1.1]
      1.1.1.1          0          100          0 i 1.1.1.1          VxLAN
*> [3]:[100]:[32,2.2.2.2]
      2.2.2.2          0          100          32768 i -----
VxLAN

Total number of prefixes 8
VTEP2#

```

CHAPTER 14 DHCP Relay Over IRB Interface

This chapter contains configurations for DHCP relay over IRB interface.

Overview

Dynamic Host Configuration Protocol (DHCP) is a protocol that allows a DHCP server to dynamically allocate IP addresses to DHCP clients. The DHCP relay agent forwards DHCP messages between DHCP clients and DHCP servers when they are on different networks.

For DHCP relay to function, uplink interface (server facing) and downlink interface (client facing) are to be configured along with DHCP server address. These configurations are done in the interface mode.

In the IRB deployment, IRB interface acts as gateway and hence it might need to provide the service of DHCP for the hosts connected to IRB network per L2 VPN. Since the DHCP server will not be present in the VTEP, it can forward the DHCP requests to the DHCP server acting as relay agent.

Topology

The procedures in this section use the topology in [Figure 14-14](#).



Figure 14-14: DHCP Relay over IRB

ROUTER-1

#configure terminal	Enter Configure mode.
(config)#interface lo	Enter Interface mode for loopback.
(config-if)#ip address 1.1.1.1/32 secondary	Assign secondary IP address.
(config-if)#exit	Exit Interface mode and return to Configure mode.
(config)#hardware-profile filter vxlan enable	Enable hardware-profile filter for VxLAN.
(config)#nvo vxlan enable	Enable VxLAN
(config)#nvo vxlan irb	Enable VxLAN IRB
(config)#ip vrf vrf1	Create routing/forwarding instance with VRF1 name and enter into VRF mode
(config-vrf)#rd 200:1	Assign RD value
(config-vrf)#route-target both 200:1	Assign route target value
(config-vrf)#ip dhcp relay address 40.40.40.1	The relay address configured should be server interface address connected to DUT machine
(config-vrf)#ip dhcp relay uplink evpn	Configure the uplink interface as L3 VNI interface for specific VRF
(config-vrf)#l3vni 45001	Configure L3VNI as 45001 for VRF1

(config-vrf)#exit	Exit IP VRF mode
(config)#mac vrf vrfred	Create MAC VRF instance with vrfred name and enter into VRF mode
(config-vrf)#rd 1.1.1.1:1	Assign RD value
(config-vrf)#route-target both 1.1.1.1:1	Assign route target value
(config-vrf)#exit	Exit MAC VRF mode
(config)#interface irb 1	Configure IRB interface
(config-irb-if)#ip vrf forwarding vrf1	Configure IP VRF forwarding
(config-irb-if)#ip address 11.1.1.1/24	Assign IP address on IRB interface.
(config-irb-if)#ip dhcp relay	Relay should be configured on the interface connecting to the relay
(config-irb-if)#exit	Exit IRB interface mode
(config)#interface irb 2	Configure irb interface
(config-irb-if)#ip vrf forwarding vrf1	Configure IP VRF forwarding
(config-irb-if)#ip address 70.70.70.1/24	Assign IP address on IRB interface.
(config-irb-if)#exit	Exit IRB interface mode
(config)#interface ce49	Enter Interface mode for ce49.
(config-if)#ip address 10.1.1.0/31	Assign IP address on ce49 interface.
(config-if)#exit	Exit Interface mode and return to Configure mode.
(config)#interface xe5	Enter Interface mode for xe5.
(config-if)#switchport	Configure interface as L2 interface
(config-if)#exit	Exit Interface mode and return to Configure mode.
(config)#router ospf	Enter the Router OSPF mode
(config-router)#network 1.1.1.1/32 area 0.0.0.0	Advertise loopback address in OSPF
(config-router)#network 10.1.1.0/31 area 0.0.0.0	Advertise network address in OSPF
(config-router)#exit	Exit from Router OSPF mode and enter into config mode
(config)#router bgp 1	Enter into BGP router mode
(config-router)#neighbor 2.2.2.2 remote-as 1	Specify a VTEP2 loopback IP address and remote-as defined
(config-router)#neighbor 2.2.2.2 update-source 1.1.1.1	Configure update as loopback for VTEP2
(config-router)#address-family l2vpn evpn	Enter into L2VPN EVPN address family mode
(config-router-af)#neighbor 2.2.2.2 activate	Activate neighbor in L2VPN mode
(config-router-af)#exit-address-family	Exit from Address family mode
(config-router)#address-family ipv4 vrf vrf1	Enter into address-family mode for VRF1
(config-router-af)#redistribute connected	Configure Redistribute connected
(config-router-af)#exit-address-family	Exit from Address family mode
(config-router)#exit	Exit from router BGP mode and enter into config mode
(config)#nvo vxlan vtep-ip-global 1.1.1.1	Configure Source VTEP-IP-global configuration. Use loopback IP address
(config)#nvo vxlan id 10 ingress-replication inner-vid-disabled	Configure VxLAN Network identifier with/without inner-vid-disabled configure and enter into VxLAN tenant mode

(config-nvo)#vxlan host-reachability-protocol evpn-bgp vrfred	Assign VRF for EVPN-BGP to carry EVPN route
(config-nvo)#evpn irb1	Configure IRB1 under VxLAN ID 10
(config-nvo)#exit	Exit from VxLAN tenant mode and enter into configuration mode.
(config)#nvo vxlan id 30 ingress-replication inner-vid-disabled	Configure VxLAN Network identifier with/without inner-vid-disabled configure and enter into VxLAN tenant mode
(config-nvo)#vxlan host-reachability-protocol evpn-bgp vrfred	Assign VRF for EVPN-BGP to carry EVPN route
(config-nvo)#evpn irb2	Configure IRB2 under VxLAN ID 30
(config-nvo)#exit	Exit from VxLAN tenant mode and enter into configuration mode.
(config)#nvo vxlan access-if port-vlan xe5 2	Enable port-VLAN mapping i.e. access port to outer-VLAN (SVLAN) - Multihomed access port
(config-nvo-acc-if)#map vnid 10	Map VxLAN Identified to access-port for VxLAN
(config-nvo-acc-if)#exit	Exit from VxLAN access-interface mode and enter into configuration mode
(config)#commit	Commit the candidate configuration to the running configuration
(config)#exit	Exit from configuration mode

ROUTER-2

#configure terminal	Enter Configure mode.
(config)#interface ce0	Enter Interface mode for ce0.
(config-if)#ip address 10.1.1.1/31	Assign IP address on ce0 interface.
(config-if)#exit	Exit Interface mode and return to Configure mode.
(config)#interface xe13	Enter Interface mode for xe13.
(config-if)#ip address 30.1.1.1/31	Assign IP address on xe13 interface.
(config-if)#exit	Exit Interface mode and return to Configure mode.
(config)#router ospf	Enter the Router OSPF mode
(config-router)#network 10.1.1.0/24 area 0.0.0.0	Advertise network address in OSPF
(config-router)#network 30.30.30.0/24 area 0.0.0.0	Advertise network address in OSPF
(config-router)#exit	Exit from Router OSPF mode and enter into config mode
(config)#commit	commit the candidate configuration to the running configuration
(config)#exit	Exit from configuration mode

ROUTER-3

#configure terminal	Enter Configure mode.
(config)#interface lo	Enter Interface mode for loopback.
(config-if)#ip address 2.2.2.2/32 secondary	Assign secondary IP address.
(config-if)#exit	Exit Interface mode and return to Configure mode.

(config)#hardware-profile filter vxlan enable	Enable hardware-profile filter for VxLAN.
(config)#nvo vxlan enable	Enable VxLAN
(config)#nvo vxlan irb	Enable VxLAN IRB
(config)#ip vrf vrf1	Create routing/forwarding instance with VRF1 name and enter into VRF mode
(config-vrf)#rd 300:1	Assign RD value
(config-vrf)#route-target both 200:1	Assign route target value
(config-vrf)#ip dhcp relay uplink evpn	Configure the uplink interface as L3 VNI interface for specific VRF
(config-vrf)#l3vni 45001	Configure L3VNI as 45001 for VRF1
(config-vrf)#exit	Exit IP VRF mode
(config)#mac vrf vrfred	Create MAC VRF instance with vrfred name and enter into VRF mode
(config-vrf)#rd 2.2.2.1:1	Assign RD value
(config-vrf)#route-target both 1.1.1.1:1	Assign route target value
(config-vrf)#exit	Exit MAC VRF mode
(config)#interface irb 2	Configure IRB interface
(config-irb-if)#ip vrf forwarding vrf1	Configure IP VRF forwarding
(config-irb-if)#ip address 40.40.40.2/24	Assign IP address on IRB interface.
(config-irb-if)#exit	Exit IRB interface mode
(config)#interface xe13	Enter Interface mode for xe13.
(config-if)#ip address 30.1.1.0/31	Assign IP address on xe13 interface.
(config-if)#exit	Exit Interface mode and return to Configure mode.
(config)#interface xe19	Enter Interface mode for xe19.
(config-if)#switchport	Configure interface as L2 interface
(config-if)#exit	Exit Interface mode and return to Configure mode.
(config)#router ospf	Enter the Router OSPF mode
(config-router)#network 2.2.2.2/32 area 0.0.0.0	Advertise loopback address in OSPF
(config-router)#network 30.1.1.0/24 area 0.0.0.0	Advertise network address in OSPF
(config-router)#network 40.1.1.0/24 area 0.0.0.0	Advertise network address in OSPF
(config-router)#exit	Exit from Router OSPF mode and enter into config mode
(config)#router bgp 1	Enter into BGP router mode
(config-router)#neighbor 1.1.1.1 remote-as 1	Specify a VTEP1 loopback IP address and remote-as defined
(config-router)#neighbor 1.1.1.1 update-source 2.2.2.2	Configure update as loopback for VTEP1
(config-router)#address-family l2vpn evpn	Enter into L2VPN EVPN address family mode
(config-router-af)#neighbor 1.1.1.1 activate	Activate neighbor in L2VPN mode
(config-router-af)#exit-address-family	Exit from Address family mode
(config-router)#address-family ipv4 vrf vrf1	Enter into address-family mode for VRF1
(config-router-af)#redistribute connected	Configure Redistribute connected

(config-router-af)#exit-address-family	Exit from Address family mode
(config-router)#exit	Exit from router BGP mode and enter into config mode
(config)#nvo vxlan vtep-ip-global 2.2.2.2	Configure Source VTEP-IP-global configuration. Use loopback IP address
(config)#nvo vxlan id 10 ingress-replication inner-vid-disabled	Configure VxLAN Network identifier with/without inner-vid-disabled configure and enter into VxLAN tenant mode
(config-nvo)#vxlan host-reachability-protocol evpn-bgp vrfred	Assign VRF for EVPN-BGP to carry EVPN route
(config-nvo)#exit	Exit from VxLAN tenant mode and enter into configuration mode.
(config)#nvo vxlan id 20 ingress-replication inner-vid-disabled	Configure VxLAN Network identifier with/without inner-vid-disabled configure and enter into VxLAN tenant mode
(config-nvo)#vxlan host-reachability-protocol evpn-bgp vrfred	Assign VRF for EVPN-BGP to carry EVPN route
(config-nvo)#evpn irb2	Configure IRB2 under VxLAN ID 20
(config-nvo)#exit	Exit from VxLAN tenant mode and enter into configuration mode.
(config)#nvo vxlan access-if port xe19	Enable port mapping i.e. access port
(config-nvo-acc-if)#map vnid 20	Map VxLAN Identified to access-port for VxLAN
(config-nvo-acc-if)#exit	Exit from VxLAN access-interface mode and enter into configuration mode
(config)#commit	Commit the candidate configuration to the running configuration
(config)#exit	Exit from configuration mode

Validation

ROUTER-1

```

VTEP1#show running-config nvo vxlan
!
nvo vxlan enable
!
nvo vxlan irb
!
nvo vxlan vtep-ip-global 1.1.1.1
!
nvo vxlan id 10 ingress-replication inner-vid-disabled
  vxlan host-reachability-protocol evpn-bgp vrfred
  evpn irb1
!
nvo vxlan id 30 ingress-replication inner-vid-disabled
  vxlan host-reachability-protocol evpn-bgp vrfred
  evpn irb2
!
nvo vxlan access-if port xe2
  map vnid 10
!
nvo vxlan access-if port-vlan xe5 2
  map vnid 10

```

```
!
VTEP1#show ip dhcp relay
DHCP relay service is Enabled.
VRF Name: vrf1
Option 82: Disabled
DHCP Servers configured: 40.40.40.1
```

```
Interface                Uplink/Downlink
-----                -
irb1                    Downlink
evpn                    uplink
```

Incoming DHCPv4 packets which already contain relay agent option are FORWARDED unchanged.

```
VTEP1#show nvo vxlan mac-table
```

```
=====
VxLAN MAC Entries
=====
```

VNID	Interface	VlanId	Vlan-RangeId	Inner-VlanId	Mac-Addr	VTEP-Ip/ESI	Type	Status
10	xe5	2	----	----	0000.2837.ddf5	1.1.1.1	Dynamic Local	-----
10	irb1			b86a.97f9.85be	1.1.1.1		Static Local	-----
30	irb2			b86a.97f9.85be	1.1.1.1		Static Local	-----

Total number of entries are : 3

```
VTEP1#show nvo vxlan arp-cache
VxLAN ARP-CACHE Information
```

```
=====
```

VNID	Ip-Addr	Mac-Addr	Type	Age-Out	Retries-Left
30	70.70.70.1	b86a.97f9.85be	Static Local	----	
10	11.1.1.1	b86a.97f9.85be	Static Local	----	
10	11.1.1.30	0000.2837.ddf5	Dynamic Local	----	

Total number of entries are 3

```
VTEP1#show nvo vxlan tunnel
VxLAN Network tunnel Entries
```

```
=====
```

Source	Destination	Status	Up/Down	Update
1.1.1.1	2.2.2.2	Installed	01:51:11	01:51:11

Total number of entries are 1

ROUTER-2

```
VTEP2#show running-config nvo vxlan
!
nvo vxlan enable
!
nvo vxlan irb
!
```

```

nvo vxlan vtep-ip-global 2.2.2.2
!
nvo vxlan id 10 ingress-replication inner-vid-disabled
  vxlan host-reachability-protocol evpn-bgp vrfred
!
nvo vxlan id 20 ingress-replication inner-vid-disabled
  vxlan host-reachability-protocol evpn-bgp vrfred
  evpn irb2
!
nvo vxlan access-if port xe19
  map vnid 20
!
!

```

```
VTEP2#show nvo vxlan arp-cache
```

```
VxLAN ARP-CACHE Information
```

```
=====
```

VNID	Ip-Addr	Mac-Addr	Type	Age-Out	Retries-Left
20	40.40.40.2	b86a.9761.ea3d	Static	Local	----
20	40.40.40.1	0002.a54f.1577	Dynamic	Local	----
20	40.40.40.101	0000.2837.ddf3	Dynamic	Local	----
10	11.1.1.1	b86a.97f9.85be	Static	Remote	----
10	11.1.1.30	0000.2837.ddf6	Dynamic	Remote	----

```
Total number of entries are 5
```

```
VTEP2#show running-config dhcp
```

```
interface eth0
  ip address dhcp
!
!
```

```
ip vrf vrf1
  ip dhcp relay uplink evpn
```

CHAPTER 15 VxLAN Eline xConnect Configuration

This chapter contains examples of VxLAN Eline xConnect using single-homed and multi-homed topologies.

Vxlan Eline xConnect is a mechanism for a point-to-point tunnel for data and control packets from one leaf to another. It helps in achieving pseudowire between two endpoints. Since there are only two endpoints in this, there is no need for MAC learning and hence the differentiation of Unicast/Broadcast-Unicast-Multicast traffic is not seen. Inner Tags are preserved and VxLAN encapsulated within the outer VNID which is specified as the Xconnect VNID.

Single-Homed VxLAN Eline xConnect

Topology

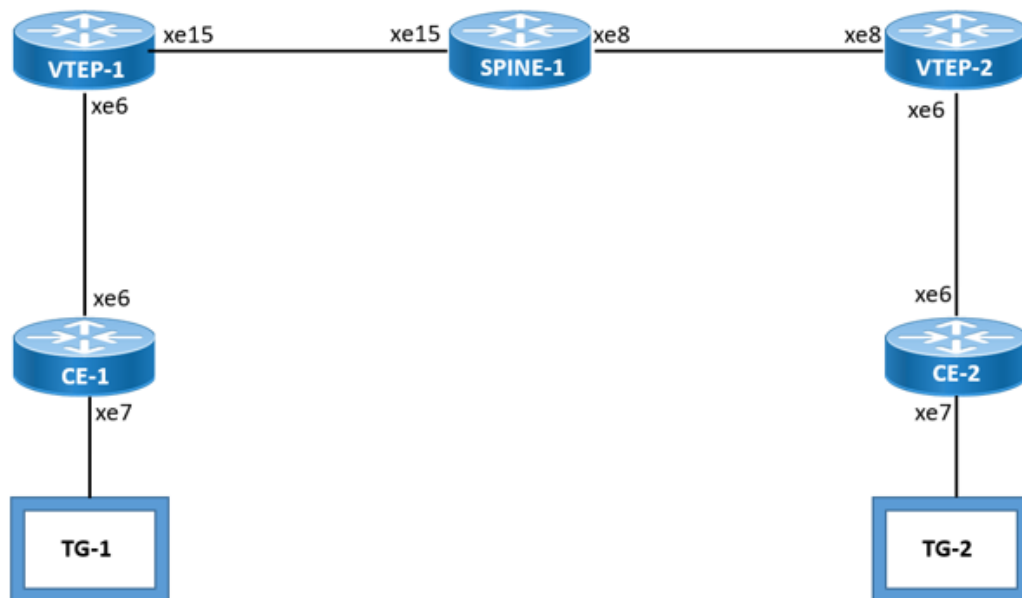

Figure 15-15: Single-homed VxLAN Eline xConnect topology

L2, IPv4, and IPv6 traffic streams are sent from TG-1 and TG-2.

CE1

(config)#hostname CE1	Configure host name
(config)#bridge 1 protocol ieee vlan-bridge	Configure bridge as IEEE VLAN bridge
(config)#interface xe6	Enter interface mode
(config-if)#switchport	Configure the interface as switchport
(config-if)#exit	Exit interface mode
(config)#interface xe7	Enter interface mode
(config-if)#switchport	Configure the interface as switchport

(config-if)#bridge-group 1	Associate bridge to an interface.
(config-if)#switchport mode trunk	Configure port as a trunk.
(config-if)#switchport trunk allowed vlan all	Allow all VLANs on the interface.
(config-if)#commit	Commit the candidate configuration to the running configuration.

VTEP-1

#con t	Enter configure mode
(config)#hostname VTEP-1	Configure host name
(config)#hardware-profile filter vxlan enable	Enable hardware-profile filter for VxLAN
(config)#hardware-profile statistics ingress-acl enable	Configure hardware profile statistics ingress-acl
(config)#nvo vxlan enable	Enable VxLAN globally on this vtep
(config)#mac vrf evpn_sh	Configure a new VRF
(config-vrf)#rd 1.1.1.1:1	Assign the Route Distinguisher value.
(config-vrf)#route-target both 10:1	Configure route target to import and export the routes
(config-vrf)#exit	Exit vrf mode
(config)#bridge 1 protocol ieee vlan-bridge	Configure bridge as IEEE VLAN bridge
(config)#interface xe6	Enter interface mode
(config-if)#switchport	Configure the interface as switchport
(config-if)#exit	Exit interface mode
(config)#interface xe15	Enter interface mode
(config-if)#ip address 10.10.10.1/24	Configure IP address on the interface
(config-if)#exit	Exit interface mode
(config)#interface lo	Enter interface mode
(config-if)#ip address 1.1.1.1/32 secondary	Configure IP address on the interface
(config-if)#exit	Exit interface mode
(config)#router ospf 100	Enter router mode for OSPF
(config-router)#bfd all-interfaces	Enable BFD for all-interface into OSPF
(config-router)#network 1.1.1.1/32 area 0.0.0.0	Add 1.1.1.1 network into area 0
(config-router)#network 10.10.10.0/24 area 0.0.0.0	Add 10.10.10.0 network into area 0
(config)#router bgp 100	Enter BGP router mode
(config-router)#bgp router-id 1.1.1.1	Assign BGP router ID
(config-router)#neighbor 2.2.2.2 remote-as 100	Specify a neighbor router with peer ip address and remote-as defined
(config-router)#neighbor 2.2.2.2 update-source lo	Specify the neighbor to use loopback address as source
(config-router)#address-family l2vpn evpn	Enter into l2vpn address family mode
(config-router-af)#neighbor 2.2.2.2 activate	Activate the peer into address family mode

(config-router-af)#exit-address-family	Exit I2vpn address family mode
(config-router)#exit	Exit BGP router mode
(config)#nvo vxlan vtep-ip-global 1.1.1.1	Configure Source vtep-ip-global configuration
(config)#nvo vxlan id 10 xconnect target-vxlan-id 20	add a tenant and the type of VPN. This creates an ELAN with source and target identifier for ELINE XConnect
(config-nvo)#vxlan host-reachability-protocol evpn-bgp evpn_sh	Set the host reachable protocol to Ethernet-
(config-nvo)#nvo vxlan access-if port-vlan xe6 2	Map the access port xe6 of this VTEP with vlan 2
(config-nvo-acc-if)#map vnid 10	Map the VNID to access-port
(config-nvo-acc-if)#commit	Commit the candidate configuration to the running configuration.

SPINE-1

(config)#hostname SPINE-1	Configure hostname
(config)#hardware-profile statistics ingress-acl enable	Configure hardware profile statistics ingress-acl
(config)#interface xe8	Enter interface mode
(config-if)#ip address 20.20.20.1/24	Configure IP address on the interface
(config-if)#exit	Exit interface mode
(config)#interface xe15	Enter interface mode
(config-if)#ip address 10.10.10.2/24	Configure IP address on the interface
(config-if)#exit	Exit interface mode
(config)#router ospf 100	Enter OSPF router mode
(config-router)#bfd all-interfaces	Enable BFD for all-interface into OSPF
(config-router)#network 10.10.10.0/24 area 0.0.0.0	Add 10.10.10.0 network into area 0
(config-router)#network 20.20.20.0/24 area 0.0.0.0	Add 20.20.20.0 network into area 0
(config-router)#commit	Commit the candidate configuration to the running configuration.

VTEP-2

#con t	Enter configure mode
(config)#hostname VTEP-2	Configure hostname
(config)#hardware-profile filter vxlan enable	Enable hardware-profile filter for VxLAN
(config)#hardware-profile statistics ingress-acl enable	Configure hardware profile statistics ingress-acl
(config)#nvo vxlan enable	Enable VxLAN globally on this vtep
(config)#mac vrf evpn_sh	Configure a new VRF
(config-vrf)#rd 2.2.2.2:1	Assign the Route Distinguisher value.
(config-vrf)#route-target both 10:1	Configure route target to import and export the routes

<code>(config-vrf)#exit</code>	Exit vrf mode
<code>(config)#bridge 1 protocol ieee vlan-bridge</code>	Configure bridge as IEEE VLAN bridge
<code>(config)#interface xe6</code>	Enter interface mode
<code>(config-if)#switchport</code>	Configure the interface as switchport
<code>(config-if)#exit</code>	Exit interface mode
<code>(config)#interface xe8</code>	Enter interface mode
<code>(config-if)#ip address 20.20.20.2/24</code>	Configure IP address on the interface
<code>(config-if)#exit</code>	Exit interface mode
<code>(config)#interface lo</code>	Enter interface mode
<code>(config-if)#ip address 2.2.2.2/32 secondary</code>	Configure IP address on the interface
<code>(config-if)#exit</code>	Exit interface mode
<code>(config)#router ospf 100</code>	Enter into router ospf mode
<code>(config-router)#bfd all-interfaces</code>	Enable BFD for all-interface into OSPF
<code>(config-router)#network 2.2.2.2/32 area 0.0.0.0</code>	Add lo ip address 2.2.2.2 as network into area 0
<code>(config-router)#network 20.20.20.0/24 area 0.0.0.0</code>	Add 20.20.20.0 network into area 0
<code>(config-router)#exit</code>	Exit router mode
<code>(config)#router bgp 100</code>	Enter BGP router mode
<code>(config-router)#bgp router-id 2.2.2.2</code>	Assign BGP router ID
<code>(config-router)#neighbor 1.1.1.1 remote-as 100</code>	Specify a neighbor router with peer ip address and remote-as defined
<code>(config-router)#neighbor 1.1.1.1 update-source lo</code>	Specify the neighbor to use loopback address as source
<code>(config-router)#address-family l2vpn evpn</code>	Enter into l2vpn address family mode
<code>(config-router-af)#neighbor 1.1.1.1 activate</code>	Activate the peer into address family mode
<code>(config-router-af)#exit-address-family</code>	Exit l2vpn address family mode
<code>(config-router)#exit</code>	Exit BGP router mode
<code>(config)#nvo vxlan vtep-ip-global 2.2.2.2</code>	Configure Source vtep-ip-global configuration
<code>(config)#nvo vxlan id 20 xconnect target-vxlan-id 10</code>	add a tenant and the type of VPN. This creates an ELAN with source and target identifier for ELINE XConnect
<code>(config-nvo)#vxlan host-reachability-protocol evpn-bgp evpn_sh</code>	Set the host reachable protocol to Ethernet-
<code>(config-nvo)#nvo vxlan access-if port-vlan xe6 2</code>	Map the access port xe6 of this VTEP with vlan 2
<code>(config-nvo-acc-if)#map vnid 20</code>	Map the VNID to access-port
<code>(config-nvo-acc-if)#commit</code>	Commit the candidate configuration to the running configuration.

CE2

<code>(config)#hostname CE1</code>	Configure host name
<code>(config)#bridge 1 protocol ieee vlan-bridge</code>	Configure bridge as IEEE VLAN bridge
<code>(config)#interface xe6</code>	Enter interface mode

(config-if)#switchport	Configure the interface as switchport
(config-if)#exit	Exit interface mode
(config)#interface xe7	Enter interface mode
(config-if)#switchport	Configure the interface as switchport
(config-if)#bridge-group 1	Associate bridge to an interface.
(config-if)#switchport mode trunk	Configure port as a trunk.
(config-if)#switchport trunk allowed vlan all	Allow all VLANs on the interface.
(config-if)#commit	Commit the candidate configuration to the running configuration.

Validation

```
VTEP-1#sh nvo vxlan xconnect
EVPN Xconnect Info
=====
AC-AC: Local-Cross-connect
AC-NW: Cross-connect to Network
AC-UP: Access-port is up
AC-DN: Access-port is down
NW-UP: Network is up
NW-DN: Network is down
NW-SET: Network and AC both are up
```

Local		Remote		Connection-Details	
VPN-ID	EVI-Name	MTU	VPN-ID	Source	Destination
PE-IP	MTU	Type	NW-Status		
10	----	1500	20	xe6 2	--- Single Homed Port ---
2.2.2.2	1500	AC-NW	NW-SET		

Total number of entries are 1

```
VTEP-1#sh nvo vxlan tunnel
VxLAN Network tunnel Entries
Source          Destination    Status        Up/Down       Update
=====
1.1.1.1         2.2.2.2       Installed     00:02:01     00:02:01
```

Total number of entries are 1

VTEP-1#

```
VTEP-2#sh nvo vxlan xconnect
EVPN Xconnect Info
=====
AC-AC: Local-Cross-connect
```

AC-NW: Cross-connect to Network
 AC-UP: Access-port is up
 AC-DN: Access-port is down
 NW-UP: Network is up
 NW-DN: Network is down
 NW-SET: Network and AC both are up

Local		Remote		Connection-Details	
VPN-ID	EVI-Name	MTU	VPN-ID	Source	Destination
PE-IP	MTU	Type	NW-Status		
20	----	1500	10	xe6 2	--- Single Homed Port ---
1.1.1.1	1500	AC-NW	NW-SET		

Total number of entries are 1

VTEP-2#sh nvo vxlan tunnel

VxLAN Network tunnel Entries

Source	Destination	Status	Up/Down	Update
2.2.2.2	1.1.1.1	Installed	00:01:16	00:01:16

Total number of entries are 1

VTEP-2#

Multi-Homed VxLAN Eline xConnect

Topology

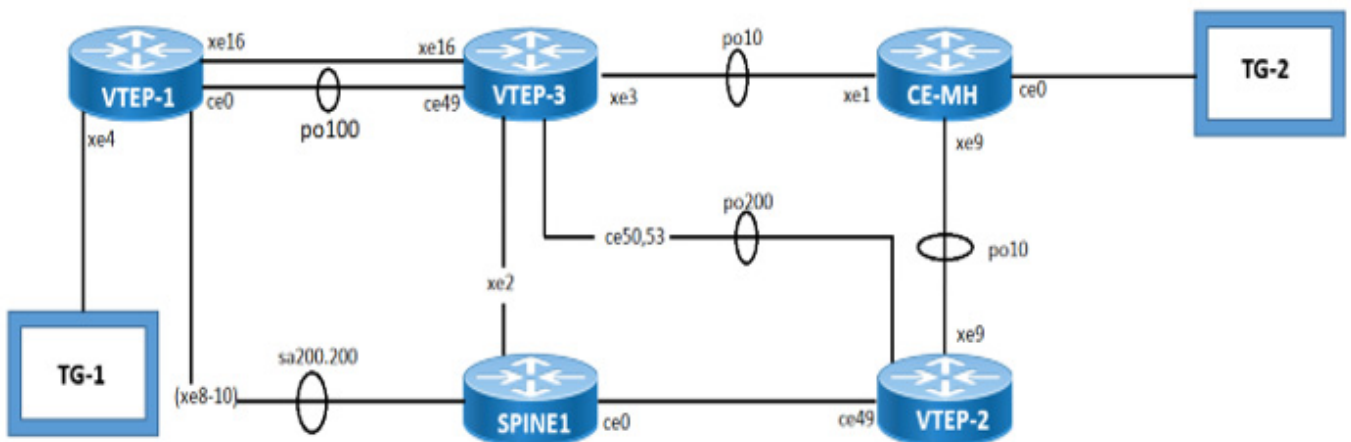

Figure 15-16: Multi-homed VxLAN Eline xConnect topology

L2, IPv4, and IPv6 traffic streams are sent from TG-1 and TG-2.

VTEP-1

#con t	Enter configure mode
(config)#hostname VTEP1	Configure hostname
(config)#hardware-profile filter egress-ipv4 enable	Enable hardware filter for egress ipv4
(config)#hardware-profile filter vxlan enable	Enable hardware-profile filter for VxLAN
(config)#hardware-profile filter vxlan-mh enable	Enable hardware-profile filter for multi-homed VxLAN
(config)#hardware-profile statistics ingress-acl enable	Configure hardware profile statistics ingress-acl
(config)#nvo vxlan enable	Enable VxLAN globally on this vtep
(config)#mac vrf evpn_mh_eline	Configure a new VRF
(config-vrf)#rd 1.1.1.1:2	Assign the Route Distinguisher value.
(config-vrf)#route-target both 2:2	Configure route target to import and export the routes
(config-vrf)#evpn vxlan multihoming enable	Enable evpn vxlan multihoming
(config-vrf)#exit	Exit vrf mode
(config)#interface po100	Enter interface mode
(config-if)#ip address 51.1.1.1/24	Configure IP address on the interface
(config-if)#isis circuit-type level-1	Configure instance as level-1-only routing.
(config-if)#ip router isis VxLAN	Enable IS-IS routing on the interface
(config-if)#exit	Exit interface mode
(config)#interface sa200	Enter interface mode
(config-if)#interface sa200.200	Enter interface mode
(config-if)#encapsulation dot1q 200	Configure the encapsulation as dot1q matching vlan 200
(config-if)#ip address 61.1.1.1/24	Configure IP address on the interface
(config-if)#isis circuit-type level-1	Configure instance as level-1-only routing.
(config-if)#ip router isis VxLAN	Enable IS-IS routing on the interface
(config-if)#interface ce0	Enter interface mode
(config-if)#channel-group 100 mode active	Add this interface to channel group 100 and enable link aggregation so that it can be selected for aggregation by the local system.
(config-if)#interface lo	Enter interface mode
(config-if)#ip address 1.1.1.1/32 secondary	Configure IP address on the interface
(config-if)#ip router isis VxLAN	Enable IS-IS routing on the interface
(config-if)#interface xe4	Enter interface mode
(config-if)#switchport	Configure the interface as switchport
(config-if)#interface xe8	Enter interface mode
(config-if)#static-channel-group 200	Add this interface to channel group 200 and enable link aggregation so that it can be selected for aggregation by the local system.
(config-if)#interface xe9	Enter interface mode

(config-if)#static-channel-group 200	Add this interface to channel group 200 and enable link aggregation so that it can be selected for aggregation by the local system.
(config-if)#interface xe10	Enter interface mode
(config-if)#static-channel-group 200	Add this interface to channel group 200 and enable link aggregation so that it can be selected for aggregation by the local system.
(config-if)#interface xe16.100	Enter interface mode
(config-if)#encapsulation dot1q 100	Configure the encapsulation as dot1q matching vlan 100
(config-if)#ip address 50.1.1.1/24	Configure IP address on the interface
(config-if)#isis circuit-type level-1	Configure instance as level-1-only routing.
(config-if)#ip router isis VxLAN	Enable IS-IS routing on the interface
(config-if)#exit	Exit interface mode
(config)#router isis VxLAN	Create an IS-IS routing instance
(config-router)#is-type level-1	Configure instance as level-1-only routing
(config-router)#spf-interval-exp 0 0	Set the minimum and maximum hold intervals between Shortest Path First (SPF) calculations
(config-router)#metric-style wide	Configure the new style of metric type as wide.
(config-router)#mpls traffic-eng level-1	Enable MPLS-TE in is-type Level-1.
(config-router)#dynamic-hostname	Configure a hostname to use for the Dynamic Hostname Exchange Mechanism and System-ID to hostname translation
(config-router)#bfd all-interfaces	Enable BFD for all-interface on ISIS
(config-router)#net 49.0000.0000.0001.00	Set a Network Entity Title for this instance, specifying the area address and the system ID.
(config-router)#exit	Exit router mode
(config)#router bgp 100	Enter BGP router mode
(config-router)#bgp router-id 1.1.1.1	Assign BGP router ID
(config-router)#neighbor 3.3.3.3 remote-as 100	Specify a neighbor router with peer ip address and remote-as defined
(config-router)#neighbor 4.4.4.4 remote-as 100	Specify a neighbor router with peer ip address and remote-as defined
(config-router)#neighbor 3.3.3.3 update-source lo	Specify the neighbor to use loopback address as source
(config-router)#neighbor 4.4.4.4 update-source lo	Specify the neighbor to use loopback address as source
(config-router)#address-family l2vpn evpn	Enter into l2vpn address family mode
(config-router-af)#neighbor 3.3.3.3 activate	Activate the peer into address family mode
(config-router-af)#neighbor 4.4.4.4 activate	Activate the peer into address family mode
(config-router-af)#exit-address-family	Exit l2vpn address family mode
(config-router)#nvo vxlan vtep-ip-global 1.1.1.1	Configure Source vtep-ip-global configuration
(config)#nvo vxlan id 2 xconnect target-vxlan-id 1002	add a tenant and the type of VPN. This creates an ELAN with source and target identifier for ELINE XConnect
(config-nvo)#vxlan host-reachability-protocol evpn-bgp evpn_mh_eline	Set the host reachable protocol to Ethernet-

(config-nvo)#nvo vxlan access-if port-vlan xe4 2	Map the access port xe4 of this VTEP with vlan 2
(config-nvo-acc-if)#map vnid 2	Map the VNID to access-port
(config-nvo-acc-if)#nvo vxlan access-if port-vlan xe4 2000	Map the access port xe4 of this VTEP with vlan 2000
(config-nvo-acc-if)#map vnid 2000	Map the VNID to access-port
(config-nvo-acc-if)#commit	Commit the candidate configuration to the running configuration.

VTEP-2

#con t	Enter configure mode
(config)#hostname VTEP2	Configure hostname
(config)#hardware-profile filter egress-ipv4 enable	Enable hardware filter for egress ipv4
(config)#hardware-profile filter vxlan enable	Enable hardware-profile filter for VxLAN
(config)#hardware-profile filter vxlan-mh enable	Enable hardware-profile filter for multi-homed VxLAN
(config)#hardware-profile statistics ingress-acl enable	Configure hardware profile statistics ingress-acl
(config)#nvo vxlan enable	Enable VxLAN globally on this vtep
(config)#mac vrf evpn_mh_eline	Configure a new VRF
(config-vrf)#rd 4.4.4.4:2	Assign the Route Distinguisher value.
(config-vrf)#route-target both 2:2	Configure route target to import and export the routes
(config-vrf)#evpn vxlan multihoming enable	Enable evpn vxlan multihoming
(config)#vlan database	Enter VLAN configure mode
(config-vlan)#vlan 200 bridge 1	Configure a VLAN and add it to the bridge.
(config-vlan)#interface po10	Enter interface mode
(config-if)#switchport	Configure the interface as switchport
(config-if)#evpn multi-homed system-mac 0000.0000.1111	Configure system mac as ESI value for the interface
(config-if)#interface po200	Enter interface mode
(config-if)#ip address 63.1.1.2/24	Configure IP address on the interface
(config-if)#isis circuit-type level-1	Configure instance as level-1-only routing.
(config-if)#ip router isis VxLAN	Enable IS-IS routing on the interface
(config-if)#interface ce49	Enter interface mode
(config-if)#switchport	Configure the interface as switchport
(config-if)#bridge-group 1	Associate bridge to an interface.
(config-if)#switchport mode trunk	Configure port as a trunk.
(config-if)#switchport trunk allowed vlan add 200	Allow VLAN 200 on the interface.
(config-if)#interface ce50	Enter interface mode

(config-if)#channel-group 200 mode active	Add this interface to channel group 200 and enable link aggregation so that it can be selected for aggregation by the local system.
(config-if)#interface ce53	Enter interface mode
(config-if)#channel-group 200 mode active	Add this interface to channel group 200 and enable link aggregation so that it can be selected for aggregation by the local system.
(config-if)#interface lo	Enter interface mode
(config-if)#ip address 4.4.4.4/32 secondary	Configure IP address on the interface
(config-if)#ip router isis VxLAN	Enable IS-IS routing on the interface
(config-if)#interface vlan1.200	Enter interface mode
(config-if)#ip address 20.1.1.2/24	Configure IP address on the interface
(config-if)#isis circuit-type level-1	Configure instance as level-1-only routing.
(config-if)#ip router isis VxLAN	Enable IS-IS routing on the interface
(config-if)#interface xe9	Enter interface mode
(config-if)#channel-group 10 mode active	Add this interface to channel group 10 and enable link aggregation so that it can be selected for aggregation by the local system.
(config-if)#exit	Exit interface mode
(config)#router isis VxLAN	Create an IS-IS routing instance
(config-router)#is-type level-1	Configure instance as level-1-only routing
(config-router)#spf-interval-exp 0 0	Set the minimum and maximum hold intervals between Shortest Path First (SPF) calculations
(config-router)#metric-style wide	Configure the new style of metric type as wide.
(config-router)#mpls traffic-eng level-1	Enable MPLS-TE in is-type Level-1.
(config-router)#dynamic-hostname	Configure a hostname to use for the Dynamic Hostname Exchange Mechanism and System-ID to hostname translation
(config-router)#bfd all-interfaces	Enable BFD for all-interface on ISIS
(config-router)#net 49.0000.0000.0004.00	Set a Network Entity Title for this instance, specifying the area address and the system ID.
(config-router)#exit	Exit isis interface mode
(config-router)#router bgp 100	Enter BGP router mode
(config-router)#bgp router-id 4.4.4.4	Assign BGP router ID
(config-router)#neighbor 1.1.1.1 remote-as 100	Specify a neighbor router with peer ip address and remote-as defined
(config-router)#neighbor 3.3.3.3 remote-as 100	Specify a neighbor router with peer ip address and remote-as defined
(config-router)#neighbor 1.1.1.1 update-source lo	Specify the neighbor to use loopback address as source
(config-router)#neighbor 3.3.3.3 update-source lo	Specify the neighbor to use loopback address as source
(config-router)#address-family l2vpn evpn	Enter into l2vpn address family mode
(config-router-af)#neighbor 1.1.1.1 activate	Activate the peer into address family mode
(config-router-af)#neighbor 3.3.3.3 activate	Activate the peer into address family mode
(config-router-af)#exit-address-family	Exit l2vpn address family mode

(config-router)#nvo vxlan vtep-ip-global 4.4.4.4	Configure Source vtep-ip-global configuration
(config)#nvo vxlan id 3000 xconnect target- vxlan-id 2000	add a tenant and the type of VPN. This creates an ELAN with source and target identifier for ELINE XConnect
(config-nvo)#vxlan host-reachability- protocol evpn-bgp evpn_mh_eline	Set the host reachable protocol to Ethernet-
(config-nvo)#nvo vxlan access-if port-vlan po10 2000	Map the access port po10 of this VTEP with vlan 2000
(config-nvo-acc-if)#map vnid 3000	Map the VNID to access-port
(config-nvo-acc-if)#commit	Commit the candidate configuration to the running configuration.

VTEP-3

#con t	Enter configure mode
(config)#hostname VTEP3	Configure host name
(config)#hardware-profile filter egress-ipv4 enable	Enable hardware filter for egress ipv4
(config)#hardware-profile filter vxlan enable	Enable hardware-profile filter for VxLAN
(config)#hardware-profile filter vxlan-mh enable	Enable hardware-profile filter for multi-homed VxLAN
(config)#hardware-profile statistics ingress-acl enable	Configure hardware profile statistics ingress-acl
(config)#nvo vxlan enable	Enable VxLAN globally on this vtep
(config)#mac vrf evpn_mh_eline	Configure a new VRF
(config-vrf)#rd 3.3.3.3:2	Assign the Route Distinguisher value.
(config-vrf)#route-target both 2:2	Configure route target to import and export the routes
(config-vrf)#evpn vxlan multihoming enable	Enable evpn vxlan multihoming
(config)#bridge 1 protocol ieee vlan-bridge	Configure bridge as IEEE VLAN bridge
(config)#vlan database	Enter VLAN configure mode
(config-vlan)#vlan 300 bridge 1	Configure a VLAN and add it to the bridge.
(config-vlan)#interface po10	Enter interface mode
(config-if)#switchport	Configure the interface as switchport
(config-if)#evpn multi-homed system-mac 0000.0000.1111	Configure system mac as ESI value for the interface
(config-if)#interface po100	Enter interface mode
(config-if)#ip address 51.1.1.2/24	Configure IP address on the interface
(config-if)#isis circuit-type level-1	Configure instance as level-1-only routing.
(config-if)#ip router isis VxLAN	Enable IS-IS routing on the interface
(config-if)#interface po200	Enter interface mode
(config-if)#ip address 63.1.1.1/24	Configure IP address on the interface
(config-if)#isis circuit-type level-1	Configure instance as level-1-only routing.
(config-if)#ip router isis VxLAN	Enable IS-IS routing on the interface
(config-if)#interface ce49	Enter interface mode

(config-if)#channel-group 100 mode active	Add this interface to channel group 100 and enable link aggregation so that it can be selected for aggregation by the local system.
(config-if)#interface ce50	Enter interface mode
(config-if)#channel-group 200 mode active	Add this interface to channel group 200 and enable link aggregation so that it can be selected for aggregation by the local system.
(config-if)#interface ce53	Enter interface mode
(config-if)#channel-group 200 mode active	Add this interface to channel group 200 and enable link aggregation so that it can be selected for aggregation by the local system.
(config-if)#interface lo	Enter interface mode
(config-if)#ip address 3.3.3.3/32 secondary	Configure IP address on the interface
(config-if)#ip router isis VxLAN	Enable IS-IS routing on the interface
(config-if)#interface vlan1.300	Enter interface mode
(config-if)#ip address 40.1.1.2/24	Configure IP address on the interface
(config-if)#isis circuit-type level-1	Configure instance as level-1-only routing.
(config-if)#ip router isis VxLAN	Enable IS-IS routing on the interface
(config-if)#interface xe2	Enter interface mode
(config-if)#ip address 62.1.1.1/24	Configure IP address on the interface
(config-if)#isis circuit-type level-1	Configure instance as level-1-only routing.
(config-if)#ip router isis VxLAN	Enable IS-IS routing on the interface
(config-if)#interface xe3	Enter interface mode
(config-if)#channel-group 10 mode active	Add this interface to channel group 10 and enable link aggregation so that it can be selected for aggregation by the local system.
(config-if)#interface xe16.100	Enter interface mode
(config-if)#encapsulation dot1q 100	Configure the encapsulation as dot1q matching vlan 100
(config-if)#ip address 50.1.1.2/24	Configure IP address on the interface
(config-if)#isis circuit-type level-1	Configure instance as level-1-only routing.
(config-if)#ip router isis VxLAN	Enable IS-IS routing on the interface
(config-if)#exit	Exit interface mode
(config)#router isis VxLAN	Create an IS-IS routing instance
(config-router)#is-type level-1	Configure instance as level-1-only routing
(config-router)#spf-interval-exp 0 0	Set the minimum and maximum hold intervals between Shortest Path First (SPF) calculations
(config-router)#metric-style wide	Configure the new style of metric type as wide.
(config-router)#mpls traffic-eng level-1	Enable MPLS-TE in is-type Level-1.
(config-router)#dynamic-hostname	Configure a host name to use for the Dynamic Hostname Exchange Mechanism and System-ID to host name translation
(config-router)#bfd all-interfaces	Enable BFD for all-interface on ISIS
(config-router)#net 49.0000.0000.0006.00	Set a Network Entity Title for this instance, specifying the area address and the system ID.
(config-router)#exit	Exit isis router mode

(config)#router bgp 100	Enter BGP router mode
(config-router)#bgp router-id 3.3.3.3	Assign BGP router ID
(config-router)#neighbor 1.1.1.1 remote-as 100	Specify a neighbor router with peer ip address and remote-as defined
(config-router)#neighbor 4.4.4.4 remote-as 100	Specify a neighbor router with peer ip address and remote-as defined
(config-router)#neighbor 1.1.1.1 update-source lo	Specify the neighbor to use loopback address as source
(config-router)#neighbor 4.4.4.4 update-source lo	Specify the neighbor to use loopback address as source
(config-router)#address-family l2vpn evpn	Enter into l2vpn address family mode
(config-router-af)#neighbor 1.1.1.1 activate	Activate the peer into address family mode
(config-router-af)#neighbor 4.4.4.4 activate	Activate the peer into address family mode
(config-router-af)#exit-address-family	Exit l2vpn address family mode
(config-router)#nvo vxlan vtep-ip-global 3.3.3.3	Configure Source vtep-ip-global configuration
(config)#nvo vxlan id 3000 xconnect target-vxlan-id 2000	add a tenant and the type of VPN. This creates an ELAN with source and target identifier for ELINE XConnect
(config-nvo)#vxlan host-reachability-protocol evpn-bgp evpn_mh_eline	Set the host reachable protocol to Ethernet-
(config-nvo)#nvo vxlan access-if port-vlan po10 2000	Map the access port po10 of this VTEP with vlan 2000
(config-nvo-acc-if)#map vnid 3000	Map the VNID to access-port
(config-nvo-acc-if)#commit	Commit the candidate configuration to the running configuration.

SPINE

#con t	Enter configure mode
(config)#hostname SPINE	Configure host name
(config)#hardware-profile statistics ingress-acl enable	Configure hardware profile statistics ingress-acl
(config)#bridge 1 protocol ieee vlan-bridge	Configure bridge as IEEE VLAN bridge
(config)#vlan database	Enter VLAN configure mode
(config-vlan)#vlan 200 bridge 1	Configure a VLAN and add it to the bridge.
(config-if)#interface sa200	Enter interface mode
(config-if)#interface sa200.200	Enter interface mode
(config-if)#encapsulation dot1q 200	Configure the encapsulation as dot1q matching vlan 200
(config-if)#ip address 61.1.1.2/24	Configure IP address on the interface
(config-if)#isis circuit-type level-1	Configure instance as level-1-only routing.
(config-if)#ip router isis VxLAN	Enable IS-IS routing on the interface
(config-if)#interface ce0	Enter interface mode
(config-if)#switchport	Configure the interface as switchport
(config-if)#bridge-group 1	Associate bridge to an interface.
(config-if)#switchport mode trunk	Configure port as a trunk.

(config-if)#switchport trunk allowed vlan add 200	Allow VLAN 200 on the interface.
(config-if)#interface lo	Enter interface mode
(config-if)#ip address 11.11.11.11/32 secondary	Configure IP address on the interface
(config-if)#ip router isis VxLAN	Enable IS-IS routing on the interface
(config-if)#interface vlan1.200	Enter interface mode
(config-if)#ip address 20.1.1.1/24	Configure IP address on the interface
(config-if)#isis circuit-type level-1	Configure instance as level-1-only routing.
(config-if)#ip router isis VxLAN	Enable IS-IS routing on the interface
(config-if)#interface xe2	Enter interface mode
(config-if)#ip address 62.1.1.2/24	Configure IP address on the interface
(config-if)#isis circuit-type level-1	Configure instance as level-1-only routing.
(config-if)#ip router isis VxLAN	Enable IS-IS routing on the interface
(config-if)#interface xe8	Enter interface mode
(config-if)#static-channel-group 200	Add this interface to channel group 200 and enable link aggregation so that it can be selected for aggregation by the local system.
(config-if)#interface xe9	Enter interface mode
(config-if)#static-channel-group 200	Add this interface to channel group 200 and enable link aggregation so that it can be selected for aggregation by the local system.
(config-if)#interface xe10	Enter interface mode
(config-if)#static-channel-group 200	Add this interface to channel group 200 and enable link aggregation so that it can be selected for aggregation by the local system.
(config-if)#exit	Exit interface mode
(config-if)#router isis VxLAN	Create an IS-IS routing instance
(config-router)#is-type level-1	Configure instance as level-1-only routing
(config-router)#spf-interval-exp 0 0	Set the minimum and maximum hold intervals between Shortest Path First (SPF) calculations
(config-router)#metric-style wide	Configure the new style of metric type as wide.
(config-router)#mpls traffic-eng level-1	Enable MPLS-TE in is-type Level-1.
(config-router)#dynamic-hostname	Configure a host name to use for the Dynamic Hostname Exchange Mechanism and System-ID to host name translation
(config-router)#bfd all-interfaces	Enable BFD for all-interface on ISIS
(config-router)#net 49.0000.0000.0003.00	Set a Network Entity Title for this instance, specifying the area address and the system ID.
(config-router)#exit	Exit isis interface mode
(config)#router bgp 100	Enter BGP router mode
(config-router)#neighbor 1.1.1.1 remote-as 100	Assign BGP router ID
(config-router)#neighbor 5.5.5.5 remote-as 100	Specify a neighbor router with peer ip address and remote-as defined
(config-router)#address-family l2vpn evpn	Enter into l2vpn address family mode

(config-router-af)#neighbor 1.1.1.1 activate	Activate the peer into address family mode
(config-router-af)#neighbor 1.1.1.1 route-reflector-client	Configure this node as the route reflector with the mentioned peer as its client
(config-router-af)#neighbor 5.5.5.5 activate	Activate the peer into address family mode
(config-router-af)#neighbor 5.5.5.5 route-reflector-client	Configure this node as the route reflector with the mentioned peer as its client
(config-router-af)#exit-address-family	Exit I2vpn address family mode
(config-router)#commit	Commit the candidate configuration to the running configuration.

CE-MH

#con t	Enter configure mode
(config)#hostname CE3-MH	Configure host name
(config)#hardware-profile statistics ingress-acl enable	Configure hardware profile statistics ingress-acl
(config)#interface po10	Enter interface mode
(config-if)#switchport	Configure the interface as switchport
(config-if)#interface po10.100 switchport	Enter interface mode
(config-if)#encapsulation default	Configure the encapsulation as default
(config-if)#interface ce0	Enter interface mode
(config-if)#interface ce0.100 switchport	Enter interface mode
(config-if)#encapsulation default	Configure the encapsulation as default
(config-if)#interface xe1	Enter interface mode
(config-if)#channel-group 10 mode active	Add this interface to channel group 10 and enable link aggregation so that it can be selected for aggregation by the local system.
(config-if)#interface xe9	Enter interface mode
(config-if)#channel-group 10 mode active	Add this interface to channel group 10 and enable link aggregation so that it can be selected for aggregation by the local system.
(config-if)#cross-connect MH-CE3	Create cross-connect with name MH-CE3
(config-xc)#interface po10.100	Attach interface po10.100
(config-xc)#interface ce0.100	Attach interface ce0.100
(config-xc)#commit	Commit the candidate configuration to the running configuration.

Validation

```
VTEP1#show nvo vxlan xconnect
EVPN Xconnect Info
=====
AC-AC: Local-Cross-connect
AC-NW: Cross-connect to Network
AC-UP: Access-port is up
AC-DN: Access-port is down
```

NW-UP: Network is up
 NW-DN: Network is down
 NW-SET: Network and AC both are up

Local			Remote		Connection-Details	
VPN-ID	EVI-Name	MTU	VPN-ID	Source	Destination	
PE-IP	MTU	Type	NW-Status			
2000	----	1500	3000	xe4 2000	00:00:00:00:00:11:11:00:00:00	
4.4.4.4	1500	AC-NW	NW-SET			
3.3.3.3	1500	----	----			

Total number of entries are 1
 VTEP1-7012#
 VTEP1-7012#show nvo vxlan tunnel

VxLAN Network tunnel Entries

Source	Destination	Status	Up/Down	Update
1.1.1.1	4.4.4.4	Installed	00:03:30	00:03:30
1.1.1.1	3.3.3.3	Installed	00:03:27	00:03:27

Total number of entries are 2
 VTEP1#

VTEP3#show nvo vxlan xconnect
 EVPN Xconnect Info
 =====
 AC-AC: Local-Cross-connect
 AC-NW: Cross-connect to Network
 AC-UP: Access-port is up
 AC-DN: Access-port is down
 NW-UP: Network is up
 NW-DN: Network is down
 NW-SET: Network and AC both are up

Local			Remote		Connection-Details	
VPN-ID	EVI-Name	MTU	VPN-ID	Source	Destination	
PE-IP	MTU	Type	NW-Status			
3000	----	1500	2000	po10 2000	--- Single Homed Port ---	
1.1.1.1	1500	AC-NW	NW-SET			

Total number of entries are 1
 VTEP3#

```
VTEP2#show nvo vxlan xconnect
```

```
EVPN Xconnect Info
```

```
=====
```

```
AC-AC: Local-Cross-connect
```

```
AC-NW: Cross-connect to Network
```

```
AC-UP: Access-port is up
```

```
AC-DN: Access-port is down
```

```
NW-UP: Network is up
```

```
NW-DN: Network is down
```

```
NW-SET: Network and AC both are up
```

```
Local                               Remote                               Connection-Details
=====
=====
```

VPN-ID	EVI-Name	MTU	VPN-ID	Source	Destination
PE-IP	MTU	Type	NW-Status		
3000	----	1500	2000	po10 2000	--- Single Homed Port ---
1.1.1.1	1500	AC-NW	NW-SET		

```
=====
```

```
Total number of entries are 1
```

```
VTEP2#
```

CHAPTER 16 VxLAN-EVPN Symmetric IRB Support with Connected host

Overview

EVPN-IRB enables communication between two L2VNI's by employing Routing through IP-VRF. This functionality offers Host (/32) based Symmetric IRB support, directing inter-subnet traffic directly to the Host attached VTEP. To implement this, configure "evpn irb-advertise-host-route" within VNID (BGP type 2) settings, or "redistribute connected-host-routes" under BGP (BGP type 5) configurations.

Note:

- In VxLAN-EVPN Interface-less mode, only the 'redistribute connected-host-routes' command is supported. However, in Interface-full mode, both commands are supported.
- It is advisable to configure a route map in ESI configured Multi-Homed (MH) nodes to block Hosts from peer MH. This configuration is not required in non-ESI MH VTEPs.

Feature Characteristics

The preferred and recommended approach for AOS-CX VxLAN/EVPN Distributed L3 Gateways is Symmetric IRB. This implementation offers superior scalability by eliminating the need to manage MAC/ARP entries for both source and destination hosts, and it doesn't require configuring the same VLAN/VNI as in the case of Asymmetric IRB. These advantages facilitate simpler and more scalable deployments in both Data Center and Campus networks.

Benefits

The advantages of utilizing a VxLAN-EVPN Symmetric IRB Support:

- Routing is employed on both ingress and egress VTEPs.
- Bi-directional traffic follows a symmetric path, such as utilizing an L3 VNI per VRF.
- VTEPs are relieved from holding unnecessary ARP/MAC resources.
- Configuration of the destination VLAN/VNI on the source VTEP is unnecessary.

Configuration

Ensure that the VTEPs have a base configuration with Symmetric IRB settings. Then, initiate dynamic traffic from VTEP4 originating from the same subnet (53.1.X.XX/XXXX::XX) as the IRB interface. Typically, in EVPN, a single IP-VRF can accommodate multiple IRB interfaces. Each IRB interface corresponds to a VNI, and multiple VNIs can be associated with a MAC-VRF.

Topology

The procedures in this section use the topology in [Figure 16-1](#)

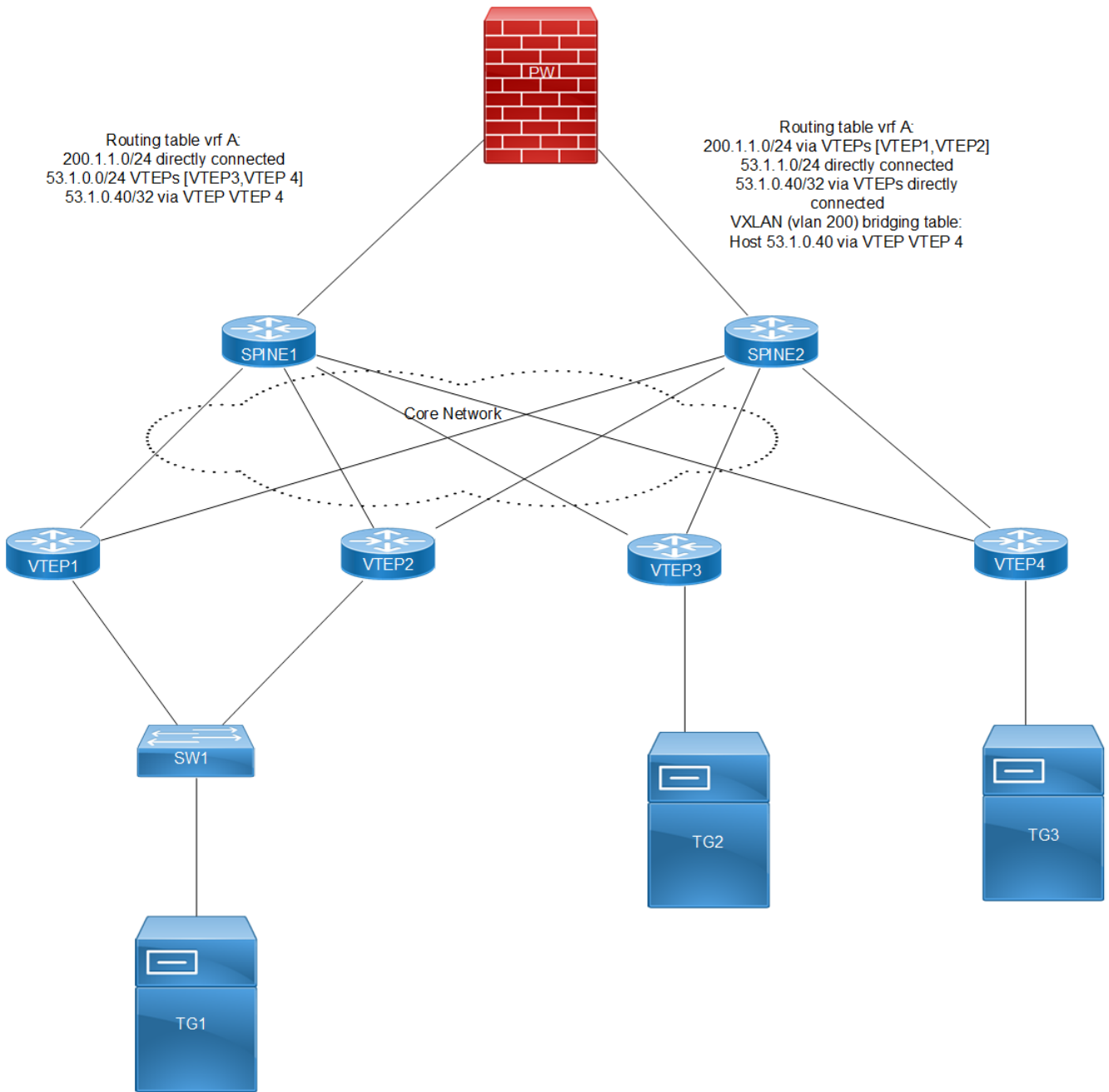

Figure 16-1: VxLAN EVPN IRB Connected host

Note: In the above topology TG1 is Multi homed Host and TG2 and TG3 are Single homed host with same subnet configured so there will be ECMP for 53 network in VTEP1 and VTEP2.

Base Configurations

Begin with a basic configuration that includes Symmetric IRB configurations on VTEPs, then initiate dynamic traffic transmission from VTEP4 within the same subnet (53.1.1.40/5301::40) as the IRB interface.

Validation

Verification before configuring evpn irb-advertise-host-route under VNID configurations or redistribute connected-host-routes under bgp.

In VTEP1:

```
VTEP1#show ip route vrf vxlan_l3_elan_mhsh
Codes: K - kernel, C - connected, S - static, R - RIP, B - BGP
       O - OSPF, IA - OSPF inter area
       N1 - OSPF NSSA external type 1, N2 - OSPF NSSA external type 2
       E1 - OSPF external type 1, E2 - OSPF external type 2
       i - IS-IS, L1 - IS-IS level-1, L2 - IS-IS level-2,
       ia - IS-IS inter area, E - EVPN,
       v - vrf leaked
       * - candidate default

IP Route Table for VRF "vxlan_l3_elan_mhsh"
B          2.2.2.2/32 [0/0] is directly connected, tunvxlan3, 00:21:33
B          5.5.5.5/32 [0/0] is directly connected, tunvxlan3, 00:21:33
B          6.6.6.6/32 [0/0] is directly connected, tunvxlan3, 00:21:33
B          53.1.1.0/24 [200/0] via 6.6.6.6 (recursive is directly connected,
tunvxlan3), 00:21:34
                                     [200/0] via 5.5.5.5 (recursive is directly connected,
tunvxlan3)
C          127.0.0.0/8 is directly connected, lo.vxlan_l3_elan_mhsh, 07:17:43
C          200.1.1.0/24 is directly connected, irb1604, 07:17:41

Gateway of last resort is not set
VTEP1#
VTEP1#show ipv6 route vrf vxlan_l3_elan_mhsh
IPv6 Routing Table
IP Route Table for VRF "vxlan_l3_elan_mhsh"
C          ::1/128 via ::, lo.vxlan_l3_elan_mhsh, 07:18:01
B          ::ffff:202:202/128 [0/0] via ::, tunvxlan3, 00:21:51
B          ::ffff:505:505/128 [0/0] via ::, tunvxlan3, 00:21:51
B          ::ffff:606:606/128 [0/0] via ::, tunvxlan3, 00:21:51
C          2000::/48 via ::, irb1604, 07:17:59
B          5301::/48 [200/0] via ::ffff:606:606 (recursive via ::, tunvxlan3), 00:21:52
                                     [200/0] via ::ffff:505:505 (recursive via ::, tunvxlan3)
C          fe80::/64 via ::, irb1604, 07:17:59
VTEP1#
```

In VTEP2:

```
VTEP2#show ip route vrf vxlan_l3_elan_mhsh
IP Route Table for VRF "vxlan_l3_elan_mhsh"
B          1.1.1.1/32 [0/0] is directly connected, tunvxlan3, 00:22:50
B          5.5.5.5/32 [0/0] is directly connected, tunvxlan3, 00:22:50
B          6.6.6.6/32 [0/0] is directly connected, tunvxlan3, 00:22:50
```

```

B          53.1.1.0/24 [200/0] via 6.6.6.6 (recursive is directly connected,
tunvxlan3), 00:22:51
          [200/0] via 5.5.5.5 (recursive is directly connected,
tunvxlan3)
C          127.0.0.0/8 is directly connected, lo.vxlan_l3_elan_mhsh, 07:19:21
C          200.1.1.0/24 is directly connected, irb1604, 07:19:19

```

Gateway of last resort is not set

VTEP2#

VTEP2#

VTEP2#show ipv6 route vrf vxlan_l3_elan_mhsh

IPv6 Routing Table

IP Route Table for VRF "vxlan_l3_elan_mhsh"

```

C          ::1/128 via ::, lo.vxlan_l3_elan_mhsh, 07:19:22
B          ::ffff:101:101/128 [0/0] via ::, tunvxlan3, 00:22:51
B          ::ffff:505:505/128 [0/0] via ::, tunvxlan3, 00:22:51
B          ::ffff:606:606/128 [0/0] via ::, tunvxlan3, 00:22:51
C          2000::/48 via ::, irb1604, 07:19:20
B          5301::/48 [200/0] via ::ffff:606:606 (recursive via ::, tunvxlan3), 00:22:51
          [200/0] via ::ffff:505:505 (recursive via ::, tunvxlan3)
C          fe80::/64 via ::, irb1604, 07:19:20

```

VTEP2#

VTEP2#show bgp l2vpn evpn mac-ip | grep 0000:0053:0040

```

0          605          0000:0053:0040 --
605          0          6.6.6.6          --          VxLAN
0          605          0000:0053:0040 53.1.1.40
605          0          6.6.6.6          --          VxLAN
0          605          0000:0053:0040 5301::40
605          0          6.6.6.6          --          VxLAN

```

VTEP2#

In VTEP4:

VTEP4#show bgp l2vpn evpn mac-ip | grep 0000:0053:0040

```

0          605          0000:0053:0040 --
605          0          6.6.6.6          --          VxLAN
0          605          0000:0053:0040 53.1.1.40
605          0          6.6.6.6          --          VxLAN
0          605          0000:0053:0040 5301::40
605          0          6.6.6.6          --          VxLAN

```

VTEP4#

Evpn irb-advertise-host-route configuration

1. To enable the EVPN irb-advertise-host-route, execute the following command in the config mode.

```

(config)#nvo vxlan id 605 ingress-replication inner-vid-disabled
(config-nvo)#vxlan host-reachability-protocol evpn-bgp vxlan_l2_elan_sh2
(config-nvo)#evpn irb605
(config-nvo)#evpn irb-advertise-host-route

```
2. To redistributed connected-host-routes, execute the following command.

```

(config)#nvo vxlan id 605 ingress-replication inner-vid-disabled

```

```
(config)#router bgp 1
(config-router)#address-family ipv4 vrf vxlan_l3_elan_sh
VTEP4(config-router-af)#redistribute connected-host-routes
```

Note: With static mac ip configured on vxlan access interface and when redistribute connected-host-routes is configured under bgp. Then routes will not be advertised as /32 or /128 because for static mac-ip Arp entry will not be present so only for dynamic routes.

Note: With redistribute connected-host-routes, show bgp l2vpn evpn mac-ip will not show the l3vnid.

Validation

Use this command to validate the VxLAN-EVPN Symmetric IRB.

In VTEP1:

```
VTEP1#show ip route vrf vxlan_l3_elan_mhsh
IP Route Table for VRF "vxlan_l3_elan_mhsh"
B          2.2.2.2/32 [0/0] is directly connected, tunvxlan3, 00:37:03
B          5.5.5.5/32 [0/0] is directly connected, tunvxlan3, 00:37:03
B          6.6.6.6/32 [0/0] is directly connected, tunvxlan3, 00:37:03
B          53.1.1.0/24 [200/0] via 6.6.6.6 (recursive is directly connected,
tunvxlan3), 00:37:04
                                     [200/0] via 5.5.5.5 (recursive is directly connected,
tunvxlan3)
B          53.1.1.40/32 [200/0] via 6.6.6.6 (recursive is directly connected,
tunvxlan3), 00:05:49
C          127.0.0.0/8 is directly connected, lo.vxlan_l3_elan_mhsh, 07:33:13
C          200.1.1.0/24 is directly connected, irb1604, 07:33:11
Gateway of last resort is not set
VTEP1#
VTEP1#show ipv6 route vrf vxlan_l3_elan_mhsh
IPv6 Routing Table
IP Route Table for VRF "vxlan_l3_elan_mhsh"
C          ::1/128 via ::, lo.vxlan_l3_elan_mhsh, 07:33:21
B          ::ffff:202:202/128 [0/0] via ::, tunvxlan3, 00:37:11
B          ::ffff:505:505/128 [0/0] via ::, tunvxlan3, 00:37:11
B          ::ffff:606:606/128 [0/0] via ::, tunvxlan3, 00:37:11
C          2000::/48 via ::, irb1604, 07:33:19
B          5301::/48 [200/0] via ::ffff:606:606 (recursive via ::, tunvxlan3), 00:37:12
                                     [200/0] via ::ffff:505:505 (recursive via ::, tunvxlan3)
B          5301::40/128 [200/0] via ::ffff:606:606 (recursive via ::, tunvxlan3), 00:05:57
C          fe80::/64 via ::, irb1604, 07:33:19
VTEP1#
VTEP1#show bgp l2vpn evpn mac-ip | grep 0000:0053:0040
0          605          0000:0053:0040 --
605          0          6.6.6.6          --          VxLAN
0          605          0000:0053:0040 53.1.1.40
605          1604          6.6.6.6          --          VxLAN
0          605          0000:0053:0040 5301::40
605          1604          6.6.6.6          --          VxLAN
VTEP1#
```

In VTEP2:

```

VTEP2#show ip route vrf vxlan_l3_elan_mhsh
IP Route Table for VRF "vxlan_l3_elan_mhsh"
B          1.1.1.1/32 [0/0] is directly connected, tunvxlan3, 00:31:16
B          5.5.5.5/32 [0/0] is directly connected, tunvxlan3, 00:31:16
B          6.6.6.6/32 [0/0] is directly connected, tunvxlan3, 00:31:16
B          53.1.1.0/24 [200/0] via 6.6.6.6 (recursive is directly connected,
tunvxlan3), 00:31:17
                                     [200/0] via 5.5.5.5 (recursive is directly connected,
tunvxlan3)
B          53.1.1.40/32 [200/0] via 6.6.6.6 (recursive is directly connected,
tunvxlan3), 00:00:03
C          127.0.0.0/8 is directly connected, lo.vxlan_l3_elan_mhsh, 07:27:47
C          200.1.1.0/24 is directly connected, irb1604, 07:27:45
Gateway of last resort is not set
VTEP2#
VTEP2#show ipv6 route vrf vxlan_l3_elan_mhsh
IPv6 Routing Table
IP Route Table for VRF "vxlan_l3_elan_mhsh"
C          ::1/128 via ::, lo.vxlan_l3_elan_mhsh, 07:27:54
B          ::ffff:101:101/128 [0/0] via ::, tunvxlan3, 00:31:23
B          ::ffff:505:505/128 [0/0] via ::, tunvxlan3, 00:31:23
B          ::ffff:606:606/128 [0/0] via ::, tunvxlan3, 00:31:23
C          2000::/48 via ::, irb1604, 07:27:52
B          5301::/48 [200/0] via ::ffff:606:606 (recursive via ::, tunvxlan3), 00:31:23
                                     [200/0] via ::ffff:505:505 (recursive via ::, tunvxlan3)
B          5301::40/128 [200/0] via ::ffff:606:606 (recursive via ::, tunvxlan3), 00:00:10
C          fe80::/64 via ::, irb1604, 07:27:52
VTEP2#
VTEP2#show bgp l2vpn evpn mac-ip | grep 0000:0053:0040
0          605          605          0000:0053:0040 --
605          0          6.6.6.6          --          VxLAN
0          605          605          0000:0053:0040 53.1.1.40
605          1604          6.6.6.6          --          VxLAN
0          605          605          0000:0053:0040 5301::40
605          1604          6.6.6.6          --          VxLAN
VTEP2#

```

In VTEP4:

```

VTEP4#show arp vrf vxlan_l3_elan_mhsh
Flags: D - Static Adjacencies attached to down interface
IP ARP Table for context vxlan_l3_elan_mhsh
Total number of entries: 1
Address          Age          MAC Address          Interface          State
1.1.1.1          -          e8c5.7aa3.2cb0      tunvxlan3          PERMANENT
2.2.2.2          -          e001.a657.ef01      tunvxlan3          PERMANENT
5.5.5.5          -          6cb9.c5b1.ab9c      tunvxlan3          PERMANENT
53.1.1.40        00:02:57 0000.0053.0040      irb604             STALE
VTEP4#

```

```
VTEP4#show bgp l2vpn evpn mac-ip | grep 0000:0053:0040
0          605          0000:0053:0040 --
605        0          6.6.6.6        --          VxLAN
0          605          0000:0053:0040 53.1.1.40
605        1604         6.6.6.6        --          VxLAN
0          605          0000:0053:0040 5301::40
605        1604         6.6.6.6        --          VxLAN
VTEP4#
```

Glossary

The following provides definitions for key terms or abbreviations and their meanings used throughout this document:

Key Terms/Acronym	Description
ECMP	ECMP stands for Equal-Cost Multi-Path. It's a routing technique used in computer networks, particularly in IP-based routing protocols like OSPF (Open Shortest Path First) and BGP (Border Gateway Protocol).
VTEPs	VTEP stands for VXLAN Tunnel Endpoint. It's a crucial component in network virtualization architectures, particularly in overlay networks using VXLAN (Virtual Extensible LAN) technology.
ARP/MAC	ARP (Address Resolution Protocol) and MAC (Media Access Control) address are both essential components of networking, particularly in Ethernet-based networks.
VLAN/VNI	VLAN (Virtual Local Area Network) and VNI (Virtual Network Identifier) are both technologies used in networking to segment and manage traffic within a larger network infrastructure.

CHAPTER 17 Single-Home for VxLAN IRB with OSPF or ISIS

Overview

Single Home Virtual Extensible LAN (VxLAN) with Integrated Routing (IRB) using Open Shortest Path First (OSPF) and Intermediate System to Intermediate System (ISIS) protocols provides the solution for connecting and managing virtual networks within a data center or network infrastructure.

This feature offers a solution for networks where the interconnection of VLANs is required. These protocols can be configured on IRB interfaces within layer 3 switches or routers. This configuration enables dynamic routing, facilitating the exchange of routing information with other devices in the network. By assigning IP addresses to the IRB interfaces, they serve as the default gateways for devices within the respective VLANs.

Both OSPF and ISIS routing updates are dynamically exchanged over IRB interfaces, ensuring up-to-date routing tables and optimized traffic routing across different VLANs and networks.

This feature offers flexibility in configuring network topologies, and ensures compatibility and interoperability within diverse network environments.

Feature Characteristics

The OSPF and ISIS support over the IRB Interface feature has the following characteristics:

- Enables the control of Receive (RX)/ Transmit (TX) of OSPF and ISIS packets on IRB interfaces, providing effective management of IRB interfaces interactions with OSPF and ISIS for optimized network communication and routing.
- IRB interfaces process configured MTU size packets.
- Maintains consistency in CLI commands with SVI interfaces for OSPF and ISIS configurations, simplifying network management tasks.

Benefits

The OSPF and ISIS support over the IRB Interface has the following benefits:

- Enables seamless inter-subnet communication across different VNIDs and subnets within the same customer network.
- Promotes seamless connectivity between devices, irrespective of whether they are connected through IRB or SVI interfaces, and simplifies network management.
- The network gains greater adaptability to various scenarios and evolving requirements, offering greater versatility in its operations.

Prerequisites

- Router must be up and running.
- Maintain synchronization with VRF changes by performing IRB shut/no shut actions when specific events occur within the IPVRF. These events may involve adding or removing Route Targets (RTs), updating Route Distinguishers (RDs), or modifying Layer 3 Virtual Network Identifiers (L3VNIs).

Topology for OSPF

The network topology includes various network elements such as routers, customer edge (CE) devices, Service Aggregator (SA) devices, and Provider Edge (PE) routers. The feature enables OSPF on the IRB interfaces, allowing for efficient routing and communication between network devices within the topology.

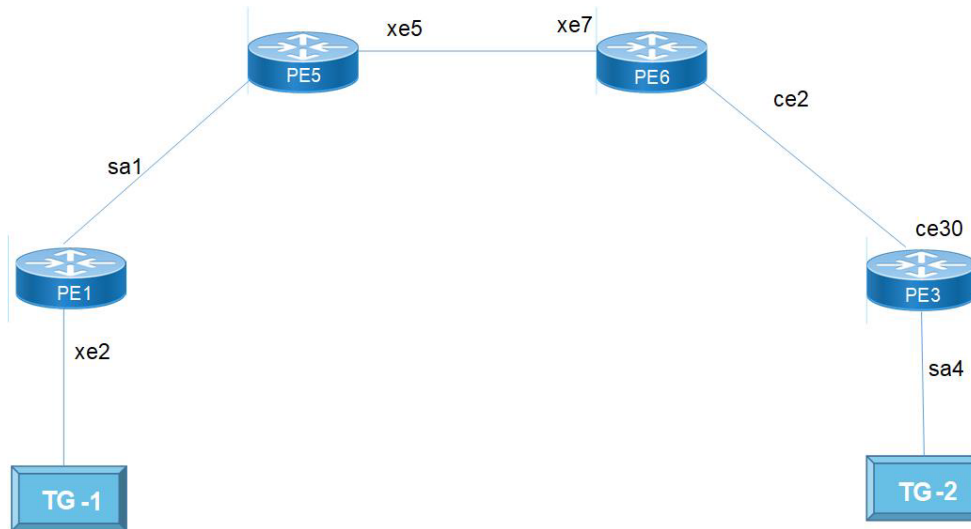

Single Home VxLAN IRB with OSPF

Configuration

Perform the following configurations to set up different interfaces, routing protocols, and BGP parameters to enable VxLAN, IRB, and EVPN functionality in the network.

OSPF

PE1

PE1(Config)# terminal	Enters the configuration mode.
PE1(config)#interface sa1	Configure the sa1 interface as a network interface.
PE1(config-if)# ip address 10.1.1.1/24	Assigns an IP address to the sa1 interface with a subnet mask of /24.
PE1(config-if)# ip ospf cost 10	Configures the OSPF cost for the sa1 interface, setting it to 10.
PE1(config-if)# load-interval 30	Configures the load-interval for monitoring traffic on the sa1 interface.
PE1(config)#interface xe1	Enters the interface xe1 mode.
PE1(config-if)# static-channel-group 1	Assigns the static channel group 1 to the xe2 interface.
PE1(config-irb-if)#interface lo	Configures the loopback (lo) interface.
PE1(config-if)# ip address 1.1.1.1/32 secondary	Assigns the primary IP address 1.1.1.1/32 to the loopback interface and specifies it as secondary.

PE1(config)#router ospf 1	Enters the OSPF configuration mode for OSPF process 1.
PE1(config-router)# ospf router-id 1.1.1.1	Sets the OSPF router ID to 1.1.1.1 for OSPF process 1.
PE1(config-router)# network 1.1.1.1/32 area 0.0.0.0	Advertises the network 1.1.1.1/32 into OSPF area 0.0.0.0.
PE1(config-router)# network 10.1.1.0/24 area 0.0.0.0	Advertises the network 10.1.1.0/24 into OSPF area 0.0.0.0.
PE1(config)#hardware-profile filter vxlan enable	Enables the hardware profile filter for VXLAN.
PE1(config)#nvo vxlan enable	Enables the VXLAN feature on the device.
PE1(config)#nvo vxlan irb	Enables VXLAN IRB functionality.
PE1(config-vrf)#mac vrf L2VRF1	Configures a MAC VRF named L2VRF1.
PE1(config-vrf)# rd 1.1.1.1:11	Sets the Route Distinguisher (RD) to 1.1.1.1:11 for the VRF.
PE1(config-vrf)# route-target both 9.9.9.9:100	Configures both import and export route targets for the VRF.
PE1(config-vrf)#ip vrf L3VRF1	Configures an IP VRF named L3VRF1.
PE1(config-vrf)# rd 51000:11	Sets the RD value to 51000:11 for the L3VRF1.
PE1(config-vrf)# route-target both 100:100	Configures both import and export route targets for L3VRF1.
PE1(config-vrf)# l3vni 1000	Configures the L3 Virtual Network Identifier (L3VNI) with the value 1000.
PE1(config)#interface irb1001	Configures the IRB interface for L3VRF1.
PE1(config-irb-if)# ip vrf forwarding L3VRF1	Assigns the L3VRF1 to the IRB interface.
PE1(config-irb-if)# ip address 11.11.11.1/24	Assigns an IP address 11.11.11.1/24 to the IRB interface.
PE1(config-irb)#interface irb2001	Configures the IRB interface for IPv6 in L3VRF1.
PE1(config-irb-if)# ip vrf forwarding L3VRF1	Assigns the L3VRF1 to the IPv6 IRB interface.
PE1(config-irb-if)# ipv6 address 2001::1/64	Assigns an IP address 11.11.11.1/24 to the IRB interface.
PE1(config-irb-if)#mtu 9000	Sets the Maximum Transmission Unit (MTU) for this IRB interface to 9000 bytes.
PE1(config-router)#router ospf 2 L3VRF1	Configures OSPF on the L3VRF1.
PE1(config-router)# network 11.11.11.0/24 area 0.0.0.0	Advertises the network 11.11.11.0/24 into OSPF area 0.0.0.0.
PE1(config-router)#router ipv6 vrf ospf L3VRF1	Configures OSPFv3 on the L3VRF1.
PE1(config-router)# router-id 1.1.1.1	Configures the router ID as 1.1.1.1.
PE1(config-irb)#interface irb2001	Configures the IPv6 IRB interface.
PE1(config-irb-if)# ipv6 router ospf area 0.0.0.0 tag L3VRF1 instance-id 0	Attaches the OSPFv3 instance ID to the IPv6 IRB interface.
PE1(config)#nvo vxlan vtep-ip-global 1.1.1.1	Configures the global VTEP IP address as 1.1.1.1.
PE1(config)#nvo vxlan id 101 ingress-replication	Configures the VXLAN ID as 101 for ingress replication.
PE1(config-nvo)# vxlan host-reachability-protocol evpn-bgp L2VRF1	Maps the EVPN-BGP host reachability protocol to L2VRF1.
PE1(config-nvo)# evpn irb1001	Maps the IRB interface 1001 to EVPN.
PE1(config-nvo)# vni-name VNI-101	Configures the VNI name as VNI-101.
PE1(config)#nvo vxlan id 2001 ingress-replication	Configures the VXLAN ID as 2001 for ingress replication.

PE1(config-nvo)# vxlan host-reachability-protocol evpn-bgp L2VRF1	Maps the EVPN-BGP host reachability protocol to L2VRF1.
PE1(config-nvo)# evpn irb2001	Maps the IPv6 IRB interface to EVPN.
PE1(config)#interface xe2	Configures the xe2 interface.
PE1(config-if)# switchport	Configures the port as a Layer 2 (L2) switchport.
PE1(config-if)# load-interval 30	Configures the load-interval of 30 minutes for monitoring traffic on the xe2 interface.
PE1(config-if)#interface xe2.100 switchport	Configures a Layer 2 access interface subinterface
PE1(config-if)# encapsulation dot1q 100	Sets the encapsulation to be a single-tag with VLAN ID 100
PE1(config-if)# rewrite pop	Configures the rewrite pop action.
PE1(config-if)# access-if-evpn	Configures the port as an access interface for EVPN.
PE1(config-acc-if-evpn)# map vpn-id 101	Maps the VPN ID 101 to the interface.
PE1(config)#interface xe2.2001 switchport	Configures a Layer 2 access interface subinterface.
PE1(config-if)# rewrite pop	Configures the rewrite pop action.
PE1(config-if)# access-if-evpn	Configures the port as an access interface for EVPN.
PE1(config-acc-if-evpn)# map vpn-id 2001	Maps the VPN ID 2001 to the interface.
PE1(config-router)#router bgp 100	Configures the BGP process with AS number 100.
PE1(config-router)# bgp router-id 1.1.1.1	Assigns the router ID as 1.1.1.1 for the BGP instance.
PE1(config-router)# neighbor 4.4.4.4 remote-as 100	Configures neighbor 4.4.4.4 with a remote AS number of 100.
PE1(config-router)# neighbor 4.4.4.4 update-source lo	Configures the update source for neighbor 4.4.4.4 to be the loopback interface.
PE1(config-router)# neighbor 4.4.4.4 advertisement-interval 0	Configures the advertisement interval for neighbor 4.4.4.4 as 0.
PE1(config-router)# address-family l2vpn evpn	Configures the address-family for L2VPN EVPN.
PE1(config-router-af)# neighbor 4.4.4.4 activate	Activates the neighbor for the L2VPN EVPN address-family.
PE1(config-router-af)# exit-address-family	Exits from the address family configuration.
PE1(config-router)# address-family ipv4 vrf L3VRF1	Configures the IPv4 address-family for VRF L3VRF1.
PE1(config-router-af)# redistribute connected	Configures the redistribution of connected routes within the IPv4 address-family.
PE1(config-router-af)# exit-address-family	Exits the IPv4 address-family configuration.
PE1(config-router)# address-family ipv6 vrf L3VRF1	Configures the IPv6 address-family for VRF L3VRF1.
PE1(config-router-af)# redistribute connected	Configures the redistribution of connected routes within the IPv6 address-family.
PE1(config-router-af)# exit-address-family	Exits the IPv6 address-family configuration.

PE5

PE5#configure terminal	Enters the configuration mode
PE5(config)#interface sa1	Configure the sa1 interface as a network interface.
PE5(config-if)# ip address 10.1.1.1/24	Assigns an IP address to the sa1 interface with a subnet mask of /24.

PE5(config-if)# ip ospf cost 10	Configures the OSPF cost for the sa1 interface, setting it to 10.
PE5(config-if)# load-interval 30	Configures the load-interval for monitoring traffic on the sa1 interface.
PE5(config)#interface xe1	Configure network interface towards PE6.
PE5(config-if)# static-channel-group 1	Assigns the static channel group 1 to the xe1 interface.
PE5(config)#interface xe5	configures the xe5 interface.
PE5(config-if)#ip address 30.1.1.1/24	Assigns the primary IP address 1.1.1.1/32 to the loopback interface and specifies it as secondary.
PE5(config)#ip ospf cost 10	Configures the OSPF cost for the xe5 interface, setting it to 10.
PE5(config-router)# ospf router-id 1.1.1.1	Assigns an IP address (30.1.1.1) to the xe5 interface with a subnet mask of /24.
PE5(config)#load-interval 30	Configures the load-interval for monitoring traffic on the xe5 interface.
PE5(config)#router ospf 1	Enters the OSPF configuration mode for OSPF process 1.
PE5(config-router)# network 30.1.1.0/24 area 0.0.0.0	Advertises the network 30.1.1.0/24 into OSPF area 0.0.0.0.
PE5(config-router)# network 10.1.1.0/24 area 0.0.0.0	Advertises the network 10.1.1.0/24 into OSPF area 0.0.0.0.

PE3

PE3#configure terminal	Enters the configuration mode
PE3(config)#interface ce30	Configure the ce30 interface as a network interface.
PE3(config-if)# ip address 40.1.1.2/24	Assigns an IP address to the ce30 interface with a subnet mask of /24.
PE3(config-if)# ip ospf cost 10	Configures the OSPF cost for the sa1 interface, setting it to 10.
PE3(config-if)# load-interval 30	Configures the load-interval for monitoring traffic on the sa1 interface.
PE3(config)#interface lo	Configure the loopback interface.
PE3(config-if)#ip address 4.4.4.4/32 secondary	Assign an secondary IP to an loopback interface.
PE3(config)#ip ospf cost 10	Configures the OSPF cost for the xe7interface, setting it to 10.
PE3(config)#load-interval 30	Configures the load-interval for monitoring traffic on the xe5 interface.
PE3(config)#router ospf 1	Enters the OSPF configuration mode for OSPF process 1.
PE3(config-router)# ospf router-id 4.4.4.4	Configures the router id to an ospf instance.
PE3(config-router)# network 4.4.4.4/32 area 0.0.0.0	Advertises the loopback address.
PE3(config-router)# network 40.1.1.0/24 area 0.0.0.0	Advertises the network interface IP address.
PE3(config)#hardware-profile filter vxlan enable	Enables hardware profile filter for vxlan
PE3(config)#nvo vxlan enable	Enables VXLAN on the device, allowing it to participate in VXLAN networks.

PE3(config)#nvo vxlan irb	Enables VXLAN IRB functionality, that allows routing between VXLAN and non-VXLAN networks.
PE3(config-vrf)#mac vrf L2VRF1	Configures a L2 MAC VRF instance named L2VRF1, which is a logical network segment for L2 traffic isolation.
PE3(config-vrf)# rd 4.4.4.4:11	Configures a RD for the L2VRF1, with the value 4.4.4.4:11.
PE3(config-vrf)# route-target both 9.9.9.9:100	Configures a route target for the VRF.
PE3(config-vrf)#ip vrf L3VRF1	Configures a L3 VRF named L3VRF1.
PE3(config-vrf)# rd 56000:11	Configures a RD for the L3VRF1, with the value 56000:11.
PE3(config-vrf)# route-target both 100:100	Configures a route target for the VRF.
PE3(config-vrf)# l3vni 1000	Configures a L3VNI with the ID 1000 for the VRF.
PE3(config)#interface irb1001	Configures the IRB interface with the ID 1001.
PE3(config-irb-if)# ip vrf forwarding L3VRF1	Associates the IRB interface with the L3VRF1, ensuring that traffic from this interface is isolated within that VRF.
PE3(config-irb-if)# ip address 12.12.12.1/24	Assigns an IP address 12.12.12.1 with a subnet mask of /24 to the IRB interface, enabling it for L3 routing.
PE3(config-irb-if)# mtu 1500	Configures the MTU for the interface irb1001 to 1500 bytes.
PE3(config)#interface irb2001	Configures another IRB interface with the ID 2001.
PE3(config-irb-if)# ip vrf forwarding L3VRF1	Associates the IRB interface with the L3VRF1.
PE3(config-irb-if)# ipv6 address 2002::1/64	Assigns an IPv6 address 2002::1 with a subnet mask of /64 to the IRB interface, enabling it for IPv6 routing.
PE3(config-irb-if)# mtu 1500	Configures the MTU for the interface irb2001 to 1500 bytes.
PE3(config-router)#router ospf 2 L3VRF1	Configures the OSPF routing process on OSPF instance 2 for the L3VRF1.
PE3(config-router)# network 12.12.12.0/24 area 0.0.0.0	Advertises the network 12.12.12.0/24 to OSPF area 0.0.0.0.
PE3(config-router)#router ipv6 vrf ospf L3VRF1	Configures the OSPFv3 routing process on OSPFv3 instance for the L3VRF1.
PE3(config-router)# router-id 4.4.4.4	Sets the router ID for the OSPF/OSPFv3 instances to 4.4.4.4.
PE3(config)#nvo vxlan vtep-ip-global 4.4.4.4	Configures the global VTEP IP address as 4.4.4.4 for VXLAN.
PE3(config)#nvo vxlan id 102 ingress-replication	Configures the VXLAN with VNI ID 102 for ingress replication.
PE3(config-nvo)# vxlan host-reachability-protocol evpn-bgp L2VRF1	Maps the VXLAN configuration with the EVPN-BGP protocol and associates it with the L2VRF1.
PE3(config-nvo)# evpn irb1001	Maps the IRB interface irb1001 to the VXLAN.
PE3(config-nvo)# vni-name VNI-101	Configures the VNI name as VNI-101.
PE3(config)#nvo vxlan id 2002 ingress-replication	Configures another VXLAN with VNI ID 2002 for ingress replication.
PE3(config-nvo)# vxlan host-reachability-protocol evpn-bgp L2VRF1	Maps the VXLAN configuration with the EVPN-BGP protocol and associates it with the L2VRF1.
PE3(config-nvo)# evpn irb2001	Maps the IPv6 IRB interface irb2001 to the VXLAN.
PE3(config)#interface sa4	Configures interface sa4.
PE3(config-if)# switchport	Configures the interface as a switchport.
PE3(config-if)# load-interval 30	Sets the load interval for the interface to 30 seconds.
PE3(config-if)# mtu 1500	Configures the MTU for the interface to 1500 bytes.

PE3(config)#interface xe1	Configures interface xe1.
PE3(config-if)# static-channel-group 4	Assigns a static channel group to interface xe1.
PE3(config-if)#interface sa4.100 switchport	Configures subinterface sa4.100 as a switchport with VLAN 100.
PE3(config-if)# encapsulation dot1q 100	Configures the encapsulation with VLAN ID 100.v
PE3(config-if)# rewrite pop	Configures the rewrite behavior for popping VLAN tags.
PE3(config-if)# access-if-evpn	Configures the interface as an access interface for EVPN.
PE3(config-acc-if-evpn)# map vpn-id 102	Maps the access interface to VPN ID 102 for EVPN routing.
PE3(config)#interface sa4.2002 switchport	Configures subinterface sa4.2002 as a switchport with VLAN 2002.
PE3(config-if)# encapsulation dot1q 2002	Configures the encapsulation with VLAN ID 2002.
PE3(config-if)# rewrite pop	Configures the rewrite behavior for popping VLAN tags.
PE3(config-if)# access-if-evpn	Configures the interface as an access interface for EVPN.
PE3(config-acc-if-evpn)# map vpn-id 2002	Maps the access interface to VPN ID 2002 for EVPN routing.
PE3(config-router)#router bgp 100	Configures the BGP with AS number 100.
PE3(config-router)# bgp router-id 4.4.4.4	Sets the BGP router ID to 4.4.4.4.
PE3(config-router)# neighbor 1.1.1.1 remote-as 100	Configures a BGP neighbor with the remote AS number 100 and the IP address 1.1.1.1.
PE3(config-router)# neighbor 1.1.1.1 update-source lo	Specifies the BGP neighbor to use the loopback interface as the source for updates.
PE3(config-router)# neighbor 1.1.1.1 advertisement-interval 0	Configures the advertisement interval for BGP neighbor updates.
PE3(config-router)# address-family l2vpn evpn	Configures the BGP address family for Layer 2 VPN EVPN.
PE3(config-router-af)# neighbor 1.1.1.1 activate	Activates the BGP neighbor for the specified address family.
PE3(config-router-af)# exit-address-family	Exits the BGP address family configuration.
PE3(config-router)# address-family ipv4 vrf L3VRF1	Configures the BGP address family for IPv4 within VRF L3VRF1.
PE3(config-router-af)# redistribute connected	Configures BGP to redistribute connected routes into the BGP process.
PE3(config-router-af)# exit-address-family	Exits the BGP address family configuration for IPv4.
PE3(config-router)# address-family ipv6 vrf L3VRF1	Configures the BGP address family for IPv6 within VRF L3VRF1.
PE3(config-router-af)# redistribute connected	Configures BGP to redistribute connected routes into the BGP process.
PE3(config-router-af)# exit-address-family	Exits the BGP address family configuration for IPv6.

PE6

PE6#configure terminal	Enters the configuration mode.
PE6(config)#interface ce2	Configure the ce2 interface as a network interface.
PE6(config-if)# ip address 10.1.1.1/24	Assigns an IP address to the sa1 interface with a subnet mask of /24.

PE6(config-if)# ip ospf cost 10	Configures the OSPF cost for the sa1 interface, setting it to 10.
PE6(config-if)# load-interval 30	Configures the load-interval for monitoring traffic on the sa1 interface.
PE6(config)#interface xe7	Configure network interface towards PE5.
PE6(config-if)# static-channel-group 1	Assigns the static channel group 1 to the xe1 interface.
PE6(config-if)#ip address 30.1.1.1/24	Assign IP address to network interface.
PE6(config)#ip ospf cost 10	Configures the OSPF cost for the xe7interface, setting it to 10.
PE6(config)#load-interval 30	Configures the load-interval for monitoring traffic on the xe5 interface.
PE6(config)#router ospf 1	Enters the OSPF configuration mode for OSPF process 1.
PE6(config-router)# network 30.1.1.0/24 area 0.0.0.0	Advertises the network 30.1.1.0/24 into OSPF area 0.0.0.0.
PE6(config-router)# network 40.1.1.0/24 area 0.0.0.0	Advertises the network 40.1.1.0/24 into OSPF area 0.0.0.0.

Topology for ISIS

The network topology includes various network elements such as routers, customer edge (CE) devices, Service Aggregator (SA) devices, and Provider Edge (PE) routers. The feature enables OSPF and ISIS support on the IRB interfaces, allowing for efficient routing and communication between network devices within the topology.

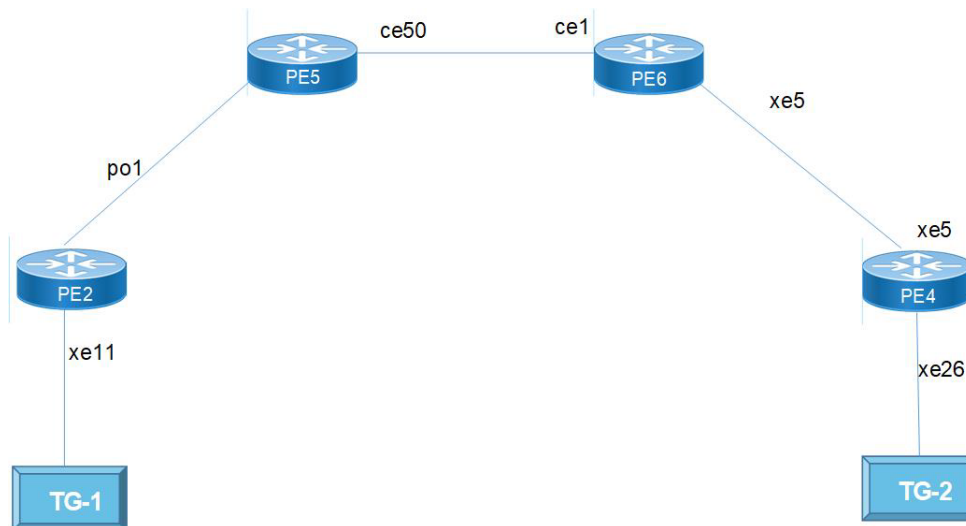

Single Home VxLAN IRB with ISIS

Configure ISIS

PE2

PE2(config-if)# interface po1	Enters configuration mode for po 1.
PE2(config-if)# ip address 20.1.1.1/24	Assigns the IP address 20.1.1.1 with a subnet mask of 255.255.255.0 to the interface.
PE2(config-if)#ip router isis 1	Enables ISIS routing protocol on the interface with process ID 1.
PE2(config-if)#load-interval 30	Sets the interval for which interface statistics are collected to 30 seconds.
PE2(config)#hardware-profile filter vxlan enable	Enables the hardware profile filter for VxLAN on the device.
PE2(config)#nvo vxlan enable	Enables the VXLAN feature on the device.
PE2(config)#nvo vxlan irb	Enables VXLAN IRB functionality.
PE2(config-vrf)#mac vrf L2VRF2	Enters the configuration mode for a MAC VRF named L2VRF2.
PE2(config-vrf)# rd 2.2.2.2:11	Sets the route distinguisher (RD) for the VRF to 2.2.2.2:11.
PE2(config-vrf)#route-target both 10.10.10.10:100	Specifies import and export route targets for the VRF.
PE2(config-vrf)#ip vrf L3VRF2	Enters the configuration mode for an IP VRF named L3VRF2.
PE2(config-vrf)#rd 61000:11	Sets the RD for the IP VRF to 61000:11
PE2(config-vrf)# route-target both 101:101	Specifies import and export route targets for the IP VRF.
PE2(config-vrf)# l3vni 2000	Configures the Layer 3 VNI (Virtual Network Identifier) for the IP VRF.
PE2(config)#interface irb2001	Enters the configuration mode for interface IRB2001.
PE2(config-irb-if)# ip vrf forwarding L3VRF2	Associates the interface with the IP VRF L3VRF2.
PE2(config-irb-if)# ip address 13.13.13.1/24	Configures an IP address with a subnet mask of /24 on IRB2001.
PE2(config-irb-if)#mtu 9000	Sets the Maximum Transmission Unit (MTU) for the interface to 9000 bytes.
PE2(config-irb-if)#ip router isis 2	Associates the interface with ISIS routing process 2.
PE2(config-irb)#interface irb3001	Enters the configuration mode for interface IRB3001.
PE2(config-irb-if)# ip vrf forwarding L3VRF2	Associates the interface with the IP VRF L3VRF2.
PE2(config-irb-if)# ipv6 address 3001::1/64	Configures an IPv6 address on IRB3001 with the specified prefix length.
PE2(config-irb-if)#mtu 9000	Sets the MTU for the interface to 9000 bytes.
PE2(config-irb)#ipv6 router isis 3	Associates the interface with IPv6 ISIS routing process 3.
PE2(config)#router isis 2 L3VRF2	Enters the configuration mode for ISIS routing process 2 within VRF L3VRF2.
PE2(config-router)#is-type level-1-2	Specifies the ISIS level type as level-1-2.
PE2(config-router)#metric-style wide	Configures a wide metric style for ISIS.
PE2(config-router)# dynamic-hostname	Enables dynamic hostname assignment for the ISIS router.
PE2(config-router)# bfd all-interfaces	Enables Bidirectional Forwarding Detection (BFD) on all interfaces within ISIS.

PE2(config-router)#net 49.0000.0000.0221.00	Configures the network entity title (NET) for the ISIS process.
PE2(config)#router isis 3 L3VRF2	Enters the configuration mode for ISIS routing process 3 within VRF L3VRF2.
PE2(config-router)#is-type level-1-2	Specifies the ISIS level type as level-1-2.
PE2(config-router)# metric-style wide	Configures a wide metric style for ISIS.
PE2(config-router)# dynamic-hostname	Enables dynamic hostname assignment for the ISIS router.
PE2(config-router)#bfd all-interfaces	Enables BFD on all interfaces within ISIS.
PE2(config-router)# net 49.0000.0000.0222.00	Configures the network entity title (NET) for ISIS routing with the specified value.
PE2(config)#nvo vxlan vtep-ip-global 2.2.2.2	Configures the global VxLAN VTEP IP address to 2.2.2.2.
PE2(config)#nvo vxlan id 201 ingress-replication	Configures a VxLAN with VNI 201 and specifies ingress-replication for multicast traffic handling.
PE2(config-nvo)# vxlan host-reachability-protocol evpn-bgp L2VRF2	Specifies the EVPN-BGP host-reachability-protocol for the VxLAN with the VRF L2VRF2
PE2(config-nvo)# evpn irb2001	Enables EVPN IRB (Integrated Routing and Bridging) for VxLAN interface IRB2001.
PE2(config-nvo)# vni-name VNI-201	Assigns a name VNI-201 to the VxLAN VNI 201.
PE2(config)#nvo vxlan id 3001 ingress-replication	Configures another VxLAN with VNI 3001 and specifies ingress-replication for multicast traffic handling.
PE2(config-nvo)# vxlan host-reachability-protocol evpn-bgp L2VRF2	Specifies the EVPN-BGP host-reachability-protocol for the VxLAN with the VRF L2VRF2.
PE2(config-nvo)# evpn irb3001	Enables EVPN IRB for VxLAN interface IRB3001.
PE2(config-if)#interface xe11	Enters the configuration mode for the interface 11.
PE2(config-if)#switchport	Configures the interface as a Layer 2 switchport.
PE2(config-if)#load-interval 30	Sets the interval for which interface statistics are collected to 30 seconds.
PE2(config-if)#interface xe11.200 switchport	Enters the configuration mode for subinterface xe11.200 and configures it as a Layer 2 switchport.
PE2(config-if)#encapsulation dot1q 200	Sets the IEEE 802.1Q VLAN encapsulation for subinterface xe11.200 with VLAN ID 200.
PE2(config-if)#rewrite pop	Configures the subinterface to rewrite the outer header for provider edge devices.
PE2(config-if)#access-if-evpn	Configures the subinterface as an access interface for EVPN (Ethernet VPN).
PE2(config-if)#map vpn-id 201	Maps the VPN ID 201 to the subinterface for EVPN.
PE2(config-if)#interface xe11.3001 switchport	Configures interface xe11.3001.
PE2(config-if)#encapsulation dot1q 200	Sets the IEEE 802.1Q VLAN encapsulation for subinterface xe11.200 with VLAN ID 200.
PE2(config-if)#rewrite pop	Configures the subinterface to rewrite the outer header for provider edge devices.
PE2(config-if)#access-if-evpn	Configures the subinterface as an access interface for EVPN.
PE2(config-if)#map vpn-id 3001	Maps the VPN ID 3001 to the subinterface for EVPN.
PE2(config-if)#router isis 1	Starts the ISIS routing process with process ID 1.
PE2(config-if)#is-type level-1-2	Specifies that the router participates in both Level 1 and Level 2 routing.

PE2(config-if)#metric-style wide	Configures the metric style to be wide, enabling more flexibility in metric calculations.
PE2(config-if)#mpls traffic-eng router-id 2.2.2.2	Sets the MPLS Traffic Engineering router ID to 2.2.2.2.
PE2(config-if)#mpls traffic-eng level-1	Enables MPLS Traffic Engineering for Level 1 ISIS.
PE2(config-if)#mpls traffic-eng level-2	Enables MPLS Traffic Engineering for Level 2 ISIS.
PE2(config-if)#dynamic-hostname	Enables the dynamic hostname feature for ISIS.
PE2(config-if)#bfd all-interfaces	Configures Bidirectional Forwarding Detection on all interfaces.
PE2(config-if)#net 49.0000.0000.0001.00	Specifies the network entity title (NET) for ISIS.

BGP Configuration

PE2(config)#router bgp 100	Starts the BGP routing process with an autonomous system number (AS) of 100.
PE2(config-router)#bgp router-id 2.2.2.2	Sets the BGP router ID to 2.2.2.2.
PE2(config-router)#neighbor 3.3.3.3 remote-as 100	Configures a BGP neighbor with the IP address 3.3.3.3 and specifies the remote AS number as 100.
PE2(config-router)#neighbor 3.3.3.3 update-source lo	Specifies that loopback interface (lo) is the source for BGP updates to the neighbor.
PE2(config-router)#neighbor 3.3.3.3 advertisement-interval 0	Sets the advertisement interval to 0, which means updates will be sent immediately.
PE2(config-router)#address-family ipv4 unicast	Enters the configuration mode for the IPv4 unicast address family within the router configuration.
PE2(config-router-af)#network 2.2.2.2/32	Specifies that network 2.2.2.2 with a /32 subnet mask is part of the IPv4 unicast address family.
PE2(config-router-af)#neighbor 3.3.3.3 activate	Activates the neighbor with the IP address 3.3.3.3 for the IPv4 unicast address family.
PE2(config-router-af)#exit-address-family	Exits the configuration mode for the IPv4 unicast address family.
PE2(config-router)#address-family l2vpn evpn	Enters the configuration mode for the L2VPN EVPN address family within the router configuration.
PE2(config-router-af)#neighbor 3.3.3.3 activate	Activates the neighbor with the IP address 3.3.3.3 for the L2VPN EVPN address family.
PE2(config-router-af)#exit-address-family	Exits the configuration mode for the L2VPN EVPN address family.
PE2(config-router)#address-family ipv4 vrf L3VRF2	Enters the configuration mode for the IPv4 address family within the VRF named L3VRF2.
PE2(config-router-af)#redistribute connected	Configures the redistribution of directly connected routes into the IPv4 address family for the specified VRF.
PE2(config-router-af)#exit-address-family	Exits the configuration mode for the IPv4 address family within the VRF L3VRF2.
PE2(config-router-af)#address-family ipv6 vrf L3VRF2	Enters the configuration mode for the IPv6 address family within the VRF named L3VRF2.
PE2(config-router-af)#redistribute connected	Configures the redistribution of directly connected routes into the IPv6 address family for the specified VRF.
PE2(config-router-af)#exit-address-family	Exits the configuration mode for the IPv6 address family within the VRF L3VRF2.

PE5

PE5(config-if)#interface po1	Enters the configuration mode for po1.
PE5(config-if)#ip address 20.1.1.2/24	Assigns the IP address 20.1.1.2 with a subnet mask of /24 to this interface.
PE5(config-if)#ip router isis 1	Specifies that ISIS routing process 1 is enabled on this interface.
PE5(config-if)#load-interval 30	Sets the load interval to 30 seconds for monitoring the interface.
PE5(config-if)#interface ce50	Enters the configuration mode for ce50.
PE5(config-if)#ip address 50.1.1.1/24	Assigns the IP address 50.1.1.1 with a subnet mask of /24 to this interface.
PE5(config-if)#ip router isis 1	Specifies that ISIS routing process 1 is enabled on this interface.
PE5(config-if)#load-interval 30	Sets the load interval to 30 seconds for monitoring the interface.
PE5(config-if)#router isis 1	Enters ISIS configuration mode with process ID 1.
PE5(config-if)#is-type level-1-2	Configures this ISIS router to support both Level 1 and Level 2 routing.
PE5(config-if)#metric-style wide	Configures ISIS to use the wide metric style, which allows for greater flexibility in metric values.
PE5(config-if)#dynamic-hostname	Allows the hostname to be dynamically generated.
PE5(config-if)#bfd all-interfaces	Enables Bidirectional Forwarding Detection on all interfaces.
PE5(config-if)#net 49.0000.0005.0001.00	Sets the NET for this router.
PE5(config-if)#exit	Exits from the router mode.

PE 6

PE6#configure terminal	Enters the configuration mode.
PE6(config-if)#interface xe5	Enters configuration mode for interface xe5.
PE6(config-if)#ip address 60.1.1.1/24	Assigns the IP address 80.1.1.2 with a subnet mask of 255.255.255.0 to interface sa2.
PE6(config-if)#ip router isis 1	Associates ISIS routing protocol with this interface using process ID 1.
PE6(config-if)#load-interval 30	Sets the load-interval to 30 seconds.
PE6(config-if)#interface ce1	Enters configuration mode for interface ce1.
PE6(config-if)#ip address 50.1.1.2/24	Assigns the IP address 50.1.1.2 with a subnet mask of 255.255.255.0 to interface ce1.
PE6(config-if)#ip router isis 1	Associates ISIS routing protocol with this interface using process ID 1.
PE6(config-if)#load-interval 30	Sets the load-interval to 30 seconds.
PE6(config-if)#router isis 1	Enters ISIS configuration mode with process ID 1.
PE6(config-if)#is-type level-1-2	Configures this ISIS router to support both Level 1 and Level 2 routing.
PE6(config-if)#metric-style wide	Configures ISIS to use the wide metric style, which allows for greater flexibility in metric values.

PE6(config-if)#dynamic-hostname	Allows the hostname to be dynamically generated.
PE6(config-if)#bfd all-interfaces	Enable BFD on all network interfaces.

PE4

PE4#configure terminal	Enters the configuration mode.
PE4(config-if)# interface xe26	Enters configuration mode for xe26.
PE4(config-if)# ip address 60.1.1.2/24	Assigns the IP address 60.1.1.2 with a subnet mask of 255.255.255.0 to the interface.
PE4(config-if)#ip router isis 1	Enables ISIS routing protocol on the interface with process ID 1.
PE4(config-if)#ip router isis 1	Enables ISIS routing protocol on the interface with process ID 1.
PE4(config-if)#load-interval 30	Sets the interval for which interface statistics are collected to 30 seconds.
PE4(config)#hardware-profile filter vxlan enable	Enables the hardware profile filter for VXLAN.
PE4(config)#nvo vxlan enable	Enables the VXLAN feature on the device.
PE4(config)#nvo vxlan irb	Enables VXLAN IRB functionality.
PE4(config-vrf)#mac vrf L2VRF2	Configures a VRF instance named L2VRF2 and associates it with a specific RD
PE4(config-vrf)# rd 3.3.3.3:11	Sets the RD for the L2VRF2 VRF to 3.3.3.3:11.
PE4(config-vrf)#route-target both 10.10.10.10:100	Associates a route target with the L2VRF2 VRF for VPN route distribution.
PE4(config-vrf)#ip vrf L3VRF2	Configures another VRF named L3VRF2.
PE4(config-vrf)#rd 63000:11	Sets the RD for the L3VRF2 VRF to 63000:11.
PE4(config-vrf)# route-target both 101:101	Associates a route target with the L3VRF2 VRF for VPN route distribution.
PE4(config-vrf)# l3vni 2000	Configures the L3VNI for the L3VRF2 VRF.
PE4(config)#interface irb2001	Configuring an IRB interface with the number 2001.
PE4(config-irb-if)# ip vrf forwarding L3VRF2	Associates the IRB interface with the L3VRF2 VRF.
PE4(config-irb-if)# ip address 14.14.14.1/24	Assigns an IP address to the IRB interface.
PE4(config-irb-if)#mtu 9000	Sets the MTU for the IRB interface.
PE4(config-irb-if)#ip router isis 2	Associates the IRB interface with ISIS routing.
PE4(config-irb)#interface irb3002	Configures another IRB interface with the number 3002.
PE4(config-irb-if)# ip vrf forwarding L3VRF2	Associates the second IRB interface with the "L3VRF2" VRF.
PE4(config-irb-if)# ipv6 address 3002::1/64	Assigns an IPv6 address to the second IRB interface.
PE4(config-irb-if)#mtu 9000	Sets the MTU for the second IRB interface.
PE4(config-irb)#ipv6 router isis 3	Associates the IRB interfaces with IPv6 and ISIS routing.
PE4(config)#router isis 2 L3VRF2	Configures ISIS routing with the VRF L3VRF2.
PE4(config-router)#is-type level-1-2	Sets the ISIS level type to level-1-2.
PE4(config-router)# metric-style wide	Configures a wide metric style for ISIS.
PE4(config-router)# dynamic-hostname	Enables dynamic hostname assignment for the ISIS router.
PE4(config-router)#bfd all-interfaces	Enables BFD on all interfaces within ISIS.

PE4(config-router)# net 49.0000.0000.0441.00	Configures the network entity title (NET) for ISIS routing with the specified value.
PE4(config)#router isis 3 L3VRF2	Configures ISIS routing with the VRF L3VRF2.
PE4(config-router)#is-type level-1-2	Sets the ISIS level type to level-1-2.
PE4(config-router)# metric-style wide	Configures a wide metric style for ISIS.
PE4(config-router)# dynamic-hostname	Enables dynamic hostname assignment for the ISIS router.
PE4(config-router)#bfd all-interfaces	Enables BFD on all interfaces within ISIS.
PE4(config-router)# net 49.0000.0000.0442.00	Configures the network entity title (NET) for ISIS routing with the specified value.
PE4(config)#nvo vxlan vtep-ip-global 3.3.3.3	Configures the global VxLAN VTEP IP address to 3.3.3.3.
PE4(config)#nvo vxlan id 201 ingress-replication	Configures a VxLAN with VNI 201 and specifies ingress-replication for multicast traffic handling.
PE4(config-nvo)# vxlan host-reachability-protocol evpn-bgp L2VRF2	Specifies the EVPN-BGP host-reachability-protocol for the VxLAN with the VRF L2VRF2
PE4(config-nvo)# evpn irb2001	Enables EVPN IRB (Integrated Routing and Bridging) for VxLAN interface IRB2001.
PE4(config-nvo)# vni-name VNI-201	Assigns a name VNI-201 to the VxLAN VNI 201.
PE4(config)#nvo vxlan id 3002 ingress-replication	Configures another VxLAN with VNI 3002 and specifies ingress-replication for multicast traffic handling.
PE4(config-nvo)# vxlan host-reachability-protocol evpn-bgp L2VRF2	Specifies the EVPN-BGP host-reachability-protocol for the VxLAN with the VRF L2VRF2.
PE4(config-nvo)# evpn irb3002	Enables EVPN IRB for VxLAN interface IRB3002
PE4(config-if)#interface xe26	Enters the configuration mode for the interface 26.
PE4(config-if)#switchport	Configures the interface as a L2 switchport.
PE4(config-if)#load-interval 30	Sets the interval for which interface statistics are collected to 30 seconds.
PE4(config)#hardware-profile filter vxlan enable	Enables the hardware profile filter for VxLAN on the device.
PE4(config-if)#interface xe26.200 switchport	Enters the configuration mode for subinterface xe26.200 and configures it as a Layer 2 switchport.
PE4(config-if)#encapsulation dot1q 200	Sets the IEEE 802.1Q VLAN encapsulation for subinterface xe11.200 with VLAN ID 200.
PE4(config-if)#rewrite pop	Configures the subinterface to rewrite the outer header for provider edge devices.
PE4(config-if)#access-if-evpn	Configures the subinterface as an access interface for EVPN (Ethernet VPN).
PE4(config-if)#map vpn-id 201	Maps the VPN ID 201 to the subinterface for EVPN.
PE4(config-if)#interface xe26.3001 switchport	Configures xe26.3001 interface.
PE4(config-if)#encapsulation dot1q 200	Sets the IEEE 802.1Q VLAN encapsulation for subinterface xe11.200 with VLAN ID 200.
PE4(config-if)#rewrite pop	Configures the subinterface to rewrite the outer header for provider edge devices.
PE4(config-if)#access-if-evpn	Configures the subinterface as an access interface for EVPN.
PE4(config-if)#map vpn-id 3002	Maps the VPN ID 3002 to the subinterface for EVPN.
PE4(config-if)#router isis 1	Starts the ISIS routing process with process ID 1.

PE4(config-if)#is-type level-1-2	Specifies that the router participates in both Level 1 and Level 2 routing.
PE4(config-if)#metric-style wide	Configures the metric style to be wide, enabling more flexibility in metric calculations.
PE4(config-if)#mpls traffic-eng router-id 2.2.2.2	Sets the MPLS Traffic Engineering router ID to 2.2.2.2.
PE4(config-if)#mpls traffic-eng level-1	Enables MPLS Traffic Engineering for Level 1 ISIS.
PE4(config-if)#mpls traffic-eng level-2	Enables MPLS Traffic Engineering for Level 2 ISIS.
PE4(config-if)#dynamic-hostname	Enables the dynamic hostname feature for ISIS.
PE4(config-if)#bfd all-interfaces	Configures Bidirectional Forwarding Detection on all interfaces.
PE4(config-if)#net 49.0000.0003.0001.00	Specifies the network entity title (NET) for ISIS.

BGP Configuration

PE4(config)#router bgp 100	Starts the BGP routing process with an autonomous system number (AS) of 100.
PE4(config-router)#bgp router-id 3.3.3.3	Sets the BGP router ID to 3.3.3.3
PE4(config-router)#neighbor 2.2.2.2 remote-as 100	Configures a BGP neighbor with the IP address 2.2.2.2 and specifies the remote AS number as 100.
PE4(config-router)#neighbor 2.2.2.2 update-source lo	Specifies that loopback interface (lo) is the source for BGP updates to the neighbor.
PE4(config-router)#neighbor 2.2.2.2 advertisement-interval 0	Sets the advertisement interval to 0, which means updates will be sent immediately.
PE4(config-router)#address-family ipv4 unicast	Enters the configuration mode for the IPv4 unicast address family within the router configuration.
PE4(config-router-af)#network 3.3.3.3/32	Specifies that network 3.3.3.3 with a /32 subnet mask is part of the IPv4 unicast address family.
PE4(config-router-af)#neighbor 2.2.2.2 activate	Activates the neighbor with the IP address 2.2.2.2 for the IPv4 unicast address family.
PE4(config-router-af)#exit-address-family	Exits the configuration mode for the IPv4 unicast address family.
PE4(config-router)#address-family l2vpn evpn	Enters the configuration mode for the L2VPN EVPN address family within the router configuration.
PE4(config-router-af)#neighbor 2.2.2.32 activate	Activates the neighbor with the IP address 2.2.2.2 for the L2VPN EVPN address family.
PE4(config-router-af)#exit-address-family	Exits the configuration mode for the L2VPN EVPN address family.
PE4(config-router)#address-family ipv4 vrf L3VRF2	Enters the configuration mode for the IPv4 address family within the VRF named L3VRF2.
PE4(config-router-af)#redistribute connected	Configures the redistribution of directly connected routes into the IPv4 address family for the specified VRF.
PE4(config-router-af)#exit-address-family	Exits the configuration mode for the IPv4 address family within the VRF L3VRF2.
PE4(config-router-af)#address-family ipv6 vrf L3VRF2	Enters the configuration mode for the IPv6 address family within the VRF named L3VRF2.

PE4 (config-router-af) #redistribute connected	Configures the redistribution of directly connected routes into the IPv6 address family for the specified VRF.
PE4 (config-router-af) #exit-address-family	Exits the configuration mode for the IPv6 address family within the VRF L3VRF2.

Implementation Examples

Scenario: Configure OSPF and ISIS protocols on an IRB interface with an assigned IP address.

Validation

OSPF Validation

```
PE1#show ip ospf neighbor
Total number of full neighbors: 1
OSPF process 1 VRF(default):
Neighbor ID      Pri   State                Dead Time   Address      Interface
  Instance ID
50.1.1.1         1    Full/DR              00:00:38   10.1.1.2    sa1
  0
```

```
Total number of full neighbors: 1
OSPF process 2 VRF(L3VRF1):
Neighbor ID      Pri   State                Dead Time   Address      Interface
  Instance ID
192.0.0.1        0    Full/DROther        00:00:34   11.11.11.2  irb1001
  0
```

```
PE1#show nvo vxlan tunnel
VXLAN Network tunnel Entries
Source           Destination      Status          Up/Down        Update
=====
1.1.1.1          4.4.4.4         Installed       00:15:59      00:15:59
```

Total number of entries are 2

```
PE1#show evpn irb-status
```

IRB is ACTIVE in Hardware

```
PE1#show nvo vxlan arp-cache
```

VXLAN ARP-CACHE Information

```
=====
VNID   Ip-Addr      Mac-Addr          Type          Age-Out      Retries-Left
-----
101    11.11.11.1   9819.2ccd.9301   Static Local   ----
101    11.11.11.2   0010.9400.0001   Dynamic Local  ----
```

Total number of entries are 2

```
PE1#show ip route vrf all
```

Codes: K - kernel, C - connected, S - static, R - RIP, B - BGP

O - OSPF, IA - OSPF inter area

N1 - OSPF NSSA external type 1, N2 - OSPF NSSA external type 2

E1 - OSPF external type 1, E2 - OSPF external type 2
 i - IS-IS, L1 - IS-IS level-1, L2 - IS-IS level-2,
 ia - IS-IS inter area, E - EVPN,
 v - vrf leaked
 * - candidate default

IP Route Table for VRF "default"

```
C      1.1.1.1/32 is directly connected, lo, 00:53:03
O      4.4.4.4/32 [110/31] via 10.1.1.2, sa1, 00:16:29
O      7.7.7.7/32 [110/12] via 10.1.1.2, sa1, 00:44:26
C      10.1.1.0/24 is directly connected, sa1, 00:50:10
O      30.1.1.0/24 [110/20] via 10.1.1.2, sa1, 00:44:22
O      40.1.1.0/24 [110/30] via 10.1.1.2, sa1, 00:17:14
O      70.1.1.0/24 [110/11] via 10.1.1.2, sa1, 00:45:18
C      127.0.0.0/8 is directly connected, lo, 00:53:03
```

IP Route Table for VRF "management"

```
C      10.12.98.0/24 is directly connected, eth0, 00:53:03
C      127.0.0.0/8 is directly connected, lo.management, 00:53:03
```

IP Route Table for VRF "L2VRF1"

IP Route Table for VRF "L3VRF1"

```
B      4.4.4.4/32 [0/0] is directly connected, tunvxlan2, 00:16:25
B      7.7.7.7/32 [0/0] is directly connected, tunvxlan2, 00:44:21
C      11.11.11.0/24 is directly connected, irb1001, 00:53:03
B      12.12.12.0/24 [200/0] via 4.4.4.4 (recursive is directly connected,
tunvxlan2), 00:16:26
B      16.16.16.0/24 [200/0] via 7.7.7.7 (recursive is directly connected,
tunvxlan2), 00:44:21
C      127.0.0.0/8 is directly connected, lo.L3VRF1, 00:53:03
```

Gateway of last resort is not set

PE1#show bgp l2vpn evpn

BGP table version is 5, local router ID is 1.1.1.1

Status codes: s suppressed, d damped, h history, a add-path, * valid, > best, i
 - internal,

l - labeled, S Stale

Origin codes: i - IGP, e - EGP, ? - incomplete

[EVPN route type]:[ESI]:[VNID]:[relevent route informantion]

1 - Ethernet Auto-discovery Route
 2 - MAC/IP Route
 3 - Inclusive Multicast Route
 4 - Ethernet Segment Route
 5 - Prefix Route

Network	Next Hop	Metric	LocPrf	Weight	Path Peer	Encap
---------	----------	--------	--------	--------	-----------	-------

RD[7100:11]

```
*>i [5]:[0]:[0]:[24]:[16.16.16.0]:[0.0.0.0]:[1000]
```

```

7.7.7.7          0          100          0    i  7.7.7.7          VXLAN
*>i  [5]:[0]:[0]:[64]:[7002::]:[::]:[1000]
7.7.7.7          0          100          0    i  7.7.7.7          VXLAN

RD[56000:11]
*>i  [5]:[0]:[0]:[24]:[12.12.12.0]:[0.0.0.0]:[1000]
4.4.4.4          0          100          0    ?  4.4.4.4          VXLAN
*>i  [5]:[0]:[0]:[64]:[2002::]:[::]:[1000]
4.4.4.4          0          100          0    ?  4.4.4.4          VXLAN

RD[1.1.1.1:11] VRF[L2VRF1]:
*>  [2]:[0]:[101]:[48,0010:9400:0001]:[0]:[101]
1.1.1.1          0          100          32768  i  -----          VXLAN
*>  [2]:[0]:[101]:[48,0010:9400:0001]:[32,11.11.11.2]:[101]
1.1.1.1          0          100          32768  i  -----          VXLAN
*>  [2]:[0]:[101]:[48,9819:2ccd:9301]:[32,11.11.11.1]:[101]
1.1.1.1          0          100          32768  i  -----          VXLAN
* i  [2]:[0]:[102]:[48,0010:9400:0002]:[0]:[102]
4.4.4.4          0          100          0      i  4.4.4.4          VXLAN
* i  [2]:[0]:[102]:[48,0010:9400:0002]:[32,12.12.12.2]:[102]
4.4.4.4          0          100          0      i  4.4.4.4          VXLAN
* i  [2]:[0]:[102]:[48,5c07:5813:425e]:[32,12.12.12.1]:[102]
4.4.4.4          0          100          0      i  4.4.4.4          VXLAN
*>  [2]:[0]:[2001]:[48,0010:9400:0009]:[0]:[2001]
1.1.1.1          0          100          32768  i  -----          VXLAN
*>  [2]:[0]:[2001]:[48,0010:9400:0009]:[128,2001::2][2001]
1.1.1.1          0          100          32768  i  -----          VXLAN
*>  [2]:[0]:[2001]:[48,9819:2ccd:9301]:[128,2001::1][2001]
1.1.1.1          0          100          32768  i  -----          VXLAN
* i  [2]:[0]:[2002]:[48,0010:9400:000a]:[0]:[2002]
4.4.4.4          0          100          0      i  4.4.4.4          VXLAN
* i  [2]:[0]:[2002]:[48,0010:9400:000a]:[128,2002::2][2002]
4.4.4.4          0          100          0      i  4.4.4.4          VXLAN
* i  [2]:[0]:[2002]:[48,5c07:5813:425e]:[128,2002::1][2002]
4.4.4.4          0          100          0      i  4.4.4.4          VXLAN
*>  [3]:[101]:[32,1.1.1.1]
1.1.1.1          0          100          32768  i  -----          VXLAN
* i  [3]:[102]:[32,4.4.4.4]
4.4.4.4          0          100          0      i  4.4.4.4          VXLAN
*>  [3]:[2001]:[32,1.1.1.1]
1.1.1.1          0          100          32768  i  -----          VXLAN
* i  [3]:[2002]:[32,4.4.4.4]
4.4.4.4          0          100          0      i  4.4.4.4          VXLAN

RD[4.4.4.4:11]
*>i  [2]:[0]:[102]:[48,0010:9400:0002]:[0]:[102]
4.4.4.4          0          100          0      i  4.4.4.4          VXLAN
*>i  [2]:[0]:[102]:[48,0010:9400:0002]:[32,12.12.12.2]:[102]
4.4.4.4          0          100          0      i  4.4.4.4          VXLAN
*>i  [2]:[0]:[102]:[48,5c07:5813:425e]:[32,12.12.12.1]:[102]

```

```

          4.4.4.4          0          100          0          i  4.4.4.4          VXLAN
*>i [2]:[0]:[2002]:[48,0010:9400:000a]:[0]:[2002]
          4.4.4.4          0          100          0          i  4.4.4.4          VXLAN
*>i [2]:[0]:[2002]:[48,0010:9400:000a]:[128,2002::2][2002]
          4.4.4.4          0          100          0          i  4.4.4.4          VXLAN
*>i [2]:[0]:[2002]:[48,5c07:5813:425e]:[128,2002::1][2002]
          4.4.4.4          0          100          0          i  4.4.4.4          VXLAN
*>i [3]:[102]:[32,4.4.4.4]
          4.4.4.4          0          100          0          i  4.4.4.4          VXLAN
*>i [3]:[2002]:[32,4.4.4.4]
          4.4.4.4          0          100          0          i  4.4.4.4          VXLAN

```

Total number of prefixes 28

PE3#show nvo vxlan tunnel

VXLAN Network tunnel Entries

Source	Destination	Status	Up/Down	Update
4.4.4.4	1.1.1.1	Installed	00:18:19	00:18:19

Total number of entries are 1

PE3#show ip ospf neighbor

Total number of full neighbors: 1

OSPF process 1 VRF(default):

Neighbor ID	Pri	State	Dead Time	Address	Interface
40.1.1.2	1	Full/DR	00:00:36	40.1.1.1	ce30
0					

Total number of full neighbors: 1

OSPF process 2 VRF(L3VRF1):

Neighbor ID	Pri	State	Dead Time	Address	Interface
192.0.0.2	0	Full/DROther	00:00:36	12.12.12.2	irb1001
0					

PE3#show ip route vrf all

Codes: K - kernel, C - connected, S - static, R - RIP, B - BGP

O - OSPF, IA - OSPF inter area

N1 - OSPF NSSA external type 1, N2 - OSPF NSSA external type 2

E1 - OSPF external type 1, E2 - OSPF external type 2

i - IS-IS, L1 - IS-IS level-1, L2 - IS-IS level-2,

ia - IS-IS inter area, E - EVPN,

v - vrf leaked

* - candidate default

IP Route Table for VRF "default"

```

O          1.1.1.1/32 [110/31] via 40.1.1.1, ce30, 00:18:35
C          4.4.4.4/32 is directly connected, lo, 00:19:22
O          7.7.7.7/32 [110/22] via 40.1.1.1, ce30, 00:18:35

```



```

O      10.1.1.0/24 [110/30] via 40.1.1.1, ce30, 00:18:35
O      30.1.1.0/24 [110/20] via 40.1.1.1, ce30, 00:18:35
C      40.1.1.0/24 is directly connected, ce30, 00:19:21
O      70.1.1.0/24 [110/21] via 40.1.1.1, ce30, 00:18:35
C      127.0.0.0/8 is directly connected, lo, 00:20:05
IP Route Table for VRF "management"
C      10.12.98.0/24 is directly connected, eth0, 00:19:19
C      127.0.0.0/8 is directly connected, lo.management, 00:20:05
IP Route Table for VRF "L3VRF1"
B      1.1.1.1/32 [0/0] is directly connected, tunvxlan2, 00:18:31
B      11.11.11.0/24 [200/0] via 1.1.1.1 (recursive is directly connected,
tunvxlan2), 00:18:32
C      12.12.12.0/24 is directly connected, irb1001, 00:19:28
C      127.0.0.0/8 is directly connected, lo.L3VRF1, 00:19:29
IP Route Table for VRF "L2VRF1"

```

Gateway of last resort is not set

PE3# show bgp l2vpn evpn

BGP table version is 4, local router ID is 4.4.4.4

Status codes: s suppressed, d damped, h history, a add-path, * valid, > best, i
- internal,

l - labeled, S Stale

Origin codes: i - IGP, e - EGP, ? - incomplete

[EVPN route type]:[ESI]:[VNID]:[relevent route informantion]

1 - Ethernet Auto-discovery Route

2 - MAC/IP Route

3 - Inclusive Multicast Route

4 - Ethernet Segment Route

5 - Prefix Route

Network	Next Hop	Metric	LocPrf	Weight	Path Peer	Encap
RD[51000:11]						
*>i [5]:[0]:[0]:[24]:[11.11.11.0]:[0.0.0.0]:[1000]	1.1.1.1	0	100	0	? 1.1.1.1	VXLAN
*>i [5]:[0]:[0]:[64]:[2001::]:[::]:[1000]	1.1.1.1	0	100	0	? 1.1.1.1	VXLAN
RD[1.1.1.1:11]						
*>i [2]:[0]:[101]:[48,0010:9400:0001]:[0]:[101]	1.1.1.1	0	100	0	i 1.1.1.1	VXLAN
*>i [2]:[0]:[101]:[48,0010:9400:0001]:[32,11.11.11.2]:[101]	1.1.1.1	0	100	0	i 1.1.1.1	VXLAN
*>i [2]:[0]:[101]:[48,9819:2ccd:9301]:[32,11.11.11.1]:[101]	1.1.1.1	0	100	0	i 1.1.1.1	VXLAN
*>i [2]:[0]:[2001]:[48,0010:9400:0009]:[0]:[2001]	1.1.1.1	0	100	0	i 1.1.1.1	VXLAN
*>i [2]:[0]:[2001]:[48,0010:9400:0009]:[128,2001::2][2001]	1.1.1.1	0	100	0	i 1.1.1.1	VXLAN

```

*>i [2]:[0]:[2001]:[48,9819:2ccd:9301]:[128,2001:::1][2001]
      1.1.1.1          0          100          0      i  1.1.1.1          VXLAN
*>i [3]:[101]:[32,1.1.1.1]
      1.1.1.1          0          100          0      i  1.1.1.1          VXLAN
*>i [3]:[2001]:[32,1.1.1.1]
      1.1.1.1          0          100          0      i  1.1.1.1          VXLAN

RD[4.4.4.4:11] VRF[L2VRF1]:
* i [2]:[0]:[101]:[48,0010:9400:0001]:[0]:[101]
      1.1.1.1          0          100          0      i  1.1.1.1          VXLAN
* i [2]:[0]:[101]:[48,0010:9400:0001]:[32,11.11.11.2]:[101]
      1.1.1.1          0          100          0      i  1.1.1.1          VXLAN
* i [2]:[0]:[101]:[48,9819:2ccd:9301]:[32,11.11.11.1]:[101]
      1.1.1.1          0          100          0      i  1.1.1.1          VXLAN
*> [2]:[0]:[102]:[48,0010:9400:0002]:[0]:[102]
      4.4.4.4          0          100          32768  i  -----          VXLAN
*> [2]:[0]:[102]:[48,0010:9400:0002]:[32,12.12.12.2]:[102]
      4.4.4.4          0          100          32768  i  -----          VXLAN
*> [2]:[0]:[102]:[48,5c07:5813:425e]:[32,12.12.12.1]:[102]
      4.4.4.4          0          100          32768  i  -----
VXLAN
* i [2]:[0]:[2001]:[48,0010:9400:0009]:[0]:[2001]
      1.1.1.1          0          100          0      i  1.1.1.1          VXLAN
* i [2]:[0]:[2001]:[48,0010:9400:0009]:[128,2001:::2][2001]
      1.1.1.1          0          100          0      i  1.1.1.1          VXLAN
* i [2]:[0]:[2001]:[48,9819:2ccd:9301]:[128,2001:::1][2001]
      1.1.1.1          0          100          0      i  1.1.1.1          VXLAN
*> [2]:[0]:[2002]:[48,0010:9400:000a]:[0]:[2002]
      4.4.4.4          0          100          32768  i  -----          VXLAN
*> [2]:[0]:[2002]:[48,0010:9400:000a]:[128,2002:::2][2002]
      4.4.4.4          0          100          32768  i  -----          VXLAN
*> [2]:[0]:[2002]:[48,5c07:5813:425e]:[128,2002:::1][2002]
      4.4.4.4          0          100          32768  i  -----          VXLAN
* i [3]:[101]:[32,1.1.1.1]
      1.1.1.1          0          100          0      i  1.1.1.1          VXLAN
*> [3]:[102]:[32,4.4.4.4]
      4.4.4.4          0          100          32768  i  -----          VXLAN
* i [3]:[2001]:[32,1.1.1.1]
      1.1.1.1          0          100          0      i  1.1.1.1          VXLAN
*> [3]:[2002]:[32,4.4.4.4]
      4.4.4.4          0          100          32768  i  -----          VXLAN

```

Total number of prefixes 26

ISIS Validation

```
PE2#show nvo vxlan tunnel
```

```
VXLAN Network tunnel Entries
```

Source	Destination	Status	Up/Down	Update
2.2.2.2	3.3.3.3	Installed	00:00:10	00:00:10

Total number of entries are 1
PE2#show clns neighbors

Total number of L1 adjacencies: 1
Total number of L2 adjacencies: 1
Total number of adjacencies: 2

Tag 1: VRF : default

System Id	Interface	SNPA	State	Holdtime	Type	Protocol
PE5	po1	b86a.9725.a7f2	Up	28	L1	IS-IS
			Up	28	L2	IS-IS

Total number of L1 adjacencies: 0
Total number of L2 adjacencies: 1
Total number of adjacencies: 1

Tag 2: VRF : L3VRF2

System Id	Interface	SNPA	State	Holdtime	Type	Protocol
Spirent-1	irb2001	0010.9400.0003	Up	28	L2	IS-IS

Total number of L1 adjacencies: 0
Total number of L2 adjacencies: 1
Total number of adjacencies: 1

Tag 3: VRF : L3VRF2

System Id	Interface	SNPA	State	Holdtime	Type	Protocol
Spirent-1	irb3001	0010.9400.000c	Up	28	L2	IS-IS

PE2#show ip route vrf all

Codes: K - kernel, C - connected, S - static, R - RIP, B - BGP
O - OSPF, IA - OSPF inter area
N1 - OSPF NSSA external type 1, N2 - OSPF NSSA external type 2
E1 - OSPF external type 1, E2 - OSPF external type 2
i - IS-IS, L1 - IS-IS level-1, L2 - IS-IS level-2,
ia - IS-IS inter area, E - EVPN,
v - vrf leaked
* - candidate default

IP Route Table for VRF "default"

```
C          2.2.2.2/32 is directly connected, lo, 02:13:57
i L2       3.3.3.3/32 [115/30] via 20.1.1.2, po1, 00:00:32
i L1       7.7.7.7/32 [115/40] via 20.1.1.2, po1, 01:05:49
C          20.1.1.0/24 is directly connected, po1, 02:13:21
i L1       50.1.1.0/24 [115/20] via 20.1.1.2, po1, 01:06:05
i L1       60.1.1.0/24 [115/30] via 20.1.1.2, po1, 00:00:47
i L1       80.1.1.0/24 [115/30] via 20.1.1.2, po1, 01:05:49
C          127.0.0.0/8 is directly connected, lo, 02:13:57
```

IP Route Table for VRF "management"

```
C          10.12.98.0/24 is directly connected, eth0, 02:13:57
C          127.0.0.0/8 is directly connected, lo.management, 02:13:57
```

IP Route Table for VRF "L3VRF2"

```
B          3.3.3.3/32 [0/0] is directly connected, tunvxlan2, 00:00:28
C          13.13.13.0/24 is directly connected, irb2001, 02:13:57
```

```

B          14.14.14.0/24 [200/0] via 3.3.3.3 (recursive is directly connected,
  tunvxlan2), 00:00:28
C          127.0.0.0/8 is directly connected, lo.L3VRF2, 02:13:57
IP Route Table for VRF "L2VRF2"

```

Gateway of last resort is not set

PE2# show bgp l2vpn evpn

BGP table version is 2, local router ID is 2.2.2.2

Status codes: s suppressed, d damped, h history, a add-path, * valid, > best, i
- internal,

l - labeled, S Stale

Origin codes: i - IGP, e - EGP, ? - incomplete

[EVPN route type]:[ESI]:[VNID]:[relevent route informantion]

1 - Ethernet Auto-discovery Route

2 - MAC/IP Route

3 - Inclusive Multicast Route

4 - Ethernet Segment Route

5 - Prefix Route

Network	Next Hop	Metric	LocPrf	Weight	Path Peer	Encap
RD[63000:11]						
*>i [5]:[0]:[0]:[24]:[14.14.14.0]:[0.0.0.0]:[2000]	3.3.3.3	0	100	0	? 3.3.3.3	VXLAN
*>i [5]:[0]:[0]:[64]:[3002::]:[::]:[2000]	3.3.3.3	0	100	0	? 3.3.3.3	VXLAN
RD[2.2.2.2:11] VRF[L2VRF2]:						
*> [2]:[0]:[201]:[48,0010:9400:0003]:[0]:[201]	2.2.2.2	0	100	32768	i -----	VXLAN
*> [2]:[0]:[201]:[48,0010:9400:0003]:[32,13.13.13.2]:[201]	2.2.2.2	0	100	32768	i -----	VXLAN
* i [2]:[0]:[201]:[48,0010:9400:0005]:[0]:[201]	3.3.3.3	0	100	0	i 3.3.3.3	VXLAN
* i [2]:[0]:[201]:[48,0010:9400:0005]:[32,14.14.14.2]:[201]	3.3.3.3	0	100	0	i 3.3.3.3	VXLAN
*> [2]:[0]:[201]:[48,e8c5:7a76:581d]:[32,13.13.13.1]:[201]	2.2.2.2	0	100	32768	i -----	VXLAN
* i [2]:[0]:[201]:[48,e8c5:7aa8:7cb3]:[32,14.14.14.1]:[201]	3.3.3.3	0	100	0	i 3.3.3.3	VXLAN
*> [2]:[0]:[3001]:[48,0010:9400:000c]:[0]:[3001]	2.2.2.2	0	100	32768	i -----	VXLAN
*> [2]:[0]:[3001]:[48,0010:9400:000c]:[128,3001::2][3001]	2.2.2.2	0	100	32768	i -----	VXLAN
*> [2]:[0]:[3001]:[48,e8c5:7a76:581d]:[128,3001::1][3001]	2.2.2.2	0	100	32768	i -----	VXLAN
* i [2]:[0]:[3002]:[48,0010:9400:000b]:[0]:[3002]	3.3.3.3	0	100	0	i 3.3.3.3	VXLAN
* i [2]:[0]:[3002]:[48,0010:9400:000b]:[128,3002::2][3002]						

```

          3.3.3.3          0          100          0          i  3.3.3.3          VXLAN
* i  [2]:[0]:[3002]:[48,e8c5:7aa8:7cb3]:[128,3002::1][3002]
          3.3.3.3          0          100          0          i  3.3.3.3          VXLAN
*>  [3]:[201]:[32,2.2.2.2]
          2.2.2.2          0          100          32768        i  -----          VXLAN
* i  [3]:[201]:[32,3.3.3.3]
          3.3.3.3          0          100          0          i  3.3.3.3          VXLAN
*>  [3]:[3001]:[32,2.2.2.2]
          2.2.2.2          0          100          32768        i  -----          VXLAN
* i  [3]:[3002]:[32,3.3.3.3]
          3.3.3.3          0          100          0          i  3.3.3.3          VXLAN

```

RD[3.3.3.3:11]

```

*>i  [2]:[0]:[201]:[48,0010:9400:0005]:[0]:[201]
          3.3.3.3          0          100          0          i  3.3.3.3          VXLAN
*>i  [2]:[0]:[201]:[48,0010:9400:0005]:[32,14.14.14.2]:[201]
          3.3.3.3          0          100          0          i  3.3.3.3          VXLAN
*>i  [2]:[0]:[201]:[48,e8c5:7aa8:7cb3]:[32,14.14.14.1]:[201]
          3.3.3.3          0          100          0          i  3.3.3.3          VXLAN
*>i  [2]:[0]:[3002]:[48,0010:9400:000b]:[0]:[3002]
          3.3.3.3          0          100          0          i  3.3.3.3          VXLAN
*>i  [2]:[0]:[3002]:[48,0010:9400:000b]:[128,3002::2][3002]
          3.3.3.3          0          100          0          i  3.3.3.3          VXLAN
*>i  [2]:[0]:[3002]:[48,e8c5:7aa8:7cb3]:[128,3002::1][3002]
          3.3.3.3          0          100          0          i  3.3.3.3          VXLAN
*>i  [3]:[201]:[32,3.3.3.3]
          3.3.3.3          0          100          0          i  3.3.3.3          VXLAN
*>i  [3]:[3002]:[32,3.3.3.3]
          3.3.3.3          0          100          0          i  3.3.3.3          VXLAN

```

Total number of prefixes 26

```

PE2# show nvo vxlan arp-
arp-cache arp-nd
PE2# show nvo vxlan arp-cache
VXLAN ARP-CACHE Information
=====

```

VNID	Ip-Addr	Mac-Addr	Type	Age-Out	Retries-Left
201	13.13.13.1	e8c5.7a76.581d	Static Local	----	
201	13.13.13.2	0010.9400.0003	Dynamic Local	----	
201	14.14.14.1	e8c5.7aa8.7cb3	Static Remote	----	
201	14.14.14.2	0010.9400.0005	Dynamic Remote	----	

Total number of entries are 4

```

PE2#show evpn irb-status
IRB is ACTIVE in Hardware
PE2#

```

```

PE4#show nvo vxlan tunnel
VXLAN Network tunnel Entries
Source          Destination          Status          Up/Down          Update

```

```

=====
3.3.3.3          7.7.7.7          Installed        00:01:28        00:01:28
3.3.3.3          2.2.2.2          Installed        00:01:28        00:01:28

```

Total number of entries are 2
PE4#show clns neighbors

Total number of L1 adjacencies: 1
Total number of L2 adjacencies: 1
Total number of adjacencies: 2

Tag 1: VRF : default

System Id	Interface	SNPA	State	Holdtime	Type	Protocol
PE6	xe5	00e0.4b71.f12c	Up	25	L1	IS-IS
			Up	25	L2	IS-IS

Total number of L1 adjacencies: 0
Total number of L2 adjacencies: 1
Total number of adjacencies: 1

Tag 2: VRF : L3VRF2

System Id	Interface	SNPA	State	Holdtime	Type	Protocol
Spirent-1	irb2001	0010.9400.0005	Up	28	L2	IS-IS

Total number of L1 adjacencies: 0
Total number of L2 adjacencies: 1
Total number of adjacencies: 1

Tag 3: VRF : L3VRF2

System Id	Interface	SNPA	State	Holdtime	Type	Protocol
Spirent-1	irb3002	0010.9400.000b	Up	28	L2	IS-IS

PE4#show ip route vrf all

Codes: K - kernel, C - connected, S - static, R - RIP, B - BGP
O - OSPF, IA - OSPF inter area
N1 - OSPF NSSA external type 1, N2 - OSPF NSSA external type 2
E1 - OSPF external type 1, E2 - OSPF external type 2
i - IS-IS, L1 - IS-IS level-1, L2 - IS-IS level-2,
ia - IS-IS inter area, E - EVPN,
v - vrf leaked
* - candidate default

IP Route Table for VRF "default"

```

i L2      2.2.2.2/32 [115/30] via 60.1.1.1, xe5, 00:01:46
C         3.3.3.3/32 is directly connected, lo, 02:09:52
i L1      7.7.7.7/32 [115/30] via 60.1.1.1, xe5, 00:01:46
i L1      20.1.1.0/24 [115/30] via 60.1.1.1, xe5, 00:01:46
i L1      50.1.1.0/24 [115/20] via 60.1.1.1, xe5, 00:01:46
C         60.1.1.0/24 is directly connected, xe5, 00:02:02
i L1      80.1.1.0/24 [115/20] via 60.1.1.1, xe5, 00:01:46
C         127.0.0.0/8 is directly connected, lo, 02:09:52

```

IP Route Table for VRF "management"

```

C         10.12.98.0/24 is directly connected, eth0, 02:09:52
C         127.0.0.0/8 is directly connected, lo.management, 02:09:52

```

IP Route Table for VRF "L3VRF2"

```

B          2.2.2.2/32 [0/0] is directly connected, tunvxlan2, 00:01:42
B          7.7.7.7/32 [0/0] is directly connected, tunvxlan2, 00:01:42
B          13.13.13.0/24 [200/0] via 2.2.2.2 (recursive is directly connected,
tunvxlan2), 00:01:42
C          14.14.14.0/24 is directly connected, irb2001, 02:09:52
B          17.17.17.0/24 [200/0] via 7.7.7.7 (recursive is directly connected,
tunvxlan2), 00:01:42
C          127.0.0.0/8 is directly connected, lo.L3VRF2, 02:09:52

```

IP Route Table for VRF "L2VRF2"

Gateway of last resort is not set

PE4# show bgp l2vpn evpn

BGP table version is 3, local router ID is 3.3.3.3

Status codes: s suppressed, d damped, h history, a add-path, * valid, > best, i - internal,

l - labeled, S Stale

Origin codes: i - IGP, e - EGP, ? - incomplete

[EVPN route type]:[ESI]:[VNID]:[relevent route informantion]

- 1 - Ethernet Auto-discovery Route
- 2 - MAC/IP Route
- 3 - Inclusive Multicast Route
- 4 - Ethernet Segment Route
- 5 - Prefix Route

Network	Next Hop	Metric	LocPrf	Weight	Path	Peer	Encap
RD[7400:11]							
*>i [5]:[0]:[0]:[24]:[17.17.17.0]:[0.0.0.0]:[2000]	7.7.7.7	0	100	0	i 7.7.7.7		VXLAN
*>i [5]:[0]:[0]:[64]:[8002::]:[::]:[2000]	7.7.7.7	0	100	0	i 7.7.7.7		VXLAN
RD[61000:11]							
*>i [5]:[0]:[0]:[24]:[13.13.13.0]:[0.0.0.0]:[2000]	2.2.2.2	0	100	0	? 2.2.2.2		VXLAN
*>i [5]:[0]:[0]:[64]:[3001::]:[::]:[2000]	2.2.2.2	0	100	0	? 2.2.2.2		VXLAN
RD[2.2.2.2:11]							
*>i [2]:[0]:[201]:[48,0010:9400:0003]:[0]:[201]	2.2.2.2	0	100	0	i 2.2.2.2		VXLAN
*>i [2]:[0]:[201]:[48,0010:9400:0003]:[32,13.13.13.2]:[201]	2.2.2.2	0	100	0	i 2.2.2.2		VXLAN
*>i [2]:[0]:[201]:[48,e8c5:7a76:581d]:[32,13.13.13.1]:[201]	2.2.2.2	0	100	0	i 2.2.2.2		VXLAN
*>i [2]:[0]:[3001]:[48,0010:9400:000c]:[0]:[3001]	2.2.2.2	0	100	0	i 2.2.2.2		VXLAN
*>i [2]:[0]:[3001]:[48,0010:9400:000c]:[128,3001::2][3001]	2.2.2.2	0	100	0	i 2.2.2.2		VXLAN

```

*>i [2]:[0]:[3001]:[48,e8c5:7a76:581d]:[128,3001::1][3001]
      2.2.2.2          0          100          0    i  2.2.2.2          VXLAN
*>i [3]:[201]:[32,2.2.2.2]
      2.2.2.2          0          100          0    i  2.2.2.2          VXLAN
*>i [3]:[3001]:[32,2.2.2.2]
      2.2.2.2          0          100          0    i  2.2.2.2          VXLAN

RD[3.3.3.3:11] VRF[L2VRF2]:
* i [2]:[0]:[201]:[48,0010:9400:0003]:[0]:[201]
      2.2.2.2          0          100          0    i  2.2.2.2          VXLAN
* i [2]:[0]:[201]:[48,0010:9400:0003]:[32,13.13.13.2]:[201]
      2.2.2.2          0          100          0    i  2.2.2.2          VXLAN
*> [2]:[0]:[201]:[48,0010:9400:0005]:[0]:[201]
      3.3.3.3          0          100          32768  i  -----          VXLAN
*> [2]:[0]:[201]:[48,0010:9400:0005]:[32,14.14.14.2]:[201]
      3.3.3.3          0          100          32768  i  -----
VXLAN
* i [2]:[0]:[201]:[48,e8c5:7a76:581d]:[32,13.13.13.1]:[201]
      2.2.2.2          0          100          0    i  2.2.2.2          VXLAN
*> [2]:[0]:[201]:[48,e8c5:7aa8:7cb3]:[32,14.14.14.1]:[201]
      3.3.3.3          0          100          32768  i  -----
VXLAN
* i [2]:[0]:[3001]:[48,0010:9400:000c]:[0]:[3001]
      2.2.2.2          0          100          0    i  2.2.2.2          VXLAN
* i [2]:[0]:[3001]:[48,0010:9400:000c]:[128,3001::2][3001]
      2.2.2.2          0          100          0    i  2.2.2.2          VXLAN
* i [2]:[0]:[3001]:[48,e8c5:7a76:581d]:[128,3001::1][3001]
      2.2.2.2          0          100          0    i  2.2.2.2          VXLAN
*> [2]:[0]:[3002]:[48,0010:9400:000b]:[0]:[3002]
      3.3.3.3          0          100          32768  i  -----          VXLAN
*> [2]:[0]:[3002]:[48,0010:9400:000b]:[128,3002::2][3002]
      3.3.3.3          0          100          32768  i  -----          VXLAN
*> [2]:[0]:[3002]:[48,e8c5:7aa8:7cb3]:[128,3002::1][3002]
      3.3.3.3          0          100          32768  i  -----          VXLAN
* i [3]:[201]:[32,2.2.2.2]
      2.2.2.2          0          100          0    i  2.2.2.2          VXLAN
*> [3]:[201]:[32,3.3.3.3]
      3.3.3.3          0          100          32768  i  -----          VXLAN
* i [3]:[3001]:[32,2.2.2.2]
      2.2.2.2          0          100          0    i  2.2.2.2          VXLAN
*> [3]:[3002]:[32,3.3.3.3]
      3.3.3.3          0          100          32768  i  -----          VXLAN

```

Total number of prefixes 28

ISIS Validation

PE2#show nvo vxlan tunnel

VXLAN Network tunnel Entries

Source	Destination	Status	Up/Down	Update
2.2.2.2	3.3.3.3	Installed	00:00:10	00:00:10

```

Total number of entries are 1
PE2#show clns neighbors
Total number of L1 adjacencies: 1
Total number of L2 adjacencies: 1
Total number of adjacencies: 2
Tag 1: VRF : default
System Id      Interface  SNPA          State  Holdtime  Type Protocol
PE5            po1       b86a.9725.a7f2 Up     28        L1   IS-IS
              po1       b86a.9725.a7f2 Up     28        L2   IS-IS

Total number of L1 adjacencies: 0
Total number of L2 adjacencies: 1
Total number of adjacencies: 1
Tag 2: VRF : L3VRF2
System Id      Interface  SNPA          State  Holdtime  Type Protocol
Spirent-1     irb2001   0010.9400.0003 Up     28        L2   IS-IS

Total number of L1 adjacencies: 0
Total number of L2 adjacencies: 1
Total number of adjacencies: 1
Tag 3: VRF : L3VRF2
System Id      Interface  SNPA          State  Holdtime  Type Protocol
Spirent-1     irb3001   0010.9400.000c Up     28        L2   IS-IS
PE2#
PE2#
PE2#show ip route vrf all
Codes: K - kernel, C - connected, S - static, R - RIP, B - BGP
       O - OSPF, IA - OSPF inter area
       N1 - OSPF NSSA external type 1, N2 - OSPF NSSA external type 2
       E1 - OSPF external type 1, E2 - OSPF external type 2
       i - IS-IS, L1 - IS-IS level-1, L2 - IS-IS level-2,
       ia - IS-IS inter area, E - EVPN,
       v - vrf leaked
       * - candidate default

IP Route Table for VRF "default"
C          2.2.2.2/32 is directly connected, lo, 02:13:57
i L2      3.3.3.3/32 [115/30] via 20.1.1.2, po1, 00:00:32
i L1      7.7.7.7/32 [115/40] via 20.1.1.2, po1, 01:05:49
C          20.1.1.0/24 is directly connected, po1, 02:13:21
i L1      50.1.1.0/24 [115/20] via 20.1.1.2, po1, 01:06:05
i L1      60.1.1.0/24 [115/30] via 20.1.1.2, po1, 00:00:47
i L1      80.1.1.0/24 [115/30] via 20.1.1.2, po1, 01:05:49
C          127.0.0.0/8 is directly connected, lo, 02:13:57
IP Route Table for VRF "management"
C          10.12.98.0/24 is directly connected, eth0, 02:13:57
C          127.0.0.0/8 is directly connected, lo.management, 02:13:57
IP Route Table for VRF "L3VRF2"
B          3.3.3.3/32 [0/0] is directly connected, tunvxlan2, 00:00:28
C          13.13.13.0/24 is directly connected, irb2001, 02:13:57

```

```

B          14.14.14.0/24 [200/0] via 3.3.3.3 (recursive is directly connected,
  tunvxlan2), 00:00:28
C          127.0.0.0/8 is directly connected, lo.L3VRF2, 02:13:57
IP Route Table for VRF "L2VRF2"

```

Gateway of last resort is not set

PE2# show bgp l2vpn evpn

BGP table version is 2, local router ID is 2.2.2.2

Status codes: s suppressed, d damped, h history, a add-path, * valid, > best, i
- internal,

l - labeled, S Stale

Origin codes: i - IGP, e - EGP, ? - incomplete

[EVPN route type]:[ESI]:[VNID]:[relevent route informantion]

1 - Ethernet Auto-discovery Route

2 - MAC/IP Route

3 - Inclusive Multicast Route

4 - Ethernet Segment Route

5 - Prefix Route

Network	Next Hop	Metric	LocPrf	Weight	Path
Peer	Encap				
RD[63000:11]					
*>i	[5]:[0]:[0]:[24]:[14.14.14.0]:[0.0.0.0]:[2000]				
	3.3.3.3	0	100	0 ?	3.3.3.3 VXLAN
*>i	[5]:[0]:[0]:[64]:[3002::]:[::]:[2000]				
	3.3.3.3	0	100	0 ?	3.3.3.3 VXLAN
RD[2.2.2.2:11] VRF[L2VRF2]:					
*>	[2]:[0]:[201]:[48,0010:9400:0003]:[0]:[201]				
	2.2.2.2	0	100	32768 i	----- VXLAN
*>	[2]:[0]:[201]:[48,0010:9400:0003]:[32,13.13.13.2]:[201]				
	2.2.2.2	0	100	32768 i	----- VXLAN
* i	[2]:[0]:[201]:[48,0010:9400:0005]:[0]:[201]				
	3.3.3.3	0	100	0 i	3.3.3.3 VXLAN
* i	[2]:[0]:[201]:[48,0010:9400:0005]:[32,14.14.14.2]:[201]				
	3.3.3.3	0	100	0 i	3.3.3.3 VXLAN
*>	[2]:[0]:[201]:[48,e8c5:7a76:581d]:[32,13.13.13.1]:[201]				
	2.2.2.2	0	100	32768 i	----- VXLAN
* i	[2]:[0]:[201]:[48,e8c5:7aa8:7cb3]:[32,14.14.14.1]:[201]				
	3.3.3.3	0	100	0 i	3.3.3.3 VXLAN
*>	[2]:[0]:[3001]:[48,0010:9400:000c]:[0]:[3001]				
	2.2.2.2	0	100	32768 i	----- VXLAN
*>	[2]:[0]:[3001]:[48,0010:9400:000c]:[128,3001::2][3001]				
	2.2.2.2	0	100	32768 i	----- VXLAN
*>	[2]:[0]:[3001]:[48,e8c5:7a76:581d]:[128,3001::1][3001]				
	2.2.2.2	0	100	32768 i	----- VXLAN
* i	[2]:[0]:[3002]:[48,0010:9400:000b]:[0]:[3002]				
	3.3.3.3	0	100	0 i	3.3.3.3 VXLAN
* i	[2]:[0]:[3002]:[48,0010:9400:000b]:[128,3002::2][3002]				

```

          3.3.3.3          0          100          0          i  3.3.3.3          VXLAN
* i  [2]:[0]:[3002]:[48,e8c5:7aa8:7cb3]:[128,3002::1][3002]
          3.3.3.3          0          100          0          i  3.3.3.3          VXLAN
*>  [3]:[201]:[32,2.2.2.2]
          2.2.2.2          0          100          32768        i  -----          VXLAN
* i  [3]:[201]:[32,3.3.3.3]
          3.3.3.3          0          100          0          i  3.3.3.3          VXLAN
*>  [3]:[3001]:[32,2.2.2.2]
          2.2.2.2          0          100          32768        i  -----          VXLAN
* i  [3]:[3002]:[32,3.3.3.3]
          3.3.3.3          0          100          0          i  3.3.3.3          VXLAN

```

RD[3.3.3.3:11]

```

*>i  [2]:[0]:[201]:[48,0010:9400:0005]:[0]:[201]
          3.3.3.3          0          100          0          i  3.3.3.3          VXLAN
*>i  [2]:[0]:[201]:[48,0010:9400:0005]:[32,14.14.14.2]:[201]
          3.3.3.3          0          100          0          i  3.3.3.3          VXLAN
*>i  [2]:[0]:[201]:[48,e8c5:7aa8:7cb3]:[32,14.14.14.1]:[201]
          3.3.3.3          0          100          0          i  3.3.3.3          VXLAN
*>i  [2]:[0]:[3002]:[48,0010:9400:000b]:[0]:[3002]
          3.3.3.3          0          100          0          i  3.3.3.3          VXLAN
*>i  [2]:[0]:[3002]:[48,0010:9400:000b]:[128,3002::2][3002]
          3.3.3.3          0          100          0          i  3.3.3.3          VXLAN
*>i  [2]:[0]:[3002]:[48,e8c5:7aa8:7cb3]:[128,3002::1][3002]
          3.3.3.3          0          100          0          i  3.3.3.3          VXLAN
*>i  [3]:[201]:[32,3.3.3.3]
          3.3.3.3          0          100          0          i  3.3.3.3          VXLAN
*>i  [3]:[3002]:[32,3.3.3.3]
          3.3.3.3          0          100          0          i  3.3.3.3          VXLAN

```

Total number of prefixes 26

```

PE2#          show nvo vxlan arp-
arp-cache arp-nd
PE2#          show nvo vxlan arp-cache
VXLAN ARP-CACHE Information
=====

```

VNID	Ip-Addr	Mac-Addr	Type	Age-Out	Retries-Left
201	13.13.13.1	e8c5.7a76.581d	Static Local	----	
201	13.13.13.2	0010.9400.0003	Dynamic Local	----	
201	14.14.14.1	e8c5.7aa8.7cb3	Static Remote	----	
201	14.14.14.2	0010.9400.0005	Dynamic Remote	----	

Total number of entries are 4

```

PE2#show evpn irb-status
IRB is ACTIVE in Hardware
PE2#

```

```

PE4#show nvo vxlan tunnel
VXLAN Network tunnel Entries
Source          Destination          Status          Up/Down          Update

```

```
=====
3.3.3.3          7.7.7.7          Installed      00:01:28      00:01:28
3.3.3.3          2.2.2.2          Installed      00:01:28      00:01:28
```

Total number of entries are 2
PE4#show clns neighbors

Total number of L1 adjacencies: 1
Total number of L2 adjacencies: 1
Total number of adjacencies: 2

Tag 1: VRF : default

System Id	Interface	SNPA	State	Holdtime	Type	Protocol
PE6	xe5	00e0.4b71.f12c	Up	25	L1	IS-IS
			Up	25	L2	IS-IS

Total number of L1 adjacencies: 0
Total number of L2 adjacencies: 1
Total number of adjacencies: 1

Tag 2: VRF : L3VRF2

System Id	Interface	SNPA	State	Holdtime	Type	Protocol
Spirent-1	irb2001	0010.9400.0005	Up	28	L2	IS-IS

Total number of L1 adjacencies: 0
Total number of L2 adjacencies: 1
Total number of adjacencies: 1

Tag 3: VRF : L3VRF2

System Id	Interface	SNPA	State	Holdtime	Type	Protocol
Spirent-1	irb3002	0010.9400.000b	Up	28	L2	IS-IS

PE4#show ip route vrf all

Codes: K - kernel, C - connected, S - static, R - RIP, B - BGP
O - OSPF, IA - OSPF inter area
N1 - OSPF NSSA external type 1, N2 - OSPF NSSA external type 2
E1 - OSPF external type 1, E2 - OSPF external type 2
i - IS-IS, L1 - IS-IS level-1, L2 - IS-IS level-2,
ia - IS-IS inter area, E - EVPN,
v - vrf leaked
* - candidate default

IP Route Table for VRF "default"

```
i L2      2.2.2.2/32 [115/30] via 60.1.1.1, xe5, 00:01:46
C         3.3.3.3/32 is directly connected, lo, 02:09:52
i L1      7.7.7.7/32 [115/30] via 60.1.1.1, xe5, 00:01:46
i L1      20.1.1.0/24 [115/30] via 60.1.1.1, xe5, 00:01:46
i L1      50.1.1.0/24 [115/20] via 60.1.1.1, xe5, 00:01:46
C         60.1.1.0/24 is directly connected, xe5, 00:02:02
i L1      80.1.1.0/24 [115/20] via 60.1.1.1, xe5, 00:01:46
C         127.0.0.0/8 is directly connected, lo, 02:09:52
```

IP Route Table for VRF "management"

```
C         10.12.98.0/24 is directly connected, eth0, 02:09:52
C         127.0.0.0/8 is directly connected, lo.management, 02:09:52
```

IP Route Table for VRF "L3VRF2"

```

B          2.2.2.2/32 [0/0] is directly connected, tunvxlan2, 00:01:42
B          7.7.7.7/32 [0/0] is directly connected, tunvxlan2, 00:01:42
B          13.13.13.0/24 [200/0] via 2.2.2.2 (recursive is directly connected,
tunvxlan2), 00:01:42
C          14.14.14.0/24 is directly connected, irb2001, 02:09:52
B          17.17.17.0/24 [200/0] via 7.7.7.7 (recursive is directly connected,
tunvxlan2), 00:01:42
C          127.0.0.0/8 is directly connected, lo.L3VRF2, 02:09:52

```

IP Route Table for VRF "L2VRF2"

Gateway of last resort is not set

PE4# show bgp l2vpn evpn

BGP table version is 3, local router ID is 3.3.3.3

Status codes: s suppressed, d damped, h history, a add-path, * valid, > best, i - internal,

l - labeled, S Stale

Origin codes: i - IGP, e - EGP, ? - incomplete

[EVPN route type]:[ESI]:[VNID]:[relevent route informantion]

```

1 - Ethernet Auto-discovery Route
2 - MAC/IP Route
3 - Inclusive Multicast Route
4 - Ethernet Segment Route
5 - Prefix Route

```

Network	Next Hop	Metric	LocPrf	Weight	Path	Peer
Encap						
RD[7400:11]						
*>i [5]:[0]:[0]:[24]:[17.17.17.0]:[0.0.0.0]:[2000]	7.7.7.7	0	100	0	i 7.7.7.7	VXLAN
*>i [5]:[0]:[0]:[64]:[8002::]:[::]:[2000]	7.7.7.7	0	100	0	i 7.7.7.7	VXLAN
RD[61000:11]						
*>i [5]:[0]:[0]:[24]:[13.13.13.0]:[0.0.0.0]:[2000]	2.2.2.2	0	100	0	? 2.2.2.2	VXLAN
*>i [5]:[0]:[0]:[64]:[3001::]:[::]:[2000]	2.2.2.2	0	100	0	? 2.2.2.2	VXLAN
RD[2.2.2.2:11]						
*>i [2]:[0]:[201]:[48,0010:9400:0003]:[0]:[201]	2.2.2.2	0	100	0	i 2.2.2.2	VXLAN
*>i [2]:[0]:[201]:[48,0010:9400:0003]:[32,13.13.13.2]:[201]	2.2.2.2	0	100	0	i 2.2.2.2	VXLAN
*>i [2]:[0]:[201]:[48,e8c5:7a76:581d]:[32,13.13.13.1]:[201]	2.2.2.2	0	100	0	i 2.2.2.2	VXLAN
*>i [2]:[0]:[3001]:[48,0010:9400:000c]:[0]:[3001]	2.2.2.2	0	100	0	i 2.2.2.2	VXLAN
*>i [2]:[0]:[3001]:[48,0010:9400:000c]:[128,3001::2][3001]						

```

                2.2.2.2          0          100          0          i  2.2.2.2          VXLAN
*>i  [2]:[0]:[3001]:[48,e8c5:7a76:581d]:[128,3001::1][3001]
                2.2.2.2          0          100          0          i  2.2.2.2          VXLAN
*>i  [3]:[201]:[32,2.2.2.2]
                2.2.2.2          0          100          0          i  2.2.2.2          VXLAN
*>i  [3]:[3001]:[32,2.2.2.2]
                2.2.2.2          0          100          0          i  2.2.2.2          VXLAN

RD[3.3.3.3:11] VRF[L2VRF2]:
* i  [2]:[0]:[201]:[48,0010:9400:0003]:[0]:[201]
                2.2.2.2          0          100          0          i  2.2.2.2          VXLAN
* i  [2]:[0]:[201]:[48,0010:9400:0003]:[32,13.13.13.2]:[201]
                2.2.2.2          0          100          0          i  2.2.2.2          VXLAN
*>  [2]:[0]:[201]:[48,0010:9400:0005]:[0]:[201]
                3.3.3.3          0          100          32768        i  -----          VXLAN
*>  [2]:[0]:[201]:[48,0010:9400:0005]:[32,14.14.14.2]:[201]
                3.3.3.3          0          100          32768        i  -----          VXLAN
* i  [2]:[0]:[201]:[48,e8c5:7a76:581d]:[32,13.13.13.1]:[201]
                2.2.2.2          0          100          0          i  2.2.2.2          VXLAN
*>  [2]:[0]:[201]:[48,e8c5:7aa8:7cb3]:[32,14.14.14.1]:[201]
                3.3.3.3          0          100          32768        i  -----          VXLAN
* i  [2]:[0]:[3001]:[48,0010:9400:000c]:[0]:[3001]
                2.2.2.2          0          100          0          i  2.2.2.2          VXLAN
* i  [2]:[0]:[3001]:[48,0010:9400:000c]:[128,3001::2][3001]
                2.2.2.2          0          100          0          i  2.2.2.2          VXLAN
* i  [2]:[0]:[3001]:[48,e8c5:7a76:581d]:[128,3001::1][3001]
                2.2.2.2          0          100          0          i  2.2.2.2          VXLAN
*>  [2]:[0]:[3002]:[48,0010:9400:000b]:[0]:[3002]
                3.3.3.3          0          100          32768        i  -----          VXLAN
*>  [2]:[0]:[3002]:[48,0010:9400:000b]:[128,3002::2][3002]
                3.3.3.3          0          100          32768        i  -----          VXLAN
*>  [2]:[0]:[3002]:[48,e8c5:7aa8:7cb3]:[128,3002::1][3002]
                3.3.3.3          0          100          32768        i  -----          VXLAN
* i  [3]:[201]:[32,2.2.2.2]
                2.2.2.2          0          100          0          i  2.2.2.2          VXLAN
*>  [3]:[201]:[32,3.3.3.3]
                3.3.3.3          0          100          32768        i  -----          VXLAN
* i  [3]:[3001]:[32,2.2.2.2]
                2.2.2.2          0          100          0          i  2.2.2.2          VXLAN
*>  [3]:[3002]:[32,3.3.3.3]
                3.3.3.3          0          100          32768        i  -----          VXLAN

```

Total number of prefixes 28

Abbreviations

The following are some key abbreviations and their meanings relevant to this document:

Acronym	Description
ECMP	Equal-Cost Multipath
EVPN	Ethernet Virtual Private Network
MPLS	Multiprotocol Label Switching
VxLAN	Virtual Extensible LAN
SR	Segment Routing
IRB	Integrated Routing
OSPF	Open Shortest Path First
ISIS	Intermediate System to Intermediate System

Glossary

The following provides definitions for key terms used throughout this document.

Single Home VxLAN	This refers to a Virtual Extensible LAN (VxLAN) deployment where a single data center or network site is connected to a single external network (usually the internet) for connectivity.
IRB	A networking feature that enables the integration of Layer 3 IP routing and Layer 2 MAC address bridging within the same interface, simplifying network management and resource utilization.
OSPF	A dynamic and efficient link-state routing protocol used to determine the best path for data packets in an IP network. It is characterized by rapid convergence and adaptability, making it suitable for large and dynamic networks.
ISIS	A routing protocol designed for scalability and stability in computer networks, commonly used in large Service Provider networks. It provides a robust framework for routing information exchange.
Layer 3 Routing	Network routing operations at the Network Layer (Layer 3) of the OSI model, focusing on routing IP packets between different subnets or networks.
Layer 2 Bridging	Network bridging operations at the Data Link Layer (Layer 2) of the OSI model, handling the forwarding of data frames based on MAC addresses within the same network segment.
EVPN	Ethernet VPN, a technology that provides advanced and efficient methods for Layer 2 and Layer 3 services in Ethernet networks, often used in data centers and service provider environments.

CHAPTER 18 Single-Home for VxLAN EVPN IRB with OSPF or ISIS

Overview

Single Home EVPN-MPLS IRB with OSPF and ISIS feature provides streamline routing and bridging operations within Service Provider (SP) networks. It seamlessly integrates EVPN-MPLS architecture and handles both Layer 3 routing and Layer2 bridging, making it an ideal choice for SP networks. This feature utilizes routing protocols, OSPF and ISIS, known for their efficiency and reliability. It also supports Integrated Routing and Bridging (IRB), enabling the integration of Layer3 IP routing and Layer2 MAC address bridging within the same interface. It simplifies network operations, enhances efficiency, and ensures network reliability for SP in dynamic environments.

Feature Characteristics

The Single Home EVPN-MPLS IRB with OSPF and ISIS feature has the following characteristics:

- Integrates with the EVPN-MPLS architecture, providing a comprehensive solution for Layer 3 routing and Layer 2 bridging within the network.
- Supports IRB, allowing for the integration of Layer 3 routing and Layer 2 bridging within the same interface.

Benefits

The Single Home EVPN-MPLS IRB with OSPF and ISIS feature has the following benefits:

- With OSPF and ISIS support, the network can effortlessly scale to accommodate increased traffic and new network elements.
- The use of robust routing protocols like OSPF and ISIS ensures reliable and fault-tolerant network communication, minimizing downtime and enhancing network stability.
- The integration of multiple functionalities into a single feature simplifies network management, reducing operational complexity and lowering the risk of configuration errors.

Prerequisites

- Router must be up and running.

Topology for OSPF

The network topology includes various network elements such as routers, customer edge (CE) devices, and Provider Edge (PE) routers. The feature enables OSPF on the IRB interfaces, allowing for efficient routing and communication between network devices within the topology.

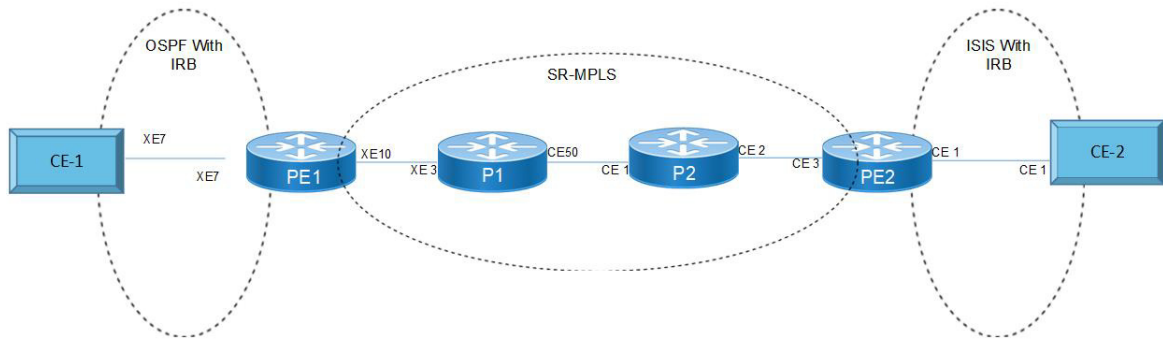

Single Home EVPN MPLS IRB with OSPF and ISIS

Configuration

Perform the following configurations to set up interfaces, assign IP addresses, configure VLAN encapsulation, establish OSPF routing, and prepare the network for routing and forwarding operations. Please ensure that the subnet mask values are accurate and suitable for your network requirements.

CE1

CE1#configure terminal	Enters the configuration mode on the OcNOS device.
CE1(config)#interface po1	Enters the configuration mode for a Port-Channel interface named po1.
CE1(config-if)# load-interval 30	Sets the load interval for the Port-Channel interface to 30 seconds.
CE1(config-if)#interface po1.101	Enters the configuration mode for a subinterface of Port-Channel 1, specifically subinterface 101.
CE1(config-if)# encapsulation dot1q 101	Configures the subinterface to use IEEE 802.1Q encapsulation with VLAN ID 101.
CE1(config-if)# ip address 101.101.101.2/24	Assigns the IP address 101.101.101.2 with a subnet mask of /24 to the subinterface.
CE1(config-if)#interface po1.1001	Enters the configuration mode for another subinterface of Port-Channel 1, specifically subinterface 1001.
CE1(config-if)# encapsulation dot1q 1001	Configures the subinterface with IEEE 802.1Q encapsulation using VLAN ID 1001.
CE1(config-if)# ipv6 address 1001::2/64	Assigns an IPv6 address 1001::2 with a subnet prefix length of /64 to the subinterface.
CE1(config-if)# ipv6 router ospf area 0.0.0.0 tag 1001 instance-id 0	Configures OSPF for IPv6 on the subinterface, specifying area 0.0.0.0 with a tag of 1001 and instance ID 0.

CE1(config-if)# ip address 99.99.99.1/243	Assigns the IP address 99.99.99.1 with a subnet mask of /243 to the Gigabit Ethernet interface. Note: The subnet mask value seems to be incorrect; it should typically be in the format /24.
CE1(config-if)#interface lo	Enters the configuration mode for a loopback interface.
CE1(config-if)# ip address 127.0.0.1/8	Assigns the primary IP address 127.0.0.1 with a subnet mask of /8 to the loopback interface.
CE1(config-if)# ip address 1.1.1.1/32 secondary	Adds a secondary IP address, 1.1.1.1 with a /32 subnet mask, to the loopback interface.
CE1(config-if)# ipv6 address ::1/128	Assigns the IPv6 address ::1 with a subnet prefix length of /128 to the loopback interface.
CE1(config-if)#interface xe7	Enters the configuration mode for Ten Gigabit Ethernet interface 7.
CE1(config-if)# channel-group 1 mode active	Configures the interface to be part of an EtherChannel group with group number 1 and sets the mode to active.
CE1(config-if)#exit	Exits the interface configuration mode.
CE1(config)#router ospf 101	Enters the configuration mode for OSPF (routing process 101).
CE1(config-router)# ospf router-id 1.1.1.1	Sets the OSPF router ID to 1.1.1.1.
CE1(config-router)# redistribute connected	Configures OSPF to redistribute connected routes into the OSPF routing process.
CE1(config-router)# network 101.101.101.0/24 area 0.0.0.0	Specifies that the network 101.101.101.0/24 is part of OSPF Area 0.0.0.0.
CE1(config-router)#router ipv6 ospf 1001	Enters the configuration mode for OSPFv3 (OSPF for IPv6) routing process 1001.
CE1(config-router)# router-id 1.1.1.1	Sets the OSPFv3 router ID to 1.1.1.1.
CE1(config-router)#Exit	Exists from the configurations.

Configure MTU over IRB

CE1(config)#int po1	Enters interface configuration mode for port-channel 1 (po1).
CE1(config-if)#mtu 9216	Sets the Maximum Transmission Unit (MTU) for the interface po1 to 9216 bytes, which is a jumbo frame MTU size.
CE1(config-if)#commit	Commit the changes made to the interface configuration.
CE1((config-if)#int po1.101	Enters interface configuration mode for subinterface po1.101.
CE1(config-if)#mtu 9216	Sets the MTU to 9216 bytes.
CE1(config-if)#int po1.1001	Enters interface configuration mode for subinterface po1.1001.
CE1(config-if)#mtu 9216	Sets the MTU to 9216 bytes.
CE1(config-if)#Exit	Exits the interface configuration mode.

PE1

PE1#configure terminal	Enters the global configuration mode.
PE1(config)#evpn mpls enable	Enables EVPN-MPLS within the configuration.
PE1(config)#evpn mpls irb	Configures EVPN-MPLS IRB.
PE1(config)#mac vrf MacVrf1	Creates a MAC VRF named MacVrf1.

PE1(config-vrf)# rd 2.2.2.2:100	Defines a RD for MacVrf1 as 2.2.2.2:100.
PE1(config-vrf)# route-target both 100:1	Sets the route target for MacVrf1 to 100:1 for both import and export.
PE1(config-vrf)#ip vrf IpVrf1	Creates an IP VRF named IpVrf1.
PE1(config-vrf)# rd 2.2.2.2:200	Defines an RD for IpVrf1 as 2.2.2.2:200.
PE1(config-vrf)# route-target both 100:100	Sets the route target for IpVrf1 to 100:100 for both import and export.
PE1(config-vrf)# l3vni 100	Configures Layer 3 Virtual Network Identifier (L3VNI) as 100 for IpVrf1.
PE1(config-vrf)#evpn mpls vtep-ip-global 2.2.2.2	Configures the EVPN-MPLS Virtual Tunnel EndPoint (VTEP) IP address as 2.2.2.2.
PE1(config)#evpn mpls id 101	Defines EVPN-MPLS ID as 101.
PE1(config-evpn-mpls)# host-reachability-protocol evpn-bgp MacVrf1	Specifies BGP as the host reachability protocol for MacVrf1.
PE1(config-evpn-mpls)# evpn irb irb101	Associates IRB 101 with EVPN-MPLS.
PE1(config-evpn-mpls)#evpn mpls id 1001	Defines EVPN-MPLS ID as 1001.
PE1(config-evpn-mpls)# host-reachability-protocol evpn-bgp MacVrf1	Specifies BGP as the host reachability protocol for MacVrf1.
PE1(config-evpn-mpls)# evpn irb irb1001	Associates IRB 1001 with EVPN-MPLS.
PE1(config-evpn-mpls)#qos enable	Enables QoS features.
PE1(config)#qos statistics	Configures QoS statistics collection.
PE1(config)#hostname PE1	Sets the hostname of the device to PE1.
PE1(config)#segment-routing	Enters the configuration mode for segment routing.
PE1(config-sr)# mpls sr-prefer	Configures MPLS as the preferred segment routing method.
PE1(config-sr)#exit	Exits the segment routing configuration mode.
PE1(config)#interface po1	Enters the configuration mode for Port-Channel 1.
PE1(config-if)# switchport	Configures the interface as a switchport.
PE1(config-if)# load-interval 30	Sets the load interval to 30 seconds for the interface.
PE1(config-if)#interface po1.101 switchport	Enters the configuration mode for subinterface 101 of Port-Channel 1 and configures it as a switchport.
PE1(config-if)# encapsulation dot1q 101	Configures IEEE 802.1Q encapsulation with VLAN ID 101 for the subinterface.
PE1(config-if)# rewrite pop	Configures packet rewriting for the subinterface.
PE1(config-if)# access-if-evpn	Specifies that this interface is associated with EVPN.
PE1(config-acc-if-evpn)# map vpn-id 101	Maps this interface to VPN ID 101.
PE1(config-acc-if-evpn)#interface po1.1001 switchport	Enters the configuration mode for subinterface 1001 of Port-Channel 1 and configures it as a switchport.
PE1(config-if)# encapsulation dot1q 1001	Configures IEEE 802.1Q encapsulation with VLAN ID 1001 for the subinterface.
PE1(config-if)# rewrite pop	Configures packet rewriting for the subinterface.
PE1(config-if)# access-if-evpn	Specifies that this interface is associated with E
PE1(config-acc-if-evpn)# map vpn-id 1001	Maps this interface to VPN ID 1001.
PE1(config-acc-if-evpn)#exit	Exits the access-if-evpn configuration mode.
PE1(config-if)#interface irb101	Enters the configuration mode for IRB interface 101.

PE1(config-irb-if)# ip vrf forwarding IpVrf1	Associates the IRB interface with the IP VRF IpVrf1.
PE1(config-irb-if)# ip address 101.101.101.1/24	Configures the IP address 101.101.101.1 with a subnet mask of /24 on the IRB interface.
PE1(config-irb-if)#interface irb1001	Enters the configuration mode for IRB interface 1001.
PE1(config-irb-if)# ip vrf forwarding IpVrf1	Associates the IRB interface with the IP VRF IpVrf1.
PE1(config-irb-if)# ipv6 address 1001::1/64	Configures an IPv6 address 1001::1 with a subnet prefix length of /64 on the IRB interface.
PE1(config-irb-if)# ipv6 router ospf area 0.0.0.0 tag IpVrf1 instance-id 0	Configures OSPF for IPv6 on the IRB interface, specifying area 0.0.0.0 with a tag and instance ID.
PE1(config-irb-if)#interface lo	Enters the configuration mode for loopback interface.
PE1(config-if)# ip address 127.0.0.1/8	Configures the primary IP address of the loopback interface as 127.0.0.1 with a subnet mask of /8.
PE1(config-if)# ip address 2.2.2.2/32 secondary	Adds a secondary IP address 2.2.2.2 with a /32 subnet mask to the loopback interface.
PE1(config-if)# ipv6 address ::1/128	Configures an IPv6 address ::1 with a subnet prefix length of /128 on the loopback interface.
PE1(config-if)# prefix-sid index 2	Configures a prefix SID with an index of 2.
PE1(config-if)#interface xe7	Enters the configuration mode for Ten Gigabit Ethernet interface 7.
PE1(config-if)# channel-group 1 mode active	Configures the interface to be part of an EtherChannel group with group number 1 and sets the mode to active.
PE1(config-if)#interface xe10	Enters the configuration mode for Ten Gigabit Ethernet interface 10.
PE1(config-if)# speed 10g	Sets the speed of the interface to 10 gigabits per second.
PE1(config-if)# ip address 10.1.1.1/24	Configures an IP address 10.1.1.1 with a subnet mask of /24 on the interface.
PE1(config-if)# label-switching	Enables label switching on the interface.
PE1(config-if)# exit	Exits the interface configuration mode.
PE1(config)#router ospf 100	Enters the configuration mode for OSPF routing process 100.
PE1(config-router)# ospf router-id 2.2.2.2	Sets the OSPF router ID to 2.2.2.2.
PE1(config-router)# network 2.2.2.2/32 area 0.0.0.0	Configures the network 2.2.2.2/32 within OSPF Area 0.0.0.0.
PE1(config-router)# network 10.1.1.0/24 area 0.0.0.0	Configures the network 10.1.1.0/24 within OSPF Area 0.0.0.0.
PE1(config-router)# segment-routing mpls	Configures MPLS for segment routing.
PE1(config-router)#router ospf 101 IpVrf1	Enters the configuration mode for OSPF routing process 101 within VRF IpVrf.
PE1(config-router)# network 10.1.1.0/24 area 0.0.0.0	Specifies the network 10.1.1.0 with a /24 subnet mask to be included in OSPF Area 0.0.0.0.
PE1(config-router)# segment-routing mpls	Enables MPLS-based segment routing in the OSPF configuration.
PE1(config-router)#router ospf 101 IpVrf1	Enters the configuration mode for OSPF routing process 101 associated with VRF IpVrf1.
PE1(config-router)# ospf router-id 2.2.2.2	Sets the OSPF router ID to 2.2.2.2.
PE1(config-router)# redistribute bgp	Configures the redistribution of BGP routes into OSPF.
PE1(config-router)# network 101.101.101.0/24 area 0.0.0.0	Specifies the network 101.101.101.0 with a /24 subnet mask to be included in OSPF Area 0.0.0.0 for VRF IpVrf1.

PE1(config-router)#router ipv6 vrf ospf IpVrf1	Enters the configuration mode for OSPFv3 (OSPF for IPv6) routing process associated with VRF IpVrf1.
PE1(config-router)# router-id 2.2.2.2	Sets the OSPFv3 router ID to 2.2.2.2.
PE1(config-router)#router bgp 100	Enters the configuration mode for BGP routing process 100.
PE1(config-router)# bgp router-id 2.2.2.2	Sets the BGP router ID to 2.2.2.2.
PE1(config-router)# neighbor 5.5.5.5 remote-as 100	Specifies a BGP neighbor with IP address 5.5.5.5 and assigns it the remote autonomous system number 100.
PE1(config-router)# neighbor 5.5.5.5 update-source lo	Sets the loopback interface as the source for BGP updates to the neighbor.
PE1(config-router)# neighbor 5.5.5.5 advertisement-interval 0	Configures the BGP neighbor's advertisement interval to 0.
PE1(config-router)# address-family l2vpn evpn	Enters the configuration mode for the BGP address family l2vpn evpn.
PE1(config-router-af)# neighbor 5.5.5.5 activate	Activates the BGP neighbor within the l2vpn evpn address family.
PE1(config-router-af)# exit-address-family	Exits the l2vpn evpn address family configuration.
PE1(config-router)# address-family ipv4 vrf IpVrf1	Enters the configuration mode for the BGP address family ipv4 vrf IpVrf1.
PE1(config-router-af)# redistribute ospf 101	Configures the redistribution of OSPF routes from OSPF process 101 into the ipv4 vrf IpVrf1 address family.
PE1(config-router-af)# exit-address-family	Exits the ipv4 vrf IpVrf1 address family configuration.
PE1(config-router)# address-family ipv6 vrf IpVrf1	Enters the configuration mode for the BGP address family ipv6 vrf IpVrf1.
PE1(config-router-af)# redistribute ospf	Configures the redistribution of OSPFv3 routes into the ipv6 vrf IpVrf1 address family.
PE1(config-router-af)# exit-address-family	Exits the ipv6 vrf IpVrf1 address family configuration.
PE1(config-router)#line console 0	Enters the configuration mode for the console line.
PE1(config-line)# exec-timeout 0 0	Sets the console line's execution timeout values to 0 seconds.
PE1(config-line)#line vty 0 871	Enters the configuration mode for virtual terminal lines 0 to 871.
PE1(config-line)# exec-timeout 0 0	Sets the execution timeout values for virtual terminal lines to 0 seconds.
PE1(config-line)# privilege level 16	Specifies the privilege level for users accessing the virtual terminal lines.
PE1(config-line)#commit	Commits the configuration changes.
PE1(config-line)#end	Exits the configuration mode.

Configure MTU over IRB

PE1(config)#interface irb101	Enters interface configuration mode for IRB interface 101.
PE1(config-irb-if)#mtu 9216	Sets the MTU to 9216 bytes.
PE1(config-irb-if)#commit	Commit the changes made to the interface configuration.
PE1(config-irb-if)#exit	Exits the IRB interface configuration mode and returns to the global configuration mode.
PE1(config)#interface irb1001	Enters interface configuration mode for IRB interface 1001.
PE1(config-irb-if)#mtu 9216	Sets the MTU to 9216 bytes.
PE1(config-irb-if)#commit	Commit the changes made to the interface configuration.

PE1(config-irb-if)#exit	Exits the IRB interface configuration mode and returns to the global configuration mode.
PE1(config)#interface int po1	Enters interface configuration mode for IRB int po1.
PE1(config-irb-if)#mtu 9216	Sets the MTU to 9216 bytes.
PE1(config-irb-if)#commit	Commit the changes made to the interface configuration.
PE1(config-irb-if)#exit	Exits the IRB interface configuration mode and returns to the global configuration mode.

P1

P1#configure terminal	Enters the global configuration mode.
P1(config)#segment-routing	Enters the configuration mode for Segment Routing.
P1(config-sr)# mpls sr-prefer	Configures the preference for MPLS as part of the Segment Routing setup.
P1(config-if)#interface ce50	Enters the configuration mode for interface ce50.
P1(config-if)# ip address 20.1.1.1/24	Assigns an IP address of 20.1.1.1 with a /24 subnet mask to interface ce50.
P1(config-if)# label-switching	Enables label switching for the interface ce50.
P1(config-if)#interface lo	Enters the configuration mode for a loopback interface.
P1(config-if)# ip address 127.0.0.1/8	Assigns an IP address of 127.0.0.1 with a /8 subnet mask to the loopback interface.
P1(config-if)# ip address 3.3.3.3/32 secondary	Adds a secondary IP address of 3.3.3.3 with a /32 subnet mask to the loopback interface.
P1(config-if)# ipv6 address ::1/128	Assigns an IPv6 address of ::1/128 to the loopback interface.
P1(config-if)# prefix-sid index 3	Configures a prefix SID with an index of 3 for the loopback interface.
P1(config-if)#interface xe3	Enters the configuration mode for Ten Gigabit Ethernet interface 3.
P1(config-if)# ip address 10.1.1.2/24	Assigns an IP address of 10.1.1.2 with a /24 subnet mask to interface xe3.
P1(config-if)# label-switching	Enables label switching for interface xe3.
P1(config-if)# exit	Exits the interface configuration.
P1(config-router)#router ospf 100	Enters the configuration mode for OSPF routing process 100.
P1(config-router)# ospf router-id 3.3.3.3	Sets the OSPF router ID to 3.3.3.3.
P1(config-router)# network 3.3.3.3/32 area 0.0.0.0	Specifies the network 3.3.3.3 with a /32 subnet mask to be included in OSPF Area 0.0.0.0.
P1(config-router)# network 10.1.1.0/24 area 0.0.0.0	Specifies the network 10.1.1.0 with a /24 subnet mask to be included in OSPF Area 0.0.0.0.
P1(config-router)# network 20.1.1.0/24 area 0.0.0.0	Specifies the network 20.1.1.0 with a /24 subnet mask to be included in OSPF Area 0.0.0.0.
P1(config-router)# segment-routing mpls	Enables MPLS-based segment routing in the OSPF configuration.

P1(config-router)#line console 0	Enters the configuration mode for the console line.
P1(config-line)# exec-timeout 0 0	Sets the console line's execution timeout values to 0 seconds.
P1(config-line)#line vty 0 871	Enters the configuration mode for virtual terminal lines 0 to 871.
P1(config-line)# exec-timeout 0 0	Sets the execution timeout values for virtual terminal lines to 0 seconds.
P1(config-line)# privilege level 16	Specifies the privilege level for users accessing the virtual terminal lines.
P1(config-line)# Exit	Exits from configuration mode.

P2

P2#configure terminal	Enters the global configuration mode.
P2(config)#segment-routing	Enters the configuration mode for Segment Routing.
P2(config-sr)# mpls sr-prefer	Configures the preference for MPLS as part of the Segment Routing setup.
P2(config-sr)#interface ce1	Enters the configuration mode for interface ce1.
P2(config-if)# ip address 20.1.1.2/24	Assigns an IP address of 20.1.1.2 with a /24 subnet mask to interface ce1.
P2(config-if)# label-switching	Enables label switching for interface ce1.
P2(config-if)#interface ce2	Enters the configuration mode for interface ce2.
P2(config-if)# speed 40g	Sets the speed of interface ce2 to 40Gbps.
P2(config-if)# ip address 30.1.1.1/24	Assigns an IP address of 30.1.1.1 with a /24 subnet mask to interface ce2.
P2(config-if)# label-switching	Enables label switching for interface ce2.
P2(config-if)#interface lo	Enters the configuration mode for a loopback interface.
P2(config-if)# ip address 127.0.0.1/8	Assigns an IP address of 127.0.0.1 with a /8 subnet mask to the loopback interface.
P2(config-if)# ip address 4.4.4.4/32 secondary	Adds a secondary IP address of 4.4.4.4 with a /32 subnet mask to the loopback interface.
P2(config-if)# ipv6 address ::1/128	Assigns an IPv6 address of ::1/128 to the loopback interface.
P2(config-if)# prefix-sid index 4	Configures a prefix SID with an index of 4 for the loopback interface.
P2(config)#router ospf 100	Enters the configuration mode for OSPF routing process 100.
P2(config-router)# ospf router-id 4.4.4.4	Sets the OSPF router ID to 4.4.4.4.
P2(config-router)# network 4.4.4.4/32 area 0.0.0.0	Specifies the network 4.4.4.4 with a /32 subnet mask to be included in OSPF Area 0.0.0.0.
P2(config-router)# network 20.1.1.0/24 area 0.0.0.0	Specifies the network 20.1.1.0 with a /24 subnet mask to be included in OSPF Area 0.0.0.0.
P2(config-router)# network 30.1.1.0/24 area 0.0.0.0	Specifies the network 30.1.1.0 with a /24 subnet mask to be included in OSPF Area 0.0.0.0.
P2(config-router)# segment-routing mpls	Enables MPLS-based segment routing in the OSPF configuration.
P2(config-router)#line console 0	Enters the configuration mode for the console line.
P2(config-line)# exec-timeout 0 0	Sets the console line's execution timeout values to 0 seconds.

P2(config-line)#line vty 0 871	Enters the configuration mode for virtual terminal lines 0 to 871.
P2(config-line)# exec-timeout 0 0	Sets the execution timeout values for virtual terminal lines to 0 seconds.
P2(config-line)# privilege level 16	Specifies the privilege level for users accessing the virtual terminal lines.
P2(config-line)#Exit	Exits the configuration.

PE2

PE2#configure terminal	Enters the global configuration mode.
PE2(config)#evpn mpls enable	Enables EVPN MPLS.
PE2(config)#evpn mpls irb	Enables EVPN MPLS IRB.
PE2(config)mac vrf MacVrf2	Enters the configuration mode for MAC VRF with the name MacVrf2.
PE2(config-vrf)# rd 5.5.5.5:100	Sets the route distinguisher for the MAC VRF to 5.5.5.5:100.
PE2(config-vrf)# route-target both 100:1	Specifies route targets for import and export for the MAC VRF.
PE2(config-vrf)#ip vrf IpVrf1	Enters the configuration mode for IP VRF with the name IpVrf1.
PE2(config-vrf)# rd 5.5.5.5:200	Sets the route distinguisher for the IP VRF to 5.5.5.5:200.
PE2(config-vrf)# route-target both 100:100	Specifies route targets for import and export for the IP VRF.
PE2(config-vrf)# l3vni 100	Configures an L3VNI with ID 100 for the IP VRF.
PE2(config-vrf)#evpn mpls vtep-ip-global 5.5.5.5	Sets the global VTEP IP address for EVPN MPLS to 5.5.5.5.
PE2(config)#evpn mpls id 201	Configures an EVPN MPLS instance with ID 201.
PE2(config-evpn-mpls)# host-reachability-protocol evpn-bgp MacVrf2	Specifies BGP as the host reachability protocol for EVPN MPLS using MacVrf2.
PE2(config-evpn-mpls)# evpn irb irb101	Configures EVPN MPLS IRB with the IRB interface named irb101.
PE2(config-evpn-mpls)#evpn mpls id 2001	Configures another EVPN MPLS instance with ID 2001.
PE2(config-evpn-mpls)# host-reachability-protocol evpn-bgp MacVrf2	Specifies BGP as the host reachability protocol for EVPN MPLS using MacVrf2.
PE2(config-evpn-mpls)# evpn irb irb1001	Configures EVPN MPLS IRB with the IRB interface named irb1001.
PE2(config-evpn-mpls)#qos enable	Enables QoS features for EVPN MPLS.
PE2(config)qos statistics	Configures statistics for QoS.
PE2(config)#hostname PE2	Sets the hostname of the device to PE2.
PE2(config)#segment-routing	Enters the configuration mode for Segment Routing.
PE2(config-sr)# mpls sr-prefer	Configures the preference for MPLS in Segment Routing.
PE2(config)#interface ce1	Enters the configuration mode for interface ce1.
PE2(config-if)# switchport	Enables the switchport mode for the interface.
PE2(config-if)# load-interval 30	Sets the load interval to 30 seconds for the interface.
PE2(config)#interface ce1.101 switchport	Enters the configuration mode for subinterface ce1.101 and enables the switchport mode.
PE2(config-if)# encapsulation dot1q 101	Specifies VLAN encapsulation with VLAN ID 101 for the subinterface.

PE2(config-if)# rewrite pop	Configures the rewrite operation as "pop" for the subinterface.
PE2(config-if)# access-if-evpn	Configures the subinterface as an access interface for EVPN.
PE2(config-acc-if-evpn)# map vpn-id 201	Maps the subinterface to EVPN with VPN ID 201.
PE2(config-acc-if-evpn)#exit	Exits the access interface configuration.
PE2(config)#interface ce3	Enters the configuration mode for interface ce3.
PE2(config)# ip address 30.1.1.2/24	Assigns the IP address 30.1.1.2 with a subnet mask of 255.255.255.0 to interface ce3.
PE2(config)# label-switching	Enables label-switching on interface ce3.
PE2(config-if)#interface irb101	Enters the configuration mode for interface irb101.
PE2(config-irb-if)# ip vrf forwarding IpVrf1	Associates interface irb101 with the VRF (Virtual Routing and Forwarding) instance IpVrf1.
PE2(config-irb-if)# ip address 201.201.201.1/24	Assigns the IP address 201.201.201.1 with a subnet mask of 255.255.255.0 to interface irb101.
PE2(config-irb-if)# ip router isis 101	Enables ISIS routing protocol on interface irb101.
PE2(config-irb-if)#interface irb1001	Enters the configuration mode for interface irb1001.
PE2(config-irb-if)# ip vrf forwarding IpVrf1	Associates interface irb1001 with the VRF instance IpVrf1.
PE2(config-irb-if)# ipv6 address 2001::1/64	Assigns the IPv6 address 2001::1 with a prefix length of 64 to interface irb1001.
PE2(config-irb-if)# ipv6 router isis 101	Enables ISIS routing protocol for IPv6 on interface irb1001.
PE2(config-irb-if)#interface lo	Enters the configuration mode for the loopback interface.
PE2(config-if)# ip address 127.0.0.1/8	Assigns the IP address 127.0.0.1 with a subnet mask of 255.0.0.0 to the loopback interface.
PE2(config-if)# ip address 5.5.5.5/32 secondary	Assigns the secondary IP address 5.5.5.5 with a subnet mask of 255.255.255.255 to the loopback interface.
PE2(config-if)# ipv6 address ::1/128	Assigns the IPv6 address ::1 with a prefix length of 128 to the loopback interface.
PE2(config-if)# prefix-sid index 5	Configures a prefix SID with an index of 5.
PE2(config-if)#exit	Exits the interface configuration mode.
PE2(config)#router ospf 100	Enters the configuration mode for OSPF with process ID 100.
PE2(config-router)# ospf router-id 5.5.5.5	Sets the OSPF router ID to 5.5.5.5.
PE2(config-router)# network 5.5.5.5/32 area 0.0.0.0	Advertises the network 5.5.5.5/32 into OSPF area 0.0.0.0.
PE2(config-router)# network 30.1.1.0/24 area 0.0.0.0	Advertises the network 30.1.1.0/24 into OSPF area 0.0.0.0.
PE2(config-router)# segment-routing mpls	Enables MPLS for segment routing.
PE2(config-router)#router isis 101 IpVrf1	Enters the configuration mode for ISIS with process ID 101 and VRF instance IpVrf1.
PE2(config-irb-if)#interface lo	Enters the configuration mode for the loopback interface.
PE2(config-if)# ip address 127.0.0.1/8	Assigns the IP address 127.0.0.1 with a subnet mask of 255.0.0.0 to the loopback interface.
PE2(config-if)# ip address 5.5.5.5/32 secondary	Assigns the secondary IP address 5.5.5.5 with a subnet mask of 255.255.255.255 to the loopback interface.
PE2(config-if)# ipv6 address ::1/128	Assigns the IPv6 address ::1 with a prefix length of 128 to the loopback interface.
PE2(config-if)# prefix-sid index 5	Configures a prefix SID with an index of 5.

PE2(config)#router ospf 100	Enters the configuration mode for OSPF with process ID 100.
PE2(config-router)# ospf router-id 5.5.5.5	Sets the OSPF router ID to 5.5.5.5.
PE2(config-router)# network 5.5.5.5/32 area 0.0.0.0	Advertises the network 5.5.5.5/32 into OSPF area 0.0.0.0.
PE2(config-router)# network 30.1.1.0/24 area 0.0.0.0	Advertises the network 30.1.1.0/24 into OSPF area 0.0.0.0.
PE2(config-router)# segment-routing mpls	Enables MPLS for segment routing.
PE2(config-router)#router isis 101 IpVrf1	Enters the configuration mode for ISIS with process ID 101 and VRF instance IpVrf1.
PE2(config-router)# is-type level-2-only	Configures ISIS as a level-2-only routing protocol.
PE2(config-router)# net 49.0001.0000.0000.0005.00	Sets the ISIS NET for this router.
PE2(config-router)# redistribute bgp	Configures redistribution of BGP routes into ISIS.
PE2(config-router)#router bgp 100	Enters the configuration mode for BGP with AS number 100.
PE2(config-router)# bgp router-id 5.5.5.5	Sets the BGP router ID to 5.5.5.5.
PE2(config-router)# neighbor 2.2.2.2 remote-as 100	Configures a BGP neighbor with the remote AS number 100 and IP address 2.2.2.2.
PE2(config-router)# neighbor 2.2.2.2 update-source lo	Specifies the loopback interface as the source for BGP updates to the neighbor.
PE2(config-router)# neighbor 2.2.2.2 advertisement-interval 0	Sets the BGP advertisement interval to 0.
PE2(config-router)# address-family l2vpn evpn	Enters the address-family configuration mode for L2VPN EVPN.
PE2(config-router-af)# neighbor 2.2.2.2 activate	Activates the BGP neighbor for the L2VPN EVPN address family.
PE2(config-router-af)# exit-address-family	Exits the address-family configuration.
PE2(config-router)# address-family ipv4 vrf IpVrf1	Enters the address-family configuration mode for IPv4 with VRF instance IpVrf1.
PE2(config-router-af)# redistribute isis	Configures redistribution of ISIS routes into the IPv4 address family.
PE2(config-router-af)# exit-address-family	Exits the address-family configuration.

Configure MTU over IRB

PE2(config)#interface irb101	Enters interface configuration mode for IRB interface 101.
PE2(config-irb-if)#mtu 9216	Sets the MTU to 9216 bytes.
PE2(config-irb-if)#commit	Commit the changes made to the interface configuration.
PE2(config)#interface irb1001	Enters interface configuration mode for IRB interface 1001.
PE2(config-irb-if)#mtu 9216	Sets the MTU to 9216 bytes.
PE2(config-irb-if)#commit	Commit the changes made to the interface configuration.
PE2(config-irb-if)#exit	Exits the IRB interface configuration mode and returns to the global configuration mode.
PE2(config)#interface ce1	Enters interface configuration mode for IRB interface ce1.
PE2(config-irb-if)#mtu 9216	Sets the MTU to 9216 bytes.

PE2(config-irb-if)#commit	Commit the changes made to the interface configuration.
PE2(config-irb-if)#exit	Exits the IRB interface configuration mode and returns to the global configuration mode.

CE2

CE2#Configure Terminal	Enters the configuration mode.
CE2(config)#interface ce1	Enters the configuration mode for interface ce1.
CE2(config-if)# load-interval 30	Sets the load interval for the interface to 30 seconds.
CE2(config-if)#interface ce1.101	Enters the configuration mode for subinterface ce1.101.
CE2(config-if)# encapsulation dot1q 101	Configures 802.1Q encapsulation with VLAN ID 101 for the subinterface.
CE2(config-if)# ip address 201.201.201.2/24	Assigns the IPv4 address 201.201.201.2 with a subnet mask of /24 to the subinterface.
CE2(config-if)# ip router isis 101	Specifies ISIS as the routing protocol for IPv4.
CE2(config-if)#interface ce1.1001	Enters the configuration mode for subinterface ce1.1001.
CE2(config-if)# encapsulation dot1q 1001	Configures 802.1Q encapsulation with VLAN ID 1001 for the subinterface.
CE2(config-if)# ipv6 address 2001::2/64	Assigns the IPv6 address 2001::2 with a /64 prefix length to the subinterface.
CE2(config-if)# ipv6 router isis 101	Specifies ISIS as the routing protocol for IPv6.
CE2(config-if)#interface lo	Enters the configuration mode for the loopback interface.
CE2(config-if)# ip address 127.0.0.1/8	Assigns the primary IPv4 address 127.0.0.1 to the loopback interface with a subnet mask of /8.
CE2(config-if)# ip address 6.6.6.6/32 secondary	Adds a secondary IPv4 address, 6.6.6.6 with a /32 subnet mask, to the loopback interface.
CE2(config-if)# ipv6 address ::1/128	Assigns the primary IPv6 address ::1 to the loopback interface with a /128 prefix length.
CE2(config)#router isis 101	Enters the configuration mode for ISIS with process ID 101.
CE2(config-router)# is-type level-2-only	Configures ISIS as a level-2-only routing protocol.
CE2(config-router)# net 49.0001.0000.0000.0006.00	Sets the ISIS NET for this router.
CE2(config-router)# address-family ipv6	Enters the address-family configuration mode for IPv6.
CE2(config-router-af)# exit-address-family	Exits the address-family configuration for IPv6.
CE2(config)#line console 0	Enters the configuration mode for the console line.
CE2(config-line)# exec-timeout 0 0	Sets the console line's exec-timeout to 0.
CE2(config-line)#line vty 0 871	Enters the configuration mode for VTY lines 0 through 871.
CE2(config-router-af)# exit	Exits the from configuration mode.

Configure MTU over IRB

CE2(config)#int ce1	Enters interface configuration mode for int ce1.
CE2(config-irb-if)#mtu 9216	Sets the MTU to 9216 bytes.
CE2(config-irb-if)#commit	Commit the changes made to the interface configuration.
CE2(config-irb-if)#exit	Exits the IRB interface configuration mode and returns to the global configuration mode.

CE2(config)#int ce1.101	Enters interface configuration mode for int ce1.101.
CE2(config-irb-if)#mtu 9216	Sets the MTU to 9216 bytes.
CE2(config-irb-if)#commit	Commit the changes made to the interface configuration.
CE2(config-irb-if)#exit	Exits the IRB interface configuration mode and returns to the global configuration mode.
CE2(config)#int ce1.1001	Enters interface configuration mode for int ce1.1001.
CE2(config-irb-if)#mtu 9216	Sets the MTU to 9216 bytes.
CE2(config-irb-if)#commit	Commit the changes made to the interface configuration.
CE2(config-irb-if)#exit	Exits the IRB interface configuration mode and returns to the global configuration mode.

Implementation Examples

Scenario: Configure OSPF and ISIS protocols on an IRB interface with an assigned IP address.

Validation

```
CE1#show ip ospf neighbor
```

```
Total number of full neighbors: 1
```

```
OSPF process 101 VRF(default):
```

Neighbor ID Instance ID	Pri	State	Dead Time	Address	Interface
2.2.2.2 0	1	Full/DR	00:00:37	101.101.101.1	po1.101

```
CE1#
```

```
CE1#
```

```
CE1#show ipv6 ospf neighbor
```

```
Total number of full neighbors: 1
```

```
OSPFv3 Process (1001)
```

Neighbor ID	Pri	State	Dead Time	Interface	Instance ID
2.2.2.2	1	Full/DR	00:00:34	po1.1001	0

```
CE1#
```

```
CE1#
```

```
CE1#show ip route
```

```
Codes: K - kernel, C - connected, S - static, R - RIP, B - BGP
```

```
O - OSPF, IA - OSPF inter area
```

```
N1 - OSPF NSSA external type 1, N2 - OSPF NSSA external type 2
```

```
E1 - OSPF external type 1, E2 - OSPF external type 2
```

```
i - IS-IS, L1 - IS-IS level-1, L2 - IS-IS level-2,
```

```
ia - IS-IS inter area, E - EVPN,
```

```
v - vrf leaked
```

```
* - candidate default
```

```
IP Route Table for VRF "default"
```

```
C          1.1.1.1/32 is directly connected, lo, 00:16:58
```

```

C          99.99.99.0/24 is directly connected, ge2, 00:16:59
C          101.101.101.0/24 is directly connected, po1.101, 00:14:10
C          127.0.0.0/8 is directly connected, lo, 00:18:23
O E2      201.201.201.0/24 [110/1] via 101.101.101.1, po1.101, 00:06:14

```

Gateway of last resort is not set

CE1#

CE1#

CE1#show ipv6 route

IPv6 Routing Table

Codes: K - kernel route, C - connected, S - static, D- DHCP, R - RIP,
O - OSPF, IA - OSPF inter area, E1 - OSPF external type 1,
E2 - OSPF external type 2, E - EVPN N1 - OSPF NSSA external type 1,
N2 - OSPF NSSA external type 2, i - IS-IS, B - BGP,
v - vrf leaked

Timers: Uptime

IP Route Table for VRF "default"

```

C          ::1/128 via ::, lo, 00:18:30
C          1001::/64 via ::, po1.1001, 00:14:17
O E2      2001::/64 [110/20] via fe80::eac5:7aff:fea8:7cb3, po1.1001, 00:03:50
C          fe80::/64 via ::, po1.1001, 00:14:17

```

PE1 :

PE1#show ip ospf neighbor

Total number of full neighbors: 1

OSPF process 100 VRF(default):

Neighbor ID Instance ID	Pri	State	Dead Time	Address	Interface	
3.3.3.3	1	Full/DR	00:00:38	10.1.1.2	xe10	0

Total number of full neighbors: 1

OSPF process 101 VRF(IpVrf1):

Neighbor ID Instance ID	Pri	State	Dead Time	Address	Interface
1.1.1.1	1	Full/Backup	00:00:32	101.101.101.2	irb101
0					

PE1#show ipv6 ospf neighbor

Total number of full neighbors: 1

OSPFv3 Process (IpVrf1)

Neighbor ID	Pri	State	Dead Time	Interface	Instance ID
1.1.1.1	1	Full/Backup	00:00:33	irb1001	0

PE1#show evpn mpls tunnel

EVPN-MPLS Network tunnel Entries

Source	Destination	Status	Up/Down	Update	evpn-id
2.2.2.2	5.5.5.5	Installed	00:24:13	00:24:13	100

Total number of entries are 1

```
PE1#show bgp l2vpn evpn summary
BGP router identifier 2.2.2.2, local AS number 100
BGP table version is 2
1 BGP AS-PATH entries
0 BGP community entries
```

Neighbor	PfxRcd	AD	MACIP	V	AS	MsgRcv	MsgSen	TblVer	InQ	OutQ	Up/Down	State/
			MCAST			ESI	PREFIX-ROUTE					
5.5.5.5			4	100	20		21	1	0	0	00:04:09	
9	0	5	2	0	2							

Total number of neighbors 1

Total number of Established sessions 1

```
PE1#show evpn mpls
EVPN-MPLS Information
```

=====

```
Codes: NW - Network Port
       AC - Access Port
       (u) - Untagged
```

VPN-ID	EVI-Name	EVI-Type	Type	Interface	ESI	VLAN	DF-
Status	Src-Addr	Dst-Addr					
100	----	L3	NW	----	----	----	-
---	2.2.2.2		5.5.5.5				
101	----	--	AC	po1.101	---	Single Homed Port	---
---	----		----				
1001	----	--	AC	po1.1001	---	Single Homed Port	---
---	----		----				

Total number of entries are 3

Note: Refer sub-interface config for VLAN information.

```
PE1#
```

```
PE1#
```

```
PE1#show bgp l2vpn evpn prefix-route
```

```
RD[5.5.5.5:200]
```

ESI	Nexthop	Eth-Tag	Prefix-Length	IP-Address	GW-IPAddress	L3VNID/LABEL
		Encap	Router-Mac			
0	5.5.5.5	0	24	201.201.201.0	0.0.0.0	16
5.5.5.5		MPLS	e49d:73b1:c301			
0	5.5.5.5	0	64	2001::	::	16
5.5.5.5		MPLS	e49d:73b1:c301			

```
PE1#
```

```
PE1#show bgp l2vpn evpn mac-ip
```

```
RD[2.2.2.2:100] VRF[MacVrf1]:
```

ESI VNID/LABEL	L3VNID	Eth-Tag Nexthop	Mac-Address GW-Type	IP-Address Encap
0		101	9819:2ccd:9320 --	
17	0	2.2.2.2	--	MPLS
0		101	9819:2ccd:9320	101.101.101.2
17	0	2.2.2.2	--	MPLS
0		101	e8c5:7aa8:7cb3	101.101.101.1
17	0	2.2.2.2	--	MPLS
0		201	e49d:73b1:c301	201.201.201.1
17	0	5.5.5.5	--	MPLS
0		201	e8c5:7a76:583b --	
17	0	5.5.5.5	--	MPLS
0		201	e8c5:7a76:583b	201.201.201.2
17	0	5.5.5.5	--	MPLS
0		1001	9819:2ccd:9320 --	
18	0	2.2.2.2	--	MPLS
0		1001	e8c5:7aa8:7cb3	1001::1
18	0	2.2.2.2	--	MPLS
0		2001	e49d:73b1:c301	2001::1
18	0	5.5.5.5	--	MPLS
0		2001	e8c5:7a76:583b --	
18	0	5.5.5.5	--	MPLS

RD[5.5.5.5:100]

ESI VNID/LABEL	L3VNID	Eth-Tag Nexthop	Mac-Address GW-Type	IP-Address Encap
0		201	e49d:73b1:c301	201.201.201.1
17	0	5.5.5.5	--	MPLS
0		201	e8c5:7a76:583b --	
17	0	5.5.5.5	--	MPLS
0		201	e8c5:7a76:583b	201.201.201.2
17	0	5.5.5.5	--	MPLS
0		2001	e49d:73b1:c301	2001::1
18	0	5.5.5.5	--	MPLS
0		2001	e8c5:7a76:583b --	
18	0	5.5.5.5	--	MPLS

PE1#show mpls ftn-table

Primary FTN entry with FEC: 3.3.3.3/32, id: 1, row status: Active, Tunnel-Policy: N/A, State: Installed

Owner: OSPF-SR, distance: 110, Action-type: Redirect to Tunnel, Exp-bits: 0x0, Incoming DSCP: none

Tunnel id: 0, Protected LSP id: 0, LSP-type: Primary, QoS Resource id: 0, Description: N/A, , Color: 0

Cross connect ix: 3, in intf: - in label: 0 out-segment ix: 2

Owner: N/A, Persistent: No, Admin Status: Up, Oper Status: Up

Out-segment with ix: 2, owner: N/A, Stale: NO, out intf: xe10, out label: 3

Nexthop addr: 10.1.1.2 cross connect ix: 3, op code: Push

Primary FTN entry with FEC: 4.4.4.4/32, id: 2, row status: Active, Tunnel-Policy: N/A, State: Installed

Owner: OSPF-SR, distance: 110, Action-type: Redirect to Tunnel, Exp-bits: 0x0, Incoming DSCP: none

Tunnel id: 0, Protected LSP id: 0, LSP-type: Primary, QoS Resource id: 0, Description: N/A, , Color: 0

```

Cross connect ix: 4, in intf: - in label: 0 out-segment ix: 4
  Owner: OSPF-SR, Persistent: No, Admin Status: Up, Oper Status: Up
  Out-segment with ix: 4, owner: OSPF-SR, Stale: NO, out intf: xe10, out label:
16004
  Nexthop addr: 10.1.1.2          cross connect ix: 4, op code: Push

Primary FTN entry with FEC: 5.5.5.5/32, id: 3, row status: Active, Tunnel-Policy: N/A,
State: Installed
  Owner: OSPF-SR, distance: 110, Action-type: Redirect to Tunnel, Exp-bits: 0x0,
Incoming DSCP: none
  Tunnel id: 0, Protected LSP id: 0, LSP-type: Primary, QoS Resource id: 0, Description:
N/A, , Color: 0
  Cross connect ix: 5, in intf: - in label: 0 out-segment ix: 6
  Owner: OSPF-SR, Persistent: No, Admin Status: Up, Oper Status: Up
  Out-segment with ix: 6, owner: OSPF-SR, Stale: NO, out intf: xe10, out label:
16005
  Nexthop addr: 10.1.1.2          cross connect ix: 5, op code: Push

```

PE1#show mpls forwarding-table

```

Codes: > - installed FTN, * - selected FTN, p - stale FTN, ! - using backup
      B - BGP FTN, K - CLI FTN, (t) - tunnel, P - SR Policy FTN, (b) - bypass,
      L - LDP FTN, R - RSVP-TE FTN, S - SNMP FTN, I - IGP-Shortcut,
      U - unknown FTN, O - SR-OSPF FTN, i - SR-ISIS FTN, k - SR-CLI FTN
      (m) - FTN mapped over multipath transport, (e) - FTN is ECMP

```

FTN-ECMP LDP: Disabled

Code	FEC	FTN-ID	Nhlfe-ID	Tunnel-id	Pri	LSP-Type	Out-Label
O>	3.3.3.3/32	1	3	0	Yes	LSP_DEFAULT	3
xe10	No	10.1.1.2					
O>	4.4.4.4/32	2	5	0	Yes	LSP_DEFAULT	16004
xe10	No	10.1.1.2					
O>	5.5.5.5/32	3	7	0	Yes	LSP_DEFAULT	16005
xe10	No	10.1.1.2					

PE1#show mpls ilm-table

```

Codes: > - installed ILM, * - selected ILM, p - stale ILM, ! - using backup
      K - CLI ILM, T - MPLS-TP, s - Stitched ILM
      S - SNMP, L - LDP, R - RSVP, C - CRLDP
      B - BGP, K - CLI, V - LDP_VC, I - IGP_SHORTCUT
      O - OSPF/OSPF6 SR, i - ISIS SR, k - SR CLI
      P - SR Policy, U - unknown

```

ILM-ECMP LDP: Disabled

Code	FEC/VRF/L2CKT	ILM-ID	In-Label	Out-Label	In-Intf	Out-Intf/VRF
B>	evpn:1001	5	18	Nolabel	N/A	N/A
127.0.0.1		Yes	LSP_DEFAULT			
B>	evpn:101	3	17	Nolabel	N/A	N/A
127.0.0.1		Yes	LSP_DEFAULT			
B>	IpVrfl	1	16	Nolabel	N/A	N/A
A		Yes	LSP_DEFAULT			N/

```

B> evpn:101          2          26880      Nolabel    N/A        N/A
127.0.0.1           Yes      LSP_DEFAULT
O> 4.4.4.4/32       8          16004      16004      N/A        xe10
10.1.1.2            Yes      LSP_DEFAULT
O> 3.3.3.3/32       6          16003      3          N/A        xe10
10.1.1.2            Yes      LSP_DEFAULT
O> 5.5.5.5/32       9          16005      16005      N/A        xe10
10.1.1.2            Yes      LSP_DEFAULT
B> evpn:1001        4          26881      Nolabel    N/A        N/A
127.0.0.1           Yes      LSP_DEFAULT
O> 10.1.1.2/32      7          27520      3          N/A        xe10
10.1.1.2            Yes      LSP_DEFAULT

```

```

PE2 :
=====

```

```

PE2#show ip ospf neighbor

```

```

Total number of full neighbors: 1

```

```

OSPF process 100 VRF(default):

```

Neighbor ID	Pri	State	Dead Time	Address	Interface	
Instance ID						
4.4.4.4	1	Full/DR	00:00:28	30.1.1.1	ce3	0

```

PE2#

```

```

PE2#

```

```

PE2#

```

```

PE2#show clns is-neighbors

```

```

Tag 101: VRF : IpVrf1

```

System Id	Interface	State	Type	Priority	Circuit Id
0000.0000.0006	irb101	Up	L2	64	0000.0000.0006.01
0000.0000.0006	irb1001	Up	L2	64	0000.0000.0006.02

```

PE2#

```

```

PE2#

```

```

PE2#

```

```

PE2#

```

```

PE2#show clns is-neighbors detail

```

```

Tag 101: VRF : IpVrf1

```

System Id	Interface	State	Type	Priority	Circuit Id
0000.0000.0006	irb101	Up	L2	64	0000.0000.0006.01

```

L1 Adjacency ID: 1

```

```

L2 Adjacency ID: 2

```

```

Uptime: 00:11:21

```

```

Area Address(es): 49.0001

```

```

IP Address(es): 201.201.201.2

```

```

Level-2 Protocols Supported: IPv4, IPv6

```

```

Adjacency advertisement: Advertise

```

0000.0000.0006	irb1001	Up	L2	64	0000.0000.0006.02
----------------	---------	----	----	----	-------------------

```

L1 Adjacency ID: 1

```

```

L2 Adjacency ID: 2

```

```

Uptime: 00:11:21
Area Address(es): 49.0001
IPv6 Address(es): fe80::eac5:7aff:fe76:583b
Level-2 Protocols Supported: IPv4, IPv6
Adjacency advertisement: Advertise

```

```
PE2#show evpn mpls tunnel
```

```
EVPN-MPLS Network tunnel Entries
```

Source	Destination	Status	Up/Down	Update	evpn-id
5.5.5.5	2.2.2.2	Installed	00:24:13	00:24:13	100

```
Total number of entries are 1
```

```
PE2#
```

```
PE2#
```

```
PE2#
```

```
PE2#show bgp l2vpn evpn summary
```

```
BGP router identifier 5.5.5.5, local AS number 100
```

```
BGP table version is 4
```

```
1 BGP AS-PATH entries
```

```
0 BGP community entries
```

Neighbor PfxRcd	AD	MACIP	V MCAST	AS	MsgRcv ESI	MsgSen PREFIX-ROUTE	TblVer	InQ	OutQ	Up/Down	State/
2.2.2.2			4	100	93	94	3	0	0	00:14:47	
12	0	5	2	0	5						

```
Total number of neighbors 1
```

```
Total number of Established sessions 1
```

```
PE2#
```

```
PE2#
```

```
PE2#
```

```
PE2#show bgp l2vpn evpn prefix-route
```

```
RD[2.2.2.2:200]
```

ESI	Eth-Tag	Prefix-Length	IP-Address	GW-IPAddress	L3VNID/LABEL
Nexthop	Encap	Router-Mac			
0	0	24	99.99.99.0	0.0.0.0	16
2.2.2.2	MPLS	e8c5:7aa8:7cb3			
0	0	24	101.101.101.0	0.0.0.0	16
2.2.2.2	MPLS	e8c5:7aa8:7cb3			
0	0	32	1.1.1.1	0.0.0.0	16
2.2.2.2	MPLS	e8c5:7aa8:7cb3			
0	0	64	1001::	::	16
2.2.2.2	MPLS	e8c5:7aa8:7cb3			
0	0	64	9001::	::	16
2.2.2.2	MPLS	e8c5:7aa8:7cb3			

```
PE2#show bgp l2vpn evpn mac-ip
```

```
RD[2.2.2.2:100]
```

ESI VNID/LABEL	L3VNID	Eth-Tag Nexthop	Mac-Address GW-Type	IP-Address Encap
0		101	9819:2ccd:9320 --	
17	0	2.2.2.2	--	MPLS
0		101	9819:2ccd:9320	101.101.101.2
17	0	2.2.2.2	--	MPLS
0		101	e8c5:7aa8:7cb3	101.101.101.1
17	0	2.2.2.2	--	MPLS
0		1001	9819:2ccd:9320 --	
18	0	2.2.2.2	--	MPLS
0		1001	e8c5:7aa8:7cb3	1001::1
18	0	2.2.2.2	--	MPLS

RD[5.5.5.5:100] VRF[MacVrf2]:

ESI VNID/LABEL	L3VNID	Eth-Tag Nexthop	Mac-Address GW-Type	IP-Address Encap
0		101	9819:2ccd:9320 --	
17	0	2.2.2.2	--	MPLS
0		101	9819:2ccd:9320	101.101.101.2
17	0	2.2.2.2	--	MPLS
0		101	e8c5:7aa8:7cb3	101.101.101.1
17	0	2.2.2.2	--	MPLS
0		201	e49d:73b1:c301	201.201.201.1
17	0	5.5.5.5	--	MPLS
0		201	e8c5:7a76:583b --	
17	0	5.5.5.5	--	MPLS
0		201	e8c5:7a76:583b	201.201.201.2
17	0	5.5.5.5	--	MPLS
0		1001	9819:2ccd:9320 --	
18	0	2.2.2.2	--	MPLS
0		1001	e8c5:7aa8:7cb3	1001::1
18	0	2.2.2.2	--	MPLS
0		2001	e49d:73b1:c301	2001::1
18	0	5.5.5.5	--	MPLS
0		2001	e8c5:7a76:583b --	
18	0	5.5.5.5	--	MPLS

PE2#show mpls forwarding-table

Codes: > - installed FTN, * - selected FTN, p - stale FTN, ! - using backup
 B - BGP FTN, K - CLI FTN, (t) - tunnel, P - SR Policy FTN, (b) - bypass,
 L - LDP FTN, R - RSVP-TE FTN, S - SNMP FTN, I - IGP-Shortcut,
 U - unknown FTN, O - SR-OSPF FTN, i - SR-ISIS FTN, k - SR-CLI FTN
 (m) - FTN mapped over multipath transport, (e) - FTN is ECMP

FTN-ECMP LDP: Disabled

Code	FEC	ELC	Nexthop	FTN-ID	Nhlfe-ID	Tunnel-id	Pri	LSP-Type	Out-Label
O>	2.2.2.2/32	No	30.1.1.1	1	3	0	Yes	LSP_DEFAULT	16002
ce3									
O>	3.3.3.3/32	No	30.1.1.1	2	5	0	Yes	LSP_DEFAULT	16003
ce3									
O>	4.4.4.4/32	No	30.1.1.1	3	7	0	Yes	LSP_DEFAULT	3
ce3									

PE2#

PE2#show mpls ilm-table

Codes: > - installed ILM, * - selected ILM, p - stale ILM, ! - using backup

K - CLI ILM, T - MPLS-TP, s - Stitched ILM
 S - SNMP, L - LDP, R - RSVP, C - CRLDP
 B - BGP , K - CLI , V - LDP_VC, I - IGP_SHORTCUT
 O - OSPF/OSPF6 SR, i - ISIS SR, k - SR CLI
 P - SR Policy, U - unknown

ILM-ECMP LDP: Disabled

Code	FEC/VRF/L2CKT	ILM-ID	In-Label	Out-Label	In-Intf	Out-Intf/VRF
Nexthop		pri	LSP-Type			
B>	evpn:2001	5	18	Nolabel	N/A	N/A
127.0.0.1		Yes	LSP_DEFAULT			
B>	evpn:201	3	17	Nolabel	N/A	N/A
127.0.0.1		Yes	LSP_DEFAULT			
B>	IpVrfl	1	16	Nolabel	N/A	N/A
A		Yes	LSP_DEFAULT			N/
B>	evpn:201	2	26880	Nolabel	N/A	N/A
127.0.0.1		Yes	LSP_DEFAULT			
O>	3.3.3.3/32	7	16003	16003	N/A	ce3
30.1.1.1		Yes	LSP_DEFAULT			
O>	2.2.2.2/32	6	16002	16002	N/A	ce3
30.1.1.1		Yes	LSP_DEFAULT			
O>	4.4.4.4/32	8	16004	3	N/A	ce3
30.1.1.1		Yes	LSP_DEFAULT			
B>	evpn:2001	4	26881	Nolabel	N/A	N/A
127.0.0.1		Yes	LSP_DEFAULT			
O>	30.1.1.1/32	9	27520	3	N/A	ce3
30.1.1.1		Yes	LSP_DEFAULT			

PE2#

PE2#

PE2#show mpls ftn-table

Primary FTN entry with FEC: 2.2.2.2/32, id: 1, row status: Active, Tunnel-Policy: N/A, State: Installed

Owner: OSPF-SR, distance: 110, Action-type: Redirect to Tunnel, Exp-bits: 0x0, Incoming DSCP: none

Tunnel id: 0, Protected LSP id: 0, LSP-type: Primary, QoS Resource id: 0, Description: N/A, , Color: 0

Cross connect ix: 3, in intf: - in label: 0 out-segment ix: 2

Owner: OSPF-SR, Persistent: No, Admin Status: Up, Oper Status: Up

Out-segment with ix: 2, owner: OSPF-SR, Stale: NO, out intf: ce3, out label: 16002

Nexthop addr: 30.1.1.1 cross connect ix: 3, op code: Push

Primary FTN entry with FEC: 3.3.3.3/32, id: 2, row status: Active, Tunnel-Policy: N/A, State: Installed

Owner: OSPF-SR, distance: 110, Action-type: Redirect to Tunnel, Exp-bits: 0x0, Incoming DSCP: none

Tunnel id: 0, Protected LSP id: 0, LSP-type: Primary, QoS Resource id: 0, Description: N/A, , Color: 0

Cross connect ix: 4, in intf: - in label: 0 out-segment ix: 4

Owner: OSPF-SR, Persistent: No, Admin Status: Up, Oper Status: Up

Out-segment with ix: 4, owner: OSPF-SR, Stale: NO, out intf: ce3, out label: 16003

Nexthop addr: 30.1.1.1 cross connect ix: 4, op code: Push

Primary FTN entry with FEC: 4.4.4.4/32, id: 3, row status: Active, Tunnel-Policy: N/A, State: Installed

Owner: OSPF-SR, distance: 110, Action-type: Redirect to Tunnel, Exp-bits: 0x0, Incoming DSCP: none

Tunnel id: 0, Protected LSP id: 0, LSP-type: Primary, QoS Resource id: 0, Description: N/A, , Color: 0

Cross connect ix: 5, in intf: - in label: 0 out-segment ix: 6

Owner: N/A, Persistent: No, Admin Status: Up, Oper Status: Up

Out-segment with ix: 6, owner: N/A, Stale: NO, out intf: ce3, out label: 3

Nexthop addr: 30.1.1.1 cross connect ix: 5, op code: Push

CE2#show clns is-neighbors

Tag 101: VRF : default

System Id	Interface	State	Type	Priority	Circuit Id
0000.0000.0005	ce1.101	Up	L2	64	0000.0000.0006.01
0000.0000.0005	ce1.1001	Up	L2	64	0000.0000.0006.02

CE2#show clns is-neighbors detail

Tag 101: VRF : default

System Id	Interface	State	Type	Priority	Circuit Id
0000.0000.0005	ce1.101	Up	L2	64	0000.0000.0006.01

L1 Adjacency ID: 1

L2 Adjacency ID: 2

Uptime: 00:13:41

Area Address(es): 49.0001

IP Address(es): 201.201.201.1

Level-2 Protocols Supported: IPv4, IPv6

Adjacency advertisement: Advertise

0000.0000.0005	ce1.1001	Up	L2	64	0000.0000.0006.02
----------------	----------	----	----	----	-------------------

L1 Adjacency ID: 1

L2 Adjacency ID: 2

Uptime: 00:13:41

Area Address(es): 49.0001

IPv6 Address(es): fe80::e69d:73ff:feb1:c301

Level-2 Protocols Supported: IPv4, IPv6

Adjacency advertisement: Advertise

CE2#show ip route

Codes: K - kernel, C - connected, S - static, R - RIP, B - BGP

O - OSPF, IA - OSPF inter area

N1 - OSPF NSSA external type 1, N2 - OSPF NSSA external type 2

E1 - OSPF external type 1, E2 - OSPF external type 2

i - IS-IS, L1 - IS-IS level-1, L2 - IS-IS level-2,

ia - IS-IS inter area, E - EVPN,

v - vrf leaked

* - candidate default

```
IP Route Table for VRF "default"
i L2      1.1.1.1/32 [115/10] via 201.201.201.1, ce1.101, 00:10:22
C         6.6.6.6/32 is directly connected, lo, 00:13:54
i L2      99.99.99.0/24 [115/10] via 201.201.201.1, ce1.101, 00:10:22
i L2      101.101.101.0/24 [115/10] via 201.201.201.1, ce1.101, 00:10:22
C         127.0.0.0/8 is directly connected, lo, 00:18:45
C         201.201.201.0/24 is directly connected, ce1.101, 00:13:54
```

Gateway of last resort is not set

```
CE2#show ipv6 route
```

```
IPv6 Routing Table
```

```
Codes: K - kernel route, C - connected, S - static, D- DHCP, R - RIP,
        O - OSPF, IA - OSPF inter area, E1 - OSPF external type 1,
        E2 - OSPF external type 2, E - EVPN  N1 - OSPF NSSA external type 1,
        N2 - OSPF NSSA external type 2, i - IS-IS, B - BGP,
        v - vrf leaked
```

```
Timers: Uptime
```

```
IP Route Table for VRF "default"
C         ::1/128 via ::, lo, 00:18:50
i L2      1001::/64 [115/10] via fe80::e69d:73ff:feb1:c301, ce1.1001, 00:10:27
C         2001::/64 via ::, ce1.1001, 00:13:59
C         fe80::/64 via ::, ce1.1001, 00:13:59
```

Abbreviations

The following are some key abbreviations and their meanings relevant to this document:

Acronym	Description
ECMP	Equal-Cost Multipath
EVPN	Ethernet Virtual Private Network
MPLS	Multiprotocol Label Switching
MPLS	Multiprotocol Label Switching
SR	Segment Routing
IRB	Integrated Routing
OSPF	Open Shortest Path First
ISIS	Intermediate System to Intermediate System

Glossary

The following provides definitions for key terms used throughout this document.

Single Home EVPN-MPLS	A network architecture that combines EVPN and MPLS to provide efficient and scalable Layer 2 and Layer 3 services within a network, particularly in SP environments.
IRB	A networking feature that enables the integration of Layer 3 IP routing and Layer 2 MAC address bridging within the same interface, simplifying network management and resource utilization.
OSPF	A dynamic and efficient link-state routing protocol used to determine the best path for data packets in an IP network. It is characterized by rapid convergence and adaptability, making it suitable for large and dynamic networks.
ISIS	A routing protocol designed for scalability and stability in computer networks, commonly used in large Service Provider networks. It provides a robust framework for routing information exchange.
Layer 3 Routing	Network routing operations at the Network Layer (Layer 3) of the OSI model, focusing on routing IP packets between different subnets or networks.
Layer 2 Bridging	Network bridging operations at the Data Link Layer (Layer 2) of the OSI model, handling the forwarding of data frames based on MAC addresses within the same network segment.
EVPN	Ethernet VPN, a technology that provides advanced and efficient methods for Layer 2 and Layer 3 services in Ethernet networks, often used in data centers and service provider environments.

Virtual Extensible LAN Command Reference

CHAPTER 1 VXLAN Commands

This chapter describes the VxLAN commands:

- `access-if-evpn`
- `arp-cache disable`
- `arp-nd flood-suppress`
- `arp-nd refresh timer`
- `clear mac address-table dynamic vxlan`
- `clear nvo vxlan counters`
- `clear nvo vxlan mac-stale-entries`
- `description`
- `dynamic-learning disable`
- `encapsulation`
- `evpn esi hold-time`
- `evpn`
- `evpn etree`
- `evpn irb-forwarding anycast-gateway-mac`
- `evpn irb-if-forwarding anycast-gateway-mac`
- `evpn multi-homed`
- `evpn vxlan multihoming enable`
- `evpn-vlan-service`
- `hardware-profile filter vxlan`
- `hardware-profile filter vxlan-mh`
- `hardware-profile filter vxlan-short-pkt`
- `interface irb`
- `ip address`
- `ipv6 address`
- `ip dhcp relay uplink`
- `l3vni`
- `mac`
- `mac vrf`
- `mac-holdtime`
- `map vpn-id`
- `nd-cache disable`
- `nvo vxlan`
- `nvo vxlan access-if`

- `nvo vxlan id`
- `nvo vxlan irb`
- `nvo vxlan mac-ageing-time`
- `nvo vxlan vtep-ip-global`
- `show bgp l2vpn evpn`
- `show bgp l2vpn evpn prefix-route`
- `show bgp l2vpn evpn summary`
- `show evpn multi-homing all`
- `show evpn multihoming-status`
- `show interface irb`
- `show nvo vxlan`
- `show nvo vxlan access-if-config`
- `show nvo vxlan arp-cache`
- `show nvo vxlan counters access-port`
- `show nvo vxlan counters network-port`
- `show evpn`
- `show nvo vxlan mac-table`
- `show nvo vxlan static host state`
- `show nvo vxlan tunnel`
- `show nvo vxlan route-count`
- `show nvo vxlan vni-name`
- `show nvo vxlan xconnect`
- `show running-config interface irb`
- `show running-config nvo vxlan`
- `shutdown`
- `vxlan host-reachability-protocol evpn-bgp`

access-if-evpn

Use this command to create the evpn access-port.

Use the no form of this command to delete the evpn access-port.

Command Syntax

```
access-if-evpn
no access-if-evpn
```

Parameters

None

Command Mode

L2 Sub-interface mode

Applicability

This command was introduced in OcNOS version 6.0.0.

Examples

```
#configure terminal
(config)#interface xe1.1 switchport
(config-if)#access-if-evpn
(config-access-if)#end
```

arp-cache disable

Use this command to disable the ARP cache for MAC/IP.

When the ARP cache is disabled on a VxLAN access port, OcnOS does not reply to any ARP arriving on this port from the cache. OcnOS withdraws all MAC/IPs configured/learned on this access port and removes the MAC/IP entry for this access port from the local ARP cache.

OcnOS also makes sure that on withdrawing the MAC/IP route, the MAC does not become unknown. If all routes for this MAC are being withdrawn because of this command, then OcnOS advertises a MAC-only route. This is done so that the MAC does not become unknown and only the cache functionality becomes disabled.

Use the `no` form of this command to enable ARP cache for MAC/IP.

Note: On enabling the cache, an IP will be in conflict, then the cache enable will fail. The conflict has to be manually removed and then the cache enabled.

Command Syntax

```
arp-cache disable
no arp-cache disable
```

Parameters

None

Default

By default, the `arp-cache` option is enabled.

Command Mode

NVO access interface mode

Access interface EVPN mode

Applicability

This command was introduced before OcnOS version 1.3.

The Access interface EVPN mode is supported only from OcnOS version 6.0.

Example

```
#configure terminal
(config)#nvo vxlan access-if port-vlan xe1 2
(config-nvo-acc-if)#arp-cache disable
(config-nvo-acc-if)#exit

(config)#interface xe7.100 switchport
(config-if)#access-if-evpn
(config-acc-if-evpn)#arp-cache disable
```

arp-nd flood-suppress

Use this command to *completely* restrict the flood of ARP/ND packets towards remote VTEPs or other access ports.

This command applies only when the ARP cache and ND cache are enabled. When the ARP cache is disabled, ARP flooding is not suppressed even if this command is given. When the ND cache is disabled, ND flooding is not disabled, even if this command is given.

Use the `no` form of this command to not restrict the flood of ARP/ND packets.

Command Syntax

```
arp-nd flood-suppress
no arp-nd flood-suppress
```

Parameters

None

Default

By default, the `arp-nd flood-suppress` option is disabled.

Command Mode

NVO access interface mode

Access interface EVPN mode

Applicability

This command was introduced before OcNOS version 1.3.

The Access interface EVPN mode is supported only from OcNOS version 6.0.

Example

```
#configure terminal
(config)#nvo vxlan access-if port-vlan xel 2
(config-nvo-acc-if)#arp-nd flood-suppress
(config-nvo-acc-if)#exit

(config)#interface xe7.100 switchport
(config-if)#access-if-evpn
(config-acc-if-evpn)#arp-nd flood-suppress disable
```

arp-nd refresh timer

Use this command to configure aging out the arp-cache and nd-cache entries for given time multiplied by 3 in seconds. Use the `no` form of this command to remove the configuration.

Note: After this timer interval, it sends out ARP to revalidate and 3 times of this would lead to removal of the dynamic entry.

Command Syntax

```
nvo vxlan arp-nd refresh-timer <3-190>
no nvo vxlan arp-nd refresh-timer
```

Parameters

<3-190> Refresh timer value in seconds (age-out is refresh time * 3)

Command Mode

Configuration mode

Applicability

This command was introduced in OcNOS version 4.0.

Example

```
#config mode
(config)#nvo vxlan arp-nd refresh-timer 100
(config)#no nvo vxlan arp-nd refresh-timer
```

clear mac address-table dynamic vxlan

Use this command to clear dynamically learned MACs.

Command Syntax

```
clear mac address-table dynamic vxlan
clear mac address-table dynamic vxlan vniid <1-16777215>
clear mac address-table dynamic vxlan vniid <1-16777215> (address MACADDR|)
```

Parameters

address	Clear the specified MAC Address
VNIID	VxLAN network identifier
<1-16777215>	Range supported for VNIID

Command Mode

Exec mode

Applicability

This command was introduced before OcNOS version 1.3.

Example

```
#clear mac address table dynamic vxlan
#clear mac address-table dynamic vxlan vniid 100
#clear mac address-table dynamic vxlan vniid 100 address 0000.0005.0505
```

clear nvo vxlan counters

Use this command to clear the counters of access ports or network ports.

Command Syntax

```
clear nvo vxlan counters((access-port (port IFNAME | port-vlan IFNAME (VLAN_ID |
outer-vlan) | all)) | (network-port (dst A.B.C.D | all)))
```

Parameters

port	Port
IFNAME	Interface name
port-vlan	VLAN port
IFNAME	Interface name
VLAN_ID	VLAN identifier
Outer-vlan	Outer VLAN
A.B.C.D	Tunnel destination IPv4 address
all	All access or network ports

Command Mode

Exec mode

Applicability

This command was introduced before OcNOS version 1.3.

Example

Example for clearing a VLAN port counter:

```
#clear nvo vxlan counters access-port port-vlan xe1 2
```

Example for clearing all access port counters:

```
#clear nvo vxlan counters access-port all
```

Example for clearing network port counters:

```
#clear nvo vxlan counters network-port dst 1.1.1.1
```

Example for clearing all network port counters:

```
#clear nvo vxlan counters network-port all
```

clear nvo vxlan mac-stale-entries

Use this command to clear MAC entries that are in discard state in the forwarding database.

Command Syntax

```
clear nvo vxlan mac-stale-entries (vnid <1-16777215> |)
```

Parameters

<1-16777215> VxLAN network identifier

Command Mode

Exec mode

Applicability

This command was introduced before OcnOS version 1.3.

Example

```
#clear nvo vxlan mac-stale-entries vnid 100
```

description

Use this command to set a description for a port.

Use the `no` form of this command to remove the description for a port.

Command Syntax

```
description LINE
no description
```

Parameters

LINE Maximum 32 characters describing this port.

Default

No default value is specified for description LINE commands.

Command Mode

NVO access interface mode

Applicability

This command was introduced before OcnOS version 1.3.

Example

```
#configure terminal
(config)#nvo vxlan access-if port-vlan xel 2
(config-nvo-acc-if)#description member-port xel with vlan 2
(config-nvo-acc-if)#exit

#show running-config nvo vxlan
!
nvo vxlan enable
!
nvo vxlan access-if port-vlan xel 2
description member-port xel with vlan 2
no shutdown
```

dynamic-learning disable

Use this command to disable dynamic learning of MACs at the access port. This command also disables dynamic learning of MAC/IP from ARP/ND messages received on this access port.

Use the `no` form of this command to enable dynamic learning of MACs at the access port.

Command Syntax

```
dynamic-learning disable
no dynamic-learning disable
```

Parameters

None

Default

By default, the dynamic-learning option is enabled.

Command Mode

NVO access interface mode

Access interface EVPN mode

Applicability

This command was introduced before OcNOS version 1.3.

The Access interface EVPN mode is supported only from OcNOS version 6.0.

Example

```
#configure terminal
(config)#nvo vxlan access-if port-vlan xe1 2
(config-nvo-acc-if)#dynamic-learning disable
(config-nvo-acc-if)#exit

(config)#interface xe7.100 switchport
(config-if)#access-if-evpn
(config-acc-if-evpn)#dynamic-learning disable
```

encapsulation

Use this command to assign a Tag Protocol Identifier (TPID) to an access port.

Use the `no` form of this command to set the default TPID (0x8100: IEEE 802.1Q VLAN-tagged frame) to an access port.

Note: Before configuring the TPID in the NVO access interface mode, first configure it at port level.

Command Syntax

```
encapsulation TPID
no encapsulation
```

Parameters

TPID	Tag Protocol Identifier:
	0x88A8: IEEE 802.1ad Provider Bridging
	0x9100: IEEE 802.1Q VLAN-tagged frame with double tagging

Default

The encapsulation TPID default is 0X8100.

Command Mode

NVO access interface mode

Applicability

This command was introduced before OcNOS version 1.3.

Example

```
#configure terminal
(config)#nvo vxlan access-if port-vlan xel 2
(config-nvo-acc-if)#encapsulation 0x9100
(config-nvo-acc-if)#no encapsulation
(config-nvo-acc-if)#exit
```

evpn esi hold-time

Use this command to allow some time for the tunnels to come at the time of VxLAN initialization before making the ESI up. This avoids traffic to be black-holed when a new PE is added and connected to an already running CE for multihoming.

Use the `no` form of this command to make the ESI up immediately when configuring the access-if cli.

Command Syntax

```
evpn esi hold-time <10-300>
no evpn esi hold-time <10-300>
```

Parameters

<10-300>	Hold time in seconds
----------	----------------------

Default

The default value is 0.

Command Mode

Configuration Mode

Applicability

This command was introduced before OcnOS version 1.3.

Example

```
#configure terminal
(config)# evpn esi hold-time 100
(config)# exit
```

evpn

Use this command to configure default gateway behavior on a VTEP for particular VNID.

Use the no form this command to disable default gateway behavior on a VTEP for the particular VNID.

Note: Map an IRB interface to an L2 VNID. This IRB interface can have multiple IP address as configured in IRB IP address CLI and can serve all subnets attached to the L2 VNID.

Command Syntax

```
evpn <NAME>
no evpn <NAME>
```

Parameters

NAME	IRB interface name
------	--------------------

Command Mode

NVO Mode

Applicability

This command was introduced before OcnOS version 4.1.

Example

```
#config mode
(config)# nvo vxlan id 2000 ingress-replication inner-vid-disabled
(config-nvo)# evpn irb1
(config-nvo)# no evpn irb1
```

evpn irb-forwarding anycast-gateway-mac

Use this command to configure common anycast mac-address for all the IRB interfaces

Use the `no` form of this command to remove the global MAC address on all the IRB interfaces.

Command Syntax

```
evpn irb-forwarding anycast-gateway-mac XXXX.XXXX.XXXX
no evpn irb-forwarding anycast-gateway-mac
```

Parameters

XX-XX-XX-XX-XX-XX	Source MAC address (Option 1)
XX:XX:XX:XX:XX:XX	Source MAC address (Option 2)
XXXX.XXXX.XXXX	Source MAC address (Option 3)

Command Mode

Configuration Mode

Applicability

This command was introduced before OcNOS version 4.1.

Example

```
#configure terminal
(config)#evpn irb-forwarding anycast-gateway-mac 0000.0000.1313
Or
(config)#evpn irb-forwarding anycast-gateway-mac 00:00:00:00:13:13
Or
(config)#evpn irb-forwarding anycast-gateway-mac 00-00-00-00-13-13
(config)# no evpn irb-forwarding anycast-gateway-mac
```

evpn irb-if-forwarding anycast-gateway-mac

Use this command to enable an IRB interface to use the global anycast IRB mac-address.

Use the `no` form of this command to un-configure anycast MAC at IRB interface.

Command Syntax

```
evpn irb-if-forwarding anycast-gateway-mac
no evpn irb-if-forwarding anycast-gateway-mac
```

Parameters

None

Command Mode

IRB_IF_Mode

Applicability

This command was introduced before OcnOS version 4.1.

Example

```
#configure terminal
(config)# interface irb 1
(config-irb-if)# ip vrf forwarding vrfip
(config-irb-if)#evpn irb-if-forwarding anycast-gateway-mac
(config-irb-if)#no evpn irb-if-forwarding anycast-gateway-mac
```

evpn multi-homed

Use this command to configure single-active or port-active load-balancing Ethernet Segment Identifier (ESI) configuration on a link with multihomed Customer Edge (CE).

Use the no parameter of this command to unconfigure Ethernet Segment Identifier (ESI) configuration on a link with multihomed Customer Edge (CE).

Command Syntax

```
evpn multi-homed (esi XX:XX:XX:XX:XX:XX:XX:XX:XX | system-mac (XX-XX-XX-XX-XX-XX|XX:XX:XX:XX:XX:XX|XXXX.XXXX.XXXX)) load-balancing single-active
evpn multi-homed system-mac (XX-XX-XX-XX-XX-XX|XX:XX:XX:XX:XX:XX|XXXX.XXXX.XXXX) load-balancing port-active
no evpn multi-homed (esi | system-mac)
```

Parameters

XX:XX:XX:XX:XX:XX:XX:XX:XX	ESI value in HH:HH:HH:HH:HH:HH:HH:HH:HH - 9 octet format
XX-XX-XX-XX-XX-XX	Host MAC address (Option 1)
XX:XX:XX:XX:XX:XX	Host MAC address (Option 2)
XXXX.XXXX.XXXX	Host MAC address (Option 3)

Default

The default value is 0.

Command Mode

Interface mode

Applicability

This command was introduced before OcNOS version 1.3 and underwent modifications in the OcNOS version 6.4.1.

Example

```
#configure terminal
(config)#interface xe1
(config-if)#evpn multi-homed esi 00:11:22:33:44:55:66:77:88 load-balancing
single-active
(config)#exit

#configure terminal
(config)#interface po1
(config-if)#evpn multi-homed system-mac 0000.0000.1111 load-balancing port-
active
(config)#exit
```

evpn vxlan multihoming enable

Use this command to enable evpn vxlan multi-homing

Use the no form of this command to disable evpn vxlan multi-homing.

Note: You must restart the device after giving this command. If there are devices in the topology which have multi-homed CEs, then devices which do not have multi-homed CEs should also enable multihoming so that they can load share traffic to the multi-homed CEs.

Note: Before enabling multi-homing, configure the hardware-profiles:

- [hardware-profile filter vxlan-mh](#)
- [hardware-profile filter for Qumran-1](#) with the `egress-ipv4` parameter

Command Syntax

```
evpn vxlan multihoming enable
no evpn vxlan multihoming enable
```

Parameters

None

Default

By default, multi-homing is disabled.

Command Mode

Configure mode

Applicability

This command was introduced before OcNOS version 1.3 and changed in OcNOS version 4.0.

Example

```
#configure terminal
#(config)#evpn vxlan multihoming enable
#(config)#exit
```

evpn-vlan-service

Use this command to configure VLAN-based EVPN-Service type.

Use the `no` form of this command to delete the evpn vlan service.

Note: If access port mappings to vnid exists already and VLAN service is configured later and mapped to tenant then we should not allow the mapping, user should either remove and reconfigure the access port mappings.

Command Syntax

```
evpn-vlan-service vlan-based
no evpn-vlan-service
```

Parameters

`vlan-based` VLAN-based EVPN-Service type

Command Mode

MAC vrf mode

Applicability

This command was introduced before OcnOS version 1.3.

Example

```
#configure terminal
(config)#mac vrf vrf1
(config-vrf)# evpn-vlan-service vlan-based
(config-vrf)# no evpn-vlan-service vlan-based
```

hardware-profile filter vxlan

Use this command to configure hardware profile for nvo vxlan. This profile should be enabled before enabling VxLAN.

Note: You need to save the configuration and do a reboot after giving this command.

Command Syntax

```
hardware-profile filter vxlan enable
hardware-profile filter vxlan disable
```

Parameters

None

Command Mode

Configure mode

Applicability

This command was introduced in OcNOS version 3.0.

Example

```
#config mode
(config)# hardware-profile filter vxlan enable
(config)# hardware-profile filter vxlan disable
```

hardware-profile filter vxlan-mh

Use this command to enable the hardware-profile for VxLAN multi-homing to successfully activate multi-homing in the hardware.

Before enabling EVPN multi-homing ([evpn multi-homed](#) command), give this command.

Before disabling the hardware-profile, disable EVPN multi-homing.

Note: You need to save the configuration and do a reboot after giving this command.

Use the `disable` form of this command to disable the configured hardware-profile.

Command Syntax

```
hardware-profile filter vxlan-mh enable
hardware-profile filter vxlan-mh disable
```

Parameters

None

Default

By default, the VxLAN multi-homing hardware-profile is disabled.

Command Mode

Configure mode

Applicability

This command was introduced in OcNOS version 3.0.

Example

```
#configure terminal
#(config)#hardware-profile filter vxlan-mh enable
#(config)#hardware-profile filter vxlan-mh disable
#(config)#exit
```

hardware-profile filter vxlan-short-pkt

Use this command to enable/disable the VxLAN short packet forwarding filter group.

When this filter group is enabled, any short packet received less than 36B is sent to the CPU to add extra bytes to make the packet size up to 64B and sent back to access-port.

Use the `disable` form of this command to disable the configured hardware-profile.

Command Syntax

```
hardware-profile filter vxlan-short-pkt enable
hardware-profile filter vxlan-short-pkt disable
```

Parameters

None

Default

By default, the VxLAN short packet hardware-profile is disabled.

Command Mode

Configure mode

Applicability

This command was introduced in OcNOS version 6.3.1.

Example

```
#configure terminal
#(config)#hardware-profile filter vxlan-short-pkt enable
#(config)#exit
```

interface irb

Use this command to configure logical IRB interface.

Use the `no` form of this command to un-configure logical IRB interface.

Command Syntax

```
interface irb<1-4094>  
no interface irb<1-4094>
```

Parameters

<1-4094> IRB interface number

Command Mode

Configure mode

Applicability

This command was introduced in OcNOS version 4.1.

Example

```
#configure terminal  
(config)#interface irb1  
(config)#no interface irb1
```

ip address

Use this command to set anycast flag for primary and secondary subnets under IRB interface.

With this anycast gateway can be supported for multiple subnets.

Command Syntax

```
ip address [ <A.B.C.D/M> | anycast]
ip address [ <A.B.C.D> | <A.B.C.D> | anycast]
ip address [ <A.B.C.D/M> | secondary | anycast]
ip address [ <A.B.C.D> | <A.B.C.D> | secondary | anycast]
```

Default

The default value is router mac

Parameters

anycast	Anycast flag
secondary	Used for secondary address option

Command Mode

IRB_IF Mode

Applicability

The anycast flag was introduced in OcnOS version 6.3.0.

Example

```
(config)#interface irb2
(config-irb-if)#ip address 40.1.1.1/24 anycast
(config-irb-if)#ip address 41.1.1.1/24 secondary anycast
(config-irb-if)#
(config)#interface irb1
(config-irb-if)#ip address 42.1.1.1 255.255.255.0 anycast
(config-irb-if)#ip address 43.1.1.1 255.255.255.0 secondary anycast
(config-irb-if)#
```

ipv6 address

Use this command to set anycast flag for any configured subnets under IRB interface.

With this anycast gateway can be supported for multiple subnets.

Command Syntax

```
ipv6 address [ < X:X::X:X/M > | anycast]
```

Default

The default value is router mac

Parameters

<code>anycast</code>	Anycast flag
----------------------	--------------

Command Mode

IRB_IF Mode

Applicability

The anycast flag was introduced in OcNOS version 6.3.0.

Example

```
(config)#interface irb1  
(config-irb-if)# ipv6 address 1100::1/64 anycast
```

ip dhcp relay uplink

Use this command to configure uplink interface towards server per vrf.

Use the `no` form of this command to un-configure uplink interface.

Command Syntax

```
ip dhcp relay uplink evpn
no ip dhcp relay uplink evpn
```

Parameters

evpn IP VRF IRB interface

Command Mode

Configure mode

Applicability

This command was introduced in OcNOS version 5.0.

Example

```
#configure terminal
(config)#ip vrf vrf1
(config-vrf)#ip dhcp relay uplink evpn
(config-vrf)#no ip dhcp relay uplink evpn
```

l3vni

Use this command to configure L3 Virtual Network Identifier for an ip vrf

Use the no form of this command to remove L3 Virtual Network Identifier

This identifies a tenant, with this one tenant can have L3VNI as its identifier and he can have multiple L2 networks identified with L2VNI's.

Note: L3 VNID cannot be same as L2 VNID.

Command Syntax

```
l3vni <L3 VNID>  
no l3vni <L3 VNID>
```

Parameters

<1-16777215> L3 VNID. Cannot be same as L2 VNID

Command Mode

Configure VRF mode

Applicability

This command was introduced in OcNOS version 4.1.

Example

```
#configure terminal  
(config)#ip vrf vrfip  
(config-vrf)#l3vni 10002  
(config-vrf)#no l3vni 10002
```

mac

Use this command to associate a static MAC address and a static IPv4 or IPv6 address on an access interface.

Use the `no` form of this command to disassociate a static MAC address and an IPv4 or IPv6 address for an access interface.

Note: When a static host is configured on an access port which is in the down state, its state is Inactive.

Note: The same static mac configuration is not allowed on a different access port as then there will be a chance of conflict. However, if a dynamic packet is sent at another access port which is up and running with the same MAC, it learns as usual. As soon as the port on which the static MAC is configured comes up, static learning is given precedence and the dynamically learned MAC is moved to the port where it is configured statically.

Command Syntax

```
mac XXXX.XXXX.XXXX
mac XXXX.XXXX.XXXX (ip A.B.C.D | ipv6 X:X::X:X)
no mac XXXX.XXXX.XXXX (ip A.B.C.D | ipv6 X:X::X:X)
```

Parameters

XXXX.XXXX.XXXX	Static MAC address. The following formats are supported:
	XX-XX-XX-XX-XX-XX Source MAC address (Option 1)
	XX:XX:XX:XX:XX:XX Source MAC address (Option 2)
	XXXX.XXXX.XXXX Source MAC address (Option 3)
A.B.C.D	Static IPv4 address.
X:X::X:X	Static IPv6 address.

Default

No default value is specified for mac command.

Command Mode

NVO access interface mode

Access interface EVPN mode

Applicability

This command was introduced before OcNOS version 1.3.

The Access interface EVPN mode is supported only from OcNOS version 6.0.

Example

```
#configure terminal
(config)#nvo vxlan access-if port-vlan xe1 2
(config-nvo-acc-if)#mac 0000.0000.aaaa ip 10.10.10.1
(config-nvo-acc-if)#mac 0000.0000.aaaa ipv6 1201::1
(config-nvo-acc-if)#exit
(config)#interface xe7.100 switchport
(config-if)#access-if-evpn
(config-acc-if-evpn)#arp-nd flood-supress disable
```

mac vrf

Use this command to create a MAC VRF to use in EVPN routes.

See also [vxlan host-reachability-protocol evpn-bgp](#).

Use the `no` form of this command to delete the MAC VRF.

Command Syntax

```
mac vrf WORD
no mac vrf WORD
```

Parameter

WORD MAC routing or forwarding instance name.

Command Mode

Configure mode

Applicability

This command was introduced before OcnOS version 1.3.

Example

```
#configure terminal
(config)#mac vrf vrf1

(config)#no mac vrf vrf1
```

mac-holdtime

Use this command to set the MAC hold time for a MAC/IP or MAC.

The feature holds the MAC in hardware until BGP has withdrawn from the neighbors. This helps to reduce flooding to other access ports.

This setting applies when the access port is shut down, the physical port on which the access port is down, or the access port is removed from the VNID using the `no` form of the [map vpn-id](#) command.

When the MAC hold time is configured as -1, then the MAC is not removed from the hardware and is also not withdrawn from EVPN BGP.

Use the `no` form of this command to remove the MAC hold time for the MAC/IP or MAC.

Note: When a MAC is moved to discard state, traffic to and from this MAC is discarded. This is applicable only on statically configured MAC/MAC-IPs.

Command Syntax

```
mac-holdtime <-1-300>
no mac-holdtime
```

Parameters

<-1-300> MAC hold time in seconds. Specify -1 to “never expire”.

Default

The default holdtime for mac is 3 seconds.

Command Mode

NVO access interface mode

Access interface EVPN mode

Note: When configured in both modes, then the `NVO_ACC_IF_MODE` or `ACC-IF-EVPN` value takes preference for that access port.

Applicability

This command was introduced before OcnOS version 1.3.

This command in `NVO_ACC_IF_MODE` mode is introduced in OcnOS version 1.3.4.

The Access interface EVPN mode is supported only from OcnOS version 6.0.

Example

```
#configure terminal
(config)#nvo vxlan id 3 ingress-replication inner-vid-disabled
(config-nvo)#mac-holdtime -1
(config-nvo)#exit

(config)#interface xe7.100 switchport
(config-if)#access-if-evpn
(config-acc-if-evpn)#mac-holdtime -1
```

map vpn-id

Use this command to map a tenant to an access-port.

Use the `no` form of this command to remove the tenant from an access-port

Command Syntax

```
map vpn-id <1-16777215>
no map vpn-id <1-16777215>
```

Parameters

<1-16777215> VxLAN network identifier.

Default

No default value is specified for map vnid command.

Command Mode

NVO access interface mode

Access interface EVPN mode

Applicability

This command was introduced before OcNOS version 1.3.

The Access interface EVPN mode is supported only from OcNOS version 6.0.

Example

```
#configure terminal
(config)#nvo vxlan access-if port-vlan xe1 2
(config-nvo-acc-if)#map vpn-id 100
(config-nvo-acc-if)#exit

(config)#interface xe7.100 switchport
(config-if)#access-if-evpn
(config-acc-if-evpn)#map vpn-id 100
```

nd-cache disable

Use this command to disable ND cache for MAC/IPv6.

When the ND cache is disabled on a VXLAN access port, OcnOS does not reply to any ND arriving on this port from the cache. OcnOS withdraws all MAC/IPs configured/learned on this access port and removes the MAC/IP entry for this access port from the local ND cache.

OcnOS also makes sure that on withdrawing the MAC/IP route, the MAC does not become unknown. If all routes for this MAC are being withdrawn because of this command, then OcnOS advertises a MAC-only route. This is done so that the MAC does not become unknown and only the cache functionality becomes disabled.

See also [arp-cache disable](#).

Use the `no` form of this command to enable ND cache for MAC/IPv6.

Note: On enabling the cache, an IP will be in conflict, then the cache enable will fail. The conflict has to be manually removed and then the cache enabled.

Command Syntax

```
nd-cache disable
no nd-cache disable
```

Parameters

None

Default

By default, the `nd-cache` option is enabled.

Command Mode

NVO access interface mode

Access interface EVPN mode

Applicability

This command was introduced before OcnOS version 1.3.

The Access interface EVPN mode is supported only from OcnOS version 6.0

Example

```
#configure terminal
(config)#nvo vxlan access-if port-vlan xe1 2
(config-nvo-acc-if)#nd-cache disable
(config-nvo-acc-if)#exit

(config)#interface xe7.100 switchport
(config-if)#access-if-evpn
(config-acc-if-evpn)#nd-cache disable
```

nvo vxlan

Use this command to enable or disable VxLAN.

You must enable the VxLAN hardware profile with the [hardware-profile filter vxlan](#) command before enabling VxLAN.

Note: To make nvo vxlan disable and enable effective, system reboot is required.

Command Syntax

```
nvo vxlan (enable | disable)
```

Parameters

None

Default

By default, the VxLAN is disabled.

Command Mode

Configure mode

Applicability

This command was introduced before OcNOS version 1.3.

Example

```
#configure terminal
(config)#nvo vxlan enable

(config)#nvo vxlan disable
```

nvo vxlan access-if

Use this command to map a complete interface or a VLAN or VLAN range on an interface to identify the tenant traffic and to enter NVO access interface mode.

The command `nvo vxlan access-if port <if_name> default` accepts all tagged, double tagged and untagged traffic received on the mapped physical port.

Use the `no` form of this command to unmap an interface or a VLAN.

Note: When a VxLAN access interface configured as a port VLAN as VLAN-range or port as default, then arp-cache and nd-cache should be disabled and only VNID with inner-vid-enable is mapped.

Note: Inner-vid-enable is one-to-one mapping. VNID is mapped to only on one access-port.

Note: VLAN Range not allowed to be configured for VxLAN stacked access-port.

Command Syntax

```
nvo vxlan access-if (port IFNAME (| default) | port-vlan IFNAME VLAN_RANGE (|
  inner-vlan <2-4094>))
no nvo vxlan access-if (port IFNAME | port-vlan IFNAME VLAN_RANGE(| inner-vlan <2-
  4094>))
```

Parameters

<code>port</code>	A physical port.
<code>IFNAME</code>	Interface name (Physical/Static lag/Dynamic lag)
<code>default</code>	Default access interface
<code>port-vlan</code>	The physical port on which VLANs are configured
<code>IFNAME</code>	Interface name (Physical/Static lag/Dynamic lag)
<code>VLAN_RANGE</code>	Configure VLANId or VLAN-Range for outer VLAN
<code>Inner-vlan</code>	Inner-VLAN id
<code><2-4094></code>	VLAN id

Default

By default, the `nvo vxlan access-if` option is port VLAN ID.

Command Mode

Configure mode

Applicability

This command was introduced before OcNOS version 1.3 and `VLAN_RANGE` option is introduced in OcNOS version 5.0. This command is not available on Qumran2 devices.

Example

```
#configure terminal
(config)#nvo vxlan access-if port-vlan xe1 2-10
(config-nvo-acc-if)#exit

#configure terminal
```

```
(config)#nvo vxlan access-if port xe1
(config-nvo-acc-if)#exit

#configure terminal
(config)#nvo vxlan access-if port xe1 default
(config-nvo-acc-if)#exit

#configure terminal
(config)#nvo vxlan access-if port-vlan xe1 2 inner-vlan 10
(config-nvo-acc-if)#exit
```

nvo vxlan id

Use this command to add a tenant and the type of VPN. This command changes the mode to NVO mode.

Use `nvo vxlan id` for creating ELAN and use `nvo vxlan id xconnect` with source and target identifier for ELINE/XConnect.

Use `no` form of this command to unconfigure the VxLAN ID.

You must enable VxLAN with the [nvo vxlan](#) command before you give this command.

Command Syntax

```
nvo vxlan id <1-16777215> (multicast |) | ((ingress-replication | xconnect target-
vxlan-id <1-16777215>) (| inner-vid-disabled)) (etree-leaf|)
no nvo vxlan id <1-16777215>
```

Parameters

<code>vxlan id <1-16777215></code>	Specifies the VXLAN Network Identifier (VNID) to identify the virtual VXLAN overlay network segment.
<code>multicast</code>	(Optional) Specifies a multicast group (point to multipoint) used for transmitting VXLAN encapsulated multicast packets.
<code>ingress-replication</code>	(Optional) Enables head-end replication for forwarding BUM traffic.
<code>xconnect target-vxlan-id <1-16777215></code>	Specifies the cross-connect Identifier.
<code>inner-vid-disabled</code>	(Optional) Disables the transmission of the VLAN ID (VID) with traffic leaving the network port.
<code>etree-leaf</code>	(Optional) Configures the device as a leaf node within the E-Tree topology, implying its role in forwarding BUM traffic within the E-Tree service model.

Command Mode

Configure mode

Applicability

Introduced before OcnOS version 1.3. Introduced the `etree-leaf` and `xconnect target-vxlan-id <1-16777215>` parameters in the OcnOS version 6.5.1.

Example

```
#configure terminal
(config)#nvo vxlan id 300 ingress-replication
(config-nvo)#exit

(config)#nvo vxlan id 200 ingress-replication inner-vid-disabled
(config-nvo)#exit

(config)#nvo vxlan id 30 xconnect target-vxlan-id 20
(config-nvo)#exit
```

```
(config)#nvo vxlan id 40 xconnect target-vxlan-id 50 ingress-replication
(config-nvo)#exit
```

To configure a VXLAN instance with VXLAN ID for ingress replication, with inner VLAN ID disabled, and as an E-Tree leaf node:

```
(config)#nvo vxlan id 10 ingress-replication inner-vid-disabled etree-leaf
(config-nvo)#exit
```

nvo vxlan irb

Use this command to enable IRB functionality.

Use the `no` form of this command to disable IRB functionality.

Note: Remove the existing L2 VNID configuration to enable IRB.

Command Syntax

```
nvo vxlan irb
no nvo vxlan irb
```

Parameters

None

Command Mode

Configure mode

Applicability

This command was introduced before OcnOS version 4.1.

Example

```
#configure terminal
(config)#nvo vxlan irb
(config)#no nvo vxlan irb
```

nvo vxlan mac-ageing-time

Use this command to set the dynamically learned MAC aging time.

Use the `no` form of this command to set the age out the MACs in hardware to its default (300 seconds).

Command Syntax

```
nvo vxlan mac-ageing-time <10-572>
no nvo vxlan mac-ageing-time
```

Parameters

<10-572> Aging time in seconds

Default

The default age out time is 300 seconds.

Command Mode

Configure mode

Applicability

This command was introduced before OcNOS version 1.3.

Example

```
#configure terminal
(config)#nvo vxlan mac-ageing-time 10
(config)#no nvo vxlan mac-ageing-time 10
```

nvo vxlan vtep-ip-global

Use this command to set the source IP address of the VXLAN tunnels.

Use the `no` form of this command to remove the source IP address of the VXLAN tunnels.

You must enable VXLAN with the [nvo vxlan](#) command before you give this command.

Command Syntax

```
nvo vxlan vtep-ip-global A.B.C.D
no nvo vxlan vtep-ip-global A.B.C.D
```

Parameters

A.B.C.D	Source VTEP IP address of the global configuration
---------	--

Default

No default value is specified for `nvo vxlan vtep-ip-global` command.

Command Mode

NVO mode

Applicability

This command was introduced before OcnOS version 1.3.

Example

```
(config-nvo)#nvo vxlan vtep-ip-global 10.10.11.1
```

show bgp l2vpn evpn

Use this command to display details about Layer 2 Virtual Private Network (L2VPN) Ethernet Virtual Private Network (EVPN) routes.

Note: A BGP EVPN route update received for an unreachable IP address is also listed by this command and as a best route. This is because the next hop tracking feature is not supported for the EVPN address family. However, the tunnel to this IP address is shown in unresolved state by the [show nvo vxlan tunnel](#) output.

Command Syntax

```
show bgp l2vpn evpn (((vrf WORD)|(rd WORD)|)((prefix-route)|)(detail| time|))
show bgp l2vpn evpn mac-ip ((vrf WORD)|(rd WORD)|)
show bgp l2vpn evpn mcast
show bgp l2vpn evpn multihoming es-route <(rd WORD)|(vrf WORD)>
show bgp l2vpn evpn multihoming ethernet-ad-per-evi <(rd WORD)|(vrf WORD)>
show bgp l2vpn evpn multihoming ethernet-ad-per-es <(rd WORD)|(vrf WORD)>
```

Parameters

vrf	Virtual Routing and Forwarding instance
WORD	VRF name
rd	Route distinguisher
WORD	Route distinguisher: ASN:nn or IP:nn
prefix-route	Shows detail of the Prefix-Route (Type:5)
detail	Detailed output of the route-path
time	Display learnt time for details for evpn routes.
mac-ip	Show detail of the MAC-IP route (Type:2)
mcast	Show detail of the Inclusive MULTICAST route (Type:3)
multihoming	Show multihoming information
peer-group	Dynamic peer-group

Command Mode

Exec mode

Applicability

This command was introduced before OcNOS version 1.3.

Example

```
show bgp l2vpn evpn detail
BGP route entry for prefix : [1]:[00:00:00:00:11:12:12:22:11:11]:[100]:[100]
Route-Distinguisher: 1.1.1.1:1
Flags : Valid, Selected, IBGP, Labelled
Nexthop : 1.1.1.1 MED value : 0
Community:
Extended Community: RT:100:1 Encapsulation:VxLAN ESI-Label:0
Weight :0, Local Preference :100
AS Path : Local
```

```
Origin : IGP
Last Update : Thu Apr 13 12:05:23 2023
Peer : 1.1.1.1
```

```
BGP route entry for prefix : [2]:[0]:[100]:[48,0000:1111:0000]:[32,10.12.11.12]:[100]
Route-Distinguisher: 1.1.1.1:1
Flags : Valid, Selected, IBGP, Labelled
Nexthop : 1.1.1.1 MED value : 0
Community:
Extended Community: RT:100:1 Encapsulation:VxLAN MAC_mob_seq:Static
Weight :0, Local Preference :100
AS Path : Local
Origin : IGP
Last Update : Thu Apr 13 12:05:23 2023
Peer : 1.1.1.1
Total number of prefixes 2
```

Table 1-1 shows the status codes displayed at the start of a route entry.

Table 1-1: status codes

Status code	Description	Comments
s	suppressed	Whether the route is suppressed and is not advertised to neighbors.
d	damped	When the penalty of a flapping route exceeds the suppress limit, the route is damped and remains in a withdrawn state until its penalty decreases below the reuse limit.
h	history	When the penalty of a flapping route does not exceed the suppress limit, the route is not damped and BGP maintains a history of the flapping route.
*	valid	Whether the route is valid. When a route is not suppressed, damped, or present in the history, it is valid.
>	best	The selected route to be installed in the kernel routing table.
i	internal	The prefix was learned from an iBGP peer.
l	labeled	BGP Labeled Unicast advertises route information between inter region routers.

Table 1-2 shows the codes at the end of each route entry that indicate where the route originated.

Table 1-2: origin codes

Origin Code	Description	Comments
i	IGP	The route is from an Interior Gateway Protocol.
e	EGP	The route is from an Exterior Gateway Protocol.
?	incomplete	Origin not known. Typically, these are routes redistributed from an IGP.

Table 1-3 explains the fields for each route.

Table 1-3: route entry fields

Field	Description
RD	Route distinguisher: AS number or IP address.
VRF	Name of the VRF.
Network	<p>EVPN route information.</p> <p>The route type indicates the type of routing information advertised by the EVPN control plane:</p> <p>2 MAC/IP Route: Endpoint reachability information, including MAC and IP addresses of the endpoints.</p> <p>3 Inclusive Multicast Route: Information about how to forward Broadcast, Unknown Unicast and Multicast (BUM) traffic.</p> <p>The other fields included depend on the route type: Type 2: [ESI]:[E-Tag]:[Length, Host MAC address]:[Length, Host IP address]:[Label/VNID] Type 3: [E-Tag]:[Length, PE IP address]</p> <p>ESI (Ethernet Segment Identifier): a unique non-zero identifier that identifies an Ethernet segment, which is a set of links that connects a network or device to one or more PEs. ESI 0 denotes a single-homed site.</p> <p>E-Tag (Ethernet tag): identifies a particular broadcast domain such as a VLAN or VNID in the VxLAN case. An EVPN instance consists of one or more broadcast domains.</p> <p>VNID (VxLAN network identifier): identifies Layer 2 segments and maintains Layer 2 isolation between the segments, allowing the addressing of up to 16 million logical networks in the same administrative domain.</p> <p>The status codes are explained in Table 1-1.</p>
Next Hop	IP address of the nexthop for this route.
Metric	Multiple-Exit Discriminator (MED). If there are multiple paths to the same destination from a single routing protocol, then the multiple paths have the same administrative distance and the best path is selected based on this metric. The path with the lowest metric is selected as the optimal path and installed in the routing table.
LocPrf	This value is used only with iBGP sessions within the local autonomous system to determine if a route towards a destination is the "best" one. The path with the highest local preference is preferred.
Weight	This field applies only to routes within an individual router. If a route was learned from a peer, it has a default weight of 0. All routes generated by the local router have a weight of 32,768.
Path	The autonomous systems through which the prefix advertisement passed. The origin codes are explained in Table 1-2 .
Peer	Neighbor address.
Total number of prefixes	The total number of prefixes listed.

show bgp l2vpn evpn prefix-route

Use this command to display the Type-5 prefix remote routes.

Command Syntax

```
show bgp l2vpn evpn prefix-route <vrf WORD | rd Word>
```

Parameters

None

Command Mode

Exec mode

Applicability

This command was introduced before OcNOS version 4.1.

Example

```
rtr1#show bgp l2vpn evpn prefix-route
```

```
RD[300:1]
ESI
GW-IP Address      Eth-Tag Prefix-Length  IP-Address      Encap
                   L3VNID  Nexthop
0                   45001   24              80.80.80.0      VxLAN
0.0.0.0            45001   24              45001  2.2.2.2
0                   45001   24              90.90.90.0      VxLAN
0.0.0.0            45001   24              45001  2.2.2.2
0                   45001   64              8001::          VxLAN
::                 45001   64              45001  2.2.2.2
0                   45001   64              9001::          VxLAN
::                 45001   64              45001  2.2.2.2
rtr1#
```

show bgp l2vpn evpn summary

Use this command to display a summary of BGP EVPN neighbor status.

Command Syntax

```
show bgp l2vpn evpn summary
```

Parameters

None

Command Mode

Exec mode

Applicability

This command was introduced before OcNOS version 1.3.

Example

```
#show bgp l2vpn evpn summary
BGP router identifier 1.1.1.1, local AS number 100
BGP table version is 17
1 BGP AS-PATH entries
0 BGP community entries
```

Neighbor	V	AS	MsgRcv	MsgSen	TblVer	InQ	OutQ	Up/Down	State/PfxRcd	AD	MACIP	MCAST	ESI
8.8.8.8	4	100	111	112	17	0	0	00:53:03	3	0	0	3	0
9.9.9.9	4	100	110	110	17	0	0	00:52:10	15	0	13	2	0
13.13.13.13	4	100	132	109	17	0	0	00:51:57	4	0	2	2	0

Total number of neighbors 3

Total number of Established sessions 3

The start of the output shows:

- The BGP router identifier and the local router AS number.
- The BGP table version tracks the local BGP table version. Any time the BGP best path algorithm executes, the table version increments.
- BGP AS-PATH entry and community entries.

[Table 1-4](#) explains the fields for each neighbor entry.

Table 1-4: neighbor fields

Field	Description
Neighbor	IP address of peer.
V	BGP version of peer.
AS	Autonomous system number of peer.
MsgRcvd	Messages received since the BGP connection was established.
MsgSent	Messages sent since the BGP connection was established.

Table 1-4: neighbor fields (Continued)

Field	Description
TblVer	Last version of the local router's BGP database advertised to the peer.
InQ	Received messages waiting in the input queue for further processing.
OutQ	Messages waiting in the output queue to be sent.
Up/Down	Connection up time in the interface.
State/PfxRcd	<p>If the TCP session is up and the BGP peers have formed an adjacency, this field shows how many prefixes have been received from the remote neighbor.</p> <p>Other states:</p> <p>Idle: The local router has not allocated resources for the peer connection, so incoming connection requests are refused</p> <p>Idle (Admin): The peer has shut down</p> <p>Idle (PfxCt): Prefix overflow</p> <p>Idle (G-shut): Graceful shutdown</p> <p>Connect: BGP is waiting for the TCP connection to complete</p> <p>Active: the local router is trying to establish a TCP connection to the remote peer. You might see this if the local peer has been configured, but the remote peer is unreachable or has not been configured.</p> <p>OpenSent: BGP is waiting for an open message from its peer</p> <p>OpenConfirm: BGP received an open message from the peer and is now waiting for a keepalive or notification message. If BGP receives a keep alive message from the peer, the state changes to established. If the message is a notification, the state changes to idle.</p> <p>Established: BGP is ready to exchange update, notification, and keep alive messages with its peer</p> <p>Invalid: The session state is invalid.</p>
AD	Number of EVPN type 1 Ethernet Auto-discovery routes: Only originated for multi-homed sites. Type 1 routes allow fast convergence where PE devices can change the next-hop adjacencies for all MAC addresses associated with a particular Ethernet Segment and aliasing where traffic can be balanced across multiple egress points
MACIP	Number of EVPN type 2 MAC/IP routes: Endpoint reachability information, including MAC and IP addresses of the endpoints.
MCAST	Number of EVPN type 3 Inclusive Multicast routes: Broadcast, Unknown Unicast and Multicast (BUM) traffic.
ESI	Number of EVPN type 4 Ethernet Segment Routes: Used in multi-homing for Designated Forwarder Election. The Designated Forwarder sends BUM traffic to the CE on a particular Ethernet Segment.

show evpn multi-homing all

Use this command to display the multi-homed VTEP details.

Command Syntax

```
show evpn multi-homing all
```

Parameters

None

Command Mode

Exec mode

Applicability

This command was introduced before OcNOS version 1.3.

Example

```
#show evpn multi-homing all
ESI
=====
00:00:11:22:33:44:55:66:77:88 ce21/1      1.1.1.1
00:00:11:22:33:44:55:66:77:88 ----      2.2.2.2
Total number of entries are 2
```

[Table 1-5](#) explains the output fields.

Table 1-5: show evpn multi-homing all output details

Field	Description
ESI	An Ethernet segment has a unique nonzero identifier, called the Ethernet segment identifier (ESI). The ESI is encoded as a 10-octet integer that identifies this segment. When manually configuring an ESI value, the most significant octet, known as the type byte, must be 00. When a single-homed CE device is attached to an Ethernet segment, the entire ESI value is zero.
Access-IF	Map the access port ce21/1 for evpn.
PE-IP-ADDRESS	Address of the provider edge router in the interface.

show evpn multihoming-status

Use this command to display the status of multihoming on a VTEP.

Command Syntax

```
show evpn multihoming-status
```

Parameters

None

Command Mode

Exec mode

Applicability

This command was introduced before OcNOS version 1.3.

Example

```
#show evpn multihoming-status  
Multihoming is ACTIVE in Hardware
```

show interface irb

Use this command to display the current running configuration of IRB interface.

Command Syntax

```
show interface irb<1-4094>
```

Parameters

None

Command Mode

Exec mode

Applicability

This command was introduced before OcNOS version 4.1.

Example

```
rtr1#show interface irb1
Interface irb1
  Hardware is IRB   Current HW addr: 0000.0000.ff10
  Physical:(Not Applicable)   Logical:0000.0000.ff10
  Port Mode is Router
  Interface index: 700001
  Metric 0 mtu 1500
  Debounce timer: disable
  ARP ageing timeout 1500
  <UP,BROADCAST,RUNNING,MULTICAST>
  VRF Binding: Associated with vrf1
  Label switching is disabled
  Administrative Group(s): None
  DHCP client is disabled.
  Last Flapped: Never
  Statistics last cleared: 2019 Mar 14 17:57:06 (00:21:31 ago)
  inet 80.80.80.1/24 broadcast 80.80.80.255
  inet6 8001::1/64
  inet6 fe80::200:ff:fe00:ff10/64
  RX
    unicast packets 0 multicast packets 0 broadcast packets 0
    input packets 0 bytes 0
    jumbo packets 0
    undersize 0 oversize 0 CRC 0 fragments 0 jabbers 0
    input error 0
    input with dribble 0 input discard 0
    Rx pause 0
  TX
    unicast packets 0 multicast packets 0 broadcast packets 0
    output packets 0 bytes 0
    jumbo packets 0
    output errors 0 collision 0 deferred 0 late collision 0
    output discard 0
    Tx pause 0
rtr1#
```

show nvo vxlan

Use this command to display VxLAN information.

Command Syntax

```
show nvo vxlan (vnid <1-16777215>|)
```

Parameters

<1-16777215> VxLAN network identifier

Command Mode

Exec mode

Applicability

This command was introduced before OcNOS version 1.3.

Example

```
#sh nvo vxlan
VxLAN Information
=====
Codes: NW - Network Port
       AC - Access Port
       (u) - Untagged

VNID    Vni-name    Type Interface ESI                    Vlan DF-Status Src-addr    Dst-addr
-----
10      ----      NW  ----      ----                    ---- ----      1.1.1.1    3.3.3.3
10      ----      NW  ----      ----                    ---- ----      1.1.1.1    2.2.2.2
10      ----      AC  ce21/1    00:00:11:22:33:44:55:66:77:88 2    DF          ----      ----
20      ----      NW  ----      ----                    ---- ----      1.1.1.1    3.3.3.3
20      ----      NW  ----      ----                    ---- ----      1.1.1.1    2.2.2.2
20      ----      AC  ce21/1    00:00:11:22:33:44:55:66:77:88 3    NON-DF     ----      ----
45001   ----      L3  NW        ----                    ---- ----      1.1.1.1    3.3.3.3

Total number of entries are 7
```

Table 1-6 explains the fields in the output.

Table 1-6: VxLAN fields

Field	Description
VNID	VxLAN network identifier.
Type	NW - Network Port: VxLAN tunnel AC - Access Port: Host connection
Interface	Name of the Interface.
Vlan	VLAN identifier
Src-addr	Source address in the interface.
Dst-addr	Destination address in the interface.
Total number of entries	The total number of entries listed.

show nvo vxlan access-if-config

Use this command to display the current running configuration of the access interface.

Command Syntax

```
show nvo vxlan access-if-config (LINE|)
```

Parameters

LINE	Access port description
------	-------------------------

Command Mode

Exec mode

Applicability

This command was introduced before OcNOS version 1.3.

Example

```
#show nvo vxlan access-if-config
  nvo vxlan access-if port-vlan xe1 2
    map vnid 100
  access-if-description member-port with xe1 as vlan 2
  shutdown
  mac 0000.0000.1111
  mac 0000.0000.aaaa ip 12.12.12.1
  map qos-profile cos-to-queue ac_port_ingress
  map qos-profile queue-color-to-cos ac_port_egress
  !
  nvo vxlan access-if port-vlan po1 6
    no shutdown
    map vnid 100
  !
```

show nvo vxlan arp-cache

Use this command to display the ARP cache information.

Command Syntax

```
show nvo vxlan arp-cache (vnid <1-16777215>|)
```

Parameters

<1-16777215> VxLAN network identifier

Command Mode

Exec mode

Applicability

This command was introduced before OcNOS version 1.3.

Example

```
#show nvo vxlan arp-cache
VxLAN ARP-CACHE Information
=====
VNID      Ip-Addr      Mac-Addr      Type      Age-Out      Retries-Left
-----
10        12.12.12.2   0000.0000.2222 Static Local  ----
Total number of entries are 1
```

[Table 1-7](#) explains the fields in the output.

Table 1-7: arp cache fields

Field	Description
VNID	VxLAN network identifier.
Ip-Addr	IP address of the vxlan.
Mac-Addr	Device MAC address.
Type	How a host learns a MAC/IP pair: Dynamic Local: Learned by data plane source learning Dynamic Remote: Learned by EVPN Type 2 (MAC/IP) routes Static Remote: Statically configured for remote; used only for static VxLAN, not with EVPN Static Local: Configured on local VTEP
Total number of entries	The total number of entries listed.

show nvo vxlan counters access-port

Use this command to display the receive and transmit counters of an access port.

Note: Due to a limitation in the hardware, the transmit packet counters includes the BUM traffic received on that port.

Note: To see the statistics, you must enable the hardware profile for the access-port with the [hardware-profile filter for Qumran-1](#) command with the `ac-lif` parameter.

Note: All the expected packets might not be seen in the output of this command.

Command Syntax

```
show nvo vxlan counters access-port (port IFNAME | port-vlan IFNAME VLAN_ID_RANGE
  (| inner-vlan INNER_VLAN_ID) | all)
```

Parameters

port	Port Mapping
IFNAME	Access port name
port-vlan	Port-VLAN Mapping
IFNAME	Access port name
VLAN_ID_RANGE	VLAN Id or VLAN Range <2-4094>
INNER_VLAN_ID	Inner-VLAN Id
all	All ports and VLANs

Command Mode

Exec mode

Applicability

This command was introduced before OcNOS version 1.3 and VLAN_RANGE option is introduced in OcNOS version 5.0.

Example

```
#show nvo vxlan counters access-port port-vlan xe13 10
```

Data packets:

*If ARP/ND cache is enabled, TX doesn't count ARP/ND replies from ARP/ND cache and ARP/ND forwarded after uplifting to the control plane.

```
RX: packets : 2774939
    bytes   : 210553516
TX: packets : 4322274
    bytes   : 326026474
```

Control Packets:

*ARP/ND uplifted and sent/replied from control plane:

```
Rx Vxlan Arp discard count : 0
Rx Vxlan Nd discard count  : 0
Tx Vxlan Arp discard count : 0
Tx Vxlan Nd discard count  : 0
Rx Vxlan Arp Request count : 0
```

```

Tx Vxlan Arp Request count      : 0
Rx Vxlan Arp Reply count       : 5
Tx Vxlan Arp Reply count       : 1
Rx Vxlan Neighbor Solicitation count : 0
Tx Vxlan Neighbor Solicitation count : 0
Rx Vxlan Neighbor Advertisement count: 3
Tx Vxlan Neighbor Advertisement count: 0

```

Table 1-8 explains the fields in the output.

Table 1-8: access port counters

Field	Description
RX: packets	Number of packets received on an access-interface.
RX: bytes	Number of bytes received.
TX: packets	Number of packets transmitted.
TX: bytes	Number of bytes transmitted.
Rx Vxlan Nd discard count	Number of discarded ND that is received from neighbor.
Tx Vxlan Arp discard count	Number of discarded Arp that is transmitted to peer.
Tx Vxlan Nd discard count	Number of discarded ND that is transmitted to peer.
Rx Vxlan Arp Request count	Number of request ARP that is received from neighbor.
Tx Vxlan Arp Request count	Number of request ARP that is transmitted to peer.
Rx Vxlan Arp Reply count	Number of replied ARP that is received from neighbor.
Tx Vxlan Arp Reply count	Number of replied ARP which is transmitted to peer.
Rx Vxlan Neighbor Solicitation count	Number of request ND that is received from neighbor.
Tx Vxlan Neighbor Solicitation count	Number of replied ND that is received from neighbor.
Rx Vxlan Neighbor Advertisement count	Number of Neighbor Advertisement that is received from neighbor.
Tx Vxlan Neighbor Advertisement count	Number of Neighbor Advertisement which is transmitted to peer.

show nvo vxlan counters network-port

Use this command to display the receive and transmit counters of a network port including ARP, ND and GARP counters.

Command Syntax

```
show nvo vxlan counters network-port (dst A.B.C.D | ALL)
```

Parameters

A.B.C.D	Tunnel IPv4 address
ALL	All addresses

Command Mode

Exec mode

Applicability

This command was introduced before OcNOS version 1.3.

Example

```
#show nvo vxlan counters network-port dst 2.2.2.2
```

Data packets:

*If ARP/ND cache is enabled, TX doesn't count ARP/ND replies from ARP/ND cache and ARP/ND forwarded after uplifting to the control plane.

```
RX: packets : 0
    bytes    : 0
TX: packets : 3570006
    bytes    : 406980684
```

Control Packets:

*ARP/ND uplifted and sent/replied from control plane:

```
TX VxLAN ARP discard count      : 0
TX VxLAN ND discard count       : 0
Tx Vxlan ARP Request count      : 0
Tx Vxlan ARP Reply count        : 0
Tx Vxlan Neighbor Solicitation count : 0
Tx Vxlan Neighbor Advertisement count: 0
```

[Table 1-9](#) explains the each network entry fields.

Table 1-9: show nvo vxlan counters network-port output fields

Field	Description
RX: packets	Number of hello packets received from neighbor.
RX: bytes	Number of hello packets received from neighbor in bytes received.

Table 1-9: show nvo vxlan counters network-port output fields (Continued)

Field	Description
TX: packets	Number of hello packets transmitted to neighbor.
TX: bytes	Number of hello packets transmitted to neighbor in bytes transmitted.
Tx VxLAN Arp discard count	Number of discarded Arp that is transmitted to peer.
Tx VxLAN Nd discard count	Number of discarded ND that is transmitted to peer.
Tx Vxlan Arp Request count	Number of request ARP that is transmitted to peer.
Tx Vxlan Arp Reply count	Number of replied ARP which is transmitted to peer.
Tx Vxlan Neighbor Solicitation count	Number of replied ND that is received from neighbor.
Tx Vxlan Neighbor Advertisement count	Number of Neighbor Advertisement which is transmitted to peer.

show evpn

Use this command to display the L3 VNI, L2 VNI and IRB interface mapping.

Command Syntax

```
show evpn l3vni-map
show evpn irb-status
```

Parameters

None

Command Mode

Exec mode

Applicability

This command was introduced before OcNOS version 4.1.

Example

```
rtr3#show evpn l3vni-map
L3VNI      L2VNI      IRB-interface
=====
45001      10         irb1
45001      20         irb2

rtr3#show evpn irb-status
IRB is ACTIVE in Hardware
```

show nvo vxlan mac-table

Use this command to display the host MAC address table. Use the hardware option to see the ageout time for the dynamically learn macs.

Command Syntax

```
show nvo vxlan mac-table (vnid <1-16777215>|) (summary | hardware |)
```

Parameters

<1-16777215>	VxLAN network identifier
summary	Display a count of MAC addresses
hardware	Display hardware information

Command Mode

Exec mode

Applicability

This command was introduced before OcNOS version 1.3.

Example

```
#show nvo vxlan mac-table
```

```
=====
VxLAN MAC Entries
=====
VNID      Interface  VlanId  Inner-VlanId  Mac-Addr      VTEP-Ip/ESI
Type                                           AccessPortDesc
-----
10        ce21/1     2        ----          0000.0000.1111 1.1.1.1
Static Local          -----          partner-port
10        ----      ----      ----          0000.0000.2222 3.3.3.3
Static Remote          -----
20        ce21/1     3        ----          0000.0000.cccc 1.1.1.1
Static Local          Discard
20        ----      ----      ----          0000.0000.dddd 3.3.3.3
Static Remote          -----
```

Total number of entries are : 4

```
#show nvo vxlan mac-table hardware
```

```
=====
VxLAN MAC Entries
=====
VNID      Interface  VlanId  Inner-VlanId  Mac-Addr      VTEP-Ip/ESI
Type                                           Time-out AccessPortDesc
-----
```

```

10          ce21/1      2      ---      0000.0000.1111 1.1.1.1
Static Local      -----      ---      partner-port
10          ---         ---     ---      0000.0000.2222 3.3.3.3
Dyanamic Remote  -----      ---
10          ---         ---     ---      0000.0000.aa11 3.3.3.3
Dyanamic Remote  -----      ---
10          ce21/1      2      ---      0000.0000.bb11 1.1.1.1
Dynamic Local    -----      300     partner-port
10          ce21/1      2      ---      0000.0000.bb12 1.1.1.1
Dynamic Local    -----      277     partner-port
20          ce21/1      ---     ---      0000.0000.cccc 1.1.1.1
Static Local      Discard      ---
20          ---         ---     ---      0000.0000.dddd 3.3.3.3
Dyanamic Remote  -----      ---

```

Total number of entries are 7

Table 1-10 explains the fields in the output.

Table 1-10: MAC table fields

Field	Description
VNID	VxLAN network identifier
Interface	Interface name
VlanId	VLAN identifier
Mac-Addr	MAC address
VTEP-Ip	VTEP identifier
Type	How a host learns a MAC/IP pair: Dynamic Remote: Learned by EVPN Type 2 (MAC/IP) routes Static Remote: Statically configured for remote; used only for static VxLAN, not with EVPN Static Local: Configured on local VTEP Dynamic Local: Learned by data plane source learning
Status	Max Move conflict: When a MAC has moved too many times (5 or more times in 180 seconds). This is according to the procedures defined in RFC 7432, Section 15.1. Discard: If a MAC hold time is configured, then if the VxLAN access port goes down (admin or operational), the MAC is moved to the discard state for the period of the hold time. The MAC is also moved to the discard state if the VNID is unmapped from the port. In dynamically learned cases, the MAC is also moved to discard when learning is disabled.
Time-out	Age timeout for dynamically learned MACs.
AccessPortDesc	Access port description.
Total number of entries	The total number of entries listed.

show nvo vxlan static host state

Use this command to display the state of the host which is configured statically.

Command Syntax

```
show nvo vxlan static host state
```

Parameters

None

Command Mode

Exec mode

Applicability

This command was introduced before OcNOS version 1.3.

Example

```
#show nvo vxlan static host state
VxLAN Static Host Information
```

```
=====
Codes: NW - Network Port
       AC - Access Port
       (u) - Untagged
```

VNID Addr	Ifname Status	Outer-Vlan	Inner-vlan	Ip-Addr	Mac-
10 0000.0000.2222	xe13 Active	10	---	12.12.12.2	
10 0000.0000.bbbb	xe17 Inactive	10	---	11.11.11.1	
10 0000.1111.2222	xe17 Inactive	30	40	0.0.0.0	

Total number of entries are 5

[Table 1-11](#) explains the output fields.

Table 1-11: Static host fields

Field	Description
VNID	VxLAN network identifier
Ifname	Interface name
Vlan	VLAN name
Ip-Addr	IP address

Table 1-11: Static host fields

Field	Description
Mac-Addr	MAC address
Status	<p>Status of the MAC/IP on the host:</p> <p>Conflict: When a MAC/IP was configured, the conflict was not known as the VNID was not mapped to the access port. After the VNID is mapped, if the same MAC/IP is present statically on some other port on the same VNID, then it is in conflict state.</p> <p>Learnt Conflict: When a MAC/IP was configured, the conflict was not known. However, it is now in conflict because the same MAC/IP is configured on an access port on VTEP1 and on an access port on VTEP2. Because the BGP session/tunnel was not up, the MAC/IP was not known to the other VTEP and the configuration was allowed. When the BGP session/tunnel comes up and it finds such a conflicted route, it marks the state as Learnt Conflict.</p> <p>Inactive: Configured but not operating, such as when the port is not mapped to any VNID. The port is down and the ARP/ND cache is disabled.</p> <p>Active: Operating host MAC/IP.</p>

show nvo vxlan tunnel

Use this command to view the source, destination, and status of the VXLAN tunnel entries.

Command Syntax

```
show nvo vxlan tunnel
```

Parameters

None

Command Mode

Exec mode

Applicability

This command was introduced before OcNOS version 1.3.

Example

The following is a sample output of the `show nvo vxlan tunnel` command.

```
#show nvo vxlan tunnel
VxLAN Network tunnel Entries
 Source Destination      Status Up/Down Update
=====
1.1.1.1 2.2.2.2      Installed 00:00:20 00:00:20
Total number of entries are 1
```

[Table 1-12](#) explains the output fields.

Table 1-12: VXLAN tunnel fields

Field	Description
Source	Tunnel source IP address.
Destination	Tunnel destination IP address.
Status	Installed: Tunnel Installed in the hardware and operating. Resolved: Tunnel destination IP is reachable, but VXLAN tunnel not installed in hardware. Therefore, not operating. Unresolved: Tunnel destination IP not reachable because L3 route is down.
Up/Down	When the tunnel came up or went down
Update	When the tunnel was last updated
Total number of entries	The total number of entries listed.

show nvo vxlan route-count

Use this command to display the VXLAN active route (MAC-IP and MAC-only) count information.

Command Syntax

```
show nvo vxlan route-count (|vniid <1-16777215>)
```

Parameters

<1-16777215> Range supported for VNID

Command Mode

Exec mode

Applicability

This command was introduced before OcNOS version 1.3 and modified to include the GW-IPv4, and Prefix IPv4 in OcNOS version 1.3.5.

Example

```
#show nvo vxlan route-count
VxLAN Active route count information
=====
Max route count      : 32768
Active route count: 0
```

```
-----
VNID      Total      MACONLY  MACIPv4  MACIPv6
-----
100       0           0         0         0
10        0           0         1         0
```

Total number of entries are 2

[Table 1-13](#) explains the output fields.

Table 1-13: show nvo vxlan route-count output details

Field	Description
Max route count	Maximum number of route count in vxlan.
Active route count	Number of active route count in the interface.
VNID	VNID is used to identify Layer 2 segments and to maintain Layer 2 isolation between the segments.
Total	Total number of entries for the interface.
MACONLY	The MAC-only route for the local interface appears in the VxLAN instance route table.
MACIPv4	IPv4 media access control (MAC) address for a default virtual gateway.
MACIPv6	IPv6 media access control (MAC) address for a default virtual gateway.

show nvo vxlan vni-name

Use this command to display the vxlan results based on vni-name.

Command Syntax

```
show nvo vxlan vni-name (WORD)
```

Parameters

WORD VxLAN id name

Command Mode

Exec mode

Applicability

This command was introduced before OcnOS version 1.3.

Example

```
#show nvo vxlan vni-name SITEA-PRO
VxLAN Information
=====
Codes: NW - Network Port
AC - Access Port
(u) - Untagged
VNID Vni-name Type Interface ESI Vlan DF-Status Src-addr Dst-addr
-----
1 ---- NW ---- ----- - - - - - - - - 10.0.1.1 10.0.6.8
1 ---- NW ---- ----- - - - - - - - - 10.0.1.1 10.0.6.9
1 ---- NW ---- ----- - - - - - - - - 10.0.1.1 10.0.3.1
1 ---- NW ---- ----- - - - - - - - - 10.0.1.1 10.0.1.2
1 ---- NW ---- ----- - - - - - - - - 10.0.1.1 10.0.5.1
1 ---- NW ---- ----- - - - - - - - - 10.0.1.1 10.0.2.2
1 ---- NW ---- ----- - - - - - - - - 10.0.1.1 10.0.2.1
1 SITEA-PRO AC xe7 - Single Hommed port - 2 ----- - - - - - - - -
1 SITEA-PRO AC xe1 - Single Hommed port - 1010 ----- - - - - - - - -
1 SITEA-PRO AC xe1 - Single Hommed port - 100 ----- - - - - - - - -
1 SITEA-PRO AC xe1 - Single Hommed port - 2020 ----- - - - - - - - -
1 SITEA-PRO AC po1 - Single Hommed port - 100 ----- - - - - - - - -
1 SITEA-PRO AC po1 - Single Hommed port - 2 ----- - - - - - - - -
1 SITEA-PRO AC po1 - Single Hommed port - 200 ----- - - - - - - - -
1 SITEA-PRO AC xe8 - Single Hommed port - ----- - - - - - - - -
1 SITEA-PRO AC po2 - Single Hommed port - ----- - - - - - - - -
Total number of entries are 16
```

show nvo vxlan xconnect

Use this command to display the VPWS xconnect details of the MTU, AC-NW connections, and network status.

Command Syntax

```
show nvo vxlan xconnect
```

Parameters

None

Command Mode

Exec mode

Applicability

This command was introduced in OcNOS version 5.1.

Example

```
MH-VTEP3#sh nvo vxlan xconnect
EVPN Xconnect Info
=====
AC-AC: Local-Cross-connect
AC-NW: Cross-connect to Network
AC-UP: Access-port is up
AC-DN: Access-port is down
NW-UP: Network is up
NW-DN: Network is down
NW-SET: Network and AC both are up

Local                Remote      Connection-Details
=====
VPN-ID      EVI-Name    MTU  VPN-ID  Source      Destination      PE-IP      MTU  Type  NW-Status
=====
92          ----      1500  91      xe2 92      --- Single Homed Port ---  102.1.1.1  1500  AC-NW  NW-SET
94          ----      1500  93      xe2 94      --- Single Homed Port ---  102.1.1.1  1500  AC-NW  NW-SET
38052       ----      1500  38051   xe2 380 716  00:11:22:33:00:00:00:55:66:77  101.1.1.1  1500  AC-NW  NW-SET
                                                    102.1.1.1  1500  ----  ----
39012       ----      1500  39011   xe2 390 715  00:00:00:12:34:90:90:00:00:00  101.1.1.1  1500  AC-NW  NW-SET
                                                    102.1.1.1  1500  ----  ----

Total number of entries are 4
```

[Table 1-14](#) explains the output fields.

Table 1-14: show nvo vxlan xconnect fields

Field	Description
Local VPN-ID	Source VPWS ID
Local EVI-Name	EVI name of the local VPWS ID
Local MTU	Local MTU
Remote VPN-ID	Remote (target) VPWS ID
Source	Source AC port

Table 1-14: show nvo vxlan xconnect fields (Continued)

Field	Description
Destination	Destination AC port: "Single Homed Port" or ESI value if it is multi-homed port
PE-IP	IP Address of the provider edge.
MTU	Remote MTU
Type	Connection details of the AC port
NW-Status	Connection details of the NW port
Total number of entries	Total number of entries listed.

show running-config interface irb

Use this command to display the current running configuration of IRB interface.

Command Syntax

```
show running-config interface irb<1-4094>
```

Parameters

None

Command Mode

Exec mode

Applicability

This command was introduced in a version before OcNOS version 4.1.

Example

```
#show running-config interface irb1
!  
  interface irb1  
    ip vrf forwarding vrfip  
    ip address 144.144.144.1/24  
    ipv6 address 1201::1/48  
    evpn irb-if-forwarding anycast-gateway-mac  
    shutdown  
  !
```

show running-config nvo vxlan

Use this command to display the current running configuration of VXLANs.

Command Syntax

```
show running-config nvo vxlan
```

Parameters

None

Command Mode

Exec mode

Applicability

This command was introduced in a version before OcNOS version 1.3; `nvo vxlan id xconnect` was introduced in OcNOS version 5.1.

Example

```
#sh running-config nvo vxlan
!
evpn vxlan multihoming enable
!
evpn esi hold-time 100
!
nvo vxlan enable
!
nvo vxlan irb
!
evpn irb-forwarding anycast-gateway-mac 0000.0000.ff10
!
nvo vxlan vtep-ip-global 2.2.2.2
!
nvo vxlan mac-ageing-time 10
!
nvo vxlan id 10 ingress-replication inner-vid-disabled
vxlan host-reachability-protocol evpn-bgp vrfred
evpn irbl
!
nvo vxlan id 100 xconnect target-vxlan-id 200
vxlan host-reachability-protocol evpn-bgp vrfblue
!
nvo vxlan access-if port-vlan xe13 10
no shutdown
map vnid 10
mac 0000.0000.2222 ip 12.12.12.2
!
nvo vxlan access-if port-vlan xe17 10
no shutdown
map vnid 10
mac 0000.0000.bbbb ip 11.11.11.1
!
nvo vxlan access-if port-vlan xe17 30
```

```
no shutdown
map vniid 10
mac 0000.1111.2222
!
nvo vxlan access-if port-vlan xe1 11
description member-port xe1 with vlan 11
no shutdown
map vniid 10
!
nvo vxlan access-if port-vlan xe1 10
no shutdown
map vniid 10
!
nvo vxlan access-if port-vlan xe1 12
no shutdown
map vniid 10
!
nvo vxlan access-if port-vlan xe9 100
no shutdown
map vniid 100
!
```

shutdown

Use this command to administratively shut down an NVO access interface.

Use the `no` form of this command to start an NVO access interface.

Command Syntax

```
shutdown
no shutdown
```

Parameters

None

Default

The NVO access interface is running by default.

Command Mode

NVO access interface mode

Applicability

This command was introduced before OcNOS version 1.3.

Example

```
#configure terminal
(config)#nvo vxlan access-if port-vlan xel 2
(config-nvo-acc-if)#shutdown
(config-nvo-acc-if)#exit
```

vxlan host-reachability-protocol evpn-bgp

Use this command to set the host reachable protocol to Ethernet-VPN over BGP. This defines BGP as the mechanism for host reachability advertisement.

Use the no form of this command to remove Ethernet-VPN as the host reachable protocol.

Command Syntax

```
vxlan host-reachability-protocol evpn-bgp NAME
no vxlan host-reachability-protocol evpn-bgp
```

Parameters

NAME	Name of the VRF to carry VNID routes
------	--------------------------------------

Command Mode

NVO mode

Applicability

This command was introduced before OcnOS version 1.3.

Example

```
(config)#nvo vxlan id 3 ingress-replication inner-vid-disabled
(config-nvo)#vxlan host-reachability-protocol evpn-bgp Blue
```

CHAPTER 2 VXLAN Quality of Service Commands

This chapter describes the VXLAN commands for Quality of Service (QoS):

- `clear nvo vxlan tunnels`
- `cos queue`
- `dscp queue`
- `I2 queue dscp`
- `I3 dscp dscpEncap`
- `map qos-profile`
- `map qos-profile cos-to-queue`
- `map qos-profile queue-color-to-cos`
- `nvo vxlan tunnel qos-map-mode cos-dscp`
- `qos profile cos-to-queue`
- `qos profile dscp-encap`
- `qos profile dscp-to-queue`
- `qos profile queue-color-to-cos`
- `qos profile queue-color-to-dscp`
- `queue cos`
- `queue dscp`
- `show qos-profile type dscp-encap`
- `show running-config interface irb`

clear nvo vxlan tunnels

Use this command to clear the nvo vxlan tunnels to re-establish the tunnel after mapping/un-mapping the QoS profile to vxlan tunnel.

Command Syntax

```
clear nvo vxlan tunnels dst-ip A.B.C.D
```

Parameters

dst-ip	VxLAN tunnel destination
A.B.C.D	destination IPv4 address

Command Mode

Exec mode

Applicability

This command was introduced in OcNOS version 3.0.

Example

```
#clear nvo vxlan tunnels dst-ip 2.2.2.2
```

cos queue

Use this command to configure user defined mapping for Class of Service (CoS) values and output queues.

Use the `no` form of this command to remove the mapping.

Command Syntax

```
cos <0-7> queue <0-7>
no cos <0-7>
```

Parameters

<code>cos <0-7></code>	Sets the CoS value, ranging from 0 to 7, which prioritizes traffic based on its importance.
<code>queue <0-7></code>	Determines the output queue, ranging from 0 to 7, where matched traffic is directed.

Default

If the mapping between CoS and queue values is not configured, it follows a one-to-one mapping.

Command Mode

Ingress CoS Map mode

Applicability

Introduced in OcNOS version 3.0.

Example

```
OcNOS(config)#qos profile cos-to-queue ac_port_ingress
OcNOS(config-ingress-cos-map)#cos 1 queue 7
OcNOS(config-ingress-cos-map)#no cos 1
```

dscp queue

Use this command to configure user defined mapping for DSCP to queue. This will be mapped with nvo VxLAN tunnel of remote VTEP.

Use the `no` form of this command to delete the mapping.

Command Syntax

```
dscp <0-63> queue <0-7> (color (green|yellow|red)|) (dscp <0-63>|)
no dscp <0-63>
```

Parameters

<0-63>	DSCP
<0-7>	Queue number
color	Color to map
green	Set mapping for green packets
red	Set mapping for red packets
yellow	Set mapping for yellow packets
<0-63>	out DSCP value

Default

Default queue and cos value is one-one default mapping if it is not configured.

Command Mode

Ingress-dscp-map mode

Applicability

This command was introduced in OcNOS version 3.0.

Example

```
(config)#qos profile dscp-to-queue nw_profile
(config-ingress-dscp-map)#dscp 50 queue 1
(config-ingress-dscp-map)#no dscp 50
```

I2 queue dscp

Use this command to configure or update user defined mapping for queue to dscp for egress L2 Traffic over VxLAN tunnel.

Use the `no` form of this command to delete the mapping.

Command Syntax

```
12 queue <0-7> (color (green|yellow|red|all)|) dscp <0-63>
no 12 queue <0-7> (color (green|yellow|red|all)|)
```

Parameters

<0-7>	Queue values
<0-63>	Select DSCP value
color	Color to map
all	Set mapping for all packets
green	Set mapping for green packets
red	Set mapping for red packets
yellow	Set mapping for yellow packets

Default

Default queue and dscp value is one-one default mapping if it is not configured.

Command Mode

egress-dscp-encap-map mode

Applicability

This command was introduced in OcNOS version 4.2.

Example

```
#configure terminal
(config)#qos profile dscp-encap DSCP_ENCP
(config-egress-dscp-encap-map)#12 queue 1 dscp 32
(config-egress-dscp-encap-map)#12 queue 5 color green dscp 16
(config-egress-dscp-encap-map)#no 12 queue 1
```

I3 dscp dscpEncap

Use this command to configure or update user defined mapping for dscp to dscp for egress L3 Traffic over VxLAN tunnel.

Use the `no` form of this command to delete the mapping.

Command Syntax

```
13 dscp <0-63> dscpEncap <0-63>
no 13 dscp <0-63>
```

Parameters

<0-63> DSCP values

Default

Default dscp and dscp encap value is one-one default mapping if it is not configured.

Command Mode

egress-dscp-encap-map mode

Applicability

This command was introduced in OcNOS version 4.2.

Example

```
#configure terminal
(config)#qos profile dscp-encap DSCP_ENCP
(config-egress-dscp-encap-map)#13 dscp 10 dscpEncap 48
(config-egress-dscp-encap-map)#no 13 dscp 10
```

map qos-profile

Use this command to map (attach) the qos profile to an IRB interface.

Use the `no` form of this command to remove a profile.

We can map the following qos profile type on IRB interface.

- dscp-to-queue for ingress traffic and
- dscp-to-dscp profile for egress traffic

from/to the IRB interface.

On doing `no map qos-profile`, default profile is applied to the IRB interface.

In order for `dscp-to-dscp` - qos profile type to be effective on L3 IRB interface , "qos remark dscp" is enabled globally.

Note: Default profile is applied to all the IRB interface only when qos is enabled.

Command Syntax

```
map qos-profile (dscp-to-dscp | dscp-to-queue) <NAME>
no map qos-profile (dscp-to-dscp | dscp-to-queue) <NAME>
```

Parameters

NAME	Profile name
------	--------------

Default

By default, the default `dscp-to-queue` and `dscp-to-dscp` profile is attached to all IRB interface and if user changes the value in the default profile, it will affect to all the IRB interfaces and L3 interfaces.

Command Mode

IRB_IF_Mode

Default

Default queue and cos value is one-one default mapping if it is not configured.

Applicability

This command was introduced in OcNOS version 4.2.

Example

```
#configure terminal
(config)#interface irb 1
(config-irb-if)# map qos-profile dscp-to-dscp DSCP_DSCP
(config-irb-if)# no map qos-profile dscp-to-dscp DSCP_DSCP

(config)#interface irb 1
(config-irb-if)# map qos-profile dscp-to-queue DSCP_QUE
(config-irb-if)# no map qos-profile dscp-to-queue DSCP_QUE
```

map qos-profile cos-to-queue

Use this command to map the cos-to-queue profile to vxlan access port on the local VTEP.

Use the `no` form of the command to remove the mapping.

Command Syntax

```
map qos-profile cos-to-queue NAME
no map qos-profile cos-to-queue NAME
```

Parameters

NAME	Profile name
------	--------------

Default

None

Command Mode

NVO access interface mode

Applicability

This command was introduced before OcNOS version 3.0.

Example

```
(config)#nvo vxlan access-if port-vlan xel 10
(config-nvo-acc-if)#map qos-profile cos-to-queue ac_port_ingress
(config-nvo-acc-if)#no map qos-profile cos-to-queue ac_port_ingress
```

map qos-profile queue-color-to-cos

Use this command to map the queue-color-to-cos profile to vxlan access port on the remote VTEP.

Use the `no` form of the command to remove the mapping.

Command Syntax

```
map qos-profile queue-color-to-cos NAME
no map qos-profile queue-color-to-cos NAME
```

Parameters

NAME	Profile name
------	--------------

Default

None

Command Mode

NVO access interface mode

Applicability

This command was introduced before OcNOS version 3.0.

Example

```
(config)#nvo vxlan access-if port-vlan xe2 10
(config-nvo-acc-if)#map qos-profile queue-color-to-cos ac_profile
(config-nvo-acc-if)#no map qos-profile queue-color-to-cos ac_profile
```

nvo vxlan tunnel qos-map-mode cos-dscp

Use this command to map QoS profile for network side to nvo vxlan tunnel. For outgoing/incoming traffic, you need to provide the direction with the keyword `egress/ingress`.

Use the `no` form of this command to delete the mapping.

You must give the [clear nvo vxlan tunnels](#) command to do the network port setting for QoS profile mapped.

Command Syntax

```
nvo vxlan tunnel qos-map-mode cos-dscp (ingress|egress) NAME
no nvo vxlan tunnel qos-map-mode cos-dscp (ingress|egress)
```

Parameters

NAME	Profile name
ingress	Ingress direction
egress	Egress direction

Command Mode

Configure mode

Applicability

This command was introduced in OcNOS version 3.0.

Example

```
(config)#nvo vxlan tunnel qos-map-mode cos-dscp egress nw_profile
(config)#no nvo vxlan tunnel qos-map-mode cos-dscp egress
(config)#nvo vxlan tunnel qos-map-mode cos-dscp ingress nw_profile
(config)#no nvo vxlan tunnel qos-map-mode cos-dscp ingress
```

qos profile cos-to-queue

Use this command to configure cos-to-queue profile. This profile has to be mapped to VxLAN access port on the local VTEP.

Use the `no` form of this command to delete the qos profile.

Command Syntax

```
qos profile cos-to-queue (NAME|default)
no qos profile cos-to-queue NAME
```

Parameters

NAME	QoS profile name for cos-to-queue
default	Default name

Command Mode

Configure mode

Applicability

This command was introduced in OcNOS version 3.0.

Example

```
(config)#qos profile cos-to-queue ac_port_ingress
(config)#no qos profile cos-to-queue ac_port_ingress
```

qos profile dscp-encap

Use this command to create new profiles or to update "default" profiles for dscp-dscpEncap and Queue to DSCP value.

Use the `no` form of this command to remove the profiles.

Note: "default" profiles can only be updated and not be deleted. User can create/delete user-defined profiles.

Note: Use this command to configure QoS profile for both VxLAN L2 and VxLAN L3 traffic.

Note: This profile will be mapped to `nvo vxlan tunnel` at the egress direction of the VTEP.

Note: Default QoS profile `dscp-encap` would take preference than default qos profile `queue-color-to dscp` when no user-defined qos profile is configured on the `nvo vxlan tunnel` mode.

Command Syntax

```
qos profile dscp-encap (NAME | default)
no qos profile dscp-encap NAME
```

Parameters

NAME	Profile name
default	update global mapping profile

Command Mode

Configure mode

Applicability

This command was introduced in OcNOS version 4.2.

Example

```
#configure terminal
(config)#qos profile dscp-encap DSCP_ENCP
(config)#no qos profile dscp-encap DSCP_ENCP
```

qos profile dscp-to-queue

Use this command to configure QoS profile for DSCP to Queue mapping. This profile will be mapped to nvo vxlan tunnel of remote VTEP. The created profile will support remarking of the data packets.

Use the `no` form of this command to delete the QoS profile

Command Syntax

```
qos profile dscp-to-queue (NAME|default)
no qos profile dscp-to-queue NAME
```

Parameters

NAME	Profile name
default	Default name

Command Mode

Configure mode

Applicability

This command was introduced in OcNOS version 3.0.

Example

```
(config)#qos profile dscp-to-queue nw_profile
(config-ingress-dscp-map)#exit
(config)#no qos profile dscp-to-queue nw_profile
(config)#
```

qos profile queue-color-to-cos

Use this command to configure queue-color-to-cos profile. This profile has to be mapped to VxLAN access port on remote VTEP.

Use the `no` form of this command to delete the qos profile.

Command Syntax

```
qos profile queue-color-to-cos (NAME|default)
no qos profile queue-color-to-cos NAME
```

Parameters

NAME	Profile name
default	Default name

Command Mode

Configure mode

Applicability

This command was introduced in OcNOS version 3.0.

Example

```
(config)#qos profile queue-color-to-cos ac_profile
(config)#no qos profile queue-color-to-cos ac_profile
```

qos profile queue-color-to-dscp

Use this command to create a QoS profile queue-color-to-dscp. This profile will be mapped to nvo vxlan tunnel of local VTEP. The created profile supports remarking of the data packets.

Note: The profile name of "default" is not supported for VxLAN QoS.

Use the `no` form of this command to delete the profile.

Command Syntax

```
qos profile queue-color-to-dscp (NAME|default)
no qos profile queue-color-to-dscp NAME
```

Parameters

NAME	Profile name
default	Default name

Default

None

Command Mode

Configure mode

Applicability

This command was introduced in OcNOS version 3.0.

Example

```
(config)#qos profile queue-color-to-dscp nw_profile
(config-egress-dscp-map)#exit
(config)#no qos profile queue-color-to-dscp nw_profile
```

queue cos

Use this command to configure user defined mapping for queue and cos.

Use the no form of this command to remove the mapping.

Command Syntax

```
queue <0-7> (color (green|yellow|red|all)|) cos <0-7>
no queue <0-7> (color(green|yellow|red|all)|)
```

Parameters

<0-7>	Queue and cos range
color	Color to map
all	Set mapping for all packets
green	Set mapping for green packets
red	Set mapping for red packets
yellow	Set mapping for yellow packets

Default

Default queue and cos value is one-one default mapping if it is not configured.

Command Mode

QoS config mode

Applicability

This command was introduced in OcNOS version 3.0.

Example

```
(config)#qos profile queue-color-to-cos ac_profile
(config-egress-cos-map)#queue 5 cos 2
(config-egress-cos-map)#no queue 5
```

queue dscp

Use this command to configure user-defined mapping for queue to DSCP. This will be mapped with nvo VxLAN tunnel of local VTEP.

Use the `no` form of this command to remove the queue-to-DSCP mapping.

Command Syntax

```
queue <0-7> (color (green|yellow|red|all)|) dscp <0-63>
no queue <0-7> (color (green|yellow|red|all)|)
```

Parameters

<0-7>	Queue number
<0-63>	DSCP
color	Color to map
all	Set mapping for all packets
green	Set mapping for green packets
red	Set mapping for red packets
yellow	Set mapping for yellow packets

Default

Default queue and cos value is one-one default mapping if it is not configured.

Command Mode

QoS config mode

Applicability

This command was introduced in OcNOS version 3.0.

Example

```
(config)#qos profile queue-color-to-dscp nw_profile
(config-egress-dscp-map)# queue 1 dscp 63
(config-egress-dscp-map)#no queue 1
```

show qos-profile type dscp-encap

Use this command to show all the default and configured QoS profiles configurations.

Command Syntax

```
show qos-profile type dscp-encap (| NAME)
```

Parameters

NAME Profile name

Command Mode

Exec Mode.

Applicability

This command was introduced in OcNOS version 4.2.

Example

```
VTEP1#show qos-profile type dscp-encap
```

```
profile name: default
```

```
profile type: dscp-encap
```

```
configured mapping:
```

```
Detailed mapping:
```

```
L3 DSCP to DSCP-ENCAP
```

INPUT	OUTPUT	INPUT	OUTPUT	INPUT	OUTPUT	INPUT	OUTPUT
DSCP	DSCP	DSCP	DSCP	DSCP	DSCP	DSCP	DSCP
0	0	16	16	32	32	48	48
1	1	17	17	33	33	49	49
2	2	18	18	34	34	50	50
3	3	19	19	35	35	51	51
4	4	20	20	36	36	52	52
5	5	21	21	37	37	53	53
6	6	22	22	38	38	54	54
7	7	23	23	39	39	55	55
8	8	24	24	40	40	56	56
9	9	25	25	41	41	57	57
10	10	26	26	42	42	58	58
11	11	27	27	43	43	59	59
12	12	28	28	44	44	60	60
13	13	29	29	45	45	61	61
14	14	30	30	46	46	62	62
15	15	31	31	47	47	63	63

```
L2 Queue + Color to DSCP-ENCAP
```

INPUT	OUTPUT	INPUT	OUTPUT	INPUT	OUTPUT
Queue	Color	DSCP	Queue	Color	DSCP
0	green	0	0	yellow	0
				red	0

1	green	8		1	yellow	8		1	red	8
2	green	16		2	yellow	16		2	red	16
3	green	24		3	yellow	24		3	red	24
4	green	32		4	yellow	32		4	red	32
5	green	40		5	yellow	40		5	red	40
6	green	48		6	yellow	48		6	red	48
7	green	56		7	yellow	56		7	red	56

profile name: DSCP_ENCAP
 profile type: dscp-encap
 profile attached to 0 instances
 configured mapping:

13 dscp 16 dscpEncap 24
 12 queue 3 color all dscp 40

Detailed mapping:

L3 DSCP to DSCP-ENCAP

INPUT	OUTPUT	INPUT	OUTPUT	INPUT	OUTPUT	INPUT	OUTPUT
DSCP	DSCP	DSCP	DSCP	DSCP	DSCP	DSCP	DSCP
0	0	16	24	32	32	48	48
1	1	17	17	33	33	49	49
2	2	18	18	34	34	50	50
3	3	19	19	35	35	51	51
4	4	20	20	36	36	52	52
5	5	21	21	37	37	53	53
6	6	22	22	38	38	54	54
7	7	23	23	39	39	55	55
8	8	24	24	40	40	56	56
9	9	25	25	41	41	57	57
10	10	26	26	42	42	58	58
11	11	27	27	43	43	59	59
12	12	28	28	44	44	60	60
13	13	29	29	45	45	61	61
14	14	30	30	46	46	62	62
15	15	31	31	47	47	63	63

L2 Queue + Color to DSCP-ENCAP

INPUT	OUTPUT	INPUT	OUTPUT	INPUT	OUTPUT
Queue	Color	DSCP	Queue	Color	DSCP
0	green	0	0	yellow	0
1	green	8	1	yellow	8
2	green	16	2	yellow	16
3	green	40	3	yellow	40
4	green	32	4	yellow	32
5	green	40	5	yellow	40
6	green	48	6	yellow	48
7	green	56	7	yellow	56

VTEP1#

show running-config interface irb

Use this command to display the current QoS running configuration of IRB interface.

Command Syntax

```
show running-config interface irb<1-4094>
```

Parameters

None

Command Mode

Exec Mode.

Applicability

This command was introduced in OcNOS version 4.2.

Example

```
VTEP1#sh run int irb1010
!
interface irb1010
 ip vrf forwarding FAX
 ip address 10.210.32.1/24
 ipv6 address 3001:ab8:1::1/64
 qos map-profile dscp-to-queue DSCP_QUE
 qos map-profile dscp-to-dscp DSCP_DSCP
!
```

Index

A

arp-cache disable 452, 455
arp-nd flood-suppress 453, 455, 534

B

begin modifier 15
BGP community value
 command syntax 13
braces
 command syntax 12

C

clear nvo vxlan counters 456, 532
command abbreviations 11
command completion 11
command line
 errors 11
 help 10
 keyboard operations 14
command modes 18
 configure 18
 exec 18
 interface 18
 privileged exec 18
 router 18
command negation 12
command syntax
 ? 13
 . 13
 () 12
 {} 12
 | 12
 A.B.C.D/M 13
 AA:NN 13
 BGP community value 13
 braces 12
 conventions 12
 curly brackets 12
 HH:MM:SS 13
 IFNAME 13
 interface name 13
 IPv4 address 13
 IPv6 address 13
 LINE 13
 lowercase 12
 MAC address 13
 monospaced font 12
 numeric range 13
 parentheses 12
 parenteses 12
 period 13
 question mark 13

square brackets 13
time 13
uppercase 12
variable placeholders 13
vertical bars 12
WORD 13
X:X::X:X 13
X:X::X:X/M 13
XX:XX:XX:XX:XX:XX 13
configure mode 18
curly brackets
 command syntax 12

D

dynamic-learning disable 459, 465, 521

E

encapsulation 22
evpn multi-homing enable 466, 528
exec command mode 18

I

IFNAME 13
interface mode 18
IPv4 address
 command syntax 13
IPv6 address
 command syntax 13

L

LAN segments 22
LINE 13
link Monitoring
 validation 338

M

mac 476
MAC address
 command syntax 13
MAC addresses 22
mac vrf 477
mac-holdtime 477, 478
map vnid 479

N

nd-cache disable 501
nvo vxlan 481
nvo vxlan access-if 482
nvo vxlan id 484
nvo vxlan mac-ageing-time 508
nvo vxlan vtep-ip-global 488

-
- P**
- parentheses
 - command syntax 12
 - parentheses
 - command syntax 12
 - period
 - command syntax 13
 - port breakout configuration 383
 - Port Mapping 24
 - privileged exec mode 18
- Q**
- question mark
 - command syntax 13
- R**
- remote failure detection 358
 - router mode 18
- S**
- show bgp l2vpn evpn 489
 - show bgp l2vpn evpn summary 493
 - show commands 15
 - exclude modifier 16
 - include modifier 16
 - redirect modifier 17
 - show nvo vxlan 498
 - show nvo vxlan arp-cache 500
 - show nvo vxlan counters access-port 501
 - show nvo vxlan counters network-port 503
 - show nvo vxlan mac-table 506
 - show nvo vxlan nd-cache 508
 - show nvo vxlan static host state 508
 - show nvo vxlan tunnel 510
 - shutdown 477, 518
 - square brackets
 - command syntax 13
- T**
- tenant 22
 - time
 - command syntax 13
 - Tunnel End Point 22
- U**
- unicast configuration 24
- V**
- validation 358
 - vertical bars
 - command syntax 12
 - Virtual eXtensible Local Area Network (VXLAN) 22
 - VXLAN Architecture 22
 - VXLAN Commands 449, 520
 - vxlan host-reachability-protocol evpn-bgp 519
 - VXLAN Network Identifier (VNI) 22
 - VXLAN Tunnel EndPoints 22
 - VXLAN Unicast Configuration 24
- W**
- WORD 13