



**OcNOS®**

**Open Compute  
Network Operating System  
for Service Providers  
Version 6.3.5**

**System Management Guide**

**June 2024**

---

© 2024 IP Infusion Inc. All Rights Reserved.

This documentation is subject to change without notice. The software described in this document and this documentation are furnished under a license agreement or nondisclosure agreement. The software and documentation may be used or copied only in accordance with the terms of the applicable agreement. No part of this publication may be reproduced, stored in a retrieval system, or transmitted in any form or any means electronic or mechanical, including photocopying and recording for any purpose other than the purchaser's internal use without the written permission of IP Infusion Inc.

IP Infusion Inc.

3965 Freedom Circle, Suite 200

Santa Clara, CA 95054

+1 408-400-1900

<http://www.ipinfusion.com/>

For support, questions, or comments via E-mail, contact:

[support@ipinfusion.com](mailto:support@ipinfusion.com)

Trademarks:

IP Infusion and OcNOS are trademarks or registered trademarks of IP Infusion. All other trademarks, service marks, registered trademarks, or registered service marks are the property of their respective owners.

Use of certain software included in this equipment is subject to the IP Infusion, Inc. End User License Agreement at <http://www.ipinfusion.com/license>. By using the equipment, you accept the terms of the End User License Agreement.

# Contents

<b>Preface</b> .....	<b>xxv</b>
IP Maestro Support .....	xxv
Audience .....	xxv
Conventions .....	xxv
Chapter Organization .....	xxv
Related Documentation .....	xxv
Feature Availability .....	xxvi
Migration Guide .....	xxvi
Support .....	xxvi
Comments .....	xxvi
<b>Command Line Interface</b> .....	<b>25</b>
Overview .....	25
Command Line Interface Help .....	25
Command Completion .....	26
Command Abbreviations .....	26
Command Line Errors .....	26
Command Negation .....	27
Syntax Conventions .....	27
Variable Placeholders .....	28
Command Description Format .....	29
Keyboard Operations .....	29
Show Command Modifiers .....	30
String Parameters .....	33
Command Modes .....	33
Transaction-based Command-line Interface .....	35
<b>System Management Configuration Guide</b> .....	<b>37</b>
CHAPTER 1 Using the Management Interface .....	39
Overview .....	39
Management Port .....	39
In-Band Ports .....	40
CHAPTER 2 User Configuration .....	43
Overview .....	43
CHAPTER 3 Telnet Configuration .....	45
Overview .....	45
Telnet Configuration with IPv4 Address .....	45
Telnet Configuration with IPv6 Address .....	46
CHAPTER 4 SSH Client Server Configuration .....	49
Overview .....	49
SSH Configuration .....	49
SSH Encryption Cipher .....	52

SSH Key-Based Authentication .....	53
CHAPTER 5 DHCP Client Configuration .....	59
Overview .....	59
DHCP Client Configuration for IPv4 .....	59
DHCP Client Configuration for IPv6 .....	60
CHAPTER 6 DHCP Relay Agent Configuration .....	63
Overview .....	63
DHCP Relay for IPv4 .....	63
DHCP Relay for IPv6 Configuration .....	64
DHCP Relay option 82 .....	65
Physical Interface Configuration with non-default VRF .....	68
DHCP-Relay with different VRFs .....	73
DHCP Relay for IPv6 Configuration with different VRFs .....	75
CHAPTER 7 DHCP Relay Agent Over L3VPN Configuration .....	77
DHCP Relay Over L3 VPN for IPv4 .....	77
CHAPTER 8 DHCPv6 Prefix Delegation Configuration .....	89
Overview .....	89
Topology .....	90
CHAPTER 9 DHCPv6 Relay Prefix Delegation Route Injection Configuration ...	95
Overview .....	95
Topology .....	95
CHAPTER 10 DHCP Snooping .....	101
Overview .....	101
Topology .....	101
DHCP Snooping Operation .....	104
CHAPTER 11 DHCP Snooping IP Source Guard .....	107
Overview .....	107
Topology .....	107
CHAPTER 12 DHCP Server Configuration .....	113
Overview .....	113
DHCP Server Configuration for IPv4 .....	113
DHCP Server Configuration for IPv6 .....	116
CHAPTER 13 Dynamic ARP Inspection .....	119
Overview .....	119
Topology .....	119
CHAPTER 14 Proxy ARP and Local Proxy ARP .....	123
Overview .....	123
Local Proxy ARP Overview .....	125
CHAPTER 15 DNS Configuration .....	129
Overview .....	129
CHAPTER 16 DNS Relay Configuration .....	133
Topology .....	133

---

Linux Configuration on the DNS client .....	133
Linux Configuration on the DNS server.....	133
OcNOS Configuration .....	134
Validation.....	134
<b>CHAPTER 17 NTP Client Configuration.....</b>	<b>137</b>
Overview .....	137
NTP Modes .....	137
NTP Client Configuration with IPv4 Address .....	138
NTP Client Configuration with IPv6 Address .....	140
<b>CHAPTER 18 NTP Server Configuration .....</b>	<b>143</b>
Topology .....	143
Configuration.....	143
Synchronization of more than one NTP clients with the NTP Master.....	144
Topology .....	144
Configuration.....	145
Synchronization with Authentication .....	146
Topology .....	147
Configuration.....	147
Synchronization of NTP Server and NTP Clients with NTP ACL .....	149
Topology .....	149
Configuration.....	150
Synchronization of NTP Server and NTP Clients with NTP ACL configured as noserve 152	
Synchronization of NTP Client with Stratum 2 NTP Master.....	154
Topology .....	154
Configuration.....	155
<b>CHAPTER 19 TACACS Client Configuration .....</b>	<b>157</b>
Overview .....	157
TACACS Server Authentication .....	157
TACACS Server Accounting.....	168
TACACS Server Authorization .....	170
<b>CHAPTER 20 RADIUS Client Configuration .....</b>	<b>173</b>
Overview .....	173
RADIUS Server Authentication .....	173
RADIUS Server Accounting .....	180
Sample Radius Clients.conf File .....	181
Sample Radius Users Configuration File .....	182
<b>CHAPTER 21 Simple Network Management Protocol .....</b>	<b>183</b>
Overview .....	183
Topology .....	183
SNMP Trap Server Configuration with IPv6 Address .....	185
<b>CHAPTER 22 Access Control Lists Configurations .....</b>	<b>189</b>
Overview .....	189
Topology .....	189

---

IPv4 ACL Configuration .....	189
ICMP ACL Configuration .....	190
Access List Entry Sequence Numbering .....	191
IPv6 ACL Configuration .....	192
IPv6 ACL Configuration for 128-Bit Support .....	193
MAC ACL Configuration .....	195
Management ACL Overview .....	196
ARP ACL Overview .....	201
ACL over Loopback .....	201
ACL OVER Virtual Terminal (VTY) .....	203
Timed ACL Configuration .....	205
Topology .....	205
CHAPTER 23 Syslog Configuration .....	209
Overview .....	209
Syslog Configuration with IPv4 Address .....	209
Syslog Configuration with IPv6 Address .....	213
CHAPTER 24 Custom Syslog Port Configuration .....	215
Overview .....	215
Custom Syslog Configuration with IPv4 Address .....	215
Custom Syslog Configuration with IPv6 Address .....	218
Custom Syslog Configuration with HOSTNAME .....	220
CHAPTER 25 sFlow Configuration .....	223
Configuration .....	224
CHAPTER 26 Trigger Failover Configuration .....	225
Basic Configuration .....	225
Port-Channel Configuration .....	226
CHAPTER 27 Show Tech Support Configurations .....	229
Overview .....	229
Tech Support Samples .....	229
CHAPTER 28 Software Monitoring and Reporting .....	231
Overview .....	231
CHAPTER 29 Control Plane Policing Configuration .....	233
CHAPTER 30 Internet Protocol SLA Configuration .....	237
Configuration .....	237
Validation .....	238
CHAPTER 31 Link Detection Debounce Timer .....	241
Log Messages .....	242
CHAPTER 32 Max Session and Session Limit Configuration .....	245
Overview .....	245
Configuration of SSH Server Session Limit Lesser than Max-Session .....	246
Configuration of Telnet Session Limit Greater than Max-Session .....	247
Configuration of SSH Session Limit Greater than Max-Session .....	248

---

CHAPTER 33	Ethernet Interface Loopback Support	249
	Overview	249
	Local Loopback	249
	Remote Loopback	250
	Topology	250
	Configurations	251
	Validation	252
CHAPTER 34	Fault Management System Configuration	261
	Implementation	262
	Enabling and Disabling the Fault Management System	262
	Alarm Configuration File	262
	Auto Generating the Alarm Configuration File	263
	Alarm Descriptions	265
CHAPTER 35	NetConf Call Home Configuration	267
	Configuration	267
	Validation	267
CHAPTER 36	QSFP-DD Configuration	271
	Overview	271
	System Description	271
	Objectives	271
	Topology	271
	Loopback	272
	PRBS	275
	Application	282
	Laser Tuning	285
	QSFP-DD Monitored Alarms	294
CHAPTER 37	Erbium-Doped Fiber Amplifier (EDFA) Configuration	303
	Overview	303
	System Description	303
	Objectives	304
	Topology	304
CHAPTER 38	Port Breakout (100G) on Qumran2	307
	Overview	307
	Limitations	307
	Topology	308
	Port Breakout 4X10g	308
	Port Breakout 4X25g	310
	Port Breakout 2X50g	311
	Un-configure Port Breakout	313
<b>System Management Command Reference</b>		<b>315</b>
CHAPTER 1	Basic Commands	317
	banner motd	319
	clock set	320

---

clock timezone . . . . .	321
configure terminal . . . . .	322
configure terminal force . . . . .	323
copy empty-config startup-config . . . . .	324
copy running-config startup-config . . . . .	325
crypto pki generate rsa common-name ipv4 . . . . .	326
debug nsm . . . . .	327
debug vm-events . . . . .	329
disable . . . . .	330
do . . . . .	331
enable . . . . .	332
enable password . . . . .	333
end . . . . .	334
exec-timeout . . . . .	335
exit . . . . .	336
help . . . . .	337
history . . . . .	338
hostname . . . . .	339
line console . . . . .	340
line vty (all line mode) . . . . .	341
line vty (line mode) . . . . .	342
logging cli . . . . .	343
logout . . . . .	344
max-session . . . . .	345
ping . . . . .	346
ping (interactive) . . . . .	348
quit . . . . .	350
reload . . . . .	351
service advanced-vty . . . . .	352
service password-encryption . . . . .	353
service terminal-length . . . . .	354
show clock . . . . .	355
show cli . . . . .	356
show cli history . . . . .	357
show crypto csr . . . . .	358
show debugging nsm . . . . .	359
show debugging vm-events . . . . .	360
show list . . . . .	361
show logging cli . . . . .	362
show nsm client . . . . .	363
show process . . . . .	364
show running-config . . . . .	365
show running-config switch . . . . .	366
show startup-config . . . . .	368
show tcp . . . . .	369
show timezone . . . . .	371
show users . . . . .	374



---

show version .....	376
sys-reload .....	378
sys-shutdown .....	379
terminal width .....	380
terminal length .....	381
terminal monitor .....	382
traceroute .....	383
watch static-mac-movement .....	384
write .....	385
write terminal .....	386
<b>CHAPTER 2 Common Management Layer Commands .....</b>	<b>387</b>
abort transaction .....	389
cancel-commit .....	390
cml force-unlock config-datastore .....	391
cml lock config-datastore .....	392
cml logging .....	393
cml netconf translation .....	394
cml notification .....	395
cml unlock config-datastore .....	396
cmlsh cli-format .....	397
cmlsh multiple-config-session .....	398
cmlsh notification .....	400
cmlsh transaction .....	401
cmlsh transaction limit .....	402
commit .....	403
confirm-commit .....	406
commit dry-run .....	407
debug cml .....	408
module notification .....	409
show cml config-datastore lock status .....	410
show cml notification status .....	411
show cmlsh multiple-config-session status .....	412
show cmlsh notification status .....	413
show max-transaction limit .....	414
show module-info .....	415
show running-config notification .....	417
show system restore failures .....	418
show transaction current .....	419
show transaction last-aborted .....	420
show (xml json) running-config candidate-config .....	421
<b>CHAPTER 3 User Management .....</b>	<b>425</b>
clear aaa local user lockout username .....	426
debug user-mgmt .....	427
show user-account .....	428
username .....	429

CHAPTER 4	Dynamic Host Configuration Protocol Client	431
	feature dhcp	432
	ip address dhcp	433
	ip dhcp client request	434
	ipv6 address dhcp	435
	ipv6 dhcp address-prefix-length	436
	ipv6 dhcp client request	437
	ipv6 dhcp client	439
	show ipv6 dhcp vendor-opts	441
CHAPTER 5	Dynamic Host Configuration Protocol Relay	443
	clear ip dhcp relay option statistics	444
	clear ipv6 dhcp pd-route ( vrf NAME)	445
	clear ip dhcp relay statistics	446
	ip dhcp relay (configure mode)	447
	ip dhcp relay (interface mode)	448
	ip dhcp relay address	449
	ip dhcp relay address global	450
	ip dhcp relay information option	451
	ip dhcp relay information option always-on	452
	ip dhcp relay information source-ip	453
	ip dhcp relay (L3VPN)	454
	ipv6 dhcp relay (configure mode)	455
	ipv6 dhcp relay (interface mode)	456
	ipv6 dhcp relay address	457
	ipv6 dhcp relay address global	458
	ipv6 dhcp relay pd-route-injection	459
	ipv6 dhcp relay subscriber-id	460
	ipv6 dhcp relay (L3VPN)	461
	show ip dhcp relay	462
	show ip dhcp relay address	463
	show ip dhcp relay option statistics	464
	show ip dhcp relay statistics	465
	show ipv6 dhcp pd-route	466
	show ipv6 dhcp relay	467
	show ipv6 dhcp relay address	468
	show running-config dhcp	469
CHAPTER 6	DHCPv6 Prefix Delegation Commands	471
	ipv6 dhcp prefix-delegation	472
	ipv6 address	473
	ipv6 address autoconfig	474
	show ipv6 dhcp interface	475
CHAPTER 7	DHCP Snooping Commands	477
	debug ip dhcp snooping	478
	hardware-profile filter dhcp-snoop	479
	hardware-profile filter dhcp-snoop-ipv6	480
	ip dhcp packet strict-validation bridge	481

---

ip dhcp snooping arp-inspection bridge	482
ip dhcp snooping arp-inspection vlan	483
ip dhcp snooping arp-inspection validate	484
ip dhcp snooping bridge	485
ip dhcp snooping database	486
ip dhcp snooping information option bridge	487
ip dhcp snooping trust	488
ip dhcp snooping verify mac-address	489
ip dhcp snooping vlan	490
renew ip dhcp snooping binding database	491
show debugging ip dhcp snooping	492
show ip dhcp snooping arp-inspection statistics bridge	493
show ip dhcp snooping bridge	494
show ip dhcp snooping binding bridge	496
<b>CHAPTER 8 DHCP Server Commands</b>	<b>499</b>
address range low-address A.B.C.D (high-address A.B.C.D )	500
address range low-address X:X::X:X (high-address X:X::X:X )	501
boot-file	502
dns-server A.B.C.D	503
dns-server X:X::X:X	504
domain-name	505
host-name	506
ip dhcp server (interface mode)	507
ip dhcp server default-lease-time	508
ip dhcp server max-lease-time	509
ip dhcp server pool	510
ipv6 dhcp server (interface mode)	511
ipv6 dhcp server pool	512
ipv6 dhcp server preference	513
ipv6 dhcp server rapid-commit	514
log-server	515
network A.B.C.D netmask A.B.C.D	516
network X:X::X:X netmask <1-128>	517
ntp-server A.B.C.D	518
ntp-server X:X::X:X	519
prefix high-range X:X::X:X low-range X:X::X:X netmask <1-128>	520
temporary address X:X::X:X	521
tftp-server	522
vendor-options	523
<b>CHAPTER 9 IP Source Guard Commands</b>	<b>525</b>
hardware-profile filter ipsg	526
hardware-profile filter ipsg-ipv6	527
ip verify source dhcp-snooping-vlan	528
<b>CHAPTER 10 Domain Name System Commands</b>	<b>529</b>
debug dns client	530

---

ip domain-list . . . . .	531
ip domain-lookup . . . . .	532
ip domain-name . . . . .	533
ip host . . . . .	534
ip name-server . . . . .	535
show hosts . . . . .	536
show running-config dns . . . . .	538
<b>CHAPTER 11 Domain Name System Relay Commands . . . . .</b>	<b>539</b>
ip dns relay (global) . . . . .	540
ip dns relay (interface) . . . . .	541
ip dns relay address . . . . .	542
ip dns relay uplink . . . . .	543
ipv6 dns relay (global) . . . . .	544
ipv6 dns relay (interface) . . . . .	545
ipv6 dns relay address . . . . .	546
ipv6 dns relay uplink . . . . .	547
show ip dns relay . . . . .	548
show ip dns relay address . . . . .	550
show ipv6 dns relay . . . . .	551
show ipv6 dns relay address . . . . .	552
show running-config dns relay . . . . .	553
<b>CHAPTER 12 Telnet . . . . .</b>	<b>555</b>
debug telnet server . . . . .	556
feature telnet . . . . .	557
show debug telnet-server . . . . .	558
show running-config telnet server . . . . .	559
show telnet-server . . . . .	560
telnet . . . . .	561
telnet6 . . . . .	562
telnet server port . . . . .	563
telnet server session-limit . . . . .	564
<b>CHAPTER 13 Secure Shell . . . . .</b>	<b>565</b>
clear ssh host-key . . . . .	566
clear ssh hosts . . . . .	567
clear ssh keypair . . . . .	568
debug ssh server . . . . .	569
feature ssh . . . . .	570
show debug ssh-server . . . . .	571
show running-config ssh server . . . . .	572
show ssh host-key . . . . .	573
show ssh server . . . . .	575
show username . . . . .	576
ssh . . . . .	577
ssh6 . . . . .	578
ssh algorithm encryption . . . . .	580

---

ssh keygen host . . . . .	582
ssh login-attempts . . . . .	584
ssh server port . . . . .	585
ssh server session-limit . . . . .	586
username sshkey . . . . .	587
username keypair . . . . .	588
<b>CHAPTER 14 Network Time Protocol . . . . .</b>	<b>589</b>
clear ntp statistics . . . . .	590
debug ntp . . . . .	591
feature ntp . . . . .	592
ntp acl . . . . .	593
ntp authenticate . . . . .	594
ntp authentication-key . . . . .	595
ntp enable . . . . .	596
ntp discard . . . . .	597
ntp logging . . . . .	598
ntp master . . . . .	599
ntp master stratum . . . . .	600
ntp peer . . . . .	601
ntp request-key . . . . .	603
ntp server . . . . .	604
ntp sync-retry . . . . .	606
ntp trusted-key . . . . .	607
show ntp authentication-keys . . . . .	608
show ntp authentication-status . . . . .	609
show ntp logging-status . . . . .	610
show ntp peer-status . . . . .	611
show ntp peers . . . . .	613
show ntp statistics . . . . .	614
show ntp trusted-keys . . . . .	616
show running-config ntp . . . . .	617
<b>CHAPTER 15 TACACS+ Commands . . . . .</b>	<b>619</b>
clear tacacs-server counters . . . . .	620
debug tacacs+ . . . . .	621
feature tacacs+ . . . . .	622
show debug tacacs+ . . . . .	623
show running-config tacacs+ . . . . .	624
show tacacs-server . . . . .	625
tacacs-server login host . . . . .	627
tacacs-server login key . . . . .	629
tacacs-server login timeout . . . . .	630
<b>CHAPTER 16 RADIUS Commands . . . . .</b>	<b>631</b>
clear radius-server . . . . .	632
debug radius . . . . .	633
radius-server login host . . . . .	634

radius-server login host acct-port . . . . .	636
radius-server login host auth-port . . . . .	637
radius-server login host key . . . . .	638
radius-server login key . . . . .	640
radius-server login timeout . . . . .	641
show debug radius . . . . .	642
show radius-server . . . . .	643
show running-config radius . . . . .	645
<b>CHAPTER 17 Simple Network Management Protocol . . . . .</b>	<b>647</b>
debug snmp-server . . . . .	649
show running-config snmp . . . . .	650
show snmp . . . . .	651
show snmp community . . . . .	652
show snmp context . . . . .	653
show snmp engine-id . . . . .	654
show snmp group . . . . .	655
show snmp host . . . . .	656
show snmp user . . . . .	657
show snmp view . . . . .	658
snmp context . . . . .	659
snmp-server community . . . . .	660
snmp-server community-map . . . . .	661
snmp-server contact . . . . .	662
snmp-server context . . . . .	663
snmp-server disable default . . . . .	664
snmp-server enable snmp . . . . .	665
snmp-server enable traps . . . . .	666
snmp-server engineID . . . . .	668
snmp-server group . . . . .	669
snmp-server host . . . . .	671
snmp-server location . . . . .	673
snmp-server smux-port-disable . . . . .	674
snmp-server tcp-session . . . . .	675
snmp-server user . . . . .	676
snmp-server view . . . . .	678
<b>CHAPTER 18 Authentication, Authorization and Accounting . . . . .</b>	<b>679</b>
aaa authentication login . . . . .	680
aaa accounting details . . . . .	681
aaa authentication login default . . . . .	682
aaa authorization default . . . . .	683
aaa authentication login default fallback error . . . . .	684
aaa group server . . . . .	685
aaa local authentication attempts max-fail . . . . .	686
aaa local authentication unlock-timeout . . . . .	687
debug aaa . . . . .	688
server . . . . .	689

---

show aaa authentication . . . . .	690
show aaa authentication login . . . . .	691
show aaa authorization . . . . .	692
show aaa groups . . . . .	693
show aaa accounting . . . . .	694
show running-config aaa . . . . .	695
<b>CHAPTER 19 Remote Management Commands . . . . .</b>	<b>697</b>
copy running-config . . . . .	698
copy running-config (interactive) . . . . .	699
copy startup-config . . . . .	700
copy startup-config (interactive) . . . . .	701
copy system file . . . . .	702
copy system file (interactive) . . . . .	703
copy ftp startup-config . . . . .	704
copy scp filepath . . . . .	705
copy scp startup-config . . . . .	706
copy sftp startup-config . . . . .	707
copy tftp startup-config . . . . .	708
copy http startup-config . . . . .	709
copy ftp startup-config (interactive) . . . . .	710
copy scp startup-config (interactive) . . . . .	711
copy sftp startup-config (interactive) . . . . .	712
copy tftp startup-config (interactive) . . . . .	713
copy http startup-config (interactive) . . . . .	714
copy file startup-config . . . . .	715
<b>CHAPTER 20 Software Monitoring and Reporting . . . . .</b>	<b>717</b>
clear cores . . . . .	718
copy core . . . . .	719
copy techsupport . . . . .	720
feature software-watchdog . . . . .	721
show bootup-parameters . . . . .	722
show cores . . . . .	723
show running-config watchdog . . . . .	724
show software-watchdog status . . . . .	725
show system log . . . . .	728
show system login . . . . .	730
show system reboot-history . . . . .	731
show system resources . . . . .	732
show system uptime . . . . .	734
show techsupport . . . . .	735
show techsupport status . . . . .	737
software-watchdog . . . . .	738
software-watchdog keep-alive-time . . . . .	740
<b>CHAPTER 21 Interface Commands . . . . .</b>	<b>741</b>
admin-group . . . . .	744

bandwidth	745
bandwidth-measurement static uni-available-bandwidth	746
bandwidth-measurement static uni-residual-bandwidth	747
bandwidth-measurement static uni-utilized-bandwidth	748
clear hardware-discard-counters	749
clear interface counters	750
clear interface cpu counters	751
clear interface fec	752
clear ip prefix-list	753
clear ipv6 neighbors	754
clear ipv6 prefix-list	755
debounce-time	756
delay-measurement dynamic twamp	757
delay-measurement a-bit-min-max-delay-threshold	759
delay-measurement static	760
delay-measurement a-bit-delay-threshold	761
description	762
duplex	763
fec	764
flowcontrol	765
hardware-profile port-config	767
hardware-profile portmode	768
if-arbiter	769
interface	770
ip address A.B.C.D/M	771
ip address dhcp	772
ip forwarding	773
ip prefix-list	774
ip proxy-arp	776
ip remote-address	777
ip unnumbered	778
ip vrf forwarding	779
ipv6 address	780
ipv6 forwarding	781
ipv6 prefix-list	782
ipv6 unnumbered	784
link-debounce-time	785
load interval	786
loopback	787
loss-measurement dynamic	788
loss-measurement uni-link-loss	789
monitor speed	790
monitor queue-drops	791
monitor speed threshold	792
mtu	793
multicast	795
show flowcontrol	796



---

show hardware-discard-counters . . . . .	797
show interface . . . . .	799
show interface capabilities . . . . .	801
show interface counters . . . . .	803
show interface counters drop-stats . . . . .	806
show interface counters error-stats . . . . .	809
show interface counters (indiscard-stats outdiscard-stats) . . . . .	810
show interface counters protocol . . . . .	813
show interface counters queue-drop-stats . . . . .	814
show interface counters queue-stats . . . . .	815
show interface counters rate . . . . .	817
show interface counters speed . . . . .	819
show interface counters summary . . . . .	820
show interface fec . . . . .	822
show ip forwarding . . . . .	824
show ip interface . . . . .	825
show ip prefix-list . . . . .	827
show ip route . . . . .	828
show ip route A.B.C.D/M longer-prefixes . . . . .	830
show ip vrf . . . . .	839
show ipv6 forwarding . . . . .	840
show ipv6 interface brief . . . . .	841
show ipv6 route . . . . .	843
show ipv6 prefix-list . . . . .	845
show hosts . . . . .	846
show running-config interface . . . . .	848
show running-config interface ip . . . . .	850
show running-config interface ipv6 . . . . .	851
show running-config ip . . . . .	852
show running-config ipv6 . . . . .	853
show running-config prefix-list . . . . .	854
shutdown . . . . .	855
speed . . . . .	856
switchport . . . . .	859
switchport allowed ethertype . . . . .	860
switchport protected . . . . .	861
transceiver . . . . .	862
poe-enable . . . . .	864
show interface poe-status . . . . .	865
<b>CHAPTER 22 Access Control List Commands (Standard) . . . . .</b>	<b>867</b>
ip access-list standard . . . . .	868
ip access-list standard filter . . . . .	869
Ipv6 access-list standard . . . . .	870
ipv6 access-list standard filter . . . . .	871
<b>CHAPTER 23 Access Control List Commands . . . . .</b>	<b>873</b>
arp access-group . . . . .	875

---

arp access-list . . . . .	876
arp access-list default . . . . .	877
arp access-list remark . . . . .	878
arp access-list request . . . . .	879
arp access-list resequence . . . . .	881
arp access-list response . . . . .	882
clear access-list . . . . .	884
clear arp access-list . . . . .	885
clear ip access-list . . . . .	886
clear ipv6 access-list . . . . .	887
clear mac access-list . . . . .	888
ip access-group . . . . .	889
ip access-list . . . . .	891
ip access-list default . . . . .	892
ip access-list filter . . . . .	893
ip access-list icmp . . . . .	896
ip access-list remark . . . . .	899
ip access-list resequence . . . . .	900
ip access-list tcp udp . . . . .	901
ipv6 access-group in . . . . .	906
ipv6 access-list . . . . .	908
ipv6 access-list default . . . . .	910
ipv6 access-list filter . . . . .	911
ipv6 access-list icmpv6 . . . . .	914
ipv6 access-list remark . . . . .	916
ipv6 access-list resequence . . . . .	917
ipv6 access-list sctp . . . . .	918
ipv6 access-list tcp udp . . . . .	920
mac access-group . . . . .	925
mac access-list . . . . .	927
mac access-list default . . . . .	928
mac access-list filter . . . . .	929
mac access-list remark . . . . .	931
mac access-list resequence . . . . .	932
show access-lists . . . . .	933
show arp access-lists . . . . .	935
show ip access-lists . . . . .	936
show ipv6 access-lists . . . . .	938
show mac access-lists . . . . .	939
show running-config access-list . . . . .	941
show running-config aclmgr . . . . .	942
show running-config ipv6 access-list . . . . .	943
CHAPTER 24 Time Range Commands . . . . .	945
end-time (absolute) . . . . .	946
end-time after (relative) . . . . .	947
frequency . . . . .	948

---

frequency days (specific days) . . . . .	949
start-time (absolute) . . . . .	950
start-time after (relative) . . . . .	951
start-time now (current) . . . . .	952
time-range . . . . .	953
CHAPTER 25 IP Service Level Agreements Commands . . . . .	955
clear ip sla statistics . . . . .	956
frequency . . . . .	957
icmp-echo . . . . .	958
ip sla . . . . .	959
ip sla schedule . . . . .	960
show ip sla statistics . . . . .	961
show ip sla summary . . . . .	963
show running-config ip sla . . . . .	964
threshold . . . . .	965
timeout . . . . .	966
CHAPTER 26 Object Tracking Commands . . . . .	967
track ip sla reachability . . . . .	968
delay up down . . . . .	969
show track . . . . .	970
show track <1-500> . . . . .	971
show track summary . . . . .	972
show running-config track . . . . .	973
CHAPTER 27 Chassis Management Module Commands . . . . .	975
cpu-core-usage . . . . .	976
debug cmm . . . . .	978
disk-activity-monitoring interval . . . . .	979
disk-activity-monitoring threshold . . . . .	980
locator led . . . . .	981
show hardware-information . . . . .	982
show system fru . . . . .	1002
show system-information . . . . .	1003
show system sensor . . . . .	1008
system-load-average . . . . .	1012
CHAPTER 28 Digital Diagnostic Monitoring Commands . . . . .	1015
clear ddm transceiver alarm . . . . .	1016
clear ddm transceiver alarm all . . . . .	1017
ddm monitor . . . . .	1018
ddm monitor all . . . . .	1019
ddm monitor interval . . . . .	1020
debug ddm . . . . .	1021
service unsupported-transceiver . . . . .	1022
show controller details . . . . .	1023
show interface frequency grid . . . . .	1024
show interface transceiver details . . . . .	1026

---

show supported-transceiver .....	1030
tx-disable .....	1031
wavelength .....	1032
CHAPTER 29 sFlow Commands .....	1033
clear sflow statistics .....	1034
debug sflow .....	1035
feature sflow .....	1036
sflow agent-ip .....	1037
sflow collector .....	1038
sflow enable .....	1039
sflow poll-interval .....	1040
sflow rate-limit .....	1041
sflow sampling-rate .....	1042
show sflow .....	1043
show sflow interface .....	1045
show sflow statistics .....	1046
CHAPTER 30 Trigger Failover Commands .....	1047
clear tfo counter .....	1048
fog .....	1049
fog tfo .....	1050
fog type .....	1051
link-type .....	1052
show tfo .....	1053
tfo .....	1055
CHAPTER 31 VLOG Commands .....	1057
show vlog all .....	1058
show vlog clients .....	1060
show vlog terminals .....	1061
show vlog virtual-routers .....	1062
CHAPTER 32 Syslog Commands .....	1063
Syslog Severities .....	1064
Log File Rotation .....	1065
clear logging logfile .....	1067
feature rsyslog .....	1068
log syslog .....	1069
logging console .....	1070
logging level .....	1071
logging logfile .....	1073
logging monitor .....	1074
logging remote facility .....	1075
logging remote server .....	1076
logging timestamp .....	1078
show logging .....	1079
show logging last .....	1081
show logging logfile .....	1082

---

show logging logfile last-index	1083
show logging logfile start-seqn end-seqn	1084
show logging logfile start-time end-time	1085
show running-config logging	1086
CHAPTER 33 Linux Shell Commands	1087
CHAPTER 34 System Configure Mode Commands	1089
delay-profile interfaces	1090
delay-profile interfaces subcommands	1091
forwarding profile	1093
hardware-profile filter	1095
hardware-profile flowcontrol	1101
hardware-profile service-queue	1102
hardware-profile statistics	1103
hardware-profile bgp-flowspec-mode	1105
ip redirects	1106
ip redirects	1107
load-balance enable	1108
show forwarding profile limit	1110
show hardware-profile filters	1111
show nsm forwarding-timer	1117
show queue remapping	1118
snmp restart	1120
CHAPTER 35 Control Plane Policing Commands	1121
clear interface cpu counters	1122
cpu-queue	1123
show interface cpu counters queue-stats	1127
show cpu-queue details	1128
CHAPTER 36 Source Interface Commands	1131
ip source-interface	1132
ipv6 source-interface	1133
show ip source-interface detail	1134
show ipv6 source-interface detail	1135
show running-config ip source-interface	1136
show running-config ipv6 source-interface	1137
CHAPTER 37 FMS Command Reference	1139
fault-management (enable   disable)	1140
fault-management close	1141
fault-management flush-db	1142
fault-management shelve	1143
show alarm active	1144
show alarm closed	1145
show alarm history	1146
show alarm shelved	1147
show alarm statistics	1148
show alarm transitions	1149

---

show fms status .....	1150
show fms supported-alarm-types .....	1151
show running-config fault-management .....	1152
CHAPTER 38 NetConf Call Home Commands .....	1153
callhome server .....	1154
debug callhome .....	1156
feature netconf callhome .....	1157
management-port .....	1158
netconf callhome .....	1159
reconnect .....	1160
retry-interval .....	1162
retry-max-attempts .....	1164
show (xml) running-config netconf-callhome .....	1166
CHAPTER 39 OSPFv3 IPsec Authentication Commands .....	1167
crypto ipsec transform-set .....	1168
crypto map .....	1170
set peer .....	1171
set session-key .....	1172
set transform-set .....	1173
sequence .....	1174
show crypto ipsec transform-set .....	1175
CHAPTER 40 QSFP-DD Laser Configuration and Status .....	1177
application .....	1178
laser channel .....	1182
laser grid .....	1183
laser fine-tune-freq .....	1184
laser output-power .....	1185
loopback .....	1186
prbs .....	1187
qsfp-dd .....	1189
show qsfp-dd advertisement applications .....	1190
show qsfp-dd advertisement controls .....	1195
show qsfp-dd advertisement diagnostics host .....	1196
show qsfp-dd advertisement diagnostics media .....	1197
show qsfp-dd advertisement diagnostics module .....	1198
show qsfp-dd advertisement durations .....	1199
show qsfp-dd advertisement laser .....	1200
show qsfp-dd advertisement monitors host .....	1201
show qsfp-dd advertisement monitors media .....	1202
show qsfp-dd advertisement monitors module .....	1204
show qsfp-dd advertisement pages .....	1205
show qsfp-dd application .....	1206
show qsfp-dd diagnostics host .....	1207
show qsfp-dd diagnostics media .....	1209
show qsfp-dd eeprom .....	1210

show qsfm-dd laser grid .....	1211
show qsfm-dd laser status .....	1213
show qsfm-dd monitors host .....	1214
show qsfm-dd monitors media .....	1216
show qsfm-dd monitors module .....	1218
show qsfm-dd state .....	1219
CHAPTER 41 Smart SFP Commands .....	1067
ddm raise .....	1068
show interface controller details .....	1069
show interface transceiver details .....	1071
show interface transceiver detail remote .....	1075
show interface transceiver protocol .....	1076
show interface transceiver protocol remote .....	1077
show interface transceiver protocol stats .....	1078
show interface transceiver remote .....	1079
show interface transceiver threshold violations remote .....	1080
xcvr <IFNAME> tx-disable <1-256> remote .....	1081
xcvr <IFNAME> reset remote .....	1082
xcvr loopback .....	1083
CHAPTER 42 Erbium-doped Fiber Amplifier Commands .....	1085
edfa operating-mode .....	1086
edfa target-gain .....	1087
edfa target-outpwr .....	1088
show edfa operating-mode .....	1089
show interface IFNAME transceiver detail .....	1090
show interface IFNAME transceiver threshold violations .....	1092
show interface IFNAME transceiver .....	1093
show interface transceiver .....	1095
show interface transceiver detail .....	1096
show interface transceiver threshold violations .....	1097
<b>Index .....</b>	<b>1099</b>





---

# Preface

---

This guide describes how to configure OcNOS.

---

## IP Maestro Support

Monitor devices running OcNOS Release 6.3.4-70 and above using IP Maestro software.

---

## Audience

This guide is intended for network administrators and other engineering professionals who configure OcNOS.

---

## Conventions

[Table P-1](#) shows the conventions used in this guide.

**Table P-1: Conventions**

Convention	Description
Italics	Emphasized terms; titles of books
Note:	Special instructions, suggestions, or warnings
<code>monospaced type</code>	Code elements such as commands, parameters, files, and directories

---

## Chapter Organization

The chapters in command references are organized as described in [Command Description Format](#).

The chapters in configuration guides are organized into these major sections:

- An overview that explains a configuration in words
  - Topology with a diagram that shows the devices and connections used in the configuration
  - Configuration steps in a table for each device where the left-hand side shows the commands you enter and the right-hand side explains the actions that the commands perform
  - Validation which shows commands and their output that verify the configuration
- 

## Related Documentation

For information about installing OcNOS, see the *Installation Guide* for your platform.

---

## Feature Availability

The features described in this document that are available depend upon the OcNOS SKU that you purchased. See the *Feature Matrix* for a description of the OcNOS SKUs.

---

## Migration Guide

Check the *Migration Guide* for configuration changes to make when migrating from one version of OcNOS to another.

---

## Support

For support-related questions, contact [support@ipinfusion.com](mailto:support@ipinfusion.com).

---

## Comments

If you have comments, or need to report a problem with the content, contact [techpubs@ipinfusion.com](mailto:techpubs@ipinfusion.com).

---

# Command Line Interface

---

This chapter introduces the OcNOS Command Line Interface (CLI) and how to use its features.

---

## Overview

You use the CLI to configure, monitor, and maintain OcNOS devices. The CLI is text-based and each command is usually associated with a specific task.

You can give the commands described in this manual locally from the console of a device running OcNOS or remotely from a terminal emulator such as `putty` or `xterm`. You can also use the commands in scripts to automate configuration tasks.

---

## Command Line Interface Help

You access the CLI help by entering a full or partial command string and a question mark “?”. The CLI displays the command keywords or parameters along with a short description. For example, at the CLI command prompt, type:

```
> show ?
```

The CLI displays this keyword list with short descriptions for each keyword:

```
show ?
  application-priority      Application Priority
  arp                      Internet Protocol (IP)
  bfd                      Bidirectional Forwarding Detection (BFD)
  bgp                      Border Gateway Protocol (BGP)
  bi-lsp                   Bi-directional lsp status and configuration
  bridge                   Bridge group commands
  ce-vlan                  COS Preservation for Customer Edge VLAN
  class-map                Class map entry
  cli                     Show CLI tree of current mode
  clns                    Connectionless-Mode Network Service (CLNS)
  control-adjacency       Control Adjacency status and configuration
  control-channel         Control Channel status and configuration
  cspf                    CSPF Information
  customer                Display Customer spanning-tree
  cvlan                   Display CVLAN information
  debugging               Debugging functions (see also 'undebug')
  etherchannel            LACP etherchannel
  ethernet                Layer-2
  ...
```

If you type the ? in the middle of a keyword, the CLI displays help for that keyword only.

```
> show de?
debugging Debugging functions (see also 'undebug')
```

If you type the ? in the middle of a keyword, but the incomplete keyword matches several other keywords, OcNOS displays help for all matching keywords.

```
> show i? (CLI does not display the question mark).
interface Interface status and configuration
ip IP information
isis ISIS information
```

---

## Command Completion

The CLI can complete the spelling of a command or a parameter. Begin typing the command or parameter and then press the tab key. For example, at the CLI command prompt type `sh`:

```
> sh
```

Press the tab key. The CLI displays:

```
> show
```

If the spelling of a command or parameter is ambiguous, the CLI displays the choices that match the abbreviation. Type `show i` and press the tab key. The CLI displays:

```
> show i
  interface ip          ipv6          isis
> show i
```

The CLI displays the `interface` and `ip` keywords. Type `n` to select `interface` and press the tab key. The CLI displays:

```
> show in
> show interface
```

Type `?` and the CLI displays the list of parameters for the `show interface` command.

```
> show interface
  IFNAME  Interface name
  |       Output modifiers
  >       Output redirection
  <cr>
```

The CLI displays the only parameter associated with this command, the `IFNAME` parameter.

---

## Command Abbreviations

The CLI accepts abbreviations that uniquely identify a keyword in commands. For example:

```
> sh int xe0
```

is an abbreviation for:

```
> show interface xe0
```

---

## Command Line Errors

Any unknown spelling causes the CLI to display the error `Unrecognized command` in response to the `?`. The CLI displays the command again as last entered.

```
> show dd?
% Unrecognized command
> show dd
```

When you press the Enter key after typing an invalid command, the CLI displays:

```
(config)#router ospf here
                               ^
% Invalid input detected at '^' marker.
```

where the `^` points to the first character in error in the command.

If a command is incomplete, the CLI displays the following message:

```
> show
% Incomplete command.
```

Some commands are too long for the display line and can wrap mid-parameter or mid-keyword, as shown below. This does *not* cause an error and the command performs as expected:

```
area 10.10.0.18 virtual-link 10.10.0.19 authent
ication-key 57393
```

---

## Command Negation

Many commands have a `no` form that resets a feature to its default value or disables the feature. For example:

- The `ip address` command assigns an IPv4 address to an interface
- The `no ip address` command removes an IPv4 address from an interface

---

## Syntax Conventions

[Table P-2](#) describes the conventions used to represent command syntax in this reference.

**Table P-2: Syntax conventions**

Convention	Description	Example
monospaced font	Command strings entered on a command line	<code>show ip ospf</code>
lowercase	Keywords that you enter exactly as shown in the command syntax.	<code>show ip ospf</code>
UPPERCASE	See <a href="#">Variable Placeholders</a>	IFNAME
()	Optional parameters, from which you must select one. Vertical bars delimit the selections. Do not enter the parentheses or vertical bars as part of the command.	<code>(A.B.C.D &lt;0-4294967295&gt;)</code>
()	Optional parameters, from which you select one or none. Vertical bars delimit the selections. Do not enter the parentheses or vertical bars as part of the command.	<code>(A.B.C.D &lt;0-4294967295&gt; )</code>
()	Optional parameter which you can specify or omit. Do not enter the parentheses or vertical bar as part of the command.	<code>(IFNAME )</code>
{ }	Optional parameters, from which you must select one or more. Vertical bars delimit the selections. Do not enter the braces or vertical bars as part of the command.	<code>{intra-area &lt;1-255&gt; inter-area &lt;1-255&gt; external &lt;1-255&gt;}</code>

**Table P-2: Syntax conventions (Continued)**

Convention	Description	Example
[ ]	Optional parameters, from which you select zero or more. Vertical bars delimit the selections. Do not enter the brackets or vertical bars as part of the command.	[<1-65535> AA:NN internet local-AS no-advertise no-export]
?	Nonrepeatable parameter. The parameter that follows a question mark can only appear once in a command string. Do not enter the question mark as part of the command.	?route-map WORD
.	Repeatable parameter. The parameter that follows a period can be repeated more than once. Do not enter the period as part of the command.	set as-path prepend .<1-65535>

---

## Variable Placeholders

Table P-3 shows the tokens used in command syntax use to represent variables for which you supply a value.

**Table P-3: Variable placeholders**

Token	Description
WORD	A contiguous text string (excluding spaces)
LINE	A text string, including spaces; no other parameters can follow this parameter
IFNAME	Interface name whose format varies depending on the platform; examples are: eth0, Ethernet0, ethernet0, xe0
A.B.C.D	IPv4 address
A.B.C.D/M	IPv4 address and mask/prefix
X:X::X:X	IPv6 address
X:X::X:X/M	IPv6 address and mask/prefix
HH:MM:SS	Time format
AA:NN	BGP community value
XX:XX:XX:XX:XX:XX	MAC address
<1-5> <1-65535> <0-2147483647> <0-4294967295>	Numeric range

---

## Command Description Format

Table P-4 explains the sections used to describe each command in this reference.

**Table P-4: Command descriptions**

Section	Description
<b>Command Name</b>	The name of the command, followed by what the command does and when should it be used
<b>Command Syntax</b>	The syntax of the command
<b>Parameters</b>	Parameters and options for the command
<b>Default</b>	The state before the command is executed
<b>Command Mode</b>	The mode in which the command runs; see <a href="#">Command Modes</a>
<b>Example</b>	An example of the command being executed

---

## Keyboard Operations

Table P-5 lists the operations you can perform from the keyboard.

**Table P-5: Keyboard operations**

Key combination	Operation
Left arrow or Ctrl+b	Moves one character to the left. When a command extends beyond a single line, you can press left arrow or Ctrl+b repeatedly to scroll toward the beginning of the line, or you can press Ctrl+a to go directly to the beginning of the line.
Right arrow or Ctrl-f	Moves one character to the right. When a command extends beyond a single line, you can press right arrow or Ctrl+f repeatedly to scroll toward the end of the line, or you can press Ctrl+e to go directly to the end of the line.
Esc, b	Moves back one word
Esc, f	Moves forward one word
Ctrl+e	Moves to end of the line
Ctrl+a	Moves to the beginning of the line
Ctrl+u	Deletes the line
Ctrl+w	Deletes from the cursor to the previous whitespace
Alt+d	Deletes the current word
Ctrl+k	Deletes from the cursor to the end of line
Ctrl+y	Pastes text previously deleted with Ctrl+k, Alt+d, Ctrl+w, or Ctrl+u at the cursor

**Table P-5: Keyboard operations (Continued)**

Key combination	Operation
Ctrl+t	Transposes the current character with the previous character
Ctrl+c	Ignores the current line and redisplay the command prompt
Ctrl+z	Ends configuration mode and returns to exec mode
Ctrl+l	Clears the screen
Up Arrow or Ctrl+p	Scroll backward through command history
Down Arrow or Ctrl+n	Scroll forward through command history

---

## Show Command Modifiers

You can use two tokens to modify the output of a `show` command. Enter a question mark to display these tokens:

```
# show users ?
  | Output modifiers
  > Output redirection
```

You can type the | (vertical bar character) to use output modifiers. For example:

```
> show rsvp | ?
begin      Begin with the line that matches
exclude    Exclude lines that match
include    Include lines that match
last       Last few lines
redirect   Redirect output
```

---

## Begin Modifier

The `begin` modifier displays the output beginning with the first line that contains the input string (everything typed after the `begin` keyword). For example:

```
# show running-config | begin xe1
...skipping
interface xe1
  ipv6 address fe80::204:75ff:fee6:5393/64
!
interface xe2
  ipv6 address fe80::20d:56ff:fe96:725a/64
!
line con 0
  login
!
end
```

You can specify a regular expression after the `begin` keyword. This example begins the output at a line with either “xe2” or “xe4”:

```
# show running-config | begin xe[3-4]
...skipping
```



```

interface xe3
 shutdown
 !
interface xe4
 shutdown
 !
interface svlan0.1
 no shutdown
 !
route-map myroute permit 3
 !
route-map mymap1 permit 10
 !
route-map rmap1 permit 3
 !
line con 0
 login
line vty 0 4
 login
 !
end

```

---

## Include Modifier

The `include` modifier includes only those lines of output that contain the input string. In the output below, all lines containing the word “input” are included:

```

# show interface xe1 | include input
input packets 80434552, bytes 2147483647, dropped 0, multicast packets 0
input errors 0, length 0, overrun 0, CRC 0, frame 0, fifo 1, missed 0

```

You can specify a regular expression after the `include` keyword. This examples includes all lines with “input” or “output”:

```

#show interface xe0 | include (in|out)put
input packets 597058, bytes 338081476, dropped 0, multicast packets 0
input errors 0, length 0, overrun 0, CRC 0, frame 0, fifo 0, missed 0
output packets 613147, bytes 126055987, dropped 0
output errors 0, aborted 0, carrier 0, fifo 0, heartbeat 0, window 0

```

---

## Exclude Modifier

The `exclude` modifier excludes all lines of output that contain the input string. In the following output example, all lines containing the word “input” are excluded:

```

# show interface xe1 | exclude input
Interface xe1
Scope: both
Hardware is Ethernet, address is 0004.75e6.5393
index 3 metric 1 mtu 1500 <UP,BROADCAST,RUNNING,MULTICAST>
VRF Binding: Not bound
Administrative Group(s): None
DSTE Bandwidth Constraint Mode is MAM
inet6 fe80::204:75ff:fee6:5393/64
output packets 4438, bytes 394940, dropped 0
output errors 0, aborted 0, carrier 0, fifo 0, heartbeat 0, window 0
collisions 0

```

You can specify a regular expression after the `exclude` keyword. This example excludes lines with “output” or “input”:

```
# show interface xe0 | exclude (in|out)put
Interface xe0
  Scope: both
  Hardware is Ethernet Current HW addr: 001b.2139.6c4a
  Physical:001b.2139.6c4a Logical:(not set)
  index 2 metric 1 mtu 1500 duplex-full arp ageing timeout 3000
  <UP,BROADCAST,RUNNING,MULTICAST>
  VRF Binding: Not bound
  Bandwidth 100m
  DHCP client is disabled.
  inet 10.1.2.173/24 broadcast 10.1.2.255
  VRRP Master of : VRRP is not configured on this interface.
  inet6 fe80::21b:21ff:fe39:6c4a/64
  collisions 0
```

---

## Redirect Modifier

The `redirect` modifier writes the output into a file. The output is not displayed.

```
# show cli history | redirect /var/frame.txt
```

The output redirection token (`>`) does the same thing:

```
# show cli history >/var/frame.txt
```

---

## Last Modifier

The `last` modifier displays the output of last few number of lines (As per the user input). The last number ranges from 1 to 9999.

For example:

```
#show running-config | last 10
```

---

## String Parameters

The restrictions in [Table P-6](#) apply for all string parameters used in OcnOS commands, unless some other restrictions are noted for a particular command.

**Table P-6: String parameter restrictions**

Restriction	Description
Input length	1965 characters or less
Restricted special characters	“?”, “,”, “>”, “ ”, and “=” The “ ” character is allowed only for the <code>description</code> command in interface mode.

---

## Command Modes

Commands are grouped into modes arranged in a hierarchy. Each mode has its own set of commands. [Table P-7](#) lists the command modes common to all protocols.

**Table P-7: Common command modes**

Name	Description
Executive mode	Also called <i>view</i> mode, this is the first mode to appear after you start the CLI. It is a base mode from where you can perform basic commands such as <code>show</code> , <code>exit</code> , <code>quit</code> , <code>help</code> , and <code>enable</code> .
Privileged executive mode	Also called <i>enable</i> mode, in this mode you can run additional basic commands such as <code>debug</code> , <code>write</code> , and <code>show</code> .
Configure mode	Also called <i>configure terminal</i> mode, in this mode you can run configuration commands and go into other modes such as <code>interface</code> , <code>router</code> , <code>route map</code> , <code>key chain</code> , and <code>address family</code> .  Configure mode is single user. Only one user at a time can be in configure mode.
Interface mode	In this mode you can configure protocol-specific settings for a particular interface. Any setting you configure in this mode overrides a setting configured in router mode.
Router mode	This mode is used to configure router-specific settings for a protocol such as BGP or OSPF.

---

## Command Mode Tree

The diagram below shows the common command mode hierarchy.

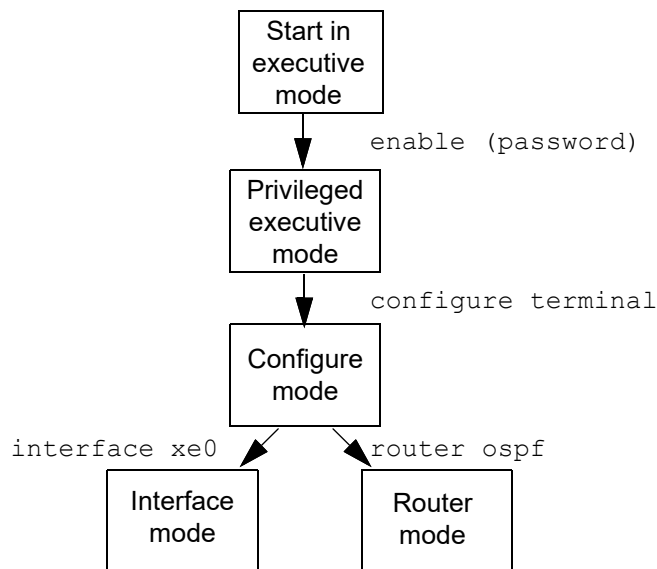

**Figure P-1: Common command modes**

To change modes:

1. Enter privileged executive mode by entering `enable` in Executive mode.
2. Enter configure mode by entering `configure terminal` in Privileged Executive mode.

The example below shows moving from executive mode to privileged executive mode to configure mode and finally to router mode:

```
> enable mypassword
# configure terminal
Enter configuration commands, one per line. End with CNTL/Z.
(config)# router ospf
(config-router)#
```

Note: Each protocol can have modes in addition to the common command modes. See the command reference for the respective protocol for details.

---

## Transaction-based Command-line Interface

The OcNOS command line interface is transaction based:

- Any changes done in configure mode are stored in a separate *candidate* configuration that you can view with the [show transaction current](#) command.
- When a configuration is complete, apply the candidate configuration to the running configuration with the [commit](#) command.
- If a [commit](#) fails, no configuration is applied as the entire transaction is considered failed. You can continue to change the candidate configuration and then retry the [commit](#).
- Discard the candidate configuration with the [abort transaction](#) command.
- Check the last aborted transaction with the [show transaction last-aborted](#) command.
- Multiple configurations cannot be removed with a single [commit](#). You must remove each configuration followed by a [commit](#).

Note: All commands MUST be executed only in the default CML shell (`cmlsh`). If you log in as root and start `imish`, then the system configurations will go out of sync. The `imish` shell is not supported and should not be started manually.



# System Management Configuration Guide





---

## CHAPTER 1 Using the Management Interface

---

---

### Overview

OcNOS provides support for different types of Management Interfaces. The management interface can be the standard out of band (OOB) port, or any in-band port.

To provide segregation between management traffic and data traffic, OcNOS provides a Management VRF. The Management VRF is created by default when OcNOS boots. This VRF cannot be deleted. All ports used as Management Interface needs to be in Management VRF. The management VRF is used for all types of Management applications listed below

- Remote access to router (SSH/Telnet)
- File transfer applications (SFTP/SCP)
- Login Authentication via Radius/Tacacs
- Network management protocols (SNMP, Netconf)

Apart from this, DHCP, DNS, NTP, Syslog, sFlow, and license/software upgrade also uses ports mapped to the management VRF for their operations. Also LLDP can run on any ports mapped to the management VRF.

Note: If the management interface flaps, the device becomes unreachable.

---

### Management Port

The Out of Band (OOB) Management Port in OcNOS is identified as “eth0.” This port is automatically mapped to the Management VRF when OcNOS boots, and will remain in same VRF throughout. It cannot be moved out of this VRF.

The IP address of the management port can be configured statically or via DHCP.

---

### Static IP Configuration

A static IP can be configured on the management port during ONIE installation itself, or after installation using the OcNOS CLIs commands. To configure a static IP during ONIE installation, do the following

```
#onie-stop
#ifconfig eth0 <ip address> netmask <subnet mask> up
```

Please check the Install Guide for details.

The IP address configured during ONIE installation will be applied to the management port and the same will be retained when OcNOS boot up, and the port becomes part of Management VRF.

```
#show running-config interface eth0
!
interface eth0
 ip vrf forwarding management
 ip address 10.12.44.109/24
```

After getting the OcNOS prompt, this IP address can be changed from the CLI.

#configure terminal	Enter configure mode
(config)#interface eth0	Enter interface mode
(config-if)#ip address 10.12.44.120/24	Assign an IPv4 address to the interface
(config-if)#exit	Exit interface mode
(config)#commit	Commit the candidate configuration to the running configuration
(config)#exit	Exit configure mode

If a static IP is not configured during ONIE installation the same can be configured via CLI by following the above steps. Using the OcNOS CLI, DHCP can also be enabled on the Management port.

#configure terminal	Enter configure mode
(config)#interface eth0	Enter interface mode
(config-if)#ip address dhcp	Enable DHCP on interface
(config-if)#exit	Exit interface mode
(config)#commit	Commit the candidate configuration to the running configuration
(config)#exit	Exit configure mode

---

## Obtaining IP Address via DHCP

During onie installation, the management port attempts to acquire IP address via DHCP automatically unless stopped explicitly using the `onie-stop` command. So, if management port is getting IP via DHCP, after OcNOS boots, the management port will continue to use DHCP, even when it is part of the Management VRF.

```
#show running-config interface eth0
!  
interface eth0  
 ip vrf forwarding management  
 ip address dhcp
```

After OcNOS boots, the IP address can be changed to any static IP from the command line as shown earlier.

---

## In-Band Ports

Any front-end ports of the device (in-band ports) can be made part of the management VRF. Once they are part of the management VRF they can also support all management applications such as SSH/Telnet and others as listed in [Overview](#).

Once the ports are part of the management VRF, they should not be used for data traffic and routing or switching purposes. In-band ports can be added or removed from Management VRF as and when required.

#configure terminal	Enter configure mode
(config)#interface xe1/1	Enter interface mode
(config-if)#ip vrf forwarding management	Add in-band port to Management VRF
(config-if)#exit	Exit interface mode
(config)#commit	Commit the candidate configuration to the running
(config)#exit	Exit configure mode

---

#configure terminal	Enter configure mode
(config)#interface xe1/1	Enter interface mode
(config-if)# no ip vrf forwarding management	Remove in-band port from Management VRF
(config-if)#exit	Exit interface mode
(config)#commit	Commit the candidate configuration to the running
(config)#exit	Exit configure mode

## Using Ping in Management VRF

To check reachability to any node in the management network, you need to explicitly mention the VRF name as "management."

In the following example, Node-1 has management interface eth0 and Node-2 has management interfaces eth0 and xe3/1. In order to reach the network 20.20.20.40/24 from Node-1 a static route needs to be added.

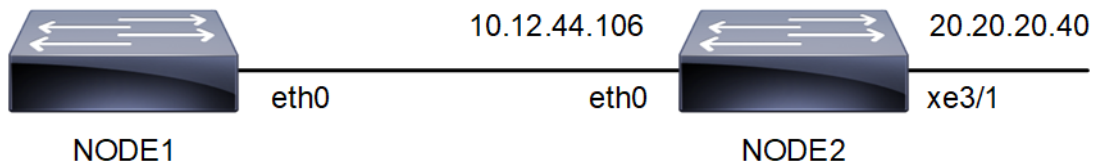

Figure 1-1: Ping in Management VRF topology

#configure terminal	Enter configure mode
(config)# ip route vrf management 20.20.20.0/24 10.12.44.106 eth0	Add static route in management VRF to reach 20.20.20.0/24 network
(config)#commit	Commit the candidate configuration to the running configuration
(config)#exit	Exit configure mode

```
Node-1#show ip route vrf management
```

```
Codes: K - kernel, C - connected, S - static, R - RIP, B - BGP
```

```
O - OSPF, IA - OSPF inter area
```

```
N1 - OSPF NSSA external type 1, N2 - OSPF NSSA external type 2
```

```
E1 - OSPF external type 1, E2 - OSPF external type 2
```

```
i - IS-IS, L1 - IS-IS level-1, L2 - IS-IS level-2, ia - IS-IS inter area,
```

```
v - vrf leaked
```

```
* - candidate default
```

```
IP Route Table for VRF "management"
```

```
C      10.12.44.0/24 is directly connected, eth0
```

```
S      20.20.20.0/24 [1/0] via 10.12.44.106, eth0
```

```
Gateway of last resort is not set
```

```
Node-1#ping 20.20.20.40 vrf management
```

```
PING 20.20.20.40 (20.20.20.40) 56(84) bytes of data.
```

```
64 bytes from 20.20.20.40: icmp_seq=1 ttl=64 time=0.494 ms
```

```
64 bytes from 20.20.20.40: icmp_seq=2 ttl=64 time=0.476 ms
```



## CHAPTER 2 User Configuration

### Overview

User management is an authentication feature that provides administrators with the ability to identify and control the users who log into the network.

OcNOS provides 4 different roles for users.

- Network Administrator: can make permanent changes to switch configuration. Changes are persistent across reset/reboot of switch.
- Network Engineer: can make permanent changes to switch configuration. Changes are persistent across reset/reboot of switch.
- Network Operator: can make permanent changes to switch configuration. Changes are not persistent across reset/reboot of switch.
- Network User: displays information; cannot modify configuration.

### User Configuration

<code>#configure terminal</code>	Enter configure mode.
<code>(config)#username user1 password user12345</code>	Create a user "user1" with password user12345 with default role of network user. Password must be 5-32 characters, username 2-15 characters.
<code>(config)#username user1 role network-operator password user12345</code>	Change the role for user1 to network-operator.
<code>(config)#username user2 role network-operator password user12345</code>	Create a user "user2" with role as network-operator.
<code>(config)#username user3 role network-admin password user12345</code>	Create a user "user3" with role as network-admin.
<code>(config)#username user4 role network-engineer password user12345</code>	Create a user "user4" with role as network-engineer.
<code>(config)#commit</code>	Commit the candidate configuration to the running configuration
<code>(config)#exit</code>	Exit configure mode.

### Validation

```
#show user-account
User:user1
roles: network-operator
User:user2
roles: network-operator
User:user3
roles: network-admin
User:user4
roles: network-engineer

#show role
```

## User Configuration

---

Role Name	Info
network-admin	Network Administrator - Have all permissions
network-engineer	Network Engineer - Can save configuration
network-operator	Network Operator - Can not save configuration
network-user	Network User - Can not change configuration
rbac-customized-role	RBAC User - Can change only permitted configuration

```
#show user-account user1
User:user1
      roles: network-operator
```

## CHAPTER 3 Telnet Configuration

### Overview

Telnet is a TCP/IP protocol used on the Internet and local area networks to provide a bidirectional interactive text-oriented communications facility using a virtual terminal connection. The Telnet program runs, connects it to a server on the network. A user can then enter commands through the Telnet program and they will be executed as if the user were entering them directly on the server console. Telnet enables users to control the server and communicate with other servers on the network. The default port number for Telnet protocol is 23. Telnet offers users the capability of running programs remotely and facilitates remote administration.

### Support for In-band Management Over Default VRF

OcNOS supports Telnet over the default and management VRFs via in-band management interface and OOB management interface, respectively.

By default, Telnet runs on the management VRF.

### Telnet Configuration with IPv4 Address

#### Topology



Figure 3-2: Telnet topology

### Enable and Disable the Telnet Server

#configure terminal	Enter configure mode
(config)#no feature telnet vrf management	Disable Telnet feature
(config)#feature telnet vrf management	Enable Telnet feature
(config)#commit	Commit the candidate configuration to the running configuration
(config)#exit	Exit configure mode

---

## Configure the Telnet Server Port

#configure terminal	Enter configure mode
(config)#no feature telnet vrf management	Disable Telnet feature
(config)#telnet server port 6112 vrf management	Set Telnet port to 61112
(config)#feature telnet vrf management	Enable Telnet feature
(config)#commit	Commit the candidate configuration to the running configuration
(config)#exit	Exit configure mode

---

## Telnet Client Session

#telnet 10.10.10.1 vrf management	Log into remote machine using IPv4 address
-----------------------------------	--

---

## Validation

```
#show telnet server

VRF MANAGEMENT
telnet server enabled port: 23
VRF DEFAULT:
telnet server enabled port: 6112

#show running-config telnet server

feature telnet vrf management
no feature telnet
```

---

## Telnet Configuration with IPv6 Address

Telnet is performed with IPv6 IP and verified by logging on remote PC.

---

## Topology

[Figure 3-3](#) shows the sample configuration of Telnet.



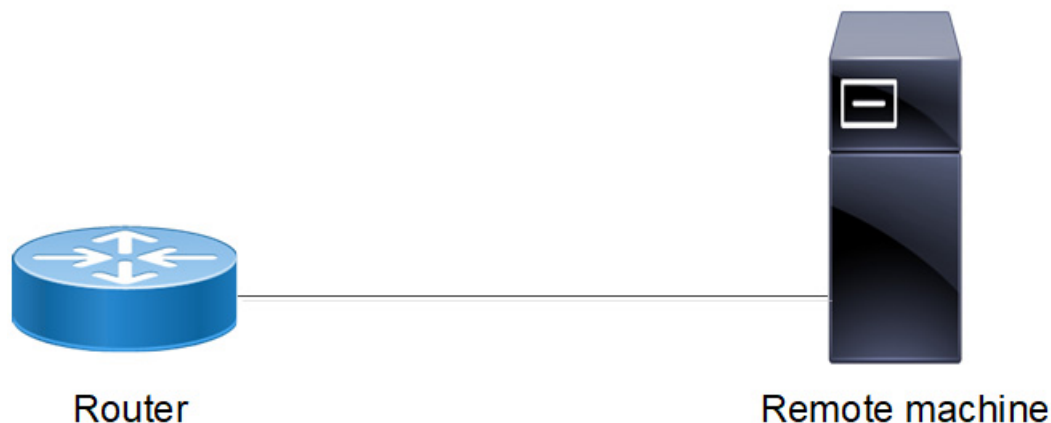

**Figure 3-3: Telnet Configuration topology**

## Basic Configuration

#configure terminal	Enter configure mode
(config)#no feature telnet vrf management	Disable Telnet feature
(config)#feature telnet vrf management	Enable Telnet feature
(config)#commit	Commit the candidate configuration to the running configuration
(config)#exit	Exit configure mode

## Configure the Telnet Server Port

#configure terminal	Enter configure mode
(config)#no feature telnet vrf management	Disable Telnet feature
(config)#telnet server port 6112 vrf management	Set Telnet port to 6112
(config)#feature telnet vrf management	Enable Telnet feature
(config)#commit	Commit the candidate configuration to the running configuration
(config)#exit	Exit configure mode

## Telnet Client Session

#telnet 2001::1 vrf management	Log into remote machine using IPv6 address
--------------------------------	--

## Validation

```
##show telnet server

VRF MANAGEMENT
telnet server enabled port: 23
```

```
VRF DEFAULT:  
telnet server enabled port: 6112  
  
#show running-config telnet server  
  
feature telnet vrf management  
no feature telnet
```

---

## CHAPTER 4 SSH Client Server Configuration

---

---

### Overview

SSH is a network protocol that allows data to be exchanged using a secure channel between two networked devices. SSH was designed as a replacement for Telnet and other insecure remote shells, which send information, notably passwords, in plain text, rendering them susceptible to packet analysis.[2] The encryption used by SSH is intended to provide confidentiality and integrity of data over an unsecured network, such as the Internet. SSH uses public-key cryptography to authenticate the remote computer and allow the remote computer to authenticate the user.

SSH is typically used to log into a remote machine and execute commands, but it also supports tunneling, forwarding TCP ports and X11 connections; it can transfer files using the associated SFTP or SCP protocols. SSH uses the client-server model

TCP port 22 is assigned for contacting SSH servers. This document covers the SSH server configuration to enable SSH service and key generation and SSH client configuration for remote login to server.

---

### In-band Management over Default VRF

OcNOS supports SSH over the default and management VRFs via the in-band management interface and out-of-band management interfaces, respectively.

SSH can run on the default and management VRFs simultaneously. By default, it runs on the management VRF.

---

### SSH Configuration

SSH is performed with IPv4 and IPv6 addresses.

---

### IPv4 Address Configuration

#### Topology



Figure 4-4: SSH sample topology

## Basic Configuration

#configure terminal	Enter configure mode
(config)#ssh login-attempts 2 vrf management	Set the number of login attempts to 2
(config)#commit	Commit the candidate configuration to the running configuration
(config)#exit	Exit configure mode

## Validation

```
#show ssh server
ssh server enabled port: 22
authentication-retries 2

#show running-config ssh server
feature ssh vrf management
ssh login-attempts 2 vrf management
```

## SSH Client Session

When the device acts as an SSH client, it supports both SSH IPv4 sessions to log into the remote machine.

#ssh root@10.10.10.1 vrf management	Log into remote machine using an IPv4 address
-------------------------------------	---

## SSH Keys

Use the ssh key command to generate new RSA/DSA keys for the SSH server. By default, the system has RSA/DSA public/private key pair placed in `/etc/ssh/`. If you want to regenerate RSA keys, you must specify the `force` option.

## Configuration

#ssh keygen host rsa vrf management	Specify the <code>force</code> option to regenerate SSH RSA keys. This option overwrites the existing key.
-------------------------------------	--

## Validation

```
#sh ssh key
*****RSA KEY*****
ssh-rsa AAAAB3NzaC1yc2EAAAADAQABAAQDMuVc0jpnGMyNzaqzIELX6LlsaK/
1q7pBixmwHAGDsZm/
dClTLb18AIB27W68YD8k0+Yw0LR0rHuPtNeSFMEsMaQxsaLkSi7yg86xSJaqqLQTyOUTS/
OC9hreXkJ73ay
n0yXa8+bre0oyJq1NWxAI9B1jEhfSSAipoDSp/
dmc93VJyV+3hgy1FMtAheyebQaUveLBEMH7siRlSfyo7OHsBYSF6GzAmSuCm6PAelpHm/
3L4gChcnPL+0outQOifCSLdUOXEZhTFXrzC61l+14Lgt8pR6YN+2uEnU6kqli
aDLEffIWK4dWCp67JUief1BTOvxRurpssuRdslhJQXDFaj
bitcount: 2048 fingerprint: a4:23:5d:8a:5a:54:8b:3e:0b:38:06:79:82:e9:83:48
*****
*****DSA KEY*****
ssh-dsa AAAAB3NzaC1kc3MAAACBALpY6MFhFPYI+VcAHzHppnwVnNXv9oR/
EGHUM50BBqdQE1Qilmlt1rft4oa4tYR46P4gazKnnNFVE/
97FwEbCZaXaz9Wzfcfa3ALtsvGdyNQQk2BebYiRnmeWnS3wGV0M/D64bAiV0
2p/
LyF6D0ygMnZ3up3ttTN5QfHeyYQtwyZAAAFQD+k6wQyr51IhXIQSSQD8by8qxjUwAAAIB0LxP31jn
fzxEXyEkNNzlxCcJ7ZzkFYUmtDJxRZlDceuSf4QipMrQVrdrgdqZNhrUIdWM/
HaCM09LdEQxfPh5TaIwPycngn
```

```
VUS83Tx577ofBW6hellTey3B3/3I+FfiGKUXS/
mZSyf5FW3swwyZwMkF0mV0SRCYTprnFt5qx8awAAAIEAjDNqMkyxUvB6JBqfo7zbGqXjBQmJ+dE8fG
jI2znlqg4lhYcMZJVNWtiydDIgMVNFfKcldAT3zr6qMZfGv56EbK
1qUu103K5CF44XfvkYNcHJV+/
fcfAJasGU8W6oSbU5Q08abyMsIGRYTurOMkRhvif6sxvieEpVnVK2/nPVVXA=
bitcount: 1024 fingerprint: d9:7a:80:e0:76:48:20:72:a6:5b:1c:67:da:91:9f:52
*****
```

Note: The newly created rsa/dsa key can be verified by logging into the device from a remote machine and checking whether the newly created key's fingerprint matches with the logging session fingerprint.

## IPv6 Address Configuration

SSH is performed with IPv6 IP and verified by logging in on remote PC.

### Topology

Figure 4-5 shows the sample configuration of SSH.

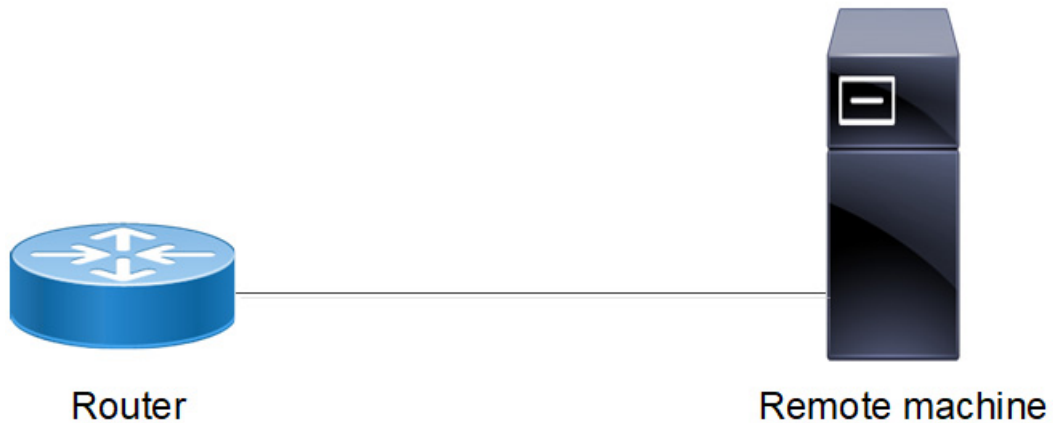

Figure 4-5: SSH Configuration topology

### DUT

#configure terminal	Enter configure mode
(config)#ssh login-attempts 2 vrf management	Set the number of login attempts to 2
(config)#commit	Commit the candidate configuration to the running configuration
(config)#exit	Exit configure mode

### Validation

```
#show ssh server ssh server
ssh server enabled port: 22
authentication-retries 2
```

```
#show running-config ssh server
feature ssh vrf management
ssh login-attempts 2 vrf management
```

## SSH Client Session

When the device acts as an SSH client, it supports both SSH IPv6 sessions to log into the remote machine.

---

#ssh root@2001::1 vrf management	Log into remote machine using an IPv6 address
----------------------------------	---

---

## SSH Keys

Use the SSH key command to generate new RSA/DSA keys for the SSH server. By default, the system has RSA/DSA public/private key pair placed in `/etc/ssh/`. If you want to regenerate RSA keys, you must specify the force option.

---

#ssh keygen host rsa vrf management	Specify the <code>force</code> option to regenerate SSH RSA keys. This option overwrites the existing key.
-------------------------------------	--

---

## Validation

```
#sh ssh key *****RSA KEY*****
ssh-rsa AAAAB3NzaC1yc2EAAAADAQABAAQDMuVc0JpNgMyNzaqzIELX6LlsaK/ 1q7pBixmwHAGDsZm/
dC1TLb18AIB27W68YD8k0+Yw0LR0rHuPtNeSFMEsMaQxsaLkSi7yg86xSJaqgLQTyOUTS/ OC9hreXkJ73ay
n0yXa8+bre0oyJq1NWxAI9B1jEhfSSAipoDsp/
dmc93VJyV+3hgylFMTAheyebQaUveLBEMH7sir1Sfyo7OHsBYSF6GzAmSuCm6PAelpHm/
3L4gChcnPL+0outQOifCSLdUOXEZhTFXrzC611+14Lgt8pR6YN+2uEnU6kqli
adLEffIWK4dWCP67JUief1BTOvxRurpssuRdslhJQXDFaj bitcount: 2048 fingerprint:
a4:23:5d:8a:5a:54:8b:3e:0b:38:06:79:82:e9:83:48 *****
*****DSA KEY*****
ssh-dsa AAAAB3NzaC1kc3MAAACBALpY6MFhFPYI+VcAHzHppnwVnNXv9oR/
EGHUM50BBqdQE1Qilmlt1rft4oa4tYR46P4gazKnnNfVE/
97FwEbCZaXaz9Wzfcfa3ALtsvGdyNQqk2BebYiRnmeWnS3wGV0M/D64bAiV0 2p/
LyF6D0ygMnZ3up3ttTN5QfHeyYQtwyzAAAAFQD+k6wQyr51IhXIQSSQD8by8qxjUwAAAIb0LxP31jn
fzxEXyEkNNzlxCcJ7ZzkFYUmtDJxRZlDceusf4QipMrQVrdrgdqZNhrUiDWM/
HaCM09LdEQxfPh5TaIwPycngn VUS83Tx577ofBW6hell1Tey3B3/3I+FfiGKUXS/
mZSyf5FW3swwyZwMkF0mV0SRCYTprnFt5qx8awAAAIeAjDNqMkyxUvB6JBqfo7zbGqXjBQmJ+dE8fG
jI2znlgg4lhYcmZJVNWtIydDIgMVNfKc1dAT3zr6qMzFGv56EbK1qUu103K5CF44XfVkyNcHJV+/
fcfAJasGU8W6oSbU5Q08abyMsIGRYTurOMkRhvif6sxvieEpVnVK2/nPVVXA= bitcount: 1024
fingerprint: d9:7a:80:e0:76:48:20:72:a6:5b:1c:67:da:91:9f:52
*****
```

---

## SSH Encryption Cipher

Specify an SSH cipher to encrypt an SSH session. By default, all the ciphers are supported for a new SSH client to connect to the SSH server.

SSH supports these encryption algorithms:

- Advanced Encryption Standard Counter:
  - aes128-ctr
  - aes192-ctr
  - aes256-ctr
  - aes128-cbc
- Advanced Encryption Standard Cipher Block Chaining:
  - aes192-cbc
  - aes256-cbc
- Triple Data Encryption Standard Cipher Block Chaining:

- 3des-cbc

---

## Configuration

#configure terminal	Enter configure mode
(config)#ssh server algorithm encryption aes128-ctr vrf management	Set the SSH server encryption algorithm to AES 128 bit counter
(config)#ssh server algorithm encryption aes128-cbc vrf management	Set the SSH server encryption algorithm to AES 128 cipher block chaining
(config)#commit	Commit the candidate configuration to the running configuration
(config)#exit	Exit configure mode

---

## Validation

The new cipher encryption algorithm takes effect for a new incoming ssh client connection.

```
#show running-config ssh server
feature ssh vrf management
ssh server algorithm encryption aes128-ctr aes128-cbc vrf management
```

---

## SSH Client Session

#ssh cipher aes128-ctr root@1.1.1.1 vrf management	Specify AES 128-bit counter encryption to establish an SSH connection to a remote machine using an IPv4 address
--	---

---

## SSH Key-Based Authentication

Enable OcNOS device SSH server to perform public key based SSH authentication, to enable machine to machine communication possible without requiring password. Public key based authentication increases the trust between two Linux servers for easy file synchronization or transfer. Public-key authentication with SSH is more secure than password authentication, as it provides much stronger identity checking through keys.

## Topology



Figure 4-6: SSH Key-based authentication

## Public Key Authentication Method

The server has the public key of the user stored; using this the server creates a random value, encrypts it with the public key and sends it to the user. If the user is who is supposed to be, he can decrypt the challenge using the private key and send it back to the server, server uses the public key again to decrypt received message to confirm the identity of the user. SSH is supported in-band (default VRF) and out of band (management VRF). Installed keys are stored in the `~/.ssh/authorized_keys` file.

SSH key based authentication steps:

1. Login to remote machine Linux desktop (ssh client) and generate the key pair using the `ssh-keygen` command.
2. Create the username in OcnOS device (ssh server).
3. Install the public key of remote Linux ssh client in the OcnOS device.
4. Display the installed key in the OcnOS device using the `show running-config` command.
5. Log in from the remote Linux ssh client to the OcnOS device without providing a password.

## Useful Commands on Remote Desktop Client

<code># ssh-keygen</code>	To generate key pair on remote Linux machine (ssh client)
<code># cd /bob/.ssh/</code>	To go to the location of saved key pair
<code># cat id_rsa.pub</code>	Command to display the generated public key in remote Linux client

## Configuration commands in OcnOS

<code>(config)#configure terminal</code>	Enter configure mode.
<code>(config)#feature ssh vrf management</code>	Enable the SSH feature on vrf management. To enable in default vrf give the command "feature ssh"



(config)#username fred	To create username with default role as network-user. To create user with different role specify role using command "username <username> role <role_name>
(config)#username fred sshkey ssh-rsa AAAAB3NzaC1yc2EAAAADAQABAAQBAQC8XhFiGlZP6yY6qIWUkew884NvqXqMPSOw3fQe5kgpXvX0SbcU15axI/VHVgU2Y0/ ogAtRUlAk5soRrf5lZ2+rT0zNP37m+Tm5HIEFKZZut0FffGSuXtPKbE+GGlQYHEzC8RSnqQuHlxlrlve3lGbB1UxuWhMzJfgc2vZ78V2znd2zk4ygiN1jxlse8UI98WyIcwuq44tzuIaUYAICIfRQJXriQml+QcJ9NER5O8rMS5D5NnTVhlnroqoozY8i/qMKfhCFMbysjiDMHU9GclNsNbIF/DQbvWESkFFEvf6fOrzXyvq26NpgaJnZ4pQVzgzOaVw16Cy3csoTncw0vyXV bob@localhost.localdomain	Install the public key of remote Linux client in OcNOS device.
(config)#commit	Commit the candidate configuration to the running
(config)#exit	Exit configure mode.

## Validation

The new cipher encryption algorithm takes effect for a new incoming ssh client connection.

```
#show running-config
```

```
<skipped other content>
```

```
feature ssh vrf management
```

```
username fred role network-user
```

```
username fred sshkey
```

```
ssh-rsa
```

```
AAAAB3NzaC1yc2EAAAADAQABAAQBAQC8XhFiGlZP6yY6qIWUkew884NvqXqMPSOw3fQe5kgpXvX0SbcU15axI/VHVgU2Y0/
```

```
ogAtRUlAk5soRrf5lZ2+rT0zNP37m+Tm5HIEFKZZut0FffGSuXtPKbE+GGlQYHEzC8RSnqQuHlxlrlve3lGbB1UxuWhMzJfgc2vZ78V2znd2zk4ygiN1jxlse8UI98WyIcwuq44tzuIaUYAICIfRQJXriQml+QcJ9NER5O8rMS5D5NnTVhlnroqoozY8i/qMKfhCFMbysjiDMHU9GclNsNbIF/
```

```
DQbvWESkFFEvf6fOrzXyvq26NpgaJnZ4pQVzgzOaVw16Cy3csoTncw0vyXV bob@localhost.localdomain
```

```
<skipped other content>
```

```
#show running-config ssh server
```

```
feature ssh vrf management
```

## SSH Key-based Client Session

#ssh fred@10.10.26.186	Specify user name and ip address to access the device. Supports IPv4 and IPv6. User should be able to access without password and through key based authentication
------------------------	--

## Restrictions

- Key generation or installation are not supported for "root" user account in OcNOS device.
- Third party SSH utilities cannot be used for key installation, rather OcNOS CLI is the only way to install public keys.

---

## Sample Use Case

1. Login to remote machine linux desktop (ssh client) and generate the key pair using the `ssh-keygen` command.

```
[bob@localhost ~]# ssh-keygen
Generating public/private rsa key pair.
Enter file in which to save the key (/bob/.ssh/id_rsa):
/bob/.ssh/id_rsa already exists.
Overwrite (y/n)? y
Enter passphrase (empty for no passphrase):
Enter same passphrase again:
Your identification has been saved in /bob/.ssh/id_rsa.
Your public key has been saved in /bob/.ssh/id_rsa.pub.
The key fingerprint is:
b2:d0:cc:d2:dd:db:3d:05:c1:33:fc:4a:df:8e:85:af bob@localhost.localdomain
The key's randomart image is:
+--[ RSA 2048 ]-----+
|           o. |
|            =. |
|           .+ |
|          = . . . . .|
|         o * S . . +o|
|          o o  o .o.+|
|           . . . o= |
|            ..o|
|             E. |
+-----+
[bob@localhost ~]# cd /bob/.ssh/
[bob@localhost .ssh]# cat id_rsa.pub

ssh-rsa
AAAAB3NzaC1yc2EAAAADAQABAAQCAQC8XhFiGlZP6yY6qIWUkew884NvqXqMPSOw3fQe5kqpXvX0SbcU15axI/
VHVgU2Y0/
ogAtRUlAk5soRrf5lZ2+rT0zNP37m+Tm5HIEFKZzut0FffGSuXtPKbE+GGlQYHEzC8RSnqQuHlxlrlve3lGbB1UU
xuWhMzJfgc2vZ78V2znd2zk4ygiN1jx1sE8UI98WyIcwuq44tzuIaUYAICIfRQJXriQml+QcJ9NER5O8rMS5D5N
nTVhlnroqoozY8i/qMKfhCFMbysjiDMHU9GclNsNbIF/
DQbvWESkFFEvf6fOrzXyvq26NpgaJnZ4pQVzGkOaVw16Cy3csoTncw0vyXV bob@localhost.localdomain
[bob@localhost .ssh]#
```

2. Create username in OcnOS switch device (ssh server)

```
(config)#username fred
```

**Note:** By default, the user role is `network-user`.

3. Install the public key of remote Linux ssh client in OcnOS device.

```
(config)#username fred sshkey
ssh-rsa
AAAAB3NzaC1yc2EAAAADAQABAAQCAQC8XhFiGlZP6yY6qIWUkew884NvqXqMPSOw3fQe5kqpXvX0SbcU15axI/
VHVgU2Y0/
ogAtRUlAk5soRrf5lZ2+rT0zNP37m+Tm5HIEFKZzut0FffGSuXtPKbE+GGlQYHEzC8RSnqQuHlxlrlve3lGbB1UU
xuWhMzJfgc2vZ78V2znd2zk4ygiN1jx1sE8UI98WyIcwuq44tzuIaUYAICIfRQJXriQml+QcJ9NER5O8rMS5D5N
nTVhlnroqoozY8i/qMKfhCFMbysjiDMHU9GclNsNbIF/
DQbvWESkFFEvf6fOrzXyvq26NpgaJnZ4pQVzGkOaVw16Cy3csoTncw0vyXV bob@localhost.localdomain
```

4. Display the installed key in OcnOS device using the `show running-config` command.

```
#show running-config
```

---

```
<skipped other content>
username fred role network-user
username fred sshkey
ssh-rsa
AAAAB3NzaC1yc2EAAAADAQABAAQAC8XhFiGlzP6yY6qIWUkew884NvqXqMPSOw3fQe5kgpXvX0SbcU15axI/
VHVgU2Y0/
ogAtRUlAk5soRrf5lZ2+rT0zNP37m+Tm5HIEFKZZut0FffGSuXtPKbE+GGlQYHEzC8RSnqQuHlxlve3lGbB1UU
xuWhMzJfgc2vZ78V2znd2zk4ygiN1jx1sE8UI98WyIcwuq44tzuIaUYAICIfRQJXriQml+QcJ9NER5O8rMS5D5N
nTVhlnroqoozY8i/qMKfhCFMbySjiDMHU9GclNsNbIF/
DQbvWEskFFEvf6fOrzXyvq26NpgaJnZ4pQVzGkOaVw16Cy3csoTncw0vyXV bob@localhost.localdomain
<skipped other content>
```

##### 5. Login from remote Linux ssh client to OcnOS device without providing password

```
[bob@localhost .ssh]# ssh fred@10.10.26.186
```



## CHAPTER 5 DHCP Client Configuration

### Overview

Dynamic Host Configuration Protocol (DHCP) protocol is used for assigning dynamic IP addresses to systems on a network. Dynamic addressing allows a system to have an IP address each time it connects to the network. DHCP makes network administration easier by removing the need to manually assign a unique IP address every time a new system is added to the network. It is especially useful to manage mobile users. Once a system is configured to use DHCP, it can be automatically configured on any network that has a DHCP server.

DHCP uses a client-server model, in which the DHCP server centrally manages the IP addresses used in the network. DHCP clients obtain an IP address on lease from the DHCP server.

### DHCP Client Configuration for IPv4

Before configuring the DHCP in client, make sure that DHCP server is ready and also dhcpd is running on the server machine.



Figure 5-7: DHCP sample topology

#configure terminal	Enter Configure mode.
(config)#feature dhcp	Enable the feature dhcp. This will be enabled by default.
(config)#interface xe1	Specify the interface(xe1) to be configured and enter the interface mode.
(config-if)#ip address dhcp	The client requests for the IP address to the server, once it receives the acknowledgment from the server, it assigns the IP address to the interface in which this command is enabled.
(config if)#exit	Exit interface mode.
(config)#commit	Commit the candidate configuration to the running configuration.
(config)#interface eth0	Enter management interface mode.
(config-if)#ip address dhcp	The client requests for the IP address to the server, once it receives the Acknowledgement from the server, it assigns the IP address to the management interface.

(config if)#exit	Exit interface mode.
(config)#commit	Commit the candidate configuration to the running configuration.

---

### Validation Commands

```
#show running-config dhcp
  interface xe2
    ip address dhcp
  !
ip dhcp relay information option
```

```
#sh ip interface brief
```

Interface	IP-Address	Admin-Status	Link-Status
GMPLS Type			
eth0	10.12.44.20	up	up
-			
lo	127.0.0.1	up	up
-			
lo.4	127.0.0.1	up	up
-			
vlan1.1	unassigned	up	down
-			
xe1/1	2.2.2.3	up	up
-			
xe1/2	unassigned	down	down
-			
xe1/3	unassigned	down	down
-			
xe1/4	unassigned	up	down
-			
xe2	*40.40.40.40	up	down
-			
xe3/1	20.20.30.1	up	up
-			

---

### DHCP Client Configuration for IPv6

Before configuring the DHCP in client, make sure that DHCP server is ready and also dhcpd is running on the server machine.

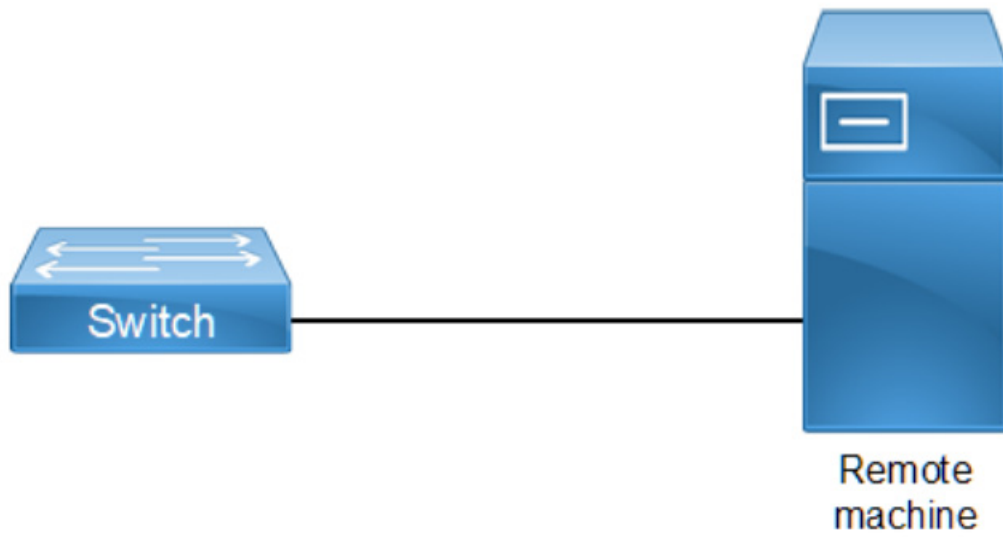

**Figure 5-8: DHCP sample topology**

#configure terminal	Enter Configure mode.
(config)#feature dhcp	Enable the feature dhcp. This will be enabled by default.
(config)#interface xe1	Specify the interface(xe1) to be configured and enter the interface mode.
(config-if)#ipv6 dhcp client request dns-nameserver	The client request for name-server configured in server
(config-if)#ipv6 dhcp client request domain-search	The client request for domain names with ip
(config-if)#ipv6 dhcp client request ntp-server	The client request for Ntp server details configured in server
(config-if)#ipv6 dhcp client request rapid-commit	Enables rapid commit option
(config-if)#ipv6 dhcp client request vendor-specific-information	The client request for vendor specific information
(config-if)#ipv6 dhcp client duid llt	Set duid type for DHCP Client. Possible values are llt or ll
(config-if)#ipv6 dhcp client dad-wait-time 300	Max time that the client process should wait for the duplicate address detection to complete before initiating DHCP requests
Values range from 1 - 600	
(config-if)#ipv6 address dhcp	The client requests for the IP address to the server, once it receives the acknowledgment from the server, it assigns the IP address to the interface in which this command is enabled.
(config if)#exit	Exit interface mode.
(config)#commit	Commit the candidate configuration to the running
(config)#interface eth0	Enter management interface mode.
(config-if)#ip address dhcp	The client requests for the IP address to the server, once it receives the Acknowledgement from the server, it assigns the IP address to the management interface.

(config if)#exit	Exit interface mode.
(config)#commit	Commit the candidate configuration to the running.

---

### Validation Commands

```
OcNOS#show ipv6 interface brief
```

Interface	IPv6-Address	Admin-Status
ce20	fe80::eac5:7aff:fe28:a67b	[up/up]
ce21	fe80::eac5:7aff:fe28:a67c	[up/down]
eth0	fe80::eac5:7aff:fe8e:c365	[up/up]
xel	fe80::eac5:7aff:fe28:a66b	[up/up]

```
OcNOS#show ipv6 dhcp vendor-opts
```

Interface name	vendor-opts
xel	0:0:9:bf:0:1:0:c:48:65:6c:6c:6f:20:77:6f:72:6c:64:21

```
OcNOS#show running-config dhcp
```

```
interface eth0
 ip address dhcp
!
interface xel
 ipv6 dhcp client request dns-nameserver
 ipv6 dhcp client request domain-search
 ipv6 dhcp client request ntp-server
 ipv6 dhcp client request rapid-commit
 ipv6 dhcp client request vendor-specific-information
 ipv6 dhcp client duid llt
 ipv6 dhcp client dad-wait-time 300
 ipv6 address dhcp
!
!
```



## CHAPTER 6 DHCP Relay Agent Configuration

### Overview

The DHCP Relay feature was designed to forward DHCP broadcast requests as unicast packets to a configured DHCP server or servers for redundancy.

### DHCP Relay for IPv4

Before configuring DHCP Relay, make sure DHCP server and client configurations are done.

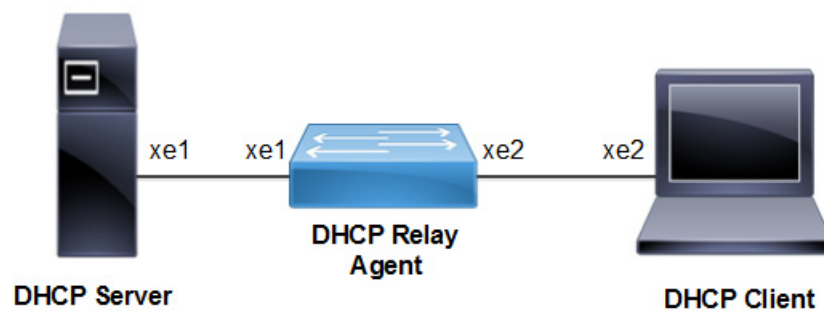

Figure 6-9: DHCP Relay Configuration

### DHCP Agent

#configure terminal	Enter configure mode.
(config)#feature dhcp	Enable the feature dhcp. This is enabled by default.
(config)#ip dhcp relay	By default this will be enabled. It starts the ip dhcp relay service.
(config)#ip dhcp relay address 10.10.10.2	The relay address configured should be server interface address connected to DUT machine.
(config)#interface xe1	Enter interface mode.
(config-if)#ip address 10.10.10.1/24	Configure ipv4 address on the interface xe1.
(config-if)#ip dhcp relay uplink	Configure relay uplink on the device connecting the server.
(config-if)#exit	Exit interface mode.
(config)#commit	Commit the candidate configuration to the running
(config)#interface xe2	Enter interface mode.
(config-if)#ip address 20.20.20.1/24	Configure ipv4 address on the interface xe2.
(config-if)#ip dhcp relay	Relay should be configured on the interface connecting to the client.
(config-if)#exit	Exit interface mode.
(config)#commit	Commit the candidate configuration to the running

**Validation Commands**

```
#show running-config dhcp

ip dhcp relay address 10.10.10.2
interface xe2
  ip dhcp relay
!
interface xe1
  ip dhcp relay uplink
!

#show ip dhcp relay
DHCP relay service is Enabled.
VRF Name: default
Option 82: Disabled
DHCP Servers configured: 10.10.10.2
Interface                Uplink/Downlink
-----                -
xe2                      Downlink
xe1                      Uplink

#show ip dhcp relay address
VRF Name: default
DHCP Servers configured: 10.10.10.2
```

**DHCP Relay for IPv6 Configuration****DHCP Agent**

#configure terminal	Enter configure mode.
(config)#feature dhcp	Enable the feature dhcp. This is enabled in default.
(config)#ipv6 dhcp relay	By default this will be enabled. It starts the ipv6 dhcp relay service.
(config)#ipv6 dhcp relay address 2001::2	The relay address configured should be server interface address connected to DUT machine.
(config)#interface xe1	Enter interface mode.
(config-if)#ipv6 address 2001::1/64	Configure ipv6 address on the interface xe1.
(config-if)#ipv6 dhcp relay uplink	Configure relay uplink on the device connecting the server.
(config-if)#exit	Exit interface mode.
(config)#commit	Commit the candidate configuration to the running configuration
(config)#interface xe2	Enter interface mode.
(config-if)#ipv6 address 2002::1/64	Configure ipv6 address on the interface xe2.
(config-if)#ipv6 dhcp relay	Relay should be configured on the interface connecting to the client.
(config-if)#exit	Exit interface mode.
(config)#commit	Commit the candidate configuration to the running configuration

## Validation Commands

```
#sh ipv6 dhcp relay address

VRF Name: default
  DHCPv6 Servers configured: 2001::2

#show running-config dhcp

Ipv6 dhcp relay address 2001::2
  interface xe2
  ipv6 dhcp relay
!
interface xe1
  ipv6 dhcp relay uplink
!
```

## DHCP Relay option 82

This section contains examples of DHCP Relay option-82 configuration. DHCP option 82 (Agent Information Option) provides additional security when DHCP is used to allocate network addresses. It enables the DHCP relay agent to prevent DHCP client requests from untrusted sources. Service Providers use remote identifier (option 82 sub option 2) for troubleshooting, authentication, and accounting. The DHCP Option 82 Remote ID Format feature adds support for the interpretation of **remote-IDs** that are inserted by end users. On the relay agent, you can configure information option to add option 82 information to DHCP requests from the clients before forwarding the requests to the DHCP server. When configured with option 82 and remote-id, the server will receive the DHCP request packet with Agent Circuit ID and remote-id.

The two examples below, show how to configure the DHCP Relay option 82:

- Configuration of DHCP Relay option 82 on a physical interface with Agent information and remote-id.
- Configuration of DHCP Relay option 82 on a VLAN interface with Agent information and remote-id.

## Topology

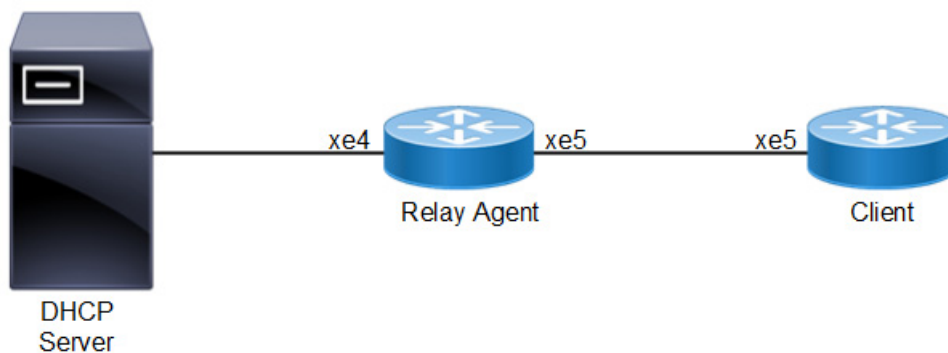

Figure 6-10: DHCP 82 interface topology

## Physical Interface Configuration

Here, the DHCP Server is running with IP 192.168.1.2 with another pool of subnet 10.10.20.0 configured in the server. Configure a static route to 10.10.20.0 network for `DHCP OFFER` packets to reach the Relay Agent.

## Relay agent

#configure terminal	Enter configure mode.
(config)#ip dhcp relay	Enable DHCP Relay
(config)#ip dhcp relay address 192.168.1.2	The relay address configured should be server interface address connected to DUT machine
(config)#ip dhcp relay information option remote-id hostname	Enable DHCP Relay information option with both agent circuit id which is sub option 1 of option 82 and remote-id which is sub option 2 of option 82. String support is also provided for remote-id.
(config)#interface xe5	Enter interface mode.
(config-if)#ip address 10.10.20.2/24	Add IP address
(config-if)#ip dhcp relay	Configure DHCP relay for the interface connecting to client.
(config-if)#exit	Exit from interface mode
(config)#commit	Commit the candidate configuration to the running
(config)#interface xe4	Enter interface mode
(config-if)#ip address 192.168.1.1/24	Configure ipv4 address on the interface xe4
(config-if)#ip dhcp relay uplink	Configure DHCP relay uplink for the interface connecting to server.
(config-if)#exit	Exit interface mode.
(config)#commit	Commit the candidate configuration to the running

## Client

#configure terminal	Enter configure mode.
(config)#interface xe5	Enter interface mode.
(config-if)#ip address dhcp	Configure IP address DHCP
(config-if)#exit	Exit from interface mode
(config)#commit	Commit the candidate configuration to the running

## Validation

### Relay Agent

```
#show running-config dhcp
!
ip dhcp relay information option remote-id hostname
ip dhcp relay address 192.168.1.2
interface xe5
 ip dhcp relay
!
interface xe4
 ip dhcp relay uplink
!

#show ip dhcp relay
DHCP relay service is Enabled.
VRF Name: default
```

```

Option 82: Enabled
Remote Id: OcNOS
DHCP Servers configured: 192.168.1.2
Interface          Uplink/Downlink
-----          -
xe5                Downlink
xe4                Uplink

```

## Client

```

#show ip interface brief | include xe5
xe5          *10.10.20.10      up          up

```

Packet captured at DHCP Server

```

Bootstrap Protocol (Discover)
  Message type: Boot Request (1)
  Hardware type: Ethernet (0x01)
  Hardware address length: 6
  Hops: 1
  Transaction ID: 0x4e61176c
  Seconds elapsed: 0
  Bootp flags: 0x0000 (Unicast)
    0... .... .... .... = Broadcast flag: Unicast
    .000 0000 0000 0000 = Reserved flags: 0x0000
  Client IP address: 0.0.0.0 (0.0.0.0)
  Your (client) IP address: 0.0.0.0 (0.0.0.0)
  Next server IP address: 0.0.0.0 (0.0.0.0)
  Relay agent IP address: 10.10.20.2 (10.10.20.2)
  Client MAC address: b8:6a:97:35:d7:9d (b8:6a:97:35:d7:9d)
  Client hardware address padding: 00000000000000000000
  Server host name not given
  Boot file name not given
  Magic cookie: DHCP
  Option: (53) DHCP Message Type (Discover)
    Length: 1
    DHCP: Discover (1)
  Option: (55) Parameter Request List
    Length: 3
    Parameter Request List Item: (1) Subnet Mask
    Parameter Request List Item: (28) Broadcast Address
    Parameter Request List Item: (3) Router
  Option: (60) Vendor class identifier
    Length: 39
    Vendor class identifier: onie_vendor:x86_64-accton_as7326_56x-r0
  Option: (82) Agent Information Option
    Length: 12
    Option 82 Suboption: (1) Agent Circuit ID
      Length: 3
      Agent Circuit ID: 786535
    Option 82 Suboption: (2) Agent Remote ID
      Length: 5
      Agent Remote ID: 4f634e4f53
  Option: (255) End
    Option End: 255
  Padding

```

## Physical Interface Configuration with non-default VRF

Here, the DHCP Server is running with IP 192.168.1.2 with another pool of subnet 10.10.20.0 configured in the server. Configure a static route to 10.10.20.0 network for DHCP OFFER packets to reach the Relay Agent.

### Relay agent

#configure terminal	Enter configure mode.
(config)#ip dhcp relay	Enable DHCP Relay.
(config)#ip vrf vrf_dhcp	Configuring non default vrf vrf_dhcp
(config-vrf)#ip dhcp relay information option remote-id hostname	Enable DHCP Relay information option with both agent circuit id which is sub option 1 of option 82 and remote-id which is sub option 2 of option 82 on non default vrf.. String support is also provided for remote-id.
(config-vrf)#ip dhcp relay address 192.168.1.2	Configure DHCP relay address in non default vrf.
(config)#interface xe5	Enter interface mode.
(config-if)#ip vrf forwarding vrf_dhcp	Configure vrf forwarding for vrf_dhcp.
(config-if)#ip address 10.10.20.2/24	Add IP address.
(config-if)#ip dhcp relay	Configure DHCP relay for the interface connecting to client.
(config-if)#exit	Exit from interface mode
(config)#commit	Commit the candidate configuration to the running
(config)#interface xe4	Enter interface mode
(config-if)#ip vrf forwarding vrf_dhcp	Configure vrf forwarding for vrf_dhcp
(config-if)#ip dhcp relay uplink	Configure DHCP relay uplink for the interface connecting to server.
(config-if)#ip address 192.168.1.4/24	Add IP address.
(config-if)#exit	Exit interface mode.
(config)#commit	Commit the candidate configuration to the running

### Client

#configure terminal	Enter configure mode.
(config)#interface xe5	Enter interface mode.
(config-if)#ip vrf forwarding vrf_dhcp	Configure ip vrf forwarding for non default vrf.
(config-if)#ip address dhcp	Configure IP address DHCP.
(config-if)#exit	Exit from interface mode.
(config)#commit	Commit the candidate configuration to the running

### Validation

#### Relay Agent

```
#show running-config dhcp
```

```

!
ip vrf vrf_dhcp
 ip dhcp relay information option remote-id hostname
 ip dhcp relay address 192.168.1.2
interface xe5
 ip dhcp relay
!
interface xe4
 ip dhcp relay uplink
!

#show ip dhcp relay
DHCP relay service is Enabled.
VRF Name: vrf_dhcp
  Option 82: Enabled
  Remote Id: OcNOS
  DHCP Servers configured: 192.168.1.2
  Interface                Uplink/Downlink
  -----
  xe5                       Downlink
  xe4                       Uplink

```

**Client**

```

#show ip interface brief | include xe5
xe5          *10.10.20.10      up

Packet captured at DHCP Server

Bootstrap Protocol (Discover)
  Message type: Boot Request (1)
  Hardware type: Ethernet (0x01)
  Hardware address length: 6
  Hops: 1
  Transaction ID: 0x4e61176c
  Seconds elapsed: 0
  Bootp flags: 0x0000 (Unicast)
    0... .... = Broadcast flag: Unicast
    .000 0000 0000 0000 = Reserved flags: 0x0000
  Client IP address: 0.0.0.0 (0.0.0.0)
  Your (client) IP address: 0.0.0.0 (0.0.0.0)
  Next server IP address: 0.0.0.0 (0.0.0.0)
  Relay agent IP address: 10.10.20.2 (10.10.20.2)
  Client MAC address: b8:6a:97:35:d7:9d (b8:6a:97:35:d7:9d)
  Client hardware address padding: 00000000000000000000
  Server host name not given
  Boot file name not given
  Magic cookie: DHCP
  Option: (53) DHCP Message Type (Discover)
    Length: 1
    DHCP: Discover (1)
  Option: (55) Parameter Request List
    Length: 3
    Parameter Request List Item: (1) Subnet Mask
    Parameter Request List Item: (28) Broadcast Address
    Parameter Request List Item: (3) Router
  Option: (60) Vendor class identifier

```

```
Length: 39
Vendor class identifier: onie_vendor:x86_64-accton_as7326_56x-r0
Option: (82) Agent Information Option
Length: 12
Option 82 Suboption: (1) Agent Circuit ID
Length: 3
Agent Circuit ID: 786535
Option 82 Suboption: (2) Agent Remote ID
Length: 5
Agent Remote ID: 4f634e4f53
Option: (255) End
Option End: 255
Padding
```

Sample DHCP configuration for using Remote-id

```
class "remote-id" {
    match if option agent.remote-id = OcNOS
} # remote-id

subnet 10.10.20.0 netmask 255.255.255.0 {
    pool {
        allow members of                "remote-id";
        default-lease-time                600;
        max-lease-time                    7200;
        range                              10.10.20.3 10.10.10.100;
        option routers                    10.10.20.2;
        option broadcast-address          10.10.20.255;
        option subnet-mask                255.255.255.0;
        option domain-name-servers        4.2.2.2;
    }
}
```

---

## VLAN Interface Configuration

### Topology

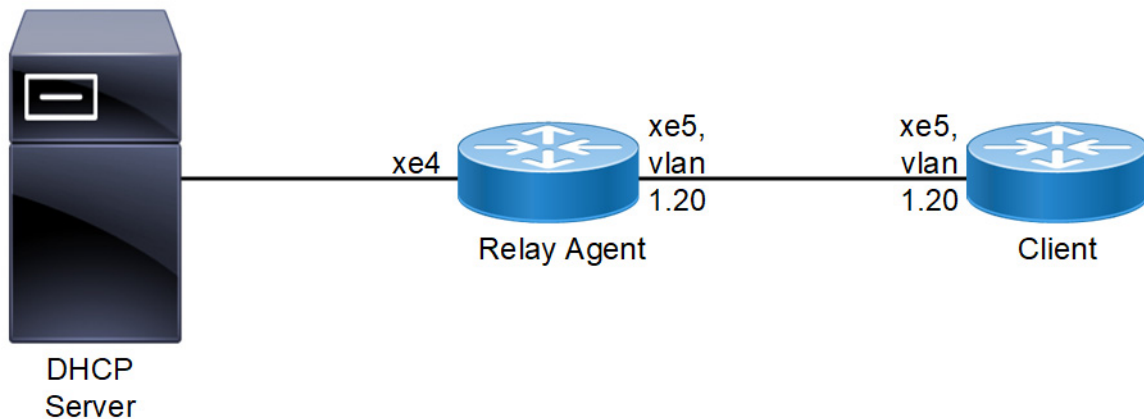

**Figure 6-11: DHCP 82 vlan topology**

Here, the DHCP Server is running with IP 192.168.1.2 with another pool of subnets 10.10.20.0 configured in the server. Configure a static route to 10.10.20.0 network for DHCP OFFER packets to reach the Relay Agent. In the above topology, vlan 20 is part of interface xe5 in relay Agent and xe5 in Client.



**Relay Agent**

t	
#configure terminal	Enter configure mode.
(config)#ip dhcp relay	Enable DHCP Relay
(config)#ip dhcp relay information option remote-id hostname	Enable DHCP Relay information option with both agent circuit id which is sub option 1 of option 82 and remote-id which is sub option 2 of option 82. String support is also provided for remote-id.
(config)#ip dhcp relay address 192.168.1.2	Configure DHCP relay address
(config)#bridge 1 protocol rstp vlan-bridge	Configure bridge
(config)#vlan 2-100 bridge 1 state enable	Enable some VLANs
(config)#interface xe5	Enter interface mode
(config-if)#switchport	Configure switchport
(config-if)#bridge-group 1	Configure bridge-group
(config-if)#switchport mode hybrid	Configure switchport mode
(config-if)#switchport hybrid allowed vlan all	Enable vlan
(config-if)#exit	Exit from interface mode
(config)#commit	Commit the candidate configuration to the running
(config)#interface vlan1.20	Enter interface mode for the vlan interface towards client.
(config-if)#ip address 10.10.20.2/24	Add IP address
(config-if)#ip dhcp relay	Configure DHCP relay on the vlan interface connecting to client.
(config-if)#exit	Exit from interface mode
(config)#commit	Commit the candidate configuration to the running
(config)#interface xe4	Enter interface mode
(config-if)#ip dhcp relay uplink	Configure DHCP relay uplink for the interface connecting to server.
(config-if)#ip address 192.168.1.4/24	Add IP address
(config-if)#exit	Exit interface mode.
(config)#commit	Commit the candidate configuration to the running

**Client**

#configure terminal	Enter configure mode.
(config)#bridge 1 protocol rstp vlan-bridge	Configure bridge
(config)#vlan 2-100 bridge 1 state enable	Enable VLANs
(config)#interface xe5	Enter interface mode.
(config-if)#switchport	Configure switchport
(config-if)#bridge-group 1	Configure bridge-group
(config-if)#switchport mode hybrid	Configure switchport mode
(config-if)#switchport hybrid allowed vlan add 20 egress-tagged enable	Enable vlan
(config-if)#exit	Exit from interface mode

## DHCP Relay Agent Configuration

---

(config)#commit	Commit the candidate configuration to the running
(config)#interface vlan1.20	Enter interface mode for the vlan interface which connects relay.
(config-if)#ip address dhcp	Configure IP address DHCP
(config-if)#exit	Exit from interface mode
(config)#commit	Commit the candidate configuration to the running

---

## Validation

### Relay Agent

```
#show running-config dhcp
!
ip dhcp relay information option remote-id hostname
ip dhcp relay address 192.168.1.2
!
interface vlan1.20
 ip dhcp relay
!
interface xe4
 ip dhcp relay uplink
!
```

```
#show ip dhcp relay
DHCP relay service is Enabled.
VRF Name: default
Option 82: Enabled
Remote Id: ocnos
DHCP Servers configured: 192.168.1.2
Interface                Uplink/Downlink
-----                -
Vlan1.20                  Downlink
xe4                       Uplink
```

### Client

```
#show ip interface brief |include vlan1.20
vlan1.20          *10.10.20.10      up                up
```

Packet captured at DHCP Server

```
Bootstrap Protocol (Discover)
Message type: Boot Request (1)
Hardware type: Ethernet (0x01)
Hardware address length: 6
Hops: 1
Transaction ID: 0x59591459
Seconds elapsed: 0
Bootp flags: 0x0000 (Unicast)
  0... .... = Broadcast flag: Unicast
  .000 0000 0000 0000 = Reserved flags: 0x0000
Client IP address: 0.0.0.0 (0.0.0.0)
Your (client) IP address: 0.0.0.0 (0.0.0.0)
```

```

Next server IP address: 0.0.0.0 (0.0.0.0)
Relay agent IP address: 10.10.20.2 (10.10.20.2)
Client MAC address: b8:6a:97:35:d7:9d (b8:6a:97:35:d7:9d)
Client hardware address padding: 00000000000000000000
Server host name not given
Boot file name not given
Magic cookie: DHCP
Option: (53) DHCP Message Type (Discover)
  Length: 1
  DHCP: Discover (1)
Option: (55) Parameter Request List
  Length: 3
  Parameter Request List Item: (1) Subnet Mask
  Parameter Request List Item: (28) Broadcast Address
  Parameter Request List Item: (3) Router
Option: (60) Vendor class identifier
  Length: 39
  Vendor class identifier: onie_vendor:x86_64-accton_as7326_56x-r0
Option: (82) Agent Information Option
  Length: 17
  Option 82 Suboption: (1) Agent Circuit ID
    Length: 8
    Agent Circuit ID: 766c616e312e3230
  Option 82 Suboption: (2) Agent Remote ID
    Length: 5
    Agent Remote ID: 4f634e4f53

Option: (255) End
Option End: 255

```

---

## DHCP-Relay with different VRFs

This chapter explains about DHCP Relay package to make Relay talk to different VRFs when Client and Server are running in different VRFs.

---

## DHCP Relay for IPv4 with different VRFs

Before configuring DHCP Relay, make sure DHCP server and client configurations are done.

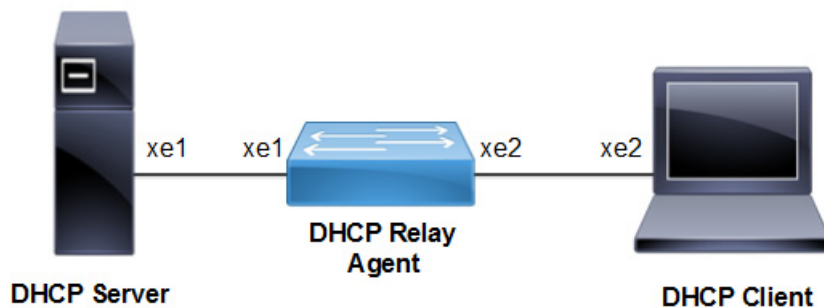

Figure 6-12: DHCP Relay Configuration

### DHCP Agent

#configure terminal	Enter configure mode.
(config)#feature dhcp	Enable the feature dhcp. This is enabled in default.
(config)#ipv4 dhcp relay	By default this will be enabled. It starts the ipv4 dhcp relay service.
(config)# ip vrf vrf1	Configure IP VRF
(config)# ip dhcp relay address 10.10.10.2 global	Configure DHCP relay address
(config)#interface xe1	Enter interface mode.
(config-if)#ip address 10.10.10.1/24	Configure ipv4 address on the interface xe1.
(config-if)#ip dhcp relay uplink	Configure relay uplink on the device connecting the server.
(config-if)#exit	Exit interface mode.
(config)#commit	Commit the candidate configuration to the running
(config)#interface xe2	Enter interface mode.
(config)#ip vrf forwarding vrf1	Configure IP VRF forwarding
(config-if)#ip address 20.20.20.1/24	Configure ipv4 address on the interface xe2.
(config-if)#ip dhcp relay	Relay should be configured on the interface connecting to the
(config-if)#exit	Exit interface mode.
(config)#commit	Commit the candidate configuration to the running

### Validation Commands

```
#show running-config dhcp
    interface eth0
    ip address dhcp
!
ip vrf vrf1
ip dhcp relay address 10.10.10.2 global
!
interface xe2
ip dhcp relay
!
interface xe1
ip dhcp relay uplink
!
```

```
#show ip dhcp relay
DHCP relay service is Enabled. VRF Name: vrf1
Option 82: Disabled
DHCP Servers configured:
10.10.10.2 default
InterfaceUplink/Downlink

xe2 Downlink
VRF Name: default
InterfaceUplink/Downlink
```

```
xe1 Uplink
```

Incoming DHCPv4 packets which already contain relay agent option are FORWARDED unchanged.

```
#show ip dhcp relay address
```

```
VRF Name: vrf1
```

```
DHCP Servers configured:
```

```
10.10.10.2      default
```

Incoming DHCPv4 packets which already contain relay agent option are FORWARDED unchanged.

## DHCP Relay for IPv6 Configuration with different VRFs

### DHCP Agent

#configure terminal	Enter configure mode.
(config)#feature dhcp	Enable the feature dhcp. This is enabled in default.
(config)#ipv6 dhcp relay	By default, this will be enabled. It starts the ipv6 dhcp relay service.
(config)#ip vrf vrf1	Configure vrf1
(config)#ipv6 dhcp relay address 2001::2 global	The relay address configured should be server interface address which is in default vrf , connected to DUT machine.
(config)#interface xe1	Enter interface mode.
(config-if)#ipv6 address 2001::1/64	Configure ipv6 address on the interface xe1.
(config-if)#ipv6 dhcp relay uplink	Configure relay uplink on the device connecting the server.
(config-if)#exit	Exit interface mode.
(config)#commit	Commit the candidate configuration to the running configuration
(config)#interface xe2	Enter interface mode.
(config-if)# ip vrf forwarding vrf1	Attach vrf1 under downlink interface
(config-if)#ipv6 address 2002::1/64	Configure ipv6 address on the interface xe2.
(config-if)#ipv6 dhcp relay	Relay should be configured on the interface connecting client.
(config-if)#exit	Exit interface mode.
(config)#commit	Commit the candidate configuration to the running configuration

### Validation Commands

```
#show ipv6 dhcp relay address
```

```
VRF Name: vrf1
```

```
DHCPv6 Servers configured:
```

```
2001::2      default
```

```
#show running-config dhcp
```

```
interface eth0
```

```
 ip address dhcp
```

```
!
```

```
ip vrf vrf1
```

```
ipv6 dhcp relay address 2001::1 global
```

## DHCP Relay Agent Configuration

---

```
interface xe2
ipv6 dhcp relay
!
interface xe1
ipv6 dhcp relay uplink
!
```

```
#show ipv6 dhcp relay
IPv6 DHCP relay service is Enabled.
VRF Name: vrf1
  DHCPv6 Servers configured:
  2001::2    default
  DHCPv6 IA_PD Route injection: Disabled
  Interface          Uplink/Downlink
  -----          -
  Xe2                Downlink
  DHCPv6 IA_PD Route injection: Disabled
  Interface          Uplink/Downlink
  -----          -
  Xe1                Uplink
```

## CHAPTER 7 DHCP Relay Agent Over L3VPN Configuration

The DHCP Relay feature was designed to forward DHCP broadcast requests as unicast packets to a configured DHCP server or servers for redundancy. In the L3VPN case, there is a special tunnel which gets created through which all the communication happens. In OcNOS, the interface created is named as tunmpls. This tunnel name is not exposed to the OcNOS control plane. This interface is directly created in the kernel.

### DHCP Relay Over L3 VPN for IPv4

Before configuring DHCP Relay, make sure DHCP server and client configurations are done.

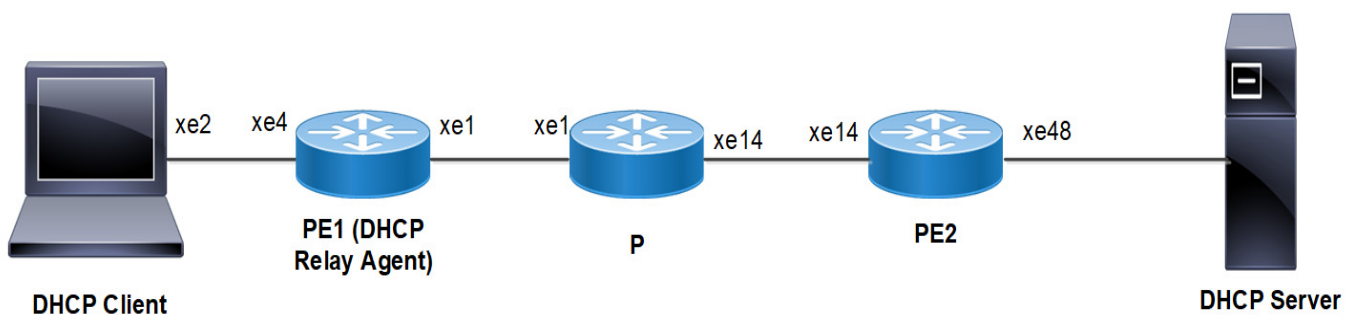

Figure 7-13: DHCP Relay Over L3 VPN Configuration

#### DHCP Client

#configure terminal	Enter configure mode.
(config)#interface xe2	Enter interface mode.
(config-if)#ip address dhcp	Enable DHCP on interface
(config-if)#commit	Commit the candidate configuration to the running configuration

**PE1(DHCP Relay Agent)**

#configure terminal	Enter configure mode.
(config)#ip dhcp relay	By default this will be enabled. It starts the ip dhcp relay service.
(config)#ip vrf vrf1	Configuring non default vrf vrf1
(config-vrf)#rd 10:10	Assign a route distinguisher to VRF
(config-vrf)#route-target both 10:10	Configure a route target for vrf1.
(config-vrf)#ip dhcp relay address 11.11.0.1	Configure DHCP server address.
(config-vrf)#ip dhcp relay uplink l3vpn	configure IPv4 DHCP Relay over L3VPN.
(config)#interface xe4	Enter interface mode.
(config-if)#ip vrf forwarding vrf1	Configure vrf forwarding for vrf1
(config-if)#ip address 50.50.50.1/24	Add IP address.
(config-if)#ip dhcp relay	Configure DHCP relay for the interface connecting to client.
(config-if)#commit	Commit the candidate configuration to the running configuration
(config-if)#exit	Exit from interface mode
(config)#interface lo	Enter interface mode
(config-if)#ip address 1.1.1.1/32 secondary	Set an IP address on the interface
(config-if)#commit	Commit the candidate configuration to the running configuration
(config-if)#exit	Exit from interface mode
(config)#router ldp	Enter the Router LDP mode.
(config-router)#router-id 1.1.1.1	Configure an LDP router ID.
(config-router)#exit	Exit from Router LDP mode
(config)#interface xe1	Enter interface mode
(config-if)#ip address 10.1.1.1/24	Add IP address.
(config-if)#label-switching	Enable label switching on the interface
(config-if)#enable-ldp ipv4	Enable IPv4 LDP configuration on the interface.
(config-if)#commit	Commit the candidate configuration to the running configuration
(config-if)#exit	Exit from interface mode
(config)#router ospf 100	Enter the Router OSPF mode.
(config-router)#network 1.1.1.1/32 area 0.0.0.0	Advertise loopback address in OSPF.
(config-router)#network 10.1.1.0/24 area 0.0.0.0	Advertise network address in OSPF.
(config-router)#exit	Exit Router OSPF mode and return to Configure mode.
(config)# router bgp 100	Enter the Router BGP mode, ASN: 100
(config-router)# bgp router-id 1.1.1.1	Configure a fixed Router ID (1.1.1.1)
(config-router)# neighbor 3.3.3.3 remote-as 100	Configuring PE2 as iBGP neighbor using it's loopback IP
(config-router)# neighbor 3.3.3.3 update-source lo	Source of routing updates as loopback
(config-router)# address-family ipv4 unicast	Entering into IPV4 unicast address family



---

(config-router-af)# neighbor 3.3.3.3 activate	Activate the neighbor in the IPV4 address family
(config-router-af)#exit	Exiting of Address family mode
(config-router)# address-family vpvv4 unicast	Entering into address family mode as vpvv4
(config-router-af)# neighbor 3.3.3.3 activate	Activate the neighbor in the vpvv4 address family
(config-router-af)#exit	Exiting of Address family mode
(config-router)# address-family ipv4 vrf vrf1	Entering into address family mode as ipv4 vrf vrf1
(config-router-af)# redistribute connected	Redistribute connected routes.
(config-router-af)#exit	Exiting of Address family mode
(config-router)# commit	Commit the candidate configuration to the running configuration

---

**P**

#configure terminal	Enter configure mode.
(config)#interface lo	Enter interface mode
(config-if)#ip address 2.2.2.2/32 secondary	Set an IP address on the interface
(config-if)#exit	Exit from interface mode
(config)#router ldp	Enter the Router LDP mode.
(config-router)#router-id 2.2.2.2	Configure an LDP router ID.
(config-router)#exit	Exit from Router LDP mode
(config)#interface xe14	Enter interface mode
(config-if)# ip address 20.1.1.1/24	Add IP address.
(config-if)# label-switching	Enable label switching on the interface
(config-if)# enable-ldp ipv4	Enable IPv4 LDP configuration on the interface.
(config-if)#exit	Exit from interface mode
(config)#interface xe1	Enter interface mode
(config-if)# ip address 10.1.1.2/24	Add IP address.
(config-if)# label-switching	Enable label switching on the interface
(config-if)# enable-ldp ipv4	Enable IPv4 LDP configuration on the interface.
(config-if)#exit	Exit from interface mode
(config)#router ospf 100	Enter the Router OSPF mode.
(config-router)#network 3.3.3.3/32 area 0.0.0.0	Advertise loopback address in OSPF.
(config-router)#network 20.1.1.0/24 area 0.0.0.0	Advertise network address in OSPF.
(config-router)#network 10.1.1.0/24 area 0.0.0.0	Advertise network address in OSPF.
(config-router)#exit	Exit Router OSPF mode and return to Configure mode.
(config)# commit	Commit the candidate configuration to the running configuration

**PE2**

#configure terminal	Enter configure mode.
(config)#ip vrf vrf1	Configuring non default vrf vrf1
(config-vrf)# rd 10:10	Assign a route distinguisher to VRF
(config-vrf)# route-target both 10:10	Configure a route target for vrf1.
(config)#interface xe48	Enter interface mode.
(config-if)#ip vrf forwarding vrf1	Configure vrf forwarding for vrf1
(config-if)# commit	Commit the candidate config
(config-if)#ip address 11.11.0.2/24	Add IP address.
(config-if)#exit	Exit from interface mode
(config)#interface lo	Enter interface mode
(config-if)#ip address 3.3.3.3/32 secondary	Set an IP address on the interface
(config-if)#exit	Exit from interface mode
(config)#router ldp	Enter the Router LDP mode.
(config-router)#router-id 3.3.3.3	Configure an LDP router ID.
(config-router)#exit	Exit from Router LDP mode
(config)#interface xe14	Enter interface mode
(config-if)# ip address 20.1.1.2/24	Add IP address.
(config-if)# label-switching	Enable label switching on the interface
(config-if)# enable-ldp ipv4	Enable IPv4 LDP configuration on the interface.
(config-if)#exit	Exit from interface mode
(config)#router ospf 100	Enter the Router OSPF mode.
(config-router)#network 3.3.3.3/32 area 0.0.0.0	Advertise loopback address in OSPF.
(config-router)#network 20.1.1.0/24 area 0.0.0.0	Advertise network address in OSPF.
(config-router)#exit	Exit Router OSPF mode and return to Configure mode.
(config)# router bgp 100	Enter the Router BGP mode, ASN: 100
(config-router)# bgp router-id 3.3.3.3	Configure a fixed Router ID (3.3.3.3)
(config-router)# neighbor 1.1.1.1 remote-as 100	Configuring PE1 as iBGP neighbor using it's loopback IP
(config-router)# neighbor 1.1.1.1 update-source lo	Source of routing updates as loopback
(config-router)# address-family ipv4 unicast	Entering into IPV4 unicast address family
(config-router-af)# neighbor 1.1.1.1 activate	Activate the neighbor in the IPV4 address family
(config-router-af)#exit	Exiting of Address family mode
(config-router)# address-family vpnv4 unicast	Entering into address family mode as vpnv4
(config-router-af)# neighbor 1.1.1.1 activate	Activate the neighbor in the vpnv4 address family
(config-router-af)#exit	Exiting of Address family mode
(config-router)# address-family ipv4 vrf vrf1	Entering into address family mode as ipv4 vrf vrf1

(config-router-af)# redistribute connected	Redistribute connected routes.
(config-router-af)#exit	Exiting of Address family mode
(config-router)# commit	Commit the candidate configuration to the running configuration

---

## Validation

### PE1 (DHCP Relay Agent)

```
PE1#show running-config dhcp
ip vrf vrf1
 ip dhcp relay address 11.11.0.1
 ip dhcp relay uplink l3vpn
interface xe4
 ip dhcp relay
```

```
PE1#show ip dhcp relay
DHCP relay service is Enabled.
VRF Name: vrf1
 Option 82: Disabled
 DHCP Servers configured: 11.11.0.1
```

Interface	Uplink/Downlink
-----	-----
xe4	Downlink
l3vpn	uplink

Incoming DHCPv4 packets which already contain relay agent option are FORWARDED unchanged.

### PE1#show ip dhcp relay address

```
VRF Name: vrf1
 DHCP Servers configured: 11.11.0.1
```

Incoming DHCPv4 packets which already contain relay agent option are FORWARDED unchanged.

### DHCP Client

```
#show ip interface brief | include xe2
xe5 *50.50.50.2 up up
```

## DHCP Relay Over L3 VPN for IPv6

Before configuring DHCP Relay, make sure DHCP server and client configurations are done.

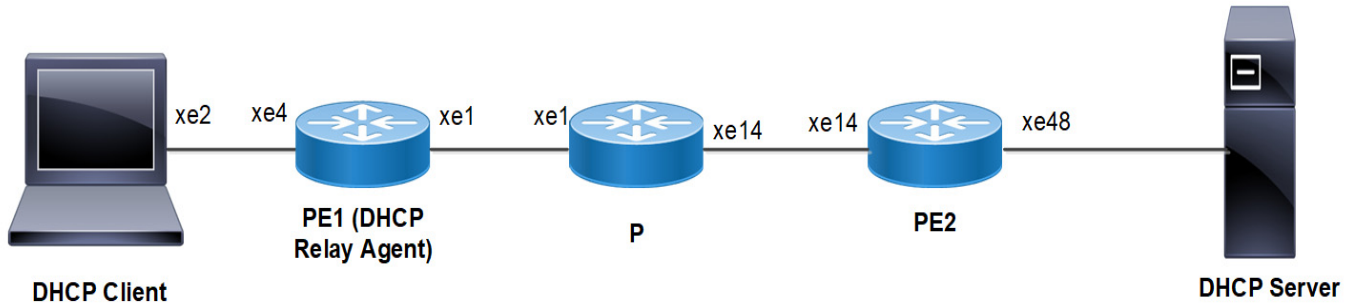

Figure 7-14: DHCP Relay Over L3 VPN Configuration

### DHCP Client

#configure terminal	Enter configure mode.
(config)#interface xe2	Enter interface mode.
(config-if)#ipv6 address dhcp	Enable DHCP on interface
(config-if)#commit	Commit the candidate configuration to the running configuration

**PE1(DHCP Relay Agent)**

#configure terminal	Enter configure mode.
(config)#ipv6 dhcp relay	By default this will be enabled. It starts the ipv6 dhcp relay service.
(config)#ip vrf vrf1	Configuring non default vrf vrf1
(config-vrf)#rd 10:10	Assign a route distinguisher to VRF
(config-vrf)#route-target both 10:10	Configure a route target for vrf1.
(config-vrf)#ipv6 dhcp relay address 2002::1	Configure DHCP server address.
(config-vrf)#ipv6 dhcp relay uplink l3vpn	configure IPv6 DHCP Relay over L3VPN.
(config)#interface xe4	Enter interface mode.
(config-if)#ip vrf forwarding vrf1	Configure vrf forwarding for vrf1
(config-if)# ipv6 address 2001::1/64	Add IPv6 address.
(config-if)#ipv6 dhcp relay	Configure DHCP relay for the interface connecting to client.
(config-if)#exit	Exit from interface mode
(config)#interface lo	Enter interface mode
(config-if)#ip address 1.1.1.1/32 secondary	Set an IP address on the interface
(config-if)#exit	Exit from interface mode
(config)#router ldp	Enter the Router LDP mode.
(config-router)#router-id 1.1.1.1	Configure an LDP router ID.
(config-router)#exit	Exit from Router LDP mode
(config)#interface xe1	Enter interface mode
(config-if)# ip address 10.1.1.1/24	Add IP address.
(config-if)# label-switching	Enable label switching on the interface
(config-if)# enable-ldp ipv4	Enable IPv4 LDP configuration on the interface.
(config-if)#exit	Exit from interface mode
(config)#router ospf 100	Enter the Router OSPF mode.
(config-router)#network 1.1.1.1/32 area 0.0.0.0	Advertise loopback address in OSPF.
(config-router)#network 10.1.1.0/24 area 0.0.0.0	Advertise network address in OSPF.
(config-router)#exit	Exit Router OSPF mode and return to Configure mode.
(config)#router bgp 100	Enter the Router BGP mode, ASN: 100
(config-router)#bgp router-id 1.1.1.1	Configure a fixed Router ID (1.1.1.1)
(config-router)#neighbor 3.3.3.3 remote-as 100	Configuring PE2 as iBGP neighbor using it's loopback IP
(config-router)#neighbor 3.3.3.3 update-source lo	Source of routing updates as loopback
(config-router)#address-family ipv4 unicast	Entering into IPV4 unicast address family
(config-router-af)#neighbor 3.3.3.3 activate	Activate the neighbor in the IPV4 address family
(config-router-af)#exit	Exiting of Address family mode
(config-router)#address-family vpv4 unicast	Entering into address family mode as vpv4
(config-router-af)#neighbor 3.3.3.3 activate	Activate the neighbor in the vpv4 address family
(config-router-af)#exit	Exiting of Address family mode

---

(config-router)#address-family vpnv6 unicast	Entering into address family mode as vpnv6
(config-router-af)#neighbor 3.3.3.3 activate	Activate the neighbor in the vpnv6 address family
(config-router-af)#exit	Exiting of Address family mode
(config-router)# address-family ipv4 vrf vrf1	Entering into address family mode as ipv4 vrf vrf1
(config-router-af)#redistribute connected	Redistribute connected routes.
(config-router-af)#exit	Exiting of Address family mode
(config-router)# address-family ipv6 vrf vrf1	Entering into address family mode as ipv6 vrf vrf1
(config-router-af)#redistribute connected	Redistribute connected routes.
(config-router-af)#exit	Exiting of Address family mode
(config-router)#commit	Commit the candidate configuration to the running configuration

---

**P**

#configure terminal	Enter configure mode.
(config)#interface lo	Enter interface mode
(config-if)#ip address 2.2.2.2/32 secondary	Set an IP address on the interface
(config-if)#exit	Exit from interface mode
(config)#router ldp	Enter the Router LDP mode.
(config-router)#router-id 2.2.2.2	Configure an LDP router ID.
(config-router)#exit	Exit from Router LDP mode
(config)#interface xe14	Enter interface mode
(config-if)#ip address 20.1.1.1/24	Add IP address.
(config-if)#label-switching	Enable label switching on the interface
(config-if)#enable-ldp ipv4	Enable IPv4 LDP configuration on the interface.
(config-if)#exit	Exit from interface mode
(config)#interface xe1	Enter interface mode
(config-if)#ip address 10.1.1.2/24	Add IP address.
(config-if)#label-switching	Enable label switching on the interface
(config-if)#enable-ldp ipv4	Enable IPv4 LDP configuration on the interface.
(config-if)#exit	Exit from interface mode
(config)#router ospf 100	Enter the Router OSPF mode.
(config-router)#network 3.3.3.3/32 area 0.0.0.0	Advertise loopback address in OSPF.
(config-router)#network 20.1.1.0/24 area 0.0.0.0	Advertise network address in OSPF.
(config-router)#network 10.1.1.0/24 area 0.0.0.0	Advertise network address in OSPF.
(config-router)#exit	Exit Router OSPF mode and return to Configure mode.
(config)# commit	Commit the candidate configuration to the running configuration



**PE2**

#configure terminal	Enter configure mode.
(config)#ip vrf vrf1	Configuring non default vrf vrf1
(config-vrf)#rd 10:10	Assign a route distinguisher to VRF
(config-vrf)#route-target both 10:10	Configure a route target for vrf1.
(config)#interface xe48	Enter interface mode.
(config-if)#ip vrf forwarding vrf1	Configure vrf forwarding for vrf1
(config-if)#commit	Commit the candidate config
(config-if)#ipv6 address 2002::2/64	Add IPv6 address.
(config-if)#exit	Exit from interface mode
(config)#interface lo	Enter interface mode
(config-if)#ip address 3.3.3.3/32 secondary	Set an IP address on the interface
(config-if)#exit	Exit from interface mode
(config)#router ldp	Enter the Router LDP mode.
(config-router)#router-id 3.3.3.3	Configure an LDP router ID.
(config-router)#exit	Exit from Router LDP mode
(config)#interface xe14	Enter interface mode
(config-if)#ip address 20.1.1.2/24	Add IP address.
(config-if)#label-switching	Enable label switching on the interface
(config-if)#enable-ldp ipv4	Enable IPv4 LDP configuration on the interface.
(config-if)#exit	Exit from interface mode
(config)#router ospf 100	Enter the Router OSPF mode.
(config-router)#network 3.3.3.3/32 area 0.0.0.0	Advertise loopback address in OSPF.
(config-router)#network 20.1.1.0/24 area 0.0.0.0	Advertise network address in OSPF.
(config-router)#exit	Exit Router OSPF mode and return to Configure mode.
(config)#router bgp 100	Enter the Router BGP mode, ASN: 100
(config-router)#bgp router-id 3.3.3.3	Configure a fixed Router ID (3.3.3.3)
(config-router)#neighbor 1.1.1.1 remote-as 100	Configuring PE1 as iBGP neighbor using it's loopback IP
(config-router)#neighbor 1.1.1.1 update-source lo	Source of routing updates as loopback
(config-router)#address-family ipv4 unicast	Entering into IPV4 unicast address family
(config-router-af)#neighbor 1.1.1.1 activate	Activate the neighbor in the IPV4 address family
(config-router-af)#exit	Exiting of Address family mode
(config-router)#address-family vpv4 unicast	Entering into address family mode as vpv4
(config-router-af)#neighbor 1.1.1.1 activate	Activate the neighbor in the vpv4 address family
(config-router-af)#exit	Exiting of Address family mode
(config-router)#address-family vpv6 unicast	Entering into address family mode as vpv6
(config-router-af)#neighbor 1.1.1.1 activate	Activate the neighbor in the vpv6 address family
(config-router-af)#exit	Exiting of Address family mode

## DHCP Relay Agent Over L3VPN Configuration

---

(config-router)#address-family ipv4 vrf vrf1	Entering into address family mode as ipv4 vrf vrf1
(config-router-af)#redistribute connected	Redistribute connected routes.
(config-router-af)#exit	Exiting of Address family mode
(config-router)#address-family ipv6 vrf vrf1	Entering into address family mode as ipv6 vrf vrf1
(config-router-af)#redistribute connected	Redistribute connected routes.
(config-router-af)#exit	Exiting of Address family mode
(config-router)#commit	Commit the candidate configuration to the running configuration

---

## Validation

### PE1 (DHCP Relay Agent)

```
PE1#show running-config dhcp
ip vrf vrf1
  ipv6 dhcp relay address 2002::1
  ipv6 dhcp relay uplink l3vpn
interface xe4
  ipv6 dhcp relay
```

```
PE1#show ipv6 dhcp relay
IPv6 DHCP relay service is Enabled.
VRF Name: vrf1
  Option 82: Enabled
  DHCPv6 Servers configured: 2002::1
  DHCPv6 IA_PD Route injection: Disabled
Interface                Uplink/Downlink
-----                -
xe4                      Downlink
l3vpn                    uplink
PE1#show ip dhcp relay address
VRF Name: vrf1
  DHCPv6 Servers configured: 2002::1
```

### DHCP Client

```
#show ipv6 interface brief | include xe2
xe5    *2001::200 up    up
```

## CHAPTER 8 DHCPv6 Prefix Delegation Configuration

### Overview

The prefix delegation feature lets a DHCP server assign prefixes chosen from a global pool to DHCP clients, that is how the Customer Premise Equipment (CPE) learns the prefix. The learnt prefix shall be used by the user to configure the IPv6 address on its LAN interface along with the subnet prefix. The LAN hosts are learning the subnetted prefix through router advertisement (NDP protocol) messages, which enables the device to auto-configure its own IPv6 addresses.

This feature would enable service providers to assign IP for the Customer Premise Equipment acting as a router between the service providers core network and subscribers internal network.

### Description

- DHCPv6 IA\_NA is used to assign a global IPv6 address on the WAN link. The address comes from a local pool specified in DHCP Server.
- The Requesting Router(RR) uses the delegated prefix to define the subnet for the LAN based on the prefix received from DHCP Server.
- The Requesting Router uses the delegated prefix to assign addresses to the LAN devices. Here RR can send Router Advertisement, or the devices shall send Router solicitation.

### Acronyms

Field	Description
IA_NA	Identity association for non-temporary addresses
NDRA	Neighbor discovery Router Advertisement
CPE	Customer Premises Equipment
BNG	Border Network Gateway
DR	Delegating Router
RR	Requesting Router
RA	Router Advertisement
RS	Router Solicitation

## Topology

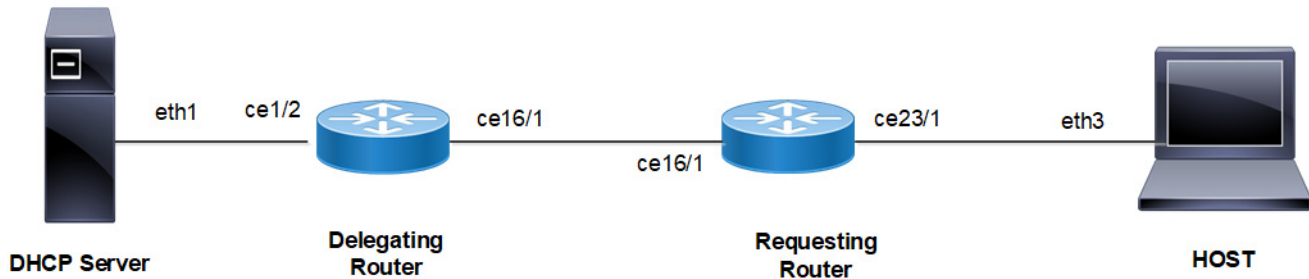

Figure 8-15: DHCPv6 Prefix Delegation Configuration

### DHCP Relay - Delegating Router (DR)

#configure terminal	Enter configure mode.
(config)#feature dhcp	Enable the feature DHCP. This is enabled by default.
(config)#ipv6 dhcp relay	By default, this will be enabled. It starts the IPv6 DHCP relay service.
(config)#ipv6 dhcp relay address 2001:101:0:1::131	The relay address configured should be server interface address connected to Delegating Router.
(config)#interface ce1/2	Enter interface mode.
(config-if)#ipv6 address 2001:101:0:1::130/64	Configure IPv6 address on the interface ce1/2
(config-if)#ipv6 dhcp relay uplink	Configure relay uplink on the device connecting the server.
(config-if)#exit	Exit interface mode.
(config)#commit	Commit the candidate configuration to the running
(config)#interface ce16/1	Enter interface mode.
(config-if)#ipv6 address 3001:101:0:1::135/64	Configure IPv6 address on the interface ce16/1
(config-if)#ipv6 dhcp relay	Relay should be configured on the interface connecting to the client.
(config-if)#exit	Exit interface mode.
(config)#commit	Commit the candidate configuration to the running
(config)#ipv6 route 1212:501:102:1::/64 3001:101:0:1::254	Configure static route towards Host

### Requesting Router (RR)

#configure terminal	Enter configure mode.
(config)#interface ce16/1	Enter interface mode.

(config-if)#ipv6 dhcp address-prefix-len 64	Addition of address prefix length option
(config-if)#ipv6 address dhcp	Configure IPv6 address DHCP.
(config-if)#ipv6 dhcp prefix-delegation PREFIX_FROM_SERVER	Configure IPv6 DHCP prefix-delegation
(config-if)#exit	Exit interface mode.
(config)#commit	Commit the candidate configuration to the running configuration
(config)#interface ce23/1	Enter interface mode.
(config-if)#ipv6 address PREFIX_FROM_SERVER ::1:0:0:0:1/64	Configure IPv6 address from the prefix learnt
(config-if)#exit	Exit interface mode.
(config)#commit	Commit the candidate configuration to the running configuration
(config)#ipv6 route 2001:101:0:1::/64 3001:101:0:1::135	Configure static route towards server

## HOST

#configure terminal	Enter configure mode.
(config)#interface ce23/1	Enter interface mode.
(config-if)#ipv6 address autoconfig	Configure IPv6 autoconfig
(config if)#exit	Exit interface mode.
(config)#commit	Commit the candidate configuration to the running
(config)#ipv6 route 2001:101:0:1::/64 fe80::ce37:abff:fec9:7426 ce23/1	Configure static route towards server

## Linux Host

IPV6_AUTOCONF=yes	IPv6 autoconfig should be set to yes in interface config file.
-------------------	--

## DHCP Server

ifconfig eth1 inet6 add 2001:101:0:1::131/64	Configure IPv6 address on client facing interface
dhcpd -d -6 -cf /etc/dhcp/dhcpd6.conf eth1	Start server
ipv6 route 1212:501:102:1::/64 2001:101:0:1::130	Configure static route towards Requesting Router

## Sample dhcpd6.conf file

Note: Preferred and Max lifetimes must not be configured with same values.

```
#
#DHCPv6 Server Configuration file.
#see /usr/share/doc/dhcp*/dhcpd6.conf.sample
#see dhcpd.conf(5) man page
#
preferred-lifetime 200;
default-lease-time 600;
```

## DHCPv6 Prefix Delegation Configuration

---

```
subnet6 2001:101:0:1::/64 {
range6 2001:101:0:1::129 2001:101:0:1::254;
}
subnet6 3001:101:0:1::/64 {
range6 3001:101:0:1::129 3001:101:0:1::254;
prefix6 1212:501:101:: 1212:501:102:: /48;
option dhcp6.name-servers fec0:0:0:1::1;
option dhcp6.domain-search "domain.example";
}
```

---

## Validation

### Delegation Router (DR)

```
DR#sh ipv6 dhcp relay
IPv6 DHCP relay service is Enabled.
VRF Name: default
  DHCPv6 Servers configured: 2001:101:0:1::131
  DHCPv6 IA_PD Route injection: Enabled
  Interface                    Uplink/Downlink
  -----                    -
  ce1/2                        Uplink
  ce16/1                       Downlink
```

### Requesting Router (RR)

```
RR#show ipv6 dhcp interface

ce16/1 is in client mode
prefix name: PREFIX_FROM_SERVER1
learned prefix: 1212:501:102::/48
preferred lifetime 600, valid lifetime 600
interfaces using the learned prefix
ce23/1    1212:501:102:1::1

RR#show int ce23/1
Interface ce23/1
Scope: both
Flexport: Breakout Control Port (Active): Break Out Enabled
Hardware is ETH Current HW addr: cc37.abc9.7426
Physical:cc37.abc9.743f Logical:(not set)
Port Mode is Router
Interface index: 10025
Metric 1 mtu 1500 duplex-full link-speed 1g
Debounce timer: disable
<UP,BROADCAST,RUNNING,MULTICAST>
VRF Binding: Not bound
DHCP client is disabled.
Last Flapped: 2021 Mar 02 09:44:05 (00:03:55 ago)
Statistics last cleared: 2021 Mar 02 09:44:05 (00:03:55 ago)
inet6 1212:501:102:1::1/64
inet6 fe80::ce37:abff:fec9:7426/64
```

ND router advertisements are sent approximately every 571 seconds  
ND next router advertisement due in 434 seconds.  
ND router advertisements live for 1800 seconds  
Hosts use stateless autoconfig for addresses.  
5 minute input rate 2 bits/sec, 0 packets/sec  
5 minute output rate 23 bits/sec, 0 packets/sec

## HOST

```
[root@localhost ~]#ifconfig -a
eth3      Link encap:Ethernet  HWaddr 00:07:E9:A5:23:4C
inet6 addr: 1212:501:102:1:207:e9ff:fea5:234c/64 Scope:Global
inet6 addr: fe80::207:e9ff:fea5:234c/64 Scope:Link
UP BROADCAST RUNNING MULTICAST  MTU:1500  Metric:1
RX packets:196985 errors:0 dropped:0 overruns:0 frame:0
TX packets:5733 errors:0 dropped:0 overruns:0 carrier:0
collisions:0 txqueuelen:1000
RX bytes:23542362 (22.4 MiB)  TX bytes:710558 (693.9 KiB)
```

## Assumptions/Dependencies/Limitations

- Neighbour discovery(NDD module / NSM) sends Router Advertisements (RA) to LAN devices with the learnt prefix, so they can auto-configure the IPV6 addresses for the interface.
- The route has to configure manually on the DR to forward the Traffic from Server to RR
- With Route injection Feature route will be injected in Delegating router, so that the traffic from the DHCP server-side shall be forwarded towards the Requesting router.
- For the Route-injection Feature refer to the [DHCPv6 Relay Prefix Delegation Route Injection Configuration](#) section





## CHAPTER 9 DHCPv6 Relay Prefix Delegation Route Injection Configuration

### Overview

The prefix delegation feature lets a DHCP server assign prefixes chosen from a global pool to DHCP clients. The DHCP client can then configure an IPv6 address on its LAN interface using the prefix it received. It will then send router advertisements including the prefix, allowing other devices to auto-configure their own IPv6 addresses.

If the network topology where Prefix Delegation is running has a Relay agent, then a route needs to be injected in Delegating Router, so that the traffic from the DHCP server-side shall be forwarded towards the Requesting Router.

### Topology

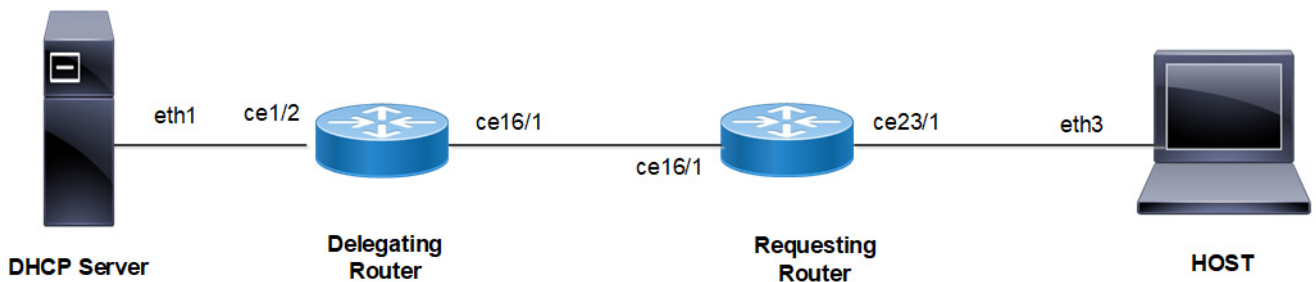

Figure 9-16: DHCPv6 Relay Delegating Configuration

### DHCP Relay - Delegating Router (DR)

#configure terminal	Enter configure mode.
(config)#feature dhcp	Enable the feature DHCP. This is enabled by default.
(config)#ipv6 dhcp relay	By default, this will be enabled. It starts the IPv6 DHCP relay service.
(config)#ipv6 dhcp relay address 2001:101:0:1::131	The relay address configured should be server interface address connected to Delegating Router.
(config)#interface ce1/2	Enter interface mode.
(config-if)#ipv6 address 2001:101:0:1::130/64	Configure IPv6 address on the interface ce1/2
(config-if)#ipv6 dhcp relay uplink	Configure relay uplink on the device connecting the server.
(config-if)#exit	Exit interface mode.
(config)#commit	Commit the candidate configuration to the running
(config)#interface ce16/1	Enter interface mode.
(config-if)#ipv6 address 3001:101:0:1::135/64	Configure IPv6 address on the interface ce16/1

## DHCPv6 Relay Prefix Delegation Route Injection Configuration

(config-if)#ipv6 dhcp relay	Relay should be configured on the interface connecting to the client.
(config-if)#exit	Exit interface mode.
(config)#commit	Commit the candidate configuration to the running
(config)#ipv6 dhcp relay pd-route-injection	Configure to enable auto route injection.

### Requesting Router (RR)

#configure terminal	Enter configure mode.
(config)#interface ce16/1	Enter interface mode.
(config-if)#ipv6 address dhcp	Configure IPv6 address DHCP.
(config-if)#ipv6 dhcp prefix-delegation PREFIX_FROM_SERVER	Configure IPv6 DHCP prefix-delegation
(config-if)#exit	Exit interface mode.
(config)#commit	Commit the candidate configuration to the running configuration
(config)#interface ce23/1	Enter interface mode.
(config-if)#ipv6 address PREFIX_FROM_SERVER ::1:0:0:0:1/64	Configure IPv6 address from the prefix learnt
(config-if)#ipv6 nd ra-interval 4	Configure ra-interval
(config-if)#exit	Exit interface mode.
(config)#ipv6 route 2001:101:0:1::/64 3001:101:0:1::135	Configure static route towards server
(config)#commit	Commit the candidate configuration to the running configuration

### HOST

#configure terminal	Enter configure mode.
(config)#interface ce23/1	Enter interface mode.
(config-if)#ipv6 address autoconfig	Configure IPv6 autoconfig
(config if)#exit	Exit interface mode.
(config)#ipv6 route 2001:101:0:1::/64 fe80::ce37:abff:fec9:7426 ce23/1	Configure static route towards server
(config)#commit	Commit the candidate configuration to the running

### Linux Host

IPV6_AUTOCONF=yes	IPv6 autoconfig should be set to yes in interface config file.
-------------------	--

### DHCP Server

ifconfig eth1 inet6 add 2001:101:0:1::131/64	Configure IPv6 address on client facing interface
dhcpd -d -6 -cf /etc/dhcp/dhcpd6.conf eth1	Start server
ipv6 route 1212:501:102:1::/64 2001:101:0:1::130	Configure static route towards Requesting Router

**Sample dhcpd6.conf file**

```
#
#DHCPv6 Server Configuration file.
#see /usr/share/doc/dhcp*/dhcpd6.conf.sample
#see dhcpd.conf(5) man page
#
preferred-lifetime 400;
default-lease-time 600;

subnet6 2001:101:0:1::/64 {
range6 2001:101:0:1::129 2001:101:0:1::254;
}
subnet6 3001:101:0:1::/64 {
range6 3001:101:0:1::129 3001:101:0:1::254;
prefix6 1212:501:101:: 1212:501:102:: /48;
option dhcp6.name-servers fec0:0:0:1::1;
option dhcp6.domain-search "domain.example";
}
```

**Validation****Delegation Router (DR)**

```
DR#sh ipv6 dhcp relay
IPv6 DHCP relay service is Enabled.
VRF Name: default
  DHCPv6 Servers configured: 2001:101:0:1::131
  DHCPv6 IA_PD Route injection: Enabled
  Interface                Uplink/Downlink
  -----                -
  ce1/2                    Downlink
  ce16/1                   Uplink

DR#sh ipv6 route
IPv6 Routing Table
Codes: K - kernel route, C - connected, S - static, D- DHCP, R - RIP,
       O - OSPF, IA - OSPF inter area, E1 - OSPF external type 1,
       E2 - OSPF external type 2, E - EVPN  N1 - OSPF NSSA external type 1,
       N2 - OSPF NSSA external type 2, i - IS-IS, B - BGP
Timers: Uptime

IP Route Table for VRF "default"
C    ::1/128 via ::, lo, 19:24:04
D    1212:501:102::/48 [80/0] via fe80::eac5:7aff:fe64:4a20, ce16/1, 00:00:01
C    2001:101:0:1::/64 via ::, xe4, 03:42:58
C    3001:101:0:1::/64 via ::, xe2, 02:51:04
C    4001:101:0:1::/64 via ::, xe5, 03:14:41
C    fe80::/64 via ::, xe9, 00:41:39

#sh ipv6 dhcp pd-route
VRF : default
```

## DHCPv6 Relay Prefix Delegation Route Injection Configuration

---

1212:501:102::/48 via fe80::eac5:7aff:fe64:4a20, ce16/1, (2019-05-30 14:02:50 - 2019-05-30 14:04:50)

### Requesting Router (RR)

```
RR#show ipv6 dhcp interface
```

```
ce16/1 is in client mode
prefix name: PREFIX_FROM_SERVER1
learned prefix: 1212:501:102::/48
preferred lifetime 600, valid lifetime 600
interfaces using the learned prefix
ce23/1    1212:501:102:1::1
```

```
RR#sh ipv6 interface ce23/1 brief
```

Interface	IPv6-Address	Admin-Status
Ce23/1	*1212:501:102:1::1	
	fe80::ce37:abff:fec9:7426	[up/up]

```
RR#show int ce23/1
```

```
Interface ce23/1
Scope: both
Flexport: Breakout Control Port (Active): Break Out Enabled
Hardware is ETH Current HW addr: cc37.abc9.7426
Physical:cc37.abc9.743f Logical:(not set)
Port Mode is Router
Interface index: 10025
Metric 1 mtu 1500 duplex-full link-speed 1g
Debounce timer: disable
<UP,BROADCAST,RUNNING,MULTICAST>
VRF Binding: Not bound
DHCP client is disabled.
Last Flapped: 2021 Mar 02 09:44:05 (00:03:55 ago)
Statistics last cleared: 2021 Mar 02 09:44:05 (00:03:55 ago)
inet6 1212:501:102:1::1/64
inet6 fe80::ce37:abff:fec9:7426/64
ND router advertisements are sent approximately every 571 seconds
ND next router advertisement due in 434 seconds.
ND router advertisements live for 1800 seconds
Hosts use stateless autoconfig for addresses.
5 minute input rate 2 bits/sec, 0 packets/sec
5 minute output rate 23 bits/sec, 0 packets/sec
```

### HOST

```
[root@localhost ~]#ifconfig -a
```

```
eth3      Link encap:Ethernet  HWaddr 00:07:E9:A5:23:4C
inet6 addr: 1212:501:102:1:207:e9ff:fea5:234c/64 Scope:Global
inet6 addr: fe80::207:e9ff:fea5:234c/64 Scope:Link
UP BROADCAST RUNNING MULTICAST MTU:1500 Metric:1
RX packets:196985 errors:0 dropped:0 overruns:0 frame:0
```

TX packets:5733 errors:0 dropped:0 overruns:0 carrier:0  
collisions:0 txqueuelen:1000  
RX bytes:23542362 (22.4 MiB) TX bytes:710558 (693.9 KiB)

N4#show ipv6 interface xe7 brief

Interface	IPv6-Address	Admin-Status
ce23/1	*1212:501:102:1:6821:5fff:fe55:4a27	
	fe80::6a21:5fff:fe55:4a27	[up/up]



---

## CHAPTER 10 DHCP Snooping

---

---

### Overview

DHCP snooping is a series of techniques applied to ensure the security of an existing DHCP infrastructure. It is a security feature that acts like a fire wall between untrusted hosts and trusted DHCP servers. It is a layer-2 security technology built into the operating system of a capable network switch that drops DHCP traffic determined to be unacceptable.

The fundamental use case of DHCP snooping is to prevent unauthorized (rogue) DHCP servers offering IP addresses to DHCP clients. Rogue DHCP servers are often used in 'man-in-the middle' or 'Denial of Service' attacks from malicious purpose. Similarly DHCP clients (rogue) can also cause 'Denial of Service' attacks by continuously requesting for IP addresses causing address depletion in the DHCP server.

The DHCP snooping feature performs the following activities:

- Validates DHCP messages received from un-trusted sources and filters out invalid messages.
- Rate-limits DHCP traffic from trusted and un-trusted sources.
- Builds and maintains the DHCP snooping binding database, which contains information about un-trusted hosts with leased IP addresses.
- Utilizes the DHCP snooping binding database to validate subsequent requests from un-trusted hosts.

DHCP snooping is enabled on a per-VLAN basis. By default, the feature is inactive on all VLANs. You can enable the feature on a single VLAN or a range of VLANs.

---

### Topology

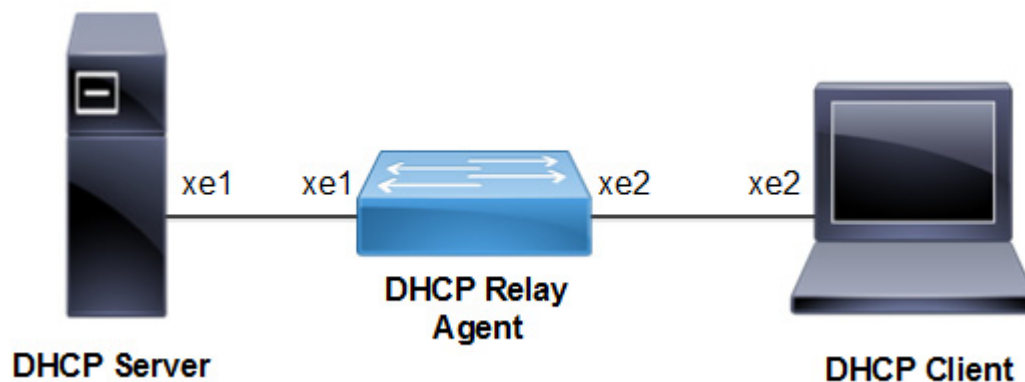

Figure 10-17: DHCP Snooping topology

### Configuration Guidelines

When configuring DHCP snooping, follow these guidelines:

- DHCP snooping is not active until you enable the feature on at least one VLAN, and enable DHCP snooping globally on the switch.
- Before globally enabling DHCP snooping on the switch, make sure that the device acting as the DHCP server is configured and enabled.

- If a Layer 2 LAN port is connected to a DHCP server, configure the port as trusted by entering the `ip dhcp snooping trust interface` configuration command.
- If a Layer 2 LAN port is connected to a DHCP client, configure the port as un-trusted by entering the `no ip dhcp snooping trust interface` configuration command.

### Procedures

The following subsections provide examples of how to enable and configure DHCP Snooping.

#### Enable the Ingress DHCP-snoop TCAM group

<code>#configure terminal</code>	Enter Configure mode.
<code>(config)#hardware-profile filter dhcp-snoop enable</code>	Enable the ingress DHCP-snoop TCAM group
<code>(config)#commit</code>	Commit Candidate config to running-config

#### Disable the Ingress DHCP-snoop TCAM group

<code>#configure terminal</code>	Enter Configure mode.
<code>(config)# hardware-profile filter dhcp-snoop disable</code>	Disable the ingress DHCP-snoop TCAM group
<code>(config)#commit</code>	Commit Candidate config to running-config

#### Enable the Ingress DHCP-snoop-IPv6 TCAM group

<code>#configure terminal</code>	Enter Configure mode.
<code>(config)#hardware-profile filter dhcp-snoop-ipv6 enable</code>	Enable the ingress DHCP-snoop-IPv6 TCAM group
<code>(config)#commit</code>	Commit Candidate config to running-config

#### Disable the Ingress DHCP-snoop-IPv6 TCAM group

<code>#configure terminal</code>	Enter Configure mode.
<code>(config)# hardware-profile filter dhcp-snoop-ipv6 disable</code>	Disable the ingress DHCP-snoop-IPv6 TCAM group
<code>(config)#commit</code>	Commit Candidate config to running-config

#### Enable DHCP Snooping Globally

<code>#configure terminal</code>	Enter Configure mode.
<code>(config)#bridge 1 protocol mstp</code>	Create MSTP or IEEE VLAN-bridge.
<code>(config)#ip dhcp snooping bridge 1</code>	Enable DHCP Snooping on the bridge
<code>(config)#commit</code>	Commit Candidate config to running-config



## Enable DHCP Snooping on a VLAN

#configure terminal	Enter Configure mode.
(config)#vlan 2 bridge 1	Configure a VLAN for the bridge.
(config)#ip dhcp snooping vlan 2 bridge 1	Enable DHCP Snooping on the VLAN 2
(config)#commit	Commit Candidate config to running-config

## Validation

```
OcNOS#show hardware-profile filters
```

Note: Shared count is the calculated number from available resources.  
 Dedicated count provides allocated resource to the group.  
 If group shares the dedicated resource with other groups, then dedicated count of group will reduce with every resource usage by other groups.

Unit - TCAMS	Free Entries	Used %	Used Entries	Total	Dedicated	shared
0 DHCP-SNOOP	9717	0	5	9722	1018	8704
0 DHCP-SNOOP-IPV6	9717	0	6	9723	1019	8704

## Configuring the Ports Connected to DHCP Server and DHCP Client

#configure terminal	Enter Configure mode.
(config)#interface xe1	Specify the interface xe1 to be configured, and Enter interface mode
(config-if)#switchport	Configure the interface as a switch port.
(config-if)#bridge-group 1	Associate the interface xe1 with bridge-group 1.
(config-if)#switchport mode access	Configure the port as an access port
(config-if)#switchport access vlan 2	Bind the interface VLAN 2 to the port
(config-if)#exit	Exit interface mode.
(config)#interface xe2	Specify interface xe2 to be configured connected to server.
(config-if)#switchport	Configure the interface as a switch port
(config-if)#bridge-group 1	Associate interface xe2 with bridge-group 1.
(config-if)#switchport mode access	Configure the port as an access port.
(config-if)#switchport access vlan 2	Bind the interface VLAN 2 to the port
(config-if)#exit	Exit the config mode.
(config)#commit	Commit Candidate config to running-config
(config)#exit	Exit the config mode.

## Configuring Trusted and Un-trusted Ports

Usually the port connected to server is configured as trusted port and the ports connected to client is configured as un-trusted port.

In this example, xe2 is connected to the DHCP client and xe1 is connected to the DHCP server.

- Configure xe2 connected to DHCP client as un-trusted port.
- Configure xe1 connected to the DHCP server as trusted port.

#configure terminal	Enter Configure mode.
(config)#interface xe1	Specify the interface to be configured
(config-if)#ip dhcp snooping trust	Enable the port as trusted.
(config)#commit	Commit Candidate config to running-config
(config)#interface xe2	Specify the interface to be configured
(config-if)#no ip dhcp snooping trust	Disable the port as trusted.
(config-if)#exit	Exit interface mode
(config)#commit	Commit Candidate config to running-config

---

## DHCP Snooping Operation

1. Configure DHCP server that is connected to DHCP Snooper through trusted port.
2. Request an IP address from the DHCP client connected through the un-trusted port.
3. DHCP client broadcast the DHCP DISCOVER message to the switch.
4. DHCP server responds to the DHCP DISCOVER message with DHCP offer message to the client.
5. Once the DHCP OFFER is received by the client, it sends an DHCP REQUEST to the server.
6. DHCP server validates the request from the client and sends DHCP ACK with the offered IP address to the client with the lease time.
7. DHCP Snooper creates an entry for the above operation into the binding table which includes the MAC address of the host, the leased IP address, the lease time, the binding type, and the VLAN number and interface information associated with the host.
8. DHCP Snooper clears the entry in the binding table once the client sends the DHCP RELEASE query.

### Validation

The `show running-config ip dhcp snooping` command displays the DHCP snooping commands configured on the device in question

```
#show running-config ip dhcp snooping
!
!
ip dhcp snooping bridge 1
ip dhcp snooping vlan 2 bridge 1
interface xe1
 ip dhcp snooping trust
!
```

The `show ip dhcp snooping bridge 1` command displays the configured information about DHCP Snooping.

```
#show ip dhcp snooping bridge 1
```

```

Bridge Group : 1
DHCP snooping is : Enabled
DHCP snooping option82 is : Disabled
Verification of hwaddr field is : Disabled
Rate limit(pps) : 100
DHCP snooping is configured on following VLANs : 2
DHCP snooping is operational on following VLANs : 2

```

DHCP snooping IP Source Guard is configured on the following Interface

Interface	Trusted
xe2	Yes

The show ip dhcp snooping binding bridge 1 command displays the binding table entries associated with un-trusted interfaces.

```
#show ip dhcp snooping binding bridge 1
```

```

Bridge Group : 1
DHCP snooping is : Enabled
DHCP snooping option82 is : Disabled
Verification of hwaddr field is : Disabled
Rate limit(pps) : 100
DHCP snooping is configured on following VLANs : 2
DHCP snooping is operational on following VLANs : 2
DHCP snooping trust is configured on the following Interfaces
Interface Trusted
-----
Xe1      Yes

```

DHCP snooping IP Source Guard is configured on the following Interfaces

Interface	Source Guard
-----	-----



## CHAPTER 11 DHCP Snooping IP Source Guard

### Overview

IPSG is a security feature that restricts IP traffic on non-routed, Layer 2 interfaces by filtering traffic based on the DHCP snooping binding database. Use IP source guard to prevent traffic attacks if a host tries to use the IP address of its neighbor. Enable IP source guard when DHCP snooping is enabled on an untrusted interface. After IPSG is enabled on an interface, the switch blocks all IP traffic received on the interface except for DHCP packets allowed by DHCP snooping. A port access control list (ACL) is applied to the interface. The port ACL allows only IP traffic with a source IP address in the IP DHCP snooping binding table and denies all other traffic.

### Topology

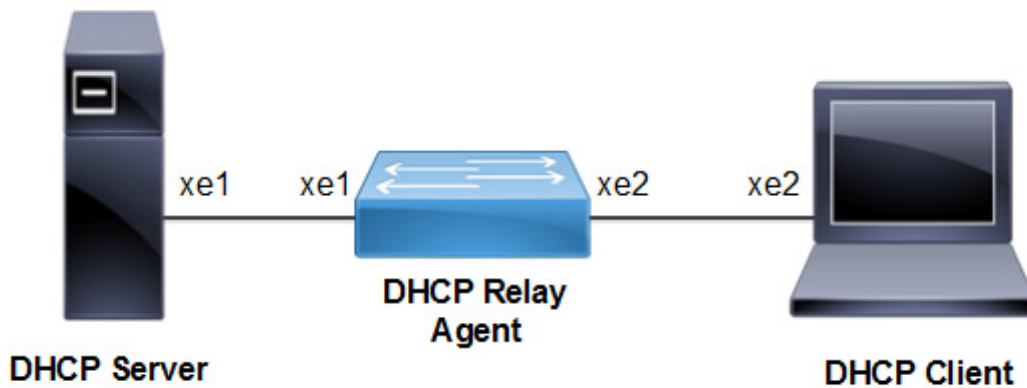

Figure 11-18: IP Source Guard Topology

#### Enable/Disable the Ingress DHCP-snoop TCAM Group

#configure terminal	Enter Configure mode.
(config)#hardware-profile filter dhcp-snoop enable	Enable the ingress DHCP-snoop TCAM group
(config)#commit	Commit Candidate config to running-config
(config)#hardware-profile filter dhcp-snoop disable	Disable the ingress DHCP-snoop TCAM group
(config)#commit	Commit Candidate config to running-config

#### Enable/Disable the Ingress DHCP-snoop-IPv6 TCAM Group

#configure terminal	Enter Configure mode.
(config)#hardware-profile filter dhcp-snoop-ipv6 disable	Disable the ingress DHCP-snoop-IPv6 TCAM group
(config)#commit	Commit Candidate config to running-config

## DHCP Snooping IP Source Guard

(config)#hardware-profile filter dhcp-snoop-ipv6 disable	Disable the ingress DHCP-snoop-IPv6 TCAM group
(config)#commit	Commit Candidate config to running-config

### Enable/Disable the Ingress IPSG TCAM group

#configure terminal	Enter Configure mode.
(config)#hardware-profile filter ipsg enable	Enable the ingress IPSG TCAM group
(config)#commit	Commit Candidate config to running-config
(config)#hardware-profile filter ipsg disable	Disable the ingress IPSG TCAM group
(config)#commit	Commit Candidate config to running-config

### Enable/Disable the Ingress IPSG-IPV6 TCAM group

#configure terminal	Enter Configure mode.
(config)#hardware-profile filter ipsg-ipv6 enable	Enable the ingress IPSG-IPv6 TCAM group
(config)#commit	Commit Candidate config to running-config
(config)#hardware-profile filter ipsg-ipv6 disable	Disable the ingress IPSG-IPv6 TCAM group
(config)#commit	Commit Candidate config to running-config

## Validation

```
OcNOS#show hardware-profile filters
```

Note: Shared count is the calculated number from available resources.  
Dedicated count provides allocated resource to the group.  
If group shares the dedicated resource with other groups, then dedicated count of group will reduce with every resource usage by other groups.

Unit - TCAMS	Free Entries	%	Used Entries	Total	Dedicated	shared
0 DHCP-SNOOP	5620	0	6	5626	1018	4608
0 DHCP-SNOOP-IPV6	5620	0	6	5626	1018	4608
0 IPSG	3327	0	1	3328	1024	2304
0 IPSG-IPV6	3327	0	1	3328	1024	2304

## Configuring the Ports Connected to DHCP Server and DHCP Client

#configure terminal	Enter Configure mode.
(config)#bridge 1 protocol ieee vlan-bridge	Create IEEE VLAN bridge 1.
(config)#vlan 2 bridge 1 state enable	Create VLAN 2

(config)#ip dhcp snooping bridge 1	Configure DHCP snooping for bridge 1
(config)#ip dhcp snooping information option bridge 1	Configure DHCP snooping information option 82
(config)#ip dhcp snooping vlan 2 bridge 1	Configure DHCP snooping for VLAN 2 for bridge 1
(config)#ip dhcp snooping verify mac-address bridge 1	Configure DHCP snooping verify MAC-address
(config)#interface xe1	Enter Interface Mode
(config-if)#switchport	Configure the interface as Layer 2
(config-if)#bridge-group 1	Associate the interface with bridge group 1.
(config-if)#switchport mode access	Set the Layer2 interface as Access. (It can be Trunk mode also)
(config-if)#switchport access vlan 2	Set the default VLAN for the interface
(config-if)#ip dhcp snooping trust	Configuring the interface as Trust. Basically this is configured on the interface which is connected to Server Side.
(config-if)#exit	Exit interface mode.
(config)#interface xe2	Enter Interface Mode
(config-if)#switchport	Configure the interface as Layer 2
(config-if)#bridge-group 1	Associate the interface with bridge group 1.
(config-if)#switchport mode access	Set the Layer2 interface as Access. (It can be Trunk mode also)
(config-if)#switchport access vlan 2	Set the default VLAN for the interface
(config-if)#ip verify source dhcp-snooping-vlan	Configuring IP source guard at Interface level and configured on the interface which is connected to client side
(config-if)#ip verify source access-group mode merge	Merge IPSG policy with other ACL
(config-if)#exit	Exit interface mode
(config)#ip dhcp snooping binding bridge 1 0011.1111.2222 2 ipv4 1.1.1.1 xe2	Configure IPv4 Static Entry For DHCP snooping with MAC address and Source Address for an interface and VLAN configured
(config)#ip dhcp snooping binding bridge 1 0022.2222.3333 2 ipv6 3ffe::1 xe2	Configure IPv6 Static Entry For DHCP snooping with MAC address and Source Address for an interface and VLAN configured
(config)#commit	Commit Candidate config to running-config
(config)#exit	Exit config mode
#clear ip dhcp snooping binding bridge 1	Clear DHCP binding tables which are learned dynamically

## Validation

Verify that DHCP snooping is enabled on the bridge:

```
#sh ip dhcp snooping bridge 1
Bridge Group : 1
DHCP snooping is : Enabled
DHCP snooping option82 is : Enabled
Verification of hwaddr field is : Enabled
DHCP snooping is configured on following VLANs : 2
DHCP snooping is operational on following VLANs : 2
DHCP snooping trust is configured on the following Interfaces
Interface      Trusted
-----
xe1            Yes
```

```
DHCP snooping IP Source Guard is configured on the following Interfaces
Interface          Source Guard
-----
xe2                 Yes
```

## Configuring Trusted and Un-trusted Ports

Usually the port connected to server is configured as trusted port and the ports connected to client is configured as un-trusted port.

In this example, xe2 is connected to the DHCP client and xe1 is connected to the DHCP server.

- Configure xe2 connected to DHCP client as un-trusted port.
- Configure xe1 connected to the DHCP server as trusted port.

#configure terminal	Enter Configure mode.
(config)#interface xe1	Specify the interface to be configured
(config-if)#ip dhcp snooping trust	Enable the port as trusted.
(config)#commit	Commit Candidate config to running-config
(config)#interface xe2	Specify the interface to be configured
(config-if)#no ip dhcp snooping trust	Disable the port as trusted.
(config-if)#exit	Exit interface mode
(config)#commit	Commit Candidate config to running-config

## Validation

Verify that static DHCP snooping entries are configured for the bridge:

```
#sh ip dhcp snooping binding bridge 1
Total number of static IPV4 entries : 1
Total number of dynamic IPV4 entries : 0
Total number of static IPV6 entries : 1
Total number of dynamic IPV6 entries : 0
```

MacAddress	IpAddress	Lease(sec)	Type	VLAN	Interface
0011.1111.2222	1.1.1.1	0	static	2	xe2
0022.2222.3333	3ffe::1	0	static	2	xe2

## Configuring IP Source Guard on LAG Port

In this example, the LAG port (sa2) is created, then physical interfaces are added.

#configure terminal	Enter Configure mode.
(config)#bridge 1 protocol ieee vlan-bridge	Create IEEE VLAN bridge 1.
(config)#vlan 2 bridge 1 state enable	Create VLAN 2
(config)#ip dhcp snooping bridge 1	Configure DHCP snooping for bridge 1
(config)#ip dhcp snooping information option bridge 1	Configure DHCP snooping information option 82
(config)#ip dhcp snooping vlan 2 bridge 1	Configure DHCP snooping for VLAN 2 for bridge 1
(config)#ip dhcp snooping verify mac-address bridge 1	Configure DHCP snooping verify MAC-address



(config)#interface sa2	Enter Interface Mode
(config-if)#switchport	Configure the interface as Layer 2
(config-if)#bridge-group 1	Associate the interface with bridge group 1.
(config-if)#ip verify source dhcp-snooping-vlan	Configuring IP source guard at Interface level and configured on the interface which is connected to client side
(config-if)#ip verify source access-group mode merge	Merge IPSG policy with other ACL
(config-if)#exit	Exit interface mode
(config)#interface xe1	Enter Interface Mode
(config-if)#switchport	Configure the interface as Layer 2
(config-if)#bridge-group 1	Associate the interface with bridge group 1.
(config-if)#switchport mode access	Set the Layer2 interface as Access. (It can be Trunk mode also)
(config-if)#switchport access vlan 2	Set the default VLAN for the interface
(config-if)#ip dhcp snooping trust	Configuring the interface as Trust. Basically this is configured on the interface which is connected to Server Side.
(config-if)#exit	Exit interface mode.
(config)#interface xe2	Enter Interface Mode
(config-if)#switchport	Configure the interface as Layer 2
(config-if)#bridge-group 1	Associate the interface with bridge group 1.
(config-if)#switchport mode access	Set the Layer2 interface as Access. (It can be Trunk mode also)
(config-if)#switchport access vlan 2	Set the default VLAN for the interface
(config-if)#static-channel-group 2	Configure Static Channel LAG on the interface
(config-if)#exit	Exit interface mode
(config)#ip dhcp snooping binding bridge 1 0011.1111.2222 2 ipv4 1.1.1.1 xe1	Configure IPv4 Static Entry For DHCP snooping with MAC address and Source Address for an interface and VLAN configured
(config)#ip dhcp snooping binding bridge 1 0022.2222.3333 2 ipv6 3ffe::1 xe2	Configure IPv6 Static Entry For DHCP snooping with MAC address and Source Address for an interface and VLAN configured
(config)#commit	Commit Candidate config to running-config
(config)#exit	Exit config mode
#clear ip dhcp snooping binding bridge 1	Clear DHCP binding tables which are learned dynamically

## Validation

Verify that DHCP snooping is enabled on the bridge with the static LAG interface:

```
#sh ip dhcp snooping bridge 1
Bridge Group : 1
DHCP snooping is : Enabled
DHCP snooping option82 is : Enabled
Verification of hwaddr field is : Enabled
DHCP snooping is configured on following VLANs : 2
DHCP snooping is operational on following VLANs : 2
DHCP snooping trust is configured on the following Interfaces
Interface      Trusted
-----
Xe1            Yes
```

## DHCP Snooping IP Source Guard

---

DHCP snooping IP Source Guard is configured on the following Interfaces

Interface	Source Guard
sa2	Yes

Verify that static DHCP snooping or source guard entries are configured for the bridge with the LAG interface:

```
#sh ip dhcp snooping binding bridge 1
```

```
Total number of static IPV4 entries : 1
```

```
Total number of dynamic IPV4 entries : 0
```

```
Total number of static IPV6 entries : 1
```

```
Total number of dynamic IPV6 entries : 0
```

MacAddress	IpAddress	Lease(sec)	Type	VLAN	Interface
------------	-----------	------------	------	------	-----------

0011.1111.2222	1.1.1.1	0	static	2	sa2
0022.2222.3333	3ffe::1	0	static	2	sa2

## CHAPTER 12 DHCP Server Configuration

### Overview

A DHCP Server is a network server that automatically provides and assigns IP addresses, default gateways and other network parameters to client devices. It relies on the standard protocol known as Dynamic Host Configuration Protocol or DHCP to respond to broadcast queries by clients.

### DHCP Server Configuration for IPv4

Before configuring make sure that DHCP server is ready.

### Topology

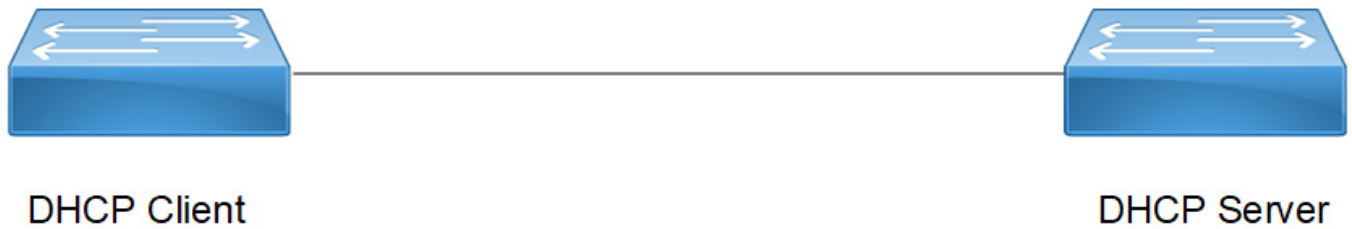

Figure 12-19: DHCP IPv4 topology

### Configuration

#### DHCP IPv4 Client Interface

#configure terminal	Enter Configure mode.
(config)#interface xe1	Specify the interface (xe1) to be configured and enter the interface mode.
(config-if)#ip address dhcp	The client requests for the IP address to the server, once it receives the acknowledgment from the server, it assigns the IP address to the interface in which this command is enabled.
(config-if)#ip dhcp client request dns-nameserver	The client requests for the DNS name server.
(config-if)#ip dhcp client request ntp-server	The client requests for the NTP server .
(config-if)#ip dhcp client request host-name	The client requests for the Name of the client.
(config-if)#ip dhcp client request log-server	The client requests for the log server.
(config if)#exit	Exit interface mode.

## DHCP IPv4 Server Interface

#configure terminal	Enter Configure mode.
(config)#interface xe2	Specify the interface (xe2) to be configured and enter the interface mode.
(config-if)#ip address 10.10.10.1/24	Configure the IP address to the server interface.
(config-if)#ip address dhcp	The client requests for the IP address to the server, once it receives the acknowledgment from the server, it assigns the IP address to the interface in which this command is enabled.
(config if)#exit	Exit interface mode.
(config)#commit	Commit the candidate configuration to the running configuration.

## DHCP IPv4 Server Feature

#configure terminal	Enter Configure mode.
(config)#ip vrf vrf1	Configure IP VRF name.
(config-vrf)#ip dhcp server max-lease-time 100	Configure max lease time.
(config-vrf)#ip dhcp server default-lease-time 100	Configure default lease time.
(config-vrf)#ip dhcp server pool test	Configure DHCP server pool name.
(dhcp-config)#network 3.3.3.0 netmask 255.255.255.0	Configure network and netmask.
(dhcp-config)#address range low-address 3.3.3.1 high-address 3.3.3.4	Configure address IPv4 range.
(dhcp-config)#boot-file test	Configure boot-file name.
(dhcp-config)#host-name dhcp-server	Configure host name.
(dhcp-config)#ntp-server 4.4.4.5	Configure NTP server.
(dhcp-config)#log-server 5.5.5.6	Configure log server.
(dhcp-config)#dns-server 5.5.5.5	Configure DNS server.
(dhcp-config)#tftp-server 5.5.5.6	Configure TFTP server.
(dhcp-config)#boot-file test	Configure boot-file name.

## Validation

### Client

```
OcNOS#show running-config dhcp
interface eth0
  ip address dhcp
!
interface xe47
  ip address dhcp
ip dhcp client request dns-nameserver
ip dhcp client request host-name
ip dhcp client request log-server
```

```
ip dhcp client request ntp-server
!  
!
```

```
OcNOS#show ip int br
```

```
'*' - address is assigned by dhcp client
```

Interface	IP-Address	Admin-Status	Link-Status
ce54	unassigned	up	down
eth0	*10.12.122.114	up	up
lo	127.0.0.1	up	up
lo.management	127.0.0.1	up	up
xe47	*10.10.10.2	up	up
xe48	unassigned	up	down

```
OcNOS#conf t
Enter configuration commands, one per line. End with CNTL/Z.
OcNOS(config)#int xe6
OcNOS(config-if)#ip dhcp client request host-name
OcNOS(config-if)#commit
OcNOS(config-if)#
OcNOS(config-if)#
OcNOS(config-if)#end
dhcp-client#
dhcp-client#
dhcp-client#
dhcp-client#sh hostname
*dhcp-client
```

```
* - Hostname learnt by DHCP Client.
dhcp-client#
```

## Server

```
OcNOS#show run dhcp
interface eth0
 ip address dhcp
!  
!  
  
ip dhcp server max-lease-time 100
ip dhcp server default-lease-time 100
ip dhcp server pool test
 network 10.10.10.0 netmask 255.255.255.0
 address range low-address 10.10.10.1 high-address 10.10.10.5
 host-name dhcp-client
 boot-file test
 tftp-server 5.5.5.6
 ntp-server 4.4.4.5
 log-server 5.5.5.6
```

```
dns-server 5.5.5.5
interface ge5
 ip dhcp server
```

## DHCP Server Configuration for IPv6

Before configuring make sure that DHCP server is ready.

### Topology



Figure 12-20: DHCP IPv6 topology

## Configuration

### DHCP IPv6 Client Interface

#configure terminal	Enter Configure mode.
(config)#interface xe47	Specify the interface (xe47) to be configured and enter the interface mode.
(config-if)#ipv6 address dhcp	The client requests for the IPv6 address to the server, once it receives the acknowledgment from the server, it assigns the IP address to the interface in which this command is enabled.
(config-if)#ipv6 dhcp client request dns-nameserver	The client requests for the DNS name server.
(config-if)#ipv6 dhcp client request ntp-server	The client requests for the NTP server.
(config-if)#ipv6 dhcp client request domain-search	The client request for IPv6 domain search.
(config-if)#ipv6 dhcp client request vendor-specific-information	The client request for IPv6 vendor-specific-information.
(config-if)#ipv6 dhcp client request rapid-commit	The client request to enable rapid-commit.
(config if)#exit	Exit interface mode.
(config)#commit	Commit the candidate configuration to the running configuration.

## DHCP IPv6 Server Interface

#configure terminal	Enter Configure mode.
(config)#interface xe2	Specify the interface (xe2) to be configured and enter the interface mode.
(config-if)#ipv6 address dhcp	The client requests for the IPv6 address to the server, once it receives the acknowledgment from the server, it assigns the IP address to the interface in which this command is enabled.
(config-if)#ipv6 address 2001::1/64	Configure the IPv6 address to the server interface.
(config if)#ipv6 dhcp server	Configure an interface as a DHCP server starting interface.
(config if)#exit	Exit interface mode.
(config)#commit	Commit the candidate configuration to the running configuration.

## DHCP IPv6 Server Feature

#configure terminal	Enter Configure mode
(config)#ip vrf vrf1	Configure IP VRF name
(config-vrf)#ipv6 dhcp server preference	Configure IPv6 DHCP server preference
(config-vrf)#ipv6 dhcp server rapid-commit	Configure IPv6 DHCP server rapid-commit
(config-vrf)#ipv6 dhcp server pool test	Configure IPv6 DHCP server pool name
(dhcp6-config)#network 2001:: netmask 64	Configure IPv6 network and netmask
(dhcp6-config)#address range low-address 2001::1 high-address 2001::124	Configure IPv6 address range
(dhcp6-config)#vendor-options 00:00:09:bf:63	Configure IPv6 vendor option
(dhcp6-config)#ntp-server 4001::1	Configure IPv6 NTP server
(dhcp6-config)#dns-server 3001::1	Configure IPv6 DNS server
(dhcp6-config)#log-server 5.5.5.6	Configure log server
(dhcp6-config)#domain-name abcd	Configure domain name
(dhcp6-config)#tftp-server 5.5.5.6	Configure TFTP server
(dhcp6-config)#boot-file test	Configure boot-file name

## Validation

### Client

```
OcNOS#sh running-config dhcp
interface eth0
 ip address dhcp
!
interface xe2
 ipv6 dhcp client request dns-nameserver
 ipv6 dhcp client request domain-search
 ipv6 dhcp client request ntp-server
 ipv6 dhcp client request rapid-commit
```

## DHCP Server Configuration

---

```
ipv6 dhcp client request vendor-specific-information
ipv6 address dhcp
!
```

```
OcNOS#show ipv6 int br
```

Interface	IPv6-Address	Admin-Status
tus		
ce49	unassigned	[up/down]
eth0	fe80::e69d:73ff:fe05:8100	[up/up]
lo	::1	[up/up]
lo.management	::1	[up/up]
xe45	unassigned	[up/down]
xe46	unassigned	[up/down]
xe47	*2001::124 fe80::e69d:73ff:fe84:8137	[up/up]
xe48	unassigned	[up/down]

### Server

```
OcNOS#show running-config dhcp
```

```
interface eth0
 ip address dhcp
!
```

```
ipv6 dhcp server rapid-commit
ipv6 dhcp server preference
ipv6 dhcp server pool test
 network 2001:: netmask 64
 address range low-address 2001::1 high-address 2001::124
 vendor-options 00:00:09:bf:63
 ntp-server 4001::1
 dns-server 3001::1
 domain-name abcd
interface xe2
 ipv6 dhcp server
!
```



## CHAPTER 13 Dynamic ARP Inspection

### Overview

DAI (Dynamic ARP Inspection) is a security features that validates ARP packet in network by intercepting ARP packet and validating IP-to-MAC address binding learnt from DHCP SNOOP.

DAI (Dynamic ARP Inspection) is a security measures which allows user to intercept, log and discard ARP packets with invalid MAC address to IP address binding. Once the DAI feature is enabled on the system, ARP packets are re-directed to software and validated against the MAC to IP binding data base before getting forwarded. ARP coming on untrusted port is inspected, validated and forwarded/dropped appropriately.

### Topology

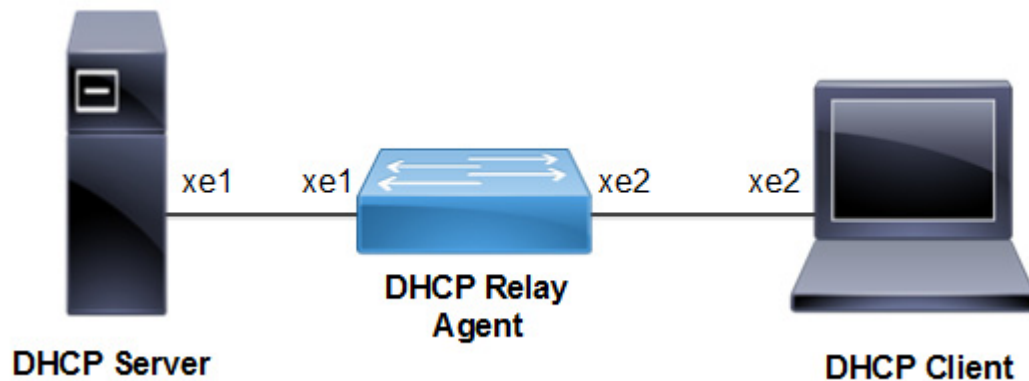

Figure 13-21: DAI Topology

#### Enable/Disable the Ingress DHCP-snoop TCAM group

#configure terminal	Enter Configure mode.
(config)#hardware-profile filter dhcp-snoop enable	Enable the ingress DHCP-snoop TCAM group
(config)#commit	Commit Candidate config to running-config
(config)#hardware-profile filter dhcp-snoop disable	Disable the ingress DHCP-snoop TCAM group
(config)#commit	Commit Candidate config to running-config

#### Enable/Disable the Ingress DHCP-snoop-IPv6 TCAM group

#configure terminal	Enter Configure mode.
(config)#hardware-profile filter dhcp-snoop-ipv6 enable	Enable the ingress DHCP-snoop-IPv6 TCAM group
(config)#commit	Commit Candidate config to running-config

(config)#hardware-profile filter dhcp-snoop-ipv6 disable	Disable the ingress DHCP-snoop-IPv6 TCAM group
(config)#commit	Commit Candidate config to running-config

### Enable DHCP Snooping and DAI Globally

#configure terminal	Enter Configure mode.
(config)#bridge 1 protocol mstp	Create MSTP or IEEE VLAN-bridge.
(config)#ip dhcp snooping bridge 1	Enable DHCP Snooping on the bridge
(config)#ip dhcp snooping arp-inspection bridge 1	Enable DAI on bridge
(config)#commit	Commit Candidate config to running-config

### Enable DHCP Snooping and DAI on a VLAN

#configure terminal	Enter Configure mode.
(config)#vlan 2 bridge 1	Configure a VLAN for the bridge.
(config)#ip dhcp snooping vlan 2 bridge 1	Enable DHCP Snooping on the VLAN 2
(config)#ip dhcp snooping arp-inspection vlan 2 bridge 1	Enable DAI on VLAN
(config)#commit	Commit Candidate config to running-config

### Validation

OcNOS#show hardware-profile filters

Note: Shared count is the calculated number from available resources.  
 Dedicated count provides allocated resource to the group.  
 If group shares the dedicated resource with other groups, then dedicated count of group will reduce with every resource usage by other groups.

Unit - TCAMS	Free Entries	%	Used Entries	Total	Dedicated	shared
0 DHCP-SNOOP	5522	2	104	5626	1018	4608
0 DHCP-SNOOP-IPV6	5522	0	6	5528	920	4608
0 IPSEG	3327	0	1	3328	1024	2304
0 IPSEG-IPV6	3327	0	1	3328	1024	2304

### Enable/Disable IP DHCP Snooping ARP-inspection Validate

Use this command to enable validation of the source-MAC, destination-MAC, or IP address field in the ARP packet payload.

Note: The IP address in a payload is validated for not being a broadcast address, a reserved zero IP address, and multicast address.

#configure terminal	Enter Configure mode.
(config)#ip dhcp snooping arp-inspection validate src-mac bridge 1	Enable SRC-MAC validate
(config)#commit	Commit Candidate config to running-config
(config)#no ip dhcp snooping arp-inspection validate src-mac bridge 1	Disable SRC-MAC validate
(config)#commit	Commit Candidate config to running-config
(config)#ip dhcp snooping arp-inspection validate dst-mac bridge 1	Enable DST-MAC validate
(config)#commit	Commit Candidate config to running-config
(config)#no ip dhcp snooping arp-inspection validate dst-mac bridge 1	Disable DST-MAC validate
(config)#commit	Commit Candidate config to running-config
(config)#ip dhcp snooping arp-inspection validate ip bridge 1	Enable IP validate
(config)#commit	Commit Candidate config to running-config
(config)#no ip dhcp snooping arp-inspection validate ip bridge 1	Disable IP validate
(config)#commit	Commit Candidate config to running-config

## Configuring the Ports Connected to DHCP Server and DHCP Client

#configure terminal	Enter Configure mode.
(config)#interface xe1	Specify the interface xe1 to be configured, and Enter interface mode
(config-if)#switchport	Configure the interface as a switch port.
(config-if)#bridge-group 1	Associate the interface xe1 with bridge-group 1.
(config-if)#switchport mode access	Configure the port as an access port
(config-if)#switchport access vlan 2	Bind the interface VLAN 2 to the port
(config-if)#exit	Exit interface mode.
(config)#interface xe2	Specify interface xe2 to be configured connected to server.
(config-if)#switchport	Configure the interface as a switch port
(config-if)#bridge-group 1	Associate interface xe2 with bridge-group 1.
(config-if)#switchport mode access	Configure the port as an access port.
(config-if)#switchport access vlan 2	Bind the interface VLAN 2 to the port
(config-if)#exit	Exit the config mode.
(config)#commit	Commit Candidate config to running-config
(config)#exit	Exit the config mode.

## Configuring Trusted and Un-trusted Ports

Usually the port connected to server is configured as trusted port and the ports connected to client is configured as un-trusted port.

In this example, xe2 is connected to the DHCP client and xe1 is connected to the DHCP server.

- Configure xe2 connected to DHCP client as un-trusted port.
- Configure xe1 connected to the DHCP server as trusted port.

#configure terminal	Enter Configure mode.
(config)#interface xe1	Specify the interface to be configured
(config-if)#ip dhcp snooping trust	Enable the port as trusted.
(config)#commit	Commit Candidate config to running-config
(config)#interface xe2	Specify the interface to be configured
(config-if)#no ip dhcp snooping trust	Disable the port as trusted.
(config-if)#exit	Exit interface mode
(config)#commit	Commit Candidate config to running-config

### Validation

```
OcNOS#show ip dhcp snooping arp-inspection statistics bridge 1
bridge      forwarded  dai dropped
-----
1           0          10
```

---

## CHAPTER 14 Proxy ARP and Local Proxy ARP

---

---

### Overview

Proxy ARP (RFC 1027) is a technique by which a device on a given network answers the ARP queries for a network address that is not on that network. The Proxy ARP is aware of the location of the traffic's destination, and offers its own MAC address as destination. The captured traffic is then typically routed by the Proxy to the intended destination via another interface. Proxy ARP can help machines on a subnet reach remote subnets without the need to configure routing or a default gateway.

Use `no ip proxy-arp` to disable Proxy ARP, Proxy ARP is disabled by default.

---

### Topology

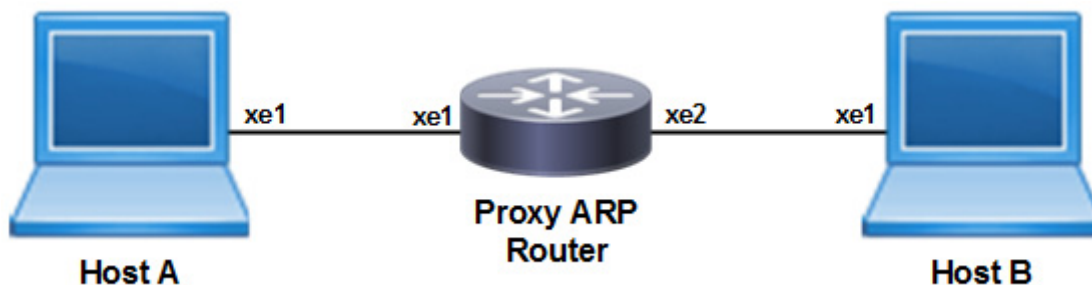

Figure 14-22: Sample topology

### Host A

#configure terminal	Enter Configure mode.
(config)#interface xe1	Specify the interface to be configured on Host A
(config-if)#ip address 20.20.0.3/24	Configure the ip address on the interface
(config)#commit	Commit the candidate configuration to the running
(config)#end	Exit interface and configure mode

### Host B

#configure terminal	Enter Configure mode
(config)#interface xe1	Specify the interface to be configured on Host B
(config-if)#ip address 20.20.1.2/24	Configure the ip address on the interface
(config)#commit	Commit the candidate configuration to the running
(config)#end	Exit interface and configure mode

### Enable Proxy ARP

#configure terminal	Enter Configure mode.
(config)#interface xe1	Specify the interface connected to Host A
(config-if)#ip address 20.20.0.1/24	Configure the ip address on the interface
(config-if)#interface xe2	Specify the interface connected to Host B
(config-if)#ip address 20.20.1.1/24	Configure the ip address on the interface
(config-if)#interface xe1	Specify the interface to configure Proxy ARP
(config-if)#ip proxy-arp	Enable Proxy ARP
(config)#commit	Commit the candidate configuration to the running
(config)#end	Exit interface and configure mode

---

## Validation

```
#show running-config arp
!  
interface xe1  
ip proxy-arp  
!
```

The `show arp` command on the hosts shows the ARP table entries to reach different subnets. Ping Host A from Host B. The ARP table should have the router's xe1 interface MAC address to reach Host A. Execute the below command at Host B:

```
#show arp
```

```
Flags: D - Static Adjacencies attached to down interface
```

```
IP ARP Table for context default
```

```
Total number of entries: 2
```

Address	Age	MAC Address	Interface	State
20.20.0.3	00:02:39	ecf4.bbc0.3d71	xe1	STALE.

---

## Local Proxy ARP Overview

Local Proxy ARP feature is used to enable local proxy support for ARP requests per interface level. Activation will make the router answer all ARP requests on configured subnet, even for clients that should not normally need routing. Local proxy ARP means that the traffic comes in and goes out the same interface.

The local proxy ARP feature allows responding to ARP requests for IP addresses within a subnet where normally no routing is required. With the local proxy ARP feature enabled, ARP responds to all ARP requests for IP addresses within the subnet and forwards all traffic between hosts in the subnet. Use this feature only on subnets where hosts are intentionally prevented from communicating directly.

---

## Topology

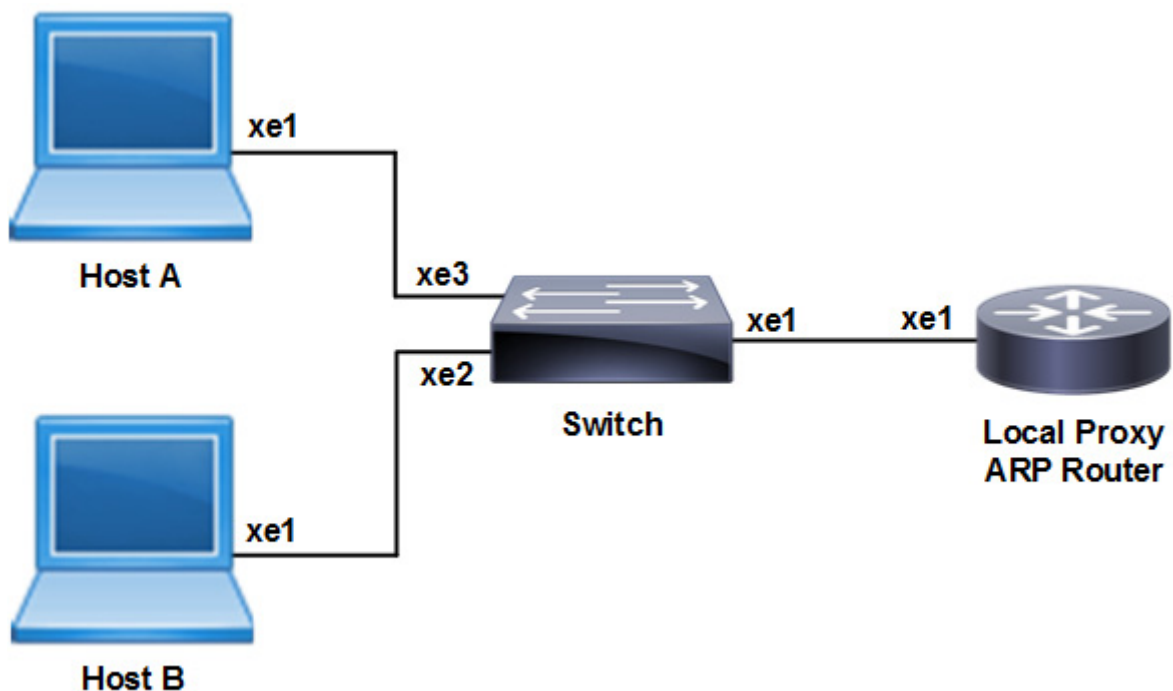

Figure 14-23: Sample topology

**Host A**

#configure terminal	Enter Configure mode.
(config)#interface xe1	Specify the interface to be configured on Host A
(config-if)#ip address 20.20.0.2/24	Configure the ip address on the interface
(config)#commit	Commit the candidate configuration to the running
(config)#end	Exit interface and configure mode

**Host B**

#configure terminal	Enter Configure mode
(config)#interface xe1	Specify the interface to be configured on Host B
(config-if)#ip address 20.20.0.3/24	Configure the ip address on the interface
(config)#commit	Commit the candidate configuration to the running
(config)#end	Exit interface and configure mode

**Private Vlan Configuration on Switch**

#configure terminal	Enter Configure mode.
(config)#bridge 1 protocol ieee vlan-bridge	Create ieee vlan-bridge on switch for pvlan configuration
(config)#vlan database	Enter into the vlan database
(config-vlan)#vlan 100-101 bridge 1 state enable	Create vlans 100 and 101 as part of bridge 1
(config-vlan)#private-vlan 100 primary bridge 1	Configure vlan 100 as a primary vlan
(config-vlan)#private-vlan 101 isolated bridge 1	Configure vlan 101 as a isolated vlan
(config-vlan)#private-vlan 100 association add 101 bridge 1	Associate secondary vlan 101 to primary vlan 100
(config-vlan)#exit	Exit from the vlan database
(config)#commit	Commit the candidate configuration to the running
(config)#interface xe1	Specify the interface to be configured
(config-if)#switchport	Configure xe1 as a layer2 interface.
(config-if)#bridge-group 1	Associate the interface to the bridge
(config-if)#switchport access vlan 100	Associate primary vlan to the interface
(config-if)#switchport mode private-vlan promiscuous	Configure xe1 interface as a promiscuous port
(config-if)#switchport private-vlan mapping 100 add 101	Associate primary vlan 100 and secondary vlan 101 to a promiscuous port
(config-if)#exit	Exit interface mode
(config)#commit	Commit the candidate configuration to the running
(config)#interface xe2	Specify the interface to be configured
(config-if)#switchport	Configure xe2 as a layer2 interface.
(config-if)#bridge-group 1	Associate the interface to the bridge
(config-if)#switchport access vlan 100	Associate primary vlan to the interface
(config-if)#switchport mode private-vlan promiscuous	Configure xe2 interface as a promiscuous port



(config-if)#switchport private-vlan mapping 100 add 101	Associate primary vlan 100 and secondary vlan 101 to a promiscuous port
(config-if)#exit	Exit interface mode
(config)#commit	Commit the candidate configuration to the running
(config)#interface xe3	Specify the interface to be configured
(config-if)#switchport	Configure xe3 as a layer2 interface.
(config-if)#bridge-group 1	Associate the interface to the bridge
(config-if)#switchport access vlan 100	Associate primary VLAN to the interface
(config-if)#switchport mode private-vlan promiscuous	Configure xe2 interface as a promiscuous port
(config-if)#switchport private-vlan mapping 100 add 101	Associate primary vlan 100 and secondary vlan 101 to a promiscuous port
(config-if)#exit	Exit interface mode
(config)#commit	Commit the candidate configuration to the running

### Enable Local Proxy ARP on Router

#configure terminal	Enter Configure mode
(config)#interface xe1	Specify the interface to be configured on Host B
(config-if)#ip address 20.20.0.3/24	Configure the ip address on the interface
(config-if)#ip local-proxy-arp	Enable Local Proxy ARP
(config)#commit	Commit the candidate configuration to the running
(config)#end	Exit interface and configure mode

## Validation

### ARP cache on Host A and Host B

The show arp command on hosts shows the arp table entries to reach different subnets. Ping Host B from Host A. Host A ARP table should have Router's xe1 interface MAC address to reach Host B. Execute the below command at Host A.

```
#show arp
```

```
Flags: D - Static Adjacencies attached to down interface
```

```
IP ARP Table for context default
```

```
Total number of entries: 2
```

```
Address          Age           MAC Address    Interface    State
20.20.0.3       00:02:39     ecf4.bbc0.3d71  xe1         STALE.
```



## CHAPTER 15 DNS Configuration

### Overview

The Domain Name System (DNS) is an Internet service that translates domain names into IP addresses. When a domain name is used, DNS service translates the name into the corresponding IP address. If one DNS server does not know how to translate a particular domain name, it gathers information from other Domain Name Systems to obtain the correct IP address.

### Support for In-band Management over default VRF

OcNOS offers support for DNS over default and management VRFs via in-band management interface & OOB management interface, respectively.

The feature can be enabled to run on default and management VRF simultaneously. By default, it runs on management VRF.

### Topology

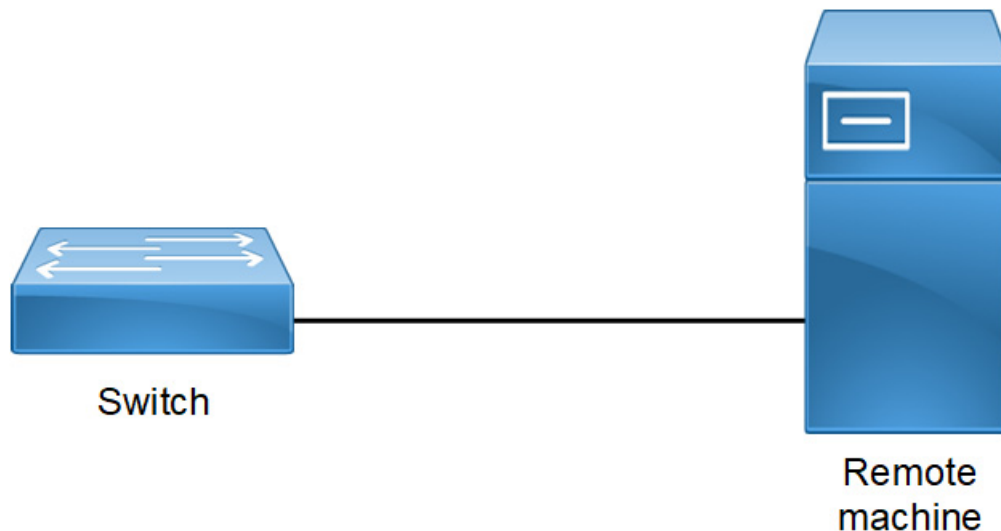

Figure 15-24: DNS sample topology

### Configuration

#configure terminal	Enter Configure mode.
(config)#ip name-server vrf management 10.12.17.11	This add a IPv4 Name Server to the DNS.
(config)#ip name-server vrf management 10.1.1.2	This add a IPv4 Name Server to the DNS.
(config)#ip host vrf management BINGO 10.1.1.1	This will add IPv4 host to the DNS

## DNS Configuration

---

(config)#commit	Commit the candidate configuration to the running configuration
(config)#exit	Exit configure mode.

---

### Validation Commands

```
#show hosts vrf management
    VRF: default
```

```
DNS lookup is disabled
Default domain is empty
DNS domain list is empty
```

```
Name Servers      : 10.12.17.11 10.1.1.2
Host              Address
-----
BINGO             10.1.1.1
```

\* - Values assigned by DHCP Client.

---

### Configuration

#configure terminal	Enter Configure mode.
(config)#ip name-server vrf management 3001::1	This add a IPv6 Name Server to the DNS.
(config)#ip host vrf management bingo 5001::1	This will add IPv6 host to the DNS
(config)#commit	Commit the Candidate configuration to the running configuration
(config)#exit	Exit configure mode.

---

### Validation Commands

```
OcNOS#show hosts vrf management
    VRF: management
```

```
DNS lookup is enabled
Default domain is empty
DNS domain list is empty
```

```
Name Servers      : 3001::1
Host              Address
-----
bingo             5001::1
```

\* - Values assigned by DHCP Client.  
OcNOS#





## CHAPTER 16 DNS Relay Configuration

DNS relay is used to forward DNS request and reply packets between the DNS client and DNS server. In the network where DNS relay is used, the DNS client sends DNS request packets to the DNS relay. The DNS relay forwards request packets to the DNS server and sends reply packets to the DNS client, and domain resolution is realized.

### Topology

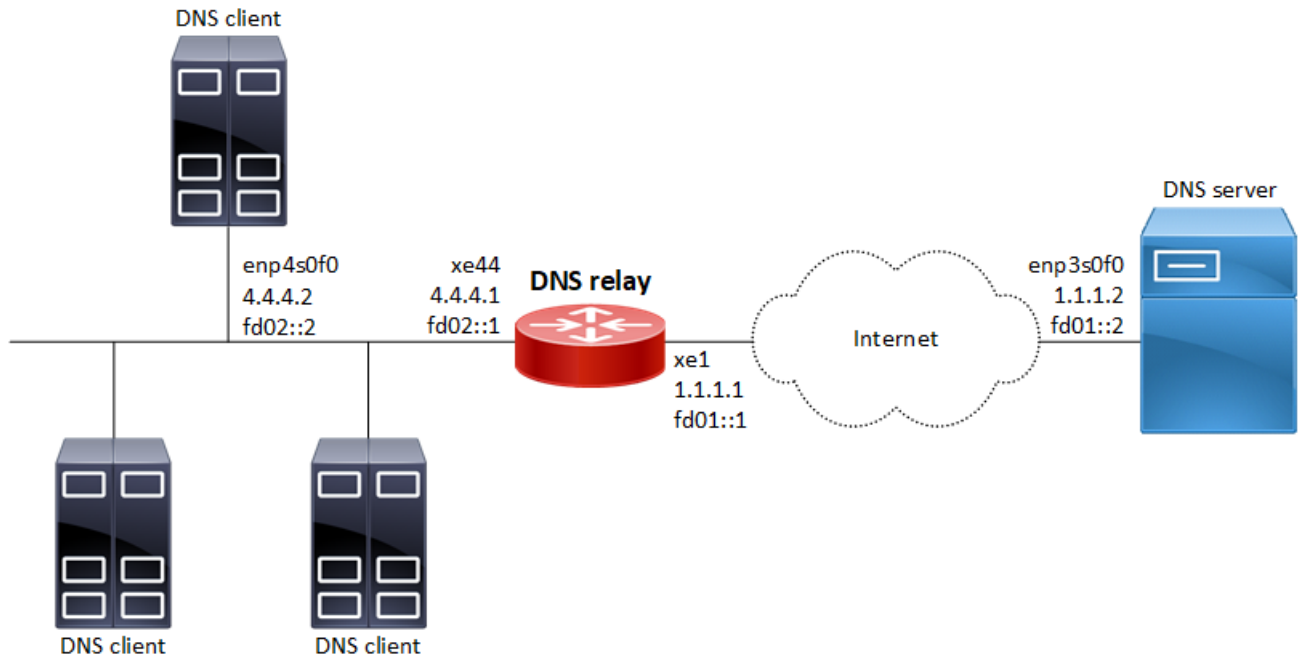

Figure 16-25: DNS relay configuration

### Linux Configuration on the DNS client

1. `sudo ifconfig enp4s0f0 4.4.4.2/24`
2. `sudo ifconfig enp4s0f0 inet6 add fd02::2/16`
3. `echo nameserver fd02::1 >> /etc/resolv.conf`
4. `echo nameserver 4.4.4.1 >> /etc/resolv.conf`

### Linux Configuration on the DNS server

1. `sudo ifconfig enp3s0f0 1.1.1.2/24`
2. `sudo ifconfig enp3s0f0 inet6 add fd01::2/16`
3. Install and configure BIND9:

- a. `apt-get -y update && apt install -y bind9`
- b. Configure 'forwarders' section in the `/etc/bind/named.conf.options` file like this:

```
forwarders { 8.8.8.8; 2001:4860:4860::8888; };
```

---

## OcNOS Configuration

<code>#configure terminal</code>	Enter configure mode
<code>(config)#ip dns relay address 1.1.1.2</code>	Set the IPv4 address of a DNS server
<code>(config)#ipv6 dns relay address fd01::2</code>	Set the IPv6 address of a DNS server
<code>(config)#commit</code>	Commit the configuration
<code>(config)#interface xe44</code>	Enter interface mode (interface connected to client)
<code>(config-if)#ip address 4.4.4.1/24</code>	Assign an IPv4 address to the interface
<code>(config-if)#ip dns relay</code>	Set the interface as a DNS relay client-facing IPv4 port
<code>(config-if)#ipv6 address fd02::1/16</code>	Assign an IPv6 address to the interface
<code>(config-if)#ipv6 dns relay</code>	Set the interface as a DNS relay client-facing IPv6 port
<code>(config-if)#commit</code>	Commit the configuration
<code>(config)#interface xe1</code>	Enter interface mode (interface connected to server)
<code>(config-if)#ip address 1.1.1.1/24</code>	Assign an IPv4 address to the interface
<code>(config-if)#ip dns relay uplink</code>	Set the interface as a DNS relay server-facing IPv4 port
<code>(config-if)#ipv6 address fd01::1/16</code>	Assign an IPv6 address to the interface
<code>(config-if)#ipv6 dns relay uplink</code>	Set the interface as a DNS relay server-facing IPv6 port
<code>(config-if)#commit</code>	Commit the configuration
<code>(config)#exit</code>	Exit configure mode

---

## Validation

```
#sh run dns relay
!
ip dns relay address 1.1.1.2
!
ipv6 dns relay address fd01::2
!
interface xe1
 ip dns relay uplink
 ipv6 dns relay uplink
!
interface xe44
 ip dns relay
 ipv6 dns relay
!
#show running-config interface xe1
!
interface xe1
```



```
ip address 1.1.1.1/24
ipv6 address fd01::1/16
ip dns relay uplink
ipv6 dns relay uplink
!
#show running-config interface xe44
!
interface xe44
 ip address 4.4.4.1/24
 ipv6 address fd02::1/16
 ip dns relay
 ipv6 dns relay
!
```

**Verify DNS Query result on DNS client machine:**

```
[root@localhost ~]# host google.com
google.com has address 172.217.160.238
google.com has IPv6 address 2404:6800:4002:804::200e
google.com mail is handled by 40 alt3.aspmx.l.google.com.
google.com mail is handled by 10 aspmx.l.google.com.
google.com mail is handled by 50 alt4.aspmx.l.google.com.
google.com mail is handled by 30 alt2.aspmx.l.google.com.
google.com mail is handled by 20 alt1.aspmx.l.google.com.
```



---

## CHAPTER 17 NTP Client Configuration

---

---

### Overview

NTP modes differ based on how NTP allows communication between systems. NTP communication consists of time requests and control queries. Time requests provide the standard client/server relationship in which a client requests time synchronization from an NTP server. Control queries provide ways for remote systems to get configuration information and reconfigure NTP servers.

---

### Support for Default VRF via In-band Management

OcNOS now offers support for NTP over default and management VRFs via in-band management interface & OOB management interface, respectively.

The feature can either be running on the default or management VRF. By default, it runs on the management VRF.

---

### NTP Modes

The following describes the various NTP node types.

---

#### Client

An NTP client is configured to let its clock be set and synchronized by an external NTP timeserver. NTP clients can be configured to use multiple servers to set their local time and are able to give preference to the most accurate time sources. They do not, however, provide synchronization services to any other devices.

---

#### Server

An NTP server is configured to synchronize NTP clients. Servers can be configured to synchronize any client or only specific clients. NTP servers, however, will accept no synchronization information from their clients and therefore will not let clients update or affect the server's time settings.

---

#### Peer

With NTP peers, one NTP-enabled device does not have authority over the other. With the peering model, each device shares its time information with the others, and each device can also provide time synchronization to the others.

---

#### Authentication

For additional security, you can configure your NTP servers and clients to use authentication. Routers support MD5 authentication for NTP. To enable a router to do NTP authentication:

1. Enable NTP authentication with the `ntp authenticate` command.
2. Define an NTP authentication key with the `ntp authentication-key vrf management` command. A unique number identifies each NTP key. This number is the first argument to the `ntp authentication-key vrf management` command.

3. Use the `ntp trusted-key vrf management` command to tell the router which keys are valid for authentication. If a key is trusted, the system will be ready to synchronize to a system that uses this key in its NTP packets. The trusted key should already be configured and authenticated.

## NTP Client Configuration with IPv4 Address

NTP client, user can configure an association with a remote server. In this mode the client clock can synchronize to the remote server

After configuring the NTP servers, wait a few minutes before you verify that clock synchronization is successful. When the clock synchronization has actually happened, there will be an "\*" symbol along with the interface while you give the "show ntp peers" command.

### Topology

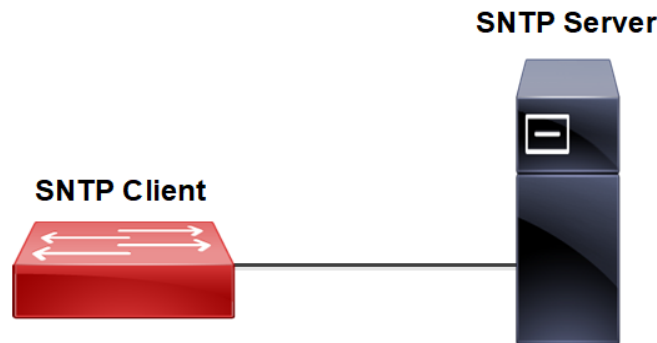

Figure 17-26: SNTP Client and Server

### NTP Client

<code>#configure terminal</code>	Enter Configure mode.
<code>(config)#feature ntp vrf management</code>	Configure feature on default or management VRF. By default this feature runs on management VRF.
<code>(config)#ntp enable vrf management</code>	This feature enables ntp. This will be enabled in default.
<code>(config)#ntp server 10.1.1.1 vrf management</code>	Configure ntp server ip address.
<code>(config)#commit</code>	Commit the configuration
<code>(config)#exit</code>	Exit from the Configure Mode.

### Validation

```
#show ntp peers
-----
Peer IP Address Serv/Peer
-----
10.1.1.1 Server (configured)

#show ntp peer-status
Total peers : 1
* - selected for sync, + - peer mode(active),
```

```

- - peer mode(passive), = - polled in client mode
  remote          refid          st t when poll reach  delay  offset  jitter
=====
*10.1.1.1        LOCAL(0)          7 u   14   32   37   0.194  -4.870  3.314

```

## Maxpoll and Minpoll Configuration

The maximum poll interval are specified in defaults to 6 (64 seconds), but can be increased by the `maxpoll` option to an upper limit of 16 (18.2 hours). The minimum poll interval defaults to 4 (16 seconds), and this is also the minimum value of the `minpoll` option.

The client will retry between `minpoll` and `maxpoll` range configured for synchronization with the server.

### Client

#configure terminal	Enter Configure mode.
(config)#feature ntp vrf management	Configure feature on default or management VRF. By default this feature runs on management VRF.
(config)#ntp server 10.1.1.1 maxpoll 7 minpoll 5 vrf management	Configure minpoll and maxpoll range for ntp server.
(config)#commit	Commit the configuration
(config)#exit	Exit from the Configure Mode.

### Validation

```

#show ntp peers
-----
Peer IP Address Serv/Peer
-----
10.1.1.1 Server (configured)

#show ntp peer-status
Total peers : 1
* - selected for sync, + - peer mode(active),
- - peer mode(passive), = - polled in client mode
  remote          refid          st t when poll reach  delay  offset  jitter
=====
*10.1.1.1        LOCAL(0)          7 u   14   32   37   0.194  -4.870  3.314

```

## NTP Authentication

When you enable NTP authentication, the device synchronizes to a time source only if the source carries the authentication keys specified with the source by key identifier. The device drops any packets that fail the authentication check, and prevents them from updating the local clock.

### Client

#configure terminal	Enter Configure mode.
(config)#feature ntp vrf management	Enable feature on default or management VRF. By default this feature runs on management VRF..

## NTP Client Configuration

<code>(config)#ntp server 10.1.1.1 vrf management</code>	Configure ntp server ip address.
<code>(config)#ntp authenticate vrf management</code>	Enable NTP Authenticate. NTP authentication is disabled by default.
<code>(config)#ntp authentication-key 1234 md5 text vrf management</code>	Configure ntp authentication key along with md5 value.
<code>(config)#ntp trusted-key 1234 vrf management</code>	Configure trusted key <1-65535>
<code>(config)#commit</code>	Commit the configuration
<code>(config)#exit</code>	Exit from the Configure Mode.

### Validation

```
#show ntp authentication-status
  Authentication enabled
```

```
#show ntp authentication-keys
-----
Auth Key      MD5 String
-----
1234          SWWX
```

```
#show ntp trusted-keys
Trusted Keys:
1234
```

---

## NTP Client Configuration with IPv6 Address

NTP client, user can configure an association with a remote server. In this mode the client clock can synchronize to the remote server.

---

### Topology

Figure 17-27 shows the sample configuration of NTP Client.



Figure 17-27: NTP Client topology

## NTP Client

#configure terminal	Enter configure mode
(config)#feature ntp vrf management	Configure feature on default or management VRF. By default this feature runs on management VRF.
(config)# ntp enable vrf management	This feature enables NTP. This will be enabled in default.
(config)#ntp server 2001::1 vrf management	Configure NTP server IP address.
(config)#commit	Commit the configuration
(config)#exit	Exit from the Configure Mode.

## Validation

```
#show ntp peers
```

```
=====
```

```
Peer IP Address Serv/Peer
```

```
=====
```

```
2001::1 Server (configured)
```

```
#show ntp peer-status
```

```
Total peers : 1
```

```
* - selected for sync, + - peer mode(active),
```

```
- - peer mode(passive), = - polled in client mode
```

Remote	refid	st	when	poll	reach	delay	offset	jitter	
*2001::1	LOCAL(0)	7	u	14	32	37	0.194	-4.870	3.314

## Maxpoll and Minpoll Configuration

The maximum poll interval are specified in defaults to 6 (64 seconds), but can be increased by the maxpoll option to an upper limit of 16 (18.2 hours). The minimum poll interval defaults to 4 (16 seconds), and this is also the minimum value of the minpoll option. The client will retry between minpoll and maxpoll range configured for synchronization with the server.

### Client

#configure terminal	Enter configure mode
(config)#feature ntp vrf management	Configure feature on default or management VRF. By default this feature runs on management VRF
(config)#ntp server 2001::1 maxpoll 7 minpoll 5 vrf management	Configure minpoll and maxpoll range for NTP server
(config)#commit	Commit the configuration
(config)#exit	Exit from the Configure Mode

## Validation

```
#show ntp peers
```

```
=====
```

```

Peer IP Address Serv/Peer
=====
2001::1 Server (configured)
#show ntp peer-status
Total peers : 1
* - selected for sync, + - peer mode(active),
- - peer mode(passive), = - polled in client mode
  Remote  refid      st when poll reach delay  offset      jitter
=====
*2001::1  LOCAL(0) 7  u   14  32  37   0.194      -4.870      3.314
    
```

## NTP Authentication

When you enable NTP authentication, the device synchronizes to a time source only if the source carries the authentication keys specified with the source by key identifier. The device drops any packets that fail the authentication check, and prevents them from updating the local clock.

### Client

#configure terminal	Enter configure mode
(config)#feature ntp vrf management	Enable feature on default or management VRF. By default this feature runs on management VRF..
(config)#ntp server 2001::1 vrf management	Configure NTP server IP address.
(config)#ntp authenticate vrf management	Enable NTP Authenticate. NTP authentication is disabled by default.
(config)#ntp authentication-key 1234 md5 text vrf management	Configure NTP authentication key along with MD5 value.
(config)#ntp trusted-key 1234 vrf management	Configure trusted key
(config)#commit	Commit the configuration
(config)#exit	Exit from the Configure Mode.

### Validation

```

#show ntp authentication-status
Authentication enabled

#show ntp authentication-keys
----- Auth Key      MD5 String -----
                1234      SWWX

#show ntp trusted-keys
Trusted Keys: 1234
    
```



## CHAPTER 18 NTP Server Configuration

The Network Time Protocol (NTP) synchronizes the time of day among a set of distributed time servers and clients so that you can correlate events when you receive system logs and other time-specific events from multiple network devices. NTP uses the User Datagram Protocol (UDP) as its transport protocol. All NTP communications use Coordinated Universal Time (UTC).

An NTP server usually receives its time from an authoritative time source, such as a radio clock or an atomic clock attached to a time server, and then distributes this time across the network.

Above explained NTP Server and Client functionality will be supported in OcNOS. NTP Access restrictions can be configured to allow Client devices to access NTP Server.

### Topology

The procedures in this section use the topology as mentioned below :

Setup consists of two nodes. One node acting as NTP Master and the other node acting as NTP Client.

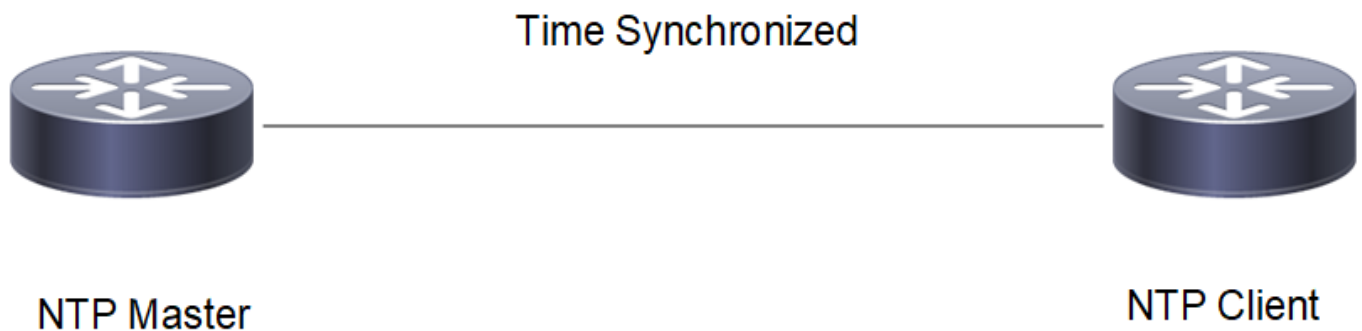

Figure 18-28: Synchronization of NTP Master and NTP Client

### Configuration

#### NTP Master

#configure terminal	Enter configure mode
(config)#feature ntp vrf management	Enable feature ntp
(config)#ntp enable vrf management	Enable ntp
(config)#ntp master vrf management	Configure the node as NTP master
(config)#ntp master stratum 1 vrf management	Configure the ntp stratum level as 1 indicating that it is using local clock
(config)#ntp allow 10.12.20.6 vrf management	Configure ntp client address in the ntp allow list
(config)#commit	Commit the candidate configuration to the running configuration
(config)#exit	Exit configure mode

## NTP Client

#configure terminal	Enter configure mode.
(config)#feature ntp vrf management	Enable feature ntp.
(config)#ntp enable vrf management	Enable ntp
(config)#ntp server 10.12.20.5 vrf management	Configure ntp server address for the sync to happen
(config)#commit	Commit the candidate configuration to the running
(config)#exit	Exit Configure mode

---

## Validation

Check the local clock synchronization in the NTP Master as mentioned below:

```
VTEP1#show ntp peer-status
  remote          refid          st t when poll reach  delay  offset  jitter
=====
*127.127.1.0     .LOCL.             1 1  59  64  377  0.000  0.000  0.000
```

Check the ntp client synchronization status as mentioned below:

```
#show ntp peer-status
Total peers : 1
* - selected for sync, + - peer mode(active),
- - peer mode(passive), = - polled in client mode,
x - source false ticker
  remote          refid          st t when poll reach  delay  offset  jitter
=====
*10.12.20.5     LOCAL(0)         2 u   4  16  377  0.137  -0.030  0.004
```

---

## Synchronization of more than one NTP clients with the NTP Master

In the below section, check the Synchronization of more than one NTP clients with the NTP Master using Subnet definition on the NTP Master.

---

## Topology

The procedures in this section use the topology as mentioned below:

Setup consists of three nodes. One node acting as NTP Master and the other two nodes acting as NTP Clients.

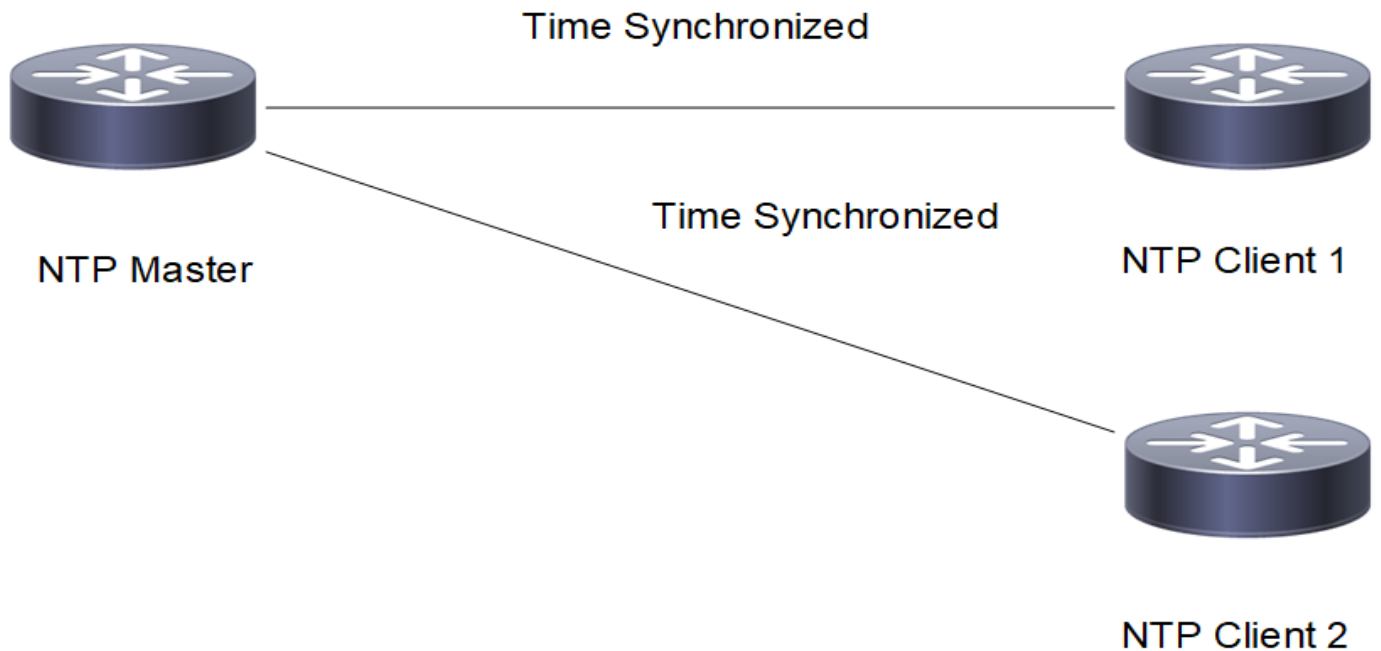

**Figure 18-29: Synchronization of more than one NTP clients with NTP Master using subnet definition**

## Configuration

### NTP Master

#configure terminal	Enter configure mode
(config)# feature ntp vrf management	Enable feature ntp
(config)# ntp enable vrf management	Enable ntp
(config)# ntp master vrf management	Configure the node as NTP master
(config)# ntp master stratum 1 vrf management	Configure the ntp stratum level as 1 indicating that it is using local clock
(config)# ntp allow 10.12.20.6 mask 255.255.255.0 vrf management	Configure the mask in the ntp allow list
(config)#commit	Commit the candidate configuration to the running
(config)# exit	Exit configure mode

### NTP Client1

#configure terminal	Enter configure mode.
(config)# feature ntp vrf management	Enable feature ntp.
(config)# ntp enable vrf management	Enable ntp
(config)# ntp server 10.12.20.5 vrf management	Configure ntp server address for the sync to happen

## NTP Server Configuration

---

(config)#commit	Commit the candidate configuration to the running
(config)# exit	Exit Configure mode

### NTP Client2

#configure terminal	Enter configure mode.
(config)# feature ntp vrf management	Enable feature ntp.
(config)# ntp enable vrf management	Enable ntp
(config)# ntp server 10.12.20.5 vrf management	Configure ntp server address for the sync to happen
(config)#commit	Commit the candidate configuration to the running
(config)# exit	Exit Configure mode

---

## Validation

Check the local clock synchronization in the NTP Master as mentioned below:

```
VTEP1#show ntp peer-status
      remote          refid          st t when poll reach  delay  offset  jitter
=====
*127.127.1.0        .LOCL.              1 1  59  64  377  0.000  0.000  0.000
```

Check the ntp client1 synchronization status as mentioned below :

```
#show ntp peer-status
Total peers : 1
* - selected for sync, + - peer mode(active),
- - peer mode(passive), = - polled in client mode,
x - source false ticker
      remote          refid          st t when poll reach  delay  offset  jitter
=====
*10.12.20.5        LOCAL(0)           2 u   8  32  377  0.153  -0.053  0.020
```

Check the ntp client2 synchronization status as mentioned below:

```
VTEP2#show ntp peer-status
Total peers : 1
* - selected for sync, + - peer mode(active),
- - peer mode(passive), = - polled in client mode,
x - source false ticker
      remote          refid          st t when poll reach  delay  offset  jitter
=====
*10.12.20.5        LOCAL(0)           2 u  14  16  377  0.150  -0.686  0.034
```

---

## Synchronization with Authentication

In the below section, check the synchronization of NTP Master and NTP Client with Authentication.

## Topology

The procedures in this section use the topology as mentioned below:

Setup consists of three nodes. One node acting as NTP Master and the other two nodes acting as NTP Clients.

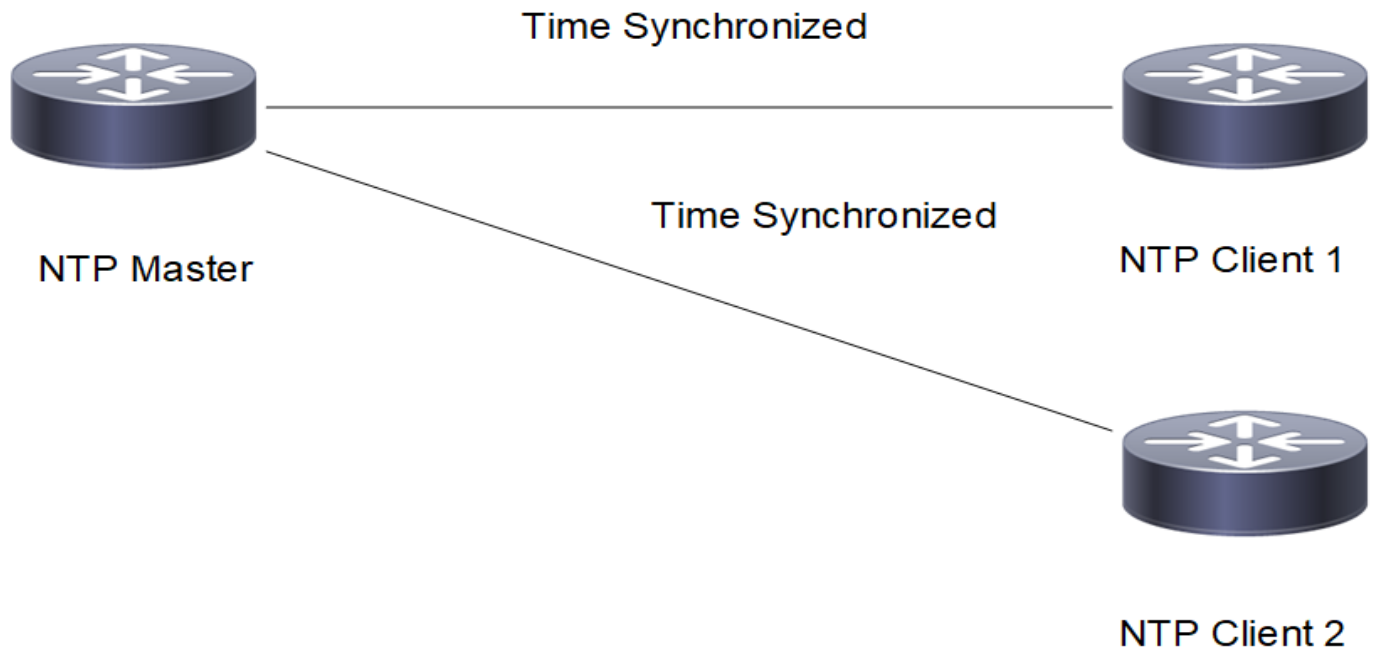

Figure 18-30: Synchronization of NTP Master and NTP Clients using authentication

## Configuration

### NTP Master

#configure terminal	Enter configure mode
(config)# feature ntp vrf management	Enable feature ntp
(config)# ntp enable vrf management	Enable ntp
(config)# ntp master vrf management	Configure the node as NTP master
(config)# ntp master stratum 1 vrf management	Configure the ntp stratum level as 1 indicating that it is using local clock
(config)# ntp authenticate vrf management	Configure ntp server for authentication
(config)# ntp authentication-key 65 md5 test123 vrf management	Configure ntp authentication key with password
(config)# ntp trusted-key 65 vrf management	Configure ntp trusted key
(config)# ntp allow 10.12.20.6 mask 255.255.255.0 vrf management	Configure the mask in the ntp allow list
(config)#commit	Commit the configuration
(config)# exit	Exit configure mode

**NTP Client1**

#configure terminal	Enter configure mode.
(config)# feature ntp vrf management	Enable feature ntp.
(config)# ntp enable vrf management	Enable ntp
(config)# ntp authenticate vrf management	Configure ntp client for authentication
(config)# ntp authentication-key 65 md5 test123 vrf management	Configure ntp authentication key with password
(config)# ntp trusted-key 65 vrf management	Configure ntp trusted key
(config)# ntp server 10.12.20.5 key 65 vrf management	Configure ntp server address for the sync to happen with authentication key
(config)#commit	Commit the configuration
(config)# exit	Exit Configure mode

**NTP Client2**

#configure terminal	Enter configure mode.
(config)# feature ntp vrf management	Enable feature ntp.
(config)# ntp enable vrf management	Enable ntp
(config)# ntp authenticate vrf management	Configure ntp client for authentication
(config)# ntp authentication-key 65 md5 test123 vrf management	Configure ntp authentication key with password
(config)# ntp trusted-key 65 vrf management	Configure ntp trusted key
(config)# ntp server 10.12.20.5 key 65 vrf management	Configure ntp server address for the sync to happen with authentication key
(config)#commit	Commit the configuration
(config)# exit	Exit Configure mode

**Validation**

Check the local clock synchronization in the NTP Master as mentioned below:

```
VTEP1#show ntp peer-status
      remote          refid          st t when poll reach  delay  offset  jitter
=====
*127.127.1.0        .LOCL.                1 1  64  64  377   0.000   0.000   0.000
```

Check the ntp client1 synchronization status as mentioned below:

```
#show ntp peer-status
Total peers : 1
* - selected for sync, + - peer mode(active),
- - peer mode(passive), = - polled in client mode,
x - source false ticker
      remote          refid          st t when poll reach  delay  offset  jitter
=====
*10.12.20.5        LOCAL(0)           2 u  12  64  377   0.185   0.002   0.006
```

Check the ntp client2 synchronization status as mentioned below :

```
VTEP2#show ntp peer-status
```

```
Total peers : 1
```

```
* - selected for sync, + - peer mode(active),
- - peer mode(passive), = - polled in client mode,
x - source false ticker
```

remote	refid	st	t	when	poll	reach	delay	offset	jitter
*10.12.20.5	LOCAL(0)	2	u	16	32	377	0.175	-0.360	0.226

---

## Synchronization of NTP Server and NTP Clients with NTP ACL

The command `nomodify ntp acl` signifies NTP Clients must be denied `ntpq(1)` and `ntpd(1)` queries which attempt to modify the state of the server (i.e., run time reconfiguration). Queries which return information shall be permitted.

The command `noquery ntp acl` signifies Deny `ntpq(1)` and `ntpd(1)` queries by NTP Clients. But Time service shall not be affected.

The command `nopeer ntp acl` signifies NTP Clients shall be denied access if unauthenticated packets which would result in mobilizing a new association is sent.

The command `notrap ntp acl` signifies NTP Clients shall be declined to provide mode 6 control message trap service to matching hosts. The trap service is a sub-system of the `ntpq(1)` control message protocol which is intended for use by remote event logging programs.

The command `KoD ntp acl` signifies When an access violation happens by NTP Clients, the server must send the KoD (kiss-o'-death) packets. KoD packets are rate limited to no more than one per second. If another KoD packet occurs within one second after the last one, the packet is dropped.

---

## Topology

The procedures in this section use the topology as mentioned below:

Setup consists of three nodes. One node acting as NTP Master and the other two nodes acting as NTP Clients.

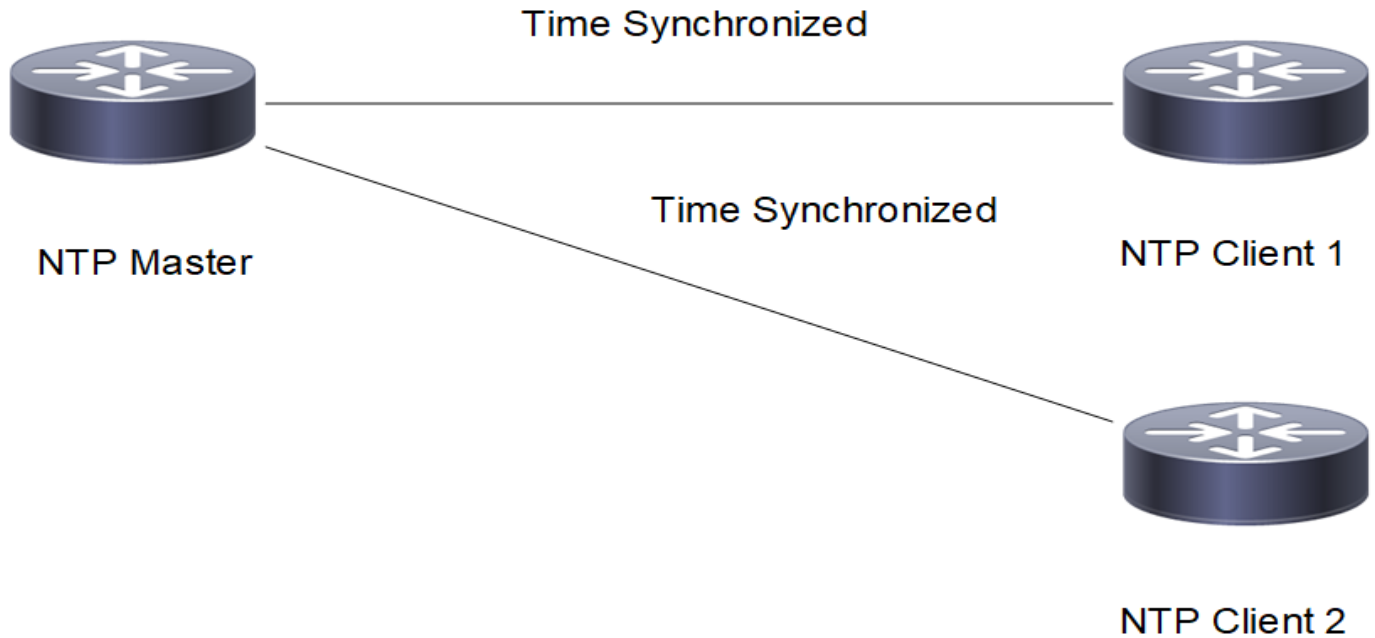

Figure 18-31: Synchronization of NTP Master and NTP Clients with NTP ACL

## Configuration

### NTP Master

#configure terminal	Enter configure mode
(config)# feature ntp vrf management	Enable feature ntp
(config)# ntp enable vrf management	Enable ntp
(config)# ntp master vrf management	Configure the node as NTP master
(config)# ntp master stratum 1 vrf management	Configure the ntp stratum level as 1 indicating that it is using local clock
(config)# ntp authenticate vrf management	Configure ntp server for authentication
(config)# ntp authentication-key 65 md5 test123 vrf management	Configure ntp authentication key with password
(config)# ntp trusted-key 65 vrf management	Configure ntp trusted key
(config)# ntp allow 10.12.20.6 mask 255.255.255.0 nomodify vrf management	Configure the ntp acl nomodify in the ntp allow list
(config)# ntp allow 10.12.20.6 mask 255.255.255.0 noquery vrf management	Configure the ntp acl noquery in the ntp allow list
(config)# ntp allow 10.12.20.6 mask 255.255.255.0 nopeer vrf management	Configure the ntp acl nopeer in the ntp allow list
(config)# ntp allow 10.12.20.6 mask 255.255.255.0 notrap vrf management	Configure the ntp acl notrap in the ntp allow list
(config)# ntp allow 10.12.20.6 mask 255.255.255.0 kod vrf management	Configure the ntp acl KoD in the ntp allow list



(config)#commit	Commit the configuration
(config)# exit	Exit configure mode

### NTP Client1

#configure terminal	Enter configure mode.
(config)# feature ntp vrf management	Enable feature ntp.
(config)# ntp enable vrf management	Enable ntp
(config)# ntp authenticate vrf management	Configure ntp client for authentication
(config)# ntp authentication-key 65 md5 test123 vrf management	Configure ntp authentication key with password
(config)# ntp trusted-key 65 vrf management	Configure ntp trusted key
(config)# ntp server 10.12.20.5 key 65 vrf management	Configure ntp server address for the sync to happen with authentication key
(config)#commit	Commit the configuration
(config)# exit	Exit Configure mode

### NTP Client2

#configure terminal	Enter configure mode.
(config)# feature ntp vrf management	Enable feature ntp.
(config)# ntp enable vrf management	Enable ntp
(config)# ntp authenticate vrf management	Configure ntp client for authentication
(config)# ntp authentication-key 65 md5 test123 vrf management	Configure ntp authentication key with password
(config)# ntp trusted-key 65 vrf management	Configure ntp trusted key
(config)# ntp server 10.12.20.5 key 65 vrf management	Configure ntp server address for the sync to happen with authentication key
(config)#commit	Commit the configuration
(config)# exit	Exit Configure mode

## Validation

Normal Time synchronization is not affected.

Check the local clock synchronization in the NTP Master as mentioned below:

```
VTEP1#show ntp peer-status
      remote          refid          st t when poll reach  delay  offset  jitter
=====
*127.127.1.0      .LOCL.              1 1  40  64  377   0.000   0.000   0.000
VTEP1#
```

Check the ntp client1 synchronization status as mentioned below:

```
#show ntp peer-status
Total peers : 1
* - selected for sync, + - peer mode(active),
```

```
- - peer mode(passive), = - polled in client mode,  
x - source false ticker  
      remote          refid          st t when poll reach  delay  offset  jitter  
=====
```

remote	refid	st	t	when	poll	reach	delay	offset	jitter
*10.12.20.5	LOCAL(0)	2	u	13	16	377	0.180	0.019	0.013

Check the ntp client2 synchronization status as mentioned below:

```
VTEP2#show ntp peer-status  
Total peers : 1  
* - selected for sync, + - peer mode(active),  
- - peer mode(passive), = - polled in client mode,  
x - source false ticker  
      remote          refid          st t when poll reach  delay  offset  jitter  
=====
```

remote	refid	st	t	when	poll	reach	delay	offset	jitter
*10.12.20.5	LOCAL(0)	2	u	15	16	377	0.185	-0.018	0.017

---

## Synchronization of NTP Server and NTP Clients with NTP ACL configured as noserve

The command `noserve ntp acl` signifies NTP Clients shall be denied all packets except `ntpq(1)` and `ntpd(1)` queries.

---

### Topology

The procedures in this section use the topology as mentioned below:

Setup consists of three nodes. One node acting as NTP Master and the other two nodes acting as NTP Clients.

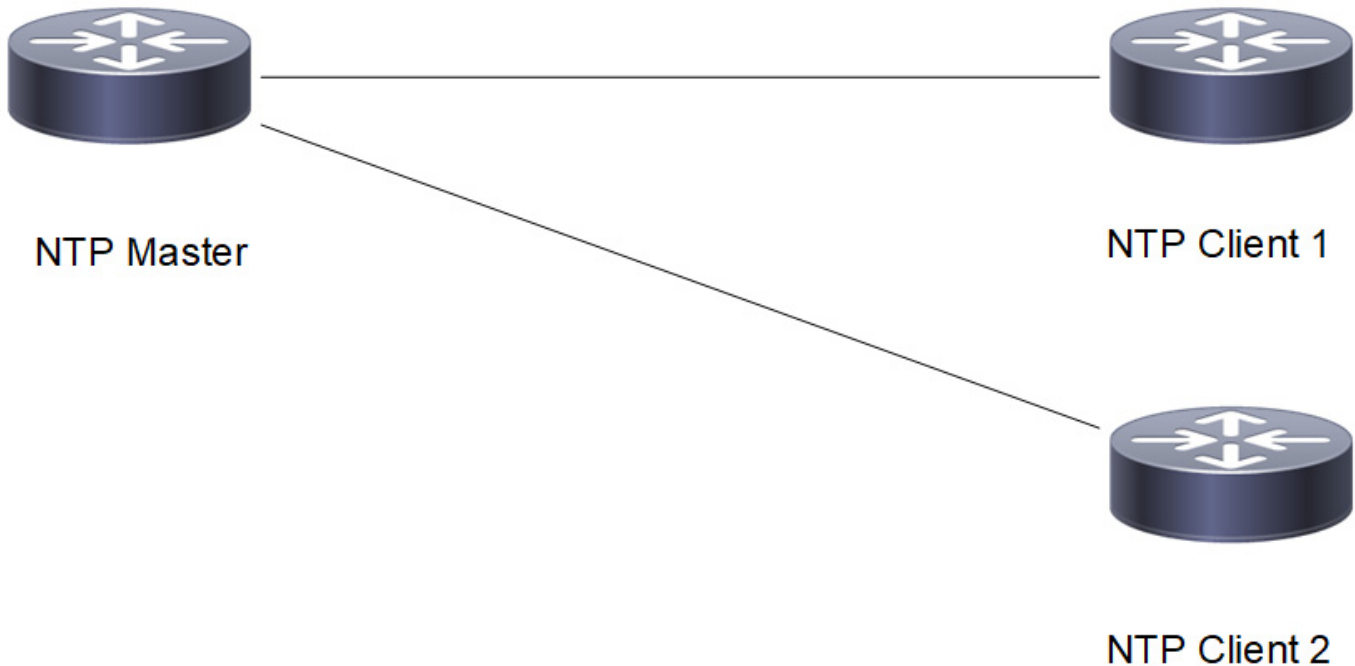

Figure 18-32: Synchronization of NTP Master and NTP Clients with NTP ACL as noserve

**NTP Master**

#configure terminal	Enter configure mode
(config)# feature ntp vrf management	Enable feature ntp
(config)# ntp enable vrf management	Enable ntp
(config)# ntp master vrf management	Configure the node as NTP master
(config)# ntp master stratum 1 vrf management	Configure the ntp stratum level as 1 indicating that it is using local clock
(config)# ntp authenticate vrf management	Configure ntp server for authentication
(config)# ntp authentication-key 65 md5 test123 vrf management	Configure ntp authentication key with password
(config)# ntp trusted-key 65 vrf management	Configure ntp trusted key
(config)# ntp allow 10.12.20.6 mask 255.255.255.0 noserve vrf management	Configure the ntp acl noserve in the ntp allow list
(config)#commit	Commit the configuration
(config)# exit	Exit configure mode

**NTP Client1**

#configure terminal	Enter configure mode.
(config)#feature ntp vrf management	Enable feature ntp.
(config)#ntp enable vrf management	Enable ntp
(config)#ntp authenticate vrf management	Configure ntp client for authentication
(config)#ntp authentication-key 65 md5 test123 vrf management	Configure ntp authentication key with password
(config)#ntp trusted-key 65 vrf management	Configure ntp trusted key
(config)#ntp server 10.12.20.5 key 65 vrf management	Configure ntp server address for the sync to happen with authentication key
(config)#commit	Commit the configuration
(config)#exit	Exit Configure mode

**NTP Client2**

#configure terminal	Enter configure mode.
(config)#feature ntp vrf management	Enable feature ntp.
(config)#ntp enable vrf management	Enable ntp
(config)#ntp authenticate vrf management	Configure ntp client for authentication
(config)#ntp authentication-key 65 md5 test123 vrf management	Configure ntp authentication key with password
(config)#ntp trusted-key 65 vrf management	Configure ntp trusted key
(config)#ntp server 10.12.20.5 key 65 vrf management	Configure ntp server address for the sync to happen with authentication key
(config)#commit	Commit the configuration
(config)#exit	Exit Configure mode

## Validation

Check that with NTP acl configured as noserve, Normal Time synchronization is affected and there is no synchronization.

Check the local clock synchronization in the NTP Master as mentioned below:

```
VTEP1#show ntp peer-status
      remote          refid          st t when poll reach  delay  offset  jitter
=====
*127.127.1.0        .LOCL.             1 1  41  64  377  0.000  0.000  0.000
```

Check the ntp client1 synchronization status as mentioned below:

```
#show ntp peer-status
Total peers : 1
* - selected for sync, + - peer mode(active),
- - peer mode(passive), = - polled in client mode,
x - source false ticker
      remote          refid          st t when poll reach  delay  offset  jitter
=====
10.12.20.5         .INIT.             16 u   -  64   0  0.000  0.000  0.000
```

Check the ntp client2 synchronization status as mentioned below:

```
VTEP2#show ntp peer-status
Total peers : 1
* - selected for sync, + - peer mode(active),
- - peer mode(passive), = - polled in client mode,
x - source false ticker
      remote          refid          st t when poll reach  delay  offset  jitter
=====
10.12.20.5         .INIT.             16 u   -  64   0  0.000  0.000  0.000
```

---

## Synchronization of NTP Client with Stratum 2 NTP Master

In the below section, check Synchronization of NTP Client with Stratum 2 NTP Master.

---

## Topology

The procedures in this section use the topology as mentioned below:

Setup consists of three nodes. First node acting as Stratum 1 NTP Master, Second node acting as Stratum 2 NTP master and the third node acting as NTP client.

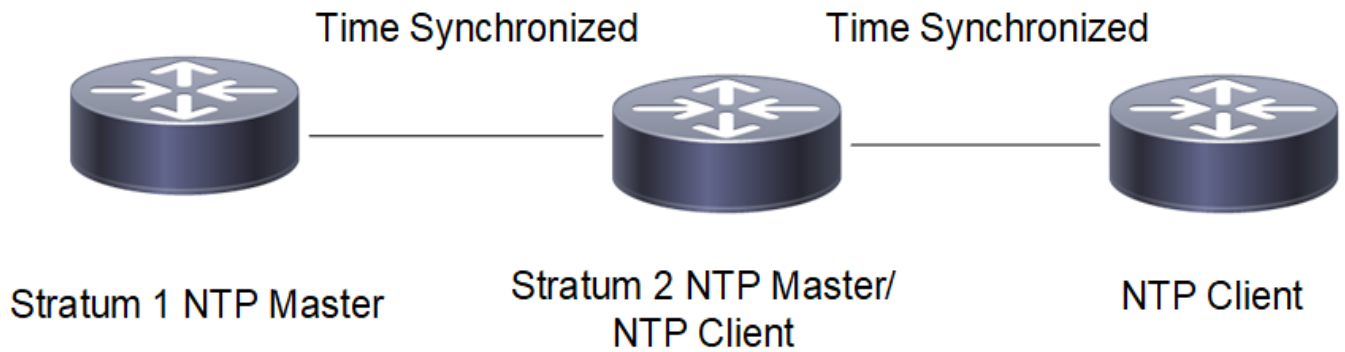

Figure 18-33: Synchronization of Stadium 2 NTP Master with NTP Client

## Configuration

### Stratum 1 NTP Master

#configure terminal	Enter configure mode
(config)#feature ntp vrf management	Enable feature ntp
(config)#ntp enable vrf management	Enable ntp
(config)#ntp master vrf management	Configure the node as NTP master
(config)#ntp master stratum 1 vrf management	Configure the ntp stratum level as 1 indicating that it is using local clock
(config)#ntp allow 10.12.20.5 vrf management	Configure the ntp client ip address in the ntp allow list
(config)#commit	Commit the configuration
(config)#exit	Exit configure mode

### Stratum 2 NTP Server/NTP Client

#configure terminal	Enter configure mode.
(config)#feature ntp vrf management	Enable feature ntp.
(config)#ntp enable vrf management	Enable ntp
(config)#ntp master vrf management	Configure the node as NTP Master
(config)#ntp master stratum 2 vrf management	Configure the node as stratum 2 ntp master
(config)#ntp allow 10.12.20.6 vrf management	Configure NTP client ip address in the ntp allow list
(config)#ntp server 10.12.20.7 vrf management	Configure the stratum 1 NTP master ip address for time synchronization
(config)#commit	Commit the configuration
(config)#exit	Exit Configure mode

## NTP Client

#configure terminal	Enter configure mode.
(config)#feature ntp vrf management	Enable feature ntp.
(config)#ntp enable vrf management	Enable ntp
(config)#ntp server 10.12.20.5 vrf management	Configure ntp server address for the sync to happen
(config)#commit	Commit the configuration
(config)#exit	Exit Configure mode

## Validation

Check that NTP Client successfully synchronizes the time with stratum 2 NTP Master.

Check the local clock synchronization in the Stratum 1 NTP Master as mentioned below:

```
VTEP2#show ntp peer-status
      remote          refid          st t when poll reach  delay  offset  jitter
=====
*127.127.1.0      .LOCL.              1 1  22  64  377  0.000  0.000  0.000
```

Check the Stratum 2 NTP Master/NTP client synchronization status as mentioned below:

```
VTEP1#show ntp peer-status
Total peers : 1
* - selected for sync, + - peer mode(active),
- - peer mode(passive), = - polled in client mode,
x - source false ticker
      remote          refid          st t when poll reach  delay  offset  jitter
=====
*10.12.20.7      LOCAL(0)          2 u  33  64  377  0.145  0.010  0.009
127.127.1.0      .LOCL.              2 1 110m 64   0  0.000  0.000  0.000
```

Check the NTP Client synchronization status as mentioned below:

```
#show ntp peer-status
Total peers : 1
* - selected for sync, + - peer mode(active),
- - peer mode(passive), = - polled in client mode,
x - source false ticker
      remote          refid          st t when poll reach  delay  offset  jitter
=====
*10.12.20.5      10.12.20.7        3 u  16  64  377  0.137  -2.596  0.235
```

## CHAPTER 19 TACACS Client Configuration

### Overview

Terminal Access Controller Access Control System (TACACS) is a remote authentication protocol that is used to communicate with an authentication server. With TACACS, a network device communicates to an authentication server to determine whether a particular user should be allowed access to the device. TACACS+ listens at port 49.

### TACACS Server Authentication

#### IPv4 Address Configuration

This section shows a TACACS+ server is configured with an IPv4 address. Authentication messages are transmitted to TACACS+ server from the device using an IPv4 address.

#### Topology

Figure 19-34 shows the sample configuration of TACACS+ server.

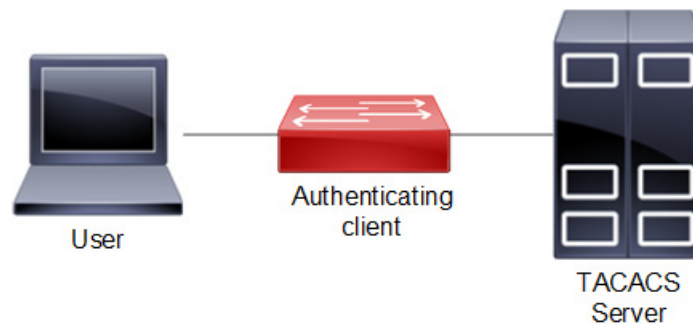

Figure 19-34: TACACS Server Host Configuration

#### Authenticating Client

#configure terminal	Enter configure mode.
(config)#feature tacacs+ vrf management	Enable the feature TACACS+ for management vrf
(config)#feature tacacs+	Enable the feature TACACS+. for default vrf
(config)#tacacs-server login key 0 testing101 vrf management	Specify the global key for tacacs servers that are not configured with their respective keys for management vrf This key should match the one present in the config file of tacacs server
(config)#tacacs-server login key 0 testing101	Specify the global key for tacacs servers that are not configured with their respective keys for default vrf This key should match the one present in the config file of tacacs server
(config)#tacacs-server login host 10.16.19.2 vrf management seq-num 1 key 0 testing123	Specify the tacacs server ipv4 address to be configured with shared key. The same key should be present on the server config file

## TACACS Client Configuration

<pre>(config)#tacacs-server login host 10.16.19.2 seq-num 3 key 0 testing123</pre>	Specify the tacacs server ipv4 address to be configured with shared local key for default vrf The same key should be present on the server config file.
<pre>(config)#tacacs-server login host 10.12.30.86 vrf management seq-num 4 port 1045</pre>	Specify the tacacs server ipv4 address to be configured with the sequence and port number.The tacacs server should be started with same port number
<pre>config)#tacacs-server login host 10.12.30.86 seq-num 2 port 1045</pre>	Specify the tacacs server ipv4 address to be configured with the sequence and port number for default vrf. The tacacs server should be started with same port number
<pre>(config)#tacacs-server login host 10.12.17.11 vrf management seq-num 8 key 7 65535 port 65535</pre>	Specify the tacacs server ipv4 address to be configured with the sequence, key and port number for management vrf. The tacacs server should be started with same port number.
<pre>(config)#tacacs-server login host 10.12.17.11 seq-num 8 key 7 65535 port 65535</pre>	Specify the tacacs server ipv4 address to be configured with the sequence, key and port number for default vrf. The tacacs server should be started with same port number.
<pre>(config)#tacacs-server login host Tacacs- Server-1 vrf management seq-num 7 key 7 65535 port 65535</pre>	Specify the tacacs server configured with host-name sequence number key and port number for management vrf. The tacacs server should be started with same port number
<pre>(config)#tacacs-server login host Tacacs- Server-1 seq-num 7 key 7 65535 port 65535</pre>	Specify the tacacs server configured with host-name sequence number key and port number for default vrf. The tacacs server should be started with same port number
<pre>(config)#aaa authentication login default vrf management group tacacs+</pre>	Enable authentication for TACACS+ server configured for management vrf. Authorization is also enabled by default
<pre>(config)#aaa authentication login default group tacacs+</pre>	Enable authentication for TACACS+ server configured for default vrf. Authorization is also enabled by default.
<pre>(config)#aaa authentication login default vrf management group tacacs+ local</pre>	Enable authentication for TACACS+ and fall-back to local configured for management vrf. Authorization is also enabled by default
<pre>(config)#aaa authentication login default vrf management group tacacs+ local none</pre>	Enable authentication for TACACS+ fall-back to local followed by fall-back to none configured for management vrf. Authorization is also enabled by default
<pre>(config)#aaa authentication login default vrf management group tacacs+ none</pre>	Enable authentication for TACACS+ fall-back to none configured for management vrf. Authorization is also enabled by default
<pre>(config)#aaa authentication login default group tacacs+ none</pre>	Enable authentication for TACACS+ fall-back to none , configured for default vrf. Authorization is also enabled by default
<pre>(config)#aaa group server tacacs+ G1 vrf management</pre>	Create aaa group G1 for management vrf
<pre>(config-tacacs)#server 10.12.30.86 vrf management</pre>	Make the tacacs-server 10.12.30.86 a part of this group G1 for default vrf
<pre>(config-tacacs)#server Tacacs-Server-1</pre>	Make the tacacs-server Tacacs-Server-1 a part of this group G1 for management vrf
<pre>(config-tacacs)#exit</pre>	Exit the tacacs-config
<pre>(config)#commit</pre>	Commit the configuration
<pre>(config)#aaa group server tacacs+ G1</pre>	Create aaa group G1 for default vrf
<pre>(config-tacacs)server 10.12.30.86</pre>	Make the tacacs-server 10.12.30.86 a part of this group G1 for default vrf
<pre>(config-tacacs)#server Tacacs-Server-1</pre>	Make the tacacs-server Tacacs-Server-1 a part of this group G1 for management vrf
<pre>(config-tacacs)#exit</pre>	Exit the tacacs-config mode



(config)#commit	Commit the configuration
(config)#aaa authentication login default vrf management group G1	Authenticate the tacacs+ group G1 with aaa authentication for management vrf
(config)#aaa authentication login default group G1	Authenticate the tacacs+ group G1 with aaa authentication for default vrf
(config)#commit	Commit the configuration

Users are mapped as shown as shown in [Table 19-1](#):

**Table 19-1: Role/privilege level mapping**

Role	Privilege level
Network administrator	15
Network engineer	14
Network operator	1 to 13
Network user	0 or any other values (>15 or negative values or any character)

## Validation

```
Leaf1#show tacacs-server vrf management
      VRF: management
total number of servers:4
```

```
Tacacs+ Server           : 10.16.19.2/49
  Sequence Number        : 1
  Failed Auth Attempts   : 0
  Success Auth Attempts  : 0
  Failed Connect Attempts : 0
  Last Successful authentication:
```

```
Tacacs+ Server           : 10.12.30.86/1045
  Sequence Number        : 2
  Failed Auth Attempts   : 0
  Success Auth Attempts  : 0
  Failed Connect Attempts : 0
  Last Successful authentication:
```

```
Tacacs+ Server           : Tacacs-Server-1/65535
  Sequence Number        : 7
  Failed Auth Attempts   : 0
  Success Auth Attempts  : 0
  Failed Connect Attempts : 0
  Last Successful authentication:
```

```
Tacacs+ Server           : 10.12.17.11/65535
  Sequence Number        : 8
  Failed Auth Attempts   : 0
  Success Auth Attempts  : 0
  Failed Connect Attempts : 0
  Last Successful authentication:
```

```
Leaf1#show tacacs-server
      VRF: default
```

## TACACS Client Configuration

---

total number of servers:4

Tacacs+ Server : 10.16.19.2/49  
Sequence Number : 1  
Failed Auth Attempts : 0  
Success Auth Attempts : 0  
Failed Connect Attempts : 0  
Last Successful authentication:

Tacacs+ Server : 10.12.30.86/1045  
Sequence Number : 2  
Failed Auth Attempts : 0  
Success Auth Attempts : 0  
Failed Connect Attempts : 0  
Last Successful authentication:

Tacacs+ Server : Tacacs-Server-1/65535  
Sequence Number : 7  
Failed Auth Attempts : 0  
Success Auth Attempts : 0  
Failed Connect Attempts : 0  
Last Successful authentication:

Tacacs+ Server : 10.12.17.11/65535  
Sequence Number : 8  
Failed Auth Attempts : 0  
Success Auth Attempts : 0  
Failed Connect Attempts : 0  
Last Successful authentication:

(\*) indicates last active.

#show tacacs-server vrf all  
VRF: management

total number of servers:2

Tacacs+ Server : Tacacs-Server-1/65535 (\*)  
Sequence Number : 7  
Failed Auth Attempts : 0  
Success Auth Attempts : 1  
Failed Connect Attempts : 0  
Last Successful authentication: 2018 October 30, 10:10:22

Tacacs+ Server : 10.12.17.11/65535  
Sequence Number : 8  
Failed Auth Attempts : 0  
Success Auth Attempts : 0  
Failed Connect Attempts : 0  
Last Successful authentication:

VRF: default

total number of servers:2

Tacacs+ Server : Tacacs-Server-1/2222  
Sequence Number : 7  
Failed Auth Attempts : 0  
Success Auth Attempts : 0

---

```
Failed Connect Attempts      : 0
Last Successful authentication:
```

```
Tacacs+ Server               : 100.0.0.1/2222
    Sequence Number          : 8
    Failed Auth Attempts     : 0
    Success Auth Attempts    : 0
    Failed Connect Attempts  : 0
Last Successful authentication:
```

(\*) indicates last active.

```
#show tacacs-server
    VRF: default
total number of servers:2
```

```
Tacacs+ Server               : Tacacs-Server-1/2222
    Sequence Number          : 7
    Failed Auth Attempts     : 0
    Success Auth Attempts    : 0
    Failed Connect Attempts  : 0
Last Successful authentication:
```

```
Tacacs+ Server               : 100.0.0.1/2222
    Sequence Number          : 8
    Failed Auth Attempts     : 0
    Success Auth Attempts    : 0
    Failed Connect Attempts  : 0
Last Successful authentication:
```

(\*) indicates last active.

```
#show tacacs-server vrf management groups G1
    VRF: management
```

```
group G1:
    server Tacacs-Server-1:
        seq-num 7
        port is 65535
        key is *****

    server 10.12.17.11:
        seq-num 8
        port is 65535
        key is *****
```

```
#show tacacs-server vrf all groups G1
    VRF: management
```

```
group G1:
    server Tacacs-Server-1:
        seq-num 7
        port is 65535
        key is *****

    server 10.12.17.11:
```

```
seq-num 8
port is 65535
key is *****
```

VRF: default

```
group G1:
server Tacacs-Server-1:
seq-num 7
port is 2222
key is *****

server 100.0.0.1:
seq-num 8
port is 2222
key is *****
```

```
#show tacacs-server groups G1
```

VRF: default

```
group G1:
server Tacacs-Server-1:
seq-num 7
port is 2222
key is *****

server 100.0.0.1:
seq-num 8
port is 2222
key is *****
```

```
#show tacacs vrf management
```

VRF: management

total number of servers:2

```
Tacacs+ Server           : Tacacs-Server-1/65535 (*)
  Sequence Number        : 7
  Failed Auth Attempts   : 0
  Success Auth Attempts  : 1
  Failed Connect Attempts : 0
  Last Successful authentication: 2018 October 30, 10:10:22
```

```
Tacacs+ Server           : 10.12.17.11/65535
  Sequence Number        : 8
  Failed Auth Attempts   : 0
  Success Auth Attempts  : 0
  Failed Connect Attempts : 0
  Last Successful authentication:
```

(\*) indicates last active.

```
#show tacacs vrf all
```

VRF: management

total number of servers:2

```
Tacacs+ Server           : Tacacs-Server-1/65535 (*)
  Sequence Number        : 7
  Failed Auth Attempts   : 0
```

---

```
      Success Auth Attempts      : 1
      Failed Connect Attempts    : 0
      Last Successful authentication: 2018 October 30, 10:10:22

Tacacs+ Server                   : 10.12.17.11/65535
      Sequence Number           : 8
      Failed Auth Attempts      : 0
      Success Auth Attempts     : 0
      Failed Connect Attempts    : 0
      Last Successful authentication:
```

```
      VRF: default
total number of servers:2
```

```
Tacacs+ Server                   : Tacacs-Server-1/2222(*)
      Sequence Number           : 7
      Failed Auth Attempts      : 0
      Success Auth Attempts     : 1
      Failed Connect Attempts    : 0
      Last Successful authentication: 2018 October 30, 10:32:52
```

```
Tacacs+ Server                   : 100.0.0.1/2222
      Sequence Number           : 8
      Failed Auth Attempts      : 0
      Success Auth Attempts     : 0
      Failed Connect Attempts    : 0
      Last Successful authentication:
```

(\*) indicates last active.

```
#show tacacs
```

```
      VRF: default
total number of servers:2
```

```
Tacacs+ Server                   : Tacacs-Server-1/2222(*)
      Sequence Number           : 7
      Failed Auth Attempts      : 0
      Success Auth Attempts     : 1
      Failed Connect Attempts    : 0
      Last Successful authentication: 2018 October 30, 10:32:52
```

```
Tacacs+ Server                   : 100.0.0.1/2222
      Sequence Number           : 8
      Failed Auth Attempts      : 0
      Success Auth Attempts     : 0
      Failed Connect Attempts    : 0
      Last Successful authentication:
```

(\*) indicates last active.

```
#show tacacs vrf management
```

```
      VRF: management
total number of servers:2
```

```
Tacacs+ Server                   : Tacacs-Server-1/65535(*)
```

## TACACS Client Configuration

---

```
Sequence Number      : 7
Failed Auth Attempts : 0
Success Auth Attempts : 1
Failed Connect Attempts : 0
Last Successful authentication: 2018 October 30, 10:10:22
```

```
Tacacs+ Server      : 10.12.17.11/65535
Sequence Number     : 8
Failed Auth Attempts : 0
Success Auth Attempts : 0
Failed Connect Attempts : 0
Last Successful authentication:
```

(\*) indicates last active.

```
#show tacacs vrf all
VRF: management
total number of servers:2
```

```
Tacacs+ Server      : Tacacs-Server-1/65535 (*)
Sequence Number     : 7
Failed Auth Attempts : 0
Success Auth Attempts : 1
Failed Connect Attempts : 0
Last Successful authentication: 2018 October 30, 10:10:22
```

```
Tacacs+ Server      : 10.12.17.11/65535
Sequence Number     : 8
Failed Auth Attempts : 0
Success Auth Attempts : 0
Failed Connect Attempts : 0
Last Successful authentication:
```

```
VRF: default
total number of servers:2
```

```
Tacacs+ Server      : Tacacs-Server-1/2222 (*)
Sequence Number     : 7
Failed Auth Attempts : 0
Success Auth Attempts : 1
Failed Connect Attempts : 0
Last Successful authentication: 2018 October 30, 10:32:52
```

```
Tacacs+ Server      : 100.0.0.1/2222
Sequence Number     : 8
Failed Auth Attempts : 0
Success Auth Attempts : 0
Failed Connect Attempts : 0
Last Successful authentication:
```

(\*) indicates last active.

```
#show tacacs
VRF: default
total number of servers:2
```

---

```
Tacacs+ Server           : Tacacs-Server-1/2222 (*)
  Sequence Number       : 7
  Failed Auth Attempts  : 0
  Success Auth Attempts : 1
  Failed Connect Attempts : 0
  Last Successful authentication: 2018 October 30, 10:32:52
```

```
Tacacs+ Server           : 100.0.0.1/2222
  Sequence Number       : 8
  Failed Auth Attempts  : 0
  Success Auth Attempts : 0
  Failed Connect Attempts : 0
  Last Successful authentication:
```

(\*) indicates last active.

```
#show aaa authentication vrf management
      VRF: management
  default: group G1
  console: local
```

```
#show aaa authentication vrf all
      VRF: management
  default: group G1
  console: local
```

```
      VRF: default
  default: group tacacs+
  console: local
```

```
#show aaa authentication
      VRF: default
  default: group tacacs+
  console: local
```

```
# show aaa groups vrf management
      VRF: management
radius
tacacs+
G1
```

```
# show aaa groups vrf all
      VRF: management
radius
tacacs+
G1
```

```
      VRF: default
radius
tacacs+
G1
```

```
#show aaa groups
      VRF: default
radius
tacacs+
```

G1

```
#show running-config tacacs+
feature tacacs+ vrf management
tacacs-server login host Tacacs-Server-1 vrf management seq-num 7 key 7 65535
po
rt 65535
tacacs-server login host 10.12.17.11 vrf management seq-num 8 key 7 65535 port
6
5535
```

```
feature tacacs+
tacacs-server login host Tacacs-Server-1 seq-num 7 key 7 65535 port 2222
tacacs-server login host 100.0.0.1 seq-num 8 key 7 65535 port 2222
```

```
#show running-config aaa
aaa authentication login default vrf management group G1
aaa group server tacacs+ G1 vrf management
    server Tacacs-Server-1 vrf management
    server 10.12.17.11 vrf management
```

```
aaa authentication login default group tacacs+
aaa group server tacacs+ G1
    server Tacacs-Server-1
    server 100.0.0.1
```

```
#show running-config aaa all
aaa authentication login default vrf management group G1
aaa authentication login console local
aaa accounting default vrf management local
no aaa authentication login default fallback error local vrf management
no aaa authentication login console fallback error local
no aaa authentication login error-enable vrf management
aaa local authentication attempts max-fail 3
aaa local authentication unlock-timeout 1200
aaa group server tacacs+ G1 vrf management
    server Tacacs-Server-1 vrf management
    server 10.12.17.11 vrf management
```

```
aaa authentication login default group tacacs+
aaa authentication login console local
aaa accounting default local
no aaa authentication login default fallback error local
no aaa authentication login console fallback error local
no aaa authentication login error-enable
aaa local authentication attempts max-fail 3
aaa local authentication unlock-timeout 1200
aaa group server tacacs+ G1
    server Tacacs-Server-1
    server 100.0.0.1
```

---

## IPv6 Address Configuration

This section shows a TACACS+ server is configured with an IPv6 address. Authentication messages are transmitted to TACACS+ server from the device using an IPv6 address.



## Topology

Figure 19-35 shows the sample configuration of TACACS+ server.

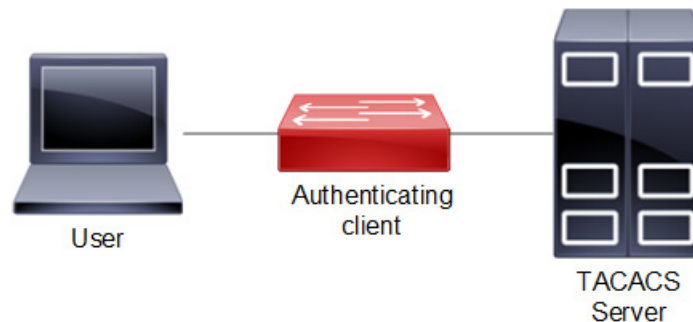

Figure 19-35: TACACS+ server topology

## Authenticating Client

R1#configure terminal	Enter configure mode.
R1(config)#tacacs-server login host 2001:db8:100::2 vrf management seq-num 1 key 0 testing123	Configure TACACS+ server with IPv6 address
R1(config)# aaa authentication login default vrf management group tacacs+	Configure AAA authentication
R1(config)#tacacs-server login host 2001:db8:100::2 vrf management seq-num 1	Config for IPv6 TACACS server with seq-num
R1(config)# ip host vrf management Server1 2001:db8:100::2	Config for assigning hostname to valid IPv6 address
R1(config)#feature tacacs+ vrf management	Config for enabling the TACACS+ server
R1(config)#tacacs-server login host 2002::3 vrf management seq-num 5 key 0 def_abc port 65535 timeout 60	Config for IPv6 TACACS+ server address with key, port and timeout
R1(config)#tacacs-server login timeout 60	Config timeout for TACACS server
R1(config)#tacacs-server login key 7 65535	Config login key for TACACS server
R1(config)# interface eth0	Navigate to the interface mode
R1(config-if)#ipv6 address 2001:db8:100::5/64	Configure IPv6 address on the eth0 interface
R1(config-if)# exit	Exit interface configure mode
R1(config)#commit	Commit the configuration
R1(config)# exit	Exit configure mode

## Validation

Perform TELNET to the Router. Provide the username mentioned in the TACACS+ server "users" file as telnet username. Check that Router sends TACACS request to the TACACS server using IPv6 address.

```
#show running-config tacacs+
tacacs-server login host 2002::3 seq-num 1 key 7 0x6f32ba3f9e05a3db
```

```
#sh tacacs-server
    VRF: default
```

## TACACS Client Configuration

---

total number of servers:1

```
Tacacs+ Server          : 2002::3/49
    Sequence Number     : 1
    Failed Auth Attempts : 0
    Success Auth Attempts : 0
    Failed Connect Attempts : 0
    Last Successful authentication:
```

(\*) indicates last active.

```
#show running-config aaa
aaa authentication login default vrf management group tacacs+
aaa authentication login error-enable vrf management
```

```
#show ipv6 interface eth0 brief
Interface          IPv6-Address          Admin-Sta
tus
eth0                2001:db8:100:::5
                   fe80::218:23ff:fe30:e6ba [up/up]
```

---

## TACACS Server Accounting

After authentication, the user can configure accounting to measure the resources that the user consumes during access.

---

### Authenticating Device

#configure terminal	Enter configure mode.
(config)#feature tacacs+ vrf management	Enable the feature TACACS+ for vrf management
(config)#feature tacacs+	Enable the feature TACACS+ for default vrf
(config)#tacacs-server login host 10.16.19.2 vrf management seq-num 1 key 0 testing123	Specify the TACACS server IPv4 address to be configured with shared key for vrf management. The same key should be present in the server configuration file.
(config)#tacacs-server login host 10.16.19.2 seq-num 3 key 0 testing123	Specify the TACACS server IPv4 address to be configured with shared key default vrf. The same key should be present in the server configuration file.
(config)#aaa accounting default vrf management group tacacs+	Enable accounting for TACACS server configured for vrf management.
(config)#aaa accounting default group tacacs+	Enable accounting for TACACS server configured for default vrf
(config)#commit	Commit the configuration
(config)#exit	Exit configure mode
#clear tacacs-server counters vrf management	Clear tacacs server counters for management vrf
#clear tacacs-server counters vrf all	Clear tacacs server counters for management and default vrf
#clear tacacs-server counters	Clear tacacs server counters for default vrf

To verify the TACACS accounting process, connect using SSH or Telnet from the host to the client with the user created and provided TACACS server password, and check whether the client validates the user with corresponding username and password.

---

## Validation Commands

show tacacs-server, show aaa accounting, show aaa accounting

```
#show aaa accounting vrf management
                        VRF: management
                        default: group tacacs+
#
```

```
#show aaa accounting vrf all
                        VRF: management
                        default: group tacacs+

                        VRF: default
                        default: group tacacs+
```

```
#show aaa accounting
                        VRF: default
                        default: group tacacs+
#
```

```
#show running-config aaa
aaa authentication login default vrf management group G1
aaa accounting default vrf management group tacacs+
aaa group server tacacs+ G1 vrf management
server Tacacs-Server-1 vrf management
server 10.12.17.11 vrf management

aaa authentication login default group tacacs+
aaa accounting default group tacacs+
aaa group server tacacs+ G1
server Tacacs-Server-1
server 100.0.0.1
```

## Sample TACACS Config File Contents

```
#tacacs configuration file
#set the key

key = "testing123"
accounting file = /var/log/tac_acc.log

user = test1 {
    default service = permit
    login = cleartext "12345"
}

group = netadmin {
    service = ppp protocol = ip {
        priv-lvl = 1
    }
}
```

```
user = test2 {
    default service = permit
    login = cleartext "12345"
    member = netadmin
}

user = test3 {
    default service = permit
    login = cleartext "12345"
    service = ppp protocol = ip {
        priv-lvl = 15
    }
}
```

---

## TACACS Server Authorization

Authorization is realized by mapping the authenticated users to one of the existing predefined roles as shown in [Table 19-1](#).

The privilege information from the TACACS+ server is retrieved for the authenticated users and is mapped onto one of the roles as shown in [Table 19-1](#).

Each authenticated user is mapped to one of the pre-defined privilege level.

Users with priv-level <=0 and priv-level > 15 are treated as read-only user mapped onto the pre-defined network-user role.

There is no command to enable authorization. Authorization functionality is enabled by default when remote authentication is enabled with TACACS+.

Authorization is "auto-enabled". After successful authentication, a user can enter into privilege exec mode, irrespective of its privilege level and such user is not prompted with enable mode password, if configured. However based on their role, commands are rejected if not allowed to perform certain operations.

---

### Example

A network-user has read-only access and can only execute show commands. A network-user cannot enter configure mode. An error message is displayed upon executing any command which is not allowed.

```
#write
% Access restricted for user %
#configure terminal
% Access restricted for user %
```

The following attribute value pair in TACACS+ server is used to fetch user privilege information.

```
service = ppp protocol = ip {
    priv-lvl = <0...15>
}
```

---

### Sample TACACS+ Configuration File

```
#tacacs configuration file from "tac_plus version F4.0.3.alpha "
#set the key

key = "testing123"
```

---

```
accounting file = /var/log/tac_acc.log

#Read only user "test1", without any priv-lvl, mapped to role "network-user"
user = test1 {
default service = permit
login = cleartext "12345"
}

#We can create a group of users mapped to a privilege
group = netadmin {
service = ppp protocol = ip {
priv-lvl = 15
}
}

#User "test2" with highest priv-lvl=15, mapped to role "network-admin"
user = test2 {
default service = permit
login = cleartext "12345"
member = netadmin
}

#User "test3" with priv-lvl= 1...13, mapped to role "network-operator"
user = test3 {
default service = permit
login = cleartext "12345"
service = ppp protocol = ip {
priv-lvl = 10
}
}

#User "test4" with priv-lvl=14, mapped to role "network-engineer" user = test4 {
default service = permit
login = cleartext "12345"
service = ppp protocol = ip {
priv-lvl = 14
}
}
```



## CHAPTER 20 RADIUS Client Configuration

### Overview

Remote Authentication Dial In User Service (RADIUS) is a remote authentication protocol that is used to communicate with an authentication server.

A RADIUS server is responsible for receiving user connection requests, authenticating the user, and then returning all configuration information necessary for the client to deliver service to the user.

The key points for RADIUS authentication are:

- Transactions between client and server are authenticated through the use of a shared key and this key is never sent over the network.
- The password is encrypted before sending it over the network.

Note: As part of Radius Client, OcNOS supports authentication and accounting via Radius Server. Authorization is not supported.

### RADIUS Server Authentication

#### IPv4 Address

Radius server address is configured as IPv4 address.

#### Topology



Figure 20-36: RADIUS Server Host Configuration

#### Host

#configure terminal	Enter configure mode.
(config)#radius-server login key testing101 vrf management	Specify the global key for radius servers that are not configured with their respective keys for management vrf. This key should match the one present in the config file of tacacs server.

<pre>(config)#radius-server login key testing101</pre>	Specify the global key for radius servers that are not configured with their respective keys for default vrf. This key should match the one present in the config file of tacacs server
<pre>(config)#radius-server login host 10.12.17.13 vrf management seq-num 1 key testing123</pre>	Specify the radius server ipv4 address to be configured with shared local key for management vrf. The same key should be present on the server config file.
<pre>(config)#radius-server login host 10.12.17.13 seq-num 2 key testing123</pre>	Specify the radius server ipv4 address to be configured with shared local key for default vrf. The same key should be present on the server config file.
<pre>(config)#radius-server login host 10.12.17.11 vrf management seq-num 1 auth- port 1045</pre>	Specify the radius server ipv4 address to be configured with port number for management vrf. The radius server should be started with same port number.
<pre>(config)#radius-server login host 10.12.17.11 seq-num 1 auth-port 1045</pre>	Specify the radius server ipv4 address to be configured with port number for default vrf. The radius server should be started with same port number
<pre>(config)#radius-server login host 10.12.17.11 vrf management seq-num 1 key 7 wawyanb123 auth-port 60000 acct-port 60000 timeout 6</pre>	Specify the radius server ipv4 address to be configured with authentication port number, accounting port number, shared key for management vrf. The radius server should be started with same port number.
<pre>(config)#radius-server login host 10.12.17.11 seq-num 1 key 7 wawyanb123 auth-port 60000 acct-port 60000 timeout 6</pre>	Specify the radius server ipv4 address to be configured with authentication port number, accounting port number, shared key for default vrf. The radius server should be started with same port number. The radius server should be started with same port number
<pre>(config)#radius-server login host Radius- Server-1 vrf management seq-num 2 key 7 wawyanb123 auth-port 60000 acct-port 60000 timeout 2</pre>	Specify the radius server configured with hostname, key authentication port number, accounting port number, for management VRF. The radius server should be started with same port number
<pre>(config)#radius-server login host Radius- Server-1 seq-num 2 key 7 wawyanb123 auth- port 60000 acct-port 60000 timeout 2</pre>	Specify the radius server configured with hostname sequence number, key and port number for default VRF. The radius server should be started with same port number.
<pre>(config)#aaa authentication login default vrf management group radius</pre>	Enable authentication for radius server configured for management VRF. Authorization is also enabled by default
<pre>(config)#aaa authentication login default group radius</pre>	Enable authentication for radius server configured for default vrf. Authorization is also enabled by default.
<pre>(config)#aaa authentication login default vrf management group radius local</pre>	Enable authentication for radius server and fallback to local configured for management VRF. Authorization is also enabled by default
<pre>(config)#aaa authentication login default group radius local</pre>	Enable authentication for radius server and fallback to local configured for default vrf. Authorization is also enabled by default
<pre>(config)#aaa authentication login default vrf management group radius local none</pre>	Enable authentication for radius server, fallback to local followed by fallback to none, configured for management VRF. Authorization is also enabled by default
<pre>(config)#aaa authentication login default radius local none</pre>	Enable authentication for radius server, fallback to local followed by fallback to none, configured for default vrf. Authorization is also enabled by default
<pre>(config)#aaa authentication login default vrf management group radius none</pre>	Enable authentication for radius, fallback to none, configured for management VRF. Authorization is also enabled by default
<pre>(config)#aaa authentication login default group radius none</pre>	Enable authentication for radius, fallback to none, configured for default VRF. Authorization is also enabled by default



(config)#aaa group server radius G1 vrf management	Create aaa radius group G1 for management vrf
(config)#aaa group server radius G1	Create AAA radius group G1 for default VRF
(config-radius)#server 10.12.17.11	Make the radius server 10.12.30.86 a part of this group G1 for default VRF
(config-radius)#server Radius-Server-1	Make Radius-Server-1 a part of this group G1
(config-radius)#exit	Exit radius mode
(config)#commit	Commit the configuration
(config)#aaa group server radius G1	Enter radius mode
(config-radius)#server 10.12.17.11	Make the radius server 10.12.30.86 a part of this group G1 for default vrf
(config-radius)#server Radius-Server-1	Make Radius-Server-1 a part of this group G1
(config-radius)#exit	Exit radius mode.
(config)#commit	Commit the configuration
(config)#aaa authentication login default vrf management group G1	Authenticate the tacacs+ group G1 with aaa authentication for management vrf
(config)#aaa authentication login default group G1	Authenticate the tacacs+ group G1 with aaa authentication for default vrf
(config)#commit	Commit the configuration

## Validation

To verify the RADIUS authentication process, use SSH or Telnet from the host machine to Host IP with the authenticating user created, and provide a RADIUS server password and check whether the client validates the user with the corresponding username and password.

```
#show radius-server vrf management
      VRF: management
timeout value: 5
```

Total number of servers:2

Following RADIUS servers are configured:

```
Radius Server          : 10.12.17.13
  Sequence Number      : 1
  available for authentication on port : 60000
  available for accounting on port     : 60000
  timeout              : 2
  RADIUS shared secret : *****
  Failed Authentication count          : 0
  Successful Authentication count      : 2
  Failed Connection Request           : 2
  Last Successful authentication      : 2000 January 05, 20:55:44
Radius Server          : 10.12.17.11 (*)
  Sequence Number      : 2
  available for authentication on port : 60000
  available for accounting on port     : 60000
  timeout              : 2
  RADIUS shared secret : *****
  Failed Authentication count          : 1
  Successful Authentication count      : 1
  Failed Connection Request           : 0
  Last Successful authentication      : 2000 January 05, 20:58:33
```

```
#show radius-server
    VRF: default
timeout value: 5
```

Total number of servers:4

Following RADIUS servers are configured:

```
Radius Server          : 192.168.1.1
  Sequence Number      : 1
  available for authentication on port : 60000
  available for accounting on port    : 60000
  timeout              : 2
  RADIUS shared secret : *****
  Failed Authentication count         : 0
  Successful Authentication count     : 1
  Failed Connection Request          : 2
  Last Successful authentication     : 2000 January 05, 20:45:09
```

```
Radius Server          : 100.0.0.1 (*)
  Sequence Number      : 2
  available for authentication on port : 60000
  available for accounting on port    : 60000
  timeout              : 2
```

```
Radius Server          : 100.0.0.1 (*)
  Sequence Number      : 2
  available for authentication on port : 60000
  available for accounting on port    : 60000
  timeout              : 2
  RADIUS shared secret : *****
  Failed Authentication count         : 1
  Successful Authentication count     : 1
  Failed Connection Request          : 0
  Last Successful authentication     : 2000 January 05, 20:46:36
```

```
#show radius-server vrf management
    VRF: management
timeout value: 5
```

Total number of servers:2

Following RADIUS servers are configured:

```
Radius Server          : 10.12.17.13
  Sequence Number      : 1
  available for authentication on port : 60000
  available for accounting on port    : 60000
  timeout              : 2
  RADIUS shared secret : *****
  Failed Authentication count         : 0
  Successful Authentication count     : 2
  Failed Connection Request          : 2
  Last Successful authentication     : 2000 January 05, 20:55:44
```

```
Radius Server          : 10.12.17.11 (*)
  Sequence Number      : 2
  available for authentication on port : 60000
  available for accounting on port    : 60000
```

---

```
timeout : 2
RADIUS shared secret : *****
Failed Authentication count : 1
Successful Authentication count : 1
Failed Connection Request : 0
Last Successful authentication : 2000 January 05, 20:58:33
```

```
#show radius-server
    VRF: default
timeout value: 5
```

```
Total number of servers:4
```

```
Following RADIUS servers are configured:
```

```
Radius Server : 192.168.1.1
  Sequence Number : 1
  available for authentication on port : 60000
  available for accounting on port : 60000
  timeout : 2
  RADIUS shared secret : *****
  Failed Authentication count : 0
  Successful Authentication count : 1
  Failed Connection Request : 2
  Last Successful authentication : 2000 January 05, 20:45:09
```

```
Radius Server : 100.0.0.1 (*)
  Sequence Number : 2
  available for authentication on port : 60000
  available for accounting on port : 60000
  timeout : 2
```

```
Radius Server : 100.0.0.1 (*)
  Sequence Number : 2
  available for authentication on port : 60000
  available for accounting on port : 60000
  timeout : 2
  RADIUS shared secret : *****
  Failed Authentication count : 1
  Successful Authentication count : 1
  Failed Connection Request : 0
  Last Successful authentication : 2000 January 05, 20:46:36
```

```
#show radius-server vrf all
    VRF: management
timeout value: 5
```

```
Total number of servers:2
```

```
Following RADIUS servers are configured:
```

```
Radius Server : 10.12.17.13
  Sequence Number : 1
  available for authentication on port : 60000
  available for accounting on port : 60000
  timeout : 2
  RADIUS shared secret : *****
  Failed Authentication count : 0
  Successful Authentication count : 2
```

```
Failed Connection Request      : 2
Last Successful authentication : 2000 January 05, 20:55:44
Radius Server                  : 10.12.17.11 (*)
Sequence Number                : 2
available for authentication on port : 60000
available for accounting on port   : 60000
timeout                        : 2
RADIUS shared secret           : *****
Failed Authentication count      : 1
Successful Authentication count  : 1
Failed Connection Request       : 0
Last Successful authentication   : 2000 January 05, 20:58:33
```

```
VRF: default
timeout value: 5
```

Total number of servers:4

Following RADIUS servers are configured:

```
Radius Server                  : 192.168.1.1
Sequence Number                : 1
available for authentication on port : 60000
available for accounting on port   : 60000
timeout                        : 2
RADIUS shared secret           : *****
Failed Authentication count      : 0
Successful Authentication count  : 1
Failed Connection Request       : 2
Last Successful authentication   : 2000 January 05, 20:45:09
```

```
Radius Server                  : 100.0.0.1 (*)
Sequence Number                : 2
available for authentication on port : 60000
available for accounting on port   : 60000
timeout                        : 2
RADIUS shared secret           : *****
Failed Authentication count      : 1
Successful Authentication count  : 1
Failed Connection Request       : 0
Last Successful authentication   : 2000 January 05, 20:46:36
```

```
#show running-config radius
radius-server login key 7 0x6f32ba3f9e05a3db vrf management
radius-server login host 10.12.17.13 vrf management seq-num 1 key 7
0x67efdb4ad9d771c3ed8312b2bc74cedb
```

```
#show running-config aaa
aaa authentication login default vrf management group radius
aaa group server radius rad1 vrf management
server Radius-Server-1 vrf management
server 100.0.0.1 vrf management
```

```
aaa authentication login default group radius
aaa group server radius rad1
server Radius-Server-1
server 100.0.0.1
```

```
#show running-config aaa all
aaa authentication login default vrf management group radius
aaa authentication login console local
aaa accounting default vrf management local
no aaa authentication login default fallback error local vrf management
no aaa authentication login console fallback error local
no aaa authentication login error-enable vrf management
aaa local authentication attempts max-fail 3
aaa local authentication unlock-timeout 1200
aaa group server radius rad1 vrf management
server Radius-Server-1 vrf management
server 100.0.0.1 vrf management

aaa authentication login default group radius
aaa authentication login console local
aaa accounting default local
no aaa authentication login default fallback error local
no aaa authentication login console fallback error local
no aaa authentication login error-enable
aaa local authentication attempts max-fail 3
aaa local authentication unlock-timeout 1200
aaa group server radius rad1
server Radius-Server-1
server 100.0.0.1
```

---

## IPv6 Address

Radius server address is configured as IPv6 address. Authentication messages are transmitted to radius server from the Router using IPv6 address.

## Topology

Figure 20-37 shows the sample configuration of Radius server.



Figure 20-37: RADIUS topology

## R1

#configure terminal	Enter configure mode.
(config)#radius-server login host 2001:db8:100::2 vrf management seq-num 1 key 0 testing123	Configure radius server with IPv6 address
(config)#aaa authentication login default vrf management group radius	Configure AAA authentication
(config)#aaa authentication login error-enable vrf management	Configure AAA authentication login error-enable
(config)#interface eth0	Navigate to the interface mode
(config-if)#ipv6 address 2001:db8:100::5/64	Configure IPv6 address on the eth0 interface
(config-if)#exit	Exit interface configure mode
(config)#commit	Commit the configuration
(config)#exit	Exit configure mode

**Validation**

Perform TELNET to the Router R1. Provide the username mentioned in the radius server "users" file as telnet username. Check that R1 sends radius request to the radius server using IPv6 address.

```
#show running-config radius
radius-server login host 2001:db8:100::2 vrf management seq-num 1 key 7
0x67efdb
4ad9d771c3ed8312b2bc74cedb
```

```
#show running-config aaa
aaa authentication login default vrf management group radius
aaa authentication login error-enable vrf management
```

```
#show ipv6 interface eth0 brief
Interface          IPv6-Address          Admin-
Sta
tus
eth0                2001:db8:100::5
                    fe80::218:23ff:fe30:e6ba          [up/up]
```

## RADIUS Server Accounting

You can configure accounting to measure the resources that another user consumes during access.

**User**

#configure terminal	Enter configure mode.
(config)#radius-server login host 10.12.17.11 vrf management key 7 seq-num 1 wawayanb123 auth-port 60000 acct-port 60000 timeout 6	Specify the radius server ipv4 address to be configured with authentication port number, accounting port number, shared key for management vrf. The radius server should be started with same port number.

(config)#radius-server login host 10.12.17.11 seq-num 2 key 7 wawyanb123 auth-port 60000 acct-port 60000 timeout 6	Specify the radius server ipv4 address to be configured with port number for default vrf. The radius server should be started with same port number
(config)#aaa accounting default vrf management group radius	Enable accounting for radius server configured for vrf management
(config)#aaa accounting default group radius	Enable accounting for radius server configured for default vrf
(config)#commit	Commit the candidate configuration to the running configuration

---

## Validation

```
#show aaa accounting vrf management
      VRF: management
      default: group radius

#show aaa accounting vrf all
      VRF: management
      default: group radius

      VRF: default
      default: group radius

#show aaa accounting
      VRF: default
      default: group radius
#
#show running-config aaa
aaa authentication login default vrf management group radius
aaa accounting default vrf management group radius
aaa group server radius rad1 vrf management
    server Radius-Server-1 vrf management
    server 100.0.0.1 vrf management

aaa authentication login default group radius
aaa accounting default group radius
aaa group server radius rad1
    server Radius-Server-1
    server 100.0.0.1
```

---

## Sample Radius Clients.conf File

```
client 10.12.58.20 {
    secret    = testing123
    shortname = localhost
}
client 192.168.1.2 {
    secret    = testing123
    shortname = localhost
}
```

```
client 10.12.37.196 {
    secret      = testing123
}
client 100.0.0.2 {
    secret      = testing123
    shortname   = localhost
}

# IPv6 Client
#client ::1 {
#    secret      = testing123
#    shortname   = localhost
#}
#
# All IPv6 Site-local clients
#client fe80::/16 {
#    secret      = testing123
#    shortname   = localhost
```

---

## Sample Radius Users Configuration File

```
#
#DEFAULT
#    Service-Type = Login-User,
#    Login-Service = Rlogin,
#    Login-IP-Host = shellbox.ispdomain.com

# #
# # Last default: shell on the local terminal server.
# #
# DEFAULT
#    Service-Type = Administrative-User

# On no match, the user is denied access.

selftest Cleartext-Password := "password"
testuser1 Cleartext-Password := "user1@101"
testuser2 Cleartext-Password := "user2@202"
testuser3 Cleartext-Password := "user3@303"
```



## CHAPTER 21 Simple Network Management Protocol

### Overview

SNMP provides a standardized framework and a common language for monitoring and managing devices in a network. The SNMP framework consists of three parts:

- An SNMP manager: The system used to control and monitor the activities of network devices. This is sometimes called a Network Management System (NMS).
- An SNMP agent: The component within a managed device that maintains the data for the device and reports these data SNMP managers.
- Management Information Base (MIB): SNMP exposes management data in the form of variables which describe the system configuration. These variables can be queried by SNMP managers.

In SNMP, administration groups are known as communities. SNMP communities consist of one agent and one or more SNMP managers. You can assign groups of hosts to SNMP communities for limited security checking of agents and management systems or for administrative purposes. Defining communities provides security by allowing only management systems and agents within the same community to communicate.

A host can belong to multiple communities at the same time, but an agent does not accept a request from a management system outside its list of acceptable community names.

SNMP access rights are organized by groups. Each group is defined with three accesses: read access, write access, and notification access. Each access can be enabled or disabled within each group.

The SNMP v3 security level determines if an SNMP message needs to be protected from disclosure and if the message needs to be authenticated. The security levels are:

- noAuthNoPriv: No authentication or encryption
- authNoPriv: Authentication but no encryption
- authPriv: Both authentication and encryption

SNMP is defined in RFCs 3411-3418.

### Topology

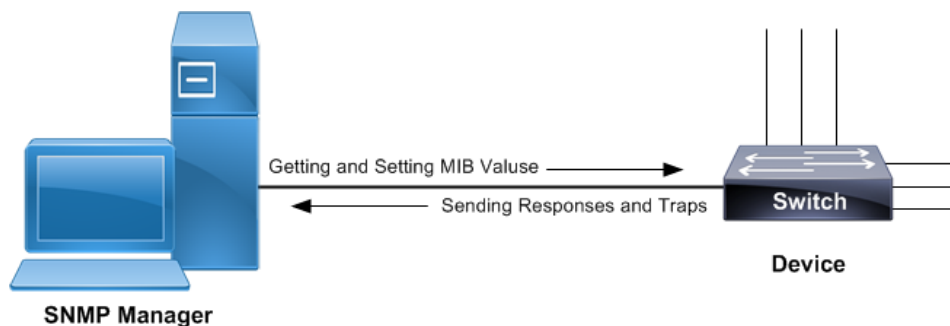

Figure 21-38: SNMP sample topology

---

## Standard SNMP Configurations

#configure terminal	Enter configure mode.
(config)#snmp-server view all .1 included vrf management	Creates SNMP view labeled as "all" for OID-Tree as ".1" for vrf management.
(config)#snmp-server community test group network-operator vrf management	Set community string as "test" for group of users having "network-operator" privilege.
(config)#snmp-server host 10.12.6.63 traps version 2c test udp-port 162 vrf management	Specify host "10.12.6.63" to receive SNMP version 2 notifications at udp port number 162 with community string as "test".
(config)#snmp-server enable snmp vrf management	Use this command to start the SNMP agent.
(config)#commit	Commit the candidate configuration to the running configuration
(config)#exit	Exit configure mode.

---

## Validation

Use the below commands to verify the SNMP configuration:

```
#show running-config snmp
snmp-server view all .1 included vrf management
snmp-server community test group network-operator vrf management
snmp-server host 10.12.6.63 traps version 2c test udp-port 162 vrf management

#show snmp group
-----
community/user      group          version  Read-View  Write-view  Notify-view
-----
test                network-operator  2c/1    all        none        all

#show snmp host
-----
Host                Port  Version  Level      Type      SecName
-----
10.12.6.63         162   2c       noauth    trap      test
```

---

## SNMP GET Command

```
# snmpget -v2c -c test 10.12.45.238
.1.3.6.1.2.1.6.13.1.2.10.12.45.238.22.10.12.6.63.52214

TCP-MIB::tcpConnLocalAddress.10.12.45.238.22.10.12.6.63.52214 = IPAddress:
10.12.45.238
```

---

## SNMP WALK Command

### SNMP WALK for particular OID

```
#snmpwalk -v2c -c test 10.12.45.238 .1.3.6.1.2.1.25.3.8.1.8
HOST-RESOURCES-MIB::hrFSLastFullBackupDate.1 = STRING: 0-1-1,0:0:0.0
HOST-RESOURCES-MIB::hrFSLastFullBackupDate.4 = STRING: 0-1-1,0:0:0.0
```

```

HOST-RESOURCES-MIB::hrFSLastFullBackupDate.5 = STRING: 0-1-1,0:0:0.0
HOST-RESOURCES-MIB::hrFSLastFullBackupDate.6 = STRING: 0-1-1,0:0:0.0
HOST-RESOURCES-MIB::hrFSLastFullBackupDate.10 = STRING: 0-1-1,0:0:0.0
HOST-RESOURCES-MIB::hrFSLastFullBackupDate.12 = STRING: 0-1-1,0:0:0.0
HOST-RESOURCES-MIB::hrFSLastFullBackupDate.13 = STRING: 0-1-1,0:0:0.0
HOST-RESOURCES-MIB::hrFSLastFullBackupDate.14 = STRING: 0-1-1,0:0:0.0
HOST-RESOURCES-MIB::hrFSLastFullBackupDate.15 = STRING: 0-1-1,0:0:0.0
HOST-RESOURCES-MIB::hrFSLastFullBackupDate.16 = STRING: 0-1-1,0:0:0.0
HOST-RESOURCES-MIB::hrFSLastFullBackupDate.17 = STRING: 0-1-1,0:0:0.0
HOST-RESOURCES-MIB::hrFSLastFullBackupDate.18 = STRING: 0-1-1,0:0:0.0
HOST-RESOURCES-MIB::hrFSLastFullBackupDate.19 = STRING: 0-1-1,0:0:0.0
HOST-RESOURCES-MIB::hrFSLastFullBackupDate.20 = STRING: 0-1-1,0:0:0.0
HOST-RESOURCES-MIB::hrFSLastFullBackupDate.21 = STRING: 0-1-1,0:0:0.0
HOST-RESOURCES-MIB::hrFSLastFullBackupDate.22 = STRING: 0-1-1,0:0:0.0
HOST-RESOURCES-MIB::hrFSLastFullBackupDate.23 = STRING: 0-1-1,0:0:0.0
HOST-RESOURCES-MIB::hrFSLastFullBackupDate.24 = STRING: 0-1-1,0:0:0.0
HOST-RESOURCES-MIB::hrFSLastFullBackupDate.25 = STRING: 0-1-1,0:0:0.0
HOST-RESOURCES-MIB::hrFSLastFullBackupDate.26 = STRING: 0-1-1,0:0:0.0

```

## Complete SNMP WALK

```
#snmpwalk -v2c -c test 10.12.45.238 .1
```

## SNMP Trap Server Configuration with IPv6 Address

Snmpwalk is performed by using IPv6 address. SNMP trap server is configured on the Router with IPv6 address.

### Topology

Figure 21-39 shows the sample configuration of SNMP trap server.

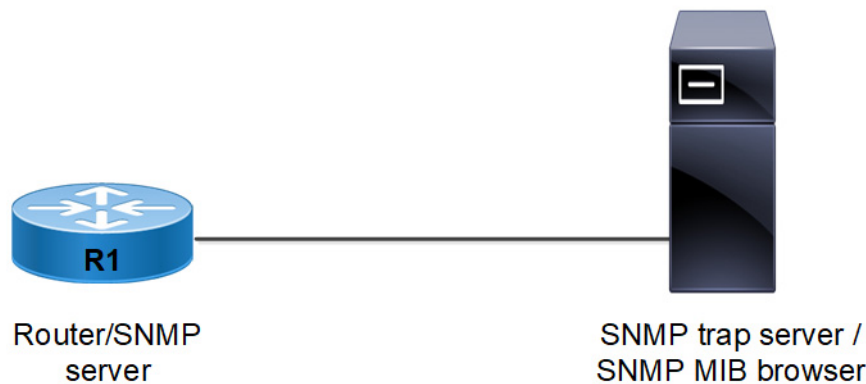

Figure 21-39: SNMP trap server topology

R1

#configure terminal	Enter configure mode.
(config)#snmp-server view all .1 included vrf management	Configure SNMP server view
(config)#snmp-server view test1 1.3.6.1 included vrf management	Configure SNMP server view

(config)#snmp-server user test1 network-admin auth md5 test1234 vrf management	Configure SNMP server user
(config)#snmp-server user test2 network-admin vrf management	Configure SNMP server user
(config)#snmp-server user test3 network-admin auth md5 test1234 priv des test1234 vrf management	Configure SNMP server user
(config)#snmp-server community test group network-operator vrf management	Configure SNMP server community
(config)#snmp-server community test1 group network-admin vrf management	Configure SNMP server community
(config)#snmp-server host 2001:db8:100::2 traps version 2c test udp-port 162 vrf management	Configure SNMP trap server
(config)#interface eth0	Navigate to the interface mode
(config-if)#ipv6 address 2001:db8:100::5/64	Configure IPv6 address on the eth0 interface
(config-if)#exit	Exit interface configure mode
(config)#commit	Commit the candidate configuration to the running configuration
(config)#exit	Exit configure mode

## Validation

Below is the SNMP configuration in Router node:

```
#show running-config snmp
snmp-server view all .1 included vrf management
snmp-server user test1 network-admin auth MD5 encrypt 0xd1fe6acc88856c90 vrf management
snmp-server user test2 network-admin vrf management
snmp-server user test3 network-admin auth MD5 encrypt 0xd1fe6acc88856c90 priv DES 0xd1fe6acc88856c90 vrf management
snmp-server community test group network-operator vrf management
snmp-server community test1 group network-admin vrf management
snmp-server enable snmp vrf management
snmp-server enable traps link linkDown
snmp-server enable traps link linkUp
```

```
#show ipv6 interface eth0 brief
Interface          IPv6-Address          Admin-Status
-----          -
eth0              2001:db8:100::5      [up/up]
                  fe80::218:23ff:fe30:e6ba
```

Perform snmpwalk as mentioned below with IPv6 address using SNMPv3

```
snmpwalk -v3 -u test3 -a MD5 -A test1234 -x DES -X test1234 -l authPriv 2001:db8:100::5
.1.3.6.1.2.1.25.3.8.1.8
```

Perform snmpwalk as mentioned below with IPv6 address using SNMPv2

---

```
snmpwalk -v2c -c test 2001:db8:100::5 1.3.6.1.2.1.31
```

Perform snmpwalk as mentioned below with IPv6 address using SNMPv1

```
snmpwalk -v1 -c test 2001:db8:100::5 1.3.6.1.2.1.31
```

```
#show snmp trap
```

```
-----  
Trap type      Description      Enabled  
-----  
link           linkUp          yes  
link           linkDown       yes  
vxlan          notification    no  
mpls           notification    no  
mpls           pw              no  
mpls           pw delete      no  
mpls-l3vpn     notification    no  
ospf           notification    no  
ospf6          notification    no  
isis           notification    no  
snmp           authentication  no  
mpls           rsvp           no  
vrrp           notification    no  
bgp            notification    no
```

As mentioned above, perform link down and link up of any interface in Router node. Check that SNMP trap is sent using IPv6 address.



## CHAPTER 22 Access Control Lists Configurations

This chapter contains a complete example of access control list (ACL) configuration.

### Overview

An Access Control List is a list of Access Control Entries (ACE). Each ACE in ACL specifies the access rights allowed or denied.

Each packet that arrives at the device is compared to each ACE in each ACL in the order they are defined. The device continues to look until it has a match. If no match is found and the device reaches the end of the list, the packet is denied. For this reason, place the most frequently occurring specifications at the top of the list.

The device stops checking the specifications after a match occurs.

**Note:** If there is no match, the packet is dropped (implicit deny). Therefore, an ACL intended to deny a few selected packets should have at least one permit filter of lower priority; otherwise, all traffic is dropped because of the default implicit deny filter.

### Topology

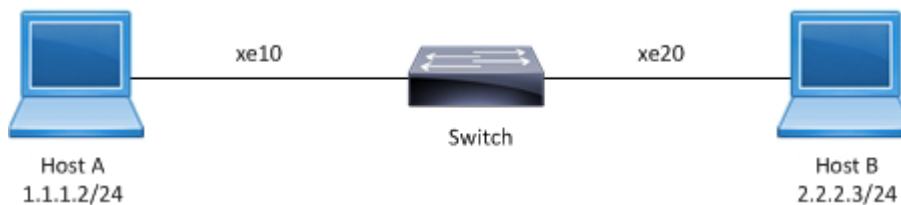

Figure 22-40: ACL sample topology

### IPv4 ACL Configuration

#configure terminal	Enter configure mode.
(config)#ip access-list T1	Create an IP access list named T1.
(config-ip-acl)#deny any host 1.1.1.1 any	Create an access rule to deny IP packets with source address 1.1.1.1.
(config-ip-acl)#permit any host 1.1.1.2 any	Create an access rule to permit IP packets with source address 1.1.1.2.
(config-ip-acl)#exit	Exit access list mode.
(config)#hardware-profile filter ingress-ipv4 enable	Enable hardware profile for the ACL.
(config)#commit	Commit the candidate configuration to the running configuration
(config)#interface xe10	Enter interface mode.
(config-if)#no switchport	Configure the interface as Layer 3.
(config-if)#ip address 1.1.1.3/24	Assign an IP address.
(config-if)#ip access-group T1 in	Apply access group T1 for inbound traffic to the interface.

---

(config-if)#commit	Commit the candidate configuration to the running configuration
(config-if)#end	Exit interface and configure mode.

---

### Validation

Use the commands below to verify the match count. When inbound IP packets reach interface xe10 with source address 1.1.1.1, then the match count for access rule 10 increases equal to the number of packets sent.

```
#show ip access-lists T1
IP access list T1
  10 deny any host 1.1.1.1 any [match=200]
  20 permit any 1.1.1.2 any
  default deny-all
```

When inbound IP packets reach interface xe10 with a source address 1.1.1.2, then the match count for access rule 20 increases equal to the number of packets sent.

```
#show ip access-lists T1
IP access list T1
  10 deny any host 1.1.1.1 any
  20 permit any 1.1.1.2 any [match=2000]
  default deny-all
```

**Note:** Use the command `clear ip access-list counters` to clear the statistics of all ACLs or `clear ip access-list <access-list name> counters` to clear statistics of a particular ACL.

---

## ICMP ACL Configuration

#configure terminal	Enter configure mode.
(config)#ip access-list icmp-acl-01	Create an IP access list named icmp-acl-01.
(config-ip-acl)#10 deny icmp 1.1.1.2/24 2.2.2.2/24 dscp af11	Create an access rule with sequence number 10 to deny ICMP packets from a specific source towards a specific destination with a DSCP value of af11. Note: The sequence number is optional.
(config-ip-acl)#20 permit icmp 1.1.1.1/24 2.2.2.2/24 precedence flash	Create an access rule with sequence number 20 to permit ICMP packets from a specific source towards a specific destination with precedence as flash.
(config-ip-acl)#exit	Exit access list mode.
(config)#commit	Commit the candidate configuration to the running configuration
(config)#interface xe10	Enter interface mode.
(config-if)#no switchport	Configure the interface as Layer 3.
(config-if)#ip address 1.1.1.3/24	Assign an IP address.
(config-if)#ip access-group icmp-acl-01 in	Apply access group icmp-acl-01 for inbound traffic to the interface.
(config-if)#commit	Commit the candidate configuration to the running configuration
(config-if)#end	Exit interface and configure mode.

---



---

## Validation

Use the commands below to verify the match count. When inbound IP packets reach interface xe10 with source address 1.1.1.X, destination address 2.2.2.X, DSCP value af11, and are fragmented, then the count for access rule 10 increases equal to the number of packets sent.

```
#show ip access-lists icmp-acl-01
IP access-list icmp-acl-01
 10 deny icmp 1.1.1.2/24 2.2.2.2/24 dscp af11 [match=200]
 20 permit icmp 1.1.1.1/24 2.2.2.2/24 precedence flash
 default deny-all
```

When inbound IP packets reach interface xe10 with source address as 1.1.1.X, destination address 2.2.2.X, and precedence value flash, then the count for access rule 20 increases equal to the number of packets sent.

```
#show ip access-lists icmp-acl-01
IP access-list icmp-acl-01
 10 deny icmp 1.1.1.2/24 2.2.2.2/24 dscp af11
 20 permit icmp 1.1.1.1/24 2.2.2.2/24 precedence flash [match=200]
 default deny-all
```

**Note:** Use the command `clear ip access-list counters` to clear statistics of all ACLs configured or `clear ip access-list <access-list name> counters` to clear statistics of a particular ACL.

---

## Access List Entry Sequence Numbering

You can change the sequence numbers of rules in an access list.

**Note:** Re-sequencing an ACL attached to a management interface clears the ACL counters associated to it.

#configure terminal	Enter configure mode.
(config)#ip access-list icmp-acl-01	Enter access list mode for ACL icmp-acl-01.
(config-ip-acl)#resequence 100 200	Re-sequence the access list, starting with sequence number 100 and incrementing by 200.
(config-ip-acl)#1000 deny icmp 1.1.1.2/24 2.2.2.2/24 dscp af11	Re-sequencing specific access rule 100 with sequence number 1000
(config-ip-acl)#exit	Exit access list mode.
(config)#commit	Commit the candidate configuration to the running configuration

---

## Validation

Before re-sequencing:

```
#show access-lists icmp-acl-01
IP access list icmp-acl-01
 10 deny icmp 1.1.1.2/24 2.2.2.2/24 dscp af11 log
 20 permit icmp 1.1.1.1/24 2.2.2.2/24 precedence flash
 default deny-all
```

After re-sequencing the access list, starting with sequence number 100 and incrementing by 200

```
#show access-lists icmp-acl-01
IP access list icmp-acl-01
 100 deny icmp 1.1.1.2/24 2.2.2.2/24 dscp af11 log
 300 permit icmp 1.1.1.1/24 2.2.2.2/24 precedence flash
```

```
default deny-all
```

After re-sequencing specific access rule 100 with sequence number 1000

```
#show access-lists icmp-acl-01
IP access list icmp-acl-01
300 permit icmp 1.1.1.1/24 2.2.2.2/24 precedence flash
1000 deny icmp 1.1.1.2/24 2.2.2.2/24 dscp af11 log
default deny-all
```

---

## IPv6 ACL Configuration

#configure terminal	Enter configure mode.
(config)#ipv6 access-list ipv6-acl-01	Create an IPv6 access list named as icmp-acl-01.
(config-ipv6-acl)#11 deny ipipv6 any any	Create access rule sequence number 11 to deny IPv4 encapsulated packets in IPv6 with any source address to any destination address.
(config-ipv6-acl)#default permit-all	Update the default rule to permit all.
(config-ipv6-acl)#exit	Exit access list mode
(config)#commit	Commit the candidate configuration to the running configuration
(config)#interface xe10	Enter interface mode.
(config-if)#no switchport	Configure the interface as Layer 3.
(config-if)#ipv6 address 1::1:3/64	Assign an IPv6 address.
(config-if)#ipv6 access-group ipv6-acl-01 in	Apply access group ipv6-acl-01 for inbound traffic to the interface.
(config-if)#commit	Commit the candidate configuration to the running configuration
(config-if)#end	Exit interface and configure mode.

---

## Validation

Use the commands below to verify the match count. When inbound IPv6 packets reach interface xe10 with IPv4, then count for access rule 11 increases equal to the number of packets sent.

```
#show ipv6 access-lists ipv6-acl-01
IPv6 access-list ipv6-acl-01
 11 deny ipipv6 any any [match=1000]
default permit all
```

For all other IPv6 packets, access rule 100 is invoked and the match counts increase equal to the number of packets sent.

```
#show ipv6 access-lists ipv6-acl-01
IPv6 access-list ipv6-acl-01
 11 deny ipipv6 any any
default permit-all [match=2000]
```

**Note:** Use the command `clear ipv6 access-list counters` to clear statistics of all IPv6 ACLs configured or `clear ipv6 access-list <ipv6 access-list name> counters` to clear statistics of the particular IPv6 ACL.

## IPv6 ACL Configuration for 128-Bit Support

### Configuration for Physical, PO, SA and MLAG Interfaces

Enable hardware-profile ingress-ipv6-ext:

(config)#hardware-profile filter ingress-ipv6-ext enable	Enable ingress IPv6 group for 128-bit address qualification on physical interfaces.
(config)#commit	Commit the candidate configuration to the running configuration.
(config)#ipv6 access-list test1	Create an IPv6 access list named test1.
(config-ipv6-acl)#permit any 2001::1/128 2002::1/128	Create an access rule to permit any IPv6 packet from 2001::1/128 to 2002::1/128.
(config-ipv6-acl)#commit	Commit the candidate configuration to the running configuration.
(config)#interface xe1	Enter interface mode.
(config-if)#ipv6 access-group test1 in	Attach IPv6 access list test1 to the interface.
(config-if)#commit	Commit the candidate configuration to the running configuration.

### Validation

Use the commands below to verify the hardware-profile configurations.

```
#show hardware-profile filters
```

Note: Shared count is the calculated number from available resources.

Dedicated count provides allocated resource to the group.

If group shares the dedicated resource with other groups, then dedicated count of group will reduce with every resource usage by other groups.

```
+-----+-----+-----+-----+
|          | Free   | Used   |          Total Entries          |
| Unit - TCAMS | Entries | %   | Entries | Total | Dedicated | shared |
+-----+-----+-----+-----+
0 INGRESS IPV6-ACL-EXT      1280      0      0      1280      0      1280
```

```
#
```

Use the commands below to verify the running configurations.

```
#show running-config ipv6 access-list
ipv6 access-list test1
 10 permit any 2001::1/128 2002::1/128
!
#show running-config interface xe1
!
interface xe1
  ipv6 access-group test1 in
!
```

#

Use the commands below to verify the match count.

```
#show ipv6 access-lists test1
IPv6 access list test1
    10 permit any 2001::1/128 2002::1/128 [match=1000]
    268435453 permit icmpv6 any any
    default deny-all
```

#

**Note:** Use the command `clear ipv6 access-list counters` to clear statistics of all IPv6 ACLs configured or `clear ipv6 access-list NAME counters` to clear statistics of the particular IPv6 ACL.

## Configuration for VLAN Interfaces and L3 Subinterfaces

Enable hardware-profile ingress-ipv6-ext-vlan.

(config)#hardware-profile filter ingress-ipv6-ext-vlan enable	Enable ingress IPv6 group for 128-bit address qualification on VLAN interfaces and subinterfaces.
(config)#commit	Commit the candidate configuration to the running configuration.
(config)#interface vlan1.20	Enter interface mode.
(config-if)#ipv6 access-group test1 in	Attach IPv6 access list test1 to the interface.
(config-if)#commit	Commit the candidate configuration to the running configuration.
(config)#interface xe1.2	Enter interface mode.
(config-if)#ipv6 access-group test1 in	Attach IPv6 access list test1 to the interface.
(config-if)#commit	Commit the candidate configuration to the running configuration.

## Validation

Use the commands below to verify the hardware-profile configurations.

```
#show hardware-profile filters
```

**Note:** Shared count is the calculated number from available resources.

Dedicated count provides allocated resource to the group.

If group shares the dedicated resource with other groups, then dedicated count of group will reduce with every resource usage by other groups.

```
+-----+-----+-----+-----+
|          | Free   |      Used      |          Total Entries          | | |
| Unit - TCAMS | Entries |-----|-----|
|          |      % | Entries | Total | Dedicated | shared |
+-----+-----+-----+-----+
0 INGRESS IPV6-ACL-EXT-VLAN 1280      0      0          1280      0          1280
```

Use the commands below to verify the running configurations.

```
#show running-config ipv6 access-list
ipv6 access-list test1
    10 permit any 2004::1/128 2005::1/128
!
```

```
#show running-config interface vlan1.20
!
interface vlan1.20
  ipv6 access-group test1 in
#
```

```
#show running-config interface xe1.2
interface xe1.2
  ipv6 access-group test1 in
!
```

Use the commands below to verify the match count.

```
#show ipv6 access-lists test1
IPv6 access list test1
  10 permit any 2004::1/128 2005::1/128 [match=1000]
  268435453 permit icmpv6 any any
  default deny-all
```

**Note:** Use the command `clear ipv6 access-list counters` to clear statistics of all IPv6 ACLs configured or `clear ipv6 access-list NAME counters` to clear statistics of a particular IPv6 ACL.

## MAC ACL Configuration

#configure terminal	Enter configure mode.
(config)#mac access-list mac-acl-01	Create a MAC access list named mac-acl-01.
(config-mac-acl)#22 permit host 0000.0011.1212 host 0000.1100.2222 vlan 2	Create an access rule with sequence number 22 to permit packets from a host with a specific MAC towards a host with a specific MAC with VLAN 2.
(config-mac-acl)#exit	Exit access list mode.
(config)#commit	Commit the candidate configuration to the running configuration
(config)#bridge 1 protocol rstp vlan- bridge	Create a VLAN-aware RSTP bridge.
(config)#vlan 2 bridge 1 state enable	Create VLAN 2.
(config)#interface xe10	Enter interface mode.
(config-if)#switchport	Configure the interface as Layer 2.
(config-if)#bridge-group 1	Associate the interface with bridge group 1.
(config-if)#switchport mode trunk	Set the switching characteristics of this interface to trunk mode.
(config-if)#switchport trunk allowed vlan all	Enable all VLAN identifiers on this interface.
(config-if)#mac access-group mac-acl-01 in	Applies the MAC access list mac-acl-01 to ingress traffic.
(config-if)#commit	Commit the candidate configuration to the running configuration
(config-if)#end	Exit interface and configure mode.

## Validation

Use the commands below to verify the match count. When inbound packets reach interface xe10 with the specific source and destination MAC with the VLAN as 2, then the count for access rule 22 increases equal to the number of packets sent.

```
#show mac access-lists
MAC access list mac-acl-01
  22 permit mac host 0000.0011.1212 host 0000.1100.2222 vlan 2 [match=3000]
  default deny-all
```

For all other packets, default rule is invoked and the match counts increases equal to the number of packets sent.

```
#show mac access-lists mac-acl-01
MAC access list mac-acl-01
  22 permit mac host 0000.0011.1212 host 0000.1100.2222 vlan 2
  default deny-all [match=2000]
```

Note: As per the present design, ARP/ND packets will be filtered based on the source MAC address only (host mac address).

Note: Use the command `clear mac access-list counters` to clear statistics of all MAC ACLs or `clear mac access-list <mac access-list name> counters` to clear statistics of a particular MAC ACL.

## Management ACL Overview

Management Port ACL can be used to provide basic level of security for accessing the management network. ACLs can also be used to decide which types of management traffic to be forwarded or blocked at the management port.

When configuring access list on a router or a switch, each access list needs to be identified by a unique name or a number. Each access list entry can have permit or deny actions. Each entry will be associated with a sequence number in the range of <1-268435453>. Lower the sequence number, higher the priority.

User should be able to configure the system to allow certain IP address for a protocol and don't allow any other IP address matching for that protocol.

Note: If there is no match, the packet is dropped (implicit deny). Therefore, an ACL intended to deny a few selected packets should have at least one permit filter of lower priority; otherwise, all traffic is dropped because of the default implicit deny filter.

## Topology

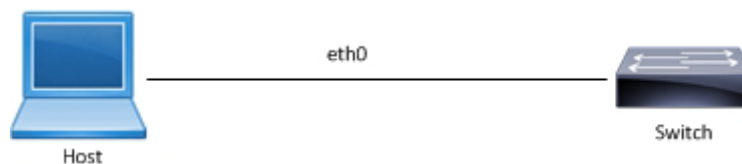

Figure 22-41: Management ACL Sample Topology

## Management ACL Configuration

#configure terminal	Enter configure mode.
(config)#ip access-list mgmt	Create an IP access list named mgmt

(config-ip-acl)#permit tcp host 10.12.45.57 host 10.12.29.49 eq ssh	Create an access rule to permit TCP connection with source address 10.12.45.57 with destination address 10.12.29.49 on destination port equal to SSH.
(config-ip-acl)#permit tcp host 10.12.45.58 host 10.12.29.49 eq telnet	Create an access rule to permit TCP connection with source address 10.12.45.58 with Destination address 10.12.29.49 on destination port equal to Telnet.
(config-ip-acl)#permit udp any host 10.12.29.49 eq snmp	Create an access rule to permit UDP packet with any source address with Destination address 10.12.29.49 on destination port equal to SNMP.
(config-ip-acl)#permit udp any host 10.12.29.49 eq ntp	Create an access rule to permit UDP packet with any source address with Destination address 10.12.29.49 on destination port equal to NTP.
(config-ip-acl)#permit udp host 10.12.29.49 any eq snmptrap	Create an access rule to permit UDP packet with source address 10.12.29.49 with any Destination address on destination port equal to SNMPTrap.
(config-ip-acl)#permit tcp host 10.12.29.49 eq ssh host 10.12.45.57	Create an access rule to permit TCP connection with source address 10.12.29.49 on source port equal to ssh with Destination address 10.12.45.57 .
(config-ip-acl)#deny tcp host 10.12.45.58 host 10.12.29.49 eq ssh	Create an access rule to deny TCP connection with source address 10.12.45.58 with Destination address 10.12.29.49 on destination port equal to SSH.
(config-ip-acl)#deny tcp host 10.12.45.57 host 10.12.29.49 eq telnet	Create an access rule to deny TCP connection with source address 10.12.45.57 with Destination address 10.12.29.49 on destination port equal to Telnet.
(config-ip-acl)#exit	Exit access list mode.
(config)#hardware-profile filter egress-ipv4 enable	Enable hardware profile for the ACL.
(config)#commit	Commit the candidate configuration to the running configuration
(config)#interface eth0	Enter interface mode of Management Interface.
(config-if)#no switchport	Configure the interface as Layer 3.
(config-if)#ip address 10.12.29.49/24	Assign an IP address.
(config-if)#ip access-group mgmt in	Apply access group mgmt for inbound traffic to the interface.
(config-if)#commit	Commit the candidate configuration to the running configuration
(config-if)#end	Exit interface and configure mode.

## Validation

Use the commands below to verify the match count. When a TCP connection for Destination Port SSH reach interface eth0 with source address 10.12.45.57, then the match count for access rule 10 increases equal to the number of packets sent.

```
#show ip access-lists mgmt
  IP access list mgmt
    10 permit tcp host 10.12.45.57 host 10.12.29.49 eq ssh [match=9]
    20 permit tcp host 10.12.45.58 host 10.12.29.49 eq telnet
    30 permit udp any host 10.12.29.49 eq snmp
    40 permit udp any host 10.12.29.49 eq ntp
    50 permit udp host 10.12.29.49 any eq snmptrap
    60 permit tcp host 10.12.29.49 eq ssh host 10.12.45.57
    70 deny tcp host 10.12.45.58 host 10.12.29.49 eq ssh
    80 deny tcp host 10.12.45.57 host 10.12.29.49 eq telnet
  default deny-all
```

When a TCP connection for Destination Port Telnet reach interface eth0 with source address 10.12.45.58, then the match count for access rule 20 increases equal to the number of packets sent.

```
#show ip access-lists mgmt
IP access list mgmt
 10 permit tcp host 10.12.45.57 host 10.12.29.49 eq ssh
 20 permit tcp host 10.12.45.58 host 10.12.29.49 eq telnet [match=10]
 30 permit udp any host 10.12.29.49 eq snmp
 40 permit udp any host 10.12.29.49 eq ntp
 50 permit udp host 10.12.29.49 any eq snmptrap
 60 permit tcp host 10.12.29.49 eq ssh host 10.12.45.57
 70 deny tcp host 10.12.45.58 host 10.12.29.49 eq ssh
 80 deny tcp host 10.12.45.57 host 10.12.29.49 eq telnet
 default deny-all
```

When a UDP packet for Destination Port SNMP reach interface eth0 with any source address, then the match count for access rule 30 increases equal to the number of packets sent. Prior to this SNMP should be configured on Device (10.12.29.49).

Example:

```
snmp-server community SNMPTEST group network-admin vrf management
snmp-server host 10.12.6.86 traps version 2c SNMPTEST udp-port 162 vrf
management
snmp-server enable snmp vrf management
```

```
#show ip access-lists mgmt
IP access list mgmt
 10 permit tcp host 10.12.45.57 host 10.12.29.49 eq ssh
 20 permit tcp host 10.12.45.58 host 10.12.29.49 eq telnet
 30 permit udp any host 10.12.29.49 eq snmp [match=50]
 40 permit udp any host 10.12.29.49 eq ntp
 50 permit udp host 10.12.29.49 any eq snmptrap
 60 permit tcp host 10.12.29.49 eq ssh host 10.12.45.57
 70 deny tcp host 10.12.45.58 host 10.12.29.49 eq ssh
 80 deny tcp host 10.12.45.57 host 10.12.29.49 eq telnet
 default deny-all
```

When a UDP packet for Destination Port NTP reach interface eth0 with any source address, then the match count for access rule 40 increases equal to the number of packets sent. Prior to this NTP should be configured on Device (10.12.29.49).

Example:

```
ntp enable vrf management
ntp authenticate vrf management
ntp authentication-key 123 md5 swwx 7 vrf management
ntp trusted-key 123 vrf management
ntp server 10.12.45.36 vrf management
ntp server 10.12.16.16 prefer vrf management
ntp server 10.12.16.16 key 123 vrf management
```

```
#show ip access-lists mgmt
IP access list mgmt
 10 permit tcp host 10.12.45.57 host 10.12.29.49 eq ssh
 20 permit tcp host 10.12.45.58 host 10.12.29.49 eq telnet
 30 permit udp any host 10.12.29.49 eq snmp
 40 permit udp any host 10.12.29.49 eq ntp [match=1]
 50 permit udp host 10.12.29.49 any eq snmptrap
 60 permit tcp host 10.12.29.49 eq ssh host 10.12.45.57
 70 deny tcp host 10.12.45.58 host 10.12.29.49 eq ssh
```



```
80 deny tcp host 10.12.45.57 host 10.12.29.49 eq telnet
default deny-all
```

When a TCP connection request for Destination Port SSH reach interface eth0 with source address 10.12.45.58, this should deny the connection and the match count for access rule 70 increases equal to the number of packets sent.

```
#show ip access-lists mgmt
IP access list mgmt
10 permit tcp host 10.12.45.57 host 10.12.29.49 eq ssh
20 permit tcp host 10.12.45.58 host 10.12.29.49 eq telnet
30 permit udp any host 10.12.29.49 eq snmp
40 permit udp any host 10.12.29.49 eq ntp
50 permit udp host 10.12.29.49 any eq snmptrap
60 permit tcp host 10.12.29.49 eq ssh host 10.12.45.57
70 deny tcp host 10.12.45.58 host 10.12.29.49 eq ssh [match=1]
80 deny tcp host 10.12.45.57 host 10.12.29.49 eq telnet
default deny-all
```

When a TCP connection request for Destination Port Telnet reach interface eth0 with source address 10.12.45.57, this should deny the connection and the match count for access rule 80 increases equal to the number of packets sent.

```
#show ip access-lists mgmt
IP access list mgmt
10 permit tcp host 10.12.45.57 host 10.12.29.49 eq ssh
20 permit tcp host 10.12.45.58 host 10.12.29.49 eq telnet
30 permit udp any host 10.12.29.49 eq snmp
40 permit udp any host 10.12.29.49 eq ntp
50 permit udp host 10.12.29.49 any eq snmptrap
60 permit tcp host 10.12.29.49 eq ssh host 10.12.45.57
70 deny tcp host 10.12.45.58 host 10.12.29.49 eq ssh
80 deny tcp host 10.12.45.57 host 10.12.29.49 eq telnet [match=1]
default deny-all
```

To enable SNMPTRAPS, apply the ACL outbound to the Management interface.

#configure terminal	Exit access list mode.
(config)#interface eth0	Enter interface mode of Management Interface.
(config-if)#ip access-group mgmt out	Apply access group mgmt for outbound traffic to the interface.
(config-if)#commit	Commit the candidate configuration to the running configuration
(config-if)#end	Exit interface and configure mode.

When a UDP packet for Destination Port SNMPTrap sends out of interface eth0 with any Destination address, then the match count for access rule 50 increases equal to the number of packets received. Prior to this SNMPTrap should be configured on Device (10.12.29.49) to listen to port 162.

Example:

```
snmp-server community SNMPTEST group network-admin vrf management
snmp-server host 10.12.6.86 traps version 2c SNMPTEST udp-port 162 vrf
management
snmp-server enable snmp vrf management
```

```
#show ip access-lists mgmt
IP access list mgmt
10 permit tcp host 10.12.45.57 host 10.12.29.49 eq ssh
20 permit tcp host 10.12.45.58 host 10.12.29.49 eq telnet
30 permit udp any host 10.12.29.49 eq snmp
40 permit udp any host 10.12.29.49 eq ntp
```

```
50 permit udp host 10.12.29.49 any eq snmptrap [match=5]
60 permit tcp host 10.12.29.49 eq ssh host 10.12.45.57
70 deny tcp host 10.12.45.58 host 10.12.29.49 eq ssh
80 deny tcp host 10.12.45.57 host 10.12.29.49 eq telnet
default deny-all
```

When an ACL is applied on interface eth0 outbound and inbound together, then we must configure an ACL to establish a TCP connection between source 10.12.29.49 with source Port SSH to destination address 10.12.45.57. When a TCP connection is established on port SSH, then the match count for access rule 10 and 60 increases equal to the number of packets sent and received.

```
#show ip access-lists mgmt
IP access list mgmt
 10 permit tcp host 10.12.45.57 host 10.12.29.49 eq ssh [match=9]
 20 permit tcp host 10.12.45.58 host 10.12.29.49 eq telnet
 30 permit udp any host 10.12.29.49 eq snmp
 40 permit udp any host 10.12.29.49 eq ntp
 50 permit udp host 10.12.29.49 any eq snmptrap
 60 permit tcp host 10.12.29.49 eq ssh host 10.12.45.57 [match=9]
 70 deny tcp host 10.12.45.58 host 10.12.29.49 eq ssh
 80 deny tcp host 10.12.45.57 host 10.12.29.49 eq telnet
default deny-all
```

**Note:** Use the command `clear ip access-list counters` to clear the statistics of all ACLs or `clear ip access-list <access-list name> counters` to clear statistics of a particular ACL.

```
#show access-lists
IP access list mgmt
 10 permit tcp host 10.12.45.57 host 10.12.29.49 eq ssh
 20 permit tcp host 10.12.45.58 host 10.12.29.49 eq telnet
 30 permit udp any host 10.12.29.49 eq snmp
 40 permit udp any host 10.12.29.49 eq ntp
 50 permit udp host 10.12.29.49 any eq snmptrap
 60 permit tcp host 10.12.29.49 eq ssh host 10.12.45.57
 70 deny tcp host 10.12.45.58 host 10.12.29.49 eq ssh
 80 deny tcp host 10.12.45.57 host 10.12.29.49 eq telnet
```

```
#show access-lists summary
IPV4 ACL mgmt
  statistics enabled
  Total ACEs Configured: 8
  Configured on interfaces:
    eth0 - ingress (Router ACL)
  Active on interfaces:
    eth0 - ingress (Router ACL)
```

```
#show access-lists expanded
IP access list mgmt
 10 permit tcp host 10.12.45.57 host 10.12.29.49 eq ssh
 20 permit tcp host 10.12.45.58 host 10.12.29.49 eq telnet
 30 permit udp any host 10.12.29.49 eq snmp
 40 permit udp any host 10.12.29.49 eq ntp
 50 permit udp host 10.12.29.49 any eq snmptrap
 60 permit tcp host 10.12.29.49 eq ssh host 10.12.45.57
 70 deny tcp host 10.12.45.58 host 10.12.29.49 eq ssh
 80 deny tcp host 10.12.45.57 host 10.12.29.49 eq telnet
default deny-all [match=4]
```

## ARP ACL Overview

ARP ACL can be used to permit or deny the ARP packets, based on the ARP request or response option configured.

### Topology

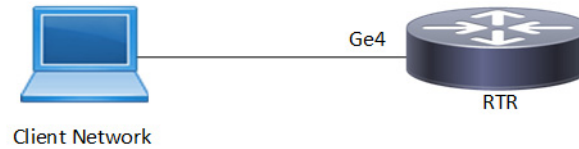

Figure 22-42: ARP ACL Sample Topology

### ARP ACL Configuration

#configure terminal	Enter configure mode.
(config)#interface ge4	Enter interface mode
(config-if)#ip address 11.11.11.11/24	Assign IPv4 address.
(config-if)#exit	Exit access list mode.
(config)#commit	Commit the candidate configurations to the running configurations
(config)#mac access-list m1	Enter mac access list mode.
(config-mac-acl)#permit any any vlan 6	Create an access rule to permit any IPv6 packet
(config-mac-acl)#permit 0000.0215.2151 0000.0000.0011 any vlan 3	Create an access rule to permit specific ARP response.
(config-mac-acl)#exit	Exit access list mode.
(config)#commit	Commit the candidate configurations to the running configurations
(config)#interface ge4	Enter interface mode.
(config-if)#mac access-group m1 in	Apply access group mac1 for inbound traffic to the interface.
(config-if)#commit	Commit the candidate configurations to the running configurations
(config-if)#end	Exit interface and configure mode.

### Validation

Use the commands below to assign IP address on IXIA and ping from IXIA.

```
#show mac access-lists
  MAC access list mac1
    10 permit host 0000.3AE0.456D any arp request [match=1]
    20 permit host 0000.3AE0.456D any arp response [match=1]
    30 permit any any ipv4 [match=1]
    default deny-all
```

## ACL over Loopback

The loopback interface ACL feature provides basic security for management applications accessible through In-band interfaces.

Note: Refer to the command reference section for limitations, default behavior, and unsupported features.

## Topology

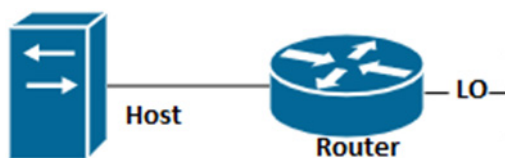

Figure 22-43: ACL Loopback Topology

#configure terminal	Enter configure mode.
(config)#interface lo	Enter interface mode.
(config-if)#ip address 3.3.3.3/32 secondary	Assign the IPv4 secondary address.
(config-if)#ip address 4.4.4.4/32 secondary	Assign the IPv4 secondary address.
(config-if)#ip address 5.5.5.5/32 secondary	Assign the IPv4 secondary address.
(config-if)#ip address 6.6.6.6/32 secondary	Assign the IPv4 secondary address.
(config-if)#ip address 7.7.7.7/32 secondary	Assign the IPv4 secondary address.
(config-if)# exit	Exit interface mode.
(config)#commit	Commit the candidate configuration to the running configuration
(config)#ip access-list loopback	Create loopback access list
(config-ip-acl)# 10 permit tcp any host 3.3.3.3 eq telnet	Permit telnet session from any source with specific destination.
(config-ip-acl)# 20 deny tcp any host 4.4.4.4 eq telnet	Deny telnet session from any source with specific destination.
(config-ip-acl)# 30 permit tcp any host 5.5.5.5 eq ssh	Permit ssh session from any source with specific destination.
(config-ip-acl)# 40 deny tcp any host 6.6.6.6 eq ssh	Deny ssh session from any source with specific destination.
(config-ip-acl)# 50 deny udp any host 6.6.6.6 eq snmp	Deny udp from any source with specific destination.
(config-ip-acl)# 60 deny udp any host 7.7.7.7 eq ntp	Deny udp from any source with specific destination.
(config-ip-acl)#exit	Exit interface acl mode
(config)#commit	Commit the candidate configuration to the running configuration
(config)#interface lo	Enter interface lo mode
(config-if)#ip access-group loopback in	Associate loopback acl over lo interface
(config-if)#exit	Exit interface mode
(config)#commit	Commit the candidate configuration to the running configuration
(config)#exit	Exit config mode

## Validation

```
#sh access-lists
```

```
IP access list loopback
 10 permit tcp any host 3.3.3.3 eq telnet [match=12]
 20 deny tcp any host 4.4.4.4 eq telnet [match=12]
 30 permit tcp any host 5.5.5.5 eq ssh
 40 deny tcp any host 6.6.6.6 eq ssh
 50 deny udp any host 6.6.6.6 eq snmp [match=6]
 60 deny udp any host 7.7.7.7 eq ntp
```

```
#sh ip access-lists summary
IPV4 ACL loopback
  statistics enabled
  Total ACEs Configured: 6
  Configured on interfaces:
    lo - ingress (Router ACL)
  Active on interfaces:
    lo - ingress (Router ACL)
  Configured on line vty:
```

```
#sh running-config aclmgr
ip access-list loopback
 10 permit tcp any host 3.3.3.3 eq telnet
 20 deny tcp any host 4.4.4.4 eq telnet
 30 permit tcp any host 5.5.5.5 eq ssh
 40 deny tcp any host 6.6.6.6 eq ssh
 50 deny udp any host 6.6.6.6 eq snmp
 60 deny udp any host 7.7.7.7 eq ntp
!
interface lo
 ip access-group loopback in
!
```

---

## ACL OVER Virtual Terminal (VTY)

When a Telnet/SSH/NetConf connection is established in the OcNOS, it associates the connection with a virtual terminal (VTY) line. The ACL over VTY feature provides security for management features associated with VTY.

Users can create Standard and Extended ACL rules and attach them to a virtual teletype (VTY) command line interface. These ACL rules are applied on both Management and Default virtual routing forwarding (VRFs).

OcNOS supports both IPv4 and IPv6 access lists for VTY lines, providing flexibility for network configurations.

Applying a standard ACL rule on a VTY line permits or denies only management access protocols such as SSH, Telnet, and SSH-Netconf protocols (port numbers 22,23,830)).

Extended ACL rules are applied as configured by the user, and it is not limited to management protocols only, unlike Standard ACLs.

When a user configures a rule with 'deny any any any' and attaches it to the VTY, it effectively blocks only the Telnet, SSH, and NetConf protocols on the control plane

For example, when a user configures a rule as below and attach them to VTY, If the deny ACL rule includes 'any' value in protocol, only Telnet/SSH/SSH-NetConf protocols are denied.

```
ip access-list ssh-access
```

```
10 permit tcp 10.12.43.0/24 any eq ssh
20 deny any any any
```

**Note:** To deny any protocols other than Telnet/SSH/SSH-Netconf, create a deny rule with the specific protocol access on VTY. For example: To deny OSPF protocol from all the source and destination address, apply the rule, 10 deny ospf any any.

In general, the VTY ACLs are more specific to management protocols. Hence, the Extended ACL “any” rule translation is enhanced to allow management protocols as follows:

- If the **deny** ACL rule includes any value in protocol, only Telnet/SSH/SSH-Netconf protocols are denied.
- The **permit** ACL rule is unchanged.

**Note:** Refer to the command reference section for limitations, default behavior, and unsupported features.

**Note:** This feature allows the customer to define a Extended ACL deny rule only to the management protocol without impacting other control protocols.

**Note:** Configure a separate Extended ACL deny rule to deny protocols other than Telnet, SSH, and NetConf.

---

## Topology

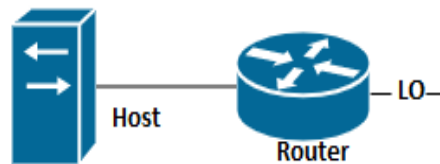

**Figure 22-44: ACL VTY Topology**

---

## VTY ACL Configuration

#configure terminal	Enter configure mode.
(config)#interface lo	Enter interface mode.
(config-if)#ip address 3.3.3.3/32 secondary	Assign the IPv4 secondary address.
(config-if)# exit	Exit interface mode.
(config)#ip access-list vty	Create loopback access list
(config-ip-acl)# 10 permit tcp any host 3.3.3.3 eq telnet	Permit telnet session from any source with specific destination.
(config-ip-acl)#exit	Exit interface acl mode
(config)#line vty	Enter interface vty mode
(config-all-line)#ip access-group vty in	Associate acl over
(config-if)#exit	Exit interface mode
(config)#exit	Exit config mode

## Validation

```
OcNOS#sh access-lists
```

```
IP access list vty
  10 permit tcp any host 3.3.3.3 eq telnet
```

```
OcNOS#sh ip access-lists summary
IPV4 ACL vty
  statistics enabled
  Total ACEs Configured: 1
  Configured on interfaces:
  Active on interfaces:
  Configured on line vty:
  all vty lines - ingress
```

```
OcNOS#sh running-config access-list
ip access-list vty
10 permit tcp any host 3.3.3.3 eq telnet
!
line vty
ip access-group vty in
```

---

## Timed ACL Configuration

The time range feature was introduced to be able to add a timing boundary for specified activities. The activity would start, end and repeat at the specific times set by the user. This time-range feature will enable creating "Timed ACLs". This will help service providers to customize the internet data to customers based on time to increase the video traffic during weekends and reduce data traffic, restrict the internet traffic in school or college non-working hours etc.

---

## Topology

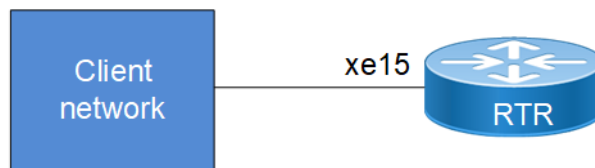

Figure 22-45: Timed acl sample topology

---

## Configuration with IPv4 Address

#configure terminal	Enter configure mode.
(config)#time-range TIMER1	Configure a timer
(config-tr)#start-time 10:00 03 nov 2021	Configure start time
(config-tr)#end-time 18:00 03 nov 2021	Configure end time
(config-tr)#exit	Exit timer
(config)#ip access-list ACL1	Create ip access list
(config-ip-acl)# deny icmp host 10.1.1.1 host 10.1.2.2	Create an acl rule to deny icmp

## Access Control Lists Configurations

---

(config-ip-acl)#exit	Exit Acl mode
(config)#commit	Commit the candidate configuration to the running configuration
(config)#hardware-profile filter egress-ipv4 enable	Hardware profile enable for the acl
(config)#int xe15	Enter into the interface mode
(config-if)#ip access-group ACL1 out time-range TIMER1	Apply the acl along with the timer.
(config-if)#commit	Commit the candidate configuration to the running configuration
(config-if)#exit	Exit

---

## Configuration with IPv6 Address

(config)#ipv6 access-list ACL1v6	Create ipv6 access list
(config-ipv6-acl)# deny any any any	Create an acl rule to deny
(config-ipv6-acl)#exit	Exit Acl mode
(config)#commit	Commit the candidate configuration to the running configuration
(config)# hardware-profile filter ingress-ipv6 enable	Hardware profile enable for the acl
(config)#int xe12	Enter into the interface mode
(config-if)# ipv6 access-group ACL1v6 in time-range TIMER1	Apply the acl along with the timer.
(config-if)#commit	Commit the candidate configuration to the running configuration
(config-if)#exit	Exit

---

## Configuration with mac

(config)# mac access-list ACL1mac	Create ip access list
(config-mac-acl)# deny 0000.0000.0000 1111.2222.3333 0000.0000.0000 4444.5555.6666	Create an acl rule to deny icmp
(config-mac-acl)#exit	Exit Acl mode
(config)#commit	Commit the candidate configuration to the running configuration
(config)# hardware-profile filter ingress-12 enable	Hardware profile enable for the acl
(config)#int xe13	Enter into the interface mode
(config-if)# mac access-group ACL1mac in time-range TIMER1	Apply the acl along with the timer.
(config-if)#commit	Commit the candidate configuration to the running configuration
(config-if)#exit	Exit



---

## Validation

```
#sh running-config in xe15
!
interface xe15
 ip access-group ACL1 out time-range TIMER1
!
#sh running-config in xe12
!
interface xe12
 ipv6 access-group ACL1v6 in time-range TIMER1
!
#sh running-config in xe13
!
interface xe13
 mac access-group ACL1mac in time-range TIMER1

#sh time-range
=====
TR handler interval: 10 seconds
=====
TR entries: 1
Entry: 0
 name: TIMER1
 state: Pending
 frequency: none
 start time: Wed Nov 3 10:00:00 2021
 end time: Wed Nov 3 18:00:00 2021
=====
RUNNING TR entries: 0
=====
COMPLETED TR entries: 0
```



## CHAPTER 23 Syslog Configuration

### Overview

Syslog is a standard for logging program messages. It allows separation of the software that generates messages from the system that stores them and the software that reports and analyzes them. It also provides devices which would otherwise be unable to communicate, a means to notify administrators of problems or performance.

OcNOS supports logging messages to a syslog server in addition to logging to a file or the console (local or ssh/telnet console). OcNOS messages can be logged to a local syslog server (the machine on which OcNOS executes) as well as to one or more remote syslog servers (maximum of 8 remote syslog server is supported). Remote syslog servers can either be configured with IPv4/v6 addresses or host names.

### Support for In-band management over default VRF

OcNOS supports syslog over the default and management VRFs via in-band management interface and OOB management interface, respectively.

By default, syslog runs on the management VRF.

### Syslog Configuration with IPv4 Address

Logging is performed with IPv4 IP address and verified by logs on remote machine.

### Topology



Figure 23-46: Syslog sample topology

### Enabling rsyslog

#configure terminal	Enter configure mode.
(config)#feature rsyslog [vrf management]	Enable feature on default or management VRF. By default this feature runs on the management VRF.

(config)#commit	Commit the candidate configuration to the running configuration
(config)#exit	Exit configure mode

## Logging to a File

The below configurations shows how to enable debug logs for a particular protocol. In this case, OSPF is shown.

#debug ospf all	This enables the debugging on OSPF.
#configure terminal	Enter configure mode
(config)#router ospf 1	Enable OSPF process 1
(config-router)#exit	Exit router mode
(config)#feature rsyslog	Enable feature on default or management VRF. By default this feature runs on the management VRF.
(config)#logging level ospf 7	This enable debug messages for OSPF module. This is configurable either if default of management VRF.
(config)#logging logfile ospf1 7	This creates the log file where the logs will be saved. The path of the file will be in the directory /log/ospf1. Log File size 4096-4194304 bytes.
(config)#commit	Commit the candidate configuration to the running configuration
(config)#exit	Exit configure mode

To verify this, do some OSPF configuration and view the messages in the log file or with the `show logging logfile` command.

## Validation

```
#show logging logfile
```

```
File logging : enabled File Name : /log/ospf1 Size : 419430400 Severity :
(7)
2019 Jan 05 20:10:52.202 : OcNOS : OSPF : INFO : NSM Message Header
2019 Jan 05 20:10:52.202 : OcNOS : OSPF : INFO : VR ID: 0
2019 Jan 05 20:10:52.203 : OcNOS : OSPF : INFO : VRF ID: 0
2019 Jan 05 20:10:52.203 : OcNOS : OSPF : INFO : Message type:
NSM_MSG_LINK_ADD
(5)
2019 Jan 05 20:10:52.203 : OcNOS : OSPF : INFO : Message length: 232
2019 Jan 05 20:10:52.203 : OcNOS : OSPF : INFO : Message ID: 0x00000000
2019 Jan 05 20:10:52.203 : OcNOS : OSPF : INFO : NSM Interface
2019 Jan 05 20:10:52.203 : OcNOS : OSPF : INFO : Interface index: 100001
2019 Jan 05 20:10:52.203 : OcNOS : OSPF : INFO : Name: po1
2019 Jan 05 20:10:52.204 : OcNOS : OSPF : INFO : Flags: 536875010
2019 Jan 05 20:10:52.204 : OcNOS : OSPF : INFO : Status: 0x00000804
2019 Jan 05 20:10:52.204 : OcNOS : OSPF : INFO : Metric: 1
2019 Jan 05 20:10:52.207 : OcNOS : OSPF : INFO : MTU: 1500
2019 Jan 05 20:10:52.207 : OcNOS : OSPF : INFO : Type: L3
2019 Jan 05 20:10:52.207 : OcNOS : OSPF : INFO : HW type: 9
2019 Jan 05 20:10:52.208 : OcNOS : OSPF : INFO : HW len: 6
2019 Jan 05 20:10:52.209 : OcNOS : OSPF : INFO : HW address: ecf4.bb5c.a2b0
2019 Jan 05 20:10:52.210 : OcNOS : OSPF : INFO : Bandwidth: 0.000000
2019 Jan 05 20:10:52.211 : OcNOS : OSPF : INFO : Interface lacp key flag 0
```

```
2019 Jan 05 20:10:52.212 : OcNOS : OSPF : INFO : Interface lacp aggregator
upda
te flag 0
```

```
#show logging level
```

Facility	Default	Severity	Current	Session	Severity
nsm		3		3	
ripd		3		3	
ospfd		3		7	
ospf6d		3		3	
isisd		3		3	
hostpd		3		3	
ldpd		2		2	
rsvpd		2		2	
mribd		2		2	
pimd		2		2	
authd		2		2	
mstpd		2		2	
imi		2		2	
onmd		2		2	
oamd		2		2	
vlogd		2		2	
vrrpd		2		2	
ribd		2		2	
bgpd		3		3	
l2mribd		2		2	
lagd		2		2	
sflow		2		2	
pservd		2		2	

## Logging to the Console

Note: For CMMD, Critical logs in the console are equivalent to Alert traps & Alert logs on the console is equivalent to critical trap in SNMP.

#configure terminal	Enter configure mode.
(config)#logging level ospf 7	This enable debug messages for OSFP module.
(config)#logging console 7	This enables the console logs.
(config)#debug ospf	This enables the debugging on OSPF configurations.
(config)#router ospf	Enabling ospf for process 1.
(config-router)#exit	Exit router mode.
(config)#commit	Commit the candidate configuration to the running configuration
(config)#exit	Exit configure mode.

To verify this, do some OSPF configuration and view the messages in the console.

### Validation

```
#show logging console
  Console logging      : enabled Severity: (debugging)
```

```
#show logging level
```

Facility	Default Severity	Current Session Severity
nsm	3	3
ripd	3	3
ospfd	3	7
ospf6d	3	3
isisd	3	3
hostpd	3	3
ldpd	2	2
rsvdpd	2	2
mribd	2	2
pimd	2	2
authd	2	2
mstpd	2	2
imi	2	2
onmd	2	2
oamd	2	2
vlogd	2	2
vrrpd	2	2
ribd	2	2
bgpd	3	3
l2mribd	2	2
lagd	2	2
sflow	2	2
pservd	2	2

---

## Logging to Remote Server

#configure terminal	Enter configure mode.
(config)#logging level bgp 7	This enable debug messages for BGP module.
(config)#logging remote server 10.16.2.1 vrf management	Redirects the log messages to the server configured.
(config)#debug bgp all	This enables the debugging on BGP configurations.
(config)#router bgp 1	Enabling BGP process 1.
(config-router)#exit	Exit router mode.
(config)#commit	Commit the candidate configuration to the running configuration
(config)#exit	Exit configure mode.

## Validation

```
#show logging server
  Remote Servers:
    10.16.2.1
    severity: (debugging)
    facility: local7
    VRF: management
```

```
#show logging level
```

Facility	Default Severity	Current Session Severity
nsm	3	3
ripd	3	3
ospfd	3	3

ospf6d	3	3
isisd	3	3
hostpd	3	3
ldpd	2	2
rsvpd	2	2
mribd	2	2
pimd	2	2
authd	2	2
mstpd	2	2
imi	2	2
onmd	2	2
oamd	2	2
vlogd	2	2
vrrpd	2	2
ribd	2	2
bgpd	3	7
l2mribd	2	2
lagd	2	2
sflow	2	2
pservd	2	2

## Syslog Configuration with IPv6 Address

Logging is performed with IPv6 IP and verified by logs on remote PC (Logging server).

### Topology

Figure 23-47 shows the sample configuration of Syslog.



Figure 23-47: Syslog Configuration topology

### Enabling rsyslog

#configure terminal	Enter configure mode
(config)#feature rsyslog [vrf management]	Enable feature on default or management VRF. By default this feature runs on the management VRF.

<code>(config)#commit</code>	Commit the candidate configuration to the running configuration
<code>(config)#exit</code>	Exit configure mode

---

### Logging to a File

The below configurations shows how to enable debug logs for a particular protocol. In this case, OSPF is shown.

<code>#debug ospf all</code>	This enables the debugging on OSPF
<code>#configure terminal</code>	Enter configure mode
<code>(config)#router ospf 1</code>	Enable OSPF process 1
<code>(config-router)#exit</code>	Exit router mode
<code>(config)#feature rsyslog</code>	Enable feature on default or management VRF. By default this feature runs on the management VRF.
<code>(config)#logging level ospf 7</code>	This enable debug messages for OSPF module. This is configurable either if de-fault of management VRF.
<code>(config)#logging logfile ospf1 7</code>	This creates the log file where the logs will be saved. The path of the file will be in the directory /log/ospf1. Log File size 4096-4194304 bytes
<code>(config)#commit</code>	Commit the candidate configuration to the running configuration
<code>(config)#exit</code>	Exit configure mode

---

### Logging to Remote Server

<code>#configure terminal</code>	Enter configure mode.
<code>(config)#logging level bgp 7</code>	This enable debug messages for BGP module
<code>(config)#logging remote server 10.16.2.1 vrf management</code>	Redirects the log messages to the server configured.
<code>(config)#debug bgp all</code>	This enables the debugging on BGP configurations.
<code>(config)#router bgp 1</code>	Enabling BGP process 1.
<code>(config-router)#exit</code>	Exit router mode.
<code>(config)#commit</code>	Commit the candidate configuration to the running configuration
<code>(config)#exit</code>	Exit configure mode.

---

### Validation

```
#show logging server
Remote Servers:
    2001::1
    severity: (debugging)
    facility: local7
    VRF: management
```



---

## CHAPTER 24 Custom Syslog Port Configuration

---

---

### Overview

OcNOS enables the establishment of a Syslog server by designating the logging server as XX.XX.XX.XXX. This configuration sends syslog messages via the default port, which is 514. However, utilizing the default port for the Syslog server is considered a security vulnerability.

---

### Support for In-band management over default VRF

OcNOS supports syslog over the default and management VRFs via in-band management interface and OOB management interface, respectively.

By default, syslog runs on the management VRF.

---

### Features

- CLI is supported for user to configure custom syslog port.
- Once configured syslog conf file is updated with the configured port value.
- At the rsyslog server side, stop the running rsyslogd daemon using the command `systemctl stop rsyslog.service`
- Update `/etc/rsyslog.conf` file with syslog client configured port.
- Start the rsyslog daemon –using `systemctl start rsyslog.service`.
- Logs will redirect to syslog server through configured port.
- After un-configuring, the port logs will be sent to syslog remote server through default port 514, to receive the logs at server side, it also needs to be set back to default.
- Delete the custom Syslog port.

---

### Custom Syslog Configuration with IPv4 Address

Logging is performed with IPv4 address and verified by logs on remote machine.

## Topology



Figure 24-48: Syslog sample topology

## Enabling rsyslog

#configure terminal	Enter configure mode.
(config)#feature rsyslog [vrf management]	Enable feature on default or management VRF. By default this feature runs on the management VRF.
(config)#commit	Commit the candidate configuration to the running configuration
(config)#exit	Exit configure mode
(config)# logging remote server 10.12.33.211 7 port 8514 vrf management	Redirect into the remote server configure the severity and custom port with vrf management (default custom port is 514).
(config)#commit	Commit the candidate configuration to the running configuration
(config)#exit	Exit configure mode

## Validation

```
#sh running-config logging
feature rsyslog vrf management
logging remote server 10.12.33.211 7 port 8514 vrf management
```

```
ocnos#show logging server
  Remote Servers:
    10.12.33.211
    port: 8514
    severity: Operator (debug-detailed)
    facility: local7
    VRF : management
```

Check the rsyslog messages in server at /var/log/OcNOS.log

---

```
2023-08-25T12:36:56+05:30 OcnOS PSERV[1595]: 2023 Aug 25 12:36:56.982 : OcnOS : PSERV :
DEBUG : Keep-Alive message sent to systemd
2023-08-25T12:37:03+05:30 OcnOS HSL[4598]: 2023 Aug 25 12:37:03.610 : OcnOS : HSL :
NOTIF : [IF_PKT_ERRORS_4]: Oversized packets received on ge14 (1 packets)
2023-08-25T12:37:13+05:30 OcnOS HSL[4598]: 2023 Aug 25 12:37:13.610 : OcnOS : HSL :
NOTIF : [IF_PKT_ERRORS_4]: Oversized packets received on ge14 (1 packets)
2023-08-25T12:37:23+05:30 OcnOS HSL[4598]: 2023 Aug 25 12:37:23.610 : OcnOS : HSL :
NOTIF : [IF_PKT_ERRORS_4]: Oversized packets received on ge14 (1 packets)
2023-08-25T12:37:33+05:30 OcnOS HSL[4598]: 2023 Aug 25 12:37:33.610 : OcnOS : HSL :
NOTIF : [IF_PKT_ERRORS_4]: Oversized packets received on ge14 (1 packets)
2023-08-25T12:37:43+05:30 OcnOS HSL[4598]: 2023 Aug 25 12:37:43.611 : OcnOS : HSL :
NOTIF : [IF_PKT_ERRORS_4]: Oversized packets received on ge14 (1 packets)
2023-08-25T12:37:49+05:30 OcnOS sshd[11651]: Accepted password for ocnos from
192.168.230.131 port 57298 ssh2
2023-08-25T12:37:49+05:30 OcnOS sshd[11651]: pam_unix(sshd:session): session opened for
user ocnos by (uid=0)
2023-08-25T12:37:50+05:30 OcnOS sshd[11660]: Accepted password for ocnos from
192.168.230.131 port 57301 ssh2
2023-08-25T12:37:50+05:30 OcnOS sshd[11660]: pam_unix(sshd:session): session opened for
user ocnos by (uid=0)
2023-08-25T12:37:50+05:30 OcnOS CML[4875]: 2023 Aug 25 12:37:50.359 : OcnOS : CML : INFO
: [CML_5]: Client [cmlsh (/dev/pts/0)] established connection with CML server
2023-08-25T12:37:51+05:30 OcnOS CMLSH[11672]: 2023 Aug 25 12:37:51.214 : OcnOS : CMLSH :
CLI_HIST : User ocnos@/dev/pts/0 : CLI : terminal monitor
2023-08-25T12:37:53+05:30 OcnOS CMLSH[11672]: 2023 Aug 25 12:37:53.330 : OcnOS : CMLSH :
CLI_HIST : User ocnos@/dev/pts/0 : CLI : en *New User Login*
2023-08-25T12:37:53+05:30 OcnOS HSL[4598]: 2023 Aug 25 12:37:53.611 : OcnOS : HSL :
NOTIF : [IF_PKT_ERRORS_4]: Oversized packets received on ge14 (1 packets)
2023-08-25T12:37:55+05:30 OcnOS CMLSH[11672]: 2023 Aug 25 12:37:55.570 : OcnOS : CMLSH :
CLI_HIST : User ocnos@/dev/pts/0 : CLI : start-shell
2023-08-25T12:37:56+05:30 OcnOS PSERV[1595]: 2023 Aug 25 12:37:56.983 : OcnOS : PSERV :
DEBUG : Keep-Alive message sent to systemd
2023-08-25T12:37:58+05:30 OcnOS su: (to root) ocnos on pts/0
2023-08-25T12:37:58+05:30 OcnOS su: pam_unix(su-l:session): session opened for user
root by ocnos(uid=1000)
2023-08-25T12:38:03+05:30 OcnOS HSL[4598]: 2023 Aug 25 12:38:03.611 : OcnOS : HSL :
NOTIF : [IF_PKT_ERRORS_4]: Oversized packets received on ge14 (1 packets)
2023-08-25T12:38:13+05:30 OcnOS HSL[4598]: 2023 Aug 25 12:38:13.611 : OcnOS : HSL :
NOTIF : [IF_PKT_ERRORS_4]: Oversized packets received on ge14 (1 packets)
2023-08-25T12:38:17+05:30 OcnOS PSERV[1595]: 2023 Aug 25 12:38:17.201 : OcnOS : PSERV :
CRITI : Module: ospfd has closed connection with PSERVD.
2023-08-25T12:38:17+05:30 OcnOS CML[4875]: 2023 Aug 25 12:38:17.204 : OcnOS : CML :
CRITI : Module ospf disconnected with CML
2023-08-25T12:38:18+05:30 OcnOS PSERV[1595]: 2023 Aug 25 12:38:18.229 : OcnOS : PSERV :
INFO : Protocol pservd published protocol-module-down notification.
2023-08-25T12:38:18+05:30 OcnOS PSERV[1595]: 2023 Aug 25 12:38:18.241 : OcnOS : PSERV :
DEBUG : pserv SIGUER2 signal for module :ospfd
2023-08-25T12:38:18+05:30 OcnOS PSERV[1595]: 2023 Aug 25 12:38:18.242 : OcnOS : PSERV :
DEBUG : Crash Dump Directory not present
2023-08-25T12:38:20+05:30 OcnOS NSM[4639]: 2023 Aug 25 12:38:20.110 : OcnOS : NSM :
DEBUG : G8031 : nsm_g8031_sync : Sync PG info to ONMD
2023-08-25T12:38:20+05:30 OcnOS PSERV[1595]: 2023 Aug 25 12:38:20.116 : OcnOS : PSERV :
NOTIF : [WATCHDOG_PM_RECOVERED_4]: The module ospfd recovered from a critical error
2023-08-25T12:38:20+05:30 OcnOS PSERV[1595]: Signal SIGUSR2 received and restarted
module: ospfd

2019 Jan 05 20:10:52.212 : OcnOS : OSPF : INFO : Interface lacp aggregator update flag 0
```

---

## Custom Syslog Configuration with IPv6 Address

Logging is performed with IPv6 IP and verified by logs on remote PC (Logging server).

### Topology

Figure 24-49 shows the sample configuration of Syslog.

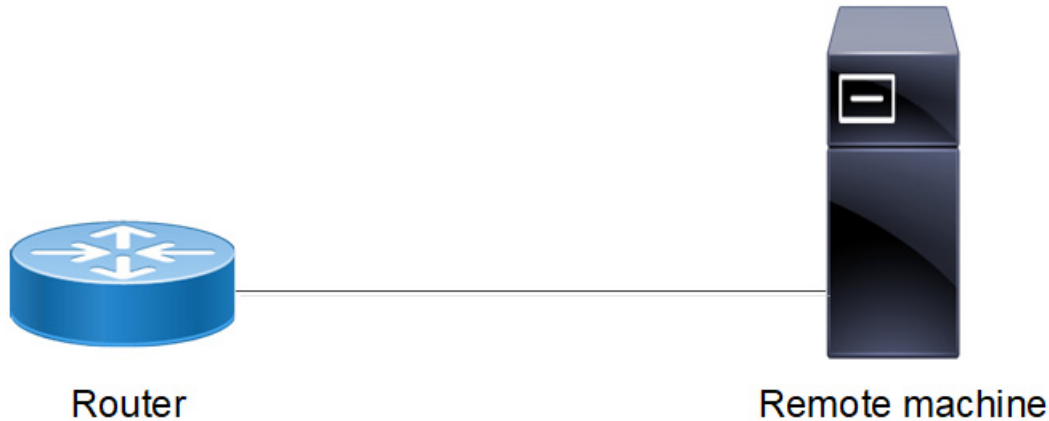

Figure 24-49: Syslog Configuration topology

### Enabling rsyslog

#configure terminal	Enter configure mode
(config)#feature rsyslog [vrf management]	Enable feature on default or management VRF. By default this feature runs on the management VRF.
(config)#commit	Commit the candidate configuration to the running configuration
(config)#logging remote server 200:201::100:10 7 port 8514 vrf management	Redirect into the remote server configure the severity and custom port with vrf management (default custom port is 514).
(config)#commit	Commit the candidate configuration to the running configuration
(config)#exit	Exit configure mode

### Validation

```
ocnos#sh running-config logging
feature rsyslog vrf management
logging remote server 200:201::100:10 7 port 8514 vrf management
```

```
#show logging server
Remote Servers:
    200:201::100:10
    port: 8514
    severity: Operator (debug-detailed)
    facility: local7
    VRF : management
```

---

**Check the rsyslog messages in server at /var/log/OcNOS.log**

```
2023-08-25T12:36:56+05:30 OcNOS PSERV[1595]: 2023 Aug 25 12:36:56.982 : OcNOS : PSERV :
DEBUG : Keep-Alive message sent to systemd
2023-08-25T12:37:03+05:30 OcNOS HSL[4598]: 2023 Aug 25 12:37:03.610 : OcNOS : HSL :
NOTIF : [IF_PKT_ERRORS_4]: Oversized packets received on ge14 (1 packets)
2023-08-25T12:37:13+05:30 OcNOS HSL[4598]: 2023 Aug 25 12:37:13.610 : OcNOS : HSL :
NOTIF : [IF_PKT_ERRORS_4]: Oversized packets received on ge14 (1 packets)
2023-08-25T12:37:23+05:30 OcNOS HSL[4598]: 2023 Aug 25 12:37:23.610 : OcNOS : HSL :
NOTIF : [IF_PKT_ERRORS_4]: Oversized packets received on ge14 (1 packets)
2023-08-25T12:37:33+05:30 OcNOS HSL[4598]: 2023 Aug 25 12:37:33.610 : OcNOS : HSL :
NOTIF : [IF_PKT_ERRORS_4]: Oversized packets received on ge14 (1 packets)
2023-08-25T12:37:43+05:30 OcNOS HSL[4598]: 2023 Aug 25 12:37:43.611 : OcNOS : HSL :
NOTIF : [IF_PKT_ERRORS_4]: Oversized packets received on ge14 (1 packets)
2023-08-25T12:37:49+05:30 OcNOS sshd[11651]: Accepted password for ocnos from
192.168.230.131 port 57298 ssh2
2023-08-25T12:37:49+05:30 OcNOS sshd[11651]: pam_unix(sshd:session): session opened for
user ocnos by (uid=0)
2023-08-25T12:37:50+05:30 OcNOS sshd[11660]: Accepted password for ocnos from
192.168.230.131 port 57301 ssh2
2023-08-25T12:37:50+05:30 OcNOS sshd[11660]: pam_unix(sshd:session): session opened for
user ocnos by (uid=0)
2023-08-25T12:37:50+05:30 OcNOS CML[4875]: 2023 Aug 25 12:37:50.359 : OcNOS : CML : INFO
: [CML_5]: Client [cmlsh (/dev/pts/0)] established connection with CML server
2023-08-25T12:37:51+05:30 OcNOS CMLSH[11672]: 2023 Aug 25 12:37:51.214 : OcNOS : CMLSH :
CLI_HIST : User ocnos@/dev/pts/0 : CLI : terminal monitor
2023-08-25T12:37:53+05:30 OcNOS CMLSH[11672]: 2023 Aug 25 12:37:53.330 : OcNOS : CMLSH :
CLI_HIST : User ocnos@/dev/pts/0 : CLI : en *New User Login*
2023-08-25T12:37:53+05:30 OcNOS HSL[4598]: 2023 Aug 25 12:37:53.611 : OcNOS : HSL :
NOTIF : [IF_PKT_ERRORS_4]: Oversized packets received on ge14 (1 packets)
2023-08-25T12:37:55+05:30 OcNOS CMLSH[11672]: 2023 Aug 25 12:37:55.570 : OcNOS : CMLSH :
CLI_HIST : User ocnos@/dev/pts/0 : CLI : start-shell
2023-08-25T12:37:56+05:30 OcNOS PSERV[1595]: 2023 Aug 25 12:37:56.983 : OcNOS : PSERV :
DEBUG : Keep-Alive message sent to systemd
2023-08-25T12:37:58+05:30 OcNOS su: (to root) ocnos on pts/0
2023-08-25T12:37:58+05:30 OcNOS su: pam_unix(su-l:session): session opened for user
root by ocnos(uid=1000)
2023-08-25T12:38:03+05:30 OcNOS HSL[4598]: 2023 Aug 25 12:38:03.611 : OcNOS : HSL :
NOTIF : [IF_PKT_ERRORS_4]: Oversized packets received on ge14 (1 packets)
2023-08-25T12:38:13+05:30 OcNOS HSL[4598]: 2023 Aug 25 12:38:13.611 : OcNOS : HSL :
NOTIF : [IF_PKT_ERRORS_4]: Oversized packets received on ge14 (1 packets)
2023-08-25T12:38:17+05:30 OcNOS PSERV[1595]: 2023 Aug 25 12:38:17.201 : OcNOS : PSERV :
CRITI : Module: ospfd has closed connection with PSERVD.
2023-08-25T12:38:17+05:30 OcNOS CML[4875]: 2023 Aug 25 12:38:17.204 : OcNOS : CML :
CRITI : Module ospf disconnected with CML
2023-08-25T12:38:18+05:30 OcNOS PSERV[1595]: 2023 Aug 25 12:38:18.229 : OcNOS : PSERV :
INFO : Protocol pservd published protocol-module-down notification.
2023-08-25T12:38:18+05:30 OcNOS PSERV[1595]: 2023 Aug 25 12:38:18.241 : OcNOS : PSERV :
DEBUG : pserv SIGUER2 signal for module :ospfd
2023-08-25T12:38:18+05:30 OcNOS PSERV[1595]: 2023 Aug 25 12:38:18.242 : OcNOS : PSERV :
DEBUG : Crash Dump Directory not present
2023-08-25T12:38:20+05:30 OcNOS NSM[4639]: 2023 Aug 25 12:38:20.110 : OcNOS : NSM :
DEBUG : G8031 : nsm_g8031_sync : Sync PG info to ONMD
2023-08-25T12:38:20+05:30 OcNOS PSERV[1595]: 2023 Aug 25 12:38:20.116 : OcNOS : PSERV :
NOTIF : [WATCHDOG_PM_RECOVERED_4]: The module ospfd recovered from a critical error
```

```
2023-08-25T12:38:20+05:30 OcNOS PSERV[1595]: Signal SIGUSR2 received and restarted module: ospfd
2019 Jan 05 20:10:52.212 : OcNOS : OSPF : INFO : Interface lacp aggregator update flag 0
```

---

## Custom Syslog Configuration with HOSTNAME

Logging is performed with IPv6 IP and verified by logs on remote PC (Logging server).

---

### Topology

Figure 24-50 shows the sample configuration of Syslog.

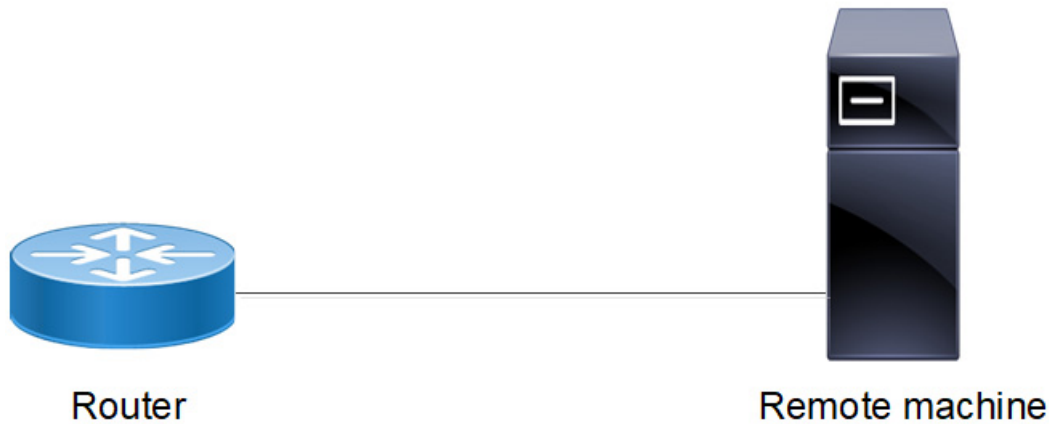

Figure 24-50: Syslog Configuration topology

---

### Enabling rsyslog

#configure terminal	Enter configure mode
(config)#feature rsyslog [vrf management]	Enable feature on default or management VRF. By default this feature runs on the management VRF.
(config)#commit	Commit the candidate configuration to the running configuration
(config)#exit	Exit configure mode
(config)#hostname CUSTOM-SYSLOG	Change the hostname to custom-syslog
(config)#commit	Commit the candidate configuration to the running configuration
(config)#exit	Exit configure mode
(config)#logging remote server custom-syslog 7 port 8514 vrf management	Redirect into the remote server configure the severity and custom port with vrf management (default custom port is 514).
(config)#commit	Commit the candidate configuration to the running configuration
(config)#exit	Exit configure mode

### Validation

```
ocnos#sh running-config logging
CUSTOM-SYSLOG#sh ru logging
feature rsyslog vrf management
```

---

```
logging remote server custom-syslog 7 port 8514 vrf management
CUSTOM-SYSLOG#
```

```
#show logging server
```

```
Remote Servers:
    custom-syslog
    port: 8514
    severity: Operator (debug-detailed)
    facility: local7
    VRF : management
```

Check the rsyslog messages in server

Server Path:- /var/log/OcNOS.log

---

## Sample Output

```
2023-08-25T12:36:56+05:30 OcNOS PSERV[1595]: 2023 Aug 25 12:36:56.982 : OcNOS : PSERV :
DEBUG : Keep-Alive message sent to systemd
2023-08-25T12:37:03+05:30 OcNOS HSL[4598]: 2023 Aug 25 12:37:03.610 : OcNOS : HSL :
NOTIF : [IF_PKT_ERRORS_4]: Oversized packets received on ge14 (1 packets)
2023-08-25T12:37:13+05:30 OcNOS HSL[4598]: 2023 Aug 25 12:37:13.610 : OcNOS : HSL :
NOTIF : [IF_PKT_ERRORS_4]: Oversized packets received on ge14 (1 packets)
2023-08-25T12:37:23+05:30 OcNOS HSL[4598]: 2023 Aug 25 12:37:23.610 : OcNOS : HSL :
NOTIF : [IF_PKT_ERRORS_4]: Oversized packets received on ge14 (1 packets)
2023-08-25T12:37:33+05:30 OcNOS HSL[4598]: 2023 Aug 25 12:37:33.610 : OcNOS : HSL :
NOTIF : [IF_PKT_ERRORS_4]: Oversized packets received on ge14 (1 packets)
2023-08-25T12:37:43+05:30 OcNOS HSL[4598]: 2023 Aug 25 12:37:43.611 : OcNOS : HSL :
NOTIF : [IF_PKT_ERRORS_4]: Oversized packets received on ge14 (1 packets)
2023-08-25T12:37:49+05:30 OcNOS sshd[11651]: Accepted password for ocnos from
192.168.230.131 port 57298 ssh2
2023-08-25T12:37:49+05:30 OcNOS sshd[11651]: pam_unix(sshd:session): session opened for
user ocnos by (uid=0)
2023-08-25T12:37:50+05:30 OcNOS sshd[11660]: Accepted password for ocnos from
192.168.230.131 port 57301 ssh2
2023-08-25T12:37:50+05:30 OcNOS sshd[11660]: pam_unix(sshd:session): session opened for
user ocnos by (uid=0)
2023-08-25T12:37:50+05:30 OcNOS CML[4875]: 2023 Aug 25 12:37:50.359 : OcNOS : CML : INFO
: [CML_5]: Client [cmlsh (/dev/pts/0)] established connection with CML server
2023-08-25T12:37:51+05:30 OcNOS CMLSH[11672]: 2023 Aug 25 12:37:51.214 : OcNOS : CMLSH :
CLI_HIST : User ocnos@/dev/pts/0 : CLI : terminal monitor
2023-08-25T12:37:53+05:30 OcNOS CMLSH[11672]: 2023 Aug 25 12:37:53.330 : OcNOS : CMLSH :
CLI_HIST : User ocnos@/dev/pts/0 : CLI : en *New User Login*
2023-08-25T12:37:53+05:30 OcNOS HSL[4598]: 2023 Aug 25 12:37:53.611 : OcNOS : HSL :
NOTIF : [IF_PKT_ERRORS_4]: Oversized packets received on ge14 (1 packets)
2023-08-25T12:37:55+05:30 OcNOS CMLSH[11672]: 2023 Aug 25 12:37:55.570 : OcNOS : CMLSH :
CLI_HIST : User ocnos@/dev/pts/0 : CLI : start-shell
2023-08-25T12:37:56+05:30 OcNOS PSERV[1595]: 2023 Aug 25 12:37:56.983 : OcNOS : PSERV :
DEBUG : Keep-Alive message sent to systemd
2023-08-25T12:37:58+05:30 OcNOS su: (to root) ocnos on pts/0
2023-08-25T12:37:58+05:30 OcNOS su: pam_unix(su-l:session): session opened for user
root by ocnos(uid=1000)
```

## Custom Syslog Port Configuration

---

```
2023-08-25T12:38:03+05:30 OcNOS HSL[4598]: 2023 Aug 25 12:38:03.611 : OcNOS : HSL :  
NOTIF : [IF_PKT_ERRORS_4]: Oversized packets received on ge14 (1 packets)  
2023-08-25T12:38:13+05:30 OcNOS HSL[4598]: 2023 Aug 25 12:38:13.611 : OcNOS : HSL :  
NOTIF : [IF_PKT_ERRORS_4]: Oversized packets received on ge14 (1 packets)  
2023-08-25T12:38:17+05:30 OcNOS PSERV[1595]: 2023 Aug 25 12:38:17.201 : OcNOS : PSERV :  
CRITI : Module: ospfd has closed connection with PSERVD.  
2023-08-25T12:38:17+05:30 OcNOS CML[4875]: 2023 Aug 25 12:38:17.204 : OcNOS : CML :  
CRITI : Module ospf disconnected with CML  
2023-08-25T12:38:18+05:30 OcNOS PSERV[1595]: 2023 Aug 25 12:38:18.229 : OcNOS : PSERV :  
INFO : Protocol pservd published protocol-module-down notification.  
2023-08-25T12:38:18+05:30 OcNOS PSERV[1595]: 2023 Aug 25 12:38:18.241 : OcNOS : PSERV :  
DEBUG : pserv SIGUER2 signal for module :ospfd  
2023-08-25T12:38:18+05:30 OcNOS PSERV[1595]: 2023 Aug 25 12:38:18.242 : OcNOS : PSERV :  
DEBUG : Crash Dump Directory not present  
2023-08-25T12:38:20+05:30 OcNOS NSM[4639]: 2023 Aug 25 12:38:20.110 : OcNOS : NSM :  
DEBUG : G8031 : nsm_g8031_sync : Sync PG info to ONMD  
2023-08-25T12:38:20+05:30 OcNOS PSERV[1595]: 2023 Aug 25 12:38:20.116 : OcNOS : PSERV :  
NOTIF : [WATCHDOG_PM_RECOVERED_4]: The module ospfd recovered from a critical error  
2023-08-25T12:38:20+05:30 OcNOS PSERV[1595]: Signal SIGUSR2 received and restarted  
module: ospfd  
2019 Jan 05 20:10:52.212 : OcNOS : OSPF : INFO : Interface lacp aggregator update flag 0
```



## CHAPTER 25 sFlow Configuration

This chapter provides the steps for configuring Sampled Flow (sFlow).

sFlow is the standard for monitoring high-speed switched and routed networks. The sFlow monitoring system consists of an sFlow Agent which is embedded in a switch or router and an sFlow Collector.

The sFlow agent samples packets as well as polling traffic statistics for the device it is monitoring. The packet sampling is performed by the switching/routing device at wire speed. The sFlow agent forwards the sampled traffic statistics in sFlow PDUs as well as sampled packets to an sFlow collector for analysis.

Note: sFlow egress sampling for multicast, broadcast, or unknown unicast packets is not supported.

The sFlow agent uses the following forms of sampling:

- Sampling packets: samples one packet out of a defined sampling rate. This sampling is done by hardware at wire speed.
- Sampling counters: polls interface statistics such as generic and Ethernet counters at a defined interval.

You must enable the sFlow feature and collector before enabling sFlow sampling on an interface.

You cannot globally enable sFlow sampling monitoring on all interfaces with a single command. Instead you must enable sFlow sampling on the required interfaces individually.

sFlow feature is supported on physical interface as well as LAG interface. Configuring sampling on a LAG interface will enable the same on all member ports part of that LAG interface.

Note: When sflow sampling is in-progress on high rate, CPU usage spike messages from Chassis monitoring module (cmmd) is expected.

Note: Qumran-1 (Q1) platform supports sflow ingress sampling on 5 interfaces and egress sampling on 4 interfaces.

Note: Qumran-2 (Q2) platform supports sflow ingress sampling on 8 interfaces and egress sampling on 3 interfaces.

### Topology

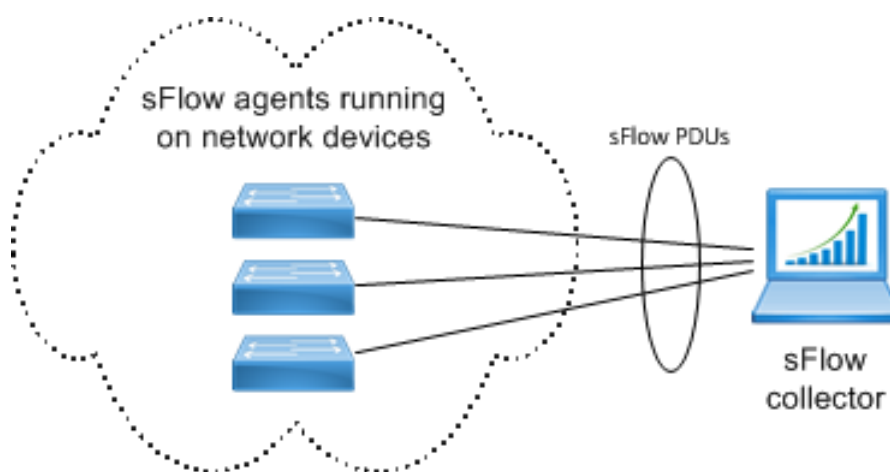

Figure 25-51: Basic sFlow topology

## Configuration

### sFlow Agent

#configure terminal	Enter configure mode.
(config)#feature sflow	Enable the sFlow feature.
(config)#sflow collector 2.2.2.2 port 6343 receiver-time-out 0 max-datagram-size 200	Configure the sFlow collector. The IP address must be reachable via the management VRF.
(config)#interface xe1	Enter interface mode
(config-if)#sflow poll-interval 5	Set the counter poll Interval on the interface.
(config-if)#sflow sampling-rate 1024 direction ingress max-header-size 200	Set the sFlow sampling interval on the interface in ingress directions.
(config-if)#sflow sampling-rate 1024 direction egress max-header-size 120	Set the sFlow sampling interval on the interface in egress directions.
(config-if)#sflow enable	Start packet sampling on the interface
(config-if)#commit	Commit the candidate configuration to the running configuration
(config-if)#end	Exit interface and configure mode.

### Validation

```
#show sflow detail
sFlow Feature: Enabled
sFlow Version: 5
sFlow Global Information :
Agent      IP: 10.10.26.132
Collector IP: 2.2.2.2      Port: 6343
Maximum Datagram Size(bytes): 200
Receiver timeout(sec)      : 0
```

sFlow Port Detailed Information:

Interface	Packet-Sampling		Packet-Sampling		Counter-Interval
	Maximum Header	Rate	Count	Count	
Count	Size(bytes)		Ingress	Egress	(sec)
Ingress	Ingress	Egress	Ingress	Egress	
	Egress				
xe1/1	1024	1024	464564	414532	5
131	120	20			

## CHAPTER 26 Trigger Failover Configuration

This chapter contains Trigger Failover (TFO) configuration examples.

This example shows the complete configuration to enable TFO in a simple network topology. TFO complements NIC teaming functionality supported on blade servers. TFO allows a switch module to monitor specific uplink ports to detect link failures. When the switch module detects a link failure, it disables the corresponding downlink ports automatically.

TFO uses these components:

- A Fail Over Group (FOG) contains a Monitor Port Group (MPG) and a Control Port Group (CPG).
- An MPG contains only uplink ports.
- A CPG contains only downlink ports.

Note:

- TFO is supported in STP or RSTP bridge mode.
- TFO can be configured on a LAG interface.

### Basic Configuration



Figure 26-52: Basic topology

#### Switch

#configure terminal	Enter configure mode.
(config)#tfo enable	Enable TFO globally.
(config)#fog 1 enable	Create a Fail over group (FOG) and enable it.
(config)#interface xe35	Enter interface mode
(config-if)#link-type uplink	Specify the link-type as Uplink.
(config-if)#fog 1 type mpg	Specify the MPG member for FOG 1.
(config-if)#exit	Exit interface mode
(config)#commit	Commit the candidate configuration to the running configuration
(config)#interface xe34	Enter interface mode
(config-if)#link-type downlink	Specify the link-type as Downlink.
(config-if)#fog 1 type cpg	Specify the CPG member for FOG 1.
(config-if)#commit	Commit the candidate configuration to the running configuration
(config-if)#end	Exit interface and configure mode

## Validation

```
#show tfo

TFO : Enable

Failover Group 1 : Enable
Failover Status : MPG Link Failure
No. of links to trigger failover : 0
MPG Port(s) :
xe35    Status : DOWN
CPG Port :
xe34    Status : DOWN
No. of times MPG link failure : 1
No. of times MPG link recovered : 0
No. of times CPG got auto disabled : 1
No. of times CPG got auto enable : 0
```

## Port-Channel Configuration

### Topology

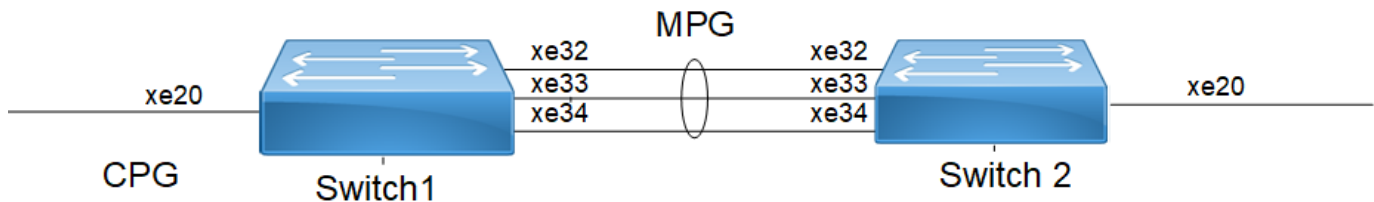

Figure 26-53: TFO with port-channel

### Switch 1

#configure terminal	Enter configure mode.
(config)#tfo enable	Enable TFO globally.
(config)#fog 1 enable	Create a Fail over group (FOG) and enable it.
(config)#interface po1	Enter interface mode
(config-if)#switchport	Make the interface Layer2.
(config-if)#exit	Exit interface mode
(config)#commit	Commit the candidate configuration to the running configuration
(config)#interface xe32	Enter interface mode
(config-if)#switchport	Make the interface Layer2.
(config-if)#link-type uplink	Specify the link-type as Uplink.
(config-if)#exit	Exit interface mode
(config)#commit	Commit the candidate configuration to the running configuration

(config)#interface xe33	Enter interface mode
(config-if)#switchport	Make the interface as Layer2.
(config-if)#link-type uplink	Specify the link-type as Uplink.
(config-if)#channel-group 1 mode active	Specify the channel group in interface
(config-if)#exit	Exit interface mode
(config)#commit	Commit the candidate configuration to the running configuration
(config)#interface xe34	Enter interface mode
(config-if)#switchport	Make the interface as Layer2.
(config-if)#link-type uplink	Specify the link-type as Uplink.
(config-if)#channel-group 1 mode active	Specify the channel group in interface
(config-if)#exit	Exit interface mode
(config)#commit	Commit the candidate configuration to the running configuration
(config)#interface xe20	Enter interface mode
(config-if)#link-type downlink	Specify the link-type as Downlink.
(config-if)#fog 1 type cpq	Specify the CPG member for FOG 1
(config-if)#exit	Exit interface mode
(config)#commit	Commit the candidate configuration to the running configuration
(config)#interface po1	Enter port-channel mode
(config-if)#link-type uplink	Specify the link-type as Uplink.
(config-if)#fog 1 type mpg	Specify the MPG member for FOG 1.
(config-if)#commit	Commit the candidate configuration to the running configuration
(config-if)#end	Exit interface and configure mode

## Switch 2

#configure terminal	Enter configure mode.
(config)#interface po1	Enter interface mode
(config-if)#switchport	Make the interface as Layer2.
(config-if)#exit	Exit interface mode
(config-if)#commit	Commit the candidate configuration to the running configuration
(config)#interface xe32	Enter interface mode
(config-if)#switchport	Make the interface as Layer2.
(config-if)#channel-group 1 mode active	Specify the channel group in interface
(config-if)#exit	Exit interface mode
(config-if)#commit	Commit the candidate configuration to the running configuration
(config)#interface xe33	Enter interface mode
(config-if)#switchport	Make the interface as Layer2.

## Trigger Failover Configuration

---

(config-if)#channel-group 1 mode active	Specify the channel group in interface
(config-if)#exit	Exit interface mode
(config)#commit	Commit the candidate configuration to the running configuration
(config)#interface xe34	Enter interface mode
(config-if)#switchport	Make the interface as Layer2
(config-if)#channel-group 1 mode active	Specify the channel group in interface
(config-if)#exit	Exit interface mode
(config)#commit	Commit the candidate configuration to the running configuration

---

## Validation

```
#show interface brief | include up
xe20      ETH    --    --          up      none    10g    --
xe32      ETH    --    --          up      none    10g    --
xe33      ETH    --    --          up      none    10g    --
xe34      ETH    --    --          up      none    10g    --
eth0      METH                   up      --      100m
lo
lo.management                   up      --
```

```
#show tfo
```

```
TFO : Enable
```

```
Failover Group 1 : Enable
Failover Status : MPG Link Failure
No. of links to trigger failover : 0
MPG Port(s) :
po1  Status : DOWN
CPG Port :
xe20  Status : DOWN
No. of times MPG link failure : 0
No. of times MPG link recovered : 0
No. of times CPG got auto disabled : 0
No. of times CPG got auto enable : 0
```

---

## CHAPTER 27 Show Tech Support Configurations

---

---

### Overview

OcNOS maintains a collection of consolidated information about system configurations and statistics. This information is for debugging and diagnosing system issues.

Note: Output is displayed on the terminal.

---

### Tech Support Samples

<pre>#show techsupport all</pre>	Collects system configurations and statistics for all modules.
----------------------------------	--





## CHAPTER 28 Software Monitoring and Reporting

### Overview

OcNOS provides a mechanism (called “watchdogging”) to monitor all OcNOS modules and provides the following functions.

1. Periodic heart beat check.
2. Automatic restarts of a module upon a hung state or crash detection.
3. Upon hanging or crashing of a module, a crash report (including system states) is logged.
4. A proprietary SNMP trap is sent to the trap manager, if configured, after a fault is detected in a protocol module. Similarly a trap is sent when the module recovers.

By default, the software watchdog is enabled and the keep-alive time interval is 6s0 seconds. All OcNOS processes periodically send keep-alive messages to a monitoring module at the configured keep-alive time interval.

This functionality can be disabled for a particular module or all OcNOS modules by using CLI commands. In order to permanently disable software monitoring functionality, the user has to disable the watchdog feature. If, however, software watchdogging is disabled the monitoring module doesn't take any action upon a hang or crash of any OcNOS module.

### Software Monitoring

#configure terminal	Enter Configure mode.
(config)#feature software-watchdog	Enable software watchdog for all OcNOS modules — This is the default.
(config)#no software-watchdog imi	To disable software watchdog for only imi modules.
(config)#software-watchdog keep-alive-time 100	The keep-alive time interval in seconds. Default is 60 seconds and applies to all OcNOS modules.
(config)#show software-watchdog status	Display the keep-alive time interval and list of OcNOS process names with watchdog status for each OcNOS modules.
(config)#commit	Commit the candidate configuration to the running configuration
(config)#exit	Exit configuration

### Validation

```
#show software-watchdog status
Software Watchdog timeout in seconds : 100
Process name           Watchdog status
=====
nsm                     Enabled
ripd                   Enabled
ospfd                  Enabled
isis                   Enabled
```

hostpd	Enabled
ldpd	Enabled
rsvpd	Enabled
mribd	Enabled
pimd	Enabled
authd	Enabled
mstpd	Enabled
imi	Disabled
onmd	Enabled
HSL	Enabled
oam	Enabled
vlogd	Enabled
vrrpd	Enabled
ndd	Enabled
ribd	Enabled
bgpd	Enabled
l2mribd	Enabled
lagd	Enabled
sflow	Enabled

## CHAPTER 29 Control Plane Policing Configuration

Control plane policing (CoPP) manages the traffic flow destined to the host router CPU for control plane processing. CoPP limits the traffic forwarded to the host CPU and avoids impact on system performance.

1. CoPP has organized handling of control packets by providing per-protocol hardware CPU queues. So, control packets are queued in different CPU queues based on protocol.
2. Per-protocol CPU queue rate limits and buffer allocations are programmed during router initialization, thus every CPU queue is rate-limited to a default stable and balanced behavior across protocols.
3. When control packets received at higher rate than the programmed rate, the excess traffic is dropped at queue level in the packet processor hardware itself.
4. OcNOS does not support per-queue rate modification and usage monitoring.
5. All CPU queues are pre-programmed with default rate limits and buffer allocations to ensure a default stable and balanced behavior across protocols.
6. Rate limits are in terms of kbps. Hardware does not support PPS (packets per second).
7. Qumran (MX, AX, and UX) supports per-queue rate shaping configuration within a range of 469 kbps to 483 gbps. The granularity is 469 kbps for low range and 1.56% for higher range.

**Table 29-2: Default CPU queues**

Default queues	Default rate In kbps	Maximum configurable rate in kbps	Default queue length In kbytes	Description
CPU0.q0	900	900	1024	Unclassified protocols and unknown or destination lookup failure packets are redirected to default CPU queues 0-7 based on packet's cos/dscp values.  SSH, TELNET and SNMP traffic destined to host router CPU is remarked to CPU0.q6.  SSH: TCP Source/Destination port 22 TELNET: TCP Source/Destination port 23 SNMP: UDP Source/Destination port 161/162
CPU0.q1	900	900	1024	
CPU0.q2	900	900	1024	
CPU0.q3	900	900	1024	
CPU0.q4	900	900	1024	
CPU0.q5	900	900	1024	
CPU0.q6	900	900	1024	
CPU0.q7	900	900	1024	
CPU1.q0	900	900	1024	
CPU1.q1	900	900	1024	
CPU1.q2	900	900	1024	
CPU1.q3	900	900	1024	
CPU1.q4	900	900	1024	
CPU1.q5	900	900	1024	
CPU1.q6	900	900	1024	
CPU1.q7	900	900	1024	

\*cpu1 is valid only for QMX

**Table 29-3: Per protocol CPU queues**

Protocol queues	Default rate in kbps	Maximum configurable Rate in kbps	Default queue length in kbytes	Description
IGMP	1000	1000	2048	Internet Group Management Protocol packets (IP protocol 2)
ISIS/ISIS	8000	8000	1024	ISIS (DMAC 0180:C200:0014/0015) ISIS (DMAC 0900:2B00:0004/0005) Note: ISIS = End System-to-Intermediate System (ISIS point-to-point case)
Reserved Mcast	8000	8000	2048	Reserved IPv4 and IPv6 Multicast packets IPv4: Local Network Control Block (224.0.0.0 - 224.0.0.255 (224.0.0/24)) IPv6: Link-Local Scope Multicast Addresses (FF02::/8)
IPv6 Link Local	1000	1000	1024	IPv6 link local packets DIPv6: FE80::/8
ospf	8000	8000	1024	OSPF unicast packets (IP protocol 89)
bgp	8000	8000	1024	BGP packets TCP source/destination port number: 179
rsvp/ldp	2000	2000	1024	RSVP and LDP packets RSVP: IP protocol 46 LDP: L4 source/destination port number:646
vrrp/rip/dhcp	8000	8000	1024	VRRP packets: IP protocol number 112 RIP packets: UDP source and destination port number: 520 RIPNG packets: UDP source and destination port number: 521 DHCP: DHCP v4/v6 server packets, DHCP v4/v6 client packets (L4 source/destination port number: 67 or 68)
pim	1000	1000	1024	Protocol Independent Multicast packets: IP protocol number 103
icmp	1000	1000	1024	ICMP packets: IP protocol number 1 Unicast ICMPv6 packets: IP next header number 58
arp	1000	1000	1024	ARP packets. Ether-type 0x0806
bpdu	1000	1000	1024	xSTP: DMAC 0180:C200:0000 Provider Bridging: 0180:C200:0008 LACP: DMAC 0180:C200:0002, ethertype:0x8809, subtype:1/2 AUTHD: DMAC 0180:C200:0003 LLDP: DMAC 0180:C200:000E EFM: DMAC 0180:C200:0002, ethertype:0x8809, subtype:3 ELMI: DMAC 0180:C200:0007 SYNCE: DMAC 0180:C200:0002, ethertype:0x8809, subtype:0x0A RPVST: DMAC 0100:0CCC:CCCD L2TP: DMAC 0100:C2CD:CDD0/0104:DFCD:CDD0 G8032: DMAC 0119:A700:00XX

**Table 29-3: Per protocol CPU queues (Continued)**

<b>Protocol queues</b>	<b>Default rate In kbps</b>	<b>Maximum configurable Rate in kbps</b>	<b>Default queue length In kbytes</b>	<b>Description</b>
bfd	16384	16384	1024	BFD Single hop packets: UDP port 3784, TTL 255 BFD Multi hop packets: UDP port 4784 Micro BFD packets: UDP port 6784, TTL 255
sflow	1500	1500	1024	Ingress and Egress sampled packets
dsp	500	500	76800	L2 FDB events
vxlan	500	500	1024	ARP and ND cache queue for packets coming on VXLAN access ports.
nhop	400	400	1024	Inter VRF route leak unresolved data packets for ARP resolution.
icmp-redirect	1000	1000	256	Data packets to CPU for ICMP redirect packet generation.



## CHAPTER 30 Internet Protocol SLA Configuration

Internet Protocol Service Level Agreement (IP SLA) is an active method of monitoring and reliably reporting on network performance. By “active,” I refer to the fact that IP SLA will generate and actively monitor traffic continuously across the network. An IP SLA Router is capable of generating traffic and reporting on it in real time

IP SLA can be configured in two parts. There is the IP SLA router, which generates the traffic, and the IP SLA Responder (which can be any device, not just a router). The IP SLA Responder is not required for IP SLA to function, but it does allow for more detailed information gathering and reporting.

After an IP SLAs operation has been configured, you must schedule the operation to begin capturing statistics and collecting error information. When scheduling an operation, it can start immediately or start at a certain month, day, and hour. There is a pending option to set the operation to start at a later time. The pending option is also an internal state of the operation visible through SNMP. The pending state is also used when an operation is a reaction (threshold) operation waiting to be triggered. You can schedule a single ip slas operation or a group of operations at one time.

Note: IP SLA sessions are scaled to 500 sessions on Edgecore AS7316-26XB switches. This limit may vary on other devices based on the device capacity and performance.

### Topology



Figure 30-54: IP SLA Topology

### Configuration

#### Configure IP Address

Configure the IP addresses on the PE-1, P routers.

##### PE-1

#configure terminal	Enter configure mode.
(config)#interface xe1	Specify the interface (xe1) to be configured.
(config-if)#ip address 10.1.1.1/24	Set the IP address of the interface to 10.1.1.1/24.
(config-if)#exit	Exit interface mode.
(config)#commit	Commit the candidate configuration to the running configuration

##### P

#configure terminal	Enter configure mode.
(config)#interface xe1	Specify the interface (xe1) to be configured.
(config-if)#ip address 10.1.1.2/24	Set the IP address of the interface to 10.1.1.2/24.

(config-if)#exit	Exit interface mode.
(config)#commit	Commit the candidate configuration to the running configuration

## Configure IP SLA Configurations on PE 1 router

### PE-1

#configure terminal	Enter configure mode.
(config)#ip sla <1-65535>	configure IP SLA with a unique no
(config-ip-sla)# icmp-echo ipv4<destination IP> source-interface <interface name>	configure the icmp-echo using destination Ip Address and source interface name
(config-ip-sla-echo)#threshold <1000-60000>	Configure the threshold value
(config-ip-sla-echo)#timeout <1000-60000>	Configure the Timeout value
(config-ip-sla-echo)#frequency <1-60>	Configure the frequency value
(config-ip-sla-echo)#exit	Exit icmp-echo mode
(config-ip-sla)#exit	Exit from IP SLA mode
(config)#commit	Commit the candidate configuration to the running configuration
(config)#time-range <1-60 characters>	configure a time-range
(config-tr)#start-time 11:22 3 july 2021	configure a start-time
(config-tr)#end-time after 200	Configure end-time
(config-tr)#frequency hourly	configure frequency
(config-tr)#exit	exit from time-range
(config)#ip sla schedule <1-65535> time-range echo_schedule	Schedule a IP SLA measurement
(config)#commit	Commit the candidate configuration to the running configuration

## Validation

### PE-1

```
#sh running-config ip sla
ip sla 1
 icmp-echo ipv4 10.1.1.2 source-interface xel
  frequency 6
  threshold 50000
  timeout 55000
ip sla schedule 1 time-range tr1
#sh running-config time-range
!
time-range tr1
 start-time 05:00 21 september 2021
 end-time 06:40 21 september 2021
```



```
#ping 10.1.1.2
Press CTRL+C to exit
PING 10.1.1.2 (10.1.1.2) 56(84) bytes of data.
64 bytes from 10.1.1.2: icmp_seq=1 ttl=64 time=0.436 ms
1 packets transmitted, 1 received, 0% packet loss, time 0ms
#sh ip sla summary
IP SLA Operation Summary
Codes: * active, ^ inactive
```

ID	Type	Destination	Stats	Return (usec)	Last Code	Run
*1	icmp-echo	10.1.1.2	2000	OK	2021 Sep 21	05:01:00

```
#sh ip sla statistics 1 detail
```

```
=====
                IP SLA Statistics
=====
IP SLA ID           : 1
Start Time          : 2021 Sep 21 05:00:00
Elapsed time(milli sec) : 25003
Packets Sent        : 5
Packets Received    : 5
Packet Loss(%)      : 0.0000
Invalid Tests       : 0
Round Trip Delay(usec)
  Minimum           : 1000
  Maximum           : 1000
  Average           : 800
```



## CHAPTER 31 Link Detection Debounce Timer

The link debounce timer avoids frequent updates (churn) to higher layer protocols during flapping of an interface. The initial link state is UP. The link goes DOWN. If the Link comes UP and goes DOWN, The link DOWN AND link UP timer is started and being restarted on each flap (link comes up and goes down again). For each link DOWN, link down timer will start and it restarts on flap within the link debounce interval. For each link UP, link up timer will start and it restarts on flap within the link debounce interval

Note: Keep the following in mind when using the Link detection debounce timer:

- Link debounce timer is supported only for physical L2 and L3 interfaces.
- When debounce timer is configured we won't be able to configure the link-debounce-timer config and viceversa.
- The link debounce flap-count refers to the number of flaps OcnOS receives while the debounce timer is running:
  - The flap-count is only updated if the timer is still running and OcnOS receives a link status event for the interface.
  - The flap-count is reset at the subsequent start of the link debounce timer.
- Protocol-specific timers such as BFD which depend on the link status should be configured to minimum of 1.5 times the value of the link-debounce time. Otherwise it could affect the protocol states if the link debounce timer is still running.
- Protocols such as PO, OSPF, BFD, ISIS, BGP which depends on the link status, in this case we should ensure on both the connected interfaces we need to configure the link-debounce timer.

### Topology

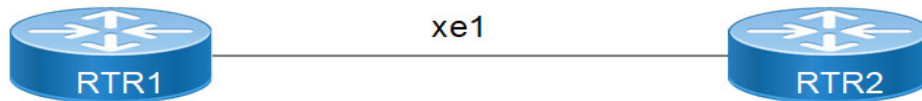

Figure 31-55: Link detection debounce timer topology

### Configuration

#### RTR1

#configure terminal	Enter configure mode.
(config)#interface xe1	Enter interface mode
(config-if)#link-debounce-time 4000 5000	Configure link-debounce-time where link-up timer is 4000 ms and link-down timer is 5000 ms
(config-if)#commit	Commit the candidate configuration to the running configuration
(config-if)#exit	Exit interface mode

#### RTR2

#configure terminal	Enter configure mode.
(config)#interface xe1	Enter interface mode

## Link Detection Debounce Timer

---

(config-if)#link-debounce-time 4000 5000	Configure link-debounce-time where link-up timer is 4000 ms and link-down timer is 5000 ms
(config-if)#commit	Commit the candidate configuration to the running configuration
(config-if)#exit	Exit interface mode

---

## Validation

```
#show interface xel | i Debounce Link Debounce timer: enable
  Linkup Debounce time 4000 ms Linkdown Debounce time 5000 ms
  Linkup Debounce status : idle
  Linkdown Debounce status : idle
```

### RTR1 and RTR2 outputs after interface flap:

```
#show interface xel | i debounce Link Debounce timer: enable
Linkup Debounce time 4000 ms Linkdown Debounce time 5000 ms
Flap Count: 1
Last Debounce Flap :
Linkup Debounce status : idle
Linkdown Debounce status : idle
```

```
#show interface xel | i debounce
  Link Debounce timer: enable
  Linkup Debounce time 4000 ms Linkdown Debounce time 5000 ms
  Flap Count: 1
  Last Debounce Flap :      Linkup Debounce status : idle
  Linkdown Debounce status : idle
```

---

## Log Messages

The following is a configuration example to log link debounce timer activity

:

---

#configure terminal	Enter Configure mode
(config)#logging level nsm 7	Enable operational log to display debounce start and end.

---

## Example Log Messages

```
2019 Feb 28 02:50:40.761 : OcNOS : NSM : INFO : Start UP->DOWN Link Debounce Timer on
interface xel
2019 Feb 28 02:50:40.761 : OcNOS : NSM : NOTIF : [DEBOUNCE_EVENT_4]: Interface xel
changed state from up to down
2019 Feb 28 02:50:43.543 : OcNOS : NSM : INFO : Start DOWN->UP Link Debounce Timer on
interface xel
2019 Feb 28 02:50:43.543 : OcNOS : NSM : INFO : Interface xel Flapped, prev_state DOWN
new_state UP,flap count 1
2019 Feb 28 02:50:43.543 : OcNOS : NSM : NOTIF : [DEBOUNCE_EVENT_4]: Interface xel
changed state from down to up
2019 Feb 28 02:50:45.761 : OcNOS : NSM : INFO : Link Debounce Timer Expired on interface
xel (initiated transition up->down), prev_state UP, new_state UP
```

2019 Feb 28 02:50:47.544 : OcNOS : NSM : INFO : Link Debounce Timer Expired on interface  
xe1 (initiated transition down->up), prev\_state UP, new\_state UP



## CHAPTER 32 Max Session and Session Limit Configuration

### Overview

User can configure session-limit for Telnet and SSH sessions separately but this max-session parameter value takes the precedence to restrict the maximum number of sessions. If user configured this max-session to be 4, then the device would allow only maximum of 4 SSH and Telnet sessions collectively irrespective of the individual SSH and Telnet max-session configuration. Active sessions won't be disturbed even if the configured max-session limit is lesser than the current active sessions. Default value for max-session value is 40 in line mode. There is no default value for the telnet-server-limit and ssh-server-limit.

After configuring max-session parameter if user tries to configure SSH/Telnet sessions then the total value of Telnet and SSH session limit should be lesser than the max-session value otherwise error will be thrown.

If already Telnet and SSH session-limits configured, now if user is configuring max-session then there won't be any error but maximum number of sessions will be limited to max-session value.

### Topology

The procedures in this section use the topology as mentioned below. Setup consists of one node acting as Telnet server.

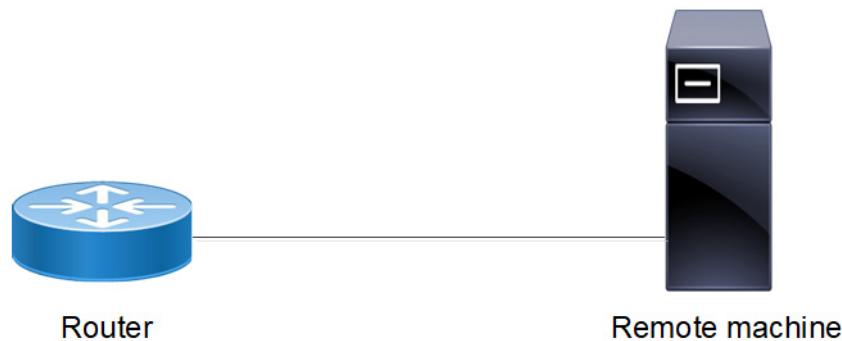

Figure 32-56: Telnet topology

### Configuration of Telnet Session Limit Lesser than Max-Session

#configure terminal	Enter configure mode
(config)#no feature telnet vrf management	Disable Feature Telnet in VRF Management
(config)#telnet server session-limit 12 vrf management	Configure the Session limit as 12 which is less than Max-Session parameter in line VTY
(config)#commit	Perform commit to submit the changes done
(config)#feature telnet vrf management	Enable telnet feature in VRF management
(config)#commit	Perform commit to submit the changes done
(config)#exit	Exit configure mode

## Validation

Check that the maximum telnet session possible are 12 which is lesser than Max-Session limit parameter value in line VTY.

```
#show running-config telnet server
telnet server session-limit 12 vrf management
feature telnet vrf management
no feature telnet
```

---

## Configuration of SSH Server Session Limit Lesser than Max-Session

Configure SSH Server Session limit to be lesser than Max-Session.

---

## Topology

Setup consists of one node acting as SSH server.

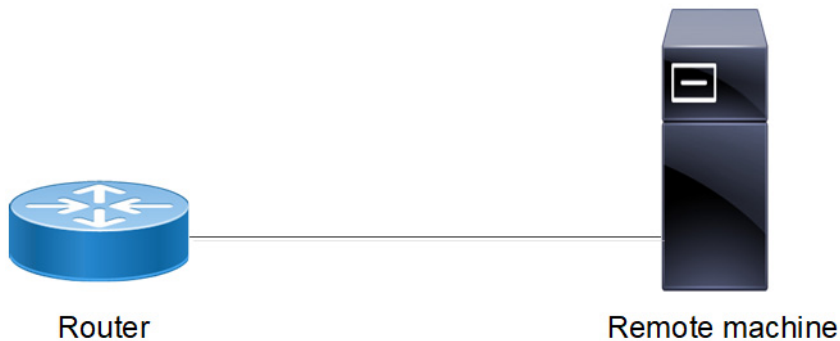

Figure 32-57: SSH Server topology

## Configuration of SSH Server Session Limit Lesser than Max-Session

#configure terminal	Enter configure mode
(config)#no feature ssh vrf management	Disable feature SSH
(config)#ssh server session-limit 12 vrf management	Configure SSH server session-limit to be lesser than Max-Session limit
(config)#commit	Perform Commit to submit changes done
(config)#feature ssh vrf management	Enable feature SSH
(config)#commit	Perform commit to submit changes
(config)#exit	Exit configure mode

## Validation

Check that the maximum SSH session possible are 12 which is lesser than Max-Session limit parameter value in line VTY.

```
#show running-config ssh server
feature ssh vrf management
ssh server session-limit 12 vrf management
```



```
no feature ssh
```

## Configuration of Telnet Session Limit Greater than Max-Session

In the below section, configure Telnet Session limit to be greater than Max-Session limit.

### Topology

Setup consists of one node acting as Telnet server.

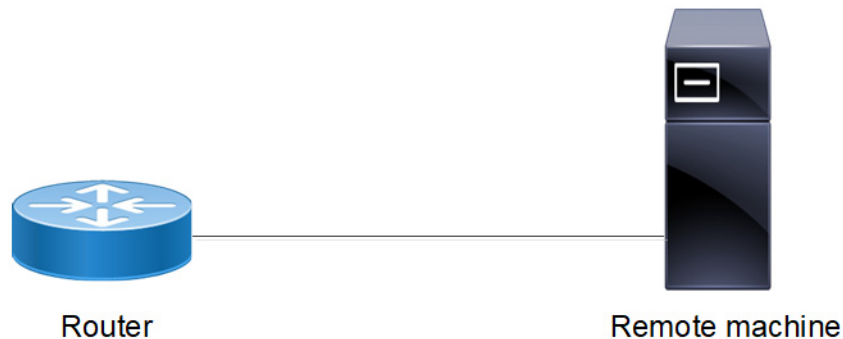

Figure 32-58: Telnet Session Topology

### Configuration of Telnet server Session-Limit to be greater than line-VTY max-session

#configure terminal	Enter configure mode
(config)#no feature telnet vrf management	Disable feature telnet
(config)#telnet server session-limit 12 vrf management	Configure Session-limit as 12 for telnet server
(config)#commit	Perform commit to submit changes
(config)#feature telnet vrf management	Enable Telnet server
(config)#commit	Perform commit to submit changes
(config)#line vty	Enter line VTY mode
(config-line)#max-session 10	Configure max-session as 10
(config-line)#commit	Perform commit to submit changes
(config)#exit	Exit configure mode

### Validation

Check that the total telnet sessions possible is 10 even though telnet server session limit is configured as 12.

```
#show running-config telnet server
telnet server session-limit 12 vrf management
feature telnet vrf management
no feature telnet

#show running-config | grep max-session
max-session 10
```

---

## Configuration of SSH Session Limit Greater than Max-Session

In the below section, configure SSH Session limit to be greater than Max-Session limit.

---

### Topology

Setup consists of one node acting as SSH server.



### Configuration of SSH server Session-Limit to be greater than line-vty max-session

#configure terminal	Enter configure mode
(config)#no feature ssh vrf management	Disable feature SSH
(config)#ssh server session-limit 12 vrf management	Configure Session-limit as 12 for SSH server
(config)#commit	Perform commit to submit changes
(config)#feature ssh vrf management	Enable SSH server
(config)#commit	Perform commit to submit changes
(config)#line vty	Enter line VTY mode
(config-line)#max-session 10	Configure max-session as 10
(config-line)#commit	Perform commit to submit changes
(config)#exit	Exit configure mode

### Validation

Check that the total SSH sessions possible is 10 even though SSH server session limit is configured as 12.

```
#show running-config ssh server
feature ssh vrf management
ssh server session-limit 12 vrf management
no feature ssh
```

```
#show running-config | grep max-session
max-session 10
```

## CHAPTER 33 Ethernet Interface Loopback Support

### Overview

This feature support is to provide additional hardware diagnostic functionality for physical ports on boards. This feature will enable the user to determine if there are any issues in the physical port at the MAC and the PHY layer.

To achieve this functionality, the Ethernet interfaces can be configured as the loopback interfaces. Looping back the packets are possible either at MAC layer or at PHY layer. Also packets can be looped either from Egress to Ingress or Ingress to Egress. On enabling this feature, if all the TX packets are looped back to RX, it indicates there is no issue with the hardware at the particular layer configured, either MAC or PHY.

### Local Loopback

#### Tx PHY Loopback

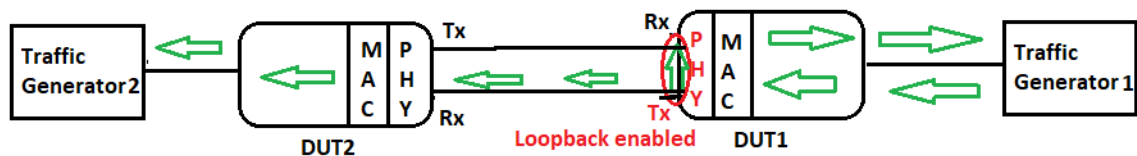

When the loopback Tx PHY is enabled on an Ethernet interface, packets that the traffic generator receives on such an interface are loop-backed to the originator and forwarded to the destination.

Because loopback is enabled as the Tx PHY in the diagram above, packets will loop at the physical layer, and the same number of packets will be returned to the traffic generator from the DUT's Egress to Ingress side. Thus, the Tx and Rx counts of receiving and transmitting interfaces are the same. The packets are looped and also forwarded to their next destination.

#### Tx MAC Loopback

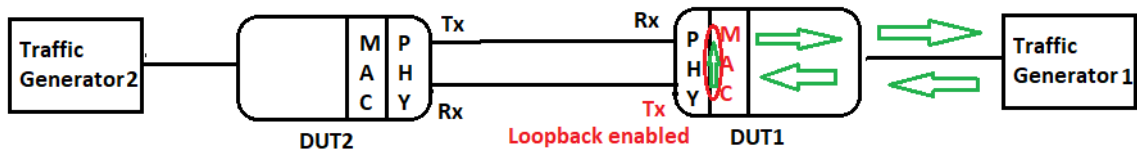

Loopback Tx MAC is enabled on the Ethernet interface, and when packets from the traffic generator arrive on such an interface, they are loop-backed to the originator rather than being forwarded.

In the above diagram, as loopback is enabled as a Tx MAC, the packets will loop at the MAC layer (data link layer), and the same number of packets are returned from the egress side to the ingress side of the DUT to the traffic generator. Thus, the Tx and Rx counts of receiving and transmitting interfaces are the same. The packets are looped but not forwarded further.

## Remote Loopback

### Rx PHY Loopback

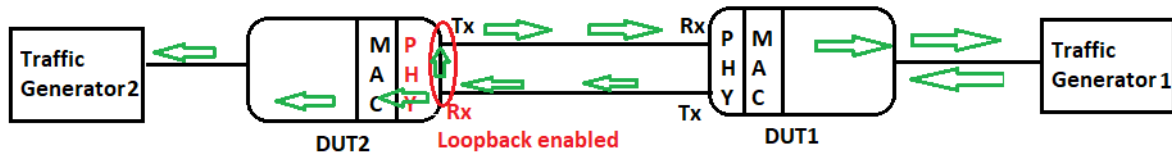

Loopback Rx PHY is enabled on the ethernet interface, and when packets from the traffic generator arrive at a remote node via such an interface, they are loop-backed to the originator and forwarded to the next route.

In the above diagram, as loopback is enabled as Rx PHY on DUT2, the packets will loop at the physical layer of the DUT2, and the same number of packets are returned from the ingress to the egress side of the DUT2 to DUT1 and the traffic generator. Thus, the Tx and Rx counts of receiving and transmitting interfaces are the same. The packets are looped back to Traffic Generator1 as well as forwarded to Traffic Generator2.

### Rx MAC Loopback

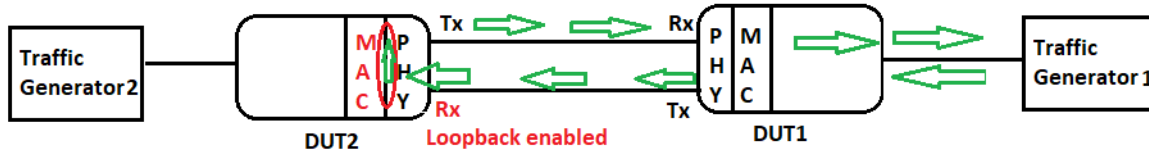

Loopback Rx MAC is enabled on the ethernet interface, and when packets from the traffic generator arrive at a remote node via such an interface, they are loop-backed to the originator but not forwarded to the next route.

In the above diagram, as loopback is enabled as Rx MAC on DUT2, the packets will loop at the MAC layer (data link layer) of the DUT2, and the same number of packets are returned from the ingress to the egress side of the DUT2 to DUT1 and the traffic generator. Thus, the Tx and Rx counts of receiving and transmitting interfaces are the same. The packets are looped back to Traffic Generator1, but not forwarded to Traffic Generator2.

## Topology



Figure 33-59: Loopback configuration nodes

## Configurations

### R1

#configure terminal	Enter into the configure terminal mode.
R1(config)#hostname R1	Configure the hostname
R1(config)#commit	Commit the configuration
R1(config)#bridge 1 protocol rstp vlan-bridge	Configure bridge
R1(config)#vlan database	Enter into vlan database
R1(config-vlan)#vlan 2 bridge 1	Configure vlans
R1(config-vlan)#exit	Exit the vlan database mode
R1(config)#interface ce1/1	Enter into interface ce1/1
R1(config-if)#switchport	Configure switchport
R1(config-if)#bridge-group 1	Configure bridge-group
R1(config-if)#switchport mode trunk	Configure switchport mode as trunk
R1(config-if)#switchport trunk allowed vlan add 2	Add all the vlans to the interface
R1(config-if)#exit	Exit the interface mode
R1(config)#interface ce5/1	Enter into interface ce1/1
R1(config-if)#switchport	Configure switchport
R1(config-if)#bridge-group 1	Configure bridge-group
R1(config-if)#switchport mode trunk	Configure switchport mode as trunk
R1(config-if)#switchport trunk allowed vlan add 2	Add all the vlans to the interface
R1(config-if)#loopback tx phy	Configure loopback tx phy
R1(config-if)#exit	Exit the interface level
R1(config)#no mac-address-table learning bridge 1 interface ce1/1	Disable the mac-learning on the device
R1(config)#no mac-address-table learning bridge 1 interface ce5/1	Disable the mac-learning on the device
R1(config)#commit	Commit the configuration
R1(config)#exit	Exit from configuration mode

### R2

#configure terminal	Enter into the configure terminal mode.
R2(config)#hostname R2	Configure the hostname
R2(config)#commit	Commit the configuration
R2(config)#exit	Come out of configuration mode

R2#conf terminal	Enter into the configure terminal mode
R2(config)#bridge 1 protocol rstp vlan-bridge	Configure bridge
R2(config)#vlan database	Enter into vlan database
R2(config-vlan)#vlan 2 bridge 1	Configure vlans
R2(config-vlan)#exit	Exit the vlan database mode
R2(config)#interface ce3/1	Enter into interface ce3/1
R2(config-if)#switchport	Configure switchport
R2(config-if)#bridge-group 1	Configure bridge-group
R2(config-if)#switchport mode trunk	Configure switchport mode as trunk
R2(config-if)#switchport trunk allowed vlan add 2	Add the vlan to the interface
R2(config-if)#exit	Exit the interface mode
R2(config-if)#interface ce29/1	Enter into interface ce29/1
R2(config-if)#switchport	Configure switchport
R2(config-if)#bridge-group 1	Configure bridge-group
R2(config-if)#switchport mode trunk	Configure switchport mode as trunk
R2(config-if)#switchport trunk allowed vlan add 2	Add the vlan to the interface
R2(config-if)#exit	Exit from interface level
R2(config)#no mac-address-table learning bridge 1 interface ce3/1	Disable the mac-learning on the device
R2(config)#no mac-address-table learning bridge 1 interface ce29/1	Disable the mac-learning on the device
R2(config)#commit	Commit the configuration
R2(config)#exit	Exit from configuration mode

## Validation

### R1

```
R1#show running-config interface ce1/1
!
interface ce1/1
  switchport
  bridge-group 1
  switchport mode trunk
  switchport trunk allowed vlan add 2
!
R1#show running-config interface ce5/1
!
interface ce5/1
  switchport
  bridge-group 1
```

```

switchport mode trunk
switchport trunk allowed vlan add 2
loopback tx phy
!
R1# show interface ce5/1
Interface ce5/1
  Flexport: Breakout Control Port (Active): Break Out disabled
  Hardware is ETH Current HW addr: 34ef.b689.e04a
  Physical:34ef.b689.e04a Logical:(not set)
  Forward Error Correction (FEC) configured is Auto (default)
  FEC status is N/A
  Port Mode is trunk
  Interface index: 5045
  Metric 1 mtu 1500 duplex-full link-speed 40g
  Debounce timer: disable
  Loopback Type: PHY
  <UP,BROADCAST,RUNNING,MULTICAST>
  VRF Binding: Not bound
  DHCP client is disabled.
  Last Flapped: 2021 Oct 23 15:57:01 (00:08:51 ago)
  Statistics last cleared: 2021 Oct 23 15:54:44 (00:11:08 ago)
  5 minute input rate 255 bits/sec, 0 packets/sec
  5 minute output rate 255 bits/sec, 0 packets/sec
RX
  unicast packets 0 multicast packets 2272 broadcast packets 0
  input packets 2272 bytes 153730
  jumbo packets 0
  undersize 0 oversize 0 CRC 0 fragments 0 jabbers 0
  input error 0
  input with dribble 0 input discard 7
  Rx pause 0
TX
  unicast packets 0 multicast packets 4333 broadcast packets 0
  output packets 4333 bytes 293304
  jumbo packets 0
  output errors 0 collision 0 deferred 0 late collision 0
  output discard 0
  Tx pause 0

```

```
R1# show interface brief
```

```

-----
Ethernet  Type          PVID  Mode          Status Reason  Speed Port  Ctl Br/Bu
Loopbk
Interface                                     Ch #
-----
ce5/1    ETH                1     trunk         up     none   10g  --    Br  Yes
PHY

```

## R2

```
R2#show running-config interface ce3/1
!
```

```
interface ce3/1
  switchport
  bridge-group 1
  switchport mode trunk
  switchport trunk allowed vlan add 2
!
```

```
R2#show running-config interface ce29/1
!
interface ce29/1
  switchport
  bridge-group 1
  switchport mode trunk
  switchport trunk allowed vlan add 2
!
R2#
```

Interface counters before configuring loopback on both the devices:

```
=====
R1#show interface counters rate gbps
+-----+-----+-----+-----+
| Interface | Rx gbps | Rx pps | Tx gbps | Tx pps |
+-----+-----+-----+-----+
| ce1/1     | 8.65    | 8446138 | 0.00    | 0      |
| ce5/1     | 0.00    | 0       | 8.65    | 8446125|
R1#
```

```
R2#show interface counters rate gbps
+-----+-----+-----+-----+
| Interface | Rx gbps | Rx pps | Tx gbps | Tx pps |
+-----+-----+-----+-----+
| ce3/1     | 0.00    | 0       | 8.65    | 8446188|
| ce29/1    | 8.65    | 8446254 | 0.00    | 0      |
```

---

## Interface counters after configuring loopback tx phy

### R1

```
R1#show interface counters rate gbps
+-----+-----+-----+-----+
| Interface | Rx gbps | Rx pps | Tx gbps | Tx pps |
+-----+-----+-----+-----+
| ce1/1     | 8.65    | 8446147 | 8.65    | 8446319|
| ce5/1     | 8.65    | 8446194 | 8.65    | 8446194|
R1#
```

```
R2#show interface counters rate gbps
+-----+-----+-----+-----+
| Interface | Rx gbps | Rx pps | Tx gbps | Tx pps |
```



```

+-----+-----+-----+-----+
ce3/1          0.00          0          0.00          0
R2#

```

---

## Removing the Loopback Configuration

### R1

R1#configure terminal	Enter into configure terminal mode
R1(config)#in ce5/1	Enter into interface level
R1(config-if)#no loopback	Un-configure the loopback
R1(config-if)#commit	Commit the configuration
R1(config-if)#end	Exit from the configuration mode

### Loopback tx mac

R1#configure terminal	Enter into configure terminal mode
R1(config)#in ce5/1	Enter into interface level
R1(config-if)#loopback tx mac	Configure loopback tx mac
R1(config-if)#commit	Commit the configuration
R1(config-if)#end	Exit from the configuration mode

---

## Validation

### R1

```

R1#show running-config interface ce1/1
!
interface ce1/1
  switchport
  bridge-group 1
  switchport mode trunk
  switchport trunk allowed vlan add 2
!
R1#show running-config interface ce5/1
!
interface ce5/1
  switchport
  bridge-group 1
  switchport mode trunk
  switchport trunk allowed vlan add 2
  loopback tx mac
!
R1# sh interface ce5/1
Interface ce5/1
  Flexport: Breakout Control Port (Active): Break Out disabled

```

## Ethernet Interface Loopback Support

---

```
Hardware is ETH Current HW addr: 34ef.b689.e04a
Physical:34ef.b689.e04a Logical:(not set)
Forward Error Correction (FEC) configured is Auto (default)
FEC status is N/A
Port Mode is trunk
Interface index: 5045
Metric 1 mtu 1500 duplex-full link-speed 40g
Debounce timer: disable
Loopback Type: MAC
<UP,BROADCAST,RUNNING,MULTICAST>
VRF Binding: Not bound
DHCP client is disabled.
Last Flapped: 2021 Oct 23 15:57:01 (00:08:51 ago)
Statistics last cleared: 2021 Oct 23 15:54:44 (00:11:08 ago)
5 minute input rate 255 bits/sec, 0 packets/sec
5 minute output rate 255 bits/sec, 0 packets/sec
RX
  unicast packets 0 multicast packets 2272 broadcast packets 0
  input packets 2272 bytes 153730
  jumbo packets 0
  undersize 0 oversize 0 CRC 0 fragments 0 jabbers 0
  input error 0
  input with dribble 0 input discard 7
  Rx pause 0
TX
  unicast packets 0 multicast packets 4333 broadcast packets 0
  output packets 4333 bytes 293304
  jumbo packets 0
  output errors 0 collision 0 deferred 0 late collision 0
  output discard 0
  Tx pause 0
```

R1# show interface brief

```
-----
Ethernet  Type          PVID  Mode          Status Reason  Speed Port  Ctl Br/Bu
Loopbk
Interface                                     Ch #
-----
ce5/1      ETH             1     trunk         up      none    10g  --    Br Yes
MAC
```

### R2

```
R2#show running-config interface ce3/1
!
interface ce3/1
  switchport
  bridge-group 1
  switchport mode trunk
  switchport trunk allowed vlan add 2
```

```

!
R2#show running-config interface ce29/1
!
interface ce29/1
switchport
 bridge-group 1
 switchport mode trunk
 switchport trunk allowed vlan add 2
!
R2#

```

## Interface counters before configuring loopback on both the devices

```
R1#show interface counters rate gbps
```

Interface	Rx gbps	Rx pps	Tx gbps	Tx pps
ce1/1	8.65	8432138	0.00	0
ce5/1	0.00	0	8.65	8430125

```
R1#
```

```
R2#show interface counters rate gbps
```

Interface	Rx gbps	Rx pps	Tx gbps	Tx pps
ce3/1	0.00	0	8.65	8429188
ce29/1	8.65	8430254	0.00	0

## Interface counters after configuring loopback tx phy

```
R1#show interface counters rate gbps
```

Interface	Rx gbps	Rx pps	Tx gbps	Tx pps
ce1/1	8.65	8446147	8.65	8446319
ce5/1	8.65	8446194	8.65	8446194

```
R1#
```

```
R2#show interface counters rate gbps
```

Interface	Rx gbps	Rx pps	Tx gbps	Tx pps
ce3/1	0.00	0	0.00	0
ce29/1	0.00	0	0.00	0

```
R2#
```

---

## Removing the Loopback Configuration

### R1

R1#configure terminal	Enter into configure terminal mode
R1(config)#in ce5/1	Enter into interface level
R1(config-if)#no loopback	Un-configure the loopback
R1(config-if)#commit	Commit the configuration
R1(config-if)#end	Exit from the configuration mode

### Loopback rx phy

R2#configure terminal	Enter into configure terminal mode
R2(config)#in ce29/1	Enter into interface level
R2(config-if)#loopback rx phy	Configure loopback rx phy
R2(config-if)#commit	Commit the configuration
R2(config-if)#end	Exit from the configuration mode

---

## Validation

### R2

```
R2#show interface ce29/1
Interface ce29/1
  Flexport: Breakout Control Port (Active): Break Out disable
  Hardware is ETH Current HW addr: 80a2.357f.4ebd
  Physical:80a2.357f.4ebd Logical:(not set)
  Forward Error Correction (FEC) configured is Auto (default)
  FEC status is N/A
  Port Mode is trunk
  Interface index: 5001
  Metric 1 mtu 1500 duplex-full link-speed 40g
  Debounce timer: disable
  Loopback Type: R-PHY
  <UP,BROADCAST,RUNNING,MULTICAST>
  VRF Binding: Not bound
  DHCP client is disabled.
  Last Flapped: 2019 Apr 30 10:03:23 (00:00:58 ago)
  Statistics last cleared: 2019 Apr 30 09:43:30 (00:20:51 ago)
  30 second input rate 8648972937 bits/sec, 8446291 packets/sec
  30 second output rate 20723 bits/sec, 38 packets/sec
RX
  unicast packets 3390485528 multicast packets 6205 broadcast packets 0
  input packets 3390494721 bytes 433982963744
  jumbo packets 0
  undersize 0 oversize 0 CRC 0 fragments 1 jabbers 0
  input error 1
```



## Ethernet Interface Loopback Support

---

ce3/1	0.00	0	8.65	8446218
ce29/1	8.65	8446222	0.00	0

R2#

## CHAPTER 34 Fault Management System Configuration

The Fault Management System (FMS) detects events, correlates them, and raises relevant alarms. The events are OPER\_LOGs relayed from the `vlogd` module. The alarms are a result of the correlation rules and provide a persistent indication of the faults. The alarms are maintained in a database and can be displayed via `show` commands.

Note:

- FMS relies on the loopback interface (`interface lo0`) for communication with VLOGd. Therefore, ensuring the operational status of the loopback interface is vital for the normal functioning of both the FMS and VLOGd modules.
- In OcNOS, FMS is disabled by default.
- After starting FMS, avoid editing the `alarm_def_config.yaml` file, as changes will only take effect after restarting FMS.
- Set the device's logging level to at least 4 (NOTIFY) to ensure timely delivery of notification events to FMS for appropriate actions. Adjusting the logging level below NOTIFY may cause FMS to miss clear events and fail to resolve active alarms.
- If FMS reboots due to a device reboot (upgrade/downgrade/reboot) or manual FMS reboots through disabling and enabling it, the device will close active alarms. Use the `show alarm closed` CLI command to view closed active alarms.

FMS applies the correlation procedures in [Table 34-4](#) based on the configurations specified.

**Table 34-4: FMS correlation procedures**

Correlation type	Description
Generalization	<ul style="list-style-type: none"> <li>• Groups two or more events into a single alarm.</li> <li>• A generalized alarm will further use one of the correlation types (none, time-bound, counting and compression) for applying correlation logic to the new alarm.</li> </ul>
Time-bound	<ul style="list-style-type: none"> <li>• Stipulates that when the event is received, a timer is started for that event.</li> <li>• While the timer is running, subsequent events of the same type are suppressed.</li> <li>• On the expiry of the timer, an alarm will be raised for that event stating the count for the number of times that event was received in this duration.</li> </ul>
Counting	Considers a specified number of similar events as one. In this correlation type, the respective alarm will be raised after the event has occurred for count times.
Compression	Check multiple occurrences of the same event for duplicate/redundant event information, remove the redundancies, and report them as a single alarm.
Severity	Correlates events based on the severity of the events.

## Implementation

FMS was developed with NodeJS with scripts written in JavaScript with a \*.js extension and configuration files with a \*.yaml extension. These files are in the below paths in OcnOS.

**Table 34-5: FMS script and configuration files**

/usr/local/bin/js	JavaScript files (*.js files)
/usr/local/etc	Configuration files (*.yaml files)

## Enabling and Disabling the Fault Management System

Follow the below steps to enable or disable FMS:

### Enabling FMS

```
# configure terminal
Enter configuration commands, one per line. End with CNTL/Z.
(config)#
(config)#fault-management enable
(config)#
```

### Disabling FMS

```
# configure terminal
Enter configuration commands, one per line. End with CNTL/Z.
(config)#
(config)#fault-management disable
(config)#
```

## Alarm Configuration File

The alarm configuration file contains the configurations/rules for the alarms that will be referred by FMS to generate alarms upon receiving events. This file is in \*.yaml format (human readable) in /usr/local/etc.

This file can be edited before starting FMS to include correlation rules for specific events.

### Alarm Configuration File Template

```
#-----Template-----
#- Event_Group:
# - ALARM_ID: # Integer number identifying alarm
# ALARM_TYPE_ID: # Alarm Type-id(AIS, EQPT, LOS, OTS, OPWR, UNKNOWN)
# EVENT: # Event name(oper_log)
# GENERALIZED_EVENT_NAME: # Event name for the Generalization Event Group
# ALARM_DESC: # Alarm string which will be generated
# CORRELATION_TYPE: # Correlation logic type(0:No-Correlation,
1:Generalization, 2:Timebound, 3:Counting, 4:Compression, 5:Drop-Event, 6:Severity)
# GENERALIZED_CORRELATION_TYPE # Correlation type, in which generalized event
will be sent
```



```

# CORRELATION_COUNTER: # Counter value that will be considered during
counting logic to raise alarm
# CORRELATION_TIMER_DURATION: # Timer duration to be considered for time bound
logic
# CORRELATION_SEVERITY: # Alarm Severity(0:Critical, 1:Major, 2:Warning,
3:Minor, 4:Unknown)
# QUALIFIER_STRING_POSITION: # List of positions where qualifier values present
# QUALIFIER_POSITION_1_EVENT_1: # First position of the qualifier value in the
first event
# RESOURCE_STRING_POSITION: # List of positions where resource values present
# RESOURCE_POSITION_1_EVENT_1: # First position of the resource value in the
first event
# SNMP_TRAP: # SNMP TRAP (true(1) or false(0))
# SNMP_OID: # OID for SNMP TRAP
# NETCONF_NOTIFICATION: # Netconf Notification (true(1) or false(0))
# CLEAR_ALARM: # Clear Alarm (oper_log enum, Status for Alarm will
be made In-active if this event is received)
# CLEAR_EVENT_PATTERN_VALUES: # Pattern values which will be searched in event's
description to identify clear event and to clear active alarm (required if both active
and clear event types are same)
# SNMP_TRAP_CLEAR: # true(1) or false(0, if CLEAR_ALARM is null then
SNMP_TRAP_CLEAR will be null)
# SNMP_CLEAR_OID: # OID for SNMP TRAP CLEAR
# NETCONF_CLEAR_NOTIFICATION: # Clear Netconf Notification information

```

---

## Auto Generating the Alarm Configuration File

The `auto_yaml_generator.js` file is a NodeJS script that generates the alarm configuration file (`alarm_def_config.yaml`) for the oper logs which are listed in the `oper_logs_list.yaml` file with the default values as shown below.

```

# Integer number identifying alarm
ALARM_ID: 1000
# Event name (oper_log)
EVENT: oper_log string
# Event name for the Generalization Event Group
GENERALIZED_EVENT_NAME: null
# Alarm string which will be generated
ALARM_DESC: oper_log string
# Correlation logic type (0: No-Correlation, 1: Generalization, 2: Time Bound, 3:
Counting, 4: Compression, 5: Drop-Event)
CORRELATION_TYPE: 0
# Correlation type, in which generalized event will be sent
GENERALISED_CORRELATION_TYPE: null
# Counter value that will be considered during counting logic to raise alarm
CORRELATION_COUNTER: 3
# Timer duration to be considered for time bound logic
CORRELATION_TIMER_DURATION: 20000
# Alarm Severity(1:Emergency, 2:Alert, 3:Critical, 4:Error, 5:Warning, 6:Notification,
7:Informational, 8:Debugging, 9:Cli)
CORRELATION_SEVERITY: null
# QUALIFIER_STRING_POSITION
QUALIFIER_POSITION_1_EVENT_1: null

```

```
# RESOURCE_STRING_POSITION
  RESOURCE_POSITION_1_EVENT_1: null
SNMP_TRAP: 0
# OID for SNMP TRAP
SNMP_OID: null
# Netconf Notification (true (1) or false (0))
NETCONF_NOTIFICATION: 1
# Clear Alarm (oper_log enum, Status for Alarm will be made In-active if this event is
received)
CLEAR_ALARM: null
# Clear Event's pattern values which will be searched in event's description to identify
clear event
CLEAR_EVENT_PATTERN_VALUES: null
# True (1) or False (0, if CLEAR_ALARM is null then SNMP_TRAP_CLEAR will be null)
SNMP_TRAP_CLEAR: 0
# OID for SNMP TRAP CLEAR
SNMP_CLEAR_OID: null
# Clear Netconf Notification information
NETCONF_CLEAR_NOTIFICATION: 0
```

---

## Alarm Configuration File Generation Steps

1. List all the `oper_log` enums in the `oper_logs_list.yaml` file and keep the file in the same path with `auto_yaml_generator.js`.
2. Copy `auto_yaml_generator.js` and `oper_logs_list.yaml` files into `/usr/local/bin/js`.
3. Run the `auto_yaml_generator.js` script with the following command.  

```
# node auto_yaml_generator.js
```
4. After executing the above commands, you will see the `alarm-def-config.yaml` file in the same directory.

---

## Sample `oper_logs_list.yaml` File

```
EVENT_GROUP:
  IFMGR_IF_DOWN,
  IFMGR_IF_UP,
  STP_SET_PORT_STATE,
  STP_IPC_COMMUNICATION_FAIL,
  STP_ROOTGUARD_PORT_BLOCK,
  :
  :
```

## Alarm Descriptions

Table 34-6 describes the supported alarms.

**Table 34-6: FMS alarms**

Alarm	Description
CMM_DDM_MONITOR_CURRENT	Transceiver Bias Current crossed the threshold limit
CMM_DDM_MONITOR_FREQ	Transceiver Frequency crossed the threshold limit
CMM_DDM_MONITOR_RxPOWER	Transceiver Rx Power crossed the threshold limit
CMM_DDM_MONITOR_TEC	Transceiver Thermoelectric Cooler fault
CMM_DDM_MONITOR_TEMP	Transceiver Temperature crossed the threshold limit
CMM_DDM_MONITOR_TxPOWER	Transceiver Tx Power crossed the threshold limit
CMM_DDM_MONITOR_VOLT	Transceiver Voltage crossed the threshold limit
CMM_DDM_MONITOR_WAVE	Transceiver Wavelength crossed the threshold limit
CMM_FAN_CTRL	Fan insertion, removal, speed, or fault condition alarm
CMM_MONITOR_CPU	CPU load average crossed the threshold limit
CMM_MONITOR_CPU_CORE	CPU core usage crossed the threshold limit
CMM_MONITOR_CURRENT	Current crossed the threshold limit
CMM_MONITOR_DISK_READ_ACTIVITY	Disk read activity crossed the threshold limit
CMM_MONITOR_DISK_REMAIN_LIFE	Disk remaining life crossed the threshold limit
CMM_MONITOR_DISK_WRITE_ACTIVITY	Disk write activity crossed the threshold limit
CMM_MONITOR_FAN	FAN RPM crossed the threshold limit
CMM_MONITOR_PSU_IIN	Power supply unit input current crossed the threshold limit
CMM_MONITOR_PSU_IOUT	Power supply unit output current crossed the threshold limit
CMM_MONITOR_PSU_PIN	Power supply unit input power crossed the threshold limit
CMM_MONITOR_PSU_POUT	Power supply unit output power crossed the threshold limit
CMM_MONITOR_PSU_POWER	Power supply unit insertion, removal, or fault condition
CMM_MONITOR_PSU_PRESENCE	Power supply unit is present
CMM_MONITOR_PSU_TEMP1	Power supply unit temperature 1 crossed the threshold limit
CMM_MONITOR_PSU_TEMP2	Power supply unit temperature 2 crossed the threshold limit
CMM_MONITOR_PSU_VIN	Power supply unit input voltage crossed the threshold limit

**Table 34-6: FMS alarms (Continued)**

<b>Alarm</b>	<b>Description</b>
CMM_MONITOR_PSU_VOUT	Power supply unit output voltage crossed the threshold limit
CMM_MONITOR_RAM	RAM memory usage crossed the threshold limit
CMM_MONITOR_SDCARD	Hard-disk usage crossed the threshold limit or fault condition
CMM_MONITOR_TEMP	Temperature sensor crossed the threshold limit
CMM_MONITOR_VOLTAGE	Voltage crossed the threshold limit
CMM_TRANSCEIVER	Transceiver on fault condition
HW_PROFILE_MONITOR	TCAM Utilization
IFMGR_IF_DOWN	Interface state down
IFMGR_IF_UP	Interface state up
HW_PROFILE_MONITOR	TCAM group utilization

## CHAPTER 35 NetConf Call Home Configuration

By default, in the NetConf protocol (RFC 6241), a NetConf client application initiates the connection towards the NetConf server in the network element (OcnOS device). However, for certain use cases such as in the presence of firewalls or NAT, it is useful to have “call home” functionality where the connection process is reversed and the NetConf server initiates the connection to the NetConf client. This process, as shown in [Figure 35-60](#), is standardized by IETF in RFC 8071.

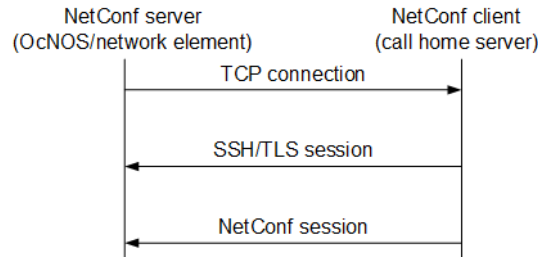

**Figure 35-60: RFC 8071 NetConf call home functionality**

OcnOS supports the call home feature (only for SSH) at the NetConf server side. You can use any standard NetConf client application which supports call home functionality. (Call home support in the NetConf client application [Yangcli] is not supported.)

Call home is generally useful for both the initial deployment and ongoing management of networking elements.

### Configuration

<code>(config)#netconf callhome</code>	Enter call home mode
<code>(netconf-callhome)#feature netconf callhome enable</code>	Enable the call home feature
<code>(netconf-callhome)#reconnect enable</code>	Enable the reconnect feature
<code>(netconf-callhome)#retry-max-attempts 10</code>	Set the number of connect retries
<code>(netconf-callhome)#retry-interval 20</code>	Set the retry interval
<code>(netconf-callhome)#callhome server test-ch-server 192.168.56.1</code>	Configure the call home server
<code>(netconf-callhome)#management-port enp0s3</code>	Set the call home management port
<code>(netconf-callhome)#commit</code>	Commit the candidate configuration to the running configuration
<code>(netconf-callhome)#exit</code>	Exit call home mode

### Validation

```

(config)#do show running-config netconf-callhome
!
netconf callhome
  feature netconf callhome enable
  management-port enp0s3
  reconnect enable
  retry-max-attempts 10
  
```

```
retry-interval 20
callhome server test-ch-server 192.168.56.1
!
(config)#
(config)#do show users
Current user      : (*). Lock acquired by user : (#).
CLI user         : [C]. Netconf users       : [N].
Location        : Applicable to CLI users.
Session         : Applicable to NETCONF users.
```

Role	Line	User	Idle	Location/Session	PID	TYPE
(#) (*)	130 vty 0	[C]root	0d00h00m	pts/0	2730	Local
network-admin						

```
(config)#
```

---

## Start the Call Home Server

After you start the call home server, the `show users` command displays a NetConf user.

```
2022 May 18 15:32:55.989 : OcNOS : CML : INFO : [CML_5]: Client [netconf (192.168.56.1)]
established connection with CML server
```

```
(config)#do show users
Current user      : (*). Lock acquired by user : (#).
CLI user         : [C]. Netconf users       : [N].
Location        : Applicable to CLI users.
Session         : Applicable to NETCONF users.
```

Role	Line	User	Idle	Location/Session	PID	TYPE
(#) (*)	130 vty 0	[C]root	0d00h00m	pts/0	2730	Local
network-admin						
	NA	[N]root	0d00h00m	192.168.56.1	2118	Local
network-admin						

```
(config)#
```

---

## NetConf sget Output

While the NetConf client is running, the `sget` command returns the session-specific data:

```
sget /netconf-state/sessions
```

```
<rpc-reply xmlns="urn:ietf:params:xml:ns:netconf:base:1.0">
  <data>
    <netconf-state xmlns="urn:ietf:params:xml:ns:yang:ietf-netconf-monitoring">
      <sessions>
        <session>
          <session-id>1</session-id>
```

```

    <transport
      xmlns:ncm="urn:ietf:params:xml:ns:yang:ietf-netconf-monitoring">ncm:netconf-
ssh</transport>
    <username>root</username>
    <source-host>192.168.56.1</source-host>
    <login-time>2022-05-18T15:32:55Z</login-time>
    <in-rpcs>0</in-rpcs>
    <in-bad-rpcs>0</in-bad-rpcs>
    <out-rpc-errors>0</out-rpc-errors>
    <out-notifications>0</out-notifications>
  </session>
</sessions>
</netconf-state>
</data>
</rpc-reply>

```

---

## Stop the Call Home Server

After you stop the call home server, the `show users` command no longer displays a NetConf user.

```
2022 May 18 15:33:20.028 : OcNOS : CML : NOTIF : [CML_4]: Client [netconf
(192.168.56.1)] has closed connection with CML server
```

```

(config)#
(config)#do show users
Current user      : (*). Lock acquired by user : (#).
CLI user         : [C]. Netconf users       : [N].
Location : Applicable to CLI users.
Session  : Applicable to NETCONF users.

```

Role	Line	User	Idle	Location/Session	PID	TYPE
(#) (*)	130 vty 0	[C]root	0d00h00m	pts/0	2730	Local
network-admin						

```
(config)#
```





---

## CHAPTER 36 QSFP-DD Configuration

---

---

### Overview

QSFP-DD is a new module developed but with the same form factor as the current QSFP, to support high-speed solutions. It provides eight lanes electrical interface. Each lane can operate up to 25Gbps NRZ modulation or 50Gbps PAM4 modulation. QSFP modules are designed to be backward compatible with the existing QSFP modules.

---

### System Description

Basically, the system will be developed to support 400Gbps data transmission. This will enable us to support the high-speed solution. The management interface will be used to get the status and control of the module.

CMIS modules have two physical interfaces for signal transmission:

---

#### Host Interface (Device to device interconnection)

The host interface is the high-speed electrical interface between the module and the host system. The host interface carries signals traveling from host to module (transmitter input signals) and signals traveling from module to host (receiver output signals). All electrical signals carried over the host interface are transmitted over the wire pairs, each of which is called host lanes.

---

#### Media Interface (Device to media interconnection)

The media interface is the high-speed electrical/optical interface between the module and the interconnecting media. The media interface carries signals that travel from module to media (transmitter output signals) and signals that travel from media to module (receiver input signals). Media interface signals are carried either over electrical wire pairs (Copper cables) or over optical wavelengths on physical fibers, which are called media lanes.

---

### Objectives

The objective of this document is to provide a high-speed solution using QSFP-DD. The management characteristics, status, and control of QSFP-DD.

---

### Topology



Figure 36-61: QSFP-DD Sample Topology

## Loopback

Use this command to configure the loopback type (input, output, both) on the QSFP-DD module host/media side. If the loopback type is supported by the QSFP-DD module this will enable the loopback function.

### Media Input Loopback

Use this command to configure the input loopback type on the QSFP-DD module media side. If the loopback type is supported by the QSFP-DD module this will enable the loopback function.

#### ROUTER1

ROUTER1#configure terminal	Enter configure mode.
ROUTER1(config)# qsfdd 0	Entering to QSFP-DD mode.
ROUTER1(config-qsfdd)#loopback in media	Configure input media Loopback.
ROUTER1(config-qsfdd)#commit	Commit the configuration.

### Validation of Media Input Loopback

OcNOS#show qsfdd 0 diagnostics media loopback

Port Number : 0

```

-----
  User Config | H/W Config |
-----
  Input      | Input      |
  
```

### Media Output Loopback

Use this command to configure the output loopback type on the QSFP-DD module media side. If the loopback type is supported by the QSFP-DD module this will enable the loopback function.

#### ROUTER1

ROUTER1#configure terminal	Enter configure mode.
ROUTER1(config)#qsfdd 0	Entering to QSFP-DD mode.
ROUTER1(config-qsfdd)#loopback out media	Configure output media Loopback.
ROUTER1(config-qsfdd)#commit	Commit the configuration.

### Validation of Media Output Loopback

OcNOS#show qsfdd 0 diagnostics media loopback

Port Number : 0

```

-----
  
```

```

User Config | H/W Config |
-----
Output      | Output      |

```

## Media Both Loopback

Use this command to configure the both loopback type on the QSFP-DD module media side. If the loopback type is supported by the QSFP-DD module this will enable the loopback function.

### ROUTER1

ROUTER1#configure terminal	Enter configure mode.
ROUTER1(config)#qsfp-dd 0	Entering to QSFP-DD mode.
ROUTER1(config-qsfp-dd)#loopback both media	Configure both input & output media Loopback.
ROUTER1(config-qsfp-dd)#commit	Commit the configuration.

## Validation of Media Both Loopback

```
OcNOS#show qsfp-dd 0 diagnostics media loopback
```

```
Port Number          : 0
```

```

-----
User Config | H/W Config |
-----
Input/Output | Input/Output |

```

## Host Input Loopback

Use this command to configure the input loopback type on the QSFP-DD module host side. If the loopback type is supported by the QSFP-DD module this will enable the loopback function.

### ROUTER1

ROUTER1#configure terminal	Enter configure mode.
ROUTER1(config)#qsfp-dd 0	Entering to QSFP-DD mode.
ROUTER1(config-qsfp-dd)#loopback in host	Configure input host Loopback.
ROUTER1(config-qsfp-dd)#commit	Commit the configuration.

## Validation of Host Input Loopback

```
OcNOS#show qsfp-dd 0 diagnostics Host loopback
```

```
Port Number          : 0
```

```

-----
User Config | H/W Config |
-----

```

Input | Input |

---

### Host Output Loopback

Use this command to configure the output loopback type on the QSFP-DD module host side. If the loopback type is supported by the QSFP-DD module this will enable the loopback function.

#### ROUTER1

ROUTER1#configure terminal	Enter configure mode.
ROUTER1(config)#qsfp-dd 0	Entering to QSFP-DD mode.
ROUTER1(config-qsfp-dd)#loopback out host	Configure output host Loopback.
ROUTER1(config-qsfp-dd)#commit	Commit the configuration.

---

### Validation of Host Output Loopback

```
OcNOS#show qsfp-dd 0 diagnostics host loopback
```

```
Port Number : 0
```

```
-----  
User Config | H/W Config |  
-----  
Output | Output |
```

---

### Host Both Loopback

Use this command to configure the both loopback type on the QSFP-DD module Host side. If the loopback type is supported by the QSFP-DD module this will enable the loopback function.

#### ROUTER1

ROUTER1#configure terminal	Enter configure mode.
ROUTER1(config)#qsfp-dd 0	Entering to QSFP-DD mode.
ROUTER1(config-qsfp-dd)#loopback both host	Configure both input & output host Loopback.
ROUTER1(config-qsfp-dd)#commit	Commit the configuration.

---

### Validation of Host Both Loopback

```
OcNOS#show qsfp-dd 0 diagnostics Host loopback
```

```
Port Number : 0
```

```
-----  
User Config | H/W Config |  
-----  
Input/Output | Input/Output |
```

## PRBS

Use these commands to configure the PRBS pattern generator/checker type to be used for diagnostics of the QSFP-DD module host/media side and to configure the PRBS pattern generator/checker location (pre-fec/post-fec) on the QSFP-DD module host/media side. If the generator/checker pattern type and location are supported by the QSFP-DD module this will enable the selected function.

Use the no parameter to remove this configuration and disable the generator/checker function.

### PRBS Host Checker & Generator

#### ROUTER1 (checker)

ROUTER1#configure terminal	Enter configure mode.
ROUTER1 (config) #qsfp-dd 3	Entering to QSFP-DD mode.
ROUTER1 (config-qsfp-dd) #prbs checker type 15 host	Configure PRBS checker type.
ROUTER1 (config-qsfp-dd) #commit	Commit the configuration.

#### ROUTER2 (generator)

ROUTER2#configure terminal	Enter configure mode.
ROUTER2 (config) #qsfp-dd 3	Entering to QSFP-DD mode.
ROUTER2 (config-qsfp-dd) #prbs generator type 15 host	Configure PRBS generator type.
ROUTER2 (config-qsfp-dd) #commit	Commit the configuration.

## Validation

#### ROUTER1

```
OcNOS#show qsfp-dd 3 diagnostics host prbs
```

```
Port Number                : 3
```

```
-----
Generator Type
```

```
-----
User Config | H/W Config |
```

```
-----
None        | PRBS-31Q   |
```

```
-----
Checker Type
```

```
-----
User Config | H/W Config |
```

## QSFP-DD Configuration

---

PRBS-15 | PRBS-15 |

-----  
Generator

-----  
User Config | H/W Config | Status |

-----  
None | Pre-FEC | Inactive |

-----  
Checker

-----  
User Config | H/W Config | Status |

-----  
None | Pre-FEC | Active |

## ROUTER2

OcNOS#show qsfp-dd 3 diagnostics host prbs

Port Number : 3

-----  
Generator Type

-----  
User Config | H/W Config |

-----  
PRBS-15 | PRBS-15 |

-----  
Checker Type

-----  
User Config | H/W Config |

-----  
None | PRBS-31Q |

-----  
Generator

-----  
User Config | H/W Config | Status |

-----  
None | Pre-FEC | Active |

-----  
Checker

-----  
User Config | H/W Config | Status |

-----  
None | Pre-FEC | Inactive |

## Unconfigure PRBS Host Checker & Generator

### ROUTER1 (checker)

ROUTER1#configure terminal	Enter configure mode.
ROUTER1(config)#qsfp-dd 3	Entering to QSFP-DD mode.
ROUTER1(config-qsfp-dd)#no prbs checker type host	Unconfigure PRBS checker type.
ROUTER1(config-qsfp-dd)#commit	Commit the configuration.
ROUTER1#configure terminal	Enter configure mode.
ROUTER1(config)#qsfp-dd 3	Entering to QSFP-DD mode.
ROUTER1(config-qsfp-dd)#no prbs generator type host	Unconfigure PRBS generator type.
ROUTER1(config-qsfp-dd)#commit	Commit the configuration.

## Validation

### ROUTER1

OcNOS#show qsfp-dd 3 diagnostics host prbs

Port Number : 3

```

-----
          Generator Type
-----
User Config | H/W Config |
-----
None        | PRBS-31Q   |
-----

          Checker Type
-----
User Config | H/W Config |
-----
None        | PRBS-31Q   |
-----

          Generator
-----
User Config | H/W Config | Status |
-----
None        | Pre-FEC    | Inactive |
-----

          Checker
-----
User Config | H/W Config | Status |

```

## QSFP-DD Configuration

---

```
-----  
None          | Pre-FEC      | Inactive |
```

### ROUTER2

```
OcNOS#show qsfdd 3 diagnostics host prbs
```

```
Port Number          : 3
```

```
-----  
Generator Type
```

```
-----  
User Config | H/W Config |
```

```
-----  
None          | PRBS-31Q   |
```

```
-----  
Checker Type
```

```
-----  
User Config | H/W Config |
```

```
-----  
None          | PRBS-31Q   |
```

```
-----  
Generator
```

```
-----  
User Config | H/W Config | Status |
```

```
-----  
None          | Pre-FEC      | Inactive |
```

```
-----  
Checker
```

```
-----  
User Config | H/W Config | Status |
```

```
-----  
None          | Pre-FEC      | Inactive |
```

---

## PRBS Media Checker & Generator

### ROUTER1 (checker)

ROUTER1#configure terminal	Enter configure mode.
ROUTER1(config)#qsfdd 3	Entering to QSFP-DD mode.
ROUTER1(config-qsfdd)#prbs checker type 15 media	Configure PRBS checker type.
ROUTER1(config-qsfdd)#commit	Commit the configuration.



## ROUTER2 (generator)

ROUTER2#configure terminal	Enter configure mode.
ROUTER2 (config)#qsfp-dd 3	Entering to QSFP-DD mode.
ROUTER2 (config-qsfp-dd)#prbs generator type 15 media	Configure PRBS generator type.
ROUTER2 (config-qsfp-dd)#commit	Commit the configuration.

## Validation

### ROUTER1

OcNOS#show qsfp-dd 3 diagnostics media prbs

Port Number : 3

```

-----
Generator Type
-----
User Config | H/W Config |
-----
None        | PRBS-31Q   |
-----

Checker Type
-----
User Config | H/W Config |
-----
PRBS-15    | PRBS-15    |
-----

Generator
-----
User Config | H/W Config | Status |
-----
None        | Pre-FEC    | Inactive |
-----

Checker
-----
User Config | H/W Config | Status |
-----
None        | Pre-FEC    | Active  |

```

### ROUTER2

OcNOS#show qsfp-dd 3 diagnostics media prbs

Port Number : 3

## QSFP-DD Configuration

---

-----  
Generator Type

-----  
User Config | H/W Config |  
-----  
PRBS-15 | PRBS-15 |

-----  
Checker Type

-----  
User Config | H/W Config |  
-----  
None | PRBS-31Q |

-----  
Generator

-----  
User Config | H/W Config | Status |  
-----  
None | Pre-FEC | Active |

-----  
Checker

-----  
User Config | H/W Config | Status |  
-----  
None | Pre-FEC | Inactive |

---

## Unconfigure PRBS Media Checker & Generator

### ROUTER1 (checker)

ROUTER1#configure terminal	Enter configure mode.
ROUTER1(config)#qsfp-dd 3	Entering to QSFP-DD mode.
ROUTER1(config-qsfp-dd)#no prbs checker type media	Unconfigure PRBS checker type.
ROUTER1(config-qsfp-dd)#commit	Commit the configuration.
ROUTER1#configure terminal	Enter configure mode.
ROUTER1(config)#qsfp-dd 3	Entering to QSFP-DD mode.
ROUTER1(config-qsfp-dd)#no prbs generator type media	Unconfigure PRBS generator type.
ROUTER1(config-qsfp-dd)#commit	Commit the configuration.

## Validation

### ROUTER1

OcNOS#show qsfp-dd 3 diagnostics media prbs

Port Number : 3

```

-----
Generator Type
-----
User Config | H/W Config |
-----
None        | PRBS-31Q   |
-----

Checker Type
-----
User Config | H/W Config |
-----
None        | PRBS-31Q   |
-----

Generator
-----
User Config | H/W Config | Status |
-----
None        | Pre-FEC    | Inactive |
-----

Checker
-----
User Config | H/W Config | Status |
-----
None        | Pre-FEC    | Inactive |
-----

```

### ROUTER2

OcNOS#show qsfp-dd 3 diagnostics media prbs

Port Number : 3

```

-----
Generator Type
-----
User Config | H/W Config |
-----
None        | PRBS-31Q   |
-----

```

## QSFP-DD Configuration

---

### Checker Type

```
-----  
User Config | H/W Config |  
-----  
None       | PRBS-31Q   |
```

### Generator

```
-----  
User Config | H/W Config | Status |  
-----  
None       | Pre-FEC    | Inactive |
```

### Checker

```
-----  
User Config | H/W Config | Status |  
-----  
None       | Pre-FEC    | Inactive |
```

---

## Application

Use this command to select the application ID to be configured for this QSFP-DD module.

Note: Only 400G application modes are supported.

Note: For checking the supported applications modes show `qsfp-dd <port no.> advertisement applications` command.

## ROUTER1

ROUTER1#configure terminal	Enter configure mode.
ROUTER1(config)# qsfp-dd 49	Entering to QSFP-DD mode.
ROUTER1(config-qsfp-dd)#application 2	Select the application ID to be configured for this QSFP-DD module
ROUTER1(config-qsfp-dd)#commit	Commit the configuration.

---

## Validation

```
OcNOS#sh qsfp-dd 49 application
```

```
Port Number           : 49
```

```
-----  
User Config          | H/W Config
```

```
-----  
Application 2       | Application 2
```

```
OcNOS#sh qsfp-dd 49 advertisement applications
```

---

```
Port Number : 49
> Application 1:
  | Host |
    Interface : 400GAUI-8 C2M
    Application BR : 425.00
    Lane Count : 8
    Lane Sig BR : 26.5625
    Modulation Format : PAM4
    Bits Per Unit Intvl : 2.000000
    Lane Assigned : Lane-1
  | Media |
    Interface : 400ZR, DWDM, Amplified
    Application BR : 478.75
    Lane Count : 1
    Lane Sig BR : 59.84375
    Modulation Format : DP-16QAM
    Bits Per Unit Intvl : 8.000000
    Lane Assigned : Lane-1
Application 2:
  | Host |
    Interface : 400GAUI-8 C2M
    Application BR : 425.00
    Lane Count : 8
    Lane Sig BR : 26.5625
    Modulation Format : PAM4
    Bits Per Unit Intvl : 2.000000
    Lane Assigned : Lane-1
  | Media |
    Interface : 400ZR, Single Wavelen., Unamp.
    Application BR : 478.75
    Lane Count : 1
    Lane Sig BR : 59.84375
    Modulation Format : DP-16QAM
    Bits Per Unit Intvl : 8.000000
    Lane Assigned : Lane-1
Application 3:
  | Host |
    Interface : 100GAUI-2 C2M
    Application BR : 106.25
    Lane Count : 2
    Lane Sig BR : 26.5625
    Modulation Format : PAM4
    Bits Per Unit Intvl : 2.000000
    Lane Assigned : Lane-7/Lane-5/Lane-3/Lane-1
  | Media |
    Interface : 400ZR, DWDM, Amplified
    Application BR : 478.75
    Lane Count : 1
    Lane Sig BR : 59.84375
```

---

## QSFP-DD Configuration

---

```

    Modulation Format      : DP-16QAM
    Bits Per Unit Intvl   : 8.000000
    Lane Assigned         : Lane-1
Application 4:
  | Host |
    Interface             : 400GAUI-8 C2M
    Application BR        : 425.00
    Lane Count            : 8
    Lane Sig BR           : 26.5625
    Modulation Format      : PAM4
    Bits Per Unit Intvl   : 2.000000
    Lane Assigned         : Lane-1
  | Media |
    Interface             : ZR400-OFEC-16QAM
    Application BR        : 481.108374
    Lane Count            : 1
    Lane Sig BR           : 60.1385468
    Modulation Format      : DP-16QAM
    Bits Per Unit Intvl   : 8.000000
    Lane Assigned         : Lane-1
Application 5:
  | Host |
    Interface             : 100GAUI-2 C2M
    Application BR        : 106.25
    Lane Count            : 2
    Lane Sig BR           : 26.5625
    Modulation Format      : PAM4
    Bits Per Unit Intvl   : 2.000000
    Lane Assigned         : Lane-7/Lane-5/Lane-3/Lane-1
  | Media |
    Interface             : ZR400-OFEC-16QAM
    Application BR        : 481.108374
    Lane Count            : 1
    Lane Sig BR           : 60.1385468
    Modulation Format      : DP-16QAM
    Bits Per Unit Intvl   : 8.000000
    Lane Assigned         : Lane-1
Application 6:
  | Host |
    Interface             : 100GAUI-2 C2M
    Application BR        : 106.25
    Lane Count            : 2
    Lane Sig BR           : 26.5625
    Modulation Format      : PAM4
    Bits Per Unit Intvl   : 2.000000
    Lane Assigned         : Lane-7/Lane-5/Lane-3/Lane-1
  | Media |
    Interface             : ZR300-OFEC-8QAM
    Application BR        : 360.831281
    Lane Count            : 1
```

```

Lane Sig BR           : 60.1385468
Modulation Format     : DP-8QAM
Bits Per Unit Intvl  : 6.000000
Lane Assigned        : Lane-1

```

Application 7:

| Host |

```

Interface           : 100GAUI-2 C2M
Application BR      : 106.25
Lane Count          : 2
Lane Sig BR         : 26.5625
Modulation Format    : PAM4
Bits Per Unit Intvl : 2.000000
Lane Assigned       : Lane-7/Lane-5/Lane-3/Lane-1

```

| Media |

```

Interface           : ZR200-OFEC-QPSK
Application BR      : 240.554187
Lane Count          : 1
Lane Sig BR         : 60.1385468
Modulation Format    : DP-QPSK
Bits Per Unit Intvl : 4.000000
Lane Assigned       : Lane-1

```

Application 8:

| Host |

```

Interface           : 100GAUI-2 C2M
Application BR      : 106.25
Lane Count          : 2
Lane Sig BR         : 26.5625
Modulation Format    : PAM4
Bits Per Unit Intvl : 2.000000
Lane Assigned       : Lane-7/Lane-5/Lane-3/Lane-1

```

| Media |

```

Interface           : ZR100-OFEC-QPSK
Application BR      : 120.277094
Lane Count          : 1
Lane Sig BR         : 30.069273
Modulation Format    : DP-QPSK
Bits Per Unit Intvl : 4.000000
Lane Assigned       : Lane-1

```

## Laser Tuning

Laser Tuning only supports for tunable Transceivers.

## Laser Grid Configuration

Use this command to configure the Laser Grids in the QSFP-DD port. These commands only supports for modules which supports for laser Tuning Transceivers.

## ROUTER1

ROUTER1#configure terminal	Enter configure mode.
ROUTER1 (config)#qsfp-dd 49	Entering to QSFP-DD mode.
ROUTER1 (config-qsfp-dd)#laser grid 100	Configure Laser Grid at QSFP-DD level.
ROUTER1 (config-qsfp-dd)#commit	Commit the configuration.

## Validation

ROUTER-1#sh qsfp-dd 49 laser status

Port Number : 49

Attribute	Lane	Value	Unit
Grid Spacing	1	100.000	GHz
Laser Frequency	1	193.100000	THz
Channel Number	1	0	--
Wavelength	1	1552.52	nm

Flag	Lane	Status
Tuning in progress	1	No
Wavelength locked	1	Yes

Flag	Lane	Status (L)
Target output power OOR	1	No
Fine tuning out of range	1	Yes
Tuning accepted	1	No
Channel number valid	1	No

## Laser Grid Unconfiguration

### ROUTER1

ROUTER1#configure terminal	Enter configure mode.
ROUTER1 (config)#qsfp-dd 49	Entering to QSFP-DD mode.
ROUTER1 (config-qsfp-dd)#no laser grid	Unconfigure Laser Grid at QSFP-DD level.
ROUTER1 (config-qsfp-dd)#commit	Commit the configuration.



## Laser Channel Configuration

Use this command to configure the Laser Channel in the QSFP-DD port. Using Channel Number we can set different Frequency and Wavelength for that port .Every Laser Grid have their own Channel Numbers. These commands only supports for modules which supports for laser Tuning Transceivers.

### ROUTER1

ROUTER1#configure terminal	Enter configure mode.
ROUTER1(config)#qsfp-dd 49	Entering to QSFP-DD mode.
ROUTER1(config-qsfp-dd)#laser channel 20	Configure Laser Channel at QSFP-DD level.
ROUTER1(config-qsfp-dd)#commit	Commit the configuration.

## Validation

ROUTER-1#show qsfp-dd 49 laser status

Port Number : 49

```

-----
Attribute | Lane | Value | Unit |
-----
Grid Spacing | 1 | 100.000 | GHz |
Laser Frequency | 1 | 195.100000 | THz |
Channel Number | 1 | 20 | -- |
Wavelength | 1 | 1536.61 | nm |
-----

```

```

-----
Flag | Lane | Status |
-----
Tuning in progress | 1 | No |
Wavelength locked | 1 | Yes |
-----

```

```

-----
Flag | Lane | Status (L) |
-----
Target output power OOR | 1 | No |
Fine tuning out of range | 1 | Yes |
Tuning accepted | 1 | Yes |
Channel number valid | 1 | No |
-----

```

## Laser Channel Unconfiguration

### ROUTER1

ROUTER1#configure terminal	Enter configure mode.
ROUTER1(config)#qsfp-dd 49	Entering to QSFP-DD mode.

## QSFP-DD Configuration

ROUTER1(config-qsfp-dd)#no laser channel	Unconfigure Laser Channel at QSFP-DD level.
ROUTER1(config-qsfp-dd)#commit	Commit the configuration.

## Laser Fine-tune-freq Configuration

Use this command to configure the Laser fine-tune-freq in the QSFP-DD port. These commands only supports for modules which supports for laser Tuning Transceivers.

### ROUTER1

ROUTER1#configure terminal	Enter configure mode.
ROUTER1(config)#qsfp-dd 49	Entering to QSFP-DD mode.
ROUTER1(config-qsfp-dd)#laser fine-tune-freq 5	Configure laser fine-tune-freq at QSFP-DD level.
ROUTER1(config-qsfp-dd)#commit	Commit the configuration.

## Validation

```
ROUTER-1#show qsfp-dd 49 laser status
```

```
Port Number          : 49
```

Attribute	Lane	Value	Unit
Grid Spacing	1	100.000	GHz
Laser Frequency	1	195.104000	THz
Channel Number	1	20	--
Wavelength	1	1536.58	nm

Flag	Lane	Status
Tuning in progress	1	No
Wavelength locked	1	Yes

Flag	Lane	Status (L)
Target output power OOR	1	No
Fine tuning out of range	1	Yes
Tuning accepted	1	Yes
Channel number valid	1	Yes

## Laser Fine-tune-freq Unconfiguration

### ROUTER1

ROUTER1#configure terminal	Enter configure mode.
ROUTER1(config)#qsfp-dd 49	Entering to QSFP-DD mode.
ROUTER1(config-qsfp-dd)#no laser fine-tune-freq	Unconfigure laser fine-tune-freq at QSFP-DD level.
ROUTER1(config-qsfp-dd)#commit	Commit the configuration.

## Laser Output-power Configuration

Use this command to configure the Laser output-power in the QSFP-DD port. These commands only supports for modules which supports for laser Tuning Transceivers.

### ROUTER1

ROUTER1#configure terminal	Enter configure mode.
ROUTER1(config)#qsfp-dd 49	Entering to QSFP-DD mode.
ROUTER1(config-qsfp-dd)#laser output-power 2	Configure laser output-power at QSFP-DD level.
ROUTER1(config-qsfp-dd)#commit	Commit the configuration.

## Validation

```
ROUTER-1#show qsfp-dd 49 laser status
```

```
Port Number          : 49
```

```
-----
```

Attribute	Lane	Value	Unit
Grid Spacing	1	100.000	GHz
Laser Frequency	1	195.104000	THz
Channel Number	1	20	--
Wavelength	1	1536.58	nm

```
-----
```

Flag	Lane	Status
Tuning in progress	1	No
Wavelength locked	1	Yes

```
-----
```

Flag	Lane	Status (L)
Target output power OOR	1	No
Fine tuning out of range	1	No

```
Tuning accepted          | 1 | Yes |
Channel number valid    | 1 | Yes |
```

## Laser Output-power Unconfiguration

### ROUTER1

ROUTER1#configure terminal	Enter configure mode.
ROUTER1 (config)#qsfp-dd 49	Entering to QSFP-DD mode.
ROUTER1 (config-qsfp-dd)#no laser output-power	Unconfigure laser output-power at QSFP-DD level.
ROUTER1 (config-qsfp-dd)#commit	Commit the configuration.

## Laser Grid at Media-lane Configuration

Use this command to configure the Laser Grids in the media-lane. These commands only supports for modules which supports for laser Tuning Transceivers.

### ROUTER1

ROUTER1#configure terminal	Enter configure mode.
ROUTER1 (config)#qsfp-dd 49	Entering to QSFP-DD mode.
ROUTER1 (config-qsfp-dd)#media-lane 1	Entering to Media lane.
ROUTER1 (config-qsfp-dd-media)#laser grid 100	Configure laser grid at Media level.
ROUTER1 (config-qsfp-dd-media)#commit	Commit the configuration.

## Validation

```
ROUTER-1#sh qsfp-dd 49 laser status
```

```
Port Number          : 49
```

```
-----
```

Attribute	Lane	Value	Unit
Grid Spacing	1	100.000	GHz
Laser Frequency	1	193.100000	THz
Channel Number	1	0	--
Wavelength	1	1552.52	nm

```
-----
```

Flag	Lane	Status
Tuning in progress	1	No
Wavelength locked	1	Yes

```
-----
```

Flag	Lane	Status (L)
------	------	------------

```

-----
Target output power OOR | 1 | No |
Fine tuning out of range | 1 | Yes |
Tuning accepted          | 1 | No |
Channel number valid     | 1 | No |
    
```

## Laser Grid at Media-lane Unconfiguration

### ROUTER1 (checker)

ROUTER1#configure terminal	Enter configure mode.
ROUTER1(config)#qsfp-dd 49	Entering to QSFP-DD mode.
ROUTER1(config-qsfp-dd)#media-lane 1	Entering to Media lane.
ROUTER1(config-qsfp-dd-media)#no laser grid	Unconfigure laser grid at Media level.
ROUTER1(config-qsfp-dd-media)#commit	Commit the configuration.

## Laser Channel at Media-lane Configuration

Use this command to configure the Laser Channel in the media-lane. Using Channel Number we can set different Frequency and Wavelength for that port .Every Laser Grid have their own Channel Numbers. These commands only supports for modules which supports for laser Tuning Transceivers.

### ROUTER1

ROUTER1#configure terminal	Enter configure mode.
ROUTER1(config)#qsfp-dd 49	Entering to QSFP-DD mode.
ROUTER1(config-qsfp-dd)#media-lane 1	Entering to Media lane.
ROUTER1(config-qsfp-dd-media)#laser channel 20	Configure laser channel at Media level.
ROUTER1(config-qsfp-dd-media)#commit	Commit the configuration.

## Validation

```
ROUTER-1#show qsfp-dd 49 laser status
```

```
Port Number          : 49
```

```

-----
Attribute           | Lane | Value   | Unit |
-----
Grid Spacing        | 1    | 100.000 | GHz  |
Laser Frequency     | 1    | 195.100000 | THz |
Channel Number      | 1    | 20      | --   |
Wavelength          | 1    | 1536.61 | nm   |
    
```

```

-----
Flag                | Lane | Status |
-----
    
```

## QSFP-DD Configuration

```
-----  
Tuning in progress | 1 | No |  
Wavelength locked | 1 | Yes |
```

```
-----  
Flag | Lane | Status (L) |  
-----  
Target output power OOR | 1 | No |  
Fine tuning out of range | 1 | Yes |  
Tuning accepted | 1 | Yes |  
Channel number valid | 1 | No |
```

## Laser Channel at Media-lane Unconfiguration

### ROUTER1

ROUTER1#configure terminal	Enter configure mode.
ROUTER1(config)#qsfp-dd 49	Entering to QSFP-DD mode.
ROUTER1(config-qsfp-dd)#media-lane 1	Entering to Media lane.
ROUTER1(config-qsfp-dd-media)#no laser channel	Unconfigure laser channel at Media level.
ROUTER1(config-qsfp-dd-media)#commit	Commit the configuration.

## Laser Fine-tune-freq at Media-lane Configuration

Use this command to configure the Laser fine-tune-freq in the media-lane. These commands only supports for modules which supports for laser Tuning Transceivers.

### ROUTER1

ROUTER1#configure terminal	Enter configure mode.
ROUTER1(config)#qsfp-dd 49	Entering to QSFP-DD mode.
ROUTER1(config-qsfp-dd)#media-lane 1	Entering to Media lane.
ROUTER1(config-qsfp-dd-media)#laser fine-tune-freq 5	Configure laser fine-tune-freq at Media level.
ROUTER1(config-qsfp-dd-media)#commit	Commit the configuration.

## Validation

```
ROUTER-1#show qsfp-dd 49 laser status
```

```
Port Number : 49
```

```
-----  
Attribute | Lane | Value | Unit |  
-----  
Grid Spacing | 1 | 100.000 | GHz |
```

Laser Frequency	1	195.104000	THz	
Channel Number	1	20	--	
Wavelength	1	1536.58	nm	

---

Flag	Lane	Status	
Tuning in progress	1	No	
Wavelength locked	1	Yes	

---

Flag	Lane	Status (L)	
Target output power OOR	1	No	
Fine tuning out of range	1	Yes	
Tuning accepted	1	Yes	
Channel number valid	1	Yes	

## Laser Fine-tune-freq at Media-lane Unconfiguration

### ROUTER1

ROUTER1#configure terminal	Enter configure mode.
ROUTER1(config)#qsfp-dd 49	Entering to QSFP-DD mode.
ROUTER1(config-qsfp-dd)#media-lane 1	Entering to Media lane.
ROUTER1(config-qsfp-dd-media)#no laser fine-tune-freq	Unconfigure laser fine-tune-freq at Media level.
ROUTER1(config-qsfp-dd-media)#commit	Commit the configuration.

## Laser Output-power at Media-lane Configuration

Use this command to configure the Laser output-power in the media-lane. These commands only supports for modules which supports for laser Tuning Transceivers.

### ROUTER1

ROUTER1#configure terminal	Enter configure mode.
ROUTER1(config)#qsfp-dd 49	Entering to QSFP-DD mode.
ROUTER1(config-qsfp-dd)#media-lane 1	Entering to Media lane.
ROUTER1(config-qsfp-dd-media)#laser output-power 2	Configure laser output-power at Media level.
ROUTER1(config-qsfp-dd-media)#commit	Commit the configuration.

## Validation

ROUTER-1#show qsfp-dd 49 laser status

## QSFP-DD Configuration

Port Number : 49

Attribute	Lane	Value	Unit
Grid Spacing	1	100.000	GHz
Laser Frequency	1	195.104000	THz
Channel Number	1	20	--
Wavelength	1	1536.58	nm

Flag	Lane	Status
Tuning in progress	1	No
Wavelength locked	1	Yes

Flag	Lane	Status (L)
Target output power OOR	1	No
Fine tuning out of range	1	No
Tuning accepted	1	Yes
Channel number valid	1	Yes

## Laser Output-power at Media-lane Unconfiguration

### ROUTER1

ROUTER1#configure terminal	Enter configure mode.
ROUTER1(config)#qsfp-dd 49	Entering to QSFP-DD mode.
ROUTER1(config-qsfp-dd)#media-lane 1	Entering to Media lane.
ROUTER1(config-qsfp-dd-media)#no laser output-power	Unconfigure laser output-power at Media level.
ROUTER1(config-qsfp-dd-media)#commit	Commit the configuration.

## QSFP-DD Monitored Alarms

Table 36-7:

Alarms	
Module	
S.No.	Name
1	Temperature
2	Voltage



**Table 36-7:**

<b>Alarms</b>	
3	TEC Current Magnitude
4	Laser temperature
Host	
S.No.	Name
1	Tx LOS
2	Tx Cdr Loss of Lock
3	Tx Adaptive Eq Failure
4	Rx Output Status
5	FEC Excessive Degrade(FED)
6	FEC Detected Degrade(FDD)
7	Remote Degrade
8	Local Degrade
9	Flexe Loss of pad block
10	Flexe loss of Multiframe
11	Flexe loss of frame
12	Flexe instance ID mismatch
13	Flexe calendar mismatch
14	Flexe instance map mismatch
15	Flexe GID mismatch
16	Tx local fault
17	Tx remote fault
18	Tx loss of alignment
19	Rx local fault
20	Rx remote fault
21	Rx loss of alignment
Media	
S.No.	Name
1	Rx Optical Power
2	Tx Optical Power

**Table 36-7:**

<b>Alarms</b>	
3	Tx Bias
4	Rx LOS
5	Rx Cdr Loss of Lock
6	Tx Failure
7	Tx Output Status
8	Tx FIFO error alarm
9	Tx Deskew Loss of Lock alarm
10	Tx Reference Clock Loss of Lock alarm
11	Tx CMU Loss of Lock alarm
12	Tx Out of Alignment alarm
13	Tx Loss of Alignment alarm
14	Rx FIFO Loss of Lock alarm
15	Rx Deskew Loss of Lock alarm
16	Rx Out of Alignment alarm
17	Rx Loss of Alignment alarm
18	Rx Chromatic Dispersion Compensation Loss of Lock alarm
19	Rx Demodulator Loss of Lock alarm
20	Rx Loss of Multi Frame alarm
21	Rx Loss of Frame alarm
22	Remote PHY Fault alarm
23	Local Degrade alarm
24	Remote Degrade alarm
25	FEC Detected Degrade over PM Interval alarm
26	FEC Excessive Degrade over PM Interval alarm
27	Laser Age
28	Laser Frequency Error

**Table 36-8:**

<b>Performance Monitoring</b>	
Host	
S.No.	Name
1	eSNR Input
2	PAM4 Level Trans
3	Pre-FEC BER
4	FERC
5	Tx Bits & Corrected Bits
6	Tx Frames & Uncorrected Frames
Media	
S.No.	Name
1	eSNR Input
2	PAM4 Level Trans
3	Pre-FEC BER
4	FERC
5	Mod Bias X/I
6	Mod Bias X/Q
7	Mod Bias Y/I
8	Mod Bias Y/Q
9	Mod Bias X_Phase
10	Mod Bias Y_Phase
11	CD - HG Short link
12	CD - LG Long link
13	DGD
14	SOPMD - HG
15	PDL
16	OSNR
17	eSNR
18	CFO

**Table 36-8:**

Performance Monitoring	
19	EVM_modem
20	Tx Power
21	Rx Total Power
22	Rx Sig Power
23	SOP ROC
24	MER
25	Clk recovery loop
26	SOPMD - LG
27	Rx Bits & Corrected Bits
28	Rx Frames & Uncorrected Frames

## Example

Given a few examples of Alarms.

For Rx Optical Power & Rx Los:

```
2023 May 25 18:23:20.545 : OcNOS : NSM : CRITI : [IFMGR_IF_DOWN_2]: Interface cd52
changed state to down
```

```
2023 May 25 18:23:24.116 : OcNOS : CMM : CRITI : [CMM_CMIS_MODULE_MONITOR_2]: Rx Optical
Power[Low Alarm] detected on Lane[1] Port[52] module. Reading[100.000 dBm], Threshold[-
28.239 dBm]. Vendor[SmartOptics      ] Serial[214156190      ]
```

```
2023 May 25 18:23:24.164 : OcNOS : CMM : CRITI : [CMM_CMIS_MODULE_MONITOR_2]: Rx LOS
detected on Lane[1] Port[52] module. Vendor[SmartOptics      ] Serial[214156190      ]
OcNOS#sh qsfp-dd 52 monitors media
```

```
Alarm Codes: TFIFO - Tx FIFO Error, TLOLDS - Tx Deskew Loss of Lock
              TLOLRC - Tx Reference Clock Loss of Lock, TLOLCMU - Tx CMU Loss of Lock
              TOOA - Tx Out of Alignment, TLOA - Tx Loss of Alignment
              RFIFO - Rx FIFO Error, RLOLDS - Tx Deskew Loss of Lock
              ROOA - Rx Out of Alignment, RLOA - Rx Loss of Alignment
              RLOLCD - Rx Chromatic Dispersion Compensation Loss of Lock
              RLOLD - Tx Demodulator Loss of Lock, RLOM - Rx Loss of Multi Frame
              RLOF - Rx Loss of Frame, FDD - FEC Detected Degradate
              FED - FEC Excessive Degradate, RPF - Remote Phy Fault
              LD - Local Degradate, RD - Remote Degradate
```

```
Codes: [HA : High Alarm], [LA : Low Alarm], [HW : High Warning], [LW : Low Warning]
```

```
Port Number      : 52
```

Monitors	Lane	Value	High Alarm	High Warning	Low Warning	Low Alarm	Unit
Rx Optical Power	1	-- [LA]	2.0	0.0	-23.0	-28.2	dBm
Tx Optical Power	1	-7.4	0.0	-2.0	-16.0	-18.0	dBm
Tx Bias	1	293.6	0.0	0.0	0.0	0.0	mA
VDM	Lane	Value	High Alarm	High Warning	Low Warning	Low Alarm	Unit

Laser Age	[DP]	1	0.0	65534.0	58983.0	0.0	0.0	%
Pre-FEC BER Min In	[DP]	1	5.00e-01	2.05e+10	2.05e+10	0.00e+00	0.00e+00	NA
Pre-FEC BER Max In	[DP]	1	5.00e-01	2.05e+10	2.05e+10	0.00e+00	0.00e+00	NA
Pre-FEC BER Avg In	[DP]	1	5.00e-01	2.05e+10	2.05e+10	0.00e+00	0.00e+00	NA
Pre-FEC BER Cur In	[DP]	1	5.00e-01	2.05e+10	2.05e+10	0.00e+00	0.00e+00	NA
FERC Min Input	[DP]	1	0.00e+00	2.05e+10	2.05e+10	0.00e+00	0.00e+00	NA
FERC Max Input	[DP]	1	0.00e+00	2.05e+10	2.05e+10	0.00e+00	0.00e+00	NA
FERC Avg Input	[DP]	1	0.00e+00	2.05e+10	2.05e+10	0.00e+00	0.00e+00	NA
FERC Curr Input	[DP]	1	0.00e+00	2.05e+10	2.05e+10	0.00e+00	0.00e+00	NA
Mod Bias X/I	[DP]	1	38.0	89.0	84.0	14.0	4.0	%
Mod Bias X/Q	[DP]	1	39.0	89.0	84.0	14.0	4.0	%
Mod Bias Y/I	[DP]	1	43.0	89.0	84.0	14.0	4.0	%
Mod Bias Y/Q	[DP]	1	41.0	89.0	84.0	14.0	4.0	%
Mod Bias X_Phase	[DP]	1	34.0	89.0	84.0	14.0	4.0	%
Mod Bias Y_Phase	[DP]	1	42.0	89.0	84.0	14.0	4.0	%
CD - HG Short link	[DP]	1	0.0	-1.0	-1.0	0.0	0.0	Ps/nm
CD - LG Long link	[DP]	1	0.0	-20.0	-20.0	0.0	0.0	Ps/nm
DGD	[DP]	1	0.0	655.3	655.3	0.0	0.0	Ps
SOPMD - HG	[DP]	1	0.0	655.3	655.3	0.0	0.0	Ps^2
PDL	[DP]	1	0.0	6553.5	6553.5	0.0	0.0	dB
OSNR	[DP]	1	0.0	6553.5	6553.5	0.0	0.0	dB
eSNR	[DP]	1	0.0	6553.5	6553.5	0.0	0.0	dB
CFO	[DP]	1	0.0	-1.0	-1.0	0.0	0.0	MHz
Tx Power	[DP]	1	-7.4	0.0	-2.0	-16.0	-18.0	dBm
Rx Total Power	[DP]	1	-46.5	13.0	10.0	-18.0	-21.0	dBm
Rx Sig Power	[DP]	1	-40.0	13.0	10.0	-18.0	-21.0	dBm
SOP ROC	[DP]	1	0.0	65535.0	65535.0	0.0	0.0	krad/s
SOPMD - LG	[DP]	1	0.0	0.0	0.0	0.0	0.0	Ps^2

Flag	Lane	Status (L)
Rx LOS	1	True
Tx Failure	1	False
Rx CDR LOL	1	True

Link Performance	Lane	Average	Minimum	Maximum	Unit
Rx DSP CCD	1	0	0	0	ps/nm
Rx DSP DGD	1	0.00	0.00	0.00	ps
Rx Low Granularity SOPMD	1	0.0	0.0	0.0	ps^2
Rx PDL	1	0.0	0.0	0.0	dB
Rx OSNR	1	0.0	0.0	0.0	dB
Rx ESNR	1	0.0	0.0	0.0	dB
Rx CFO	1	0	0	0	MHz
Tx Power	1	-7.44	-7.44	-7.43	dBm
Rx Input Optical Power	1	-48.18	-50.30	-44.67	dBm
Rx Input Optical Signal Power	1	-40.00	-40.00	-40.00	dBm
Rx SOPCR	1	0	0	0	krads/s
Rx MER	1	0.0	0.0	0.0	dB

FEC Performance	Lane	Value
Rx Bits	1	0
Rx Corrected Bits	1	0
Rx Frames	1	0
Rx Uncorrected Frames	1	0

**For TX LOS & TX Cdr Loss:**

```

2023 May 25 18:45:39.031 : OcNOS : NSM : CRITI : [IFMGR_IF_DOWN_2]: Interface cd0
changed state to down
OcNOS(config-if)#2023 May 25 18:45:40.340 : OcNOS : CMM : CRITI :
[CMM_CMIS_MODULE_MONITOR_2]: Tx LOS detected on Lane[1] Port[0] module.
Vendor[SmartOptics ] Serial[214156344 ]
    
```

## QSFP-DD Configuration

---

```
2023 May 25 18:45:40.349 : OcNOS : CMM : CRITI : [CMM_CMIS_MODULE_MONITOR_2]: Tx Cdr
Loss of Lock detected on Lane[1] Port[0] module. Vendor[SmartOptics ]
Serial[214156344 ]

2023 May 25 18:45:40.373 : OcNOS : CMM : CRITI : [CMM_CMIS_MODULE_MONITOR_2]: Tx LOS
detected on Lane[2] Port[0] module. Vendor[SmartOptics ] Serial[214156344 ]

2023 May 25 18:45:40.381 : OcNOS : CMM : CRITI : [CMM_CMIS_MODULE_MONITOR_2]: Tx Cdr
Loss of Lock detected on Lane[2] Port[0] module. Vendor[SmartOptics ]
Serial[214156344 ]

2023 May 25 18:45:40.406 : OcNOS : CMM : CRITI : [CMM_CMIS_MODULE_MONITOR_2]: Tx LOS
detected on Lane[3] Port[0] module. Vendor[SmartOptics ] Serial[214156344 ]

2023 May 25 18:45:40.414 : OcNOS : CMM : CRITI : [CMM_CMIS_MODULE_MONITOR_2]: Tx Cdr
Loss of Lock detected on Lane[3] Port[0] module. Vendor[SmartOptics ]
Serial[214156344 ]

2023 May 25 18:45:40.438 : OcNOS : CMM : CRITI : [CMM_CMIS_MODULE_MONITOR_2]: Tx LOS
detected on Lane[4] Port[0] module. Vendor[SmartOptics ] Serial[214156344 ]

2023 May 25 18:45:40.446 : OcNOS : CMM : CRITI : [CMM_CMIS_MODULE_MONITOR_2]: Tx Cdr
Loss of Lock detected on Lane[4] Port[0] module. Vendor[SmartOptics ]
Serial[214156344 ]

2023 May 25 18:45:40.471 : OcNOS : CMM : CRITI : [CMM_CMIS_MODULE_MONITOR_2]: Tx LOS
detected on Lane[5] Port[0] module. Vendor[SmartOptics ] Serial[214156344 ]

2023 May 25 18:45:40.478 : OcNOS : CMM : CRITI : [CMM_CMIS_MODULE_MONITOR_2]: Tx Cdr
Loss of Lock detected on Lane[5] Port[0] module. Vendor[SmartOptics ]
Serial[214156344 ]

2023 May 25 18:45:40.503 : OcNOS : CMM : CRITI : [CMM_CMIS_MODULE_MONITOR_2]: Tx LOS
detected on Lane[6] Port[0] module. Vendor[SmartOptics ] Serial[214156344 ]

2023 May 25 18:45:40.511 : OcNOS : CMM : CRITI : [CMM_CMIS_MODULE_MONITOR_2]: Tx Cdr
Loss of Lock detected on Lane[6] Port[0] module. Vendor[SmartOptics ]
Serial[214156344 ]

2023 May 25 18:45:40.535 : OcNOS : CMM : CRITI : [CMM_CMIS_MODULE_MONITOR_2]: Tx LOS
detected on Lane[7] Port[0] module. Vendor[SmartOptics ] Serial[214156344 ]

2023 May 25 18:45:40.543 : OcNOS : CMM : CRITI : [CMM_CMIS_MODULE_MONITOR_2]: Tx Cdr
Loss of Lock detected on Lane[7] Port[0] module. Vendor[SmartOptics ]
Serial[214156344 ]

2023 May 25 18:45:40.568 : OcNOS : CMM : CRITI : [CMM_CMIS_MODULE_MONITOR_2]: Tx LOS
detected on Lane[8] Port[0] module. Vendor[SmartOptics ] Serial[214156344 ]

2023 May 25 18:45:40.575 : OcNOS : CMM : CRITI : [CMM_CMIS_MODULE_MONITOR_2]: Tx Cdr
Loss of Lock detected on Lane[8] Port[0] module. Vendor[SmartOptics ]
Serial[214156344 ]
```

```
OcNOS(config-if)#end
OcNOS#show qsfp-dd 0 monitors host
```

Alarm Codes: FDD - FEC Detected Degrade, FED - FEC Excessive Degrade  
 LD - Local Degrade, RD - Remote Degrade  
 FLOPB - Flexe Loss of Pad Block, FLOMF - Flexe Loss of Multi-Frame  
 FLOF - Flexe Loss of Frame, FIIDM - Flexe Instance Id Mismatch  
 FCM - Flexe Calendar Mismatch, FIMM - Flexe Instance Map Mismatch  
 FGIDM - Flexe GID Mismatch, TLF - Transmit Local Fault  
 TRF - Transmit Remote Fault, TLOA - Transmit Loss of Alignment  
 RLF - Receive Local Fault, RRF - Receive Remote Fault  
 RLOA - Receive Loss of Alignment

Port Number : 0

Flag	Lane	Status (L)
Tx LOS	1	True
	2	True
	3	True
	4	True
	5	True
	6	True
	7	True
	8	True
Tx CDR LOL	1	True
	2	True
	3	True
	4	True
	5	True
	6	True
	7	True
	8	True
Tx Adaptive Input Eq	1	Good
	2	Good
	3	Good
	4	Good
	5	Good
	6	Good
	7	Good
	8	Good

VDM	Lane	Value	High Alarm	High Warning	Low Warning	Low Alarm	Unit
Pre-FEC BER Min In[DP]	1	1.00e+00	2.05e+10	2.05e+10	0.00e+00	0.00e+00	NA
Pre-FEC BER Max In[DP]	1	0.00e+00	2.05e+10	2.05e+10	0.00e+00	0.00e+00	NA
Pre-FEC BER Avg In[DP]	1	0.00e+00	2.05e+10	2.05e+10	0.00e+00	0.00e+00	NA
Pre-FEC BER Cur In[DP]	1	5.00e-01	2.05e+10	2.05e+10	0.00e+00	0.00e+00	NA
FERC Min Input [DP]	1	0.00e+00	2.05e+10	2.05e+10	0.00e+00	0.00e+00	NA
FERC Max Input [DP]	1	0.00e+00	2.05e+10	2.05e+10	0.00e+00	0.00e+00	NA
FERC Avg Input [DP]	1	0.00e+00	2.05e+10	2.05e+10	0.00e+00	0.00e+00	NA
FERC Curr Input [DP]	1	0.00e+00	2.05e+10	2.05e+10	0.00e+00	0.00e+00	NA

FEC Performance	Lane	Value
Tx Bits	1	0
Tx Corrected Bits	1	0
Tx Frames	1	0
Tx Uncorrected Frames	1	0





---

## CHAPTER 37 Erbium-Doped Fiber Amplifier (EDFA) Configuration

---

---

### Overview

Before the development of optical amplifiers, optical signals had to be converted into electrical signals, then amplified, and subsequently transformed back into optical signals. This was a very complicated and expensive process. To avoid this complexity, optical amplifiers are developed, enabling the direct amplification of optical signals without the need for conversion. This streamlined approach significantly reduced costs.

Various types of optical amplifiers include:

- Semiconductor Optical Amplifier (SOA)
- Raman Amplifiers
- Brillouin Amplifiers
- Erbium-Doped Fiber Amplifier (EDFA)

Erbium-Doped Fiber Amplifier (EDFA) uses erbium-doped fiber as an amplification medium and are extensively deployed in Wavelength Division Multiplexing (WDM) systems. It can amplify multiple optical signals simultaneously and is commonly used in the C-band and L-band.

---

### System Description

Basically, the system will be developed to combine the input signal with the pump light using a WDM coupler. This combined signal is then directed into the EDF. Within the EDF, the pump light initiates a process called population inversion, and the input signal undergoes amplification through stimulated emission.

To ensure stable signal amplification and prevent undesired back reflections from the output port, isolators are strategically placed at both the input and output ends. Additionally, the presence of isolators prevents the amplifier from functioning as a laser.

The wavelength of the pump LD is precisely controlled and maintained close to 980nm.

These optical and communication systems operate in two different modes.

---

#### APC (Automatic Power Control)

In APC mode, the microprocessor controls the output power by adjusting the pump laser to maintain a predefined reference output power level. This control mechanism ensures the output power remains constant, even when the input power fluctuates within the dynamic range.

---

#### AGC (Automatic Gain Control)

In AGC mode, the microprocessor controls the output power to maintain the specified gain relative to the input power. The expected output power cannot be guaranteed, if the input power falls below the minimum assured input power range.

## Objectives

The objective of this document is to provide the application of EDFA as a booster amplifier, Inline amplifier, and pre-amplifier.

- **Booster Amplifier:** The booster amplifier is placed just after the transmitter to increase the optical power launched to the transmission line. It's not always required in single-channel links but is an essential part of the DWDM link where the multiplexer attenuates the signal channels. It has high input power, high output power, and medium optical gain.
- **Inline Amplifier:** The inline amplifiers are placed in the transmission line, compensating for the attenuation induced by the optical fiber. The in-line EDFA is designed for optical amplification between two network nodes on the main optical link. In-line EDFAs are placed every 80-100 km to ensure that the optical signal level remains above the noise floor. It features medium to low input power, high output power, high optical gain, and a low noise figure.
- **Pre-Amplifier:** The pre-amplifier is placed just before the receiver, such that sufficient optical power is launched to the receiver. It has relatively low input power, medium output power, and medium gain.

Support added for the DDM parameters specific to the EDFA available in the QSFP28 form factor. This application supports the reading of In-power, Out-power, pump BIAS, and gain. Additionally, it will enable the configuration of the target out-power and the continuous monitoring of these attributes in accordance with the specified thresholds.

## Topology

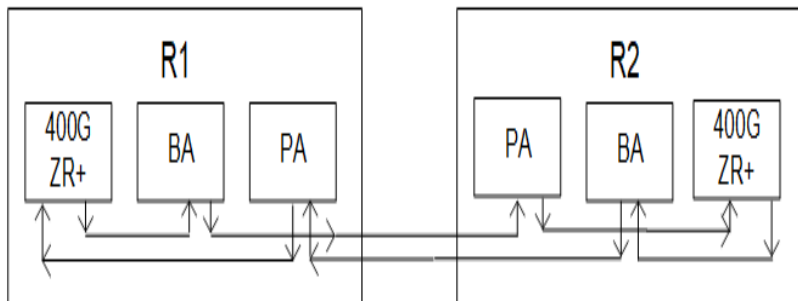

Figure 37-62: EDFA Sample Topology

## Configuration

### R1

#configure terminal	Enter into configure mode.
(config)#interface ce15	Enter into interface mode.
(config-if)#edfa operating-mode agc	Enable the EDFA operating mode AGC.
(config-if)#edfa target-gain 5	Specify the desired EDFA gain value.
(config-if)#commit	Commit the candidate configuration to the running configuration.
(config-if)#exit	Exit the router mode.
(config)#interface ce15	Enter into interface mode.

(config-if)#edfa operating-mode apc	Enable the EDFA operating mode APC.
(config-if)# edfa target-outpwr 10	Specify the desired EDFA output power value.
(config-if)#commit	Commit the candidate configuration to the running configuration.
(config-if)#exit	Exit the router mode.

## Validation

### R1 - validation for AGC mode

```
#show running-config interface ce15
```

```
!
```

```
interface ce15
  edfa operating-mode agc
  edfa target-gain 5.000
```

verify is the gain value is applied after configuring.

```
ROUTER-1#show interface ce15 transceiver detail
```

Codes: \* Not Qualified By IP Infusion, \*\* Not Supported By Module, -- No Power, - Not Applicable

Intf	DDM	InPwr (dBm)	AlertMax (dBm)	CritMax (dBm)	CritMin (dBm)	AlertMin (dBm)
ce15	Active*	-9.81	+5.00	+4.00	-20.97	-21.94
Intf	DDM	OutPwr (dBm)	AlertMax (dBm)	CritMax (dBm)	CritMin (dBm)	AlertMin (dBm)
ce15	Active*	-4.46	+20.00	+18.00	-10.00	-11.94
Intf	DDM	PumpBias (Amp)	AlertMax (Amp)	CritMax (Amp)	CritMin (Amp)	AlertMin (Amp)
ce15	Active*	+0.05	+0.59	+0.53	+0.00	+0.00
Intf	DDM	Gain (dB)	AlertMax (dB)	CritMax (dB)	CritMin (dB)	AlertMin (dB)
ce15	Active*	+3.67	+26.00	+25.00	+8.00	+7.00

### R1 - validation for APC mode

```
#show running-config interface ce15
```

```
!
```

```
interface ce15
  edfa operating-mode apc
  edfa target-outpwr 10.000
```

```
R-1#show interface ce15 transceiver detail
```

## Erbium-Doped Fiber Amplifier (EDFA) Configuration

---

Codes: \* Not Qualified By IP Infusion, \*\* Not Supported By Module, -- No Power, - Not Applicable

Intf	DDM	InPwr (dBm)	AlertMax (dBm)	CritMax (dBm)	CritMin (dBm)	AlertMin (dBm)
ce15	Active*	-9.77	+5.00	+4.00	-20.97	-21.94
Intf	DDM	OutPwr (dBm)	AlertMax (dBm)	CritMax (dBm)	CritMin (dBm)	AlertMin (dBm)
ce15	Active*	+10.08	+20.00	+18.00	-10.00	-11.94
Intf	DDM	PumpBias (Amp)	AlertMax (Amp)	CritMax (Amp)	CritMin (Amp)	AlertMin (Amp)
ce15	Active*	+0.13	+0.59	+0.53	+0.00	+0.00
Intf	DDM	Gain (dB)	AlertMax (dB)	CritMax (dB)	CritMin (dB)	AlertMin (dB)
ce15	Active*	+19.85	+26.00	+25.00	+8.00	+7.00

\*NOTE : after unconfiguring the edfa the value of output power and gain should be in default value.

Provide the following:

- o Include a Topology diagram.
- o Document configuration steps. Ensure the topology and configuration steps match.
- o Request a show running-config for the new feature.
- o Provide verification steps to demonstrate that the configuration has taken effect.
- o Add a reference to any relevant information in the existing Configuration Guide.

Note:Request a "test report" before importing QA scenarios into your doc. Ensure you only include configurations samples that "Pass".

---

## CHAPTER 38 Port Breakout (100G) on Qumran2

---

---

### Overview

Port breakout enables 100GbE ports to be broken out into 4x10GbE, 4x25GbE, and 2x50GbE ports through a secure, highly reliable breakout cabling solution. Networks require a mix of 10Gb, 25Gb, 40Gb, and 100Gb Ethernet interface speeds able to utilize the widest range of flexible connectivity options and it require a variety of cost-effective cabling options for both addressing connectivity and allowing for simple migrations as network speeds and density requirements evolve.

Port breakout feature provides flexibility in splitting 100G to 4X10G, 4X25G, 2X50G, and vice-versa. 100G splittable ports are called control ports. Ports which are members of a control port are called subsidiary ports. When you do port breakout on 100g (ce3) port into 4X10g, the original port (ce3) will be removed and four 10g ports will be added as ce3/1, ce3/2, ce3/3, and ce3/4. On this breakout port you can do the all L2 and L3 features like on a normal port.

When port breakout is un-configured, the breakout ports (ce3/1, ce3/2, ce3/3, ce3/4) will be removed and the original port (ce3) will be added back.

---

### Limitations

- Port Breakout is supported on all 100g interfaces except the ports having an external phy. These external phy ports can be seen using command `show hsl extphy status`.
- You cannot change one port breakout mode (4X10G, 4X25G) to the other mode (4X10G, 4X25G) directly. You must remove the breakout configuration to change the mode.
- Port breakout is not supported on ports which contains sub-interfaces or any other services running over it. To breakout, all services on the interfaces need to be un-configured. After breakout, all the services can be configured on breakout ports.
- While configuring port-breakout, you need to reduce the speed of some interface if this error message is displayed: "% Max egress credit limit reached". This is due to hardware limitation.

## Topology

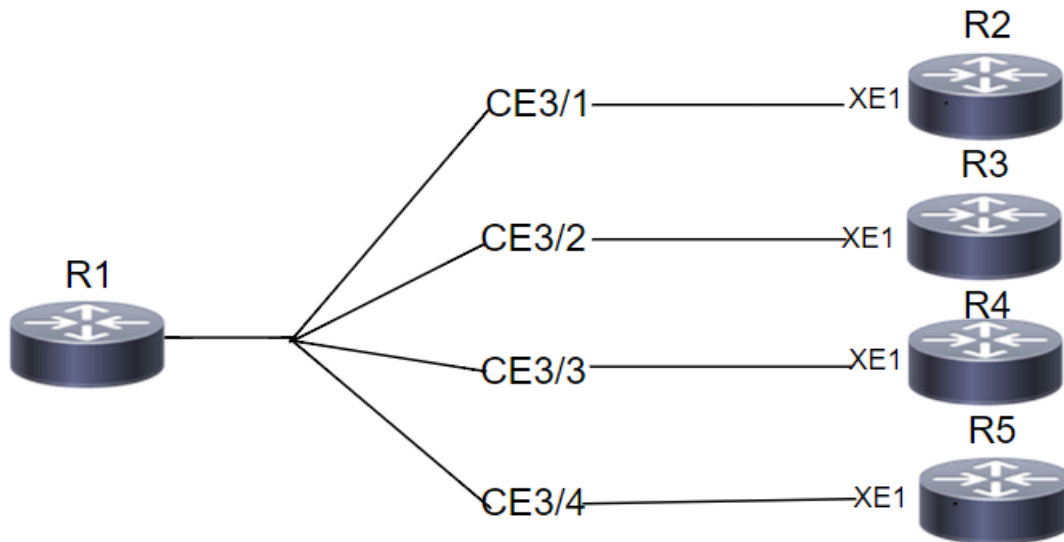

Figure 38-63: Sample Port Breakout Topology

## Port Breakout 4X10g

Breakout 100g port (ce3) into 4X10g as (ce3/1, ce3/2, ce3/3, ce3/4).

## Configuration

OcNOS#configure terminal	Enter configure mode.
OcNOS(config)#port ce3 breakout 4X10g	Breakout 100g port ce3 into 4X10g as (ce3/1, ce3/2, ce3/3, ce3/4).
OcNOS(config)#commit	Commit the configuration.

## Validation

```

OcNOS#sh run int ce3
% Can't find interface ce3.
OcNOS#sh run int ce3/1
!
interface ce3/1
!
OcNOS#sh run int ce3/2
!
interface ce3/2
!
OcNOS#sh run int ce3/3
!
interface ce3/3
!
  
```

```
OcNOS#sh run int ce3/4
!
interface ce3/4
!
```

```
OcNOS#sh int br
```

```
Codes: ETH - Ethernet, LB - Loopback, AGG - Aggregate, MLAG - MLAG Aggregate
FR - Frame Relay, TUN -Tunnel, PBB - PBB Logical Port, VP - Virtual Port
CVP - Channelised Virtual Port, METH - Management Ethernet, UNK- Unknown
ED - ErrDisabled, PD - Protocol Down, AD - Admin Down, IA - InActive
PD(Min L/B) - Protocol Down Min-Links/Bandwidth
DV - DDM Violation, NA - Not Applicable
NOM - No operational members, PVID - Port Vlan-id
Ctl - Control Port (Br-Breakout/Bu-Bundle)
HD - ESI Hold Timer Down
```

Ethernet Loopbk Interface	Type	PVID	Mode	Status	Reason	Speed	Port	Ch #	Ctl	Br/Bu
ce0	ETH	--	routed	up	none	100g	--		No	No
ce1	ETH	--	routed	up	none	40g	--		No	No
ce2	ETH	--	routed	up	none	100g	--		No	No
ce3/1	ETH	--	routed	down	PD	10g	--		No	No
ce3/2	ETH	--	routed	down	PD	10g	--		No	No
ce3/3	ETH	--	routed	down	PD	10g	--		No	No
ce3/4	ETH	--	routed	down	PD	10g	--		No	No
ce4	ETH	--	routed	down	PD	100g	--		No	No
ce5	ETH	--	routed	down	PD	100g	--		No	No
ce6	ETH	--	routed	down	PD	100g	--		No	No
ce7	ETH	--	routed	down	PD	100g	--		No	No
ce8	ETH	--	routed	down	PD	100g	--		No	No
ce9	ETH	--	routed	down	PD	100g	--		No	No
ce10	ETH	--	routed	down	PD	100g	--		No	No
ce11	ETH	--	routed	down	PD	100g	--		No	No
ce12	ETH	--	routed	down	PD	100g	--		No	No
ce13	ETH	--	routed	down	PD	100g	--		No	No
ce14	ETH	--	routed	up	none	40g	--		No	No
ce15	ETH	--	routed	up	none	40g	--		No	No
ce16	ETH	--	routed	down	PD	100g	--		No	No
ce17	ETH	--	routed	down	PD	100g	--		No	No
ce18	ETH	--	routed	down	PD	100g	--		No	No
ce19	ETH	--	routed	down	PD	100g	--		No	No
ce20	ETH	--	routed	down	PD	100g	--		No	No
ce21	ETH	--	routed	down	PD	100g	--		No	No
ce22	ETH	--	routed	down	PD	100g	--		No	No
ce23	ETH	--	routed	down	PD	100g	--		No	No
ce24	ETH	--	routed	down	PD	100g	--		No	No

## Port Breakout (100G) on Qumran2

---

ce25	ETH	--	routed	down	PD	100g	--	No	No
ce26	ETH	--	routed	down	PD	100g	--	No	No
ce27	ETH	--	routed	down	PD	100g	--	No	No
ce28	ETH	--	routed	down	PD	100g	--	No	No

---

## Port Breakout 4X25g

Breakout 100g port (ce3) into 4X25g as (ce3/1, ce3/2, ce3/3, ce3/4).

---

## Configuration

OcNOS#configure terminal	Enter configure mode.
OcNOS(config)#port ce3 breakout 4X25g	Breakout 100g port ce3 into 4X25g as (ce3/1, ce3/2, ce3/3, ce3/4).
OcNOS(config)#commit	Commit the configuration.

---

## Validation

```
OcNOS#sh run int ce3
% Can't find interface ce3.
OcNOS#sh run int ce3/1
!
interface ce3/1
!
OcNOS#sh run int ce3/2
!
interface ce3/2
!
OcNOS#sh run int ce3/3
!
interface ce3/3
!
OcNOS#sh run int ce3/4
!
interface ce3/4
!

OcNOS#sh int br
```

Codes: ETH - Ethernet, LB - Loopback, AGG - Aggregate, MLAG - MLAG Aggregate  
FR - Frame Relay, TUN -Tunnel, PBB - PBB Logical Port, VP - Virtual Port  
CVP - Channelised Virtual Port, METH - Management Ethernet, UNK- Unknown  
ED - ErrDisabled, PD - Protocol Down, AD - Admin Down, IA - InActive  
PD(Min L/B) - Protocol Down Min-Links/Bandwidth  
DV - DDM Violation, NA - Not Applicable  
NOM - No operational members, PVID - Port Vlan-id  
Ctl - Control Port (Br-Breakout/Bu-Bundle)  
HD - ESI Hold Timer Down



Ethernet Loopbk Interface	Type	PVID	Mode	Status	Reason	Speed	Port	Ch #	Ctl	Br/Bu
ce0	ETH	--	routed	up	none	100g	--		No	No
ce1	ETH	--	routed	up	none	40g	--		No	No
ce2	ETH	--	routed	up	none	100g	--		No	No
ce3/1	ETH	--	routed	down	PD	25g	--		No	No
ce3/2	ETH	--	routed	down	PD	25g	--		No	No
ce3/3	ETH	--	routed	down	PD	25g	--		No	No
ce3/4	ETH	--	routed	down	PD	25g	--		No	No
ce4	ETH	--	routed	down	PD	100g	--		No	No
ce5	ETH	--	routed	down	PD	100g	--		No	No
ce6	ETH	--	routed	down	PD	100g	--		No	No
ce7	ETH	--	routed	down	PD	100g	--		No	No
ce8	ETH	--	routed	down	PD	100g	--		No	No
ce9	ETH	--	routed	down	PD	100g	--		No	No
ce10	ETH	--	routed	down	PD	100g	--		No	No
ce11	ETH	--	routed	down	PD	100g	--		No	No
ce12	ETH	--	routed	down	PD	100g	--		No	No
ce13	ETH	--	routed	down	PD	100g	--		No	No
ce14	ETH	--	routed	up	none	40g	--		No	No
ce15	ETH	--	routed	up	none	40g	--		No	No
ce16	ETH	--	routed	down	PD	100g	--		No	No
ce17	ETH	--	routed	down	PD	100g	--		No	No
ce18	ETH	--	routed	down	PD	100g	--		No	No
ce19	ETH	--	routed	down	PD	100g	--		No	No
ce20	ETH	--	routed	down	PD	100g	--		No	No
ce21	ETH	--	routed	down	PD	100g	--		No	No
ce22	ETH	--	routed	down	PD	100g	--		No	No
ce23	ETH	--	routed	down	PD	100g	--		No	No
ce24	ETH	--	routed	down	PD	100g	--		No	No
ce25	ETH	--	routed	down	PD	100g	--		No	No
ce26	ETH	--	routed	down	PD	100g	--		No	No
ce27	ETH	--	routed	down	PD	100g	--		No	No

## Port Breakout 2X50g

Breakout 100g port (ce3) into 2X50g as (ce3/1, ce3/2).

## Configuration

OcNOS#configure terminal	Enter configure mode.
OcNOS(config)#port ce3 breakout 2X50g	Breakout 100g port ce3 into 2X50g as (ce3/1, ce3/2).
OcNOS(config)#commit	Commit the configuration.

## Validation

```
OcNOS#sh run int ce3
% Can't find interface ce3.
OcNOS#sh run int ce3/1
!
interface ce3/1
!
OcNOS#sh run int ce3/2
!
interface ce3/2
!
```

```
OcNOS#sh int br
```

Codes: ETH - Ethernet, LB - Loopback, AGG - Aggregate, MLAG - MLAG Aggregate  
 FR - Frame Relay, TUN -Tunnel, PBB - PBB Logical Port, VP - Virtual Port  
 CVP - Channelised Virtual Port, METH - Management Ethernet, UNK- Unknown  
 ED - ErrDisabled, PD - Protocol Down, AD - Admin Down, IA - InActive  
 PD(Min L/B) - Protocol Down Min-Links/Bandwidth  
 DV - DDM Violation, NA - Not Applicable  
 NOM - No operational members, PVID - Port Vlan-id  
 Ctl - Control Port (Br-Breakout/Bu-Bundle)  
 HD - ESI Hold Timer Down

Ethernet Loopbk Interface	Type	PVID	Mode	Status	Reason	Speed	Port	Ch #	Ctl	Br/Bu
ce0	ETH	--	routed	up	none	100g	--		No	No
ce1	ETH	--	routed	up	none	40g	--		No	No
ce2	ETH	--	routed	up	none	100g	--		No	No
ce3/1	ETH	--	routed	down	PD	50g	--		No	No
ce3/2	ETH	--	routed	down	PD	50g	--		No	No
ce4	ETH	--	routed	down	PD	100g	--		No	No
ce5	ETH	--	routed	down	PD	100g	--		No	No
ce6	ETH	--	routed	down	PD	100g	--		No	No
ce7	ETH	--	routed	down	PD	100g	--		No	No
ce8	ETH	--	routed	down	PD	100g	--		No	No
ce9	ETH	--	routed	down	PD	100g	--		No	No
ce10	ETH	--	routed	down	PD	100g	--		No	No
ce11	ETH	--	routed	down	PD	100g	--		No	No
ce12	ETH	--	routed	down	PD	100g	--		No	No
ce13	ETH	--	routed	down	PD	100g	--		No	No
ce14	ETH	--	routed	up	none	40g	--		No	No
ce15	ETH	--	routed	up	none	40g	--		No	No
ce16	ETH	--	routed	down	PD	100g	--		No	No
ce17	ETH	--	routed	down	PD	100g	--		No	No
ce18	ETH	--	routed	down	PD	100g	--		No	No

---

ce19	ETH	--	routed	down	PD	100g	--	No	No
ce20	ETH	--	routed	down	PD	100g	--	No	No
ce21	ETH	--	routed	down	PD	100g	--	No	No
ce22	ETH	--	routed	down	PD	100g	--	No	No
ce23	ETH	--	routed	down	PD	100g	--	No	No
ce24	ETH	--	routed	down	PD	100g	--	No	No
ce25	ETH	--	routed	down	PD	100g	--	No	No
ce26	ETH	--	routed	down	PD	100g	--	No	No
ce27	ETH	--	routed	down	PD	100g	--	No	No
ce28	ETH	--	routed	down	PD	100g	--	No	No
ce29	ETH	--	routed	down	PD	100g	--	No	No
ce30	ETH	--	routed	down	PD	100g	--	No	No
ce31	ETH	--	routed	down	PD	100g	--	No	No

---

## Un-configure Port Breakout

Combine the breakout port back to original port as (ce3).

### Configuration

---

OcNOS#configure terminal	Enter configure mode.
OcNOS(config)#no port ce3 breakout	Combine the breakout port back to original port as (ce3).
OcNOS(config)#commit	Commit the configuration.

---

### Validation

```
OcNOS#sh run int ce3
!
interface ce3
!
OcNOS#sh run int ce3/1
% Can't find interface ce3/1.
OcNOS#sh run int ce3/2
% Can't find interface ce3/2.
OcNOS#sh run int ce3/3
% Can't find interface ce3/3.
OcNOS#sh run int ce3/4
% Can't find interface ce3/4.
```

```
OcNOS#sh int br
```

Codes: ETH - Ethernet, LB - Loopback, AGG - Aggregate, MLAG - MLAG Aggregate  
FR - Frame Relay, TUN -Tunnel, PBB - PBB Logical Port, VP - Virtual Port  
CVP - Channelised Virtual Port, METH - Management Ethernet, UNK- Unknown  
ED - ErrDisabled, PD - Protocol Down, AD - Admin Down, IA - InActive  
PD(Min L/B) - Protocol Down Min-Links/Bandwidth  
DV - DDM Violation, NA - Not Applicable  
NOM - No operational members, PVID - Port Vlan-id

## Port Breakout (100G) on Qumran2

Ctl - Control Port (Br-Breakout/Bu-Bundle)

HD - ESI Hold Timer Down

---

Ethernet Loopbk Interface	Type	PVID	Mode	Status	Reason	Speed	Port Ch #	Ctl	Br/Bu
ce0	ETH	--	routed	up	none	100g	--	No	No
ce1	ETH	--	routed	up	none	40g	--	No	No
ce2	ETH	--	routed	up	none	100g	--	No	No
ce3	ETH	--	routed	down	PD	100g	--	No	No
ce4	ETH	--	routed	down	PD	100g	--	No	No
ce5	ETH	--	routed	down	PD	100g	--	No	No
ce6	ETH	--	routed	down	PD	100g	--	No	No
ce7	ETH	--	routed	down	PD	100g	--	No	No
ce8	ETH	--	routed	down	PD	100g	--	No	No
ce9	ETH	--	routed	down	PD	100g	--	No	No
ce10	ETH	--	routed	down	PD	100g	--	No	No
ce11	ETH	--	routed	down	PD	100g	--	No	No
ce12	ETH	--	routed	down	PD	100g	--	No	No
ce13	ETH	--	routed	down	PD	100g	--	No	No
ce14	ETH	--	routed	up	none	40g	--	No	No
ce15	ETH	--	routed	up	none	40g	--	No	No

# System Management Command Reference



---

## CHAPTER 1 Basic Commands

---

This chapter describes basic commands.

- `banner motd`
- `clock set`
- `clock timezone`
- `configure terminal`
- `configure terminal force`
- `copy empty-config startup-config`
- `copy running-config startup-config`
- `crypto pki generate rsa common-name ipv4`
- `debug nsm`
- `debug vm-events`
- `disable`
- `do`
- `enable`
- `enable password`
- `end`
- `exec-timeout`
- `exit`
- `help`
- `history`
- `hostname`
- `line console`
- `line vty (all line mode)`
- `line vty (line mode)`
- `logging cli`
- `logout`
- `max-session`
- `ping`
- `ping (interactive)`
- `quit`
- `reload`
- `service advanced-vty`
- `service password-encryption`
- `service terminal-length`
- `show clock`
- `show cli`

- `show cli history`
- `show crypto csr`
- `show debugging nsm`
- `show debugging vm-events`
- `show list`
- `show logging cli`
- `show nsm client`
- `show process`
- `show running-config`
- `show running-config switch`
- `show startup-config`
- `show tcp`
- `show timezone`
- `show users`
- `show version`
- `sys-reload`
- `sys-shutdown`
- `terminal width`
- `terminal length`
- `terminal monitor`
- `traceroute`
- `watch static-mac-movement`
- `write`
- `write terminal`



---

## banner motd

Use this command to set the message of the day (motd) at login.

After giving this command, you must write to memory using the [terminal monitor](#) command. If you do not write to memory, the new message of the day is not available after the device reboots.

Use the `no` parameter to not display a banner message at login.

### Command Syntax

```
banner motd LINE
banner motd default
no banner motd
```

### Parameters

<code>LINE</code>	Custom message of the day.
<code>default</code>	Default message of the day.

### Default

By default, the following banner is displayed after logging in:

```
OcNOS version 1.3.4.268-DC-MPLS-ZEBM 09/27/2018 13:44:22
```

### Command Mode

Configure mode

### Applicability

This command was introduced before OcNOS version 1.3.

### Examples

```
#configure terminal
(config)#banner motd default

#configure terminal
(config)#no banner motd
```

---

## clock set

Use this command to set the system time manually.

### Command Syntax

```
clock set HH:MM:SS <1-31> MONTH <2000-2099>
```

### Parameters

HH:MM:SS	Time of day: hour, minutes, seconds
<1-31>	Day of month
MONTH	Month of the year (january-december)
<2000-2099>	Year

### Default

N/A

### Command Mode

Exec and privileged exec mode

### Applicability

This command was introduced before OcNOS version 1.3.

### Examples

```
#clock set 18:30:00 13 january 2021  
18:30:00 UTC Wed Jan 13 2021
```

---

## clock timezone

Use this command to set the system time zone.

Use `no` form of this command to set the default system time zone (UTC).

### Command Syntax

```
clock timezone (WORD)
no clock timezone
```

### Parameters

`WORD` Timezone name. Use 'show timezone' to get the list of city names.

### Default

By default, system time zone is UTC

### Command Mode

Configuration mode

### Applicability

This command was introduced before OcNOS version 1.3.

### Examples

```
(config)#clock timezone Los_Angeles
```

---

## configure terminal

Use this command to enter configure mode.

When multiple CLI sessions are enabled with the [cmlsh multiple-config-session](#) command, `configure terminal` will not acquire a running datastore lock.

### Command Syntax

```
configure terminal
```

### Parameters

None

### Default

No default value is specified

### Command Mode

Privileged Exec mode

### Applicability

This command was introduced before OcNOS version 1.3.

### Example

The following example shows entering configure mode (note the change in the command prompt).

```
#configure terminal
(config) #
```

---

## configure terminal force

Use the `configure terminal force` command to kick out the configure command mode to privileged EXEC mode, iff there is any session already in configure command mode.

Note: `configure terminal force` with option 0 or without any option indicates immediate kick out the session which is locked to configure command mode. Similarly, `configure terminal force` with option of any value indicates session locked to configure command mode will be exited to privileged Exec mode after the specified number of seconds completed.

When multiple CLI sessions are enabled with the [cmlsh multiple-config-session](#) command, `configure terminal force` has no effect because configuration mode is allowed for multiple users simultaneously.

### Command Syntax

```
configure terminal force <0-600|>
```

### Parameters

`<0-600>` Timeout value in seconds for the session in config mode to exit to Privileged

### Default

No default value is specified

### Command Mode

Privileged Exec mode

### Applicability

This command was introduced before OcNOS version 1.3.

### Example

```
#configure terminal force 0  
#
```

---

## copy empty-config startup-config

Use this command to clear the contents of the startup configuration.

### Command Syntax

```
copy empty-config startup-config
```

### Parameters

None

### Default

None

### Command Mode

Privileged exec mode

### Applicability

This command was introduced before OcNOS version 1.3.

### Example

```
#copy empty-config startup-config  
#
```

---

## copy running-config startup-config

Use this command to write the configuration to the file used at startup. This is the same as the [terminal monitor](#) command.

### Command Syntax

```
copy running-config startup-config
```

### Parameters

None

### Default

No default value is specified

### Command Mode

Privileged Exec mode

### Applicability

This command was introduced before OcNOS version 1.3.

### Example

```
#copy running-config startup-config
Building configuration...
[OK]
#
```

---

## crypto pki generate rsa common-name ipv4

Use this command to generate a private key and Certificate Signing Request (CSR) which are required for OcnOS to establish a Transport Layer Security (TLS) connection with a NetConf client.

### Command Syntax

```
crypto pki generate rsa common-name ipv4 IPv4ADDR
```

### Parameters

IPv4ADDR	IPv4 address for the Common Name field of the CSR
----------	---

### Default

N/A

### Command Mode

Privileged Exec mode

### Applicability

This command was introduced in OcnOS version 5.0.

### Examples

```
#crypto pki generate rsa common-name ipv4 7.7.7.7
#show crypto csr
-----BEGIN CERTIFICATE REQUEST-----
MIICVzCCAT8CAQAwEjEQMA4GA1UEAwHNy43LjcuNzCCASIdQYJKoZIhvcNAQEB
BQADggEPADCCAQoCggEBAMkzIZaxNYPd8PW0hexecUFKq9pJn5IJzJkOQDtoVFOT
zeLPRxBaOt1NVd+lEF+wy3AgnGMw004g4AP7qaE+S5X1vKGAjagt fh/gfDAPDUtM
CpYLMCACM7n76OmyP9eUpkMbOSPkZDIBZfjUMxDTFwkzCBH+BF6SkSxtA24NUA9z
5heCIb1ArXYjdlIeB+9FfiVdOZ5yxQsLY8604ONL7Up1766SArGQo6oZ1dJ+bc91
sQVCEpF40SdCNn+Uw3R0cPfQF81BJD4H0EHf1VnHtYJwQ1yax6qc5ghT9R/rABDa
BFB3R09QpjV4Ihd/MyrdQmEIoXHeNNvSGDj9+eiEpksCAwEAAaAAMA0GCSqGS Ib3
DQEBcWUAA4IBAQAwxkQmNf3yiL+pmpwvE+gU8KVp3i4cvD13Vjh7IQMkCT47WPam
DUiYgwk+dPVAI+iWZq4qTvUNn6xahOyN5rnkTz9eipsQ1YHPPZB7hj5fimWwzJws
m4Tun0GZieEBCROqUpbuW+6QDvtR3XSzHhdGGSIteZv9cYyKhNu007okwr67c2Ea
11B7PcultOb4wj3xjqaO/ENDG+nmdUPaIKZrAwf2fEOarOaHgKwcl1AHHbusbJWL
qH0fA1OyVgfvG/WuCPP6Peg/Cpla7bDWqeGYt9vFTtekKoomQLzJwl6oINbtBCcw
DZJpeaQpUhFm+ZojwibZ5NGPBRSTuYncp5xJ
-----END CERTIFICATE REQUEST-----
#
```



---

## debug nsm

Use this command to enable NSM debugging.

Use the `no` form of this command or the `undebug` command to disable NSM debugging.

### Command Syntax

```
debug nsm (all|)
```

```
no debug nsm (all|)
```

```
undebug nsm (all|)
```

```
debug nsm bfd
```

```
no debug nsm bfd
```

```
undebug nsm bfd
```

```
debug nsm events
```

```
no debug nsm events
```

```
undebug nsm events
```

```
debug nsm hal (all|) debug
```

```
debug nsm hal events
```

```
no debug nsm hal (all|)
```

```
no debug nsm hal events
```

```
undebug nsm hal events
```

```
debug nsm packet (recv|send|) (detail|)
```

```
no debug nsm packet (recv|send|) (detail|)
```

```
undebug nsm packet (recv|send|) (detail|)
```

### Parameters

<code>all</code>	Enable all debugging.
<code>bfd</code>	Debug BFD events.
<code>events</code>	Debug NSM events.
<code>hal</code>	Debug HAL.
<code>events</code>	Debug HAL events.
<code>packet</code>	Debug packet events.
<code>recv</code>	Debug received packets.
<code>send</code>	Debug sent packets.
<code>detail</code>	Show detailed packet information.

### **Default**

By default, debugging is disabled.

### **Command Mode**

Exec mode, privileged exec mode, and configure mode

### **Applicability**

This command was introduced before OcNOS version 1.3.

### **Examples**

```
#debug nsm all
#
#debug nsm bfd
#
#debug nsm events
#
#debug nsm hal all
#
#debug nsm packet
#
#debug nsm packet recv detail
```

---

## debug vm-events

Use this command to enable debug logs for Guest VM events

Use the no form of this command to disable debug logs for Guest VM events

### Command Syntax

```
debug vm-events
```

```
no debug vm-events
```

### Parameters

None

### Default

No default value specified.

### Command Mode

Configure mode

Exec mode

### Applicability

This command was introduced before OcNOS version 6.1.0

### Examples

```
#configure terminal
```

```
(config)#debug vm-events
```

---

## disable

Use this command from to exit privileged exec mode and return to exec mode. This is the only command that allows you to go back to exec mode. The [exit](#) or [quit](#) commands in privileged exec mode end the session without returning to exec mode.

### Command Syntax

```
disable
```

### Parameters

None

### Default

No default value is specified

### Command Mode

Privileged Exec mode

### Applicability

This command was introduced before OcNOS version 1.3.

### Example

```
#disable  
>
```

---

## do

Use this command to run several exec mode or privileged exec mode commands from configure mode. The commands that can be run from configure mode using `do` are: `show`, `clear`, `debug`, `ping`, `traceroute`, `write`, and `no debug`.

### Command Syntax

```
do LINE
```

### Parameters

LINE                    Command and its parameters.

### Default

No default value is specified

### Command Mode

Configure mode

### Applicability

This command was introduced before OcNOS version 1.3.

### Example

```
#configure terminal
#(config)#do show interface
Interface lo
  Hardware is Loopback index 1 metric 1 mtu 16436 duplex-half arp ageing
  timeout 25
  <UP, LOOPBACK, RUNNING>
  VRF Binding: Not bound
  Label switching is disabled
  No Virtual Circuit configured
  Administrative Group(s): None
  DSTE Bandwidth Constraint Mode is MAM
  inet 4.4.4.40/32 secondary
  inet 127.0.0.1/8
  inet6 ::1/128
  Interface Gifindex: 3
  Number of Data Links: 0
  GMPLS Switching Capability Type:
    Packet-Switch Capable-1 (PSC-1)
  GMPLS Encoding Type: Packet
  Minimum LSP Bandwidth 0
    input packets 10026, bytes 730660, dropped 0, multicast packets 0
    input errors 0, length 0, overrun 0, CRC 0, frame 0, fifo 0, missed 0
    output packets 10026, bytes 730660, dropped 0
    output errors 0, aborted 0, carrier 0, fifo 0, heartbeat 0, window 0
    collisions 0
#
```

---

## enable

Use this command to enter privileged exec command mode.

### Command Syntax

```
enable
```

### Parameters

None

### Default

No default value is specified

### Command Mode

Exec mode

### Applicability

This command was introduced before OcNOS version 1.3.

### Example

The following example shows entering the Privileged Exec mode (note the change in the command prompt).

```
>enable  
#
```

## enable password

Use this command to change or create a password to use when entering enable mode.

Note: Only network administrators can execute this command. For more, see the [username](#) command.

There are two methods to enable a password:

- Plain Password: a clear text string that appears in the configuration file.
- Encrypted Password: An encrypted password does not display in the configuration file; instead, it displays as an encrypted string. First, use this command to create a password. Then, use the [service password-encryption](#) command to encrypt the password.

Use the `no` parameter to disable the password.

### Command Syntax

```
enable password LINE
no enable password
no enable password LINE
```

### Parameters

LINE	Password string, up to 8 alpha-numeric characters, including spaces. The string cannot begin with a number.
------	---

### Default

No default value is specified

### Command Mode

Configure mode

### Applicability

This command was introduced before OcnOS version 1.3.

### Examples

```
#configure terminal
(config)#enable password mypasswd
```

---

## end

Use this command to return to privileged exec command mode from any other advanced command mode.

### Command Syntax

```
end
```

### Parameters

None

### Default

No default value is specified

### Command Mode

All command modes

### Applicability

This command was introduced before OcNOS version 1.3.

### Example

The following example shows returning to privileged exec mode directly from interface mode.

```
#configure terminal
(config)#interface eth0
(config-if)#end
#
```



---

## exec-timeout

Use this command to set the interval the command interpreter waits for user input detected. That is, this sets the time a telnet session waits for an idle VTY session before it times out. A value of zero minutes and zero seconds (0 and 0) causes the session to wait indefinitely.

Use the `no` parameter to disable the wait interval.

### Command Syntax

```
exec-timeout <0-35791> (<0-2147483>|)
no exec-timeout
```

### Parameters

<0-35791>	Timeout value in minutes.
<0-2147483>	Timeout value in seconds.

### Default

No default value is specified

### Command Mode

Line mode

### Applicability

This command was introduced before OcnOS version 1.3.

### Example

In the following example, the telnet session will timeout after 2 minutes, 30 seconds if there is no response from the user.

```
Router#configure terminal
Router(config)#line vty 23 66
Router(config-line)#exec-timeout 2 30
```

---

## exit

Use this command to exit the current mode and return to the previous mode. When used in exec mode or privileged exec mode, this command terminates the session.

### Command Syntax

```
exit
```

### Parameters

None

### Default

No default value is specified

### Command Mode

All command modes

### Applicability

This command was introduced before OcNOS version 1.3.

### Examples

The following example shows exiting interface mode and returning to configure mode.

```
#configure terminal
(config)#interface eth0
(config-if)#exit
(config)#
```

---

## help

Use this command to display help for the OcNOS command line interface.

### Command Syntax

```
help
```

### Parameters

None

### Default

No default value is specified

### Command Mode

All command modes

### Applicability

This command was introduced before OcNOS version 1.3.

### Example

```
#help
CLI provides advanced help feature. When you need help,
anytime at the command line please press '?'.
```

If nothing matches, the help list will be empty and you must backup until entering a '?' shows the available options.

Two styles of help are provided:

1. Full help is available when you are ready to enter a command argument (e.g. 'show ?') and describes each possible argument.
2. Partial help is provided when an abbreviated argument is entered and you want to know what arguments match the input (e.g. 'show ve?'.)

---

## history

Use this command to set the maximum number of commands stored in the command history.

Use the `no` parameter to remove the configuration.

### Command Syntax

```
history max <0-2147483647>
no history max
```

### Parameters

<0-2147483647> Number of commands.

### Default

No default value is specified

### Command Mode

Line mode

### Applicability

This command was introduced before OcNOS version 1.3.

### Examples

```
#configure terminal
(config)#line vty 12 77
(config-line)#history max 123

(config-line)#no history max
```

## hostname

Use this command to set the network name for the device. OcnOS uses this name in system prompts and default configuration filenames.

Setting a host name using this command also sets the host name in the kernel.

**Note:** After giving the `hostname` command, you must write to memory using the [terminal monitor](#) command. If you do not write to memory, the change made by this command (the new host name) is not set after the device reboots.

Use the `no` parameter to disable this function.

### Command Syntax

```
hostname WORD
no hostname (WORD|)
```

### Parameter

WORD	Network name for a system. Per RFC 952 and RFC 1123, a host name string can contain only the special characters period (".") and hyphen ("-"). These special characters cannot be at the start or end of a host name.
------	---

### Default

No default value is specified

### Command Mode

Configure mode

### Applicability

This command was introduced before OcnOS version 1.3.

### Example

```
#configure terminal
(config)#hostname ABC
(config)#

(config)#no hostname
(config)#exit
```

---

## line console

Use the this command to move or change to the line console mode.

### Command Syntax

```
line console <0-0>
```

### Parameters

<0-0>                      First line number.

### Default

No default value is specified

### Command Mode

Configure mode

### Applicability

This command was introduced before OcNOS version 1.3.

### Example

This example enters line mode (note the change in the prompt).

```
#configure terminal
(config)#line console 0
(config-line)#
```

---

## line vty (all line mode)

Use this command to move or change to all line VTY mode.

Note: line vty is just a mode changing command, and it can't exist without sub attributes being configured. i.e exec-timeout.

### Command Syntax

```
line vty
```

### Parameters

None

### Default

No default value is specified

### Command Mode

Configure mode

### Applicability

This command was introduced in OcNOS version 3.0.

### Example

The following example shows entering all line mode (note the change in the prompt).

```
#configure terminal
(config)#line vty
(config-all-line)#exit
(config)#
```

---

## line vty (line mode)

Use this command to move or change to VTY mode. This command is used to connect to a protocol daemon. This configuration is necessary for any session. This configuration should be in the daemon's config file before starting the daemon.

Use the `no` parameter to disable this command.

Note: `line vty` is just a mode changing command, and it can't exist without sub attributes being configured. i.e `exec-timeout`.

### Command Syntax

```
line vty <0-871> <0-871>
no line vty <0-871> (<0-871>|)
```

### Parameters

<code>&lt;0-871&gt;</code>	Specify the first line number.
<code>&lt;0-871&gt;</code>	Specify the last line number.

Note: Configurations (`exec-timeout`) performed under this mode, affects only the current VTY session.

### Default

No default value is specified

### Command Mode

Configure mode

### Applicability

This command was introduced before OcNOS version 1.3.

### Example

The following example shows entering line mode (note the change in the prompt).

```
#configure terminal
(config)#line vty 9
(config-line)#exit
(config)no line vty 9
```



---

## logging cli

Use this command to enable logging commands entered by all users.

Use the `no` parameter to disable logging commands entered by all users.

### Command Syntax

```
logging cli
no logging cli
```

### Parameter

None

### Default

No default value is specified

### Command Mode

Configure mode

### Applicability

This command was introduced before OcNOS version 1.3.

### Example

```
#configure terminal
(config)#logging cli
(config)#no logging cli
```

---

## logout

Use this command to exit the OcNOS shell.

### Command Syntax

```
logout
```

### Parameters

None

### Default

No default value is specified

### Command Mode

Exec mode and privileged exec mode

### Applicability

This command was introduced before OcNOS version 1.3.

### Example

```
>logout
OcNOS login:

>enable
en#logout
>
```

---

## max-session

Use this command to set maximum VTY session limit.

Use `no` form of this command to unset session-limit.

User can configure session-limit for Telnet and SSH sessions separately but this `max-session` parameter value takes the precedence to restrict the maximum number of sessions. If user configured this `max-session` to be 4, then the device would allow only maximum of 4 SSH and Telnet sessions collectively irrespective of the individual SSH and Telnet `max-session` configuration. Active sessions won't be disturbed even if the configured `max-session` limit is lesser than the current active sessions.

### Command syntax

```
max-session <1-40>
```

### Parameters

<1-40>	Number of sessions
--------	--------------------

### Default

By default, 40 sessions are allowed.

### Command Mode

Line mode

### Applicability

This command is introduced in OcNOS version 5.0

### Example

In the following example `max-session` is configured as 4, thus the device would allow only 4 management sessions of SSH and Telnet collectively.

```
#configure terminal
(config)#line vty
(config-all-line)#max-session 5
(config-all-line)#commit
(config-all-line)#exit
(config)#exit
```

## ping

Use this command to send echo messages to another host.

Note: When data packets copied to cpu due to destination lookup fail, both data packets and icmp echo request packets processed in cpu through same cpu queue and it may happen that ping fails due to congestion. In such cases, to check connectivity, please use interactive ping command and update tos value 192. Refer [ping \(interactive\)](#) for the interactive ping command.

### Command Syntax

```
ping WORD (interface IFNAME| source-ip A.B.C.D |) (vrf (NAME|management)|)
ping ip WORD (interface IFNAME| source-ip A.B.C.D |) (vrf (NAME|management)|)
ping ipv6 WORD (interface IFNAME| source-ip X:X::X:X |) (vrf (NAME|management)|)
```

### Parameters

WORD	Destination address (in A.B.C.D format for IPv4 or X:X::X:X for IPv6) or host name.
ip	IPv4 echo.
WORD	Destination address in A.B.C.D format or host name.
ipv6	IPv6 echo.
WORD	Destination address in X:X::X:X format or host name.
interface	Interface name through which the ICMP packets to be sent.
IFNAME	Interface's name
source-ip	Source IP to be used in ICMP packet.
A.B.C.D	Source IPv4 address in the ping.
X:X::X:X	Source IPv6 address in the ping.
vrf	Virtual Routing and Forwarding instance.
NAME	VRF instance name.
management	Management VRF.

### Default

No default value is specified

### Command Mode

Privileged exec mode

### Applicability

This command was introduced before OcNOS version 1.3.

### Examples

```
>enable
#ping 20.20.20.1 vrf management
Press CTRL+C to exit
PING 20.20.20.1 (20.20.20.1) 56(84) bytes of data.
64 bytes from 20.20.20.1: icmp_seq=1 ttl=64 time=0.032 ms
64 bytes from 20.20.20.1: icmp_seq=2 ttl=64 time=0.035 ms
```

---

```
64 bytes from 20.20.20.1: icmp_seq=3 ttl=64 time=0.033 ms
64 bytes from 20.20.20.1: icmp_seq=4 ttl=64 time=0.034 ms
64 bytes from 20.20.20.1: icmp_seq=5 ttl=64 time=0.034 ms
64 bytes from 20.20.20.1: icmp_seq=6 ttl=64 time=0.036 ms
64 bytes from 20.20.20.1: icmp_seq=7 ttl=64 time=0.036 ms
64 bytes from 20.20.20.1: icmp_seq=8 ttl=64 time=0.036 ms

--- 20.20.20.1 ping statistics ---
8 packets transmitted, 8 received, 0% packet loss, time 6999ms
rtt min/avg/max/mdev = 0.032/0.034/0.036/0.006 ms

#ping ipv6 3001:db8:0:1::129 vrf management
Press CTRL+C to exit
PING 3001:db8:0:1::129(3001:db8:0:1::129) 56 data bytes
64 bytes from 3001:db8:0:1::129: icmp_seq=1 ttl=64 time=0.038 ms
64 bytes from 3001:db8:0:1::129: icmp_seq=2 ttl=64 time=0.047 ms
64 bytes from 3001:db8:0:1::129: icmp_seq=3 ttl=64 time=0.047 ms
64 bytes from 3001:db8:0:1::129: icmp_seq=4 ttl=64 time=0.049 ms
64 bytes from 3001:db8:0:1::129: icmp_seq=5 ttl=64 time=0.044 ms
64 bytes from 3001:db8:0:1::129: icmp_seq=6 ttl=64 time=0.048 ms
64 bytes from 3001:db8:0:1::129: icmp_seq=7 ttl=64 time=0.046 ms
64 bytes from 3001:db8:0:1::129: icmp_seq=8 ttl=64 time=0.048 ms

--- 3001:db8:0:1::129 ping statistics ---
8 packets transmitted, 8 received, 0% packet loss, time 6999ms
```

## ping (interactive)

Use this command to send echo messages to another host interactively. You are prompted with options supported by the command.

### Command Syntax

```
ping
```

### Parameters

None

### Default

No default value is specified

### Command Mode

Privileged Exec mode

### Applicability

This command was introduced before OcNOS version 1.3.

### Examples

```
>enable
#ping
Protocol [ip]:
Target IP address: 20.20.20.1
Name of the VRF : management
Repeat count [5]: 6
Time Interval in Sec [1]: 2.2
Datagram size [100]:
Timeout in seconds [2]:
Extended commands [n]:
Ping Broadcast? Then -b [n]:
PING 20.20.20.1 (20.20.20.1) 100(128) bytes of data.
108 bytes from 20.20.20.1: icmp_seq=1 ttl=64 time=0.038 ms
108 bytes from 20.20.20.1: icmp_seq=2 ttl=64 time=0.038 ms
108 bytes from 20.20.20.1: icmp_seq=3 ttl=64 time=0.038 ms
108 bytes from 20.20.20.1: icmp_seq=4 ttl=64 time=0.036 ms
108 bytes from 20.20.20.1: icmp_seq=5 ttl=64 time=0.037 ms
108 bytes from 20.20.20.1: icmp_seq=6 ttl=64 time=0.034 ms

--- 20.20.20.1 ping statistics ---
6 packets transmitted, 6 received, 0% packet loss, time 11000ms
rtt min/avg/max/mdev = 0.034/0.036/0.038/0.007 ms

#ping
Protocol [ip]: ipv6
Target IP address: 3001:db8:0:1::129
Name of the VRF : management
Repeat count [5]:
Time Interval in Sec [1]:
Datagram size [100]:
```

```

Timeout in seconds [2]:
Extended commands [n]:
PING 3001:db8:0:1::129(3001:db8:0:1::129) 100 data bytes
108 bytes from 3001:db8:0:1::129: icmp_seq=1 ttl=64 time=0.050 ms
108 bytes from 3001:db8:0:1::129: icmp_seq=2 ttl=64 time=0.047 ms
108 bytes from 3001:db8:0:1::129: icmp_seq=3 ttl=64 time=0.042 ms
108 bytes from 3001:db8:0:1::129: icmp_seq=4 ttl=64 time=0.048 ms
108 bytes from 3001:db8:0:1::129: icmp_seq=5 ttl=64 time=0.051 ms

--- 3001:db8:0:1::129 ping statistics ---
5 packets transmitted, 5 received, 0% packet loss, time 4000ms
rtt min/avg/max/mdev = 0.042/0.047/0.051/0.008 ms

```

The input prompts are described in [Table 1-9](#):

**Table 1-9: ping output fields**

Protocol [ip]	IPv4 or IPv6. The default is IPv4 if not specified.
Target IP address	IPv4 or IPv6 address or host name.
Name of the VRF	Name of the Virtual Routing and Forwarding instance.
Repeat count [5]	Number of ping packets to send. The default is 5 if not specified.
Time Interval in Sec [1]	Time interval between two ping packets. The default is 1 second if not specified.
Datagram size [100]	Ping packet size. The default is 100 bytes if not specified.
Timeout in seconds [2]	Time to wait for ping reply. The default is 2 seconds if not specified.
Extended commands [n]	Options for extended ping. The default is "no".
Source address or interface	Source address or interface.
Type of service [0]	Types of service. The default is 0 if not specified.
Set DF bit in IP header? [no]	Do not fragment bit. The default value is "no" if not specified.
Data pattern [0xABCD]	Specify a pattern.
Ping Broadcast? Then -b [n]	Broadcast ping. The default is "no". For a broadcast address, the value should be "y".

---

## quit

Use this command to exit the current mode and return to the previous mode. When this command is executed in one of the exec modes, it closes the shell and logs you out.

### Command Syntax

```
quit
```

### Parameters

None

### Default

No default value is specified

### Command Mode

All modes

### Applicability

This command was introduced before OcNOS version 1.3.

### Examples

```
#configure terminal
(config)#interface eth1
(config-if)#quit
(config)#
```

```
>enable
#quit
[root@TSUP-123 sbin]#
```



---

## reload

Use this command to shut down the device and perform a cold restart. You call this command when:

- You detect a configuration issue such as `show running-config` displaying a configuration but when you try to remove that configuration, you get a message that it is not configured.
- You have replaced the start-up configuration file (in this case you specify the `flush-db` parameter).

### Command Syntax

```
reload (flush-db|)
```

### Parameters

<code>flush-db</code>	Delete the database file and recreate it from the start-up configuration file.
-----------------------	--

### Default

No default value is specified

### Command Mode

Privileged Exec mode

### Applicability

This command was introduced before OcNOS version 1.3.

### Example

This example shows replacing a start-up configuration file and then synchronizing it to the configuration database:

```
#copy file /home/TEST.conf startup-config
Copy Success
#
#reload flush-db
The system has unsaved changes.
Would you like to save them now? (y/n): n

Configuration Not Saved!
Are you sure you would like to reset the system? (y/n): y
```

For both of these prompts, you must specify whether to save or discard the changes. Abnormal termination of the session without these inputs can impact the system behavior.

For the `unsaved changes` prompt:

Would you like to save them now?

You should always say “no” to this prompt because otherwise the command takes the current *running configuration* and applies it to the current start-up configuration.

---

## service advanced-vty

Use this command to set multiple options to list when the tab key is pressed while entering a command. This feature applies to commands with more than one option.

Use the `no` parameter to not list options when the tab key is pressed while entering a command.

### Command Syntax

```
service advanced-vty
no service advanced-vty
```

### Parameters

None

### Default

No default value is specified

### Command Mode

Configure mode

### Applicability

This command was introduced before OcNOS version 1.3.

### Examples

```
#configure terminal
(config)#service advanced-vty
(config)#no service advanced-vty
```

---

## service password-encryption

Use this command to encrypt passwords created with the [enable password](#) command. Encryption helps prevent observers from reading passwords.

Use the `no` parameter to disable this feature.

### Command Syntax

```
service password-encryption
no service password-encryption
```

### Parameters

None

### Default

No default value is specified

### Command Mode

Configure mode

### Applicability

This command was introduced before OcNOS version 1.3.

### Example

```
#configure terminal
(config)#enable password mypasswd
(config)#service password-encryption
```

---

## service terminal-length

Use this command to set the number of lines that display at one time on the screen for the current terminal session.

Use the `no` parameter to disable this feature.

### Command Syntax

```
service terminal-length <0-512>
no service terminal-length (<0-512>|)
```

### Parameters

`<0-512>`                    Number of lines to display. A value of 0 prevents pauses between screens of output.

### Default

No default value is specified

### Command Mode

Configure mode

### Applicability

This command was introduced before OcNOS version 1.3.

### Example

```
#configure terminal
(config)#service terminal-length 60
```

---

## show clock

Use this command to display the current system time.

### Command Syntax

```
show clock
```

### Parameters

None

### Command Mode

Exec mode and Privileged Exec mode

### Applicability

This command was introduced before OcNOS version 1.3.

### Examples

```
#show clock  
12:54:02 IST Fri Apr 29 2016
```

## show cli

Use this command to display the command tree of the current mode.

### Command Syntax

```
show cli
```

### Parameters

None

### Default

None

### Command Mode

All command modes

### Applicability

This command was introduced before OcNOS version 1.3.

### Example

```
#show cli
Exec mode:
+-clear
  +-arp-cache [clear arp-cache]
  +-ethernet
    +-cfm
      +-errors
        +-domain
          +-DOMAIN_NAME [clear ethernet cfm errors (domain DOMAIN_NAME|level
LEVEL_ID) (bridge <1-32>|)]
            +-bridge
              +-<1-32> [clear ethernet cfm errors (domain DOMAIN_NAME|level
LEVEL_ID) (bridge <1-32>|)]
                +-level
                  +-LEVEL_ID [clear ethernet cfm errors (domain DOMAIN_NAME|level
LEVEL_ID) (bridge <1-32>|)]
                    +-bridge
                      +-<1-32> [clear ethernet cfm errors (domain DOMAIN_NAME|level
LEVEL_ID) (bridge <1-32>|)]
                        +-maintenance-points
                          +-remote
                            +-domain
                              +-DOMAIN_NAME [clear ethernet cfm maintenance-points remote(domain
D
--More--
```

## show cli history

Use this command to list the commands entered in the current session. The history buffer is cleared automatically upon reboot.

### Command Syntax

```
show cli history
```

### Parameters

None

### Command Mode

Exec mode and Privileged Exec mode

### Applicability

This command was introduced before OcNOS version 1.3.

### Examples

```
#show cli history
 1 en
 2 show ru
 3 con t
 4 show spanning-tree
 5 exit
```

## show crypto csr

Use this command to display the Certificate Signing Request (CSR) created with the [crypto pki generate rsa common-name ipv4](#) command.

### Command Syntax

```
show crypto csr
```

### Parameters

None

### Default

None

### Command Mode

Privileged Exec mode

### Applicability

This command was introduced in OcNOS version 5.0.

### Example

```
#crypto pki generate rsa common-name ipv4 7.7.7.7
#show crypto csr
-----BEGIN CERTIFICATE REQUEST-----
MIICVzCCAT8CAQAwEjEQMA4GA1UEAwwHNy43LjcuNzCCASIwDQYJKoZIhvcNAQEB
BQADggEPADCCAQoCggEBAMkzIZaxNYPd8PW0hexecUfKq9pJn5IJzJkOQDtovFOT
zeLPRxBaOt1NVd+lEF+wy3AgnGMw004g4AP7qaE+S5X1vKGAjagt fh/gfDAPDUtM
CpYLMCACM7n76OmyP9eUpkMbOSPkZDIBZfjUMxDTFwkzCBH+BF6SkSxtA24NUA9z
5heCIb1ArXYjdlIeB+9FfiVdOZ5yxQsLY8604ONL7Up1766SArGQo6oZ1dJ+bc91
sQVCEpF40SdCnN+Uw3R0cPfQF81BJD4H0EHf1VnHtYJwQ1yax6qc5ghT9R/rABDa
BFB3R09QpjV4Ihd/MyrdQmEIoxHeNNvSGDj9+eiEpksCAwEAAaAAMA0GCSqGSIb3
DQEBCwUAA4IBAQAwwXkQmNf3yiL+pmpwvE+gU8KVp3i4cvD13Vjh7IQMkCT47WPam
DUiYgwk+dPVAI+iWZq4qTvUNn6xahOyN5rnkTz9eipsQ1YHPpZB7hj5fimWwzJws
m4Tun0GZieEBCROqUpbuW+6QDvtR3XSzHhdGGSIteZv9cYyKhNu007okwr67c2Ea
11b7PcultOb4wj3xjqao/ENDG+nmdUPaIKZrAwf2fEOarOaHgKwcl1AHHbusbJWL
qH0fA1OyVgfvG/WuCPP6Peg/Cpla7bDWqeGYt9vFTtekKoOMQLzJwl6oINbtBCcw
DZJpeaQpUhFm+ZOjwibZ5NGPBRSTuYncp5xJ
-----END CERTIFICATE REQUEST-----
```



---

## show debugging nsm

Use this command to display debugging information.

### Command Syntax

```
show debugging nsm
```

### Parameters

None

### Default

None

### Command Mode

Exec mode and privileged exec mode

### Applicability

This command was introduced before OcNOS version 1.3.

### Examples

```
#show debugging nsm
NSM debugging status:
  NSM event debugging is on
  NSM packet debugging is on
  NSM kernel debugging is on
```

---

## show debugging vm-events

Use this command to display the vm-events debugging information

### Command Syntax

```
show debugging events
```

### Parameters

None

### Default

No default value specified.

### Command Mode

Exec mode

### Applicability

This command was introduced before OcNOS version 6.1.0

### Examples

```
#show debugging vm-events#
```

---

## show list

Use this command to display the commands relevant to the current mode.

### Command Syntax

```
show list
```

### Parameters

None

### Default

None

### Command Mode

All command modes except IPv4 access-list and IPv6 access-list mode.

### Applicability

This command was introduced before OcNOS version 1.3.

### Example

```
>show list
clear arp-cache
clear bgp *
clear bgp * in
clear bgp * in prefix-filter
clear bgp * out
clear bgp * soft
clear bgp * soft in
clear bgp * soft out
clear bgp <1-4294967295>
clear bgp <1-4294967295> in
clear bgp <1-4294967295> in prefix-filter
clear bgp <1-4294967295> out
clear bgp <1-4294967295> soft
clear bgp <1-4294967295> soft in
clear bgp <1-4294967295> soft out
clear bgp (A.B.C.D|X:X::X:X)
clear bgp (A.B.C.D|X:X::X:X) in
clear bgp (A.B.C.D|X:X::X:X) in prefix-filter
clear bgp (A.B.C.D|X:X::X:X) out
clear bgp (A.B.C.D|X:X::X:X) soft
clear bgp (A.B.C.D|X:X::X:X) soft in
clear bgp X:X::X:X soft out
```

```
--more--
```

---

## show logging cli

Use this command to display command history for all users.

### Command Syntax

```
show logging cli ((logfile LOGFILENAME)|) (match-pattern WORD |)
show logging cli last <1-9999>
show logging logfile list
```

### Parameters

LOGFILENAME	Name of a saved command history log file. The default path is <code>/var/log/messages</code> , but you can specify a full path to override the default.
WORD	Display only lines with this search pattern.
<1-9999>	Number of lines to display from the end of the command history.
logfile list	Display a list of command history files.

### Default

LOGFILENAME Name of a saved command history log file. The default path is `/var/log/messages`, but you can specify a full path to override the default.

### Command Mode

Exec mode

### Applicability

This command was introduced before OcNOS version 1.3.

### Example

```
#sh logging cli
2017 Mar 01 16:30:59 : OcNOS : User root@/dev/pts/1 : CLI : 'exit'
2017 Mar 01 16:31:06 : OcNOS : User root@/dev/pts/1 : CLI : 'sh logging logfile list'
#sh logging cli logfile ipi
2017 Mar 01 16:30:59 : OcNOS : User root@/dev/pts/1 : CLI : 'exit'
2017 Mar 01 16:31:06 : OcNOS : User root@/dev/pts/1 : CLI : 'sh logging logfile list'
#sh logging cli match-pattern root
2017 Mar 01 16:30:59 : OcNOS : User root@/dev/pts/1 : CLI : 'exit'
2017 Mar 01 16:31:06 : OcNOS : User root@/dev/pts/1 : CLI : 'sh logging logfile list'
#sh logging cli logfile ipi match-pattern root
2017 Mar 01 16:30:59 : OcNOS : User root@/dev/pts/1 : CLI : 'exit'
2017 Mar 01 16:31:06 : OcNOS : User root@/dev/pts/1 : CLI : 'sh logging logfile list'
#show logging cli last 2
2017 Mar 1 16:34:26.302 : OcNOS : User root@/dev/pts/1 : CLI : 'sh logging info'
2017 Mar 1 16:34:37.317 : OcNOS : User root@/dev/pts/1 : CLI : 'sh logging cli last 2'
#show logging logfile list
file1
file2
```

---

## show nsm client

Use this command to display NSM client information including the services requested by the protocols, statistics and the connection time

### Command Syntax

```
show nsm client
```

### Parameters

None

### Default

None

### Command Mode

Privileged Exec mode

### Applicability

This command was introduced before OcNOS version 1.3.

### Example

```
#show nsm client
NSM client ID: 1

NSM client ID: 19
IMI, socket 23
Service: Interface Service, Router ID Service, VRF Service
Message received 1, sent 58
Connection time: Thu Jul 22 11:03:12 2010
Last message read: Service Request
Last message write: Link Up
NSM client ID: 25
ONMD, socket 24
Service: Interface Service, Bridge service, VLAN service
Message received 2, sent 74
Connection time: Thu Jul 22 11:03:15 2010
Last message read: OAM LLDP msg
Last message write: Link Up
#
```

---

## show process

Use this command to display the OcnOS daemon processes that are running.

### Command Syntax

```
show process
```

### Parameters

None

### Command Mode

Exec modes

### Applicability

This command was introduced before OcnOS version 1.3.

### Example

```
#show process
PID NAME          TIME          FD
 1 nsm             00:56:29     7
 2 ripd           00:56:29    11
 3 ripngd         00:56:29    12
 4 ospfd          00:56:29     9
 5 ospf6d         00:56:29    10
 6 bgpd           00:56:29    14
 9 isisd          00:56:29     8
#
```

[Table 1-10](#) explains the output fields.

**Table 1-10: show process fields**

Entry	Description
PID Name	Process identifier name.
TIME	(S)—Number of system and user CPU seconds that the process has used. (None, D, and E)—Total amount of time that the command has been running.
FD	The Flexible Data-Rates (FD) of the interface.

---

## show running-config

Use this command to show the running system status and configuration.

### Command Syntax

```
show running-config
show running-config full
```

### Parameters

`full` Display the full configuration information.

### Command Mode

Privileged exec mode and configure mode

### Applicability

This command was introduced before OcNOS version 1.3.

### Example

```
#show running-config
no service password-encryption
!
no service dhcp
ip domain-lookup
!
mpls propagate-ttl
!
vrrp vmac enable
spanning-tree mode provider-rstp
no data-center-bridging enable
!
interface lo
 ip address 127.0.0.1/8
 ipv6 address ::1/128
 no shutdown
!
interface eth0
 ip address 10.1.2.173/24
 no shutdown
!
interface eth1
 shutdown

!
line con 0
 login
!
end
(config)#
```

---

## show running-config switch

Use this command to display the running system switch configuration.

### Command Syntax

```
show running-config switch bridge
show running-config switch dot1x
show running-config switch gmrp
show running-config switch gvrp
show running-config switch lacp
show running-config switch lmi
show running-config switch mstp
show running-config switch radius-server
show running-config switch rpvst+
show running-config switch rstp
show running-config switch ptp
show running-config switch stp
show running-config switch synce
show running-config switch vlan
```

### Parameters

bridge	Display Bridge group information.
dot1x	Display 802.1x port-based authentication information.
gmrp	Display GARP Multicast Registration Protocol (GMRP) information.
gvrp	Display GARP VLAN Registration Protocol (GVRP) information.
lacp	Display Link Aggregation Control Protocol (LACP) information.
lmi	Display Ethernet Local Management Interface Protocol (LMI) information.
mstp	Display Multiple Spanning Tree Protocol (MSTP) information.
radius-server	Display RADIUS server information.
rpvst+	Display Rapid Per-VLAN Spanning Tree (rpvst+) information.
rstp	Display Rapid Spanning Tree Protocol (RSTP) information.
ptp	Display Precision time Protocol (PTP)
stp	Display Spanning Tree Protocol (STP) information.
synce	Display synce information.
vlan	Display values associated with a single VLAN.

### Default

None



**Command Mode**

Privileged exec mode, configure mode, router-map mode

**Applicability**

This command was introduced before OcNOS version 1.3.

**Example**

```
(config)#show running-config switch stp
!  
bridge 6 ageing-time 45  
bridge 6 priority 4096  
bridge 6 max-age 7
```

---

## show startup-config

Use this command to display the startup configuration.

### Command Syntax

```
show startup-config
```

### Parameters

None

### Default

None

### Command Mode

Privileged exec mode

### Applicability

This command was introduced before OcNOS version 1.3.

### Example

```
#show startup-config
!    2001/04/21 11:38:52
!
hostname ripd
password zebra
log stdout
!
debug rip events
debug rip packet
!
interface lo
!
interface eth0
 ip rip send version 1 2
 ip rip receive version 1 2
!
interface eth1
 ip rip send version 1 2
 ip rip receive version 1 2
!
router rip
 redistribute connected
 network 10.10.10.0/24
 network 10.10.11.0/24
!
line vty
 exec-timeout 0 0
```

## show tcp

Use this command to display the Transmission Control Protocol (TCP) connection details.

### Command Syntax

```
show tcp
```

### Parameters

None

### Command Mode

Exec mode and privileged exec mode

### Applicability

This command was introduced before OcNOS version 1.3.

### Example

```
#show tcp
Proto Recv-Q Send-Q Local Address          Foreign Address        State
tcp      0      0 0.0.0.0:22            0.0.0.0:*             LISTEN
tcp      0      0 127.0.0.1:25          0.0.0.0:*             LISTEN
tcp      0      1 10.12.44.1:57740      127.0.0.1:705        CLOSE_WAIT
tcp     52      0 10.12.44.21:22        10.12.7.89:705       ESTABLISHED
tcp     85      0 10.12.44.21:57742     10.12.44.21:57738    ESTABLISHED
```

**Table 1-11: Show tcp output**

Entry	Description
Proto	Protocol – TCP
Recv-Q	Number of TCP packets in the Receive Queue.
Send-Q	Number of TCP packets in the Send-Q.
Local Address and port number	Local IP address and the port number.

**Table 1-11: Show tcp output (Continued)**

Entry	Description
Foreign Address and port number	Foreign (received) IP address and the port number.
State	Current state of TCP connections: ESTABLISHED SYN_SENT SYN_RECV FIN_WAIT1 FIN_WAIT2 TIME_WAIT CLOSE CLOSE_WAIT LAST_ACK LISTEN CLOSING UNKNOWN

---

## show timezone

Use this command to display the list of timezone names.

### Command Syntax

```
show timezone
(all|africa|america|antarctica|arctic|asia|atlantic|australia|brazil|canada|chile|europe|indian|mexico|pacific|us)
```

### Parameters

africa	Africa timezone list
all	All timezone list
l2-profile-three	L2 profile Three (default); the size of the I2 table (Mac address table) and I3 table (Host table) is almost equal
l3-profile	L3 profile
america	America timezone list
antarctica	Antarctica timezone list
asia	Asia timezone list
atlantic	Atlantic timezone list
australia	Australia timezone list
brazil	Brazil timezone list
canada	Canada timezone list
chile	Chile timezone list
europe	Europe timezone list
indian	Indian timezone list
mexico	Mexico timezone list
pacific	Pacific timezone list
us	US timezone list

### Default

None

### Command Mode

Exec mode and Privileged Exec mode

### Applicability

This command was introduced before OcNOS version 1.3.

### Example

```
#show timezone asia
Asia:
Kuwait
```

## Basic Commands

---

Samarkand  
Novosibirsk  
Hebron  
Singapore  
Dushanbe  
Rangoon  
Riyadh  
Thimphu  
Shanghai  
Phnom\_Penh  
Taipei  
Qyzylorda  
Ho\_Chi\_Minh  
Urumqi  
Chita  
Khandyga  
Nicosia  
Jerusalem  
Ashkhabad  
Gaza  
Tel\_Aviv  
Baghdad  
Anadyr  
Tehran  
Ashgabat  
Saigon  
Damascus  
Sakhalin  
Yekaterinburg  
Baku  
Bangkok  
Kashgar  
Macao  
Seoul  
Jakarta  
Aden  
Katmandu  
Amman  
Ujung\_Pandang  
Kuching  
Hong\_Kong  
Ulan\_Bator  
Dhaka  
Macau  
Omsk  
Vientiane  
Pyongyang  
Ust-Nera  
Manila  
Srednekolymsk  
Tbilisi  
Kamchatka  
Magadan  
Istanbul  
Chongqing  
Jayapura  
Yerevan

Makassar  
Colombo  
Karachi  
Hovd  
Novokuznetsk  
Krasnoyarsk  
Irkutsk  
Kabul  
Kolkata  
Dacca  
Brunei  
Calcutta  
Kathmandu  
Bishkek  
Qatar  
Tashkent  
Aqtau  
Oral  
Kuala\_Lumpur  
Pontianak  
Harbin  
Aqtobe  
Bahrain  
Muscat  
Vladivostok  
Dubai  
Tokyo  
Chungking  
Almaty  
Choibalsan  
Thimbu  
Beirut  
Dili  
Yakutsk  
Ulaanbaatar

## show users

Use this command to display information about current users.

### Command Syntax

```
show users
```

### Parameters

None

### Command Mode

Exec mode and Privileged Exec mode

### Applicability

This command was introduced before OcNOS version 1.3.

### Example

```
#show users
Current user      : (*). Lock acquired by user : (#).
CLI user         : [C]. Netconf users       : [N].
Location : Applicable to CLI users.
Session  : Applicable to NETCONF users.
```

	Line	User	Idle	Location/Session	PID	TYPE	Role
(*)	130 vty 0	[C]root	00:00:36	pts/0	20872	Local	network-admin
(#)	NA	[N]root	NA	1	NA	NA	network-admin
	NA	[N]root	NA	2	NA	NA	network-admin
	131 vty 1	[C]joyce	00:00:26	pts/1	17593	Remote	network-admin

[Table 1-12](#) explains the output fields.

**Table 1-12: show users fields**

Entry	Description
Current users	
CLI user	
Location	
Session	
Lock acquired by user	
Netconf users	
Line	
User	User name.



**Table 1-12: show users fields**

<b>Entry</b>	<b>Description</b>
Idle	How long the user has been idle.
Location/Session	
PID	Process identifier name.
Type	
Role	

---

## show version

Use this command to display OcNOS version information.

### Command Syntax

```
show version
```

### Parameters

None

### Default

None

### Command Mode

Exec mode and privileged exec mode

### Applicability

This command was introduced before OcNOS version 1.3.

### Example

```
#show version
Software version: UFI_S9600-56DX-OcNOS-SP-PLUS-6.3.2-MR 08/29/2023 03:03:23
Copyright (C) 2023 IP Infusion. All rights reserved

Software Product: OcNOS-SP, Version: 6.3.2
Build Number: 47
Release: MR
Hardware Model: Ufi Space S9600-56DX-B
Software Feature Code: PLUS
Software Baseline Version: 6.0.117

Installation Information:
Image Filename: OcNOS-SP-PLUS-Q2-6.3.2-47-MR-installer
ONIE-SysInfo: x86_64-ufispace_s9600_56dx-r0
#
```

**Table 1-13: Show version output**

Entry	Description
Software version	The software version including hardware device name and date.
Software Product	Product name and version.
Hardware Model	Hardware platform.
Software Feature Code	SKU that specifies the capabilities of this version of the software.
Software Baseline Version	Version from which this release branch is created.
Installation Information	Information about the installation.

---

**Table 1-13: Show version output (Continued)**

<b>Entry</b>	<b>Description</b>
Image Filename	The file name of the installed image.
ONIE SysInfo	ONIE version.

---

## sys-reload

Use this command to cold restart the device.

Note: This command is an alias for the [reload](#) command.

### Command Syntax

```
sys-reload
```

### Parameters

None

### Default

None

### Command Mode

Exec mode

### Applicability

This command was introduced in OcNOS version 1.3.7.

### Example

```
>sys-reload
The system has unsaved changes.
Would you like to save them now? (y/n): y
Building Configuration...
[OK]
Are you sure you would like to reset the system? (y/n): n
```

---

## sys-shutdown

Use this command to shut down the device gracefully. After giving this command, you can remove the device power cable.

Note: Some of the switch hardwares doesn't support system shutdown. On such devices this command will make the switch to go for a reboot.

### Command Syntax

```
sys-shutdown
```

### Parameters

None

### Default

None

### Command Mode

Exec mode

### Applicability

This command was introduced in OcNOS version 1.3.7.

### Example

```
>sys-shutdown
The system has unsaved changes.
Would you like to save them now? (y/n): y
Building Configuration...
[OK]
Are you sure you would like to shutdown the system? (y/n): y
For both of these prompts, you must specify whether to save or discard the
changes.
For the unsaved changes prompt:
Would you like to save them now?
```

---

## terminal width

Use this command to set the number of characters to be displayed in one line on the screen. Use the no option to unset the number of characters on the screen.

Note: If user wants to have a fixed terminal length and width, then terminal length should not be set to 0. i.e. CLI "terminal length 0" should not be used, and only non-zero length to be used.

### Command Syntax

```
terminal width <24-511>
terminal no width <24-511>
```

### Parameters

<24-511>            Number of lines on screen

### Default

Default width value 80 is optionally overridden by kernel.

### Command Mode

Exec mode and Privileged Exec mode

### Applicability

This command was introduced before OcNOS version 1.3.

### Examples

```
host#terminal width 120
```

## terminal length

Use this command to set the number of lines displayed on the screen.

Use the `no` option to unset the number of lines on a screen.

Note: If user wants to have a fixed terminal length and width, then terminal length should not be set to 0. i.e. CLI “terminal length 0” should not be used, and only non-zero length to be used.

### Command Syntax

```
terminal length <0-511>
terminal no length <0-511>
```

### Parameters

<0-511>                    Number of lines on screen. Specify 0 for no pausing.

### Default

Default length value 24 is optionally overridden by kernel.

### Command Mode

Exec mode and Privileged Exec mode

### Applicability

This command was introduced before OcnOS version 1.3.

### Examples

```
>enable
#terminal length 0
```

The following example sets the terminal length to 30 lines.

```
#terminal length 30
```

---

## terminal monitor

Use this command to display debugging output on a terminal.

Use one of the optional parameters to display debugging output for the OcNOS user. When the command is used without a parameter, it can be used by a OcNOS user to display the debug output on the terminal for the user local OcNOS. When used with a parameter, it may be used only by a OcNOS user.

The `no` form of the command terminates the debug output on the terminal. The OcNOS user can use this command. In addition, the OcNOS user can cancel a debug output from a specific VR or all VRs.

### Command Syntax

```
terminal monitor
terminal monitor (all|WORD|)
terminal no monitor
terminal no monitor (WORD|)
```

### Parameters

<code>WORD</code>	Used in the PVR context, and contains the VR name to be included in the debugging session.
<code>all</code>	Used the PVR context to include all VR in a PVR debugging session.

### Default

No default value is specified

### Command Mode

Privileged Exec mode

### Applicability

This command was introduced before OcNOS version 1.3.

### Example

```
>Enable
#terminal monitor
#terminal no monitor
```



---

## traceroute

Use this command to trace an IPv4/v6 route to its destination.

### Command Syntax

```
traceroute WORD
traceroute WORD (vrf (NAME|management) |)
traceroute ip WORD
traceroute ip WORD (vrf (NAME|management) |)
traceroute ipv6 WORD
traceroute ipv6 WORD (vrf (NAME|management) |)
```

### Parameters

WORD	Destination address (in A.B.C.D format for IPv4 or X:X::X:X for IPv6) or host name.
vrf	Virtual Routing and Forwarding instance.
NAME	Virtual Routing and Forwarding name.
management	Virtual Routing and Forwarding name.
ip	IPv4 echo.
WORD	Destination address in A.B.C.D format or host name.
ipv6	IPv6 echo.
WORD	Destination address in X:X::X:X format or host name.

### Default

No default value is specified

### Command Mode

Privileged Exec mode

### Applicability

This command was introduced before OcNOS version 1.3.

### Example

```
#traceroute ip 10.10.100.126 vrf management
traceroute to 10.10.100.126 (10.10.100.126), 30 hops max, 38 byte packets
 1  10.1.2.1 (10.1.2.1)  0.386 ms  0.315 ms  0.293 ms
 2  10.10.100.126 (10.10.100.126)  1.944 ms  1.497 ms  1.296 ms
#
```

---

## watch static-mac-movement

Use this command to watch if any MAC movement is detected over static MAC entries for a time period. A notification will display if static MAC movement happens before the timer expires.

The counters can be validated with [show interface counters queue-stats](#) for the L2 movement queue (Tx pkts and Dropped pkts columns).

Without enabling `watch static-mac-movement`, the statistics are reflected in the Rx EGR Port Unavail of [show interface counters queue-drop-stats](#).

For VXLAN, `watch static-mac-movement` applies to all the MAC entries learned from the remote peer (remote dynamic or static remote), as these learned MACs are installed as static MAC entries in the hardware.

### Command Syntax

```
watch static-mac-movement (<1-300>|)
```

### Parameters

<1-300>                      Timer value in seconds.

### Default

By default, the timer is 10 seconds

### Command Mode

Exec mode

### Applicability

This command was introduced before OcNOS version 1.3.

### Examples

```
#watch static-mac-movement
```

---

## write

Use this command to write the running configuration to the file used at startup or to a specified file. This is the same as the `copy running-config startup-config` command.

### Command Syntax

```
write
write file FILE
write memory
write WORD
```

### Parameters

FILE	Write to a given path and file. If you do not give a file path, the file is added to <code>/root</code> .
memory	Write to non-volatile memory.
WORD	Write to running configuration file path.

### Default

No default value is specified

### Command Mode

Privileged Exec mode

### Applicability

This command was introduced before OcNOS version 1.3.

### Example

This example shows writing the running configuration to the startup configuration file:

```
#write
Building configuration...
[OK]
```

This example shows writing the running configuration to a specified file:

```
#write file /home/test.txt
Building configuration...
[OK]
```

---

## write terminal

Use this command to display the current configuration.

### Command Syntax

```
write terminal
```

### Parameters

None

### Default

No default value is specified

### Command Mode

Privileged Exec mode

### Applicability

This command was introduced before OcNOS version 1.3.

### Example

```
#write terminal

Current configuration:
!
hostname ripd
password zebra
log stdout
!
debug rip events
debug rip packet
!
interface lo
!
interface eth0
 ip rip send version 1 2
 ip rip receive version 1 2
!
interface eth1
 ip rip send version 1 2
 ip rip receive version 1 2
!
!
router rip
 network 10.10.10.0/24
 network 10.10.11.0/24
 redistribute connected
!
line vty
 exec-timeout 0 0
```

---

## CHAPTER 2 Common Management Layer Commands

---

This chapter is a reference for the Common Management Layer (CML) commands.

Transaction are enabled by default. You can disable the feature by using the [cmlsh transaction](#) command outside of configuration mode, but IP Infusion Inc. does *not* recommend this.

These are the steps to follow to use transactions:

- When transactions are enabled, any changes done in configure mode are stored in a separate *candidate* configuration that you can view with the [show transaction current](#) command.
- When a configuration is complete, apply the candidate configuration to the running configuration with the [commit](#) command.
- If a [commit](#) fails, no configuration is applied as the entire transaction is considered failed. You can continue to change the candidate configuration and then retry the [commit](#).
- Discard the candidate configuration with the [abort transaction](#) command.
- Check the last aborted transaction with the [show transaction last-aborted](#) command.

This chapter describes these commands:

- [abort transaction](#)
- [cancel-commit](#)
- [cml force-unlock config-datastore](#)
- [cml lock config-datastore](#)
- [cml logging](#)
- [cml netconf translation](#)
- [cml notification](#)
- [cml unlock config-datastore](#)
- [cmlsh cli-format](#)
- [cmlsh multiple-config-session](#)
- [cmlsh notification](#)
- [cmlsh transaction](#)
- [cmlsh transaction limit](#)
- [commit](#)
- [confirm-commit](#)
- [commit dry-run](#)
- [debug cml](#)
- [module notification](#)
- [show cml config-datastore lock status](#)
- [show cml notification status](#)
- [show cmlsh multiple-config-session status](#)
- [show cmlsh notification status](#)
- [show max-transaction limit](#)
- [show module-info](#)

- `show running-config notification`
- `show system restore failures`
- `show transaction current`
- `show transaction last-aborted`
- `show (xml|json) running-config|candidate-config`

---

## abort transaction

Use this command to end a configuration session and discard all uncommitted changes.

### Command Syntax

```
abort transaction
```

### Parameters

None

### Default

N/A

### Mode

Configure mode

### Applicability

This command was introduced in OcNOS version 5.0.

### Example

```
(config)#  
(config)#interface eth2  
(config-if)#ip address 10.12.3.4/24  
(config-if)#exit  
(config)#abort transaction  
(config)#exit  
#show running-config interface eth2  
!  
interface eth2  
!  
#
```

---

## cancel-commit

Use this command to revert configuration changes immediately before the timeout in a “confirmed commit” operation.

Note: This command does not support the <persist-id> parameter as specified in RFC 6241.

### Command Syntax

```
cancel-commit
```

### Parameters

None

### Default

N/A

### Mode

All configuration modes

### Applicability

This command was introduced in OcNOS version 6.3.0.

### Example

```
(config)#router ospf 1
(config-router)#router ospf 2
(config-router)#commit confirmed timeout 100 description This is a test for confirmed
commit
(config-router)#
(config-router)#cancel-commit
```



---

## cml force-unlock config-datastore

Use this command to release a configuration lock previously obtained with the [cml lock config-datastore](#) command by a *different* user.

This command is available only to users with the `network-admin` role.

A notification message is sent to the lock holder when forced out.

### Command Syntax

```
cml force-unlock config-datastore (running|startup|candidate) (<0-600>|)
```

### Parameters

<code>&lt;0-600&gt;</code>	Timeout interval to force out lock acquired by another user session. Zero (0) is immediate and is the default.
<code>running</code>	Release the lock on the running datastore.
<code>startup</code>	Release the lock on the startup datastore.
<code>candidate</code>	Release the lock on the candidate datastore.

### Default

The default timeout is zero (0) which is immediate.

### Mode

Exec mode

### Applicability

This command was introduced in OcNOS version 5.1.

### Example

```
#cml force-unlock config-datastore running
```

---

## cml lock config-datastore

Use this command to lock the entire configuration datastore of a device. Such locks are intended to be short-lived and allow you to make a change without fear of interaction with other users.

When the lock is acquired, the server prevents any changes to the locked resource other than those requested by this session.

The duration of the lock is defined as beginning when the lock is acquired and lasting until either the lock is released or the user session closes. The session closure can be explicitly performed by the user, or implicitly performed by the server based on criteria such as failure of the underlying transport, simple inactivity timeout, or detection of abusive behavior on the part of the client.

A lock will not be granted if any of the following conditions is true:

- A lock is already held by any user session or another entity.
- The target configuration is candidate, it has already been modified, and these changes have not been committed or rolled back.
- The target configuration is running, and another user session has an ongoing confirmed commit.

### Command Syntax

```
cml lock config-datastore (running|startup|candidate)
```

### Parameters

running	Lock on this datastore will not allow other sessions to perform operations with the target as running like commit, copy candidate to running and so on.
startup	Lock on this datastore will not allow other sessions to perform operations like copy-config and delete-config with the target startup
candidate	Lock on this datastore will not allow other sessions to perform operations with the target as candidate like edit-config, copy file candidate and so on. (Not supported in OcNOS version 5.1.)

### Default

All three datastores are in the unlocked state.

### Mode

Exec mode

### Applicability

This command was introduced in OcNOS version 5.1.

### Example

```
#cml lock config-datastore running
#
#show users
Current user      : (*). Lock acquired by user : (#).
CLI user         : [C]. Netconf users       : [N].
Location : Applicable to CLI users.
Session  : Applicable to NETCONF users.
```

Line	User	Idle	Location/Session	PID	TYPE	Role
(#) (*) 130 vty 0	[C]ocnos	0d00h00m	pts/0	10732	Local	network-admin

## cml logging

Use this command to enable or disable CML logging. The logging level and [debug cml](#) should also be configured.

### Command Syntax

```
cml logging (enable | disable)
```

### Parameters

enable	Enable CML logging
disable	Disable CML logging

### Default

By default CML Logging is enabled.

### Mode

Configure mode

### Applicability

This command was introduced in OcNOS version 5.0.

### Example

```
(config)#cml logging disable
```

---

## cml netconf translation

Use this command to enable or disable NetConf support for OpenConfig-based YANG translation. This allows OcnOS to handle OpenConfig YANG files in its NetConf server.

### Command Syntax

```
cml netconf translation (disable|openconfig)
```

### Parameters

disable	Do not translate NetConf to YANG
openconfig	Translate NetConf to YANG

### Default

By default NetConf-to-YANG translation is disabled.

### Mode

Exec mode

### Applicability

This command was introduced before OcnOS version 4.2.

### Example

```
#cml netconf translation openconfig
```

---

## cml notification

Use this command to enable or disable notification for a given CML client.

### Command Syntax:

```
cml notification (enable|disable) (netconf|snmp|cmlsh|all)
```

### Parameters

disable	Disable notification subscription
enable	Enable notification subscription
all	All CML clients
cmlsh	CML client CMLSH
netconf	CML client NETCONF
snmp	CML client SNMP

### Default

By default, notification is enabled for all CML clients.

### Mode

Exec mode

### Applicability

This command was introduced in OcNOS version 6.0.0.

### Example

To enable notification for NETCONF client:

```
#cml notification enable netconf
```

To disable notification for NETCONF client:

```
#cml notification disable netconf
```

---

## cml unlock config-datastore

Use this command to release a configuration lock previously obtained with the [cml lock config-datastore](#) command.

An unlock operation will not succeed if either of the following conditions is true:

- The specified lock is not currently active.
- The session calling this command is not the same session that obtained the lock.

### Command Syntax

```
cml unlock config-datastore (running|startup|candidate)
```

### Parameters

running	Release the lock on the running datastore.
startup	Release the lock on the startup datastore.
candidate	Release the lock on the candidate datastore.

### Default

N/A

### Mode

Exec mode

### Applicability

This command was introduced in OcNOS version 5.1.

### Example

```
#cml unlock config-datastore running
#
#show users
Current user      : (*). Lock acquired by user : (#).
CLI user         : [C]. Netconf users       : [N].
Location : Applicable to CLI users.
Session  : Applicable to NETCONF users.

      Line      User           Idle           Location/Session  PID      TYPE      Role
(*) 130 vty 0   [C]ocnos       0d00h00m      pts/0            10732    Local    network-admin
#
```

---

## cmlsh cli-format

Use this command to display command strings in CLI error messages. By default, OcNOS displays error messages with Xpaths (path notation for navigating through the hierarchical structure of an XML document) which is not very clear for users.

### Command Syntax

```
cmlsh cli-format (enable | disable)
```

### Parameters

enable	Display command strings in CLI error messages.
disble	Display Xpaths in CLI error messages.

### Default

Display Xpaths in CLI error messages

### Mode

Exec mode

### Applicability

This command was introduced in OcNOS version 6.3.0.

### Example

This is the default behavior where an Xpath is displayed:

```
>en
#configure terminal
Enter configuration commands, one per line. End with CNTL/Z.
(config)#router ospf 10
(config-router)#area 3.3.3.3 interface xel
(config-router)#commit
% Configuration " /ospfv2/processes/process[ospf-id='10']/areas/area[area-id='3.3.3.3']/interfaces/interface[name='xel']/vrf-name" depends on "/ospfv2/global/config/area-interface-config-mode"
% Failed to commit .. As error(s) encountered during commit operation..
```

If you enable this feature, the Xpath is replaced with the respective command string:

```
>en
#cmlsh cli-format enable
#configure terminal
Enter configuration commands, one per line. End with CNTL/Z.
(config)#router ospf 10
(config-router)#area 3.3.3.3 interface xel
(config-router)#commit
% Configuration " area <value-option> interface <value-option>" depends on " ospf area-interface-config-mode"
% Failed to commit .. As error(s) encountered during commit operation..
```

---

## cmlsh multiple-config-session

Use this command to enable or disable multiple CLI sessions to enter into configuration mode simultaneously.

With this support, multiple CLI users can enter into configuration mode simultaneously and do configurations in parallel and commit into the running datastore. This is similar to NetConf multiple session support described in RFC 6241.

When multiple configuration mode sessions are disabled, only one user can enter configuration mode and it will lock the running datastore.

If any CLI session is already there in configuration mode, error will be given when user tries to enable this mode.

A datastore lock can be acquired using the [cml lock config-datastore](#) command if you want to do configuration without fear of interaction with other user sessions.

This command is available only to users with the `network-admin` role.

This configuration is retained across reboots.

### Command Syntax

```
cmlsh multiple-config-session (enable|disable)
```

### Parameters

<code>enable</code>	Enable multiple configuration mode sessions.
<code>disable</code>	Disable multiple configuration mode sessions.

### Default

By default, multiple CLI sessions are disabled.

### Mode

Exec mode

### Applicability

This command was introduced in OcNOS version 5.1.

### Example

```
#cmlsh multiple-config-session enable
#
#show cmlsh multiple-config-session status
CMLSh multiple configuration session mode : Enabled
#
```

### Usage

Multiple users can enter into configuration mode simultaneously and do configurations in parallel and commit into the running datastore. Examples of when you need this feature are:

- Migrating to replace an existing device. If an existing device has a large configuration and it is only done by one person, it will take more time to configure. If multiple users can configure at same time, it will take less time.
- Troubleshooting and operating. Sometimes a single device has 2 or more links to troubleshoot. If only one user only can do configuration, it will take more time to resolve the problem.



When multiple sessions are doing parallel configurations, there is a chance that one user's configuration might conflict with another user's configuration.

If you do not lock the datastore before doing a configuration, a parallel candidate datastore can be created and will be allowed to commit to the datastore. So the datastore can change while the previous user is still having the configuration in its candidate. Now when the previous user tries to commit, if the configurations conflict, it will fail.

For example, if the previous user was adding a BGP neighbor and the BGP router itself is removed from the datastore via the parallel transaction, when this user tries to commit, it will fail. The reason is when commands are added to candidate, it only checks the running datastore at that point and allows them to be added to candidate configuration datastore. But later if the running datastore itself is changed, these configurations can be irrelevant and will cause an error on commit. So the user will have to abort the transaction.

---

## cmlsh notification

Use this command to enable or disable notification for the current CMLSH session.

### Command Syntax

```
cmlsh notification (enable|disable)
```

### Parameters

<code>disable</code>	Disable notification subscription for current CMLSH session
<code>enable</code>	Enable notification subscription for current CMLSH session

### Default

By default, notification is enabled for the CMLSH session.

### Mode

Exec mode

### Applicability

This command was introduced in OcNOS version 6.0.0.

### Example

To enable notification for current CMLSH session:

```
#cmlsh notification enable
```

To disable notification for current CMLSH session:

```
#cmlsh notification disable
```

---

## cmlsh transaction

Use this command to enable or disable the transaction-based command-line interface.

Note: IP Infusion Inc. recommends that you do *not* disable transactions.

### Command Syntax

```
cmlsh transaction (enable | disable)
```

### Parameters

enable	Enable transaction-based command-line interface
disable	Disable transaction-based command-line interface

### Default

The transaction-based command-line interface is enabled by default.

### Mode

Exec mode

### Applicability

This command was introduced in OcNOS version 5.0.

### Example

```
>en
#cmlsh transaction disable
% Deprecated CLI. Disabling transaction mode is not recommended
#configure terminal
Enter configuration commands, one per line. End with CNTL/Z.
(config)#router ipv6 ospf test
(config-router)#exit
(config)#show running-config router ipv6 ospf
!
router ipv6 ospf test
!
(config)#
```

---

## cmlsh transaction limit

Use this command to set the maximum number of transactions.

To verify, give the [show max-transaction limit](#) command in exec mode.

### Command Syntax

```
cml transaction limit <0-300000>
```

### Parameters

<0-300000> Maximum number of transactions with zero (0) indicating unlimited transactions.

### Default

300,000 transactions

### Mode

Configure mode

### Applicability

This command was introduced in OcNOS version 5.0.

### Example

```
(config)#cml transaction limit 1500
(config)#exit
#show max-transaction limit
Max-Transaction Limit is 1500
```

---

## commit

Use this command to commit the candidate configuration to the running configuration.

**Note:** After a successful `commit` command, you must give the `write` command to save the running configuration to the startup configuration.

**Note:** Multiple configurations cannot be removed with a single `commit`. You must remove each configuration followed by a `commit`.

Optionally with “confirmed commit”, you can commit the configuration on a trial basis for a time specified in seconds. If you do not confirm within the specified time, the configuration will be reverted after the timeout.

- To revert the configuration before timeout, then give the `cancel-commit` command.
- To retain the configuration before timeout, then give the `confirm-commit` command.

See RFC 6241 “Confirmed Commit Capability”.

**Note:** A `commit` command without any parameters is treated as permanent and an explicit `confirm-commit` command is not required to confirm the commit.

**Note:** Multiple confirmed commits in the same session or different sessions are not supported. The `commit` command does not support the `<persist-id>` parameter as specified in RFC 6241.

### Command Syntax

```
commit (confirmed (timeout <1-500>|)) (description LINE|)
```

### Parameters

<code>confirmed</code>	Commits the configuration on a trial basis.
<code>&lt;1-500&gt;</code>	Timeout in seconds after which configuration should be reverted if a confirmation is not given with <code>confirm-commit</code> . If not specified, the default timeout is 300 seconds.
<code>LINE</code>	Commit description up to 65 characters

### Default

The default timeout is 300 seconds.

### Mode

All configuration modes

### Applicability

This command was introduced in OcNOS version 5.0 and the `confirmed` clause added in OcNOS version 6.3.0.

### Example

```
(config)#router ospf 1
(config-router)#exit
(config)#router isis 3
(config-router)#commit
(config-router)#exit
(config)#show running-config ospf
!
router ospf 1
```

```
!  
(config)#show running-config isis  
!  
router isis 3  
!  
(config)#
```

If you try to exit or end, you are prompted to commit or abort first:

```
(config)#router bgp 10  
(config-router)#bgp as-local-count 34  
(config-router)#exit  
(config)#exit  
% Un-committed transactions present. Please do commit or abort before exiting.  
(config)#end  
% Un-committed transactions present. Please do commit or abort before exiting.  
(config)#commit  
(config)#show running-config bgp  
!  
router bgp 10  
  bgp as-local-count 34  
!  
(config)#
```

This is an example of a “confirmed commit”:

```
(config)#router ospf 1  
(config-router)#router ospf 2  
(config-router)#commit confirmed timeout 100 description This is Test for confirmed  
commit
```

---

## Usage

OcNOS validates dependencies when you commit. In this example, bridge 1 must exist before you can create a VLAN on it:

```
(config)#vlan database  
(config-vlan)#vlan 10 bridge 1  
(config-vlan)#exit  
(config)commit
```

Because of the unmet dependency, you get an error when you try to commit.

If you also create the bridge, the commit succeeds:

```
(config)#bridge 1 protocol mstp  
(config)#vlan database  
(config-vlan)#vlan 10 bridge 1  
(config-vlan)#exit  
(config)commit
```

In a single transaction, dependent configurations can be given in any order. Using the same example as before, you can create the bridge *after* the VLAN:

```
(config)#vlan database  
(config-vlan)#vlan 10 bridge 1
```

```
(config-vlan)#exit
(config)#bridge 1 protocol mstp
(config)commit
```

OcNOS supports “hitless merges” and does not write to the candidate configuration if you make the same configuration in separate transactions. In this example, subinterface xe1.1 is not created the second time because it already exists:

```
(config)#interface xe1.1
(config-if)#commit
(config)#interface xe1.1
(config-if)#commit
```

OcNOS does not write to the candidate configuration if you create and delete the same entity in the same transaction. You must create the entity and delete it with separate commits.

Mode changes, action items (such as `clear interface counters`), and `show` commands are not part of a transaction and are not displayed by the [show transaction current](#) command.

---

## confirm-commit

Use this command to commit configuration changes before the timeout in a “confirmed commit” operation.

Note: This command does not support the <persist-id> parameter as specified in RFC 6241.

### Command Syntax

```
confirm-commit
```

### Parameters

None

### Default

N/A

### Mode

All configuration modes

### Applicability

This command was introduced in OcNOS version 6.3.0.

### Example

```
(config)#router ospf 1
(config-router)#router ospf 2
(config-router)#commit confirmed timeout 100 description This is a test for confirmed
commit
(config-router)#
(config-router)#confirm-commit
```



---

## commit dry-run

Use this command to validate the current candidate configuration without committing.

### Command Syntax

```
commit dry-run
```

### Parameters

None

### Default

N/A

### Mode

All configuration modes

### Applicability

This command was introduced in OcNOS version 6.3.0.

### Example

```
OcNOS(config)#commit dry-run
```

---

## debug cml

Use this command to enable or disable CML sub-module logging.

### Command Syntax

```
debug cml (enable | disable) (events | engine | transaction | database | replace |
  smi | notification | all)
```

### Parameters

enable	Enable debugging.
disable	Disable debugging.
events	Enable/disable events debugging
engine	Enable/disable engine debugging
transaction	Enable/disable transaction debugging
database	Enable/disable database debugging
replace	Enable/disable replace debugging
smi	Enable/disable SMI debugging
notification	Enable/disable notification debugging
all	Enable/disable all debugging

### Default

By default, CML sub-module logging is disabled for all sub-modules.

### Mode

Exec mode

### Applicability

This command was introduced in OcNOS version 4.2 and the `notification` parameter added in OcNOS version 6.1.0.

### Example

```
#debug cml enable transaction
```

---

## module notification

Use this command to enable or disable notification for a given protocol at a given notification severity level.

### Command Syntax

```
module PROTOCOL_NAME notification (enable|disable) (severity
    (all|info|warning|minor|major|critical) |)
```

### Parameters

PROTOCOL_NAME	Protocol name. Specify <code>all</code> for all protocols.
<code>enable</code>	Enable notification subscription
<code>disable</code>	Disable notification subscription
<code>severity</code>	If notification is enabled, then all notifications having severity higher than or equal to this severity allowed. If notification disabled then all the notifications having severity lower than or equal to this severity not allowed.
<code>all</code>	Notification severity all
<code>critical</code>	Notification severity critical
<code>info</code>	Notification severity info
<code>major</code>	Notification severity major
<code>minor</code>	Notification severity minor
<code>warning</code>	notification severity warning

### Mode

Configure mode

### Applicability

This command was introduced in OcNOS version 6.0.0.

### Example

To enable notification for NSM for all severity levels:

```
#module nsm notification enable
```

To disable notifications for NSM for all severity levels:

```
#module nsm notification disable
```

To enable notifications for NSM for severity levels higher than or equal to major (major and critical):

```
#module nsm notification enable severity major
```

To disable notifications for NSM for severity levels lower than or equal to minor (info, warning, and minor):

```
#module nsm notification disable severity minor
```

---

## show cml config-datastore lock status

Use this command to display the configuration datastore lock state and its holder. The identifier of the process holding the lock is shown in parenthesis.

### Command Syntax

```
show cml config-datastore lock status
```

### Parameters

None

### Default

N/A

### Mode

Privileged exec mode

### Applicability

This command was introduced in OcNOS version 6.0.0.

### Example

```
#cml lock config-datastore candidate
#show cml config-datastore lock status
```

```
Running datastore is unlocked
Candidate datastore is locked by client cmlsh(2831)
Startup datastore is unlocked
#
```

---

## show cml notification status

Use this command to display notification status (enabled or disabled) for all CML clients.

### Command Syntax

```
show cml notification status
```

### Parameters

None

### Mode

Exec mode

### Applicability

This command was introduced in OcNOS version 6.0.0.

### Example

To show notification status for all clients:

```
#show cml notification status  
NETCONF notification enabled  
CMLSH notification enabled  
SNMP notification enabled
```

---

## show cmlsh multiple-config-session status

Use this command to display the multiple configuration mode session setting.

### Command Syntax

```
show cmlsh multiple-config-session status
```

### Parameters

None

### Default

N/A

### Mode

Privileged exec mode

### Applicability

This command was introduced in OcNOS version 5.1.

### Example

```
#cmlsh multiple-config-session enable
#
#show cmlsh multiple-config-session status
CMLSh multiple configuration session mode : Enabled
#
```

---

## show cmlsh notification status

Use this command to display the notification status (enabled or disabled) for the current CMLSH session.

### Command Syntax

```
show cmlsh notification status
```

### Parameters

None

### Mode

Exec mode

### Applicability

This command was introduced in OcNOS version 6.0.0.

### Example

To show notification status for the CMLSH session.

```
# OcNOS#show cmlsh notification status  
CMLSH notification enabled.
```

---

## show max-transaction limit

Use this command to display the maximum number of transactions.

### Command Syntax

```
show max-transaction limit
```

### Parameters

None

### Default

N/A

### Mode

Exec mode

### Applicability

This command was introduced in OcNOS version 5.0.

### Example

```
#show max-transaction limit  
Max-Transaction Limit is 30000
```



---

## show module-info

Use this command to display module's config and state configuration for any top-level object in the data model. This command can be used to display module configuration in XML or JSON format. This command is equivalent to a NETCONF GET operation.

### Command Syntax

```
show module-info OBJECT_NAME format (xml|json)
```

### Parameters

OBJECT_NAME	Name of the object, such as ISIS or OSPF
xml	XML output format
json	JSON output format

### Mode

All modes

### Applicability

This command was introduced in OcNOS version 6.0.0.

### Example

To display the user-session module's config and state configuration in XML format:

```
#show module-info user-session format xml
<user-session xmlns="http://www.ipinfusion.com/yang/ocnos/ipi-user-session-management">
  <sessions>
    <session>
      <id>pts/0</id>
      <state>
        <id>pts/0</id>
        <user-role>network-admin</user-role>
        <type>Local</type>
        <process-identifier>1099</process-identifier>
        <idle-time>0d00h00m</idle-time>
        <client-type>CLI</client-type>
        <user-name>root</user-name>
        <line>130 vty 0</line>
      </state>
    </session>
  </sessions>
</user-session>
```

To display the user-session module's config and state configuration in JSON format:

```
#show module-info user-session format json
{
  "user-session":{
    "sessions":{
      "session":[
```

```
{
  "id":"pts/0",
  "state":{
    "id":"pts/0",
    "user-role":"network-admin",
    "type":"Local",
    "process-identifier":"1099",
    "idle-time":"0d00h00m",
    "client-type":"CLI",
    "user-name":"root",
    "line":"130 vty 0"
  }
}
]
```

---

## show running-config notification

Use this command to display the notification status (enabled or disabled) and notification severity levels.

### Command Syntax:

```
show running-config notification
```

### Parameters

None

### Mode

Exec mode

### Applicability

This command was introduced in OcNOS version 6.0.0.

### Example

To display the notification status and notification severity levels.

```
#show running-config notification
!  
module nsm notification enable severity major  
!
```

---

## show system restore failures

Use this command to display configuration restoration status after save reload device.

### Command Syntax

```
show system restore failures
```

### Parameters

None

### Mode

Exec mode

### Applicability

This command was introduced in OcnOS version 5.1.

### Example

Configuration restoration successful status information after save reload device:

```
#show system restore failures
Configuration restore from DB is completed.
Total no. of failed configuration objects = 0
```

Configuration restoration failure status information after save reload device:

```
#show system restore failures
Configuration restore from DB is completed.
Total no. of failed configuration objects = 1.
```

Failed Protocols information :

Protocol Name=ipi-interface, Protocol Id=3 :

Failed configuration object information :

Total no. of failed configuration objects = 1.

Object Name = config, DN = cmlAutoDummy3074=3074,name=eth0,cmlAutoDummy3073=3073 :

Error Information :

Total no. of configuration errors = 1.

ErrorCode = -16946, ErrorMessage = % No such VRF, ErrorXPath = /interfaces/  
interface[name='eth0']/config.

---

## show transaction current

Use this command to display the current transaction.

Mode changes, action items (such as `clear interface counters`), and `show` commands are not part of a transaction and are not displayed by this command.

### Command Syntax

```
show transaction current
```

### Parameters

None

### Default

N/A

### Mode

Exec mode and configure mode

### Applicability

This command was introduced in OcNOS version 5.0.

### Example

```
(config)#interface eth3
(config-if)#description testing
(config-if)#mtu 664
(config-if)#exit
(config)#show transaction current
interface eth3
description testing
mtu 664
```

---

## show transaction last-aborted

Use this command to display the last aborted transaction.

### Command Syntax

```
show transaction last-aborted
```

### Parameters

None

### Default

N/A

### Mode

Exec mode

### Applicability

This command was introduced in OcNOS version 5.0.

### Example

```
(config)#router isis 4
(config-router)#isis wait-timer 45
(config-router)#net 11.22.33
(config-router)#exit
(config)#commit
%% Invalid NET length - /isis/isis-instance[instance='4']/config
(config)#show running-config isis
!
!
(config)#abort transaction
(config)#exit
#show transaction last-aborted
router isis 4
isis wait-timer 45
net 11.22.33
#
```

## show (xml|json) running-config|candidate-config

Use this command to display the running or candidate system configuration for any top-level object in the data model. This CLI can also be used to display full running or candidate system configuration for all protocol modules. This command can be used to display running or candidate system configuration in xml or json format. This command is equivalent to a NETCONF GET-CONFIG operation.

### Command Syntax

```
show (xml|json) (running-config| candidate-config) OBJECT_NAME
```

### Parameters

xml	XML output format
json	JSON output format
candidate-config	Candidate system configuration
running-config	Running system configuration
OBJECT_NAME	Name of the object, such as ISIS or OSPF

### Mode

All modes

### Applicability

This command was introduced before OcNOS version 4.2 and updated in OcNOS version 6.0.0.

### Example

To display the top level objects:

```
#show xml running-config
arp                bfd                bgp                dhcp                evpn                evpn-mpls
interfaces         ip-global          isis               key-chains          lacp                layer2-global
ldp                lldp              logging            mpls                neighbor-discovery network-instances
ospfv2             pcep              ping              prefixes            routemaps           routing
rsvp-te            segment-routing   system-info       tacacs              time-ranges        vlan-classifier
vpls              vpls              vxlan
```

To display the ISIS running configuration in XML format:

```
#show xml running-config isis
<isis xmlns="http://www.ipinfusion.com/yang/ocnos/ipi-isis">
  <isis-instance xmlns="http://www.ipinfusion.com/yang/ocnos/ipi-isis">
    <instance>1</instance>
    <config xmlns="http://www.ipinfusion.com/yang/ocnos/ipi-isis">
      <instance>1</instance>
      <vrf-name>default</vrf-name>
    </config>
  </isis-instance>
</isis>
```

To display the logging running configuration in XML format:

```
#show xml running-config logging
<logging xmlns="http://www.ipinfusion.com/yang/ocnos/ipi-logging">
```

```
<rsyslog>
  <vrf>default</vrf>
  <config>
    <vrf>default</vrf>
    <enable-rsyslog>rsyslog</enable-rsyslog>
  </config>
</rsyslog>
</logging>
```

To display the logging running configuration in JSON format:

```
#show json running-config logging
{
  "logging":{
    "rsyslog":[
      {
        "vrf":"default",
        "config":{
          "vrf":"default",
          "enable-rsyslog":"rsyslog"
        }
      }
    ]
  }
}
```

To display the OSPFv2 candidate configuration in XML format:

```
#show xml candidate-config ospfv2
<ospfv2 xmlns="http://www.ipinfusion.com/yang/ocnos/ipi-ospf">
  <processes>
    <process>
      <ospf-id>1</ospf-id>
      <config>
        <ospf-id>1</ospf-id>
        <vrf-name>default</vrf-name>
      </config>
    </process>
  </processes>
</ospfv2>
```

To display the OSPFv2 candidate configuration in JSON format:

```
#show json candidate-config ospfv2
{
  "ospfv2":{
    "processes":{
      "process":[
        {
          "ospf-id":"1",
          "config":{
            "ospf-id":"1",
            "vrf-name":"default"
          }
        }
      ]
    }
  }
}
```



```
}  
  ]  
}  
}
```



## CHAPTER 3 User Management

---

This chapter is a reference for user management commands.

This chapter includes these commands:

- `clear aaa local user lockout username`
- `debug user-mgmt`
- `show user-account`
- `username`

---

## clear aaa local user lockout username

Use this command to unlock the locked user due to three times wrong password login attempt.

### Command Syntax

```
clear aaa local user lockout username USERNAME
```

### Parameters

USERNAME	User name; length 2-15 characters
----------	-----------------------------------

### Command Mode

Exec mode

### Applicability

This command was introduced before OcNOS version 1.3.

### Example

```
#clear aaa local user lockout username testuser
```

---

## debug user-mgmt

Use this command to display user management debugging information.

Use the `no` form of this command stop displaying user management debugging information.

### Command Syntax

```
debug user-mgmt
no debug user-mgmt
```

### Parameters

None

### Default

By default, disabled.

### Command Mode

Exec mode and Configure mode

### Applicability

This command was introduced before OcNOS version 1.3.

### Example

```
#debug user-mgmt

#config t
(config)#debug user-mgmt
```

---

## show user-account

Use this command to display information about all users or a given user.

### Command Syntax

```
show user-account (WORD|)
```

### Parameters

WORD	User name
------	-----------

### Command Mode

Privileged Exec mode

### Applicability

This command was introduced before OcnOS version 1.3.

### Example

```
#show user-account
User:user1
roles: network-operator
User:user2
roles: network-operator
User:user3
roles: network-operator
```

---

## username

Use this command to add a user or to change a user password.

The `role` parameter maps to privilege levels in the TACACS+ server as shown in [Table 3-14](#)

**Table 3-14: Role/privilege level mapping**

Role	Privilege level
Network administrator	15
Network engineer	14
Network operator	1 to 13
Network user	0 or greater than 15

Use the `no` form of this command to remove a user.

### Command Syntax

```
username USERNAME
username USERNAME password (encrypted|) PASSWORD
username USERNAME role (network-admin|network-engineer|network-operator|network-user)
username USERNAME role (network-admin|network-engineer|network-operator|network-user) password (encrypted|) PASSWORD
username disable-default
no username disable-default
no username USERNAME
```

### Parameters

<code>USERNAME</code>	User name; length 2-15 characters
<code>encrypted</code>	Encrypted password
<code>PASSWORD</code>	Password; length 5-32 characters
<code>network-admin</code>	Network administrator role with all access permissions that can make permanent changes to the configuration. Changes persist after a reset/reboot of the switch.  Only network administrators can manage other users with the <a href="#">enable password</a> , <a href="#">Authentication, Authorization and Accounting</a> , <a href="#">RADIUS Commands</a> , and <a href="#">TACACS+ Commands</a> commands.
<code>network-engineer</code>	Network engineer role with all access permission that can make permanent changes to the configuration. Changes persist after a reset/reboot of the switch.
<code>network-operator</code>	Network operator role with all access permissions that can make temporary changes to the configuration. Changes do not persist after a reset/reboot of the switch.
<code>network-user</code>	Network user role with access permissions to display the configuration, but cannot change the configuration.

`disable-default`

This option is used to disable the implicit configuration of default user by the system. This command can be executed only by users with “network-admin” privileges. When this option is configured, explicit configuration of default user will be rejected. If default-user is explicitly configured using “username” CLI, it should be removed using “no username USERNAME” before configuring “disable-default”.

### **Default**

By default, user name is disabled.

### **Command Mode**

Configure mode

### **Applicability**

This command was introduced before OcNOS version 1.3.

### **Example**

```
#configure terminal
(config)#username fred_smith password fred123
```



## CHAPTER 4 Dynamic Host Configuration Protocol Client

This chapter describes the Dynamic Host Configuration Protocol (DHCP) client commands.

DHCP is used to configure devices that are connected to a network so they can communicate on that network using the Internet Protocol (IP). DHCP is implemented in a client-server model where DHCP clients request configuration data, such as an IP address, a default route, or DNS server addresses from a DHCP server.

This chapter contains these commands:

- [feature dhcp](#)
- [ip address dhcp](#)
- [ip dhcp client request](#)
- [ipv6 address dhcp](#)
- [ipv6 dhcp address-prefix-length](#)
- [ipv6 dhcp client request](#)
- [ipv6 dhcp client](#)
- [show ipv6 dhcp vendor-opts](#)

---

## feature dhcp

Use this command to enable the DHCP client and DHCP relay on the device.

Use the `no` form of this command to disable the DHCP client and DHCP relay and delete any DHCP-related configuration.

### Command Syntax

```
feature dhcp
no feature dhcp
```

### Parameters

None

### Default

By default, feature dhcp is disabled

### Command Mode

Configure mode

### Applicability

This command was introduced before OcNOS version 1.3.

### Examples

```
#configure terminal
(config)#feature dhcp
```

---

## ip address dhcp

Use this command to get an IP address from a DHCP server for this interface.

Use the `no` form of this command to disable the DHCP client for this interface.

You can give the [ip dhcp client request](#) command before giving this command to request additional options.

### Command Syntax

```
ip address dhcp
no ip address dhcp
```

### Parameters

None

### Default

No default value is specified.

### Command Mode

Interface mode

### Applicability

This command was introduced before OcNOS version 1.3.

### Examples

```
#configure terminal
(config)#interface eth0
(config-if)#ip address dhcp
(config-if)#
```

---

## ip dhcp client request

Use this command to add an option to a DHCP request.

Use the `no` form of this command to remove an option from a DHCP request.

### Command Syntax

```
ip dhcp client request dns-nameserver
ip dhcp client request host-name
ip dhcp client request log-server
ip dhcp client request ntp-server
no ip dhcp client request dns-nameserver
no ip dhcp client request host-name
no ip dhcp client request log-server
no ip dhcp client request ntp-server
```

### Parameters

<code>dns-nameserver</code>	List of DNS name servers (DHCP option 6)
<code>host-name</code>	Name of the client (DHCP option 12)
<code>ntp-server</code>	List of NTP servers (DHCP option 42)
<code>log-server</code>	List of log servers (DHCP option 7)

### Default

By default, `ip dhcp client request` is enabled

### Command Mode

Interface mode

### Applicability

This command was introduced before OcnOS version 1.3.

### Examples

```
#configure terminal
(config)#interface eth0
(config-if)#ip dhcp client request ntp-server
```

---

## ipv6 address dhcp

Use this command to get an IPV6 address from a DHCP server for this interface.

Use the `no` form of this command to disable the DHCP client for this interface.

You can give the `ipv6 dhcp client request` command before giving this command to request additional options.

### Command Syntax

```
ipv6 address dhcp
no ipv6 address dhcp
```

### Parameters

None

### Default

No default value is specified.

### Command Mode

Interface mode

### Applicability

This command was introduced before OcNOS version 1.3.

### Examples

```
#configure terminal
(config)#interface eth0
(config-if)#ipv6 address dhcp
(config-if)#
```

---

## ipv6 dhcp address-prefix-length

Use this command to configure the prefix-length for dynamically allocated ipv6 address.

Use the `no` form of this command to unconfigure the prefix-length.

### Command Syntax

```
ipv6 dhcp address-prefix-length <1-128>
no ipv6 dhcp address-prefix-length
```

### Parameters

<1-128>	IPv6 address prefix length
---------	----------------------------

### Default

Default ipv6 address prefix length is 128

### Command Mode

Interface mode

### Applicability

This command was introduced before OcNOS version 4.2.

### Examples

```
#configure terminal
(config)#interface xe1
(config-if)#ipv6 dhcp address-prefix-length 64
(config-if)
```

---

## ipv6 dhcp client request

Use this command to add an option to a DHCPv6 request.

Use the `no` form of this command to remove an option from a DHCPv6 request.

Note:

- Vendor-specific options allow a specific vendor to define a set of DHCP options that really make sense for their device or operating system.
- By default DHCPv6 uses four messages exchange (Solicit, Advertise, Request, and Reply) to obtain configuration parameters from a server. But when `rapid-commit` is specified, `dhcp6-client` will include a `rapid-commit` option in solicit messages and wait for an immediate reply instead of advertisements. The Rapid Commit option is used to signal the use of the two message exchange for address assignment.

### Command Syntax

```
ipv6 dhcp client request dns-nameserver
ipv6 dhcp client request ntp-server
ipv6 dhcp client request domain-search
ipv6 dhcp client request vendor-specific-information
ipv6 dhcp client request rapid-commit
no ipv6 dhcp client request rapid-commit
no ipv6 dhcp client request vendor-specific-information
no ipv6 dhcp client request domain-search
no ipv6 dhcp client request ntp-server
no ipv6 dhcp client request dns-nameserver
```

### Parameters

<code>dns-nameserver</code>	List of DNS name servers
<code>ntp-server</code>	Request for IPv6 NTP server
<code>domain-search</code>	Request for IPv6 domain search
<code>vendor-specific-information</code>	Request for IPv6 vendor-specific-information
<code>rapid-commit</code>	Request to enable rapid-commit

### Default

No default value is specified.

### Command Mode

Interface mode

### Applicability

This command was introduced before OcnOS version 1.3 and modified in OcnOS version 5.0

## Examples

```
#configure terminal
(config)#interface eth0
(config-if)#ipv6 dhcp client request dns-nameserver
(config-if)#

(config)#interface eth0
(config-if)#ipv6 dhcp client request ntp-server
(config-if)#exit

(config)#interface eth0
(config-if)#ipv6 dhcp client request domain-search
(config-if)#exit

(config)#interface eth0
(config-if)#ipv6 dhcp client request vendor-specific-information
(config-if)#exit

(config)#interface eth0
(config-if)#ipv6 dhcp client request rapid-commit
(config-if)#exit
```



---

## ipv6 dhcp client

Use this command to configure DHCP client options to a DHCPv6 request.

Use the `no` form of this command to remove client options from a DHCPv6 request.

Note:

- `ipv6 dhcp client information-request` is used to get only stateless configuration parameters (i.e., without address).
- DAD-wait-time value is the maximum time (in seconds) that the client should wait for the duplicate address detection (DAD) to complete on an interface.
- DUID option override the default when selecting the type of DUID to use. By default, DHCPv6 dhclient creates an identifier based on the link-layer address (DUID-LL) if it is running in stateless mode (with `-S`, not requesting an address), or it creates an identifier based on the link-layer address plus a timestamp (DUID-LLT) if it is running in stateful mode (without `-S`, requesting an address).

### Command Syntax

```
ipv6 dhcp client information-request
ipv6 dhcp client dad-wait-time <1-600>
ipv6 dhcp client duid (ll | llt)
no ipv6 dhcp client duid
no ipv6 dhcp client dad-wait-time
no ipv6 dhcp client information-request
```

### Parameters

<code>information-request</code>	Request to enable information-request
<code>&lt;1-600&gt;</code>	DAD wait-time in seconds
<code>ll</code>	Link-layer address
<code>llt</code>	Link-layer address plus timestamp

### Default

No default value is specified.

### Command Mode

Interface mode

### Applicability

This command was introduced before OcNOS version 1.3 and modified in OcNOS version 5.0

### Examples

```
#configure terminal
(config)#interface eth0
(config-if)#ipv6 dhcp client information-request
(config-if)#exit
```

```
(config)#interface eth0
(config-if)#ipv6 dhcp client dad-wait-time 20
(config-if)#exit
```

```
(config)#interface eth0
(config-if)#ipv6 dhcp client duid 11
(config-if)#exit
```

---

## show ipv6 dhcp vendor-opts

Use this command to display vendor-specific-information option value given by DHCP server.

### Command Syntax

```
show ipv6 dhcp vendor-opts
```

### Parameters

None

### Command Mode

Executive mode

### Applicability

This command is introduced in OcNOS version 5.0

### Examples

```
#sh ipv6 dhcp vendor-opts
ifName          vendor-opts
=====          =====
xe5             IP Infusion Inc
#
```



---

## CHAPTER 5 Dynamic Host Configuration Protocol Relay

---

This chapter describes the Dynamic Host Configuration Protocol (DHCP) relay commands.

In small networks with only one IP subnet, DHCP clients communicate directly with DHCP servers. When DHCP clients and associated servers do not reside on the same subnet, a DHCP relay agent can be used to forward DHCP client messages to DHCP server.

The DHCP client broadcasts on the local link, the relay agents receives the broadcast DHCP messages, and then generate a new DHCP message to send out on another interface.

The relay agent sets the gateway IP address (`giaddr` field of the DHCP packet) and, if configured, adds the relay agent information option (option 82) in the packet and forwards it to the DHCP server. The DHCP server replies to the client and the relay agent then retransmits the response on the local network.

This chapter contains these commands:

- `clear ip dhcp relay option statistics`
- `clear ipv6 dhcp pd-route (|vrf NAME)`
- `clear ip dhcp relay statistics`
- `ip dhcp relay (configure mode)`
- `ip dhcp relay (interface mode)`
- `ip dhcp relay address`
- `ip dhcp relay address global`
- `ip dhcp relay information option`
- `ip dhcp relay information option always-on`
- `ip dhcp relay information source-ip`
- `ip dhcp relay information source-ip`
- `ip dhcp relay (L3VPN)`
- `ipv6 dhcp relay (configure mode)`
- `ipv6 dhcp relay (interface mode)`
- `ipv6 dhcp relay address`
- `ipv6 dhcp relay address global`
- `ipv6 dhcp relay pd-route-injection`
- `ipv6 dhcp relay subscriber-id`
- `ipv6 dhcp relay (L3VPN)`
- `show ip dhcp relay`
- `show ip dhcp relay address`
- `show ip dhcp relay option statistics`
- `show ip dhcp relay statistics`
- `show ipv6 dhcp pd-route`
- `show ipv6 dhcp relay`
- `show ipv6 dhcp relay address`
- `show running-config dhcp`

---

## clear ip dhcp relay option statistics

Use this command to clear ipv4 relay option statistics.

### command syntax

```
clear ip dhcp relay option statistics
```

### Parameters

None

### Command Mode

Executive mode

### Applicability

This command was introduced in OcNOS version 1.3.9.

### Examples

```
#clear ip dhcp relay option statistics
```

---

## clear ipv6 dhcp pd-route (|vrf NAME)

Use this command to clear the routes in RIBD module learnt as part of Route injection feature.

### Command Syntax

```
clear ipv6 dhcp pd-route (|vrf NAME)
```

### Parameters

NAME	Name of the VRF
------	-----------------

### Default

No default value

### Command Mode

Executive mode

### Applicability

This command was introduced in OcNOS version 4.2.

### Examples

```
#clear ipv6 dhcp pd-route vrf vrf1
```

---

## clear ip dhcp relay statistics

Use this command to clear ipv4 relay statistics.

### Command syntax

```
clear ip dhcp relay statistics
```

### Parameters

None

### Command Mode

Executive mode

### Applicability

This command was introduced in OcNOS version 1.3.9.

### Examples

```
#clear ip dhcp relay statistics
```



---

## ip dhcp relay (configure mode)

Use this command to enable the DHCP relay agent. The DHCP relay starts forwarding packets to the DHCP server address once configured.

Use the `no` form of this command to disable the DHCP relay agent.

### Command Syntax

```
ip dhcp relay
no ip dhcp relay
```

### Parameters

None

### Default

By default, this feature is enabled.

### Command Mode

Configure mode

### Applicability

This command was introduced before OcNOS version 1.3.

### Examples

```
#configure terminal
(config)#ip dhcp relay

#configure terminal
(config)#no ip dhcp relay
```

---

## ip dhcp relay (interface mode)

Use this command to configure an interface as a DHCP client-facing port.

Use the `no` form of this command to remove an interface as a DHCP client-facing port.

### Command Syntax

```
ip dhcp relay
no ip dhcp relay
```

### Parameters

None

### Default

No default value is specified.

### Command Mode

Interface mode

### Applicability

This command was introduced in OcNOS version 1.3.8.

### Examples

```
#configure terminal
(config)#interface eth2
(config-if)#ip dhcp relay
```

## ip dhcp relay address

Use this command to set an IPv4 address of a DHCP server to which a DHCP relay agent forwards client requests.

Use the `no` form of this command to remove the IP address of a DHCP server.

User must enable the DHCP relay feature with the [ip dhcp relay \(configure mode\)](#) command to configure server address.

### Command Syntax

```
ip dhcp relay address A.B.C.D
no ip dhcp relay address A.B.C.D
```

### Parameters

A.B.C.D	IPv4 address of the DHCP server
---------	---------------------------------

### Default

No default value is specified

### Command Mode

Configure mode

VRF mode

### Applicability

This command was introduced before OcNOS version 1.3 and was changed in OcNOS version 1.3.8.

### Examples

```
#configure terminal
(config)#ip vrf vrf1
(config-vrf)#ip dhcp relay address 198.51.100.127

#configure terminal
(config)#ip dhcp relay address 198.51.100.127
```

---

## ip dhcp relay address global

When the IPv4 DHCP server resides in a different VPN or global space that is different from the VPN, then use this command to specify the name of the VRF or global space in which the DHCP server resides.

Use the no form of this command to remove the VRF in which IPv4 DHCP server resides.

### Command Syntax

```
ip dhcp relay address A.B.C.D global (|VRF-NAME)
no ip dhcp relay address A.B.C.D global
```

### Parameters

A.B.C.D	IPv4 address of the DHCP server
VRF-NAME	Name of VRF where the DHCP server is present

### Default

If no input given, default VRF is the default Value.

### Command Mode

Configure mode

VRF mode

### Applicability

This command was introduced in OcNOS version 5.1.

### Examples

```
#configure terminal
(config)#ip vrf vrf1
(config-vrf)#ip dhcp relay address 198.51.100.127 global

#configure terminal
(config)#ip dhcp relay address 198.51.100.127 global vrf1
```

## ip dhcp relay information option

Use this command to enable the device to insert and remove option 82 information in DHCP packets forwarded by the relay agent.

The option 82 suboption remote-id can be configured either as hostname or any string provided by the User.

Use the `no` form of this command to disable inserting and removing option-82 information.

### Command Syntax

```
ip dhcp relay information option (|remote-id (hostname|WORD))
no ip dhcp relay information option (|remote-id)
```

### Parameters

<code>remote-id</code>	Remote host Identifier, can either be the System's hostname or a user-specified string.
<code>WORD</code>	Specify a string as remote-id (Maximum 255 alphanumeric characters).

### Default

No default value is specified

### Command Mode

Configure mode

VRF mode

### Applicability

This command was introduced before OcnOS version 1.3 and was changed in OcnOS version 1.3.8.

### Examples

```
#configure terminal
(config)#ip vrf vrf1
(config-vrf)#ip dhcp relay information option remote-id hostname

#configure terminal
(config)#ip dhcp relay information option

#configure terminal
(config)#no ip dhcp relay information option
```

---

## ip dhcp relay information option always-on

Use this command to enable the device to insert options 82 information in DHCP packets forwarded by the relay-agent and keep them while forwarding to client.

Use the `no` form of this command to disable the option-82 always-on information.

### Command Syntax

```
ip dhcp relay information option always-on
no ip dhcp relay information option always-on
```

### Parameters

None

### Default

No default value is specified

### Command Mode

Configure mode

VRF mode

### Applicability

This command was introduced before OcNOS version 1.3 and was changed in OcNOS version 6.2.0.

### Examples

```
#configure terminal
(config)#ip vrf vrf1
(config-vrf)#ip dhcp relay information option always-on

#configure terminal
(config)#ip dhcp relay information option always-on

#configure terminal
(config)#no ip dhcp relay information option always-on
```

---

## ip dhcp relay information source-ip

Use this command to enable DHCP relay option 82 link selection.

Use the no form of this command to disable DHCP relay option 82 link selection.

### Command Syntax

```
ip dhcp relay information source-ip A.B.C.D
no ip dhcp relay information source-ip
```

### Parameters

A.B.C.D            IPv4 address

### Default

No default value is specified.

### Command Mode

Configure mode

VRF mode

### Applicability

This command was introduced before OcNOS version 1.3.6.

### Example

```
#configure terminal
(config)#ip vrf vrf1
(config-vrf)#ip dhcp relay information option source-ip 2.2.2.2

#configure terminal
(config)#ip dhcp relay information option source-ip 3.3.3.3
```

---

## ip dhcp relay (L3VPN)

Use this command to specify IPv4 DHCP relay to use tunnel interfaces as Uplink/Downlink.

Use the `no` form of this command to remove the usage of tunnel interfaces in IPv4 DHCP relay.

### Command Syntax

```
ip dhcp relay (uplink|downlink) (l3vpn)
no ip dhcp relay (uplink|downlink) (l3vpn)
```

### Parameters

<code>uplink</code>	DHCP Relay uplink interface
<code>downlink</code>	DHCP Relay downlink interface
<code>l3vpn</code>	L3VPN interface

### Default

No default value is specified.

### Command Mode

Configure and VRF mode

### Applicability

This command was introduced in OcNOS version 5.0.

### Examples

```
#configure terminal
(config)#ip vrf vrf1
(config-vrf)#ip dhcp relay uplink l3vpn
(config-vrf)#end

#configure terminal
(config)#ip dhcp relay uplink l3vpn
```



---

## ipv6 dhcp relay (configure mode)

Use this command to enable the DHCP IPv6 relay agent.

Use the `no` form of this command to disable the DHCP IPv6 relay agent.

### Command Syntax

```
ipv6 dhcp relay
no ipv6 dhcp relay
```

### Parameters

None

### Default

No default value is specified

### Command Mode

Configure mode

### Applicability

This command was introduced before OcNOS version 1.3.

### Examples

```
#configure terminal
(config)#ipv6 dhcp relay

#configure terminal
(config)#no ipv6 dhcp relay
```

---

## ipv6 dhcp relay (interface mode)

Use this command to configure an interface as a DHCPv6 client-facing port.

Use the `no` form of this command to remove an interface as a DHCPv6 client-facing port.

### Command Syntax

```
ipv6 dhcp relay
no ipv6 dhcp relay
```

### Parameters

None

### Default

No default value is specified

### Command Mode

Interface mode

### Applicability

This command was introduced in OcNOS version 1.3.8.

### Examples

```
#configure terminal
(config)#interface eth1
(config-if)#ipv6 dhcp relay
```

## ipv6 dhcp relay address

Use this command to set an IPv6 address of a DHCP server to which a DHCP relay agent forwards client requests.

Use the `no` form of this command to remove an IPv6 address of a DHCP server.

User must enable the IPv6 DHCP relay feature with the [ipv6 dhcp relay \(configure mode\)](#) command to configure server address.

### Command Syntax

```
ipv6 dhcp relay address X:X::X:X
no ipv6 dhcp relay address X:X::X:X
```

### Parameters

X:X::X:X	IPv6 address of the DHCP server
----------	---------------------------------

### Default

No default value is specified

### Command Mode

Configure mode

VRF mode

### Applicability

This command was introduced before OcNOS version 1.3 and was changed in OcNOS version 1.3.8.

### Examples

```
#configure terminal
(config)#ip vrf vrf1
(config-vrf)#ipv6 dhcp relay address 2001:db8::7F

#configure terminal
(config)#ipv6 dhcp relay address 2001:db8::7F
```

---

## ipv6 dhcp relay address global

When the IPv6 DHCP server resides in a different VPN or global space that is different from the VPN, then use this command to specify the name of the VRF or global space in which the DHCP server resides.

Use the no form of this command to remove the VRF in which IPv6 DHCP server resides.

### Command Syntax

```
ipv6 dhcp relay address X:X::X:X global (|VRF-NAME)
no ipv6 dhcp relay address X:X::X:X global
```

### Parameters

X:X::X:X	IPv6 address of the DHCP server
VRF-NAME	Name of VRF where the DHCP server is present

### Default

If no input given, default VRF is the default Value.

### Command Mode

Configure mode

VRF mode

### Applicability

This command was introduced in OcNOS version 5.1.

### Examples

```
#configure terminal
(config)#ip vrf vrf1
(config-vrf)#ipv6 dhcp relay address 2001:db8::7F global

#configure terminal
(config)#ipv6 dhcp relay address 2001:db8::7F global vrf1
```

---

## ipv6 dhcp relay pd-route-injection

Use this command to enable the Route Injection of the delegated prefixes in DHCP Relay.

Use the no form of this command to disable Route Injection.

### Command Syntax

```
ipv6 dhcp relay pd-route-injection
no ipv6 dhcp relay pd-route-injection
```

### Parameters

None

### Default

By default this feature is disabled.

### Command Mode

Configure mode

VRF mode

### Applicability

This command was introduced in OcNOS version 4.2.

### Examples

```
#configure terminal
(config)# ip vrf vrf1
(config-vrf)# ipv6 dhcp relay pd-route-injection
```

```
#configure terminal
(config)#ipv6 dhcp relay pd-route-injection
```

---

## ipv6 dhcp relay subscriber-id

Use this command to configure subscriber-ID for IPv6 DHCP relay.

Use `no` form of this command to disable subscriber-id.

### Command Syntax

```
ipv6 dhcp relay information option subscriber-id WORD
no ipv6 dhcp relay information option subscriber-id
```

### Parameters

WORD	Subscriber ID
------	---------------

### Default

No default value is specified.

### Command Mode

Configuration mode and VRF mode

### Applicability

This command is introduced in OcNOS version 5.0

### Examples

```
#configure terminal
(config)#ipv6 dhcp relay information option subscriber-id test
(config)#exit
```

---

## ipv6 dhcp relay (L3VPN)

Use this command to specify IPv6 DHCP relay to use tunnel interfaces as Uplink/Downlink.

Use the `no` form of this command to remove the usage of tunnel interfaces in IPv6 DHCP relay.

### Command Syntax

```
ipv6 dhcp relay (uplink|downlink) (l3vpn)
no ipv6 dhcp relay (uplink|downlink) (l3vpn)
```

### Parameters

uplink	DHCP Relay uplink interface
downlink	DHCP Relay downlink interface
l3vpn	L3VPN interface

### Default

No default value is specified.

### Command Mode

Configure and VRF mode

### Applicability

This command was introduced in OcNOS version 5.0.

### Examples

```
#configure terminal
(config)#ip vrf vrf1
(config-vrf)#ipv6 dhcp relay uplink l3vpn
(config-vrf)#end

#configure terminal
(config)#ipv6 dhcp relay uplink l3vpn
```

---

## show ip dhcp relay

Use this command to display DHCP relay status including DHCP server addresses configured on interfaces.

### Command Syntax

```
show ip dhcp relay
```

### Parameters

None

### Command Mode

Executive mode

### Applicability

This command was introduced before OcNOS version 1.3 and changed in OcNOS version 1.3.8.

### Examples

```
#show ip dhcp relay
DHCP relay service is Enabled.
VRF Name: vrf1
  Option 82: Enabled
  Remote Id: ocnos-device
  Link selection Source-IP: 1.4.5.6
  DHCP Servers configured: 9.9.9.9 8.8.8.8
  Interface                Uplink/Downlink
  -----                -
  ge10                      Uplink
  ge28                      Downlink
VRF Name: default
  Option 82: Enabled
  Remote Id: OcNOS
  Link selection Source-IP: 1.2.3.4
  DHCP Servers configured: 1.1.1.1 2.2.2.2
  Interface                Uplink/Downlink
  -----                -
  ge11                      Uplink
  ge27                      Downlink
```



---

## show ip dhcp relay address

Use this command to display DHCP relay addresses.

### Command Syntax

```
show ip dhcp relay address
```

### Parameters

None

### Command Mode

Executive mode

### Applicability

This command was introduced before OcNOS version 1.3 and changed in OcNOS version 1.3.8.

### Examples

```
#show ip dhcp relay address
VRF Name: vrf1
  DHCP Servers configured: 9.9.9.9 8.8.8.8
VRF Name: default
  DHCP Servers configured: 1.1.1.1 2.2.2.2
```

---

## show ip dhcp relay option statistics

Use this command to display IPv4 DHCP Relay Agent Option(Option82) packet statistics

### command syntax

```
show ip dhcp relay option statistics
```

### Parameters

None

### Command Mode

Executive mode

### Applicability

This command was introduced in OcNOS version 1.3.9.

### Examples

```
#sh ip dhcp relay option statistics
VRF Name: default
Remote ID : OcNOS
Circuit ID : ge5
Number of packets forwarded without agent options : 0
Dropped pkts due to bad relay agent information option : 0
Dropped pkts due to no RAI option match found : 0
Circuit ID option is not matching with known circuit ID : 0
Circuit ID option in matching RAI option was missing : 0
#
```

---

## show ip dhcp relay statistics

Use this command to display IPv4 DHCP relayed packet statistics.

Note: DHCPv6 relay statistics is not supported

### command syntax

```
show ip dhcp relay statistics
```

### Parameters

None

### Command Mode

Executive mode

### Applicability

This command was introduced in OcNOS version 1.3.9.

### Examples

```
#sh ip dhcp relay statistics
VRF Name: default
Packets sent with a bogus giaddr : 0
Packets relayed from client to server : 12
Errors sending packets to servers : 0
Packets relayed from server to client : 1
Errors sending packets to clients : 0
#
```

---

## show ipv6 dhcp pd-route

Use this command to display the routes and their properties installed as part of the Route Injection feature

### Command Syntax

```
show ipv6 dhcp pd-route
```

### Parameters

None

### Command Mode

Executive mode

### Applicability

This command was introduced in OcNOS version 4.2.

### Examples

```
#show ipv6 dhcp pd-route
VRF : vrf1
  4002:db8:1bff::/48 via xe9 (2019-02-14 10:50:18 - 2019-02-14 10:51:58)
```

---

## show ipv6 dhcp relay

Use this command to display DHCP IPv6 relay status including DHCP IPv6 server addresses configured on interfaces.

### Command Syntax

```
show ipv6 dhcp relay
```

### Parameters

None

### Command Mode

Executive mode

### Applicability

This command was introduced before OcNOS version 1.3 and changed in OcNOS version 1.3.8.

### Examples

```
#show ipv6 dhcp relay
IPv6 DHCP relay service is Enabled.
VRF Name: vrf1
  DHCPv6 Servers configured: 2001::1
  Interface                  Uplink/Downlink
  -----
  ge35                       Uplink
  xe50                       Downlink
VRF Name: default
  DHCPv6 Servers configured: 3001::1
  Interface                  Uplink/Downlink
  -----
  ge34                       Uplink
  xe49                       Downlink
```

---

## show ipv6 dhcp relay address

Use this command to display DHCP IPv6 relay addresses.

### Command Syntax

```
show ipv6 dhcp relay address
```

### Parameters

None

### Command Mode

Executive mode

### Applicability

This command was introduced before OcNOS version 1.3 and changed in OcNOS version 1.3.8.

### Examples

```
#show ipv6 dhcp relay address
VRF Name: vrf1
  DHCPv6 Servers configured: 2001::1
VRF Name: default
  DHCPv6 Servers configured: 3001::1
```

---

## show running-config dhcp

Use this command to display DHCP settings in the running configuration.

### Command Syntax

```
show running-config dhcp
```

### Parameters

None

### Command Mode

Executive mode

### Applicability

This command was introduced before OcNOS version 1.3 and changed in OcNOS version 1.3.8.

### Examples

```
#show running-config dhcp
ip vrf vrf1
  ip dhcp relay information option remote-id hostname
  ip dhcp relay address 1.1.1.2

ip dhcp relay information option remote-id hostname
ip dhcp relay information source-ip 5.4.3.2
ip dhcp relay address 1.1.1.1
```





## CHAPTER 6 DHCPv6 Prefix Delegation Commands

---

This chapter describes the Dynamic Host Configuration Protocol (DHCP) v6 Prefix delegation commands.

The prefix delegation feature lets a DHCP server assign prefixes chosen from a global pool to DHCP clients. The DHCP client can configure an IPv6 address on its LAN interface using the prefix it received. Then it send router advertisements including the prefix, allowing other devices to auto configure their own IPv6 addresses.

Enable OcNOS device DHCP Client to receive the prefixes from external DHCP Server and enable IPv6 address autoconfiguration of LAN interfaces and the respective host machines.

This feature enables the service providers to assign IP for the Customer Premise Equipment acting as a router between the service providers core network and subscribers internal network.

This chapter contains these commands:

- [ipv6 dhcp prefix-delegation](#)
- [ipv6 address](#)
- [ipv6 address autoconfig](#)
- [show ipv6 dhcp interface](#)

---

## ipv6 dhcp prefix-delegation

Use this command to enable the DHCPv6 client to request the prefix (IA\_PD) for the interface.

Prefixes delegated by the DHCP server are stored in the general prefix called `PREFIX-NAME`.

Use the no form of command to remove the IA\_PD option from the DHCPv6 client request. This command also deletes the learned prefix if it exists.

### Command Syntax

```
ipv6 dhcp prefix-delegation PREFIX-NAME
no ipv6 dhcp prefix-delegation
```

### Parameters

`PREFIX-NAME`      Name of the learned prefix (maximum length 255 characters).

### Default

DHCPv6 Prefix delegation client is not enabled by default.

### Command Mode

Interface mode

### Applicability

This command was introduced in OcNOS version 4.2.

### Examples

```
#configure terminal
(config)#interface xe1
(config-if)#ipv6 dhcp prefix-delegation prefix_xe1
(config-if)#
```

---

## ipv6 address

Use this command to configure the global IPv6 address using the learned prefix and user provided suffix.

Use the `no` form of this command to remove the configuration.

### Command Syntax

```
ipv6 address PREFIX-NAME X:X::X:X/M
no ipv6 address PREFIX-NAME X:X::X:X/M
```

### Parameters

PREFIX-NAME	Name of the prefix which stores the address-prefix learned using prefix delegation enabled in the client interface
X:X::X:X/M	Suffix address consists subnet id and host address. This value must start with '::', and end with a /64 bit prefix.

### Default

DHCPv6 IA\_PD option is not requested by default.

### Command Mode

Interface mode

### Applicability

This command was introduced in OcNOS version 4.2.

### Examples

```
#configure terminal
(config)#interface xe1
(config-if)#ipv6 address dhcp
(config-if)#ipv6 dhcp prefix-delegation prefix_xe1
(config-if)#

(config)#interface xe3
(config-if)#ipv6 address prefix_xe1 ::1:0:0:0:1/64
(config-if)#
```

---

## ipv6 address autoconfig

Use this command to enable autoconfiguration of IPv6 address in host interface. IPv6 address are formed using the Prefix learned from RA and suffix formed using EUI-64 method.

Autoconfiguration of IPv6 address will be successful only when the received prefix length is 64.

Use the `no` form of this command to disable the ipv6 address autoconfiguration.

### Command Syntax

```
ipv6 address autoconfig
```

### Parameters

None

### Default

No default value specified.

### Command Mode

Interface mode

### Applicability

This command was introduced in OcNOS version 4.2.

### Examples

```
#configure terminal
(config)#interface eth0
(config-if)#ipv6 address autoconfig
```

---

## show ipv6 dhcp interface

Use this command to display the DHCPv6 prefix delegation information in the Requesting Router device.

### Command Syntax

```
show ipv6 dhcp interface
```

### Parameters

None

### Command Mode

Executive mode

### Applicability

This command was introduced in OcNOS version 4.2.

### Examples

```
#show ipv6 dhcp interface
xe1 is in client mode
prefix name: prefix_xe1
learned prefix: 1212:501:102::/48
preferred lifetime 600, valid lifetime 600
interfaces using the learned prefix
xe3    1212:501:102:1::1
```



---

## CHAPTER 7 DHCP Snooping Commands

---

This chapter describe the commands for DHCP snooping.

- `debug ip dhcp snooping`
- `hardware-profile filter dhcp-snoop`
- `hardware-profile filter dhcp-snoop-ipv6`
- `ip dhcp packet strict-validation bridge`
- `ip dhcp snooping arp-inspection bridge`
- `ip dhcp snooping arp-inspection vlan`
- `ip dhcp snooping arp-inspection validate`
- `ip dhcp snooping bridge`
- `ip dhcp snooping database`
- `ip dhcp snooping information option bridge`
- `ip dhcp snooping trust`
- `ip dhcp snooping verify mac-address`
- `ip dhcp snooping vlan`
- `renew ip dhcp snooping binding database`
- `show debugging ip dhcp snooping`
- `show debugging ip dhcp snooping`
- `show ip dhcp snooping bridge`
- `show ip dhcp snooping binding bridge`

---

## debug ip dhcp snooping

Use this command to enable the debugging DHCP snooping.

Use the `no` parameter to disable the debug options.

### Command Syntax

```
debug ip dhcp snooping (event|rx|tx|packet|all)
no debug ip dhcp snooping (event|rx|tx|packet|all)
```

### Parameters

<code>event</code>	Enable event debugging
<code>rx</code>	Enable receive debugging
<code>tx</code>	Enable transmit debugging
<code>packet</code>	Enable packet debugging
<code>all</code>	Enable all debugging

### Default

By default all debugging options are disabled.

### Command Mode

Exec mode and configure mode

### Applicability

This command was introduced in OcNOS version 5.0.

### Example

```
#debug ip dhcp snooping all
#no debug ip dhcp snooping packet
```



---

## hardware-profile filter dhcp-snoop

Use this command to enable or disable the ingress dhcp-snoop TCAM group.

### Command Syntax

```
hardware-profile filter dhcp-snoop (disable | enable)
```

### Parameters

enable	Enable the ingress dhcp-snoop group
disable	Disable the ingress dhcp-snoop group

### Default

None

### Command Mode

Configure mode

### Applicability

This command was introduced in OcNOS version 5.0.

### Examples

```
configure terminal  
(config)#hardware-profile filter dhcp-snoop enable
```

---

## hardware-profile filter dhcp-snoop-ipv6

Use this command to enable or disable the ingress dhcp-snoop-ipv6 TCAM group.

### Command Syntax

```
hardware-profile filter dhcp-snoop-ipv6 (disable | enable)
```

### Parameters

enable	Enable the ingress dhcp-snoop-ipv6 group
disable	Disable the ingress dhcp-snoop-ipv6 group

### Default

None

### Command Mode

Configure mode

### Applicability

This command was introduced in OcNOS version 5.0.

### Examples

```
configure terminal  
(config)#hardware-profile filter dhcp-snoop-ipv6 enable
```

---

## ip dhcp packet strict-validation bridge

Use this command to enable strict validation of DHCP packets. Strict validation checks that the DHCP option field in the packet is valid including the magic cookie in the first four bytes of the options field. The device drops the packet if validation fails.

Use the `no` form of this command to disable strict validation.

### Command Syntax

```
ip dhcp packet strict-validation bridge <1-32>
no ip dhcp packet strict-validation bridge <1-32>
```

### Parameters

<1-32>	Bridge number
--------	---------------

### Default

By default, strict validation of DHCP packets is disabled.

### Command Mode

Configure mode

### Applicability

This command was introduced in OcNOS version 5.0.

### Example

```
configure terminal
(config)#bridge 1 protocol mstp
(config)#ip dhcp snooping bridge 1
(config)#ip dhcp packet strict-validation bridge 1
```

---

## ip dhcp snooping arp-inspection bridge

Use this command to enable/disable arp-inspection on the bridge.

Note: You must enable dhcp snooping before enabling ARP inspection.

### Command Syntax

```
ip dhcp snooping arp-inspection bridge <1-32>
no ip dhcp snooping arp-inspection bridge <1-32>
```

### Parameter

<1-32>	Bridge number
--------	---------------

### Default

None

### Command Mode

Configure mode

### Applicability

This command was introduced in OcNOS version 5.0.

### Example

```
#configure terminal
(config)#bridge 1 protocol mstp
(config)#ip dhcp snooping bridge 1
(config)#ip dhcp snooping arp-inspection bridge 1
```

---

## ip dhcp snooping arp-inspection vlan

Use this command to enable ARP inspection on the VLAN in a bridge.

Use the no form of this command to disable ARP inspection on the VLAN in a bridge.

### Command Syntax

```
ip dhcp snooping arp-inspection vlan VLAN_RANGE2 bridge <1-32>
no ip dhcp snooping arp-inspection vlan VLAN_RANGE2 bridge <1-32>
```

### Parameters

VLAN_RANGE2	VLAN identifier <1-4094> or range such as 2-5,10 or 2-5,7-19
<1-32>	Bridge number

### Default

None

### Command Mode

Configure mode

### Applicability

This command was introduced in OcNOS version 5.0.

### Examples

```
configure terminal
(config)#bridge 1 protocol mstp
(config)#ip dhcp snooping bridge 1
(config)#ip dhcp snooping arp-inspection bridge 1
(config)#vlan 2 bridge 1 state enable
(config)#ip dhcp snooping vlan 2 bridge 1
(config)#ip dhcp snooping arp-inspection vlan 2 bridge 1
```

---

## ip dhcp snooping arp-inspection validate

Use this command to enable validation of the source-mac, destination-mac, or IP address field in the ARP packet payload.

Note: The IP address in a payload is validated for not being a broadcast address, a reserved zero IP address, and multicast address.

Use the `no` form of this command to disable validation of the source-mac, destination-mac, or IP address field in the ARP packet payload

### Command Syntax

```
ip dhcp snooping arp-inspection validate (dst-mac | ip | src-mac) bridge <1-32>
no ip dhcp snooping arp-inspection validate (dst-mac | ip | src-mac) bridge <1-32>
```

### Parameters

<code>dst-mac</code>	Destination MAC validation
<code>ip</code>	ARP IP address validation
<code>src-mac</code>	Source MAC validation
<code>&lt;1-32&gt;</code>	Bridge number

### Default

None

### Command Mode

Configure mode

### Applicability

This command was introduced in OcNOS version 5.0.

### Examples

```
configure terminal
(config)# bridge 1 protocol mstp
(config)#ip dhcp snooping bridge 1
(config)#ip dhcp snooping arp-inspection bridge 1
(config)#ip dhcp snooping arp-inspection validate dst-mac bridge 1
(config)#no ip dhcp snooping arp-inspection validate dst-mac bridge 1
(config)#ip dhcp snooping arp-inspection validate src-mac bridge 1
(config)#no ip dhcp snooping arp-inspection validate src-mac bridge 1
(config)#ip dhcp snooping arp-inspection validate ip bridge 1
(config)#no ip dhcp snooping arp-inspection validate ip bridge 1
```

---

## ip dhcp snooping bridge

Use this command to enable DHCP snooping on a bridge.

Use the `no` form of this command to disable DHCP snooping on a bridge.

### Command Syntax

```
ip dhcp snooping bridge <1-32>
no ip dhcp snooping bridge <1-32>
```

### Parameters

<1-32>	Bridge number
--------	---------------

### Default

By default DHCP snooping is disabled on a bridge.

### Command Mode

Configure mode

### Applicability

This command was introduced in OcNOS version 5.0.

### Example

```
#configure terminal
(config)#bridge 1 protocol mstp
(config)#ip dhcp snooping bridge 1
```

---

## ip dhcp snooping database

Use this command to write the entries in the binding table to persistent storage.

### Command Syntax

```
ip dhcp snooping database bridge <1-32>
```

### Parameters

<1-32>	Bridge number
--------	---------------

### Default

No default value is specified.

### Command Mode

Privileged Exec Mode and Exec mode

### Applicability

This command was introduced in OcNOS version 5.0.

### Example

```
#ip dhcp snooping database bridge 1
```



---

## ip dhcp snooping information option bridge

Use this command to insert interface and VLAN name in the option 82 field in DHCP packets.

Use the `no` form of this command to disable inserting option 82 information in DHCP packets.

### Command Syntax

```
ip dhcp snooping information option bridge <1-32>
no ip dhcp snooping information option bridge <1-32>
```

### Parameters

<1-32>                      Bridge number

### Default

By default option 82 information insertion is disabled.

### Command Mode

Configure mode

### Applicability

This command was introduced in OcNOS version 5.0.

### Example

```
configure terminal
(config)# bridge 1 protocol mstp
(config)#ip dhcp snooping bridge 1
(config)#vlan 2 bridge 1 state enable
(config)#ip dhcp snooping vlan 2 bridge 1
(config)#ip dhcp information option bridge 1
```

---

## ip dhcp snooping trust

Use this command to mark an interface as trusted. All DHCP servers must be connected to the trusted interface.

Use the `no` form of this command to remove an interface from the list of trusted interfaces.

### Command Syntax

```
ip dhcp snooping trust
no ip dhcp snooping trust
```

### Parameters

None

### Default

By default all interfaces are untrusted.

### Command Mode

Interface mode

### Applicability

This command was introduced in OcnOS version 5.0.

### Example

```
configure terminal
(config)#bridge 1 protocol mstp
(config)#ip dhcp snooping bridge 1
(config)#vlan 2 bridge 1 state enable
(config)#ip dhcp snooping vlan 2 bridge 1
(config)#interface xe1
(config-if)#switchport
(config-if)#bridge-group 1
(config-if)#switchport mode access
(config-if)#switchport access vlan 2
(config-if)#ip dhcp snooping trust
```

---

## ip dhcp snooping verify mac-address

Use this command to enable MAC address verification. If the device receives a DHCP request packet on an untrusted interface and the source MAC address and the DHCP client hardware address do not match, the device drops the packet.

Use the `no` form of this command to disable address verification.

### Command Syntax

```
ip dhcp snooping verify mac-address bridge <1-32>
no ip dhcp snooping verify mac-address bridge <1-32>
```

### Parameters

<1-32>	Bridge number
--------	---------------

### Default

By default MAC address verification is disabled.

### Command Mode

Configure mode

### Applicability

This command was introduced in OcNOS version 5.0.

### Example

```
configure terminal
(config)# bridge 1 protocol mstp
(config)#ip dhcp snooping bridge 1
(config)#ip dhcp snooping verify mac-address bridge 1
```

---

## ip dhcp snooping vlan

Use this command to enable DHCP snooping for the given VLAN.

Use the `no` form of this command to disable the DHCP snooping for a VLAN.

### Command Syntax

```
ip dhcp snooping vlan VLAN_RANGE2 bridge <1-32>
no ip dhcp snooping vlan VLAN_RANGE2 bridge <1-32>
```

### Parameters

VLAN_RANGE2	VLAN identifier <1-4094> or range such as 2-5,10 or 2-5,7-19
<1-32>	Bridge number

### Default

By default DHCP snooping is disabled for all VLANs.

### Command Mode

Configure mode

### Applicability

This command was introduced in OcnOS version 5.0.

### Example

```
configure terminal
(config)#vlan 2 bridge 1 state enable
(config)#ip dhcp snooping vlan 2 bridge 1
```

---

## renew ip dhcp snooping binding database

Use this command to populate the binding table by fetching the binding entries from persistent storage.

### Command Syntax

```
renew ip dhcp snooping (source|) binding database bridge <1-32>
```

### Parameters

<1-32>	Bridge number
source	IP source guard

### Default

No default value is specified.

### Command Mode

Privileged Exec Mode and Exec mode

### Applicability

This command was introduced in OcNOS version 5.0.

### Example

```
#renew ip dhcp snooping binding database bridge 1
```

---

## show debugging ip dhcp snooping

Use this command to display the enabled debugging options.

### Command Syntax

```
show debugging ip dhcp snooping
```

### Parameters

None

### Command Mode

Privileged Exec Mode and Exec mode

### Applicability

This command was introduced in OcNOS version 5.0.

### Example

```
#show debugging ip dhcp snooping
DHCP snoop debugging status:
DHCP snoop event debugging is on
DHCP snoop tx debugging is on
```

---

## show ip dhcp snooping arp-inspection statistics bridge

Use this command to show dhcp dynamic ARP inspection related statistics on bridge.

### Command Syntax

```
show ip dhcp snooping arp-inspection statistics bridge <1-32>
```

### Parameters

<1-32>                      Bridge number.

### Command Mode

Exec mode

### Applicability

This command was introduced in OcNOS version 5.0.

### Examples

```
#show ip dhcp snooping arp-inspection statistics bridge 1
```

```
bridge      forwarded  dai dropped
-----
1           9          1
```

[Table 7-15](#) explains the fields in the output.

**Table 7-15: show ip dhcp snooping arp-inspection statistics bridge fields**

Field	Description
bridge	Bridge number.
forwarded	Number of forwarded packets.
dai dropped	Number of dropped packets.

---

## show ip dhcp snooping bridge

Use this command to display the DHCP configuration, including trusted ports, configured VLAN, active VLAN, and strict validation status.

### Command Syntax

```
show ip dhcp snooping bridge <1-32>
```

### Parameters

```
<1-32>          Bridge number
```

### Command Mode

Exec mode

### Applicability

This command was introduced in OcNOS version 5.0.

### Example

```
#show ip dhcp snooping bridge 1
```

```
Bridge Group                               : 1
DHCP snooping is                            : Enabled
DHCP snooping option82 is                  : Disabled
Verification of hwaddr field is            : Disabled
Strict validation of DHCP packet is        : Disabled
DB Write Interval(secs)                    : 300
DHCP snooping is configured on following VLANs : 20,30
DHCP snooping is operational on following VLANs : 20,30
```

DHCP snooping trust is configured on the following Interfaces

```
Interface          Trusted
-----          -
xe1                 Yes
```

DHCP snooping IP Source Guard is configured on the following Interfaces

```
Interface          Source Guard
-----          -
```

[Table 7-16](#) explains the fields in the output.

**Table 7-16: show ip dhcp snooping bridge fields**

Field	Description
Bridge Group	Bridge number
DHCP snooping is	Whether DHCP snooping is enabled



**Table 7-16: show ip dhcp snooping bridge fields (Continued)**

<b>Field</b>	<b>Description</b>
DHCP snooping option82 is	Whether DHCP snooping option 82 is enabled
Verification of hwaddr field is	Whether verification of hwaddr field is enabled
Strict validation of DHCP packet is	Whether strict validation of DHCP packets is enabled
DB Write Interval(secs)	Database write interval in seconds
DHCP snooping is configured on following VLANs	VLANs on which DHCP snooping is enabled
DHCP snooping is operational on following VLANs	VLANs on which DHCP snooping is operating
Interface	Interface name
Trusted	Whether DHCP snooping trust is enabled on the interface
Source Guard	Whether DHCP snooping IP source guard is enabled on the interface

## show ip dhcp snooping binding bridge

Use this command to display the DHCP snooping binding table.

### Command Syntax

```
show ip dhcp snooping binding bridge <1-32>
```

### Parameters

<1-32>                      Bridge number

### Command Mode

Exec mode

### Applicability

This command was introduced in OcNOS version 5.0.

### Example

```
#show ip dhcp snooping binding bridge 1
```

```
Total number of static IPV4 entries           : 0
Total number of dynamic IPV4 entries          : 2
Total number of static IPV6 entries           : 0
Total number of dynamic IPV6 entries          : 0
```

MacAddress	IpAddress	Lease (sec)	Type	VLAN	Interface
-----	-----	-----	-----	----	-----
3cfd.fe0b.06e0	12.12.12.10	30	dhcp-snooping	20	xe12
3cfd.fe0b.06e0	30.30.30.30	480	dhcp-snooping	30	xe12

[Table 7-17](#) explains the output .

**Table 7-17: show ip dhcp snooping binding bridge fields**

Field	Description
Total number of static IPV4 entries	Number of static IPV4 entries.
Total number of dynamic IPV4 entries	Number of dynamic IPV4 entries.
Total number of static IPV6 entries	Number of static IPV6 entries.
Total number of dynamic IPV6 entries	Number of dynamic IPV6 entries .
MacAddress	MAC address of the interface.
IP Address	IP address of the peer device.
Lease (sec)	DHCP lease time in seconds provided to untrusted IP addresses.
Type	Configured either statically or dynamically by the DHCP server.

**Table 7-17: show ip dhcp snooping binding bridge fields**

Field	Description
VLAN	Identifier of the number.
Interface	Interface is being snooped.



---

## CHAPTER 8 DHCP Server Commands

---

This chapter describes the Dynamic Host Configuration Protocol (DHCP) server commands.

A DHCP server is a network server that automatically provides and assigns IP addresses, default gateways, and other network parameters to client devices. A DHCP server relies on the standard protocol known as Dynamic Host Configuration Protocol or DHCP to respond to broadcast queries by clients.

This chapter contains these commands:

- `address range low-address A.B.C.D (high-address A.B.C.D|)`
- `address range low-address X:X::X:X (high-address X:X::X:X|)`
- `boot-file`
- `dns-server A.B.C.D`
- `dns-server X:X::X:X`
- `domain-name`
- `host-name`
- `ip dhcp server (interface mode)`
- `ip dhcp server default-lease-time`
- `ip dhcp server max-lease-time`
- `ip dhcp server pool`
- `ipv6 dhcp server (interface mode)`
- `ipv6 dhcp server pool`
- `ipv6 dhcp server preference`
- `ipv6 dhcp server rapid-commit`
- `log-server`
- `network A.B.C.D netmask A.B.C.D`
- `network X:X::X:X netmask <1-128>`
- `ntp-server A.B.C.D`
- `ntp-server X:X::X:X`
- `prefix high-range X:X::X:X low-range X:X::X:X netmask <1-128>`
- `temporary address X:X::X:X`
- `tftp-server`
- `vendor-options`

---

## address range low-address A.B.C.D (high-address A.B.C.D|)

Use this command to create an address-range in the IPv4 DHCP server pool.

Use the `no` form of this command to delete an address-range from the IPv4 DHCP server pool.

### Command Syntax

```
address range low-address A.B.C.D (high-address A.B.C.D|)
no address range low-address A.B.C.D (high-address A.B.C.D|)
```

### Parameters

A.B.C.D	The low range of the IPv4 addresses that the DHCP server should assign to DHCP clients.
A.B.C.D	The high range of the IPv4 addresses that the DHCP server should assign to DHCP clients.

### Default

No default value is specified

### Command Mode

DHCP configure mode

### Applicability

This command was introduced in OcnOS version 6.1.0.

### Examples

```
#configure terminal
(config)#ip dhcp server pool test-pool
(dhcp-config)#address range low-address 3.3.3.1 high-address 3.3.3.4

#configure terminal
(config)#ip vrf vrf1
(config-vrf)#ip dhcp server pool test-pool
(dhcp-config)#address range low-address 3.3.3.1 high-address 3.3.3.4
```

---

## address range low-address X:X::X:X (high-address X:X::X:X|)

Use this command to create an address-range in the IPv6 DHCP server pool.

Use the `no` form of this command to delete an address-range from the IPv6 DHCP server pool.

### Command Syntax

```
address range low-address X:X::X:X (high-address X:X::X:X|)
no address range low-address X:X::X:X (high-address X:X::X:X|)
```

### Parameters

X:X::X:X	The low range of the IPv6 addresses that the DHCP server should assign to DHCP clients.
X:X::X:X	The high range of the IPv6 addresses that the DHCP server should assign to DHCP clients.

### Default

No default value is specified

### Command Mode

DHCP6 configure mode

### Applicability

This command was introduced in OcNOS version 6.1.0.

### Examples

```
#configure terminal
(config)#ipv6 dhcp server pool ipv6_pool
(dhcp6-config)#address range low-address 2001::1 high-address 2001::124

#configure terminal
(config)#ip vrf vrf1
(config-vrf)#ipv6 dhcp server pool ipv6_pool
(dhcp6-config)#address range low-address 2001::1 high-address 2001::124
```

---

## boot-file

Use this command to specify a boot file in the IPv4 DHCP server pool.

Use the `no` form of this command to delete a boot file from the IPv4 DHCP server pool.

### Command Syntax

```
boot-file BOOTFILE
no boot-file BOOTFILE
```

### Parameters

BOOTFILE	Name of the boot file (maximum 63 alphanumeric characters)
----------	--

### Default

No default Value is specified

### Command Mode

DHCP configure mode

### Applicability

This command was introduced in OcNOS version 6.1.0.

### Examples

```
#configure terminal
(config)#ip dhcp server pool test-pool
(dhcp-config)#boot-file ocnos-boot-file
```

```
#configure terminal
(config)#ip vrf vrf1
(config-vrf)#ip dhcp server pool test-pool
(dhcp-config)#boot-file ocnos-boot-file
```



---

## dns-server A.B.C.D

Use this command to specify a DNS name server in the IPv4 DHCP server pool. Multiple name servers can be added to the pool.

Use the `no` form of this command to delete a DNS name server details from the IPv4 DHCP server pool.

### Command Syntax

```
dns-server A.B.C.D
no dns-server A.B.C.D
```

### Parameters

A.B.C.D                  IPv4 DNS name server address

### Default

No default value is specified

### Command Mode

DHCP configure mode

### Applicability

This command was introduced in OcNOS version 6.1.0.

### Examples

```
#configure terminal
(config)#ip dhcp server pool test-pool
(dhcp-config)#dns-server 10.12.3.23
```

```
#configure terminal
(config)#ip vrf vrf1
(config-vrf)#ip dhcp server pool test-pool
(dhcp-config)#dns-server 10.12.3.23
```

---

## dns-server X:X::X:X

Use this command to specify a DNS name server in the IPv6 DHCP server pool. Multiple DNS name servers can be added to the pool.

Use the `no` form of this command to delete a DNS name server from the IPv6 DHCP server pool.

### Command Syntax

```
dns-server X:X::X:X
no dns-server X:X::X:X
```

### Parameters

X:X::X:X          DNS IPv6 name server address

### Default

No default value is specified

### Command Mode

DHCP6 configure mode

### Applicability

This command was introduced in OcnOS version 6.1.0.

### Examples

```
#configure terminal
(config)#ipv6 dhcp server pool ipv6_pool
(dhcp6-config)#dns-server 2001::2
```

```
#configure terminal
(config)#ip vrf vrf1
(config-vrf)#ipv6 dhcp server pool ipv6_pool
(dhcp6-config)#dns-server 2001::2
```

---

## domain-name

Use this command to set the domain name in the IPv6 DHCP server pool.

Use the `no` form of this command to delete the domain name from the IPv6 DHCP server pool.

### Command Syntax

```
domain-name NAME
no domain-name NAME
```

### Parameters

NAME	Name of the domain (maximum 63 alphanumeric characters)
------	---

### Default

No default Value is specified

### Command Mode

DHCP6 configure mode

### Applicability

This command was introduced in OcNOS version 6.1.0.

### Examples

```
#configure terminal
(config)#ipv6 dhcp server pool ipv6_pool
(dhcp6-config)#domain-name ipinfusion.com
```

```
#configure terminal
(config)#ip vrf vrf1
(config-vrf)#ipv6 dhcp server pool ipv6_pool
(dhcp6-config)#domain-name ipinfusion.com
```

---

## host-name

Use this command to set a host name in the IPv4 DHCP server pool.

Use the `no` form of this command to delete the host name from the IPv4 DHCP server pool.

### Command Syntax

```
host-name NAME
no host-name NAME
```

### Parameters

NAME	Name of the host (maximum 63 alphanumeric characters)
------	---

### Default

No default value is specified

### Command Mode

DHCP configure mode

### Applicability

This command was introduced in OcNOS version 6.1.0.

### Examples

```
#configure terminal
(config)#ip dhcp server pool test-pool
(dhcp-config)#host-name dhcp-server
```

```
#configure terminal
(config)#ip vrf vrf1
(config-vrf)#ip dhcp server pool test-pool
(dhcp-config)#host-name dhcp-server
```

---

## ip dhcp server (interface mode)

Use this command to configure an interface as a DHCP server starting interface.

Use the `no` form of this command to remove an interface as a DHCP server starting interface.

### Command Syntax

```
ip dhcp server
no ip dhcp server
```

### Parameters

None

### Default

No default value is specified

### Command Mode

Interface mode

### Applicability

This command was introduced in OcNOS version 6.1.0.

### Examples

```
#configure terminal
(config)#interface eth2
(config-if)#ip dhcp server
```

---

## ip dhcp server default-lease-time

Use this command to set the default lease time for the DHCP server to be shared with the DHCP client.

Use the `no` form of this command to delete the IPv4 default lease time configuration.

### Command Syntax

```
ip dhcp server default-lease-time SECONDS
no ip dhcp server default-lease-time
```

### Parameters

`SECONDS` Default lease time in seconds. Default is 86400 seconds.

### Default

Default value is 86400 seconds

### Command Mode

Configure mode

VRF mode

### Applicability

This command was introduced in OcNOS version 6.1.0.

### Examples

```
#configure terminal
(config)#ip dhcp server default-lease-time 500
```

```
#configure terminal
(config)#ip vrf vrf1
(config-vrf)#ip dhcp server default-lease-time 400
```

---

## ip dhcp server max-lease-time

Use this command to set the maximum lease time for the DHCP server to be shared with the DHCP client.

Use the `no` form of this command to delete the IPv4 maximum lease time configuration.

### Command Syntax

```
ip dhcp server max-lease-time SECONDS
no ip dhcp server max-lease-time
```

### Parameters

`SECONDS` Maximum lease time in seconds. Default is 86400 seconds.

### Default

Default value is 86400 seconds

### Command Mode

Configure mode

VRF mode

### Applicability

This command was introduced in OcNOS version 6.1.0.

### Examples

```
#configure terminal
(config)#ip dhcp server max-lease-time 500
```

```
#configure terminal
(config)#ip vrf vrf1
(config-vrf)#ip dhcp server max-lease-time 400
```

---

## ip dhcp server pool

Use this command to create a IPv4 DHCP server pool.

Use the `no` form of this command to delete a IPv4 DHCP server pool.

### Command Syntax

```
ip dhcp server pool NAME
no ip dhcp server pool NAME
```

### Parameters

NAME	Name of the pool (maximum 63 alphanumeric characters)
------	---

### Default

No default value is specified

### Command Mode

Configure mode

VRF mode

### Applicability

This command was introduced in OcNOS version 6.1.0.

### Examples

```
#configure terminal
(config)#ip dhcp server pool test-pool
```

```
#configure terminal
(config)#ip vrf vrf1
(config-vrf)#ip dhcp server pool test-pool
```



---

## ipv6 dhcp server (interface mode)

Use this command to set an interface as a DHCPv6 server starting interface.

Use the `no` form of this command to remove an interface as a DHCPv6 server starting interface.

### Command Syntax

```
ipv6 dhcp server
no ipv6 dhcp server
```

### Parameters

None

### Default

No default value is specified

### Command Mode

Interface mode

### Applicability

This command was introduced in OcNOS version 6.1.0.

### Examples

```
#configure terminal
(config)#interface eth2
(config-if)#ipv6 dhcp server
```

---

## ipv6 dhcp server pool

Use this command to create a IPv6 DHCP server pool.

Use the `no` form of this command to delete a IPv6 DHCP server pool.

### Command Syntax

```
ipv6 dhcp server pool NAME
no ipv6 dhcp server pool NAME
```

### Parameters

NAME	Name of the pool (maximum 63 alphanumeric characters)
------	---

### Default

No default value is specified

### Command Mode

Configure mode

VRF mode

### Applicability

This command was introduced in OcNOS version 6.1.0.

### Examples

```
#configure terminal
(config)#ipv6 dhcp server pool test-pool
```

```
#configure terminal
(config)#ip vrf vrf1
(config-vrf)#ipv6 dhcp server pool test-pool
```

---

## ipv6 dhcp server preference

Use this command to make a DHCPv6 server preferred.

Use the `no` form of this command to disable a server preference.

### Command Syntax

```
ipv6 dhcp server preference
no ipv6 dhcp server preference
```

### Parameters

None

### Default

No default value is specified

### Command Mode

Configure mode

VRF mode

### Applicability

This command was introduced in OcNOS version 6.1.0.

### Examples

```
#configure terminal
(config)#ipv6 dhcp server preference
```

```
#configure terminal
(config)#ip vrf vrf1
(config-vrf)#ipv6 dhcp server preference
```

---

## ipv6 dhcp server rapid-commit

Use this command to enable the DHCP client to obtain configuration parameters from the server through a rapid two message exchange (solicit and reply).

Use the `no` form of this command to disable the IPv6 DHCP server rapid-commit option.

### Command Syntax

```
ipv6 dhcp server rapid-commit
no ipv6 dhcp server rapid-commit
```

### Parameters

None

### Default

No default value is specified

### Command Mode

Configure mode

VRF mode

### Applicability

This command was introduced in OcNOS version 6.1.0.

### Examples

```
#configure terminal
(config)#ipv6 dhcp server rapid-commit
```

```
#configure terminal
(config)#ip vrf vrf1
(config-vrf)#ipv6 dhcp server rapid-commit
```

---

## log-server

Use this command to specify a log server in the IPv4 DHCP server pool. Multiple log servers can be added to the pool. Use the `no` form of this command to delete a log server from the IPv4 DHCP server pool.

### Command Syntax

```
log-server A.B.C.D
no log-server A.B.C.D
```

### Parameters

A.B.C.D                  IPv4 log server address

### Default

No default value is specified

### Command Mode

DHCP configure mode

### Applicability

This command was introduced in OcNOS version 6.1.0.

### Examples

```
#configure terminal
(config)#ip dhcp server pool test-pool
(dhcp-config)#log-server 10.12.43.97
```

```
#configure terminal
(config)#ip vrf vrf1
(config-vrf)#ip dhcp server pool test-pool
(dhcp-config)#log-server 10.12.43.97
```

---

## network A.B.C.D netmask A.B.C.D

Use this command to specify a network and netmask in the IPv4 DHCP server pool.

Use the `no` form of this command to delete the network and netmask from the IPv4 DHCP server pool.

### Command Syntax

```
network A.B.C.D netmask A.B.C.D
no network A.B.C.D netmask A.B.C.D
```

### Parameters

A.B.C.D	Network part of the subnet to use to assign IPv4 addresses to hosts
A.B.C.D	Mask part of the subnet to use to assign IPv4 addresses to host

### Default

No default value is specified

### Command Mode

DHCP configure mode

### Applicability

This command was introduced in OcNOS version 6.1.0.

### Examples

```
#configure terminal
(config)#ip dhcp server pool test-pool
(dhcp-config)#network 3.3.3.0 netmask 255.255.255.0
```

```
#configure terminal
(config)#ip vrf vrf1
(config-vrf)#ip dhcp server pool test-pool
(dhcp-config)#network 3.3.3.0 netmask 255.255.255.0
```

---

## network X:X::X:X netmask <1-128>

Use this command to specify a network and netmask in the IPv6 DHCP server pool.

Use the `no` form of this command to delete the network and netmask from the IPv6 DHCP server pool.

### Command Syntax

```
network X:X::X:X netmask <1-128>
no network X:X::X:X netmask <1-128>
```

### Parameters

X:X:X:X	Network part of the subnet to use to assign IPv6 addresses to hosts
<1-128>	Mask part of the subnet to use to assign IPv6 addresses to host

### Default

No default value is specified

### Command Mode

DHCP6 configure mode

### Applicability

This command was introduced in OcNOS version 6.1.0.

### Examples

```
#configure terminal
(config)#ipv6 dhcp server pool ipv6_pool
(dhcp6-config)#network 2001:: netmask 64

#configure terminal
(config)#ip vrf vrf1
(config-vrf)#ipv6 dhcp server pool ipv6_pool
(dhcp6-config)#network 2001:: netmask 64
```

---

## ntp-server A.B.C.D

Use this command to specify an NTP server in the IPv4 DHCP server pool. Multiple NTP servers can be added to the pool.

Use the `no` form of this command to delete an NTP server from the IPv4 DHCP server pool.

### Command Syntax

```
ntp-server A.B.C.D
no ntp-server A.B.C.D
```

### Parameters

A.B.C.D	NTP IPv4 server address
---------	-------------------------

### Default

No default Value is specified

### Command Mode

DHCP configure mode

### Applicability

This command was introduced in OcNOS version 6.1.0.

### Examples

```
#configure terminal
(config)#ip dhcp server pool test-pool
(dhcp-config)#ntp-server 10.12.43.97
```

```
#configure terminal
(config)#ip vrf vrf1
(config-vrf)#ip dhcp server pool test-pool
(dhcp-config)#ntp-server 10.12.43.97
```



---

## ntp-server X:X::X:X

Use this command to specify an NTP server in the IPv6 DHCP server pool. Multiple NTP servers can be added to the pool.

Use the `no` form of this command to delete an NTP server from the IPv6 DHCP server pool.

### Command Syntax

```
ntp-server X:X::X:X
no ntp-server X:X::X:X
```

### Parameters

X:X::X:X            NTP IPv6 server address

### Default

No default Value is specified

### Command Mode

DHCP6 configure mode

### Applicability

This command was introduced in OcNOS version 6.1.0.

### Examples

```
#configure terminal
(config)#ipv6 dhcp server pool ipv6_pool
(dhcp6-config)#ntp-server 2001::2
```

```
#configure terminal
(config)#ip vrf vrf1
(config-vrf)#ipv6 dhcp server pool ipv6_pool
(dhcp6-config)#ntp-server 2001::2
```

---

## prefix high-range X:X::X:X low-range X:X::X:X netmask <1-128>

Use this command to add the DHCPv6 prefix range in the IPv6 DHCP server pool used for prefix delegation.

Use the `no` form of this command to delete the prefix-range from the IPv6 DHCP server pool.

### Command Syntax

```
prefix high-range X:X::X:X low-range X:X::X:X netmask <1-128>
no prefix high-range X:X::X:X low-range X:X::X:X netmask <1-128>
```

### Parameters

X:X::X:X	IPv6 prefix high range value
X:X::X:X	IPv6 prefix low range value
<1-128>	Network mask

### Default

No default value is specified

### Command Mode

Configure mode

VRF mode

### Applicability

This command was introduced in OcNOS version 6.1.0.

### Examples

```
#configure terminal
(config)#ipv6 dhcp server pool ipv6_pool
(dhcp6-config)#prefix high-range 3001:db8:1234:: low-range 3001:db8:1c0f:: netmask 48
```

```
#configure terminal
(config)#ip vrf vrf1
(config-vrf)#ipv6 dhcp server pool ipv6_pool
(dhcp6-config)#prefix high-range 3001:db8:1234:: low-range 3001:db8:1c0f:: netmask 48
```

---

## temporary address X:X::X:X

Use this command to add an IPv6 temporary address to the IPv6 DHCP server pool.

Use the `no` form of this command to delete an IPv6 temporary address from the IPv6 DHCP server pool.

### Command Syntax

```
temporary address X:X::X:X
no temporary address
```

### Parameters

X:X::X:X            IPv6 DHCP Temporary address

### Default

No default value is specified

### Command Mode

DHCP6 configure mode

### Applicability

This command was introduced in OcNOS version 6.1.0.

### Examples

```
#configure terminal
(config)#ipv6 dhcp server pool ipv6_pool
(dhcp6-config)#temporary address 2001::
```

```
#configure terminal
(config)#ip vrf vrf1
(config-vrf)#ipv6 dhcp server pool ipv6_pool
(dhcp6-config)#temporary address 2001::
```

---

## tftp-server

Use this command to specify a TFTP server in the IPv4 DHCP server pool.

Use the `no` form of this command to delete a TFTP server from the IPv4 DHCP server pool.

### Command Syntax

```
tftp-server A.B.C.D
no tftp-server A.B.C.D
```

### Parameters

A.B.C.D            TFTP IPv4 server address

### Default

No default Value is specified

### Command Mode

DHCP configure mode

### Applicability

This command was introduced in OcNOS version 6.1.0.

### Examples

```
#configure terminal
(config)#ip dhcp server pool test-pool
(dhcp-config)#tftp-server 10.12.43.97
```

```
#configure terminal
(config)#ip vrf vrf1
(config-vrf)#ip dhcp server pool test-pool
(dhcp-config)#tftp-server 10.12.43.97
```

---

## vendor-options

Use this command to specify vendor options in the IPv6 DHCP server pool.

Use the `no` form of this command to delete the vendor options from the IPv6 DHCP server pool.

### Command Syntax

```
vendor-options VENDOR-OPTS
no vendor-options VENDOR-OPTS
```

### Parameters

VENDOR-OPTS      Vendor option details

### Default

No default Value is specified

### Command Mode

DHCP6 configure mode

### Applicability

This command was introduced in OcNOS version 6.1.0.

### Examples

```
#configure terminal
(config)#ipv6 dhcp server pool ipv6_pool
(dhcp6-config)#vendor-options 00:00:09:bf:63
```

```
#configure terminal
(config)#ip vrf vrf1
(config-vrf)#ipv6 dhcp server pool ipv6_pool
(dhcp6-config)#vendor-options 00:00:09:bf:63
```



## CHAPTER 9 IP Source Guard Commands

---

This chapter describes the commands for IP Source Guard (IPSG):

- [hardware-profile filter ipsg](#)
- [hardware-profile filter ipsg-ipv6](#)
- [ip verify source dhcp-snooping-vlan](#)

---

## hardware-profile filter ipsg

Use this command to enable or disable the ingress IPSG TCAM group for IPv4.

### Command Syntax

```
hardware-profile filter ipsg (disable | enable)
```

### Parameters

enable	Enable the ingress IPSG TCAM group
disable	Disable the ingress IPSG TCAM group

### Default

N/A

### Command Mode

Configure mode

### Applicability

This command was introduced in OcNOS version 5.0.

### Examples

```
#configure terminal  
(config)# hardware-profile filter ipsg enable
```



---

## hardware-profile filter ips-g-ipv6

Use this command to enable or disable the ingress IPSG TCAM group for IPv6.

### Command Syntax

```
hardware-profile filter ips-g-ipv6 (disable | enable)
```

### Parameters

enable	Enable the ingress IPSG TCAM group
disable	Disable the ingress IPSG TCAM group

### Default

N/A

### Command Mode

Config mode

### Applicability

This command was introduced in OcNOS version 5.0.

### Examples

```
#configure terminal  
(config)# hardware-profile filter ips-g-ipv6 disable
```

---

## ip verify source dhcp-snooping-vlan

Use this command to enable the IPSG feature at the interface level.

Use the no form of this command to disable the IPSG on an interface.

### Command Syntax

```
ip verify source dhcp-snooping-vlan
no ip verify source dhcp-snooping-vlan
```

### Parameters

None

### Default

N/A

### Command Mode

Interface mode

### Applicability

This command was introduced in OcNOS version 5.0.

### Examples

```
#configure terminal
(config)#interface xe1
(config-if)#ip verify source dhcp-snooping-vlan

(config-if)#no ip verify source dhcp-snooping-vlan
```

## CHAPTER 10 Domain Name System Commands

---

This chapter describes Domain Name System (DNS) commands. DNS translates easily-to-remember domain names into numeric IP addresses needed to locate computer services and devices. By providing a worldwide, distributed keyword-based redirection service, DNS is an essential component of the Internet.

The DNS database is hierarchical. When a client such as a Web browser gives a request that specifies a host name, the DNS resolver on the client first contacts a DNS server to determine the server's IP address. If the DNS server does not contain the needed mapping, it forwards the request to a different DNS server at the next higher level in the hierarchy. After potentially several forwarding and delegation messages are sent within the DNS hierarchy, the IP address for the given host eventually arrives at the resolver, that in turn completes the request over Internet Protocol (IP).

Note: The commands below are supported only on the “management” VRF.

The chapter contains these commands:

- [debug dns client](#)
- [ip domain-list](#)
- [ip domain-lookup](#)
- [ip domain-name](#)
- [ip host](#)
- [ip name-server](#)
- [show hosts](#)
- [show running-config dns](#)

---

## debug dns client

Use this command to display DNS debugging messages.

Use the `no` form of this command to stop displaying DNS debugging messages.

### Command Syntax

```
debug dns client
no debug dns client
```

### Parameters

None

### Default

By default, disabled.

### Command Mode

Exec mode, Privileged Exec mode, and Configure mode

### Applicability

This command was introduced before OcNOS version 1.3.

### Examples

```
#configure terminal
(config)#debug dns client
```

## ip domain-list

Use this command to define a list of default domain names used to complete unqualified host names. Each domain in the list is to be tried in turn.

The `ip domain-list` command is similar to the [ip domain-name](#) command, except that with the `ip domain-list` command you can define a list of domains, each to be tried in turn.

If there is no domain list, the default domain name specified with the `ip domain-name` command is used. If there is a domain list, the default domain name is not used.

Use the `no` form of this command to remove a domain.

### Command Syntax

```
ip domain-list (vrf management|) DOMAIN-NAME
no ip domain-list (vrf management|) DOMAIN-NAME
```

### Parameters

management	Virtual Routing and Forwarding name
DOMAIN-NAME	Domain string (e.g. company.com)(Max Size 64)

### Default

No default is specified.

### Command Mode

Configure mode

### Applicability

This command was introduced before OcnOS version 1.3.

### Examples

```
#configure terminal
(config)#ip domain-list mySite.com
```

---

## ip domain-lookup

Use this command to enable DNS host name-to-address translation.

Use the `no` form of this command to disable DNS.

### Command Syntax

```
ip domain-lookup (vrf management|)
no ip domain-lookup (vrf management|)
```

### Parameters

<code>management</code>	Virtual Routing and Forwarding name
-------------------------	-------------------------------------

### Default

No default is specified.

### Command Mode

Configure mode

### Applicability

This command was introduced before OcNOS version 1.3.

### Examples

```
#configure terminal
(config)#ip domain-lookup
```

## ip domain-name

Use this command to set the default domain name used to complete unqualified host names (names without a dotted-decimal domain name).

The [ip domain-list](#) command is similar to the `ip domain-name` command, except that with the `ip domain-list` command you can define a list of domains, each to be tried in turn.

If a domain list has been created with [ip domain-list](#), the default domain name is not used. If there is no domain list, the default domain name is used.

Use the `no` form of this command to disable DNS.

### Command Syntax

```
ip domain-name (vrf management|) DOMAIN-NAME
no ip domain-name (vrf management|) DOMAIN-NAME
```

### Parameters

management	Virtual Routing and Forwarding name
DOMAIN-NAME	Domain string (e.g. company.com)(Max Size 64)

### Default

No default is specified.

### Command Mode

Configure mode

### Applicability

This command was introduced before OcnOS version 1.3.

### Examples

```
#configure terminal
(config)#ip domain-name company.com
```

---

## ip host

Use this command to define static a hostname-to-address mapping in DNS. You can specify one mapping in a command.

Use the `no` form of this command remove a hostname-to-address mapping.

### Command Syntax

```
ip host (vrf management|) WORD (X:X::X:X | A.B.C.D)
no ip host (vrf management|) WORD (X:X::X:X | A.B.C.D)
```

### Parameters

management	Virtual Routing and Forwarding name
WORD	Host name, such as company.com
X:X::X:X	IPv6 address of the host
A.B.C.D	IPv4 address of the host

### Default

No default is specified.

### Command Mode

Configure mode

### Applicability

This command was introduced before OcnOS version 1.3.

### Examples

```
#configure terminal
(config)#ip host company.com 192.0.2.1
```



---

## ip name-server

Use this command to add a DNS server address that is used to translate hostnames to IP addresses.

Use the `no` form of this command to remove a DNS server address.

### Command Syntax

```
ip name-server (vrf management|) (X:X::X:X | A.B.C.D)
no ip name-server (vrf management|) (X:X::X:X | A.B.C.D)
```

### Parameters

management	Virtual Routing and Forwarding name
A.B.C.D	IPv4 address of the host
X:X::X:X	IPv6 address of the host

### Default

No default is specified.

### Command Mode

Configure mode

### Applicability

This command was introduced before OcnOS version 1.3.

### Examples

```
#configure terminal
(config)#ip name-server 123.70.0.23
```



**Table 10-18: show hosts fields**

Entry	Description
Host	Static hostname-to-address mappings in DNS.
Test	Static hostname-to-address mappings in DNS.
* - Values assigned by DHCP Client.	Name-server indicates it has been learned dynamically.

---

## show running-config dns

Use this command to show the DNS settings of the running configuration.

### Command Syntax

```
show running-config dns (vrf management|)
```

### Parameters

vrf                      management

### Command Mode

Exec mode and Privileged Exec mode

### Applicability

This command was introduced before OcNOS version 1.3.

### Example

```
#show running-config dns
ip domain-lookup vrf management
ip domain-name vrf management .com
ip domain-list vrf management .in
ip domain-list vrf management .ac
ip name-server vrf management 10.12.3.23
ip host vrf management test 10.12.12.67 10::23
```

## CHAPTER 11 Domain Name System Relay Commands

---

This chapter describes the DNS relay commands:

- [ip dns relay \(global\)](#)
- [ip dns relay \(interface\)](#)
- [ip dns relay address](#)
- [ip dns relay uplink](#)
- [ipv6 dns relay \(global\)](#)
- [ipv6 dns relay \(interface\)](#)
- [ipv6 dns relay address](#)
- [ipv6 dns relay uplink](#)
- [show ip dns relay](#)
- [show ip dns relay address](#)
- [show ipv6 dns relay](#)
- [show ipv6 dns relay address](#)
- [show running-config dns relay](#)

---

## ip dns relay (global)

Use this command to globally enable the IPv4 DNS relay agent.

Use the `no` form of this command to globally disable the IPv4 DNS relay agent.

### Command Syntax

```
ip dns relay
no ip dns relay
```

### Parameters

None

### Default

By default, IPv4 DNS relay agent is enabled.

### Command Mode

Configure mode

### Applicability

This command was introduced in OcNOS version 5.0.

### Example

```
#configure terminal
(config)#ip dns relay

(config)#no ip dns relay
```

---

## ip dns relay (interface)

Use this command to configure an IPv4 interface as a DNS relay client-facing port.

Use the `no` form of this command to remove an IPv4 interface as a DNS relay client-facing port.

### Command Syntax

```
ip dns relay
no ip dns relay
```

### Parameters

None

### Default

N/A

### Command Mode

Interface mode

### Applicability

This command was introduced in OcNOS version 5.0.

### Example

```
#configure terminal
(config)#int xe44
(config-if)#ip address 4.4.4.1/24
(config-if)#ip dns relay

(config)#int xe44
(config-if)#ip vrf forwarding vrf1
(config-if)#ip address 4.4.4.1/24
(config-if)#ip dns relay
```

---

## ip dns relay address

Use this command to set the IP address of a DNS server.

Use the `no` form of this command to remove the IP address of a DNS server.

### Command Syntax

```
ip dns relay address A.B.C.D
no ip dns relay address A.B.C.D
```

### Parameters

A.B.C.D	IPv4 address of the DNS server
---------	--------------------------------

### Default

N/A

### Command Mode

Configure mode

VRF mode

### Applicability

This command was introduced in OcNOS version 5.0.

### Example

```
#configure terminal
(config)#ip dns relay address 1.1.1.2
#
(config)#ip vrf vrf1
(config-vrf)#ip dns relay address 1.1.1.2
```



---

## ip dns relay uplink

Use this command to configure an IPv4 interface as a DNS relay server-facing port.

Use the `no` form of this command to remove an IPv4 interface as a DNS relay server-facing port.

### Command Syntax

```
ip dns relay uplink
no ip dns relay uplink
```

### Parameters

None

### Default

N/A

### Command Mode

Interface mode

### Applicability

This command was introduced in OcNOS version 5.0.

### Example

```
#configure terminal
(config)#int xe44
(config-if)#ip address 4.4.4.1/24
(config-if)#ip dns relay uplink
```

---

## ipv6 dns relay (global)

Use this command to globally enable the IPv6 DNS relay agent.

Use the `no` form of this command to globally disable the IPv6 DNS relay agent.

### Command Syntax

```
ipv6 dns relay
no ipv6 dns relay
```

### Parameters

None

### Default

By default, the IPv6 DNS relay agent is enabled.

### Command Mode

Configure mode

### Applicability

This command was introduced in OcNOS version 5.0.

### Example

```
#configure terminal
(config)#ipv6 dns relay

#(config)#no ipv6 dns relay
```

---

## IPv6 dns relay (interface)

Use this command to configure an IPv6 interface as a DNS relay client-facing port.

Use the `no` form of this command to remove an IPv6 interface as a DNS relay client-facing port.

### Command Syntax

```
ipv6 dns relay
no ipv6 dns relay
```

### Parameters

None

### Default

N/A

### Command Mode

Interface mode

### Applicability

This command was introduced in OcnOS version 5.0.

### Example

```
#configure terminal
(config)#int xe44
(config-if)#ipv6 address fd02::1/16
(config-if)#ipv6 dns relay

(config)#int xe44
(config-if)#ip vrf forwarding vrf1
(config-if)#ipv6 address fd02::1/16
(config-if)#ipv6 dns relay
```

---

## ipv6 dns relay address

Use this command to set the IPv6 address of a DNS server.

Use the `no` form of this command to remove the IPv6 address of a DNS server.

### Command Syntax

```
ipv6 dns relay address X:X::X:X
no ipv6 dns relay address X:X::X:X
```

### Parameters

<code>X:X::X:X</code>	IPv6 address of the DNS server
-----------------------	--------------------------------

### Default

N/A

### Command Mode

Configure mode

VRF mode

### Applicability

This command was introduced in OcNOS version 5.0.

### Example

```
#configure terminal
(config)#ipv6 dns relay address 2001:4860:4860::8888

(config)#ip vrf vrf1
(config-vrf)#ip dns relay address 2001:4860:4860::8888
```

---

## ipv6 dns relay uplink

Use this command to configure an IPv6 interface as a DNS relay server-facing port.

Use the `no` form of this command to remove an IPv6 interface as a DNS relay server-facing port.

### Command Syntax

```
ipv6 dns relay uplink
no ipv6 dns relay uplink
```

### Parameters

None

### Default

N/A

### Command Mode

Interface mode

### Applicability

This command was introduced in OcNOS version 5.0.

### Example

```
#configure terminal
(config)#int xe44
(config-if)#ipv6 address fd02::1/16
(config-if)#ipv6 dns relay uplink
```

## show ip dns relay

Use this command to display the IPv4 DNS relay configuration including VRF name, DNS servers, and client/user facing interfaces.

### Command Syntax

```
show ip dns relay
```

### Parameters

None

### Command Mode

Exec mode

### Applicability

This command was introduced in OcNOS version 5.0.

### Example

```
#show ip dns relay
DNS feature status:           Enabled
DNS relay service status:    Enabled
VRF Name: vrf1
Status      : Running
DNS Servers: 1.1.1.2
Interfaces :
  Name      Type           State  Address
  -----
  xe1       Uplink             UP     1.1.1.1
  xe32      Downlink           UP     2.2.2.1
  xe33      Downlink           UP     3.3.3.1
  xe44      Downlink           UP     4.4.4.1
VRF Name: management
Status      : Running
DNS Servers: 8.8.8.8
Interfaces :
  Name      Type           State  Address
  -----
  eth0      Downlink           UP     172.29.4.139
```

Table 11-19 explains the fields in the output.

**Table 11-19: show ip dns relay fields**

Field	Description
DNS feature status	Whether DNS relay is enabled
DNS relay service status	Whether DNS relay is enabled

**Table 11-19: show ip dns relay fields (Continued)**

<b>Field</b>	<b>Description</b>
VRF Name	Name of the VRF
Status	Not-running, Running, or Failed
DNS Servers	IPv4 address of the DNS server
Name	DNS server facing interface
Type	Whether an uplink or a downlink
State	Whether the interface is up of down
Address	IPv4 address of the interface

---

## show ip dns relay address

Use this command to display the IPv4 DNS relay configuration including VRF name and DNS servers.

### Command Syntax

```
show ip dns relay address
```

### Parameters

None

### Command Mode

Exec mode

### Applicability

This command was introduced in OcnOS version 5.0.

### Example

```
#show ip dns relay address
DNS feature status:           Enabled
DNS relay service status:     Enabled
VRF Name: vrf1
  Status      : Running
  DNS Servers: 1.1.1.2
VRF Name: management
  Status      : Running
  DNS Servers: 8.8.8.8
```

[Table 11-20](#) explains the fields in the output.

**Table 11-20: show ip dns relay address fields**

Field	Description
DNS feature status	Whether DNS relay is enabled
DNS relay service status	Whether DNS relay is enabled
VRF Name	Name of the VRF
Status	Not-running, Running, or Failed
DNS Servers	IPv4 address of the DNS server



## show ipv6 dns relay

Use this command to display IPv6 DNS relay configuration including VRF name, DNS servers, and client/user facing interfaces.

### Command Syntax

```
show ipv6 dns relay
```

### Parameters

None

### Command Mode

Exec mode

### Applicability

This command was introduced in OcNOS version 5.0.

### Example

```
#show ipv6 dns relay
DNS feature status:           Enabled
DNS relay IPv6 service status: Enabled
VRF Name: vrf1
Status      : Not-running
DNS Servers: fd01::2
Interfaces :
  Name      Type      State  Address
  -----
  xe44     Downlink  UP     fd02::1
```

[Table 11-21](#) explains the fields in the output.

**Table 11-21: show ipv6 dns relay fields**

Field	Description
DNS feature status	Whether DNS relay is enabled
DNS relay IPv6 service status	Whether DNS relay is enabled
VRF Name	Name of the VRF
Status	Not-running, Running, or Failed
DNS Servers	IPv6 address of the DNS server
Name	DNS server facing interface
Type	Whether an uplink or a downlink
State	Whether the interface is up of down
Address	IPv6 address of the interface

## show ipv6 dns relay address

Use this command to display the IPv6 DNS relay configuration including the VRF name and DNS servers.

### Command Syntax

```
show ipv6 dns relay address
```

### Parameters

None

### Command Mode

Exec mode

### Applicability

This command was introduced in OcnOS version 5.0.

### Example

```
#show ipv6 dns relay
DNS feature status:           Enabled
DNS relay IPv6 service status: Enabled
VRF Name: vrf1
Status      : Not-running
DNS Servers: fd01::2
```

[Table 11-22](#) explains the fields in the output.

**Table 11-22: show ipv6 dns relay address fields**

Field	Description
DNS feature status	Whether DNS relay is enabled
DNS relay IPv6 service status	Whether DNS relay is enabled
VRF Name	Name of the VRF
Status	Not-running, Running, or Failed
DNS Servers	IPv6 address of the DNS server

---

## show running-config dns relay

Use this command to display DNS relay settings in the running configuration.

### Command Syntax

```
show running-config dns relay
```

### Parameters

None

### Command Mode

Exec mode

### Applicability

This command was introduced in OcNOS version 5.0.

### Example

```
#show running-config dns relay
no ipv6 dns relay
!
ip vrf vrf1
  ip dns relay address 1.1.1.2
  ipv6 dns relay address fd01::2
!
ip vrf management
  ip dns relay address 8.8.8.8
!
interface eth0
  ip dns relay
!
interface xe1
  ip dns relay uplink
!
interface xe32
  ip dns relay
!
interface xe33
  ip dns relay
!
interface xe44
  ip dns relay
  ipv6 dns relay
!
```



---

## CHAPTER 12 Telnet

---

This chapter describes telnet commands.

Telnet is a client/server protocol that establishes a session between a user terminal and a remote host:

- The telnet client software takes input from the user and sends it to the server's operating system
- The telnet server takes output from the host and sends it to the client to display to the user

While telnet is most often used to implement remote login capability, the protocol is general enough to allow it to be used for a variety of functions.

Note: In OcNOS, the default Linux terminal type is "export TERM=xterm"

Note: The commands below are supported only on the "management" VRF.

This chapter contains these commands:

- [debug telnet server](#)
- [feature telnet](#)
- [show debug telnet-server](#)
- [show running-config telnet server](#)
- [show telnet-server](#)
- [telnet](#)
- [telnet6](#)
- [telnet server port](#)
- [telnet server session-limit](#)

---

## debug telnet server

Use this command to display telnet debugging information.

Use the `no` form of this command to stop displaying telnet debugging information.

### Command Syntax

```
debug telnet server
no debug telnet server
```

### Parameters

None

### Default

By default, disabled.

### Command Mode

Executive mode and configure mode

### Applicability

This command was introduced before OcNOS version 1.3.

### Examples

```
#show debug telnet-server

telnet server debugging is on
#
```

---

## feature telnet

Use this command to enable the telnet server.

Use the `no` form of this command to disable the telnet server.

Note: Executing `no` form command closes the active telnet session.

### Command Syntax

```
feature telnet (vrf management|)
no feature telnet (vrf management|)
```

### Parameters

management      Virtual Routing and Forwarding name

### Default

By default, feature telnet is disabled.

### Command Mode

Configure mode

### Applicability

This command was introduced before OcNOS version 1.3.

### Examples

```
#configure terminal
(config)#feature telnet vrf management
```

---

## show debug telnet-server

Use this command to display whether telnet debugging is enabled.

### Command Syntax

```
show debug telnet-server
```

### Parameters

None

### Command Mode

Exec mode

### Applicability

This command was introduced before OcNOS version 1.3.

### Examples

```
#show debug telnet-server  
telnet server debugging is on
```



---

## show running-config telnet server

Use this command to display telnet settings in the running configuration.

### Command Syntax

```
show running-config telnet server
```

### Parameters

None

### Command Mode

Exec mode

### Applicability

This command was introduced before OcNOS version 1.3.

### Examples

```
#show running-config telnet server

feature telnet vrf management
no feature telnet
```

---

## show telnet-server

Use this command to display the telnet server status.

### Command Syntax

```
show telnet server
```

### Parameters

None

### Command Mode

Exec mode

### Applicability

This command was introduced before OcNOS version 1.3.

### Examples

```
#show telnet server
```

```
VRF MANAGEMENT  
telnet server enabled port: 23
```

```
VRF DEFAULT:  
telnet server disabled port: 23
```

---

## telnet

Use this command to open a telnet session to an ipv4 address or host name resolved to ipv4 address.

### Command Syntax

```
telnet (A.B.C.D | HOSTNAME) (vrf (NAME|management))
telnet (A.B.C.D | HOSTNAME) (<1-65535>) (vrf (NAME|management))
```

### Parameters

A.B.C.D	Destination IPv4 Address to open a telnet session.
HOSTNAME	Destination Hostname to resolve into IPv4 address to open a telnet session.
1-65535	Destination Port to open a telnet session. Default is 23.
vrf	Specify the VPN routing/forwarding instance.
NAME	Specify the name if the VPN routing/forwarding instance.
management	Management VPN routing/forwarding instance name.

### Default

By default, telnet is 23

### Command Mode

Privileged Exec mode

### Applicability

This command was introduced before OcNOS version 1.3.

### Examples

```
#telnet 10.12.16.17 2543 vrf management
Trying 10.12.16.17...
```

---

## telnet6

Use this command to open a telnet session to an ipv6 address or host name resolved to ipv6 address.

### Command Syntax

```
telnet6 (X:X::X:X| HOSTNAME) (vrf (NAME|management))  
telnet6 (X:X::X:X | HOSTNAME) (<1-65535>) (vrf (NAME|management))
```

### Parameters

X:X::X:X	Destination IPv6 Address to open a telnet session.
HOSTNAME	Destination Host name to resolve into IPv6 address to open a telnet session.
1-65535	Destination Port to open a telnet session. Default is 23.
vrf	Specify the VPN routing/forwarding instance.
NAME	Specify the name if the VPN routing/forwarding instance.
management	Management VPN routing/forwarding instance name.

### Default

By default, telnet is 23.

### Command Mode

Privileged Exec mode

### Applicability

This command was introduced before OcNOS version 1.3.

### Examples

```
#telnet6 2:2::2:2 2543 vrf management  
Trying 2:2::2:2...
```

---

## telnet server port

Use this command to set the port number on which the telnet server listens for connections. The default port on which the telnet server listens is 23.

You can only give this command when the telnet server is disabled. See the [feature telnet](#) command.

Use the `no` form of this command to set the default port number (23).

### Command Syntax

```
telnet server (port <1024-65535>) (vrf management|)
no telnet server port (vrf management|)
```

### Parameters

<1024-65535>	Port number
management	Virtual Routing and Forwarding name

### Default

By default, telnet server port number is 23

### Command Mode

Configure mode

### Applicability

This command was introduced before OcnOS version 1.3.

### Examples

```
#configure terminal
(config)#telnet server port 1157 vrf management
```

---

## telnet server session-limit

Use this command to limit number of Telnet sessions. Only 40 sessions allowed including Telnet and SSH. User can only give this command when the telnet server is disabled. See the [feature telnet](#) command.

Use `no` form of this command to set to default value.

### Command Syntax

```
telnet server session-limit <1-40> (vrf management|)
no telnet server session-limit (vrf management|)
```

### Parameters

<code>&lt;1-40&gt;</code>	Number of sessions
<code>management</code>	Virtual Routing and Forwarding name

### Default

By default, 40 sessions are allowed.

### Command Mode

Configure mode

### Applicability

This command was introduced in OcNOS version 4.2

### Examples

```
#configure terminal
(config)#telnet server session-limit 4 vrf management
```

---

## CHAPTER 13 Secure Shell

---

This chapter describes Secure Shell (SSH) commands.

SSH is a cryptographic protocol for secure data communication, remote login, remote command execution, and other secure network services between two networked computers.

Note: In OcNOS, the default Linux terminal type is "export TERM=xterm"

Note: The commands below are supported only on the "management" VRF.

This chapter contains these commands:

- [clear ssh host-key](#)
- [clear ssh hosts](#)
- [clear ssh keypair](#)
- [debug ssh server](#)
- [feature ssh](#)
- [show debug ssh-server](#)
- [show running-config ssh server](#)
- [show ssh host-key](#)
- [show ssh server](#)
- [show username](#)
- [ssh](#)
- [ssh6](#)
- [ssh algorithm encryption](#)
- [ssh keygen host](#)
- [ssh login-attempts](#)
- [ssh server port](#)
- [ssh server session-limit](#)
- [username sshkey](#)
- [username keypair](#)

---

## clear ssh host-key

Use this command to clear the host keys.

### Command syntax

```
clear ssh host-key ((dsa|rsa|ecdsa|ed25519)|) (vrf management|)
```

### Parameters

dsa	dsa keys
rsa	rsa keys
ecdsa	ecdsa keys
ed25519	ed25519 keys
management	Management VRF

### Default

None

### Command Mode

Privilege exec mode

### Applicability

This command was introduced in OcNOS version 5.0

### Examples

```
OcNOS#clear ssh host-key
```



---

## clear ssh hosts

Use this command to clear the `known_hosts` file.

This command clears all trusted relationships established with SSH servers during previous connections. When a client downloads a file from an external server the first time, the client stores the server keys in the `known_hosts` file. After that, other connections to the same server will use the server keys stored in the `known_hosts` file. In other words, a trusted relationship is created when a client accepts the server keys the first time.

An example of when you need to clear a trusted relationship is when SSH server keys are changed.

### Command Syntax

```
clear ssh hosts
```

### Parameters

None

### Command Mode

Exec mode

### Applicability

This command was introduced before OcNOS version 1.3.

### Examples

```
#clear ssh hosts
```

---

## clear ssh keypair

Use this command to clear RSA/DSA keypair generated for an user. This command can be executed only by networkadmin.

### Command Syntax

```
clear ssh keypair user USERNAME
```

### Parameters

None

### Command Mode

Exec mode

### Applicability

This command was introduced before OcNOS version 4.1.

### Examples

```
#clear ssh keypair user test
```

---

## debug ssh server

Use this command to display SSH server debugging information.

Use the `no` form of this command to stop displaying SSH server debugging information.

### Command Syntax

```
debug ssh server
no debug ssh server
```

### Parameters

None

### Default

By default, disabled.

### Command Mode

Executive mode and configure mode

### Applicability

This command was introduced before OcNOS version 1.3.

### Examples

```
#debug ssh server
```

---

## feature ssh

Use this command to enable the SSH server.

Use the `no` form of this command to disable the SSH server.

### Command Syntax

```
feature ssh (vrf management|)
no feature ssh (vrf management|)
```

### Parameters

management      Virtual Routing and Forwarding name

### Default

No default value is specified

### Command Mode

Configure mode

### Applicability

This command was introduced before OcNOS version 1.3.

### Examples

```
#configure terminal
(config)#feature ssh
```

---

## show debug ssh-server

Use this command to display whether SSH debugging is enabled.

### Command Syntax

```
show debug ssh-server
```

### Parameters

None

### Command Mode

Exec mode

### Applicability

This command was introduced before OcNOS version 1.3.

### Examples

```
#show debug ssh-server  
ssh server debugging is on
```

---

## show running-config ssh server

Use this command to display SSH settings in the running configuration.

### Command Syntax

```
show running-config ssh server
```

### Parameters

None

### Command Mode

Exec mode

### Applicability

This command was introduced before OcNOS version 1.3.

### Examples

```
#show running-config ssh server
feature ssh vrf management
ssh server port 1024 vrf management
ssh login-attempts 2 vrf management
ssh server algorithm encryption 3des-cbc
```

---

## show ssh host-key

Use this command to display the SSH server key.

By default, ssh feature is enabled in "management" vrf. Until and unless the same feature is explicitly enabled in "default" vrf, respective show command output will be empty.

### Command syntax

```
show ssh host-key ((dsa|rsa|ecdsa|ed25519)|) (vrf management|)
```

### Parameters

dsa	dsa keys
rsa	rsa keys
ecdsa	ecdsa keys
ed25519	ed25519 keys
management	Management VRF

### Default

If no keys are specified, all host keys will be displayed

### Command Mode

Exec mode

### Applicability

This command was introduced in OcNOS version 5.0

### Examples

```
#sh ssh host-key
*****
dsa public key :

ssh-dss AAAAB3NzaC1kc3MAAACBANgq+TZPkmKOn7ot7PBO9TOCV/
+GPyHCz9Wq39+6veigQ2CWmLNo
uqZb1B05LfeU2MuRz4rt06mcX81nAygqDLNZaRsirYdWTsJ40HAOZYr9765w+M8TAcKmBYbuWSIkqn
YQ
J1h5bj6UrJ7dW4LgaSxmVmrkXoYrr5gnxfEVgw8HAAAAFQC//
BVHnTWh8Iizbk0mvOyNzqtFMwAAAIbQ
Ca9X0qbL66Js0ul+7LMmLvWkC4Fy1Y/3igZORZ+NsnP4CJIJ1JCLwj7nj/NeUfUuyG1/
dnDVdki4FngL
LjbVa5XrK5VbsEj4sZBfebKLVZKd8h880FqNhfc3iZjCGqdYrWWlRYdNqNvq7zVa6YC7Vvo0sEC5/
rDm
aNygbx0iCAAAAIEAoZHk+5cqaYptqYBPGPMRynpWyWJPJQjoiy+p1BRNk7E/kwInQaqmtFQuM/
YaTOoN
nz5skwQ1dJmdJGq+h7bfmab0atzaaVjkcTjz0rtSBO3JID2G6KqG55yhr03bc8BY+A6g9Qm8TuWZU6
8D
NIZGj28GZSbkIpQgqSD9VUAxEHs=

dsa fingerprint :
```

1024 SHA256:Qzd8n4RjsxeW9+AnUP+zc59oPRTl2FBwdwDfVBq0DdQ

\*\*\*\*\*

\*\*\*\*\*

rsa public key :

ssh-rsa AAAAB3NzaC1yc2EAAAADAQABAAQAC706mz0GQvdEaqK/2zUUtCOh/  
kEUkZpQ7d8gie4jfl

yV4nV2g1u7oIbdnoBBI0a5bIwbUGDHPUvfTpoJntpryY7G/

QIWuBJVDiu6QteoB4u5byNVbSqA3fljbf

MISYfLxK3i3S07htadDfUIpYTyx/

D5PCf8DDxmdf7UkhOM4Quj8GgGW3PacE2YyJASBq5x7MaWEUiStu

NgtemWgR/DTw+OO8l3gZzHhWBcmHLzo3jdkH/

8ffLGEWqEb78wR4lxckVlja4suFB0GEa7vFLucYO3Tp

GzZARf7iy5A0bB0fi7ZiilyQ3RN7+di28lSNWsFCzZm8vWS7GyLUFn1xttlqJ

rsa fingerprint :

2048 SHA256:YVX+zlrDk8bqzF+HPKpFW0BttbLoiQ5IBDVI/VMYhbs

\*\*\*\*\*

\*\*\*\*\*

ecdsa public key :

ecdsa-sha2-nistp256 AAAAE2VjZHNhLXNoYTItbmlzdHAyNTYAAAAIbmlzdHAyNTYAAABBBBCN/  
XoG

uZGwNfKCE+cuQOULrSHomRSmkDp0u6MsoNIVLhtRe9+r8Ak7G8taE55D7NgunEDzdLKBmeCZWcw6  
4=

ecdsa fingerprint :

256 SHA256:T7KOGXyrU/38EvO6z/apgYDANf+q9YhqCiYoocD5Ajj

\*\*\*\*\*

\*\*\*\*\*

ed25519 public key :

ssh-ed25519 AAAAC3NzaC1lZDI1NTE5AAAII/jNFIYKbUk/ePbp4wu/  
AjhP5gERqn6F+4tH39idbh7

ed25519 fingerprint :

256 SHA256:1MU6iy03eEQBj099GERLjkMCPDoUwkdCwGh8bgYZbeo

\*\*\*\*\*

#



## show ssh server

Use this command to display the SSH server status.

### Command Syntax

```
show ssh server
```

### Parameters

None

### Command Mode

Exec mode

### Applicability

This command was introduced before OcNOS version 1.3.

### Examples

```
#show ssh server
VRF MANAGEMENT:
ssh server enabled port: 22
authentication-retries 3
VRF DEFAULT:
ssh server enabled port: 22
authentication-retries 3
#
```

---

## show username

Use this command to display the RSA or DSA key pair for a user.

### Command Syntax

```
show username USERNAME keypair
```

### Parameters

USERNAME	User identifier
----------	-----------------

### Command Mode

Exec mode

### Applicability

This command was introduced before OcNOS version 1.3.

### Examples

```
#show username OcNOS keypair
*****RSA KEY*****
ssh-rsa AAAAB3NzaC1yc2EAAAADAQABAAQDCnWo/3Y7LlVkw/Z43dbVIm+I3o25JlgUTmwa91l
T35+2gNvDbIPfYAqUKYgrmXKDC9vg7f4SasmXS+4ZwrrQSTTsHk8PNLA+4lEcufFNl3jpfXTuhphN9
N9
i+uFHGYIIviWZksiRqpMZmDlALyzAIOzyCfG44hlRm3/
pYfhBNhHruvxYVhbP4wHsmrWfcFb+HZCWQGM
CJupxu8bouGd2UW5/B1Vy1yuYNIhdo2NHjUI+ameETV+Wroki8+OLVA6eXp5/
KY3Bj9x2+AxOCiKcpU0
axwFSoCbP3+29wrp4JJh14ssSqM+19+VbUtpuXAM0cR7VQ7mJ0JDZ9tBvK4l8/
bitcount: 2048 fingerprint: 2b:ac:17:a4:ef:1d:79:4e:2d:17:af:72:4c:c7:e4:2f
*****
*****DSA KEY*****
ssh-dss AAAAB3NzaC1kc3MAAACBAP0npAm+Pw8t7OpO+KQ0Vx3ayXavHHVPPAKOo8RTmqUE8zUSjn
/XiZ+vP2343RpXu9/
jLwAcCUMfNBZyE8NbmGKxMMk2PqMz10VtFvDOn5LSNurXL4lypZLG2hR2PNva4w
6b4Adpd+ElfEoUncIgoUn2i4SO8N5TCMYVyusKjYzDAAAAFQCWeAzeahZeoIzBlNso87madxfL3QAA
AI
EA4b86l/
nHoWobRoYBrkeOGtjyWLRKk1P2T+rGH+j0rqQJiD0sh2PVfppylliNvqLtYSmXyMCxzEEeFd
HH1cVXgrgQjtUOeCPhF+2We2ummm1Cwg4v71Z358FRjsi9VgJ/vQUpOq1hRDhwjJHtEHSA+NkX/
ccW9J
ww8YOoNhCI7DcAAACANuYiP6tKGSU9LeClF1F65Tq1b1VHfLp3TSeZYPldqonDoZlqo3NNvOOH5KN8
Lj
MRtTCNlGaXowlQccs941XFy3efuWXxC00HZ64FhmjCyOYYv2Wsvn4UGCAG3ikiu6M1xjOLl6b53H4m
B3
w7O6bkcyjH1GnytWrgR0D/nlsZ/9fs=
bitcount: 1024 fingerprint: c1:0a:e5:e1:a1:78:ae:c2:4a:07:4a:50:07:4b:d5:84
*****
```

---

## ssh

Use this command to open an ssh session to a ipv4 address or host name resolved to an ipv4 address.

### Command Syntax

```
ssh WORD (vrf (NAME | management))
ssh WORD <1-65535> (vrf (NAME | management))
ssh (cipher (aes128-ctr | aes192-ctr | aes256-ctr | aes128-cbc | aes192-cbc | aes256-
  cbc | 3des-cbc)) WORD (vrf (NAME | management))
ssh (cipher (aes128-ctr | aes192-ctr | aes256-ctr | aes128-cbc | aes192-cbc |
  aes256-cbc | 3des-cbc)) WORD <1-65535> (vrf (NAME | management))
```

### Parameters

WORD	User and Destination Host name to resolve into IPV4 Address or IPv4 Address to open a ssh session as user@ipv4-address/Hostname
1-65535	Destination Port to open a ssh session. Default is 22
cipher	Specify algorithm to encrypt ssh session
aes128-ctr	Advanced Encryption Standard 128 bit Counter Mode
aes192-ctr	Advanced Encryption Standard 192 bit Counter Mode
aes256-ctr	Advanced Encryption Standard 256 bit Counter Mode
aes128-cbc	Advanced Encryption 128 bit Standard Cipher Block Chaining
aes192-cbc	Advanced Encryption Standard 192 bit Cipher Block Chaining
aes256-cbc	Advanced Encryption Standard 256 bit Cipher Block Chaining
3des-cbc	Triple Data Encryption Standard Cipher Block Chaining
vrf	Specify the VPN routing/forwarding instance.
NAME	Specify the name if the VPN routing/forwarding instance.
management	Management VPN routing/forwarding instance name.

### Default

By default, ssh WORD option is 22

### Command Mode

Privileged Exec mode

### Applicability

This command was introduced before OcnOS version 1.3.

### Examples

```
#ssh cipher aes128-ctr 10.12.16.17 22 vrf management
The authenticity of host '10.12.16.17 (10.12.16.17)' can't be established.
RSA key fingerprint is 93:82:98:ce:b7:20:1a:85:a5:9a:2e:93:13:84:ea:9e.
Are you sure you want to continue connecting (yes/no)?
```

## ssh6

Use this command to open an ssh session to an ipv6 address or host name resolved to an ipv6 address.

### Command Syntax

```
ssh6 (X:X::X:X | HOSTNAME) (vrf (NAME | management))
ssh6 (X:X::X:X | HOSTNAME) <1-65535> (vrf (NAME | management))
ssh6 (cipher (aes128-ctr | aes192-ctr | aes256-ctr | aes128-cbc | aes192-cbc |
aes256-cbc | 3des-cbc)) (X:X::X:X | HOSTNAME) (vrf (NAME | management))
ssh6 (cipher (aes128-ctr | aes192-ctr | aes256-ctr | aes128-cbc | aes192-cbc |
aes256-cbc | 3des-cbc)) (X:X::X:X | HOSTNAME) <1-65535> (vrf (NAME |
management))
```

### Parameters

X:XX::X:X	User and Destination IPv6 Address to open a ssh session as user@ipv6-address
HOSTNAME	User and Destination Host name to resolve into IPv6 Address to open an ssh session as user@ipv4-address/Hostname
1-65535	Destination Port to open a ssh session. Default is 22
cipher	Specify algorithm to encrypt ssh session
aes128-ctr	Advanced Encryption Standard 128 bit Counter Mode
aes192-ctr	Advanced Encryption Standard 192 bit Counter Mode
aes256-ctr	Advanced Encryption Standard 256 bit Counter Mode
aes128-cbc	Advanced Encryption 128 bit Standard Cipher Block Chaining
aes192-cbc	Advanced Encryption Standard 192 bit Cipher Block Chaining
aes256-cbc	Advanced Encryption Standard 256 bit Cipher Block Chaining
3des-cbc	Triple Data Encryption Standard Cipher Block Chaining
vrf	Specify the VPN routing/forwarding instance.
NAME	Specify the name if the VPN routing/forwarding instance.
management	Management VPN routing/forwarding instance name.

### Default

No default value is specified.

### Command Mode

Privileged Exec mode

### Applicability

This command was introduced before OcNOS version 1.3.

### Examples

```
#ssh6 cipher aes128-ctr 2:2::2:2 22 vrf management
The authenticity of host '2:2::2:2 (2:2::2:2)' can't be established.
RSA key fingerprint is 93:82:98:ce:b7:20:1a:85:a5:9a:2e:93:13:84:ea:9e.
```

Are you sure you want to continue connecting (yes/no)?

---

## ssh algorithm encryption

SSH server authorizes connection of only those algorithms that are configured from the list below. If a client tries establishing a connection to the server with the algorithm encryption that are not part of the list, the connection will not be established.

SSH server supports the encryption algorithms Advanced Encryption Standard Counter Mode [AES-CTR], Advanced Encryption Standard Cipher Block Chaining [AES-CBC], and Triple Data Encryption Standard [3DES].

and they are as follows:

1. aes128-ctr
2. aes192-ctr
3. aes256-ctr
4. aes128-cbc
5. 3des-cbc
6. aes192-cbc
7. aes256-cbc

Use this command to set an algorithm encryption to establish ssh session.

Use the `no` form of this command to remove an algorithm encryption.

### Command Syntax:

```
ssh server algorithm encryption {aes128-ctr | aes192-ctr | aes256-ctr | aes128-cbc
| aes192-cbc | aes256-cbc | 3des-cbc} (vrf management|)

no ssh server algorithm encryption {aes128-ctr | aes192-ctr | aes256-ctr | aes128-
cbc | aes192-cbc | aes256-cbc | 3des-cbc} (vrf management|)
```

### Parameters

<code>aes18-ctr</code>	AES 128 bit Counter Mode
<code>aes192-ctr</code>	AES 192 bit Counter Mode
<code>aes256-ctr</code>	AES 256 bit Counter Mode
<code>aes128-cbc</code>	AES 128 bit Cipher block chaining
<code>aes192-cbc</code>	AES 192 bit Cipher block chaining
<code>aes256-cbc</code>	AES 256 bit Cipher block chaining
<code>3des-cbc</code>	Triple DES Cipher block chaining
<code>vrf</code>	Virtual Routing and Forwarding
<code>NAME</code>	Virtual Routing and Forwarding name

### Default

No default value is specified.

By default, all the ciphers are supported for a new ssh client to connect to the ssh server.

**Command Mode**

Configure mode

**Applicability**

This command was introduced before OcNOS version 1.3.

**Examples**

```
#configure terminal  
(config)#ssh server algorithm encryption aes128-ctr
```

## ssh keygen host

Use these commands to create SSH server host, and public keys. These host keys are added in the SSH clients known\_hosts file after user's acceptance.

Once entry is added in known\_hosts, for the subsequent attempt login to the server will be validated against the host key and if there is key mismatch user will be prompted about the change in server identity.

### Command syntax

```
ssh keygen host dsa (vrf management|) (force|)
ssh keygen host rsa (length <1024-4096>|) (vrf management|) (force|)
ssh keygen host ecdsa (length (256|384|521)|) (vrf management|) (force|)
ssh keygen host ed25519 (vrf management|) (force|)
```

### Parameters

dsa	dsa keys
rsa	rsa keys
ecdsa	ecdsa keys
ed25519	ed25519 keys
management	Management VRF
force	Replace the old host-key with newly generated host-key
<1024-4096>	Number of bits to use when creating the SSH server key; this parameter is only valid for RSA keys (DSA keys have a default length of 1024)

### Default

DSA key has length of 1024 bits

RSA key has default length of 2048 bits

ECDSA key has default length of 521 bits

ED25519 key has length of 256 bits

### Command Mode

Privilege exec mode

### Applicability

This command was introduced in OcNOS version 5.0

### Examples

```
OcNOS#ssh keygen host rsa vrf management
OcNOS#
OcNOS#ssh keygen host ecdsa vrf management
OcNOS#
OcNOS#ssh keygen host ecdsa
%% ssh host key exists, use force option to overwrite
OcNOS#
OcNOS#ssh keygen host ecdsa force
```



OcNOS#

---

## ssh login-attempts

Use this command to set the number of times SSH client would try to authenticate to establish the SSH session.

Use the `no` form of this command to set the number of authentication attempts to its default (3).

**Note:** By default, SSH clients may send the keys to authenticate, such a implicit authentication failures would also decrease authentication attempt count. Hence the configured value is not directly proportional to the user's password based authentication attempt.

### Command Syntax

```
ssh login-attempts <1-3> (vrf management|)
no ssh login-attempts (vrf management|)
```

### Parameters

<1-3>	Retries attempts, default is 3 attempts
management	Virtual Routing and Forwarding name

### Default

By default, the device attempts to negotiate a connection with the connecting host three times.

### Command Mode

Configure mode

### Applicability

This command was introduced before OcNOS version 1.3.

### Examples

```
#configure terminal
(config)#ssh login-attempts 3
```

---

## ssh server port

Use this command to set the port number on which the SSH server listens for connections. The default port on which the SSH server listens is 22.

Use the `no` form of this command to set the default port number (22).

### Command Syntax

```
ssh server port <1024-65535> (vrf management|)
no ssh server port (vrf management|)
```

### Parameters

<1024-65535>	Port number
management	Virtual Routing and Forwarding name

### Default

By default, SSH server port is 22.

### Command Mode

Configure mode

### Applicability

This command was introduced before OcnOS version 1.3.

### Examples

```
#configure terminal
(config)#ssh server port 1720
```

---

## ssh server session-limit

Use this command to limit number of SSH sessions. Only 40 sessions allowed including Telnet and SSH.

Use `no` form of this command to set to default value.

Note: Few Terminal application (Ex: MobaXterm) where user run SSH Client has limits to use this SSH session limit option.

### Command Syntax

```
ssh server session-limit <1-40> (vrf management|)
no ssh server session-limit (vrf management|)
```

### Parameters

<1-40>	Number of sessions
management	Virtual Routing and Forwarding name

### Default

By default, 40 sessions are allowed.

### Command Mode

Configure mode

### Applicability

This command was introduced in OcNOS version 4.2

### Examples

```
#configure terminal
(config)#ssh server session-limit 4 vrf management
```

---

## username sshkey

Use this command to add public key of the ssh clients to perform password-less login into the switch.

### Command Syntax

```
username USERNAME sshkey LINE
```

### Parameters

USERNAME	User identifier
LINE	Digital System Algorithm (DSA) key or Rivest, Shamir, and Adelman (RSA) key in OpenSSH format; this key is written to the <code>authorized_keys</code> file

### Default

By default, SSHKEY is 1024.

### Command Mode

Configure mode

### Applicability

This command was introduced before OcNOS version 1.3.

### Examples

```
#configure terminal
(config)#username fred
(config)#username fred sshkey
ssh-rsa AAAAB3NzaC1kc3MAAAEBAIirweZzCdyITqbmMWB8Wly9ivGxY1JBVnWTVtcWki6uc
CPZyw3I6J6/+69LEkPUSAYo+SK8zj0NF2f25FFc2YDMh1KKHi5gK7iXF3/ran54j
nP2byyLeo8rnuVqfEDLaBI1qQaWBcDQvsZc14t5SEJfsOQSfR03PDqPYAisrZRvM
5pWfzo486Rh33J3+17OuARQtZFDp4wA5zZoFxl4U3RK42JzKNUiYBDrH3lSgfkv
XLWLXz9WcxY6zuKvXFWUpOA9PRXwUsKQqWuyyWZQLNavENqFyoQ8oZnNKLcYE0h8
QnUe62NGxb3jQXKLf1OL04JFNiii9sACG1Y/ut4ANysAAAAVAJbM7Z4chRgiVahN
iwXFJNkBmWGZAAABAAuF1FlI6xy0L/pBaIlFw34uUL/mh4SR2Di2X52eK70VNj+m
y5eQdRC6cxpaVqps3Q4xTN+W/kaBbIlX40xJP51cjMvfn/nqiuIeEodmVIJMWxOD
fh3egeGuSW614Vzd1RGrxpYInIOygMULRcxhmbX+rPliuUIvhg36iH0UR7XBln6h
uyKFvEmaL7bGlRvELjqaj0y6iiCfPlyGbc5vavH5X+jOWqdsJHsCgcIzPF5D1Ybp
w0nZmGsqO+P55mjMuj002uI7NslsxyirbnGhd+ZZ1u03QDy6MbcUspai8U5Cie6X
WqvXY+yJjpuv1W9GTHowCcGd6Z/e9IC6VE/kNEAAAAEAFie6kLGTALR0F3AfapYY
/M+bvkmkkhOJUzVdLiwMjcvTJb9fQpPxqXELs3ZvUNIEELUPS/V7KgSsj8eg3FKN
iUGICkTwHIK7RTLc8k4IE6U3V3866JtxW+Znv1DB7uwnbZgoIZuVt3r1+h800ah8
UKwDUMJT0fWu9cuuS3G8Ss/gKi1HgByrcxXoK51/r4Bc4QmR2VQ8sXOREv/SHJeY
JGbEX30xjRgXC7GlPbrdPiL8zs0dPiZ0ovAswsBOYlKYhd7JvfCcvWRjgP5h55aw
GNSmNs3STKufbIqYGeDAISYNY4F2JzR593KIBnWgyhokyYybyEBh8NwTTO4J5rT
ZA==
```

---

## username keypair

Use this command to generate the key for users.

### Command Syntax

```
username USERNAME keypair rsa
username USERNAME keypair dsa
username USERNAME keypair rsa length <1024-4096>
username USERNAME keypair rsa length <1024-4096> force
username USERNAME keypair rsa force
username USERNAME keypair dsa force
```

### Parameters

USERNAME	User identifier
rsa	Rivest, Shamir, and Adelman (RSA) public-key cryptography SSH server key
dsa	Digital System Algorithm (DSA) SSH key
<1024-4096>	Number of bits to use when creating the SSH server key; this parameter is only valid for RSA keys (DSA keys have a default length of 1024)
force	Forces the replacement of an SSH key

### Default

DSA keys have a default value of 1024.

RSA keys have a minimum key length of 1024 bits and the default length is 4096.

By default the system has RSA/DSA public/private key pair placed in /etc/ssh/. The force option is used if the user wants to regenerate the ssh rsa keys. The same thing applies for dsa also.

### Command Mode

Execute mode

### Applicability

This command was introduced before OcnOS version 1.3.

### Examples

```
#configure terminal
(config)#username fred keypair rsa
```

---

## CHAPTER 14 Network Time Protocol

---

This chapter is a reference for Network Time Protocol (NTP) commands.

NTP synchronizes clocks between computer systems over packet-switched networks. NTP can synchronize all participating computers to within a few milliseconds of Coordinated Universal Time (UTC).

NTP uses a hierarchical, layered system of time sources. Each level of this hierarchy is called a “stratum” and is assigned a number starting with zero at the top. The number represents the distance from the reference clock and is used to prevent cyclical dependencies in the hierarchy.

Note: The default time-to-live value for the unicast packets is 64.

This chapter contains these commands:

- `clear ntp statistics`
- `debug ntp`
- `feature ntp`
- `ntp acl`
- `ntp authenticate`
- `ntp authentication-key`
- `ntp enable`
- `ntp discard`
- `ntp logging`
- `ntp master`
- `ntp master stratum`
- `ntp peer`
- `ntp request-key`
- `ntp server`
- `ntp sync-retry`
- `ntp trusted-key`
- `show ntp authentication-keys`
- `show ntp authentication-status`
- `show ntp logging-status`
- `show ntp peer-status`
- `show ntp peers`
- `show ntp statistics`
- `show ntp trusted-keys`
- `show running-config ntp`

---

## clear ntp statistics

Use this command to reset NTP statistics.

### Command Syntax

```
clear ntp statistics (all-peers | io | local | memory)
```

### Parameters

all-peers	Counters associated with all peers
io	Counters maintained in the input-output module
local	Counters maintained in the local protocol module
memory	Counters related to memory allocation

### Command Mode

Exec mode and Privileged Exec mode

### Applicability

This command was introduced before OcnOS version 1.3.

### Example

```
#clear ntp statistics all-peers
```



---

## debug ntp

Use this command to display NTP debugging messages.

Use the `no` form of this command to stop displaying NTP debugging messages.

### Command Syntax

```
debug ntp
no debug ntp
```

### Parameters

None

### Command Mode

Exec mode and Configure mode

### Applicability

This command was introduced before OcNOS version 1.3.

### Examples

```
#configure terminal
(config)#debug ntp

(config)#no debug ntp
```

---

## feature ntp

Use this command to enable to NTP feature.

Use the `no` form of this command to disable NTP feature and delete all the NTP related configurations.

### Command Syntax

```
feature ntp (vrf management|)
no feature ntp (vrf management|)
```

### Parameters

management      Virtual Routing and Forwarding name

### Default

By default, feature ntp is enabled.

### Command Mode

Configure mode

### Applicability

This command was introduced before OcNOS version 1.3.

### Examples

```
#configure terminal
(config)#feature ntp vrf management

(config)#no feature ntp vrf management
```

---

## ntp acl

Use this command to allow particular client to communicate with NTP server.

Use the `no` form of this command to remove the particular client from NTP server.

Note: `ntp discard` option and limited rate flag are required for sending the KOD packet.

### Command Syntax

```
ntp allow (A.B.C.D | X:X::X:X) (mask (A.B.C.D| <1-128>|))
({nopeer|noserve|noquery|nomodify|kod|limited|notrap|}) (vrf management|)
no ntp allow (A.B.C.D | X:X::X:X) (mask (A.B.C.D| <1-128>|))
({nopeer|noserve|noquery|nomodify|kod|limited|notrap|}) (vrf management|)
```

### Parameters

A.B.C.D	IPv4 address of the client
X:X::X:X	IPv6 address of the client
A.B.C.D	Mask for the IPv4 address
1-128	Mask for the IPv6 address
nopeer	Prevent the client from establishing a peer association
noserve	Prevent the client from performing time queries
noquery	Prevent the client from performing NTPq and NTPdc queries, but not time queries
nomodify	Restrict the client from making any changes to the NTP configurations
kod	Send a kiss-of-death packet if the client limit has exceeded
limited	Deny time service if the packet violates the rate limits established by the discard command
notrap	Prevent the client from configuring control message traps
vrf	Virtual Router and Forwarding
management	Virtual Routing and Forwarding name

### Default

By default, only local host is permitted.

### Command Mode

Configure mode

### Applicability

This command is introduced in OcNOS version 4.1.

### Example

```
#configure terminal
(config)#ntp allow 1.1.1.1 mask 255.255.255.0 nopeer kod notrap noserve vrf
management
```

---

## ntp authenticate

Use this command to enable NTP authentication.

Use the `no` form of this command to disable authentication.

### Command Syntax

```
ntp authenticate (vrf management|)
no ntp authenticate (vrf management|)
```

### Parameters

management      Virtual Routing and Forwarding name

### Default

By default, `ntp authenticate` is disabled

### Command Mode

Configure mode

### Applicability

This command was introduced before OcNOS version 1.3.

### Example

```
#configure terminal
(config)#ntp authenticate vrf management
```

---

## ntp authentication-key

Use this command to set an NTP Message Digest Algorithm 5 (MD5) authentication key.

Use the `no` form of this command to delete an authentication key.

### Command Syntax

```
ntp authentication-key <1-65534> md5 WORD (vrf management|)
ntp authentication-key <1-65534> md5 WORD 7 (vrf management|)
no ntp authentication-key <1-65534> md5 WORD (vrf management|)
```

### Parameters

<1-65534>	Authentication key number
WORD	MD5 string (maximum 8 characters)
7	Encrypt using weak algorithm
management	Virtual Routing and Forwarding name

### Default

No default value is specified

### Command Mode

Configure mode

### Applicability

This command was introduced before OcNOS version 1.3.

### Example

```
#configure terminal
(config)#ntp authentication-key 535 md5 J@u-b;12 vrf management
```

---

## ntp enable

Use this command to enable NTP feature and start the NTP service.

Use the `no` form of this command to stop the NTP service.

### Command Syntax

```
ntp enable (vrf management|)
no ntp enable (vrf management|)
```

### Parameters

management      Virtual Routing and Forwarding name

### Default

By default, ntp is enabled.

### Command Mode

Configure mode

### Applicability

This command was introduced before OcNOS version 1.3.

### Example

```
#configure terminal
(config)#ntp enable vrf management
```

---

## ntp discard

Use this command to enable rate limiting access to the NTP service running on a system.

Use the no form of this command to disable rate limiting access to the NTP service running on a system.

This NTP discard option and limited rate flag are required for sending the KOD packet. KOD (Kiss of Death) packets have the leap bits set unsynchronized and stratum set to zero and the reference identifier field set to a four-byte ASCII code. If the noserve or notrust flag of the matching restrict list entry is set, the code is "DENY"; if the limited flag is set and the rate limit is exceeded, the code is "RATE".

### Command Syntax

```
ntp discard minimum <1-65535> (vrf management|)
no ntp discard minimum (vrf management|)
```

### Parameters

minimum	Specify the minimum interpacket spacing <default 2>
<0-65535>	Minimum value

### Default

By default, the minimum value is 2.

### Command Mode

Configure mode

### Applicability

This command is introduced in OcNOS version 4.2.

### Example

```
#configure terminal
(config)#ntp discard minimum 50 vrf management
```

---

## ntp logging

Use this command to log NTP events.

Use the `no` form of this command to disable NTP logging.

### Command Syntax

```
ntp logging (vrf management|)
no ntp logging (vrf management|)
```

### Parameters

management      Virtual Routing and Forwarding name

### Default

By default, ntp logging message is disabled

### Command Mode

Configure mode

### Applicability

This command was introduced before OcNOS version 1.3.

### Example

```
#configure terminal
(config)#ntp logging vrf management
```



---

## ntp master

Use this command to run a device as an NTP server.

Use the `no` command to disable the NTP server.

### Command Syntax

```
ntp master (vrf management|)
no ntp master (vrf management|)
```

### Parameters

<code>vrf</code>	Virtual Router and Forwarding
<code>management</code>	Virtual Routing and Forwarding name

### Default

By default, NTP master is disabled

### Command Mode

Configure mode

### Applicability

This command is introduced in OcNOS version 4.1.

### Example

```
#configure terminal
(config)#ntp master vrf management
```

---

## ntp master stratum

Use this command to set stratum value for NTP server.

Use the `no` command to remove stratum value.

The NTP Stratum model is a representation of the hierarchy of time servers in an NTP network, where the Stratum level (0-15) indicates the device's distance to the reference clock.

### Command Syntax

```
ntp master stratum <1-15> (vrf management|)
no ntp master stratum (vrf management|)
```

### Parameters

<1-15>	Stratum value for NTP server
vrf	Virtual Router and Forwarding
management	Virtual Routing and Forwarding name

### Default

By default, NTP startum value is 16.

### Command Mode

Configure mode

### Applicability

This command is introduced in OcNOS version 4.1.

### Example

```
#configure terminal
(config)#ntp master stratum 2 vrf management
```

---

## ntp peer

Use this command to configure a peer association. In a peer association, this system can synchronize with the other system or the other system can synchronize with this system.

Use the `no` command to remove a peer association.

### Command Syntax

```
ntp peer (A.B.C.D | HOSTNAME) ({prefer|key <1-65534>|minpoll <4-16>|maxpoll <4-16>}) (vrf management|)
ntp peer (A.B.C.D | X:X::X:X | HOSTNAME) ({prefer|key <1-65534>|minpoll <4-16>|maxpoll <4-16>}) (vrf management|)
no ntp peer (A.B.C.D | HOSTNAME) ({prefer|key <1-65534>|minpoll <4-16>|maxpoll <4-16>}) (vrf management|)
no ntp peer (A.B.C.D | HOSTNAME) ({prefer|key|minpoll|maxpoll}) (vrf management|)
no ntp peer (A.B.C.D | X:X::X:X | HOSTNAME) ({prefer|key <1-65534>|minpoll <4-16>|maxpoll <4-16>}) (vrf management|)
no ntp peer (A.B.C.D | X:X::X:X | HOSTNAME) ({prefer|key|minpoll|maxpoll}) (vrf management|)
```

### Parameters

A.B.C.D	IPv4 address of peer
HOSTNAME	Host name of peer
X:X::X:X	IPv6 address of peer
prefer	Prefer this peer; preferred peer responses are discarded only if they vary dramatically from other time sources
key	Peer authentication key
<1-65534>	Peer authentication key value
minpoll	Minimum poll interval
<4-16>	Minimum poll interval value in seconds raised to a power of 2 (default 4 = 16 seconds)
maxpoll	Maximum poll interval
<4-16>	Maximum poll interval value in seconds raised to a power of 2 (default 6 = 64 seconds)
management	Virtual Routing and Forwarding name

### Default

By default, value of `minpoll` is 4 and `maxpoll` is 6.

### Command Mode

Configure mode

### Applicability

This command was introduced before OcnOS version 1.3.

## Examples

```
#configure terminal
(config)#ntp peer 10.10.0.23 vrf management
(config)#ntp peer 10.10.0.23 prefer key 12345 vrf management

(config)#no ntp peer 10.10.0.23 vrf management
```

---

## ntp request-key

Use this command to define NTP request-key which is used by the NTPDC utility program. NTP client should be able to modify NTP server configuration by using this request-key. Request key must be a trusted key.

Use `no` form of this command to remove a request key.

### Command Syntax

```
ntp request-key <1-65534> (vrf management|)
no ntp request-key <1-65534> (vrf management|)
```

### Parameter

<1-65534>	Request key number
vrf management	Virtual Routing and Forwarding name

### Default

No default value

### Command Mode

Configure mode

### Applicability

This command is introduced in OcNOS version 5.1 MR.

### Example

```
#configure terminal
(config)#ntp request-key 123 vrf management
```

## ntp server

Use this command to configure an NTP server so that this system synchronizes with the server, but not vice versa.

Use the `no` option with this command to remove an NTP server.

### Command Syntax

```
ntp server (A.B.C.D | HOSTNAME) ({prefer|key <1-65534>|minpoll <4-16>|maxpoll <4-16>}) (vrf management|)
ntp server (A.B.C.D | X:X::X:X | HOSTNAME) ({prefer|key <1-65534>|minpoll <4-16>|maxpoll <4-16>}) (vrf management|)
no ntp server (A.B.C.D | HOSTNAME) ({prefer|key <1-65534>|minpoll <4-16>|maxpoll <4-16>}) (vrf management|)
no ntp server (A.B.C.D | HOSTNAME) ({prefer|key|minpoll|maxpoll}) (vrf management|)
no ntp server (A.B.C.D | X:X::X:X | HOSTNAME) ({prefer|key <1-65534>|minpoll <4-16>|maxpoll <4-16>}) (vrf management|)
no ntp server (A.B.C.D | HOSTNAME) ({prefer|key|minpoll|maxpoll}) (vrf management|)
```

### Parameters

A.B.C.D	IPv4 address of the server
HOSTNAME	Host name of the server
X:X::X:X	IPv6 address of the server
prefer	Prefer this server; preferred server responses are discarded only if they vary dramatically from other time sources
key	Server authentication key
<1-65534>	Server authentication key
minpoll	Minimum poll interval
<4-16>	Minimum poll interval value in seconds raised to a power of 2 (default 4 = 16 seconds)
maxpoll	Maximum poll interval
<4-16>	Maximum poll interval value in seconds raised to a power of 2 (default 6 = 64 seconds)
management	Virtual Routing and Forwarding name

### Default

By default, `minpoll` is 4 and `maxpoll` is 6.

### Command Mode

Configure mode

### Applicability

This command was introduced before OcnOS version 1.3.

**Examples**

```
#configure terminal
(config)#ntp server 10.10.0.23 vrf management
(config)#ntp server 10.10.0.23 prefer key 12345 vrf management

(config)#no ntp server 10.10.0.23 vrf management
```

---

## ntp sync-retry

Use this command to retry NTP synchronization with configured servers.

### Command Syntax

```
ntp sync-retry (vrf management|)
```

### Parameters

management      Virtual Routing and Forwarding name

### Default

No default value is specified

### Command Mode

Exec mode

### Applicability

This command was introduced before OcNOS version 1.3.

### Example

```
#ntp sync-retry vrf management
```



## ntp trusted-key

Use this command to define a “trusted” authentication key. If a key is trusted, the device will synchronize with a system that specifies this key in its NTP packets.

Use the `no` option with this command to remove a trusted key.

### Command Syntax

```
ntp trusted-key <1-65534> (vrf management|)
no ntp trusted-key <1-65534> (vrf management|)
```

### Parameter

<1-65534>	Authentication key number
management	Virtual Routing and Forwarding name

### Default

By default, `ntp trusted-key` is disabled

### Command Mode

Configure mode

### Applicability

This command was introduced before OcnOS version 1.3.

### Example

```
#configure terminal
(config)#ntp trusted-key 234676 vrf management
```

---

## show ntp authentication-keys

Use this command to display authentication keys.

### Command Syntax

```
show ntp authentication-keys
```

### Parameters

None

### Command Mode

Exec mode and Privileged Exec mode

### Applicability

This command was introduced before OcNOS version 1.3.

### Example

```
#sh ntp authentication-keys
-----
Auth Key          MD5 String
-----
123                0xa2cb891442844220
#
```

[Table 14-23](#) explains the output fields.

**Table 14-23: show ntp authentication-key fields**

Entry	Description
Auth key	Authentication key (password). Use the password to verify the authenticity of packets sent from this interface or peer interface.
MD5 String	One or more MD5 key strings. The MD5 key values can be from 1 through 16 characters long. You can specify more than one key value within the list.

---

## show ntp authentication-status

Use this command to display whether authentication is enabled or disabled.

### Command Syntax

```
show ntp authentication-status
```

### Parameters

None

### Command Mode

Exec mode and Privileged Exec mode

### Applicability

This command was introduced before OcNOS version 1.3.

### Example

```
#show ntp authentication-status  
Authentication enabled
```

---

## show ntp logging-status

Use this command to display the NTP logging status.

### Command Syntax

```
show ntp logging-status
```

### Parameters

None

### Command Mode

Exec mode and Privileged Exec mode

### Applicability

This command was introduced before OcNOS version 1.3.

### Example

```
#show ntp logging-status  
NTP logging enabled
```

## show ntp peer-status

Use this command to display the peers for which the server is maintaining state along with a summary of that state.

### Command Syntax

```
show ntp peer-status
```

### Parameters

None

### Command Mode

Exec mode and Privileged Exec mode

### Applicability

This command was introduced before OcNOS version 1.3.

### Example

```
#sh ntp peer-status
Total peers : 1
* - selected for sync, + - peer mode(active),
- - peer mode(passive), = - polled in client mode,
x - source false ticker
      remote          refid          st t when poll reach  delay  offset  jitter
=====
*216.239.35.4      .GOOG.          1 u  24  64  377  38.485  0.149  0.053
#
```

Table 14-24 explains the output fields.

**Table 14-24: show ntp peer-status fields**

Entry	Description
Total peers	Number of servers and peers configured.
* - selected for sync, + - peer mode (active), - - peer mode (passive), = - polled in client mode x - source false ticker	Fate of this peer in the clock selection process.
Remote	Address of the remote peer.
refid	Reference ID (0.0.0.0 for an unknown reference ID).
st	The stratum of the remote peer (a stratum of 16 indicated remote peer is unsynchronized).
t	Type of peer (local, unicast, multicast and broadcast).
when	Time the last packet was received.

**Table 14-24: show ntp peer-status fields**

<b>Entry</b>	<b>Description</b>
poll	The polling interval (seconds).
reach	The reachability register (octal).
delay	Current estimated delay in seconds.
offset	Current estimated offset in seconds.
jitter	Current dispersion of the peer in seconds.

---

## show ntp peers

Use this command to display NTP peers.

### Command Syntax

```
show ntp peers
```

### Parameters

None

### Command Mode

Exec mode and Privileged Exec mode

### Applicability

This command was introduced before OcNOS version 1.3.

### Example

```
#show ntp peers
-----
Peer IP Address                               Serv/Peer
-----
216.239.35.4                                 Server (configured)
```

[Table 14-25](#) explains the output fields.

**Table 14-25: show ntp peers fields**

Entry	Description
Peer IP Address	Address of the neighbor protocol.
Serv/Peer	List of NTP peers and servers configured or dynamically learned.

---

## show ntp statistics

Use this command to display NTP statistics.

### Command Syntax

```
show ntp statistics (io | local | memory | peer ( ipaddr (A.B.C.D | X:X::X:X ) |
name (HOSTNAME)) )
```

### Parameters

io	Counters maintained in the input-output module
local	Counters maintained in the local protocol module
memory	Counters related to memory allocation
peer	Counters associated with the specified peer
A.B.C.D	Peer IPv4 address
X:X::X:X	Peer IPv6 address
HOSTNAME	Peer host name

### Command Mode

Exec mode and Privileged Exec mode

### Applicability

This command was introduced before OcNOS version 1.3.

### Example

```
#show ntp statistics local
time since restart:    1685
time since reset:     1685
packets received:     4
packets processed:    0
current version:      0
previous version:     0
declined:             0
access denied:        0
bad length or format: 0
bad authentication:   0
rate exceeded:        0
#show ntp statistics memory
time since reset:     1698
total peer memory:    15
free peer memory:     15
calls to findpeer:    0
new peer allocations: 0
peer demobilizations: 0
hash table counts:   0 0 0 0 0 0 0 0
                    0 0 0 0 0 0 0 0
                    0 0 0 0 0 0 0 0
                    0 0 0 0 0 0 0 0
                    0 0 0 0 0 0 0 0
                    0 0 0 0 0 0 0 0
```



Table 14-26 explains the output fields.

**Table 14-26: show ntp statisticsfields**

<b>Entry</b>	<b>Description</b>
Time since restart	Time when the ntp protocols were last started and how long they have been running.
Time since reset	Time when the ntp protocols were last reset and how long they have been running.
Packets received	Number of packets received from the peers.
Packets processed	Number of packets processed to the peers.
Current version	Current version of the protocol that is being used.
Previous version	Previous version of the protocol that has been used.
Declined	Access to the protocol declined
Access denied	Number of attempts denied to access protocol
Bad length or format	Number of messages received with length or format errors so severe that further classification could not occur.
Bad authentication	Number of messages received with incorrect authentication.
Rate exceeded	Exceed the configured rate if additional bandwidth is available from other queues
Total peer memory	Actual memory available to the peer system.
Free peer memory	Free memory available to the peer system.
Calls to find peer	Number of calls to find peer.
New peer allocations	Number of allocations from the free peer list.
Peer demobilizations	Number of structures freed to free peer list.
Hash table counts	Peer hash table's each bucket count.

---

## show ntp trusted-keys

Use this command to display keys that are valid for authentication.

### Command Syntax

```
show ntp trusted-keys
```

### Parameters

None

### Command Mode

Exec mode and Privileged Exec mode

### Applicability

This command was introduced before OcNOS version 1.3.

### Example

```
#show ntp trusted-keys

Trusted Keys:
333
#
```

[Table 14-27](#) explains the output fields.

**Table 14-27: show ntp trusted-keys fields**

Entry	Description
Trusted Keys	Keys that are valid for authentication.

---

## show running-config ntp

Use this command to display the NTP running configuration.

### Command Syntax

```
show running-config ntp (|all)
```

### Parameters

<code>all</code>	Reserved for future use
------------------	-------------------------

### Command Mode

Exec mode and Privileged Exec mode

### Applicability

This command was introduced before OcnOS version 1.3.

### Example

```
#sh running-config ntp
feature ntp vrf management
ntp enable vrf management
ntp authenticate vrf management
ntp logging vrf management
ntp authentication-key 123 md5 0xa2cb891442844220 7 vrf management
ntp trusted-key 123 vrf management
ntp server 216.239.35.4 vrf management
```



---

## CHAPTER 15 TACACS+ Commands

---

Terminal Access Controller Access-Control System Plus (TACACS+, usually pronounced like tack-axe) is an access control network protocol for network devices.

The differences between RADIUS and TACACS+ can be summarized as follows:

- RADIUS combines authentication and authorization in a user profile, while TACACS+ provides separate authentication.
- RADIUS encrypts only the password in the access-request packet sent from the client to the server. The remainder of the packet is unencrypted. TACACS+ encrypts the entire body of the packet but leaves a standard TACACS+ header.
- RADIUS uses UDP, while TACACS+ uses TCP.
- RADIUS is based on an open standard (RFC 2865). TACACS+ is proprietary to Cisco, although it is an open, publicly documented protocol (there is no RFC protocol specification for TACACS+).

Note: Only network administrators can execute these commands. For more, see the [username](#) command.

Note: The commands below are supported only on the “management” VRF.

This chapter contains these commands:

- [clear tacacs-server counters](#)
- [debug tacacs+](#)
- [feature tacacs+](#)
- [show debug tacacs+](#)
- [show running-config tacacs+](#)
- [show tacacs-server](#)
- [tacacs-server login host](#)
- [tacacs-server login key](#)
- [tacacs-server login timeout](#)

---

## clear tacacs-server counters

Use this command to clear the counter on a specified TACACS server.

### Syntax

```
clear tacacs-server ((HOSTNAME | X:X::X:X | A.B.C.D)|) counters (vrf (management | all)|)
```

### Parameters

HOSTNAME	The name of the server
X:X::X:X	IPv6 address of the server
A.B.C.D	IPv4 address of the server
vrf	VRF of the sever
management	The management VRF
all	All VRFs

### Default

NA

### Command Mode

Executive mode

### Applicability

This command was introduced before OcNOS version 1.3.

### Example

```
#clear tacacs-server 10.1.1.1 counters
```

---

## debug tacacs+

Use this command to display TACACS+ debugging information.

Use the `no` form of this command stop displaying TACACS+ debugging information.

### Command Syntax

```
debug tacacs+
no debug tacacs+
```

### Parameters

None

### Default

Disabled

### Command Mode

Executive mode and configure mode

### Applicability

This command was introduced before OcNOS version 1.3.

### Examples

```
#debug tacacs+
```

---

## feature tacacs+

Use this command to enable the TACACS+ feature.

Use the `no` form of this command to disable the TACACS+ feature.

### Command Syntax

```
feature tacacs+ (vrf management|)
no feature tacacs+ (vrf management|)
```

### Parameters

<code>vrf</code>	Virtual Routing and Forwarding
<code>management</code>	Management VRF

### Default

By default, `feature tacacs+` is disabled

### Command Mode

Configure mode

### Applicability

This command was introduced before OcnOS version 1.3.

### Examples

```
#configure terminal
(config)#feature tacacs+ vrf management
```



---

## show debug tacacs+

Use this command to display whether TACACS+ debugging is enabled.

### Command Syntax

```
show debug tacacs+
```

### Parameters

None

### Command Mode

Exec mode

### Applicability

This command was introduced before OcNOS version 1.3.

### Examples

```
#show debug tacacs+
TACACS client debugging is on
```

---

## show running-config tacacs+

Use this command to display TACACS+ settings in the running configuration.

### Command Syntax

```
show running-config tacacs+
```

### Parameters

None

### Command Mode

Exec mode

### Applicability

This command was introduced before OcNOS version 1.3.

### Examples

```
#sh running-config tacacs+
feature tacacs+ vrf management
tacacs-server login host 10.16.19.2 vrf management seq-num 1 key 7
0x9f4a8983e02
16052
```

[Table 15-28](#) explains the output fields.

**Table 15-28: show running-config fields**

Entry	Description
TACAS server host	TACACS+ server Domain Name Server (DNS) name.
Seq-num	Sequence number of user authentication attempt with the TACACS+ server.
VRF Management	The management traffic using VPN Routing and Forwarding (VRFs).

---

## show tacacs-server

Use this command to display the TACACS+ server configuration.

### Command Syntax

```
show tacacs-server (|vrf (management|all)) ((WORD) |(groups (GROUP|)|)| (sorted))
```

### Parameters

WORD	DNS host name or IP address
groups	TACACS+ server group
GROUP	Group name; if this parameter is not specified, display all groups
sorted	Sort by TACACS+ server name
vrf	management or all VRFs

### Command Mode

Executive mode

### Applicability

This command was introduced before OcNOS version 1.3.

### Examples

```
#show tacacs-server
total number of servers:1

Tacacs+ Server           : 192.168.10.215/49 (*)
  Sequence Number       : 1
  Failed Auth Attempts  : 0
  Success Auth Attempts : 14
  Failed Connect Attempts : 0
  Last Successful authentication: 2017 December 18, 12:27:13
```

(\*) indicates last active.

[Table 15-29](#) explains the output fields.

**Table 15-29: show tacacs-server output fields**

Field	Description
Sequence Number	Sequence number of user authentication attempt with the TACACS+ server.
Failed Auth Attempts	Number of times user authentication failed with the TACACS+ server. Increments for server key mismatches and password mismatches or wrong password for the user.
Success Auth Attempts	Number of times user authenticated with TACACS+ server. Increments for each successful login.

**Table 15-29: show tacacs-server output fields**

Field	Description
Failed Connect Attempts	Number of failed TCP socket connections to the TACACS+ server. Increments for server connection failure cases such as server not-reachable, server port mismatches.
Last Successful authentication	Timestamp when user successfully authenticated with the TACACS+ server.

---

## tacacs-server login host

Use this command to set the TACACS+ server host name or IP address.

Use the `no` form of this command to remove an TACACS+ server (if only a host name or IP address is specified as a parameter) or to remove all of a TACACS+ server's configuration settings (if any other parameters are also specified).

### Command Syntax

```
tacacs-server login host (HOSTNAME | X:X::X:X | A.B.C.D) (vrf management|) (seq-num
  <1-8> |) (key ((0 WORD) | (7 WORD) )) (port <1025-65535> |) (timeout <1-60>|)
tacacs-server login host (A.B.C.D|X:X::X:X|HOSTNAME) (vrf management|) seq-num <1-
  8> key (0|7) WORD port <1025-65535> timeout <1-60>
no tacacs-server login host (A.B.C.D|X:X::X:X|HOSTNAME) (vrf management|) seq-num
  <1-8> key (0|7) WORD port <1025-65535> timeout <1-60>
```

### Parameters

HOSTNAME	Host name
X:X::X:X	IPv6 address
A.B.C.D	IPv4 address
vrf management	Virtual Routing and Forwarding Management VRF
seq-num	Sequence Number / Priority index for tacacs-servers
key	Authentication and encryption key ("shared secret")
0	Unencrypted (clear text) shared key
WORD	Unencrypted key value; maximum length 63 characters
7	Hidden shared key
WORD	Hidden key value; maximum length 512 characters
port	TACACS+ server port
<1205-65535>	TACACS+ server port number; the default is 49
timeout	TACACS+ server timeout
<1-60>	Timeout value in seconds; default is 5 seconds

### Default

Enable authentication for TACACS+ server configured. Authorization is also enabled by default. The default server port is 49.

There is no command to enable authorization. Authorization functionality is enabled by default when remote authentication is enabled with TACACS+.

### Command Mode

Configure mode

### Applicability

This command was introduced before OcNOS version 1.3.

### Examples

```
#configure terminal  
(config)#tacacs-server login host 203.0.113.31 vrf management seq-num 3
```

---

## tacacs-server login key

Use this command to set a global preshared key (“shared secret”) which is a text string shared between the device and TACACS+ servers.

Use the `no` form of this command to remove a global preshared key.

### Command Syntax

```
tacacs-server login key ((0 WORD) | (7 WORD)) (vrf management|)
no tacacs-server login key ((0 WORD) | (7 WORD) ) (vrf management|)
```

### Parameters

0	Unencrypted (clear text) shared key
WORD	Unencrypted key value; maximum length 63 characters
7	Hidden shared key
WORD	Hidden key value; maximum length 512 characters
vrf	Virtual Routing and Forwarding
management	Management VRF

### Default

Disabled

### Command Mode

Configure mode

### Applicability

This command was introduced before OcNOS version 1.3.

### Examples

```
#configure terminal
(config)#tacacs-server login key 7 jvn05mlQH1 vrf management
```

---

## tacacs-server login timeout

Use this command to set the period to wait for a response from the server before the client declares a timeout failure. The default timeout value is 5 seconds.

You can only give this command when the TACACS+ feature is enabled.

Use the `no` form of this command to set the timeout value to its default value (5 seconds).

Note: TELNET client session's default timeout is 60 seconds, so configuring timeout of 60 seconds timeout impacts TELNET client applications, because it cannot be fallback to use the other configured server/group. Hence it is recommended to configure 57 seconds or lesser timeout while using TELNET. This timeout doesn't have an impact on SSH connections.

### Command Syntax

```
tacacs-server login timeout <1-60> (vrf management|)
no tacacs-server login timeout (vrf management|)
```

### Parameters

<code>&lt;1-60&gt;</code>	Timeout value in seconds
<code>vrf</code>	Virtual Routing and Forwarding
<code>management</code>	Management VRF

### Default

Disabled

### Command Mode

Configure mode

### Applicability

This command is introduced in OcNOS version 1.3.9.

### Examples

```
#configure terminal
(config)#tacacs-server login timeout 35 vrf management
```



## CHAPTER 16 RADIUS Commands

---

This chapter is a reference for Remote Authentication Dial In User Service (RADIUS) commands, RADIUS provides centralized Authentication, Authorization management for users that connect to and use a network service. RADIUS is specified in RFC 2865.

Note: Only network administrators can execute these commands. For more, see the [username](#) command.

Note: The commands below are supported only on the “management” VRF.

- [clear radius-server](#)
- [debug radius](#)
- [radius-server login host](#)
- [radius-server login host acct-port](#)
- [radius-server login host auth-port](#)
- [radius-server login host key](#)
- [radius-server login key](#)
- [radius-server login timeout](#)
- [show debug radius](#)
- [show radius-server](#)
- [show running-config radius](#)

---

## clear radius-server

Use this command to clear Radius Server statistics.

### Command Syntax

```
clear radius-server ((HOSTNAME | X:X::X:X | A.B.C.D)|) counters (vrf (management | all)|)
```

### Parameters

A.B.C.D	IPv4 address of RADIUS server
X:X::X:X	IPv6 address of RADIUS server
HOSTNAME	DNS host name of RADIUS server
vrf management	To clear radius server counters for Virtual Routing and Forwarding management
all	To clear radius server counters for both management and default vrf
counters	To clear radius server counters for default vrf

### Default

No default value is specified

### Command Mode

Executive mode

### Applicability

This command was introduced in OcnOS version 1.3.

### Example

```
#clear radius-server counters vrf management
```

---

## debug radius

Use this command to display RADIUS debugging information.

Use the `no` form of this command stop displaying RADIUS debugging information.

### Command Syntax

```
debug radius
no debug radius
```

### Parameters

None

### Command Mode

Executive mode and configure mode

### Applicability

This command was introduced before OcNOS version 1.3.

### Examples

```
#debug radius
```

---

## radius-server login host

Use this command to configure a RADIUS server for both accounting and authentication.

Use the `no` form of this command to remove a RADIUS server.

### Command Syntax

```
radius-server login host (A.B.C.D | X:X::X:X | HOSTNAME) (vrf management|) seq-num
  (<1-8>)
```

```
radius-server login host (A.B.C.D | X:X::X:X | HOSTNAME) (vrf management|) seq-num
  (<1-8>) timeout <1-60>
```

```
radius-server login host (A.B.C.D | X:X::X:X | HOSTNAME) (vrf management|) seq-num
  (<1-8>) (acct-port <0-65535> |) | timeout <1-60> |)
```

```
radius-server login host (A.B.C.D | X:X::X:X | HOSTNAME) (vrf management|) seq-num
  (<1-8>) (| (auth-port <0-65535> (| (acct-port <0-65535> (| (timeout <1-60>))))))
```

```
radius-server login host (A.B.C.D | X:X::X:X | HOSTNAME) (vrf management|) seq-num
  (<1-8>) (| (key ((0 WORD) | (7 WORD)) (| (auth-port <0-65535> (| (acctport <0-65535>
  (| (timeout <1-60>))))))))
```

```
no radius-server login host (A.B.C.D | X:X::X:X | HOSTNAME) (vrf management|) (seq-
  num (<1-8>)|)
```

```
no radius-server login host (A.B.C.D | X:X::X:X | HOSTNAME) (vrf management|) (seq-
  num (<1-8>)|) timeout
```

### Parameters

<code>login</code>	Remote login
<code>A.B.C.D</code>	IPv4 address of RADIUS server
<code>X:X::X:X</code>	IPv6 address of RADIUS server
<code>HOSTNAME</code>	DNS host name of RADIUS server
<code>seq-num</code>	seq-num Sequence Number / Priority index for radius-servers
<code>&lt;1-8&gt;</code>	sequence number for servers
<code>timeout</code>	How long to wait for a response from the RADIUS server before declaring a timeout failure
<code>&lt;1-60&gt;</code>	Range of time out period in seconds
<code>vrf</code>	Virtual Routing and Forwarding
<code>management</code>	Management VRF

### Default

No default value is specified

### Command Mode

Configure mode

### Applicability

This command was introduced before OcnOS version 1.3.

**Examples**

```
#configure terminal  
(config)#radius-server login host 203.0.113.15 vrf management seq-num 1
```

---

## radius-server login host acct-port

Use this command to configure a RADIUS server and specify a UDP port to use for RADIUS accounting messages.

Use the `no` form of this command to remove a RADIUS server.

### Command Syntax

```
radius-server login host (A.B.C.D | X:X::X:X | HOSTNAME) (vrf management|) (seq-num
  (<1-8>)|) acct-port <0-65535> |) | timeout <1-60> |)
no radius-server login host (A.B.C.D | X:X::X:X | HOSTNAME) (vrf management|) (seq-
  num (<1-8>)|) acct-port |) | timeout <1-60> |)
```

### Parameters

<code>login</code>	Remote login
<code>A.B.C.D</code>	IPv4 address of RADIUS server
<code>X:X::X:X</code>	IPv6 address of RADIUS server
<code>HOSTNAME</code>	DNS host name of RADIUS server
<code>seq-num</code>	seq-num Sequence Number / Priority index for radius-servers
<code>&lt;1-8&gt;</code>	sequence number for servers
<code>acct-port</code>	UDP port to use for RADIUS accounting messages
<code>&lt;0-65535&gt;</code>	Range of UDP port numbers
<code>timeout</code>	How long to wait for a response from the RADIUS server before declaring a timeout failure
<code>&lt;1-60&gt;</code>	Range of timeout period in seconds
<code>vrf</code>	Virtual Routing and Forwarding
<code>management</code>	Management VRF

### Default

By default, Radius-server login host acct-port is 1813

### Command Mode

Configure mode

### Applicability

This command was introduced before OcNOS version 1.3.

### Examples

```
#configure terminal
(config)#radius-server login host 192.168.2.3 vrf management seq-num 2 acct-
port 23255
```

---

## radius-server login host auth-port

Use this command to configure a RADIUS server and specify a UDP port to use for RADIUS authentication messages. Use the `no` form of this command to remove a RADIUS server.

### Command Syntax

```
radius-server login host (A.B.C.D | X:X::X:X | HOSTNAME) (vrf management|) (seq-num
  (<1-8>|) (|(auth-port <0-65535> (|(acct-port <0-65535> (|(timeout <1-60>))))))
no radius-server login host (A.B.C.D | X:X::X:X | HOSTNAME) (vrf management|) (seq-
  num (<1-8>|) (auth-port (|(acct-port (|timeout))))
```

### Parameters

<code>login</code>	Remote login
<code>A.B.C.D</code>	IPv4 address of RADIUS server
<code>X:X::X:X</code>	IPv6 address of RADIUS server
<code>HOSTNAME</code>	DNS host name of RADIUS server
<code>seq-num</code>	seq-num Sequence Number / Priority index for radius-servers
<code>&lt;1-8&gt;</code>	sequence number for servers
<code>auth-port</code>	UDP port to use for RADIUS accounting messages
<code>&lt;0-65535&gt;</code>	Range of UDP port numbers
<code>acct-port</code>	UDP port to use for RADIUS accounting messages
<code>&lt;0-65535&gt;</code>	Range of UDP port numbers
<code>timeout</code>	How long to wait for a response from the RADIUS server before declaring a timeout failure
<code>&lt;1-60&gt;</code>	Range of timeout period in seconds
<code>vrf</code>	Virtual Routing and Forwarding
<code>management</code>	Management VRF

### Default

By default, Radius-server login host acct-port is 1812

### Command Mode

Configure mode

### Applicability

This command was introduced before OcnOS version 1.3.

### Examples

```
#configure terminal
(config)#radius-server login host 203.0.113.15 vrf management seq-num 1 auth-
port 23255
```

---

## radius-server login host key

Use this command to set per-server shared key ("shared secret") which is a text string shared between the device and RADIUS servers.

Use the no form of this command to remove a server shared key.

### Command Syntax

```
radius-server login host (A.B.C.D | X:X::X:X | HOSTNAME) (vrf management|) (seq-num
 (<1-8>|) (|(key ((0 WORD) | (7 WORD)) (|(auth-port <0-65535> (|(acct-port <0-
 65535> (|(timeout <1-60>))))))))))
```

```
no radius-server login host (A.B.C.D | X:X::X:X | HOSTNAME) (vrf management|) (seq-
 num (<1-8>|) (key ((0 WORD) | (7 WORD) ) (|(auth-port <0-65535> (|(acct-port
 (|(timeout))))))))
```

### Parameters

login	Remote login
A.B.C.D	IPv4 address of RADIUS server
X:X::X:X	IPv6 address of RADIUS server
HOSTNAME	DNS host name of RADIUS server
seq-num	seq-num Sequence Number / Priority index for radius-servers
<1-8>	sequence number for servers
0	Unencrypted (clear text) shared key
WORD	Unencrypted key value; maximum length 63 characters
7	Hidden shared key
WORD	Hidden key value; maximum length 63 characters
WORD	Unencrypted (clear text) shared key value; maximum length 63 characters
auth-port	UDP port to use for RADIUS accounting messages
<0-65535>	Range of UDP port numbers
acct-port	UDP port to use for RADIUS accounting messages
<0-65535>	Range of UDP port numbers
timeout	How long to wait for a response from the RADIUS server before declaring a timeout failure
<1-60>	Range of timeout period in seconds
vrf	Virtual Routing and Forwarding
management	Management VRF

### Default

No default value is specified

### Command Mode

Configure mode



**Applicability**

This command was introduced before OcnOS version 1.3.

**Examples**

```
#configure terminal
(config)#radius-server login host 203.0.113.15 vrf management seq-num 1 key 0
testing auth-port 23255
```

---

## radius-server login key

Use this command to set a global preshared key (“shared secret”) which is a text string shared between the device and RADIUS servers.

Use the `no` form of this command to remove a global preshared key.

### Command Syntax

```
radius-server login key ((0 WORD) | (7 WORD)) (vrf management|)
radius-server login host (A.B.C.D | X:X::X:X | HOSTNAME) (vrf management|) (seq-num
(<1-8>|) (|(key ((0 WORD) | (7 WORD)) (|(auth-port <0-65535> (|(acctport <0-65535>
(|(timeout <1-60>))))))))))
no radius-server login key ((0 WORD) | (7 WORD)) (vrf management|)
no radius-server login host (A.B.C.D | X:X::X:X | HOSTNAME) (vrf
management|) (seqnum(<1-8>|) (key ((0 WORD) | (7 WORD)) (|(auth-port <0-65535>
(|(acctport(|(timeout))))))))))
```

### Parameters

<code>login</code>	Remote login
<code>0</code>	Unencrypted (clear text) shared key
<code>WORD</code>	Unencrypted key value; maximum length 63 characters
<code>7</code>	Hidden shared key
<code>WORD</code>	Hidden key value; maximum length 63 characters
<code>WORD</code>	Unencrypted (clear text) shared key value; maximum length 63 characters
<code>vrf</code>	Virtual Routing and Forwarding
<code>management</code>	Management VRF

### Default

No default value is specified

### Command Mode

Configure mode

### Applicability

This command was introduced before OcNOS version 1.3.

### Examples

```
#configure terminal
(config)#radius-server login key 7 p2AcxlQA vrf management

#configure terminal
(config)#no radius-server login key 7 p2AcxlQA vrf management
```

---

## radius-server login timeout

Use this command to set the global timeout which is how long the device waits for a response from a RADIUS server before declaring a timeout failure.

Use the `no` form of this command to set the global timeout to its default (1 second).

Note: TELNET client session's default timeout is 60 seconds, so configuring timeout of 60 seconds timeout impacts TELNET client applications, because it cannot be fallback to use the other configured server/group. Hence it is recommended to configure 57 seconds or lesser timeout while using TELNET. This timeout doesn't have an impact on SSH connections.

### Command Syntax

```
radius-server login timeout <1-60> (vrf management|)
no radius-server login timeout (vrf management|)
```

### Parameters

<code>login</code>	Remote login
<code>&lt;1-60&gt;</code>	Range of timeout period in seconds
<code>vrf</code>	Virtual Routing and Forwarding
<code>management</code>	Management VRF

Note: The system takes minimum 3 secs to timeout even though the configured timeout value is less than 3 seconds. Hence do not configure timeout value less than 3 secs. The timeout range value is mentioned as 1-60 secs for backward compatibility.

### Default

By default, radius-server login timeout is 5 seconds

### Command Mode

Configure mode

### Applicability

This command was introduced before OcnOS version 1.3.

### Examples

```
#configure terminal
(config)#radius-server login timeout 15 vrf management

#configure terminal
(config)#no radius-server login timeout 15 vrf management
```

---

## show debug radius

Use this command to display debugging information.

### Command Syntax

```
show debug radius
```

### Parameters

None

### Command Mode

Executive mode

### Applicability

This command was introduced before OcNOS version 1.3.

### Examples

```
#show debug radius  
RADIUS client debugging is on
```

---

## show radius-server

Use this command to display the RADIUS server configuration.

### Command Syntax

```
show radius-server (|vrf(management|all)) ((WORD) |(groups (GROUP|) |) |sorted
```

### Parameters

WORD	DNS host name or IP address
groups	RADIUS server group
GROUP	Group name; if this parameter is not specified, display all groups
sorted	Sort by RADIUS server name
vrf	management or all VRFs

### Command Mode

Executive mode

### Applicability

This command was introduced before OcNOS version 1.3.

### Examples

```
#show radius-server vrf management
      VRF: management
timeout value: 5
```

```
Total number of servers:2
```

Following RADIUS servers are configured:

```
Radius Server      : 10.12.12.39
  Sequence Number  : 1
  available for authentication on port : 1812
  available for accounting on port    : 1813
  RADIUS shared secret : *****
  Failed Authentication count         : 0
  Successful Authentication count     : 0
  Failed Connection Request          : 0
  Last Successful authentication     :
```

```
Radius Server      : 1.1.1.1
  Sequence Number  : 2
  available for authentication on port : 1234
  available for accounting on port    : 1234
  timeout          : 5
  Failed Authentication count         : 0
  Successful Authentication count     : 0
  Failed Connection Request          : 0
  Last Successful authentication     :
```

[Table 16-30](#) explains the output fields.

**Table 16-30: show radius-server fields**

<b>Entry</b>	<b>Description</b>
VRF	Virtual Routing and Forwarding (VRF) default support.
Timeout Value	Period the local router waits to receive a response from a RADIUS accounting server before retransmitting the message
Total number of servers	Number of authentication requests received by the authentication server.

---

## show running-config radius

Use this command to display RADIUS configuration settings in the running configuration.

### Command Syntax

```
show running-config radius
```

### Parameters

None

### Command Mode

Executive mode

### Applicability

This command was introduced before OcNOS version 1.3.

### Examples

```
#show running-config radius
 10.12.12.39 vrf management seq-num 1 key 7 wawyanb123
 1.1.1.1 vrf management seq-num 2 auth-port 1234 acct-po
rt 1234
radius-server login key 7 wawyanb123
```





---

## CHAPTER 17 Simple Network Management Protocol

---

This chapter is a reference for Simple Network Management Protocol (SNMP) commands.

SNMP provides a standardized framework and a common language for monitoring and managing devices in a network. The SNMP framework consists of three parts:

- An SNMP manager: The system used to control and monitor the activities of network devices. This is sometimes called a Network Management System (NMS).
- An SNMP agent: The component within a managed device that maintains the data for the device and reports these data SNMP managers.
- Management Information Base (MIB): SNMP exposes management data in the form of variables which describe the system configuration. These variables can be queried by SNMP managers.

In SNMP, administration groups are known as *communities*. SNMP communities consist of one agent and one or more SNMP managers. You can assign groups of hosts to SNMP communities for limited security checking of agents and management systems or for administrative purposes. Defining communities provides security by allowing only management systems and agents within the same community to communicate.

A host can belong to multiple communities at the same time, but an agent does not accept a request from a management system outside its list of acceptable community names.

SNMP access rights are organized by groups. Each group is defined with three accesses: read access, write access, and notification access. Each access can be enabled or disabled within each group.

The SNMP v3 security level determines if an SNMP message needs to be protected from disclosure and if the message needs to be authenticated. The security levels are:

- noAuthNoPriv: No authentication or encryption
- authNoPriv: Authentication but no encryption
- authPriv: Both authentication and encryption.

SNMP is defined in RFCs 3411-3418.

Note: The commands below are supported on the “management” and default VRF.

This chapter contains these commands:

- `debug snmp-server`
- `show running-config snmp`
- `show snmp`
- `show snmp community`
- `show snmp context`
- `show snmp engine-id`
- `show snmp group`
- `show snmp host`
- `show snmp user`
- `show snmp view`
- `snmp context`
- `snmp-server community`
- `snmp-server community-map`
- `snmp-server contact`

- [snmp-server context](#)
- [snmp-server disable default](#)
- [snmp-server enable snmp](#)
- [snmp-server enable traps](#)
- [snmp-server engineID](#)
- [snmp-server group](#)
- [snmp-server host](#)
- [snmp-server location](#)
- [snmp-server smux-port-disable](#)
- [snmp-server tcp-session](#)
- [snmp-server user](#)
- [snmp-server view](#)

---

## debug snmp-server

Use this command to display SNMP debugging information.

Use the `no` form of this command to stop displaying SNMP debugging information.

### Command Syntax

```
debug snmp-server
no debug snmp-server
```

### Parameters

None

### Default

By default, disabled.

### Command Mode

Exec and configure mode

### Applicability

This command was introduced before OcNOS version 1.3.

### Example

```
#debug snmp-server
```

---

## show running-config snmp

Use this command to display the SNMP running configuration.

### Command Syntax

```
show running-config snmp
```

### Parameters

None

### Command Mode

Privileged Exec mode

### Applicability

This command was introduced before OcNOS version 1.3.

### Example

```
#show running-config snmp
snmp-server view all .1 included
snmp-server community abc group network-admin
snmp-server enable snmp
```

---

## show snmp

Use this command to display the SNMP configuration, including session status, system contact, system location, statistics, communities, and users.

### Command Syntax

```
show snmp
```

### Parameters

None

### Command Mode

Exec mode

### Applicability

This command was introduced before OcNOS version 1.3.

### Examples

```
#show snmp
SNMP Protocol:Enabled
sys Contact:
sys Location:
```

```
-----
Community Group/Access Context acl_filter
-----
public network-admin
```

---

#### SNMP USERS

---

```
User Auth Priv(enforce) Groups
```

---

```
SNMP Tcp-session :Disabled
```

---

## show snmp community

Use this command to display SNMP communities.

### Command Syntax

```
show snmp community
```

### Parameters

None

### Command Mode

Exec mode

### Applicability

This command was introduced before OcNOS version 1.3.

### Examples

```
#show snmp community
```

```
-----
Community          Group/Access      view-name
version
-----
test                network-operator
testing            network-operator  ipi
2c
```

[Table 17-31](#) explains the output fields.

**Table 17-31: show snmp community fields**

Entry	Description
Community	SNMP Community string.
Group/Access	Community group name.
View-name	Community view name.
Version	Community version.

---

## show snmp context

Use this command to display SNMP server contexts and associated groups.

### Command syntax

```
show snmp context
```

### Parameters

None

### Command Mode

Exec mode

### Applicability

This command is introduced in OcNOS-SP version 5.1 MR

### Example

```
OcNOS#show snmp context
```

```
-----  
context                                groups  
-----  
ctx1                                   grp1, grp2  
ctx2                                   grp3
```

---

## show snmp engine-id

Use this command to exhibit the SNMP engine identifier.

The SNMP engine identifier is a distinctive string employed to recognize the device for administrative purposes. The default engine-id is formulated using the MAC address, but an option for user-configured engine-id is also provided. The `show` command should be employed to retrieve information about the presently configured SNMP engine-id on the device.

### Command Syntax

```
show snmp engine-id
```

### Parameters

None

### Command Mode

Exec mode

### Applicability

This command was introduced prior to OcNOS version 1.3 and its display in the `show` output was enhanced in OcNOS version 6.3.2.

### Examples

Default SNMP engine-id:

```
#show snmp engine-id
SNMP ENGINE-ID Type: MAC address
SNMP ENGINE-ID : 80 00 1f 88 03 e8 c5 7a 1a 02 1c
```

User-Configured engine-id:

```
#show snmp engine-id
SNMP ENGINE-ID Type: User configured Text
SNMP ENGINE-ID Text: ipinfusion
SNMP ENGINE-ID : 80 00 1f 88 04 69 70 69 6e 66 75 73 69 6f 6e
```

[Table 17-32](#) explains the output fields.

**Table 17-32: show snmp engine-ip fields**

Entry	Description
SNMP ENGINE-ID: 80 00 1f 88 04 69 70 69 6e 66 75 73 69 6f 6e	The SNMP engine identifier is a distinct string utilized to uniquely recognize the device for administrative purposes.



## show snmp group

Use this command to display SNMP server groups and associated views.

### Command Syntax

```
show snmp group
```

### Parameters

None

### Command Mode

Exec mode

### Applicability

This command was introduced before OcNOS version 1.3.

### Examples

```
#show snmp group
-----
community/user      group          version  Read-View  Write-view  Notify-view
-----
test                network-operator  2c/1    all        all        all
kedar               network-operator  3       all        none       all
tamil               network-operator  3       all        none       all
```

[Table 17-33](#) explains the output fields.

**Table 17-33: show snmp group output**

Entry	Description
Community/User	Displays the access type of the user for which the notification is generated.
Group	The name of the SNMP group, or collection of users that have a common access policy.
Version	SNMP version number.
Read-View	A string identifying the read view of the group. For further information on the SNMP views, use the show snmp view command.
Write-View	A string identifying the write view of the group.
Notify-View	A string identifying the notify view of the group. The notify view indicates the group for SNMP notifications, and corresponds to the setting of the snmp-server group group-name version notify notify-view command.

---

## show snmp host

Use this command to display the SNMP trap hosts.

### Command Syntax

```
show snmp host
```

### Parameters

None

### Command Mode

Exec mode

### Applicability

This command was introduced before OcNOS version 1.3.

### Examples

```
#show snmp host
```

```
-----  
Host          Port    Version  Level    Type    SecName  
-----  
10.10.26.123  162    2c       noauth   trap    test
```

[Table 17-34](#) explains the output fields.

**Table 17-34: Show snmp host output**

Entry	Description
Host	The IP address of the SNMP host server.
Port	The port being used for SNMP traffic.
Version	SNMP version number.
Level	The security level being used.
Type	The type of SNMP object being sent.
SecName	Secure Name for this SNMP session.

---

## show snmp user

Use this command to display SNMP users and associated authentication, encryption, and group.

### Command Syntax

```
show snmp user
```

### Parameters

None

### Command Mode

Exec mode

### Applicability

This command was introduced before OcNOS version 1.3.

### Examples

```
#show snmp user
```

```
SNMP USERS
```

User	Auth	Priv(enforce)	Groups
ntwadmin	MD5	AES	network-admin

```
#
```

[Table 17-35](#) explains the output fields.

**Table 17-35: Show snmp user output**

Entry	Description
User	The person attempting to use the SMNMP agent.
Auth	The secure encryption scheme being used.
Priv(enforce)	What enforcement privilege is being used (in this case, it is the Advance Encryption Standard).
Group	The group to which the user belongs.

---

## show snmp view

Use this command to display SNMP views.

### Command Syntax

```
show snmp view
```

### Parameters

None

### Command Mode

Exec mode

### Applicability

This command was introduced before OcNOS version 1.3.

### Examples

```
#show snmp view
```

```
View : all  
OID : .1  
View-type : included
```

---

## snmp context

Use this command to associate the SNMP context with the VRF.

Use the `no` form of this command to remove the SNMP context association from VRF.

### Command Syntax

```
snmp context-name WORD
no snmp context-name
```

### Parameters

`WORD` SNMP context name (Maximum 32 alphanumeric characters)

### Default

No default value is specified.

### Command Mode

Configure VRF mode

### Applicability

This command was introduced before OcnOS version 6.1.0.

### Examples

```
OcnOS#configure terminal
```

Enter configuration commands, one per line. End with CNTL/Z.

```
OcnOS(config)#ip vrf red
OcnOS(config-vrf)#snmp context-name context1
```

---

## snmp-server community

Use this command to create an SNMP community string and access privileges.

Use the `no` form of this command to remove an SNMP community string.

### Command Syntax

```
snmp-server community WORD (| (view VIEW-NAME version (v1 | v2c ) ( ro)) |
(group (network-admin|network-operator)) |( ro) | (use-acl WORD) ) (vrf
management|)
no snmp-server community COMMUNITY-NAME (vrf management|)
```

### Parameters

<code>WORD</code>	Name of the community (Maximum 32 alphanumeric characters)
<code>VIEW-NAME</code>	Name of the snmp view (Maximum 32 alphanumeric characters)
<code>version</code>	Set community string and access privileges
<code>v1</code>	SNMP v1
<code>v2c</code>	SNMP v2c
<code>ro</code>	Read-only access
<code>group</code>	Community group
<code>network-admin</code>	System configured group for read-only
<code>network-operator</code>	System configured group for read-only(default)
<code>ro</code>	Read-only access
<code>use-acl</code>	Access control list (ACL) to filter SNMP requests
<code>WORD</code>	ACL name; maximum length 32 characters
<code>management</code>	Virtual Routing and Forwarding name

### Default

No default value specified.

### Command Mode

Configure mode

### Applicability

This command was introduced before OcnOS version 1.3.

### Examples

```
#configure terminal
(config)#snmp-server community MyComm view MyView1 version v2c ro vrf
management
```

---

## snmp-server community-map

Use this command to map the community name with context and SNMPv2 user.

Use `no` form of this command to remove the community mapping.

Note: Community can be mapped with one context and user.

### Command Syntax

```
snmp-server community-map WORD context WORD user WORD (vrf management|)
no snmp-server community-map WORD context WORD user WORD (vrf management|)
```

### Parameters

WORD	SNMP community name
context	SNMP context name
WORD	Context string
user	SNMP user name
WORD	User string
management	Virtual Routing and Forwarding name

### Command Mode

Configure mode

### Applicability

This command is introduced in OcNOS-SP version 5.1 MR.

### Examples

```
OcNOS(config)#snmp-server community-map test context ctx2 user testing vrf
management
```

---

## snmp-server contact

Use this command to set the system contact information for the device (`sysContact` object).

Use the `no` form of this command to remove the system contact information.

### Command Syntax

```
snmp-server contact (vrf management|) (TEXT|)
no snmp-server contact (vrf management|) (TEXT|)
```

### Parameters

<code>management</code>	Virtual Routing and Forwarding name
<code>TEXT</code>	System contact information; maximum length 1024 characters without spaces

### Default

No default value specified.

### Command Mode

Configure mode

### Applicability

This command was introduced before OcNOS version 1.3.

### Examples

```
#configure terminal
(config)#snmp-server contact vrf management Irving@555-0150
```



---

## snmp-server context

Use this command to create SNMP context.

Use `no` form of this command to remove the context.

### Command Syntax

```
snmp-server context WORD (vrf management|)
no snmp-server context WORD (vrf management|)
```

### Parameters

context	SNMP context name
WORD	Context string (Maximum 32 alphanumeric characters)
management	Virtual Routing and Forwarding name

### Command Mode

Configure mode

### Applicability

This command is introduced in OcNOS version 5.1MR.

### Examples

```
OcNOS(config)#snmp-server context ctx1 vrf management
```

---

## snmp-server disable default

Use this command to disable default instance which is running on OcnOS device. After configuring this command user should not be able to enable default snmp instance. Use no form of this command to unset this after that only user should be able to configure default instance.

### Command Syntax

```
snmp-server disable-default
```

### Parameters

None

### Default

No default value specified.

### Command Mode

Configure mode

### Applicability

This command was introduced before OcnOS version 6.1.0.

### Examples

```
#configure terminal  
(config)#snmp-server disable-default
```

---

## snmp-server enable snmp

Use this command to start the SNMP agent daemon over UDP.

Use the `no` form of this command to stop the SNMP agent daemon over UDP.

### Command Syntax

```
snmp-server enable snmp (vrf management|)
no snmp-server enable snmp (vrf management|)
```

### Parameters

management      Virtual Routing and Forwarding name

### Default

No default value specified.

### Command Mode

Configure mode

### Applicability

This command was introduced before OcnOS version 1.3.

### Examples

```
#configure terminal
(config)#snmp-server enable snmp vrf management
```

---

## snmp-server enable traps

Use this command to enable or disable SNMP traps and inform requests.

Note: For CMMD, Critical logs in the console are equivalent to Alert traps & Alert logs on the console is equivalent to critical trap in SNMP.

### Command Syntax

```
snmp-server enable traps (link(|linkDown|linkUp|include-interface-  
name)|snmp(|authentication)| mpls|pw|pwdelete|ospf|bgp|isis|vxlan|vrrp|ospf6)
```

```
no snmp-server enable traps (link(|linkDown|linkUp|include-interface-  
name)|snmp(|authentication)| mpls|pw|pwdelete|ospf|bgp|isis|vxlan|vrrp|ospf6)
```

### Parameters

bgp	bgp notification trap
isis	isis notification trap
link	Module notifications enable
linkDown	IETF Link state down notification
linkUp	IETF Link state up notification
snmp	Enable RFC 1157 notifications
authentication	Send SNMP authentication failure notifications
mpls	mpls notification trap
mplsl3vpn	mpls-l3vpn notification trap
ospf	ospf notification trap
ospf6	ospf6 notification trap
pw	pw notification trap
pwdelete	pwdelete notification trap
rib	rib notification trap
rsvp	rsvp notification trap
vrrp	vrrp notification trap
vxlan	vxlan notification trap
linkDown	IETF link state down notification
linkup	IETF link state up notification
include-interface-name	Enable this option to include interface name in the Linkup/Linkdown trap's varbind

### Default

By default, SNMP server traps are enabled.

### Command Mode

Configure mode

**Applicability**

This command was introduced before OcnOS version 1.3 and was updated in OcnOS version 4.0.

**Examples**

```
(config)#snmp-server enable traps snmp
(config)#snmp-server enable traps mpls
(config)#snmp-server enable traps mpls13vpn
(config)#snmp-server enable traps rsvp
(config)#snmp-server enable traps ospf
(config)#snmp-server enable traps ospf6
(config)#snmp-server enable traps vrrp
(config)#snmp-server enable traps vxlan
(config)#snmp-server enable traps snmp authentication
```

---

## snmp-server engineID

Use this command to establish the SNMPv3 engine ID.

Use the no form of this command to remove the SNMPv3 engine ID.

### Command Syntax

```
snmp-server engineID ENGINE_ID_STR
no snmp-server engineID
```

### Parameters

`ENGINE_ID_STR` String of characters that uniquely identifies the SNMP engine ID.

### Default

By Default the SNMP Server Engine ID value is automatically generated using the MAC address.

### Command Mode

Configure mode

### Applicability

This command was introduced before OcNOS version 6.3.2.

### Examples

```
#configure terminal
(config)#snmp-server engineID ipinfusion
```

---

## snmp-server group

Use this command to create a SNMP group.

Use the `no` form of this command to remove the groups.

### Command syntax

```
snmp-server group WORD version (1|2c) (context (all|WORD)) (vrf management|)
snmp-server group WORD version 3 (auth|noauth|priv) (context (all|WORD)) (vrf
management|)
no snmp-server group WORD (context (all|WORD)) (vrf management|)
```

### Parameters

WORD	Specify the snmp group name (Maximum 32 alphanumeric characters)
version	SNMP Version
1	SNMP v1
2c	SNMP v2c
3	SNMP v3 security level
noauth	No authentication and no privacy (noAuthNoPriv) security model: messages transmitted as clear text providing backwards compatibility with earlier versions of SNMP
auth	Authentication and no privacy (authNoPriv) security model: use message digest algorithm (MD5) or Secure Hash Algorithm (SHA) for packet authentication; messages transmitted in clear text
priv	Authentication and privacy (authPriv) security model: use authNoPriv packet authentication with Data Encryption Standard (DES) Advanced Encryption Standard (AES) for packet encryption
context	SNMP context name
WORD	SNMP context string (Maximum 32 alphanumeric characters)
all	All context name's allowed for this group.
management	Virtual Routing and Forwarding (VRF) name

### Default

None

### Command Mode

Configure mode

### Applicability

This command is introduced in OcNOS-SP version 5.1 MR.

### Examples

```
OcNOS#con t
OcNOS(config)#snmp-server context ctx1 vrf management
OcNOS(config)#snmp-server group grp1 version 3 auth context ctx1 vrf
management
```

```
OcNOS(config)#snmp-server group grp3 version 2c context ctx2 vrf management
```



---

## snmp-server host

Use this command to configure an SNMP trap host. An SNMP trap host is usually a network management station (NMS) or an SNMP manager.

Use the `no` form of this command to remove an SNMP trap host.

Note: The maximum number of SNMP trap hosts is limited to 8.

### Command Syntax

```
snmp-server host (A.B.C.D | X:X::X:X | HOSTNAME) ((traps version(( (1 | 2c) WORD )
| (3 (noauth | auth | priv) WORD))) |(informs version ((2c WORD) | (3 (noauth |
auth | priv) WORD))))(|udp-port <1-65535>) (vrf management|)

snmp-server host (A.B.C.D | X:X::X:X | HOSTNAME) WORD (|udp-port <1-65535>) (vrf
management|)

snmp-server host (A.B.C.D | X:X::X:X | HOSTNAME) (version(( (1 | 2c) WORD ) | (3
(noauth | auth | priv) WORD)))(|udp-port <1-65535>) (vrf management|)

no snmp-server host (A.B.C.D|X:X::X:X|HOSTNAME) (vrf management|)
```

### Parameters

A.B.C.D	IPv4 address
X:X::X:X	IPv6 address
HOSTNAME	DNS host name
WORD	SNMP community string or SNMPv3 user name (Maximum 32 alphanumeric characters)
informs	Send notifications as informs
version	SNMP Version. Default notification is traps
<1-65535>	Host UDP port number; the default is 162
management	Virtual Routing and Forwarding name
traps	Send notifications as traps
version	Version
1	SNMP v1
2c	SNMP v2c
WORD	SNMP community string (Maximum 32 alphanumeric characters)
3	SNMP v3 security level
noauth	No authentication and no privacy (noAuthNoPriv) security model: messages transmitted as clear text providing backwards compatibility with earlier versions of SNMP
auth	Authentication and no privacy (authNoPriv) security model: use message digest algorithm 5 (MD5) or Secure Hash Algorithm (SHA) for packet authentication; messages transmitted in clear text
priv	Authentication and privacy (authPriv) security model: use authNoPriv packet authentication with Data Encryption Standard (DES) Advanced Encryption Standard (AES) for packet encryption
WORD	SNMPv3 user name

## Default

The default SNMP version is v2c and the default UDP port is 162. Simple Network Management Protocol.

## Command Mode

Configure mode

## Applicability

This command was introduced before OcnOS version 1.3.

## Examples

```
#configure terminal
(config)#snmp-server host 10.10.10.10 traps version 3 auth MyUser udp-port 512
vrf management
```

---

## snmp-server location

Use this command to set the physical location information of the device (`sysLocation` object).

Use the `no` form of this command to remove the system location information.

### Command Syntax

```
snmp-server location (vrf management|) (TEXT|)
no snmp-server location (vrf management|) (TEXT|)
```

### Parameters

<code>management</code>	Virtual Routing and Forwarding name
<code>TEXT</code>	Physical location information; maximum length 1024 characters

### Default

No system location string is set.

### Command Mode

Configure mode

### Applicability

This command was introduced before OcnOS version 1.3.

### Examples

```
#configure terminal
(config)#snmp-server location vrf management Bldg. 5, 3rd floor, northeast
```

---

## snmp-server smux-port-disable

Use this CLI to disable the SMUX open port.

### Command Syntax

```
snmp-server smux-port-disable
```

### Parameters

None

### Default

None

### Command Mode

Configure mode

### Applicability

This command is introduced in OcNOS version 5.1 release.

### Examples

```
#configure terminal
#snmp-server smux-port-disable
```

---

## snmp-server tcp-session

Use this command to start the SNMP agent daemon over TCP.

Use the `no` form of this command to close the SNMP agent daemon over TCP.

### Command Syntax

```
snmp-server tcp-session (vrf management|)
no snmp-server tcp-session (vrf management|)
```

### Parameters

management      Virtual Routing and Forwarding name

### Default

By default, snmp server tcp session is disabled.

### Command Mode

Configure mode

### Applicability

This command was introduced before OcnOS version 1.3.

### Examples

```
#configure terminal
(config)#snmp-server tcp-session vrf management
```

---

## snmp-server user

Use this command to create an SNMP server user.

Use the `no` form of this command to remove an SNMP server user.

### Command Syntax

```
snmp-server user WORD ((network-operator|network-admin| WORD|) ((auth (md5 | sha
) (encrypt|) AUTH-PASSWORD) ((priv (des | aes) PRIV-PASSWORD) |) |) (vrf
management|)
no snmp-server user USER-NAME (vrf management|)
```

### Parameters

WORD	Specify the snmp user name (Min 5 to Max 32 alphanumeric characters)
network-operator network-admin	Name of the group to which the user belongs.
WORD	User defined group-name
auth	Packet authentication type
md5	Message Digest Algorithm 5 (MD5)
sha	Secure Hash Algorithm (SHA)
AUTH-PASSWORD	Authentication password; length 8-32 characters
priv	Packet encryption type ("privacy")
des	Data Encryption Standard (DES)
aes	Advanced Encryption Standard (AES)
PRIV-PASSWORD	Encryption password; length 8-33 characters
management	Virtual Routing and Forwarding name
encrypt	Specify authentication-password and/or privilege-password in encrypted form. This option is provided for reconfiguring a password using an earlier encrypted password that was available in running configuration display or get-config payload. Users are advised not to use this option for entering passwords generated in any other method.

### Default

By default, snmp server user word is disabled

### Command Mode

Configure mode

### Applicability

This command was introduced before OcNOS version 1.3.

**Examples**

```
#configure terminal
(config)#snmp-server user Fred auth md5 J@u-b;l2e`n,9p_ priv des
t41VVb99i8He{Jt vrf management
```

---

## snmp-server view

Use this command to create or update a view entry

Use the `no` form of this command to remove a view entry.

Note: OIDs to be excluded or included need to be specifically mentioned while configuring the SNMP view. Only when the OIDs are included will they be displayed in SNMP-Walk. When an OID is excluded, other OIDs must be explicitly included for the system to function.

### Command Syntax

```
snmp-server view VIEW-NAME OID-TREE (included | excluded) (vrf management|)
no snmp-server view VIEW-NAME (vrf management|)
```

### Parameters

VIEW-NAME	Name of the snmp view (Maximum 32 alphanumeric characters)
OID-TREE	Object identifier of a subtree to include or exclude from the view; specify a text string consisting of numbers and periods, such as 1.3.6.2.4
included	Include <code>OID-TREE</code> in the SNMP view
excluded	Exclude <code>OID-TREE</code> from the SNMP view
management	Virtual Routing and Forwarding name

### Default

By default, snmp-server view VIEW-NAME OID-TREE is disabled.

### Command Mode

Configure mode

### Applicability

This command was introduced before OcNOS version 1.3.

### Examples

The following example creates a view named `myView3` that excludes the `snmpCommunityMIB` object (1.3.6.1.6.3.18).

```
#configure terminal
(config)#snmp-server view myView3 1.3.6.1.6.3.18 excluded vrf management
```



---

## CHAPTER 18 Authentication, Authorization and Accounting

---

This chapter is a reference for the authentication:

- Authentication identifies users by challenging them to provide a user name and password. This information can be encrypted if required, depending on the underlying protocol.
- Authorization provides a method of authorizing commands and services on a per user profile basis.

Note: Authorization will be auto-enabled if user enables the Authentication.

- Accounting collects detailed system and command information and stores it on a central server where it can be used for security and quality assurance purposes.

The authentication feature allows you to verify the identity and, grant access to managing devices. The authentication feature works with the access control protocols as described in these chapters:

- [Chapter 16, RADIUS Commands](#)
- [Chapter 15, TACACS+ Commands](#)

Note: Only network administrators can execute these commands. For more, see the [username](#) command.

Note: The commands below are supported only on the “management” VRF.

Note: Per-command authorization needs to be enabled explicitly by the user whereas Session based authorization will be implicitly enabled when user enables authentication.

This chapter describes these commands:

- [aaa authentication login](#)
- [aaa accounting details](#)
- [aaa authentication login default](#)
- [aaa authorization default](#)
- [aaa authentication login default fallback error](#)
- [aaa group server](#)
- [aaa local authentication attempts max-fail](#)
- [aaa local authentication unlock-timeout](#)
- [debug aaa](#)
- [server](#)
- [show aaa authentication](#)
- [show aaa authentication login](#)
- [show aaa authorization](#)
- [show aaa groups](#)
- [show aaa accounting](#)
- [show running-config aaa](#)

---

## aaa authentication login

Use this command to set login authentication behavior.

Use the `no` form of this command to disable either authentication behavior.

### Command Syntax

```
aaa authentication login error-enable (vrf management|)
no aaa authentication login error-enable (vrf management|)
```

### Parameters

<code>error-enable</code>	Display login failure messages
<code>management</code>	Management VRF

### Default

By default, `aaa authentication login` is local

### Command Mode

Configure mode

### Applicability

This command was introduced before OcnOS version 1.3.

### Examples

```
#configure terminal
(config)#aaa authentication login error-enable vrf management
```

---

## aaa accounting details

Use this command to set a list of server groups to which to redirect accounting logs.

Use the `no` form of this command to only log locally.

### Command Syntax

```
aaa accounting default (vrf management|) ((group LINE)|local)
no aaa accounting default (vrf management|) ((group)|local)
```

### Parameters

<code>group</code>	Server group list for authentication
<code>LINE</code>	A space-separated list of up to 8 configured RADIUS or TACACS+ server group names
<code>local</code>	Use local authentication
<code>management</code>	Management VRF

### Default

Default AAA method is local

Default groups: RADIUS or TACACS+

### Command Mode

Configure mode

### Applicability

This command was introduced before OcNOS version 1.3.

### Examples

```
#configure terminal
(config)#aaa accounting default vrf management group radius
```

---

## aaa authentication login default

Use this command to set the AAA authentication methods.

Use the `no` form of this command to set the default AAA authentication method (`local`).

### Command Syntax

```
aaa authentication login default (vrf management|) ((group LINE) | (local (|none))
| (none))
no aaa authentication login default (vrf management|) ((group) | (local (|none)) |
(none))
```

### Parameters

<code>group</code>	Use a server group list for authentication
<code>LINE</code>	A space-separated list of up to 8 configured RADIUS or TACACS+, server group names followed by <code>local</code> or <code>none</code> or both <code>local</code> and <code>none</code> . The list can also include:
<code>radius</code>	All configured RADIUS servers
<code>tacacs+</code>	All configured TACACS+ servers
<code>local</code>	Use local authentication
<code>none</code>	No authentication
<code>management</code>	Management VRF

### Default

By default, AAA authentication method is `local`

By default, groups: RADIUS or TACACS+

### Command Mode

Configure mode

### Applicability

This command was introduced before OcNOS version 1.3.

### Examples

```
#configure terminal
(config)#aaa authentication login default vrf management group radius
```

---

## aaa authorization default

Use this command to enable per-command authorization. By enabling this user should be able to authorize every command executed via configured server.

This authorization will work only when authentication is successful.

Use the no form of this command to disable authorization.

### Command Syntax

```
aaa authorization default (vrf management|) ((group LINE)|local)
no aaa authorization default (vrf management|) ((group LINE)|local)
```

### Parameters

group	Server group list for authentication
LINE	Space-separated list of up to 8 configured TACACS+ server group names
local	Use local authentication
management	Management VRF

### Default

Default AAA method is local

Default groups: TACACS+

### Command Mode

Configure mode

### Applicability

This command is introduced in OcNOS version 6.1.0

### Examples

```
#configure terminal
(config)#aaa authorization default vrf management group tacacs+
```

---

## aaa authentication login default fallback error

Use this command to enable fallback to local authentication for the default login if remote authentication is configured and all AAA servers are unreachable.

Use the `no` form of this command to disable fallback to local authentication

Note: If you have specified `local` (use local authentication) in the [aaa authentication login default](#) command, you do not need to use this command to ensure that “fall back to local” occurs.

### Command Syntax

```
aaa authentication login default fallback error local (vrf management|)
no aaa authentication login default fallback error local (vrf management|)
```

### Parameters

`management`      Management VRF

### Default

By default, AAA authentication is local.

### Command Mode

Configure mode

### Applicability

This command was introduced before OcnOS version 1.3.

### Examples

```
#configure terminal
(config)#aaa authentication login default fallback error local vrf management
```

---

## aaa group server

Use this command to create a server group and enter server group configure mode.

Use the `no` form of this command to remove a server group.

### Command Syntax

```
aaa group server (radius|tacacs+) WORD (vrf management|)
no aaa group server (radius|tacacs+) WORD (vrf management|)
```

### Parameters

radius	RADIUS server group
tacacs+	TACACS+ server group
WORD	Server group name; maximum 127 characters
management	Management VRF

### Default

By default, the AAA group server option is disabled.

### Command Mode

Configure mode

### Applicability

This command was introduced before OcnOS version 1.3.

### Examples

```
#configure terminal
(config)#aaa group server radius maxsmart
(config-radius)#
```

---

## aaa local authentication attempts max-fail

Use this command to set the number of unsuccessful authentication attempts before a user is locked out.

Use the `no` form of this command to disable the lockout feature.

### Command Syntax

```
aaa local authentication attempts max-fail <1-25>
no aaa local authentication attempts max-fail
```

### Parameters

<1-25>                      Number of unsuccessful authentication attempts

### Default

By default, the maximum number of unsuccessful authentication attempts before a user is locked out is 3.

### Command Mode

Configure mode

### Applicability

This command was introduced before OcNOS version 1.3.

### Examples

```
#configure terminal
(config)#aaa local authentication attempts max-fail 2
```



---

## aaa local authentication unlock-timeout

Use this command to set timeout value in seconds to unlock local user-account.

Use the no form of this command to set default timeout value in seconds.

Note: This command is applicable only to local user but not for user/s present at the server end to authenticate using TACACS+ or RADIUS.

### Command Syntax

```
aaa local authentication unlock-timeout <1-3600>
no aaa local authentication unlock-timeout
```

### Parameters

<1-3600>            Timeout in seconds to unlock local user-account. Default value is 1200.

### Default

By default, the unlock timeout is 1200 seconds.

### Command Mode

Configure mode

### Applicability

This command was introduced before OcnOS version 1.3.

### Examples

```
#configure terminal
(config)#aaa local authentication unlock-timeout 1800
```

---

## debug aaa

Use this command to display AAA debugging information.

Use the `no` form of this command to stop displaying AAA debugging information.

### Command Syntax

```
debug aaa
```

```
no debug aaa
```

### Parameters

None

### Command Mode

Executive mode and configure mode

### Applicability

This command was introduced before OcNOS version 1.3.

### Examples

```
#debug aaa
```

---

## server

Use this command to add a server to a server group.

Use the `no` form of this command to remove from a server group.

### Command Syntax

```
server (A.B.C.D | X:X::X:X | HOSTNAME)
no server (A.B.C.D | X:X::X:X | HOSTNAME)
```

### Parameters

A.B.C.D	IPv4 address
X:X::X:X	IPv6 address

### Default

None

### Command Modes

RADIUS server group configure mode

TACACS+ server group configure mode

### Applicability

This command was introduced before OcnOS version 1.3.

### Examples

```
#configure terminal
(config)#feature tacacs+
(config)#aaa group server tacacs+ TacacsGroup4
(config-tacacs)#server 203.0.113.127
```

---

## show aaa authentication

Use this command to display AAA authentication configuration.

### Command Syntax

```
show aaa authentication (|vrf(management|all))
```

### Parameters

None

### Command Modes

Executive mode

### Applicability

This command was introduced before OcNOS version 1.3.

### Examples

```
#show aaa authentication
                        VRF: default
default: local
console: local
```

[Table 18-36](#) explains the output fields.

**Table 18-36: show aaa authentication fields**

Field	Description
VRF	Virtual Routing and Forwarding (VRF) default support.
Default	Displays the aaa authentication method list.
Console	Authentication setting for the console access.

---

## show aaa authentication login

Use this command to display AAA authentication configuration for login default and login console.

### Command Syntax

```
show aaa authentication login error-enable (|vrf management|all)
```

### Parameters

<code>error-enable</code>	Display setting for login failure messages
<code>vrf</code>	Management VRF or all VRFs

### Command Modes

Executive mode

### Applicability

This command was introduced before OcnOS version 1.3.

### Examples

```
#show aaa authentication login error-enable
VRF: default
disabled
```

[Table 18-37](#) explains the output fields.

**Table 18-37: show aaa authentication login error-enable fields**

Field	Description
VRF	Virtual Routing and Forwarding (VRF) default support.

---

## show aaa authorization

Use this command to display AAA authorization configuration.

### Command Syntax

```
show aaa authorization (|vrf(management|all))
```

### Parameters

vrf management	Authorization configs present in Management VRF
vrf all	Authorization configs present in all VRFs

### Command Modes

Executive mode

### Applicability

This command is introduced in OcNOS version 6.1.0.

### Examples

```
#show aaa authorization
VRF: default
default: group tacacs+
```

---

## show aaa groups

Use this command to display AAA group configuration.

### Command Syntax

```
show aaa groups (vrf (management|all)|)
```

### Parameters

vrf                      Management VRF or all VRFs

### Command Modes

Executive mode

### Applicability

This command was introduced before OcnOS version 1.3.

### Examples

```
#show aaa groups
VRF: default
radius
```

[Table 18-38](#) explains the output fields.

**Table 18-38: show aaa groups fields**

Field	Description
VRF	Virtual Routing and Forwarding (VRF) default support.

---

## show aaa accounting

Use this command to display AAA accounting configuration.

### Command Syntax

```
show aaa accounting (vrf (management|all)|)
```

### Parameters

vrf                      Management VRF or all VRFs

### Command Modes

Executive mode

### Applicability

This command was introduced before OcnOS version 1.3.

### Examples

```
#show aaa accounting
      VRF: default
```

[Table 18-39](#) explains the output fields.

**Table 18-39: show aaa accounting fields**

Field	Description
VRF	Virtual Routing and Forwarding (VRF) default support.



---

## show running-config aaa

Use this command to display AAA settings in the running configuration.

### Command Syntax

```
show running-config aaa (vrf(management|all)|)
```

### Parameters

vrf Management VRF or all VRFs

### Command Modes

Executive mode

### Applicability

This command was introduced before OcnOS version 1.3.

### Examples

```
#show aaa accounting
      VRF: default
      default: local
```

[Table 18-40](#) explains the output fields.

**Table 18-40: show aaa accounting fields**

Field	Description
VRF	Virtual Routing and Forwarding (VRF) default support.
Default	Displays the aaa authentication method list.



## CHAPTER 19 Remote Management Commands

This chapter is a reference for commands that copy these types of files:

- Start-up configuration and running configuration
- System files such as boot files, core dumps, and debug logs

You can use these commands to copy files locally or to copy between the local device and a remote system.

The commands in this chapter use the techniques in [Table 19-41](#) to remotely transfer files:

**Table 19-41: File transfer techniques**

Trivial File Transfer Protocol (TFTP)	No authentication or encryption; dangerous to use over the Internet, but might be acceptable in a trusted environment Address format: <code>tftp://server[:port]/path</code>
File Transfer Protocol (FTP)	Authenticates, but does not encrypt Address format: <code>ftp://server/path</code>
Secure copy (SCP)	Authenticates and encrypts using Secure Shell (SSH1) Address format: <code>scp://server/path</code>
SSH File Transfer Protocol (SFTP)	Authenticates and encrypts using Secure Shell (SSH2); this is the most secure technique Address format: <code>sftp://server/path</code>
Hyper text Transfer Protocol (HTTP)	Address format: <code>http://server/path</code> For download of running and startup configurations

This chapter contains these commands.

- [copy running-config](#)
- [copy running-config \(interactive\)](#)
- [copy startup-config](#)
- [copy startup-config \(interactive\)](#)
- [copy system file](#)
- [copy system file \(interactive\)](#)
- [copy ftp startup-config](#)
- [copy scp filepath](#)
- [copy scp startup-config](#)
- [copy sftp startup-config](#)
- [copy tftp startup-config](#)
- [copy http startup-config](#)
- [copy ftp startup-config \(interactive\)](#)
- [copy scp startup-config \(interactive\)](#)
- [copy tftp startup-config \(interactive\)](#)
- [copy http startup-config \(interactive\)](#)
- [copy file startup-config](#)

---

## copy running-config

Use this command to copy the running configuration to an FTP server, an SCP server, an SFTP server, a TFTP server or an HTTP server.

### Command Syntax

```
copy running-config (tftp TFTP-URL|ftp FTP-URL|scp SCP-URL|sftp SFTP-URL|http HTTP-URL) (vrf (NAME|management)|)
```

### Parameters

TFTP-URL	Destination: tftp: [//server[:port]] [/path]
FTP-URL	Destination: ftp: [//server] [/path]
SCP-URL	Destination: scp: [//server] [/path]
SFTP-URL	Destination: sftp: [//server] [/path]
HTTP-URL	Destination: http: [//server] [/path]
NAME	Virtual Routing and Forwarding name
management	Management Virtual Routing and Forwarding

### Command Mode

Privileged Exec mode

### Applicability

This command was introduced before OcNOS version 1.3.

### Examples

```
#copy running-config sftp sftp://sftp.mysite.com/running_conf vrf management
```

---

## copy running-config (interactive)

Use this command to copy the running configuration to an FTP server, an SCP server, an SFTP server, a TFTP server or an HTTP server.

### Command Syntax

```
copy running-config (ftp|tftp|scp|sftp|http) (vrf (NAME|management) |)
```

### Parameters

ftp	Destination: FTP server
tftp	Destination: TFTP server
scp	Destination: SCP server
sftp	Destination: SFTP server
http	Destination: HTTP server
NAME	Virtual Routing and Forwarding name
management	Management Virtual Routing and Forwarding

### Command Mode

Privileged Exec mode

### Applicability

This command was introduced before OcNOS version 1.3.

### Examples

```
#copy running-config sftp vrf management
```

---

## copy startup-config

Use this command to copy the running configuration to an FTP server, an SCP server, an SFTP server, a TFTP server or an HTTP server.

### Command Syntax

```
copy startup-config (tftp TFTP-URL|ftp FTP-URL|scp SCP-URL|sftp SFTP-URL|http
  HTTP_URL) (vrf (NAME|management)|)
```

### Parameters

TFTP-URL	Destination: tftp: [//server[:port]] [/path]
FTP-URL	Destination: ftp: [//server] [/path]
SCP-URL	Destination: scp: [//server] [/path]
SFTP-URL	Destination: sftp: [//server] [/path]
HTTP-URL	Destination: http: [//server] [/path]
NAME	Virtual Routing and Forwarding name
management	Management Virtual Routing and Forwarding

### Command Mode

Privileged Exec mode

### Applicability

This command was introduced before OcNOS version 1.3.

### Examples

```
#copy startup-config sftp sftp://sftp.mysite.com/start-up_conf vrf management
```

---

## copy startup-config (interactive)

Use this command to copy the running configuration to an FTP server, an SCP server, an SFTP server, a TFTP server or an HTTP server.

### Command Syntax

```
copy startup-config (ftp|tftp|scp|sftp|http) (vrf (NAME|management) |)
```

### Parameters

ftp	Destination: FTP server
tftp	Destination: TFTP server
scp	Destination: SCP server
sftp	Destination: SFTP server
http	Destination: HTTP server
NAME	Virtual Routing and Forwarding name
management	Management Virtual Routing and Forwarding

### Command Mode

Privileged Exec mode

### Applicability

This command was introduced before OcnOS version 1.3.

### Examples

```
#copy startup-config sftp vrf management
```

---

## copy system file

Use this command to copy a system file to an FTP server, an SCP server, an SFTP server, or a TFTP server.

Note: The names of the options for the source in the first parameter refer to symbolic locations. The specific locations for Linux are noted below. The locations on a specific device can vary depending on the platform.

### Command Syntax

```
copy (core|debug|log|techsupport|filepath) FILE (tftp TFTP-URL|ftp FTP-URL|scp SCP-URL|sftp SFTP-URL) (vrf (NAME|management)|)
```

### Parameters

core	Core file storage; on Linux this refers to /var/log/crash/cores/
debug	Debug file storage; on Linux this refers to /log/
log	Log file storage; on Linux this refers to /var/log/
techsupport	Copy techsupport log files to remote machine
filepath	Copy device file to remote machine
FILE	Source file name
TFTP-URL	Destination: tftp://server[:port][[/path]
FTP-URL	Destination: ftp://server[/path]
SCP-URL	Destination: scp://server[/path]
SFTP-URL	Destination: sftp://server[/path]
NAME	Virtual Routing and Forwarding name
management	Management Virtual Routing and Forwarding

### Command Mode

Privileged Exec mode

### Applicability

This command was introduced before OcNOS version 1.3.

### Examples

```
#copy core myFile sftp sftp://sftp.mysite.com/dst_filename vrf management

#copy techsupport tech_support_23_Feb_2001_18_27_00.tar.gz scp scp://
10.12.16.17/home/satya7/tech_support_23_Feb_2001_18_27_00.tar.gz vrf management
Enter Username:root
Enter Password:
% Total % Received % Xferd Average Speed Time Time Time Current
Dload Upload Total Spent Left Speed
100 72368 0 0 0 72368 0 147k -:- -:- -:- 147k
100 72368 0 0 0 72368 0 147k -:- -:- -:- 147k
Copy Success
```



---

## copy system file (interactive)

Use this command to copy a system file to an FTP server, an SCP server, an SFTP server, or a TFTP server.

Note: The names of the options for the source in the first parameter refer to symbolic locations. The specific locations for Linux are noted below. The locations on a specific device can vary depending on the platform.

### Command Syntax

```
copy (core|debug|log|techsupport|filepath) FILE (tftp TFTP-URL|ftp FTP-URL|scp SCP-URL|sftp SFTP-URL) (vrf (NAME|management)|)
```

### Parameters

core	Core file storage; on Linux this refers to /var/log/crash/cores/
debug	Debug file storage; on Linux this refers to /log/
log	Log file storage; on Linux this refers to /var/log/
techsupport	Copy techsupport log files to remote machine
filepath	Copy device file to remote machine
FILE	Source file name
TFTP-URL	Destination: tftp://server[:port][[/path]
FTP-URL	Destination: ftp://server[/path]
SCP-URL	Destination: scp://server[/path]
SFTP-URL	Destination: sftp://server[/path]
ftp	Destination: FTP server
tftp	Destination: TFTP server
scp	Destination: SCP server
sftp	Destination: SFTP server
NAME	Virtual Routing and Forwarding name
management	Management Virtual Routing and Forwarding

### Command Mode

Privileged Exec mode

### Applicability

This command was introduced before OcNOS version 1.3.

### Examples

```
#copy log myFile sftp sftp://sftp.mysite.com/dst_filename vrf management
```

---

## copy ftp startup-config

Use this command to copy the start up configuration from an FTP server to the local device.

### Command Syntax

```
copy ftp FTP-URL startup-config (vrf (NAME|management) |)
```

### Parameters

FTP-URL	Configuration source: ftp: [//server] [/path]
NAME	Virtual Routing and Forwarding name
management	Management Virtual Routing and Forwarding

### Command Mode

Privileged Exec mode

### Applicability

This command was introduced before OcnOS version 1.3.

### Examples

```
#copy ftp ftp://ftp.mysite.com/scr filename startup-config vrf management
```

---

## copy scp filepath

Use this command to copy the remote system file using SCP to the local device.

**Note:** OcNOS has a dedicated partition called `/cfg` for storing system level configurations, OcNOS configurations and license data. This is persistent across reboots and upgrades and consists of directories `/cfg/` and `/usr/local/etc`. Copying `user/general` files under `/cfg` partition is discouraged because the size of this partition is very small and impacts normal system operations like `bootup/upgrades` and important system files copy when it doesn't have enough space. Users are recommended to use `/home` to copy the general files. Please note that the contents placed in `/home` directory are deleted upon software upgrade.

### Command Syntax

```
copy scp SCP-URL (filepath FILEPATH) (vrf (NAME|management)|)
```

### Parameters

SCP-URL	Configuration source: <code>scp://server[/path]</code>
FILEPATH	Enter the local filesystem path with filename
NAME	Virtual Routing and Forwarding name
management	Management Virtual Routing and Forwarding

### Command Mode

Privileged Exec mode

### Applicability

This command was introduced before OcNOS version 3.0.

### Examples

```
#copy scp scp://10.12.65.89/root/cmlsh filepath /root/cmlsh vrf management
```

---

## copy scp startup-config

Use this command to copy the start up configuration from a SCP server to the local device.

### Command Syntax

```
copy scp SCP-URL startup-config (vrf (NAME|management) |)
```

### Parameters

SCP-URL	Configuration source: scp: [//server] [/path]
NAME	Virtual Routing and Forwarding name
management	Management Virtual Routing and Forwarding

### Command Mode

Privileged Exec mode

### Applicability

This command was introduced before OcnOS version 1.3.

### Examples

```
#copy scp scp://scp.mysite.com/scr filename startup-config vrf management
```

---

## copy sftp startup-config

Use this command to copy the start up configuration from a SFTP server to the local device.

### Command Syntax

```
copy sftp SFTP-URL startup-config (vrf (NAME|management)|)
```

### Parameters

SFTP-URL	Configuration source: sftp:[//server] [/path]
NAME	Virtual Routing and Forwarding name
management	Management Virtual Routing and Forwarding

### Command Mode

Privileged Exec mode

### Applicability

This command was introduced before OcnOS version 1.3.

### Examples

```
#copy sftp sftp://sftp.mysite.com/scr filename startup-config vrf management
```

---

## copy tftp startup-config

Use this command to copy the start up configuration from a TFTP server to the local device.

### Command Syntax

```
copy tftp TFTP-URL startup-config (vrf (NAME|management) |)
```

### Parameters

TFTP-URL	Configuration source: tftp:[//server] [/path]
NAME	Virtual Routing and Forwarding name
management	Management Virtual Routing and Forwarding

### Command Mode

Privileged Exec mode

### Applicability

This command was introduced before OcnOS version 1.3.

### Examples

```
#copy tftp tftp://tftp.mysite.com/scr filename startup-config vrf management
```

---

## copy http startup-config

Use this command to copy the start up configuration from an HTTP server to the local device.

### Command Syntax

```
copy http HTTP-URL startup-config (vrf (NAME|management) |)
```

### Parameters

HTTP-URL	Configuration source: http: [//server] [/path]
NAME	Virtual Routing and Forwarding name
management	Management Virtual Routing and Forwarding

### Command Mode

Privileged Exec mode

### Applicability

This command was introduced before OcnOS version 1.3.

### Examples

```
#copy http http://http.mysite.com/scr filename startup-config vrf management
```

---

## copy ftp startup-config (interactive)

Use this command to copy the start up configuration from an FTP server to the local device.

### Command Syntax

```
copy ftp startup-config (vrf (NAME|management))
```

### Parameters

NAME	Virtual Routing and Forwarding name
management	Management Virtual Routing and Forwarding

### Command Mode

Privileged Exec mode

### Applicability

This command was introduced before OcNOS version 1.3.

### Examples

```
#copy ftp startup-config vrf management
```



---

## copy scp startup-config (interactive)

Use this command to copy the start up configuration from a SCP server to the local device.

### Command Syntax

```
copy scp startup-config (vrf (NAME|management)|)
```

### Parameters

NAME	Virtual Routing and Forwarding name
management	Management Virtual Routing and Forwarding

### Command Mode

Privileged Exec mode

### Applicability

This command was introduced before OcnOS version 1.3.

### Examples

```
#copy scp startup-config vrf management
```

---

## copy sftp startup-config (interactive)

Use this command to copy the start up configuration from an SFTP server to the local device.

### Command Syntax

```
copy sftp startup-config (vrf (NAME|management) |)
```

### Parameters

NAME	Virtual Routing and Forwarding name
management	Management Virtual Routing and Forwarding

### Command Mode

Privileged Exec mode

### Applicability

This command was introduced before OcNOS version 1.3.

### Examples

```
#copy sftp startup-config vrf management
```

---

## copy tftp startup-config (interactive)

Use this command to copy the start-up configuration from a TFTP server to the local device.

### Command Syntax

```
copy tftp startup-config (vrf (NAME|management) |)
```

### Parameters

NAME	Virtual Routing and Forwarding name
management	Management Virtual Routing and Forwarding

### Command Mode

Privileged Exec mode

### Applicability

This command was introduced before OcnOS version 1.3.

### Examples

```
#copy tftp startup-config vrf management
```

---

## copy http startup-config (interactive)

Use this command to copy the start-up configuration from an HTTP server to the local device.

### Command Syntax

```
copy http startup-config (vrf (NAME|management) |)
```

### Parameters

NAME	Virtual Routing and Forwarding name
management	Management Virtual Routing and Forwarding

### Command Mode

Privileged Exec mode

### Applicability

This command was introduced before OcNOS version 1.3.

### Examples

```
#copy http startup-config vrf management
```

---

## copy file startup-config

Use this command to copy and store a local file into the startup configuration.

### Command Syntax

```
copy file FILE startup-config
```

### Parameters

FILE	File name
------	-----------

### Command Mode

Privileged Exec mode

### Applicability

This command was introduced before OcnOS version 1.3.

### Examples

```
#copy file myFile startup-config
```



## CHAPTER 20 Software Monitoring and Reporting

---

This document describes software watchdog and reporting related commands.

- [clear cores](#)
- [copy core](#)
- [copy techsupport](#)
- [feature software-watchdog](#)
- [show bootup-parameters](#)
- [show cores](#)
- [show running-config watchdog](#)
- [show software-watchdog status](#)
- [show system log](#)
- [show system login](#)
- [show system reboot-history](#)
- [show system resources](#)
- [show system uptime](#)
- [show techsupport](#)
- [show techsupport status](#)
- [software-watchdog](#)
- [software-watchdog keep-alive-time](#)

---

## clear cores

Use this clear command to delete the core files present in /var/log/crash/cores

### Syntax

```
clear cores (|WORD)
```

### Parameters

WORD	Core file name
------	----------------

### Default

NA

### Command Mode

Executive Mode

### Applicability

This command was introduced before OcNOS version 1.3.

### Example

```
#show cores
Core location :/var/log/crash/cores
Core-File-Name
-----
core_hostpd.9581_20190324_222313_signal_11.gz
#clear cores core_hostpd.9581_20190324_222313_signal_11.gz
#show cores
Core location :/var/log/crash/cores
Core-File-Name
-----
#
```



## copy core

Use this command to copy the core file to another file.

The core filename is in the form: core\_PROCESSNAME.PROCID\_YYMMDD\_HHMMSS\_signal\_SIGNALNUM.gz

### Command Syntax

```
copy core FILE (tftp TFTP-URL|ftp FTP-URL|scp SCP-URL|sftp SFTP-URL) (vrf
(NAME|management) |)
```

### Parameters

core	Copy Crash core files to remote location. Core file location: /var/log/crash/cores/
FILE	Source file name
TFTP-URL	Destination: tftp://server[:port][/path]
FTP-URL	Destination: ftp://server[/path]
SCP-URL	Destination: scp://server[/path]
SFTP-URL	Destination: sftp://server[/path]
NAME	Virtual Routing and Forwarding name
management	Management Virtual Routing and Forwarding

### Default

NA

### Command Mode

Privileged EXEC

### Applicability

This command was introduced before OcNOS version 1.3.

### Example

```
# copy core core_hostpd.9581_20190324_222313_signal_11.gz scp scp://10.12.16.17/home/
core core_hostpd.9581_20190324_222313_signal_11.gz vrf management
Enter Username:root
Enter Password:
  % Total      % Received % Xferd   Average Speed   Time    Time       Time  Current
                               Dload  Upload    Total     Spent    Left     Speed
100 681k    0      0    0 681k       0 3588k  --:--:--  --:--:--  --:--:-- 3588k
100 681k    0      0    0 681k       0 3588k  --:--:--  --:--:--  --:--:-- 3588k
Copy Success
```

---

## copy techsupport

Use this command to copy the contents of a compressed techsupport file (`tar.gz`) to another file.

The default filename is in the form: `tech_support_YYYY MMM_DD_HH_MM_SS.tar.gz`.

### Command Syntax

```
copy (log|techsupport) FILE (tftp TFTP-URL|ftp FTP-URL|scp SCP-URL|sftp SFTP-URL)
(vrf (NAME|management)|)
```

### Parameters

log	Log file storage; on Linux this refers to <code>/var/log/</code>
techsupport	Tech support file storage; on Linux this refers to <code>/var/log/</code>
FILE	Source file name
TFTP-URL	Destination: <code>tftp://server[:port][[/path]</code>
FTP-URL	Destination: <code>ftp://server[/path]</code>
SCP-URL	Destination: <code>scp://server[/path]</code>
SFTP-URL	Destination: <code>sftp://server[/path]</code>
NAME	Virtual Routing and Forwarding name
management	Management Virtual Routing and Forwarding

### Default

NA

### Command Mode

Privileged EXEC

### Applicability

This command was introduced before OcNOS version 1.3.

### Example

```
#copy techsupport tech_support_23_Feb_2019_18_27_00.tar.gz scp scp://10.12.16.17/home/
tech_support_23_Feb_2019_18_27_00.tar.gz vrf management
```

```
Enter Username:root
Enter Password:
% Total % Received % Xferd Average Speed Time Time Time Current
Dload Upload Total Spent Left Speed
100 72368 0 0 0 72368 0 147k --:-- --:-- --:-- 147k
100 72368 0 0 0 72368 0 147k --:-- --:-- --:-- 147k
Copy Success
#
```

---

## feature software-watchdog

Use this command to enable software watchdog functionality for all OcNOS modules. This feature is enabled by default.

Use the `no` form of this command to disable software watchdog functionality.

### Command Syntax

```
feature software-watchdog
no feature software-watchdog
```

### Parameter

None

### Default

By default, software watchdog is enabled.

### Command Mode

Configure mode

### Applicability

This command was introduced before OcNOS version 1.3.

### Examples

```
#configure terminal
#(config)feature software-watchdog
```

---

## show bootup-parameters

Use this command to show OcNOS kernel bootup parameters.

### Command Syntax

```
show bootup-parameters
```

### Parameter

None

### Command Mode

Execution mode

### Applicability

This command was introduced before OcNOS version 1.3.

### Examples

```
#show bootup-parameters  
BOOT_IMAGE=/boot/vmlinuz-3.16.7-g490411a-ec-as7712-32x root=UUID=317567fc-  
b69e-4
```

```
5d9-ab4e-fa1d9e57b
```

```
703 console=ttyS1,115200n8 ro
```

---

## show cores

Use this command to list core files in the system or to display information about a given core file.

Note: When cmlsh logged in via non-root user crashes, core files will not get generated. User can further debug the issue based on CLI-history and logs from /var/log/messages.

### Command Syntax

```
show cores (|WORD details)
```

### Parameter

WORD	Core file name
------	----------------

### Command Mode

Execution mode

### Applicability

This command was introduced before OcNOS version 1.3.

### Examples

```
#sh cores
Core location :/var/log/crash/cores
Core-File-Name
-----
core_nsm.683_20191110_103611_signal_5.gz
core_nsm.712_20191107_171803_signal_11.gz
core_nsm.684_20191112_054937_signal_5.gz
core_yangcli.5695_20191107_171715_signal_11.gz
#
```

[Table 20-42](#) explains the output fields.

**Table 20-42: show cores fields**

Entry	Description
Core-File-Name	Core dump file name.

---

## show running-config watchdog

Use this command to display watchdog configurations.

### Command Syntax

```
show running-config watchdog
```

### Parameters

None

### Command Mode

Privileged EXEC

### Applicability

This command was introduced in OcNOS version 5.0.

### Example

```
#sh running-config watchdog
software-watchdog keep-alive-time 300
```

---

## show software-watchdog status

Use this command to display the software watchdog status for each OcNOS module.

### Command Syntax

```
show software-watchdog status
show software-watchdog status detail
```

### Parameter

None

### Command Mode

Execution mode

### Applicability

This command was introduced before OcNOS version 1.3 and updated in OcNOS version 1.3.4.

### Examples

```
#show software-watchdog status
Software Watchdog timeout in seconds : 60
Process name           Watchdog status
=====
nsm                    Enabled
ripd                  Enabled
ripngd                Enabled
ospfd                 Enabled
ospf6d                Enabled
isis                  Enabled
hostpd                Enabled
ldpd                  Enabled
rsvpd                 Enabled
mribd                 Enabled
pimd                  Enabled
authd                 Enabled
mstpd                 Enabled
imi                   Enabled
onmd                  Enabled
HSL                   Enabled
oamd                  Enabled
vlogd                 Enabled
vrrpd                 Enabled
ndd                   Enabled
ribd                  Enabled
bgpd                  Enabled
l2mribd               Enabled
lagd                  Enabled
sflow                 Enabled
```

## Software Monitoring and Reporting

---

```
udld          Enabled
cmld          Enabled
cmmd          Enabled
pcep         Enabled
```

```
#show software-watchdog status detail
Software Watchdog timeout in seconds : 60
```

Process Name	Watchdog Status	Process Status	Disconnect Count	Connect Count	Last Restart Reason
nsm	Enabled	Running	0	1	Fresh bootup
ripd	Enabled	Running	0	1	Fresh bootup
ripngd	Enabled	Running	0	1	Fresh bootup
ospfd	Enabled	Running	0	1	Fresh bootup
ospf6d	Enabled	Running	0	1	Fresh bootup
isisd	Enabled	Running	0	1	Fresh bootup
hostpd	Enabled	Running	3	4	Segmentation fault
ldpd	Enabled	Running	0	1	Fresh bootup
rsvdp	Enabled	Running	0	1	Fresh bootup
mribd	Enabled	Running	0	1	Fresh bootup
pimd	Enabled	Running	0	1	Fresh bootup
authd	Enabled	Running	0	1	Fresh bootup
mstpd	Enabled	Running	0	1	Fresh bootup
imi	Enabled	Running	0	1	Fresh bootup
onmd	Enabled	Running	0	1	Fresh bootup
HSL	Enabled	Running	0	1	Fresh bootup
oamd	Enabled	Running	0	1	Fresh bootup
vlogd	Enabled	Running	0	1	Fresh bootup
vrrpd	Enabled	Running	0	1	Fresh bootup
ndd	Enabled	Running	0	1	Fresh bootup
ribd	Enabled	Running	0	1	Fresh bootup
bgpd	Enabled	Running	0	1	Fresh bootup
l2mribd	Enabled	Running	0	1	Fresh bootup
lagd	Enabled	Running	0	1	Fresh bootup
sflow	Enabled	Running	0	1	Fresh bootup
udld	Enabled	Running	0	1	Fresh bootup
cmld	Enabled	Running	0	1	Fresh bootup
cmmd	Enabled	Running	0	1	Fresh bootup
pcep	Enabled	Running	0	1	Fresh bootup

#



---

Table 20-43 explains the output fields.

**Table 20-43: show software-watchdog status output fields**

<b>Field</b>	<b>Description</b>
Process Name	The name of a protocol module.
Watchdog Status	Status of a protocol module (Enabled or Disabled).
Process Status	Status of the protocol module Running/Not-running).
Disconnect Count	Number of times the protocol module disconnected from monitoring module.
Connect Count	Number of times the protocol module connected to monitoring module.
Last Restart Reason	Reason why a module disconnected from monitoring module.

## show system log

Use this command to display the system's log file.

### Command Syntax

```
show system log
```

### Parameters

None

### Command Mode

Execution mode

### Applicability

This command was introduced before OcNOS version 1.3.

### Example

```
#show system log
Syslog           : enabled           File Name       : /var/log/messages
Oct 18 18:10:18 localhost rsyslogd: [origin software="rsyslogd"
swVersion="8.4.2
" x-pid="541" x-info="http://www.rsyslog.com"] start
Oct 18 18:10:18 localhost systemd[1]: Started Apply Kernel Variables.
Oct 18 18:10:18 localhost systemd[1]: Started Create Static Device Nodes in /
dev
.
Oct 18 18:10:18 localhost systemd[1]: Starting udev Kernel Device Manager...
Oct 18 18:10:18 localhost systemd[1]: Started udev Kernel Device Manager.
Oct 18 18:10:18 localhost systemd[1]: Starting Copy rules generated while the
ro
ot was ro...
Oct 18 18:10:18 localhost systemd[1]: Starting LSB: Set preliminary keymap...
Oct 18 18:10:18 localhost systemd[1]: Started Copy rules generated while the
roo
t was ro.
Oct 18 18:10:18 localhost nfs-common[163]: Starting NFS common utilities:.
Oct 18 18:10:18 localhost systemd[1]: Found device /dev/ttyS0.
Oct 18 18:10:18 localhost systemd[1]: Found device 16GB_SATA_Flash_Drive
OcNOS-CONFIG.
Oct 18 18:10:18 localhost systemd[1]: Starting File System Check on /dev/disk/
by
-label/OcNOS-CONFIG...
Oct 18 18:10:18 localhost systemd[1]: Starting system-ifup.slice.
Oct 18 18:10:18 localhost systemd-fsck[217]: OcNOS-CONFIG: clean, 85/128016
file
s, 27057/512000 blocks
Oct 18 18:10:18 localhost systemd[1]: Created slice system-ifup.slice.
--More--
```

[Table 20-44](#) explains the output fields.

**Table 20-44: show system log fields**

<b>Entry</b>	<b>Description</b>
Syslog	Status of the protocol (enabled or disabled).
File Name	Specifies the name of the system log files that you configured.

---

## show system login

Use this command to display the system's login history.

### Command Syntax

```
show system login
```

### Parameters

None

### Command Mode

Execution mode

### Applicability

This command was introduced before OcNOS version 1.3.

### Example

```
#show system login
eric      ttyS0      Wed Oct 19 18:31    still logged in
takayuki  ttyS0      Wed Oct 19 18:14 - 18:25    (00:10)
girish    ttyS0      Wed Oct 19 16:46 - 17:01    (00:14)
```

```
wtmp begins Wed Oct 19 16:46:18 2016
```

---

## show system reboot-history

Use this command to show the device reboot history.

### Command Syntax

```
show system reboot-history
```

### Parameters

None

### Command Mode

Execution mode

### Applicability

This command was introduced before OcNOS version 1.3

### Examples

```
#show system reboot-history
DATE-TIME                REBOOT-REASON
-----
Thu Oct 07 12:46:56 2021  Sys-update from NOS shell
Wed Oct 13 09:35:06 2021  Reload from NOS shell
Sat Feb 16 23:19:38 2019  Reload from NOS shell
```

---

## show system resources

Use this command to display the system's current resources.

### Command Syntax

```
show system resources (iteration <1-5>|)
```

### Parameters

<1-5>                    The number of times to check the resources before they are displayed.

### Command Mode

Execution mode

### Applicability

This command was introduced before OcNOS version 1.3.

### Examples

```
DELL-6K3#show system resources
load average: 0.12, 0.22, 0.20
Tasks: 173 total,   1 running, 172 sleeping,   0 stopped,   0 zombie
%Cpu(s):  3.1 us,  1.6 sy,   0.0 ni, 95.3 id,   0.0 wa,   0.0 hi,   0.0 si,   0.0
st
MiB Mem : 15930.2 total, 14277.8 free,   1003.0 used,   649.4 buff/cache

           0 used,           0 free. 252416 cached Mem
```

[Table 20-45](#) explains the output fields.

**Table 20-45: show system resource fields**

Entry	Description
Load Average	Number of processes that are running. The average reflects the system load the past 1, 5, and 15 minutes.
Tasks	Number of processes in the system and how many processes are actually running when the command is issued.
CPU	Displays the CPU utilization information for processes on the device.

**Table 20-45: show system resource fields**

Entry	Description
KiB Mem	<p>The memory field (Mem) shows the virtual memory used by processes. The value in the memory field is in KB and MB, and is broken down as follows:</p> <p>Total: The total amount of available virtual memory, in kibibytes (KiBs).</p> <p>Used: The total amount of used virtual memory, in kibibytes (KiBs).</p> <p>Free: The total amount of free virtual memory, in kibibytes (KiBs)</p> <p>Buffers: The size of the memory buffer used to hold data recently called from disk.</p>
KiB Swap	<p>The Swap field shows the total swap space available and how much is unused and is broken down as follows:</p> <p>Total: The total amount of available swap memory, in kibibytes (KiBs).</p> <p>Used: The total amount of used swap memory, in kibibytes (KiBs).</p> <p>Free: The total amount of free swap memory, in kibibytes (KiBs).</p> <p>Cache Memory: Memory that is not associated with any program and does not need to be swapped before being reused.</p>

---

## show system uptime

Use this command to display how long the system has been up and running.

### Command Syntax

```
show system uptime
```

### Parameters

None

### Command Mode

Execution mode

### Applicability

This command was introduced before OcnOS version 1.3.

### Examples

```
DELL-6K3#show system uptime
19:10:22 up 1 day, 1:01, 1 user, load average: 0.08, 0.05, 0.05
```

[Table 20-46](#) explains the output fields.

**Table 20-46: show system uptime fields**

Entry	Description
Time and up	Current time, in the local time zone, and how long the router or switch has been operational.
Users	Number of users logged in to the router or switch.
Load Average	Number of processes that are running. The average reflects the system load the past 1, 5, and 15 minutes.



---

## show techsupport

Use this command to collect system data for technical support.

### Command Syntax

```
show techsupport
  ({all|authd|bgp|cmmd|hostpd|hsl|imi|isis|l2mribd|lag|ldp|mribd|mstp|nd|nsm|oam|onm|ospf|ospf6|pcep|pim|ptp|rib|rip|ripng|rsvp|sflow|synce|vrrp})
```

### Parameters

all	ALL Related Information
authd	AUTHD Related Information
bgp	BGP Related Information
cmmd	CMMD Related Information
hostpd	HOSTP Related Information
hsl	HSL Related Information
imi	IMI Related Information
isis	ISIS Related Information
l2mribd	L2MRIB Related Information
lag	LAG/LACP Related Information
ldp	LDP Related Information
mribd	MRIB Related Information
mstp	MSTP Related Information
nd	NDD Related Information
nsm	NSM Related Information
oam	BFD Related Information
onm	ONM/LLDP Related Information
ospf	OSPF Related Information
ospf6	OSPF6 Related Information
pcep	PCEP Related Information
pim	PIM Related Information
ptp	PTP Related Information
rib	RIB Related Information
rip	RIP Related Information
ripng	RIPNG Related Information
rsvp	RSVP Related Information
sflow	SFLOW Related Information
synce	SYNCE Related Information
vrrp	VRRP Related Information

## Default

The default file path for show techsupport is /var/log/.

## Command Mode

Privileged EXEC

## Applicability

This command was introduced before OcNOS version 1.3.

## Example

```
#show techsupport all
#show techsupport bgp
#show techsupport bgp isis
```

---

## show techsupport status

Use this cli to view the status of `show techsupport` CLI to generate techsupport archive.

### Command Syntax

```
show techsupport status
```

### Parameters

None

### Command Mode

Privileged EXEC

### Applicability

This command was introduced before OcNOS version 4.2.

### Example

```
#show techsupport status
Tech Support Command Execution Is Complete
##Generated Tech Support File-list
/var/log/OcNOS_tech_support_18_Jun_2021_10_01_38.tar.gz
Tar File is generated at /var/log and file name begins with
'OcNOS_tech_support'
```

---

## software-watchdog

Use this command to enable the software watchdog feature for an OcnOS module.

Use the `no` form of this command to disable the software watchdog feature.

### Command Syntax

```
software-watchdog (nsm|authd|bgpd|cmlld|hostpd|imi|isisd|lagd|l2mribd|  
mstpd|mrribd|ndd|oamd|onmd|ospfd|ospf6d|pimd|ribd|ripd|ripngd|sflow|vlogd|vrrpd|  
ldpd|rsvpd|udld|hsl|cmmd|pcepd|ptpd|syncd)
```

```
no software-watchdog (nsm|authd|bgpd|cmlld|hostpd|imi|isisd|lagd|l2mribd|  
mstpd|mrribd|ndd|oamd|onmd|ospfd|ospf6d|pimd|ribd|ripd|ripngd|sflow|vlogd|vrrpd|  
ldpd|rsvpd|udld|hsl|cmmd|pcepd|ptpd|syncd)
```

### Parameters

<code>authd</code>	Software watchdog for AUTH module
<code>bgpd</code>	Software watchdog for BGP module
<code>cmlld</code>	Software watchdog for CML module
<code>cmmd</code>	Software watchdog for CMM module
<code>hostpd</code>	Software watchdog for HOSTP module
<code>hsl</code>	Software watchdog for HSL module
<code>imi</code>	Software watchdog for IMI module
<code>isisd</code>	Software watchdog for ISIS module
<code>l2mribd</code>	Software watchdog for L2MRIB module
<code>lagd</code>	Software watchdog for LAG module
<code>ldpd</code>	Software watchdog for LDP module
<code>mrribd</code>	Software watchdog for MRIB module
<code>mstpd</code>	Software watchdog for MSTP module
<code>ndd</code>	Software watchdog for NDD module
<code>nsm</code>	Software watchdog for NSM module
<code>oamd</code>	Software watchdog for OAM module
<code>onmd</code>	Software watchdog for ONM module
<code>ospf6d</code>	Software watchdog for OSPF6 module
<code>ospfd</code>	Software watchdog for OSPF module
<code>pcepd</code>	Software watchdog for PCEP module
<code>pimd</code>	Software watchdog for PIM module
<code>ptpd</code>	Software watchdog for PTP module

ribd	Software watchdog for RIB module
ripd	Software watchdog for RIP module
ripngd	Software watchdog for RIPNG module
rsvpd	Software watchdog for RSVP module
sflow	Software watchdog for SFLOW module
syncd	Software watchdog for SYNCE module
udld	Software watchdog for UDLD module
vlogd	Software watchdog for VLOG module
vrrpd	Software watchdog for VRRP module

**Default**

By default, software watchdog is enabled.

**Command Mode**

Configure mode

**Applicability**

This command was introduced before OcnOS version 1.3.

**Examples**

```
#configure terminal
#(config)no software-watchdog imi
#(config)software-watchdog nsm
```

---

## software-watchdog keep-alive-time

Use this command to set the software watchdog keep-alive time interval in seconds. The default keep-alive time interval is 60 seconds.

Use the `no` form of this command to set default keep-alive time interval.

### Command Syntax

```
software-watchdog keep-alive-time <30-1800>  
no software-watchdog keep-alive-time
```

### Parameters

<30-1800>      Keep-alive time interval in seconds

### Default

By default, software watchdog is enabled and the keep-alive time interval is 60 seconds.

### Command Mode

Configure mode

### Applicability

This command was introduced before OcNOS version 1.3.

### Examples

```
#configure terminal  
#(config)software-watchdog keep-alive-time 100
```

---

## CHAPTER 21 Interface Commands

---

This chapter is a reference for each of the interface commands.

- `admin-group`
- `bandwidth`
- `bandwidth-measurement static uni-available-bandwidth`
- `bandwidth-measurement static uni-residual-bandwidth`
- `bandwidth-measurement static uni-utilized-bandwidth`
- `clear hardware-discard-counters`
- `clear interface counters`
- `clear interface cpu counters`
- `clear interface fec`
- `clear ip prefix-list`
- `clear ipv6 neighbors`
- `clear ipv6 prefix-list`
- `debounce-time`
- `delay-measurement dynamic twamp`
- `delay-measurement a-bit-min-max-delay-threshold`
- `delay-measurement static`
- `delay-measurement a-bit-delay-threshold`
- `description`
- `duplex`
- `fec`
- `flowcontrol`
- `hardware-profile port-config`
- `hardware-profile portmode`
- `if-arbiter`
- `interface`
- `ip address A.B.C.D/M`
- `ip address dhcp`
- `ip forwarding`
- `ip prefix-list`
- `ip proxy-arp`
- `ip remote-address`
- `ip unnumbered`
- `ip vrf forwarding`
- `ipv6 address`
- `ipv6 forwarding`

- `ipv6 prefix-list`
- `ipv6 unnumbered`
- `link-debounce-time`
- `load interval`
- `loopback`
- `loss-measurement dynamic`
- `loss-measurement uni-link-loss`
- `monitor speed`
- `monitor queue-drops`
- `monitor speed threshold`
- `mtu`
- `multicast`
- `show flowcontrol`
- `show hardware-discard-counters`
- `show interface`
- `show interface capabilities`
- `show interface counters`
- `show interface counters drop-stats`
- `show interface counters error-stats`
- `show interface counters (indiscard-stats|outdiscard-stats)`
- `show interface counters protocol`
- `show interface counters queue-drop-stats`
- `show interface counters queue-stats`
- `show interface counters rate`
- `show interface counters speed`
- `show interface counters summary`
- `show interface fec`
- `show ip forwarding`
- `show ip interface`
- `show ip prefix-list`
- `show ip route`
- `show ip vrf`
- `show ipv6 forwarding`
- `show ipv6 interface brief`
- `show ipv6 route`
- `show ipv6 prefix-list`
- `show hosts`
- `show running-config interface`
- `show running-config interface ip`



- `show running-config interface ipv6`
- `show running-config ip`
- `show running-config ipv6`
- `show running-config prefix-list`
- `shutdown`
- `speed`
- `switchport`
- `switchport allowed ethertype`
- `switchport protected`
- `transceiver`
- `poe-enable`

---

## admin-group

Use this command to create an administrative group to be used for links. Each link can be a member of one or more, or no administrative groups.

When used in the interface mode, this command adds a link between an interface and a group. The name is the name of the group previously configured. There can be multiple groups per interface. The group is created in configure mode, then interfaces are added to the group in interface mode.

Use the `no` parameter with this command to disable this command.

### Command Syntax

```
admin-group NAME
no admin-group NAME
```

### Parameters

NAME	Name of the admin group to add.
------	---------------------------------

### Default

No default value is specified

### Command Mode

Interface mode

### Applicability

This command was introduced before OcNOS version 1.3.

### Example

In the following example, the `eth3` interface is added to the group `myGroup`:

```
#configure terminal
(config)#interface eth3
(config-if)#admin-group myGroup
```

---

## bandwidth

Use this command to specify a discrete, maximum bandwidth value for the interface.

Use the `no` parameter resets the interface's bandwidth to the default value.

### Command Syntax

```
bandwidth BANDWIDTH
no bandwidth
```

### Parameter

BANDWIDTH	<1-999>k for 1 to 999 kilobits/s
	<1-999>m for 1 to 999 megabits/s
	<1-100>g for 1 to 100 gigabits/s

### Default

Default bandwidth will be default speed of the interface. For LAG, default bandwidth will be collective bandwidth of its member ports. For VLAN interface, default bandwidth is 1 gigabits/sec.

### Command Mode

Interface mode

### Applicability

This command was introduced before OcnOS version 1.3.

### Example

```
#configure terminal
(config)#interface xe4
(config-if)#bandwidth 100m
```

---

## bandwidth-measurement static uni-available-bandwidth

Use this command to advertise the available bandwidth between two directly connected OSPF/ISIS neighbors.

Use the `no` parameter with this command to unset available bandwidth on the current interface.

### Command Syntax

```
bandwidth-measurement static uni-available-bandwidth BANDWIDTH
no bandwidth-measurement static uni-available-bandwidth
```

### Parameter

BANDWIDTH	<0-999>k for 0 to 999 kilo bits/s
	<0-999>m for 0 to 999 mega bits/s
	<0-100>g for 0 to 100 giga bits/s

### Command Mode

Interface mode

### Applicability

This command was introduced in OcNOS version 5.0.

### Examples

```
(config)#int eth2
(config-if)#bandwidth-measurement static uni-available-bandwidth 10k
(config-if)#commit

(config)#int eth2
(config-if)#no bandwidth-measurement static uni-available-bandwidth
(config-if)#commit
```

---

## bandwidth-measurement static uni-residual-bandwidth

Use this command to advertise the residual bandwidth between two directly connected OSPF/ISIS neighbors.

Use the `no` parameter with this command to unset residual bandwidth on the current interface.

### Command Syntax

```
bandwidth-measurement static uni-residual-bandwidth BANDWIDTH
no bandwidth-measurement static uni-residual-bandwidth
```

### Parameter

BANDWIDTH	<0-999>k for 0 to 999 kilo bits/s
	<0-999>m for 0 to 999 mega bits/s
	<0-100>g for 0 to 100 giga bits/s

### Command Mode

Interface mode

### Applicability

This command was introduced in OcNOS version 5.0.

### Examples

```
(config)#interface ethernet 2
(config-if)#bandwidth-measurement static uni-residual-bandwidth 10g
(config-if)#commit

(config)#interface ethernet 2
(config-if)#no bandwidth-measurement static uni-residual-bandwidth
(config-if)#commit
```

---

## bandwidth-measurement static uni-utilized-bandwidth

Use this command to advertise the utilized bandwidth between two directly connected OSPF/ISIS neighbors.

Use the `no` parameter with this command to unset utilized bandwidth on the current interface.

### Command Syntax

```
bandwidth-measurement static uni-utilized-bandwidth BANDWIDTH
no bandwidth-measurement static uni-utilized-bandwidth
```

### Parameter

BANDWIDTH	<0-999>k for 0 to 999 kilo bits/s
	<0-999>m for 0 to 999 mega bits/s
	<0-100>g for 0 to 100 giga bits/s

### Command Mode

Interface mode

### Applicability

This command was introduced in OcNOS version 5.0.

### Examples

```
(config)#int eth2
(config-if)#bandwidth-measurement static uni-utilized-bandwidth 10m
(config-if)#commit
```

```
(config)#int eth2
(config-if)#no bandwidth-measurement static uni-utilized-bandwidth
(config-if)#commit
```

---

## clear hardware-discard-counters

Use this command to clear device level discard counters.

### Command Syntax

```
clear hardware-discard-counters
```

### Parameters

None

### Command Mode

Exec mode

### Applicability

The command is introduced before OcNOS version 1.3.

### Examples

```
#clear hardware-discard-counters
```

---

## clear interface counters

Use this command to clear the statistics on a specified interface or on all interfaces.

Note: This command is not supported on loopback interfaces or the out-of-band management (OOB) management interface.

### Command Syntax

```
clear interface (IFNAME|) counters
```

### Parameter

IFNAME                    Interface name.

### Command Mode

Exec mode and Privileged Exec mode

### Applicability

This command was introduced before OcNOS version 1.3.

### Example

```
#clear interface xe0 counters
```



---

## clear interface cpu counters

Use this command to clear the CPU queue counters.

### Command Syntax

```
clear interface cpu counters
```

### Parameter

None

### Command Mode

Exec mode and Privileged Exec mode

### Applicability

This command was introduced before OcNOS version 1.3.

### Example

```
#clear interface cpu counters
```

---

## clear interface fec

Use this command to clear FEC (forward error correction) statistics on a specified interface or on all interfaces.

Note: This command is not supported on loop-back interfaces or the out-of-band (OOB) management interface.

### Command Syntax

```
clear interface (IFNAME|) fec
```

### Parameters

IFNAME                      Physical Interface name.

### Default

None

### Command Mode

Exec mode and Privileged exec mode

### Applicability

This command was introduced before OcNOS version 1.3.

### Example

```
#clear interface ce1/1 fec
```

---

## clear ip prefix-list

Use this command to reset the hit count to zero in the prefix-list entries for an IPv4 interface.

### Command Syntax

```
clear ip prefix-list
clear ip prefix-list WORD
clear ip prefix-list WORD A.B.C.D/M
```

### Parameters

WORD	Name of the prefix-list.
A.B.C.D/M	IP prefix and length.

### Command Mode

Exec mode

### Applicability

This command was introduced before OcNOS version 1.3.

### Example

```
#clear ip prefix-list List1
```

---

## clear ipv6 neighbors

Use this command to clear all dynamic IPv6 neighbor entries.

### Command Syntax

```
clear ipv6 neighbors
```

### Parameters

None

### Command Mode

Privileged Exec mode

### Applicability

This command was introduced before OcNOS version 1.3.

### Example

```
#clear ipv6 neighbors
```

---

## clear ipv6 prefix-list

Use this command to reset the hit count to zero in the prefix-list entries for an IPv6 interface.

### Command Syntax

```
clear ipv6 prefix-list
clear ipv6 prefix-list WORD
clear ipv6 prefix-list WORD X:X::X:X/M
```

### Parameters

WORD	Name of the prefix-list.
X:X::X:X/M	IP prefix and length.

### Command Mode

Privileged Exec mode

### Applicability

This command was introduced before OcNOS version 1.3.

### Example

```
#clear ipv6 prefix-list List1
```

## debounce-time

Use this command to set the debounce time for a interface.

The debounce timer avoids frequent updates (churn) to higher layer protocol during interface flapping. If the status of a link changes quickly from up to down and then back to up, the port debounce timer suppresses the link status notification. If the link transitions from up to down, but does not come back up, the port debounce timer delays the link status notification.

Note: Keep the following in mind when using the debounce timer:

- Debounce is not applicable for admin down operations.
- Debounce timer is supported only for physical L2 and L3 interfaces.
- The debounce flap-count refers to the number of flaps Ocnos receives while the debounce timer is running:
  - The flap-count is only updated if the timer is still running and Ocnos receives a link status event for the interface.
  - The flap-count is reset at the subsequent start of the debounce timer.
- Protocol-specific timers such as BFD which depend on the link status should be configured to a minimum of 1.5 times the value of the debounce timer. Otherwise it could affect the protocol states if the debounce timer is still running.

Use the `no` form of this command to turn-off the debounce timer on a interface.

### Command Syntax

```
debounce-time <250-5000>
no debounce-time
```

### Parameters

`<250-5000>`      Timer value in milliseconds.

### Default

By default, disabled.

### Command Mode

Interface mode

### Applicability

This command was introduced in Ocnos version 1.3.8.

### Example

```
#configure terminal
(config)#interface eth1
(config-if)#debounce-time 4000
```

---

## delay-measurement dynamic twamp

This command will start the measurement on the interface by using the "interfaces" profile.

The user should be aware that the IP used as a reflector IP must be a directly connected IP.

In case hostname needs to be used, the user must be sure about the hostnames configured in the network.

In case the user configures the delay-measurement with a certain hostname and then the hostname entry in the DNS changes, the delay-measurement must be unconfigured and configured again for the new configuration to take effect (a clear command would not be sufficient in this situation)

Use the `no` form of this command to stop the delay measurement.

### Command Syntax

```
delay-measurement dynamic twamp reflector-ip (HOSTNAME | X:X::X:X | A.B.C.D)
  (reflector-port <1025-65535>|) (sender-ip (HOSTNAME | X:X::X:X | A.B.C.D)|) (dscp
  WORD|)
no delay-measurement dynamic twamp reflector-ip (HOSTNAME | X:X::X:X | A.B.C.D)
```

### Parameters

<code>twamp</code>	This parameter specifies the protocol to be used to do the measurement. It is the only protocol available in this implementation. The subsequent parameters in this command are specific to the protocol chosen (TWAMP).
<code>reflector-ip</code>	Specify the reflector ip/hostname used to send the TWAMP packets to
HOSTNAME	The hostname of the reflector
X:X::X:X	The ip address of the reflector
A.B.C.D	The ip address of the reflector
<code>reflector-ports</code>	specify the UDP port of the TWAMP reflector
<1025-65535>	The reflector port value
<code>sender-ip</code>	Specify the IP used to send the TWAMP packets from (must be an IP configured on the current interface)
HOSTNAME	The hostname of the reflector
X:X::X:X	The ip address of the reflector
A.B.C.D	The ip address of the reflector
<code>dscp</code>	Specify the dscp value used during this measurement
WORD	The dscp value

### Command Mode

Interface mode

### Applicability

This command was introduced in OcNOS version 5.1.

### Example

```
(config)#
(config)#interface xe7
```

## Interface Commands

---

```
(config-if)#delay-measurement dynamic twamp reflector-ip 23.1.1.2 sender-ip  
23.1.1.1 dscp 24  
(config-if)#commit
```

```
(config-if)#no delay-measurement dynamic twamp reflector-ip 23.1.1.2  
(config-if)#commit
```



---

## delay-measurement a-bit-min-max-delay-threshold

Use this command to advertise the minimum and maximum delay values between two directly connected IS-IS/OSPF neighbors.

The A bit is set when one or more measured values exceed a configured maximum threshold. The A bit is cleared when the measured value falls below its configured reuse threshold.

Use the `no` parameter with this command to unset `a-bit-min-max-delay-threshold` on the current interface.

### Command Syntax

```
delay-measurement a-bit-min-max-delay-threshold min <1-16777215> <1-16777215> max
  <1-16777215> <1-16777215>)
no delay-measurement a-bit-min-max-delay-threshold
```

### Parameter

<code>min</code>	Reuse threshold
<code>&lt;1-16777215&gt;</code>	Reuse threshold value of Min-Delay in microseconds
<code>&lt;1-16777215&gt;</code>	Reuse threshold value of Max-Delay in microseconds
<code>a-bit-threshold</code>	Threshold values to set/clear A-bit
<code>max</code>	Maximum threshold
<code>&lt;1-16777215&gt;</code>	Maximum threshold value of Min-Delay in microseconds
<code>&lt;1-16777215&gt;</code>	Maximum threshold value of Max-Delay in microseconds

### Command Mode

Interface mode

### Applicability

This command was introduced in OcNOS version 5.0.

### Examples

```
#configure terminal
(config)#interface eth1
  (config-if)#delay-measurement a-bit-min-max-delay-threshold min 11 22 max 33
  44
(config-if)#no delay-measurement a-bit-min-max-delay-threshold
```

## delay-measurement static

Use this command to advertise static the minimum and maximum delay values or average link delay variation or average link delay values between two directly connected IS-IS/OSPF neighbors.

Use the `no` parameter with this command to unset `min-max-uni-link-delay`, `uni-delay-variation` and `uni-link-delay static` values on the current interface.

### Command Syntax

```
delay-measurement static (min-max-uni-link-delay <1-16777215> <1-16777215> | uni-  
  delay-variation <0-16777215> | uni-link-delay <1-16777215>)  
no delay-measurement static (min-max-uni-link-delay | uni-delay-variation | uni-  
  link-delay)
```

### Parameter

```
min-max-uni-link-delay Min/Max Unidirectional Link Delay  
  <1-16777215> Minimum Unidirectional Link Delay in microseconds  
  <1-16777215> Maximum Unidirectional Link Delay in microseconds  
uni-delay-variation Unidirectional Delay Variation  
  <0-16777215> Value in microseconds  
uni-link-delay Unidirectional Link Delay  
  <1-16777215> Value in microseconds
```

### Command Mode

Interface mode

### Applicability

This command was introduced in OcnOS version 5.0.

### Examples

```
#configure terminal  
(config)#interface eth1  
(config-if)#delay-measurement uni-delay-variation static 12  
(config-if)#no delay-measurement uni-delay-variation static  
#configure terminal  
(config)#interface eth1  
(config-if)#delay-measurement static uni-link-delay 12  
(config-if)#no delay-measurement static uni-link-delay  
(config-if)#delay-measurement static min-max-uni-link-delay 1 3  
(config-if)#no delay-measurement static min-max-uni-link-delay
```

---

## delay-measurement a-bit-delay-threshold

Use this command to advertise average link delay between two directly connected IS-IS/OSPF neighbors.

a-bit-threshold represents the Anomalous (A) bit. The A bit is set when the static value exceeds its configured maximum threshold. The A bit is cleared when the static value falls below its configured reuse threshold.

Use the `no` parameter with this command to unset uni-link-delay on the current interface.

### Command Syntax

```
delay-measurement a-bit-delay-threshold min <1-16777215> max <1-16777215>))
no delay-measurement a-bit-delay-threshold
```

### Parameter

min	Reuse threshold
<1-16777215>	Reuse threshold value in microseconds
max	Maximum threshold
<1-16777215>	Maximum threshold value in microseconds

### Command Mode

Interface mode

### Applicability

This command was introduced in OcNOS version 5.0.

### Examples

```
#configure terminal
(config)#interface eth1
(config-if)#delay-measurement a-bit-delay-threshold min 11 max 22
(config-if)#no delay-measurement a-bit-delay-threshold
```

---

## description

Use this command to assign an description to an interface.

Use the `no` parameter to remove an interface description.

### Command Syntax

```
description LINE
no description
```

### Parameter

`LINE` Interface description. Avoid the special characters “?”, “,”, “>”, “[”, and “=” in the description.

### Default

No default value is specified

### Command Mode

Interface mode

### Applicability

This command was introduced before OcNOS version 1.3.

### Examples

The following example provides information about the connecting router for interface `eth1`.

```
Router#configure terminal
Router(config)#interface eth1
Router(config-if)#description Connected to Zenith's fas2/0
```

## duplex

Use this command to set the duplex mode for each interface.

Use the `no` parameter to remove the duplex mode.

Note: Interface duplex setting is not supported on Management interface `eth0`.

### Command Syntax

```
duplex (half|full)
no duplex
```

### Parameter

<code>half</code>	Half-duplex mode.
<code>full</code>	Full-duplex mode.

### Default

By default, duplex mode is full duplex.

### Command Mode

Interface mode

### Applicability

This command was introduced before OcnOS version 1.3.

### Examples

```
#configure terminal
(config)#interface eth3
(config-if)#duplex full

(config-if)#no duplex
```

## fec

Use this command to force/auto configure forward error correction (FEC) on a physical port.

Use the `no` parameter to enable automatic FEC configuration provisioning based on medium.

### Command Syntax

```
fec (on (c174|c191)|off|auto)
no fec
```

### Parameter

<code>on</code>	Enable FEC.
<code>on c174</code>	Enable Base-R FEC if H/W supports it
<code>on c191</code>	Enable RS-528 FEC if H/W supports it
<code>off</code>	Disable FEC.
<code>auto</code>	Automatically apply FEC for the below transceiver Ethernet compliance codes. Transceiver compliance codes can be fetched via the "show interface controller" command. Also, "fec auto" behavior is the same as no fec. 100G AOC (Active Optical Cable) or 25GAUI C2M AOC 100G ACC (Active Copper Cable) or 25GAUI C2M ACC 100G ACC or 25GAUI C2M ACC 100G AOC or 25GAUI C2M AOC 100GBASE-SR4 or 25GBASE-SR 100G AOC (Active Optical Cable) or 25GAUI C2M AOC

### Default

By default, FEC mode is set to auto.

### Command Mode

Interface mode

### Applicability

This command was introduced before OcNOS version 4.1. The CLI is updated for options `c174|c191` in OcNOS version 6.3.1

### Examples

```
(config)#interface eth3
(config-if)#fec on
(config-if)#fec off
(config-if)#fec auto
(config-if)#fec on c174
(config-if)#fec on c191
```

---

## flowcontrol

Use this command to enable or disable flow control.

Flow control enables connected Ethernet ports to control traffic rates during periods of congestion by allowing congested nodes to pause link operations at the other end. If one port experiences congestion and cannot receive any more traffic, it notifies the other port to stop sending until the condition clears. When a local device detects congestion at its end, it notifies the remote device by sending a pause frame. On receiving a pause frame, the remote device stops sending data packets, which prevents loss of data packets during the period of congestion.

Use the `no` parameter with this command to disable flow control.

### Command Syntax

```
flowcontrol both
flowcontrol send on
flowcontrol send off
flowcontrol receive on
flowcontrol receive off
no flowcontrol
```

### Parameters

<code>both</code>	Specify flow control mode for sending or receiving.
<code>send</code>	Specify flow control mode for sending.
<code>receive</code>	Specify the flow control mode for receiving.
<code>off</code>	Turn off flow control.
<code>on</code>	Turn on flow control.

### Default

The flow control is enabled globally and auto-negotiation is on, flow control is enabled and advertised on 10/100/1000M ports. If auto-negotiation is off or if the port speed was configured manually, flow control is neither negotiated with nor advertised to the peer.

### Command Mode

Interface mode

### Applicability

This command was introduced before OcnOS version 1.3.

### Examples

```
#configure terminal
(config)#interface eth1
(config-if)#flowcontrol receive off

#configure terminal
(config)#interface eth1
(config-if)#flowcontrol receive on
```

## Interface Commands

---

```
(config)#interface eth1  
(config-if)#no flowcontrol
```



---

## hardware-profile port-config

To use the four SFP28 ports UFIS9600-32X model, the new command is being introduced to breakout the first 100G port 0 and initialize the first four SFP28 ports as either 4X1G or 4X10G or 4X25G. By default, port 0 is being used as 100G and the four SFP28 ports are not available to OcNOS, as these ports are inactive in HW

### Command Syntax

```
hardware-profile port-config (mode1 | mode2 |mode3|mode4 )
```

### Parameter

mode1	32X100G	(Default) ALL 100G ports will be present
mode2	4X1G + 31X100G	100G port 0 and initialize the first four SFP ports 4X1G
mode3	4X10G + 31X100G	100G port 0 and initialize the first four SFP+ ports 4X10G
mode4	4X25G + 31X100G	100G port 0 and initialize the first four SFP28 ports 4X25G

### Default

No default value is specified

### Command Mode

Configure mode

### Applicability

This command was introduced before OcNOS version 6.0.0

### Examples

```
OcNOS (config) #hardware-profile port-config ?
  mode1  32X100G (Default)
  mode2  4X1G + 31X100G (ce0 breakout to 4X1G)
  mode3  4X10G + 31X100G (ce0 breakout to 4X10G)
  mode4  4X25G + 31X100G (ce0 breakout to 4X25G)
```

```
OcNOS (config) #hardware-profile port-config mode2
OcNOS (config) #comm
OcNOS (config) #
```

---

## hardware-profile portmode

Use this command to set the global port mode.

### Command Syntax

```
hardware-profile portmode (4X10g|40g)
```

### Parameter

4X10g	Split all the 40G flex ports on the system
40g	Disable splitting on all flex ports and make all ports 40G

### Default

No default value is specified

### Command Mode

Configure mode

### Applicability

This command was introduced before OcNOS version 1.3.

### Examples

```
#configure terminal  
(config)#hardware-profile portmode 40g
```

## if-arbiter

Use this command to discover new interfaces recently added to the kernel and add them to the OcNOS database.

This command starts the arbiter to check interface information periodically. OcNOS dynamically finds any new interfaces added to the kernel. If an interface is loaded dynamically into the kernel when OcNOS is already running, this command polls and updates the kernel information periodically.

Use the `no` parameter with this command to revert to default.

### Command syntax

```
if-arbiter (interval <1-65535>|)
no if-arbiter
```

### Parameter

`interval` Interval (in seconds) after which NSM sends a query to the kernel.

### Default

By default, `if-arbiter` is disabled. When interface-related operations are performed outside of OcNOS (such as when using the `ifconfig` command), enable `if-arbiter` for a transient time to complete synchronization. When synchronization is complete, disable it by giving the `noif-arbiter` command.

### Command Mode

Configure mode

### Applicability

This command was introduced before OcNOS version 1.3.

### Example

```
#configure terminal
(config)#if-arbiter interval 5
```

---

## interface

Use this command to select an interface to configure, and to enter the `Interface` command mode.

Use the `no` parameter with this command to remove this configuration.

### Command Syntax

```
interface IFNAME
no interface IFNAME
```

### Parameter

IFNAME	Name of the interface.
--------	------------------------

### Default

No default value is specified

### Command Mode

Configure mode

### Applicability

This command was introduced before OcNOS version 1.3.

### Example

This example shows the use of this command to enter the `Interface` mode (note the change in the prompt).

```
#configure terminal
(config)#interface eth3
(config-if)#
```

---

## ip address A.B.C.D/M

Use this command to specify that an IP address and prefix length will be used by this interface. If the `secondary` parameter is not specified, this command overwrites the primary IP address. If the `secondary` parameter is specified, this command adds a new IP address to the interface. The secondary address cannot be configured in the absence of a primary IP address. The primary address cannot be removed when a secondary address is present.

Use the `no` parameter with this command to remove the IP address from an interface.

### Command Syntax

```
ip address A.B.C.D/M label LINE
ip address A.B.C.D/M (secondary|)
ip address A.B.C.D/M secondary label LINE
no ip address A.B.C.D/M label LINE
no ip address A.B.C.D/M secondary label LINE
no ip address (A.B.C.D/M (secondary|)|)
```

### Parameters

<code>LINE</code>	Label of this address.
<code>secondary</code>	Make the IP address secondary.

### Default

No default value is specified

### Command Mode

Interface mode

### Applicability

This command was introduced before OcNOS version 1.3.

### Examples

```
(config)#interface eth3
(config-if)#ip address 10.10.10.50/24
(config-if)#ip address 10.10.11.50/24 secondary
```

---

## ip address dhcp

Use this command to specify that a DHCP client will be used to obtain an IP address for an interface.

Use the `no` parameter with this command to remove the IP address from an interface.

### Command Syntax

```
ip address dhcp
no ip address dhcp
```

### Parameters

None

### Default

No default value is specified

### Command Mode

Interface mode

### Applicability

This command was introduced before OcNOS version 1.3.

### Examples

```
(config)#interface eth3
(config-if)#ip address 10.10.10.50/24
(config-if)#ip address 10.10.11.50/24 secondary
(config-if)#ip address dhcp
```

---

## ip forwarding

Use this command to turn on IP forwarding.

Use the `no` parameter with this command to turn off IP forwarding.

### Command Syntax

```
ip forwarding
ip forwarding vrf NAME
no ip forwarding
no ip forwarding vrf NAME
```

### Parameters

NAME	Virtual Routing and Forwarding name
------	-------------------------------------

### Default

No default value is specified

### Command Mode

Configure mode

### Applicability

This command was introduced before OcNOS version 1.3.

### Examples

```
#configure terminal
(config)#ip forwarding
```

## ip prefix-list

Use this command to create an entry for a prefix list.

A router starts to match prefixes from the top of the prefix list and stops whenever a match or deny occurs. To promote efficiency, use the `seq` parameter and place common matches or denials towards the top of the list. The sequence values are generated in the sequence of 5.

Use the parameters `ge` and `le` specify the range of the prefix length to be matched. When setting these parameters, set `le` to be less than 32 and `ge` to be less than `le` value.

Use the `no` parameter with this command to delete the prefix-list entry.

### Command Syntax

```
ip prefix-list WORD
  (deny|permit) (A.B.C.D/M|any)
  (deny|permit) A.B.C.D/M eq <0-32>
  (deny|permit) A.B.C.D/M ge <0-32>
  (deny|permit) A.B.C.D/M ge <0-32> le <0-32>
  (deny|permit) A.B.C.D/M le <0-32>
  (deny|permit) A.B.C.D/M le <0-32> ge <0-32>
  seq <1-4294967295> (deny|permit) (A.B.C.D/M|any)
  seq <1-4294967295> (deny|permit) A.B.C.D/M eq <0-32>
  seq <1-4294967295> (deny|permit) A.B.C.D/M ge <0-32>
  seq <1-4294967295> (deny|permit) A.B.C.D/M ge <0-32> le <0-32>
  seq <1-4294967295> (deny|permit) A.B.C.D/M le <0-32>
  seq <1-4294967295> (deny|permit) A.B.C.D/M le <0-32> ge <0-32>
  description LINE
  no seq <1-4294967295> (deny|permit) (A.B.C.D/M|any)
  no description LINE
  no description
no ip prefix-list WORD
ip prefix-list sequence-number
no ip prefix-list sequence-number
```

### Parameters

WORD	Name of the prefix list.
deny	Reject packets.
permit	Accept packets.
A.B.C.D/M	IP address mask and length of the prefix list mask.
eq	Exact prefix length to be matched
le	Maximum prefix length to be matched
ge	Minimum prefix length to be matched



---

<0-32>	Prefix length to match
<1-4294967295>	Sequence number of the prefix list.
any	Take all packets of any length. This parameter is the same as using 0.0.0.0 le 32 for A.B.C.D/M.
sequence-number	To suppress sequence number generation, give the <code>no ip prefix-list sequence-number</code> command. If you disable the generating sequence numbers, you must specify the sequence number for each entry using the sequence number parameter in the <code>ip prefix-list</code> command.  To enable sequence number generation, give the <code>ip prefix-list sequence-number</code> command.
LINE	Up to 80 characters describing this prefix-list.

**Default**

No default value is specified

**Command Mode**

Configure mode

IP prefix-list mode

**Applicability**

This command was introduced before OcnOS Version SP 4.0.

**Examples**

In this configuration, the `ip prefix-list` command matches all, but denies the IP address range, 76.2.2.0.

```
#conf t
(config)#router bgp 100
(config-router)#network 172.1.1.0
(config-router)#network 172.1.2.0
(config-router)#
(config-router)#neighbor 10.6.5.3 remote-as 300
(config-router)#neighbor 10.6.5.3 prefix-list mylist out
(config-router)#exit
(config)#ip prefix-list mylist
(config-ip-prefix-list)#seq 5 deny 76.2.2.0/24
(config-ip-prefix-list)#seq 10 permit 0.0.0.0/0
```

---

## ip proxy-arp

Use this command to enable the proxy ARP feature on an interface.

Use the `no` parameter to disable the proxy ARP feature on an interface.

### Command Syntax

```
ip proxy-arp
no ip proxy-arp
```

### Parameters

None

### Default

By default, the `ip proxy-arp` is disabled

### Command Mode

Interface mode

### Applicability

This command was introduced before OcNOS version 1.3.

### Example

```
#configure terminal
(config)#interface eth3
(config-if)#ip proxy-arp
```

---

## ip remote-address

Use this command to set the remote address (far end) on a point-to-point non multi-access link. This command can be used only on unnumbered interfaces. When a new remote-address is configured, the old address gets overwritten.

Use the `no` parameter to disable this function.

### Command Syntax

```
ip remote-address A.B.C.D/M
no ip remote-address
```

### Parameter

A.B.C.D/M            IP address and prefix length of the link remote address.

### Default

No default value is specified

### Command Mode

Interface mode

### Applicability

This command was introduced before OcNOS version 1.3.

### Example

```
(config)#interface ppp0
(config-if)#ip unnumbered eth1
(config-if)#ip remote-address 1.1.1.1/32
```

---

## ip unnumbered

Use this command to enable IP processing without an explicit address on a point-to-point non multi-access link. Moreover, this command lets an interface borrow the IP address of a specified interface to enable IP processing on a point-to-point interface without assigning it an explicit IP address. In this way, the IP unnumbered interface can borrow the IP address of another interface already configured on the router to conserve network and address space.

Use the `no` parameter with this command to remove this feature on an interface.

### Command Syntax

```
ip unnumbered IFNAME
no ip unnumbered
```

### Parameter

IFNAME	Interface name.
--------	-----------------

### Default

No default value is specified

### Command Mode

Interface mode

### Applicability

This command was introduced before OcnOS version 1.3.

### Examples

The following example creates a tunnel on `eth1`.

```
(config)#interface lo
(config-if)#ip address 127.0.0.1/8
(config-if)#ip address 33.33.33.33/32 secondary
(config-if)#exit
(config)#interface eth1
(config-if)#ip address 10.10.10.145/24
(config-if)#exit
(config)#interface Tunnel0
(config-if)#tunnel source 10.70.0.145
(config-if)#tunnel destination 10.70.0.77
(config-if)#tunnel ttl 255
(config-if)#tunnel path-mtu-discovery
(config-if)#tunnel mode vxlan
(config-if)#ip unnumbered eth1
(config-if)#exit
(config)#router ospf
(config-router)#network 10.10.10.0/24 area 0
```

---

## ip vrf forwarding

This command associates an interface with a VRF.

Use the `no` parameter with this command to unbind an interface.

**Note:** When you give this command in interface configuration or subinterface configuration mode of the parent VR, the IP address and other attributes of the interface are deleted from the interface. After giving this command, the IP attributes must then be configured in the context of the VRF.

**Note:** The Out Of Band (OOB) management port is part of the “management” VRF. Also, this port cannot be moved out of “management” VRF.

### Command Syntax

```
ip vrf forwarding WORD
no ip vrf forwarding WORD
```

### Parameter

WORD                      Name of the VRF.

### Default

No default value is specified

### Command Mode

Interface mode

### Applicability

This command was introduced before OcNOS version 1.3.

### Example

```
#configure terminal
(config)#ip vrf myVRF
(config-vrf)#exit
(config)#interface eth1
(config-if)#ip vrf forwarding myVRF
```

---

## ipv6 address

Use this command to set the IPv6 address of an interface.

Use the `no` form of this command to disable this function.

Note: This command is also used to configure an IPv6 link-local address for an interface.

### Command Syntax

```
ipv6 address X:X::X:X/M
ipv6 address X:X::X:X/M anycast
no ipv6 address X:X::X:X/M
```

### Parameters

<code>X:X::X:X/M</code>	IP destination prefix and a mask length.
<code>anycast</code>	Make an anycast address which is assigned to a set of interfaces that belong to different devices. A packet sent to an anycast address is delivered to the closest interface (as defined by the routing protocols in use) identified by the anycast address

### Default

No default value is specified

### Command Mode

Interface mode

### Applicability

This command was introduced before OcnOS version 1.3.

### Example

```
#configure terminal
(config)#interface eth3
(config-if)#ipv6 address 3ffe:506::1/64

#configure terminal
(config)#interface eth4
(config-if)#ipv6 address fe80::ab8/64
```

## ipv6 forwarding

Use this command to turn on IPv6 forwarding.

Use the `no` parameter with this command to turn off IPv6 forwarding.

### Command Syntax

```
ipv6 forwarding
ipv6 forwarding vrf NAME
no ipv6 forwarding
no ipv6 forwarding vrf NAME
```

### Parameters

NAME                      Virtual Routing or Forwarding name

### Default

No default value is specified

### Command Mode

Command mode

### Applicability

This command was introduced before OcnOS version 1.3.

### Example

```
#configure terminal
(config)#ipv6 forwarding
```

---

## ipv6 prefix-list

Use this command to create an entry for an ipv6 prefix-list.

Router starts to match prefixes from the top of the prefix list, and stops whenever a match or deny occurs. To promote efficiency, use the `seq` parameter and place common matches or denials towards the top of the list. The sequence values are generated in the sequence of 5.

The parameters `ge` and `le` specify the range of the prefix length to be matched.

Use the `no` parameter with this command to delete the prefix-list entry.

### Command Syntax

```
ipv6 prefix-list WORD
  (deny|permit) (X:X::X:X/M|any)
  (deny|permit) X:X::X:X/M ge <0-128>
  (deny|permit) X:X::X:X/M ge <0-128> le <0-128>
  (deny|permit) X:X::X:X/M le <0-128>
  (deny|permit) X:X::X:X/M le <0-128> ge <0-128>
  seq <1-4294967295> (deny|permit) (X:X::X:X/M|any)
  seq <1-4294967295> (deny|permit) X:X::X:X/M ge <0-128>
  seq <1-4294967295> (deny|permit) X:X::X:X/M ge <0-128> le <0-128>
  seq <1-4294967295> (deny|permit) X:X::X:X/M le <0-128>
  seq <1-4294967295> (deny|permit) X:X::X:X/M le <0-128> ge <0-128>
  description LINE
  no seq <1-4294967295> (deny|permit) (X:X::X:X/M|any)
  no description
no ipv6 prefix-list WORD
ipv6 prefix-list sequence-number
no ipv6 prefix-list sequence-number
```

### Parameters

<code>WORD</code>	Name of the prefix list.
<code>deny</code>	Reject packets.
<code>permit</code>	Accept packets.
<code>X:X::X:X/M</code>	IP address mask and length of the prefix list mask.
<code>any</code>	Take all packets of any length. This is the same as specifying <code>::/0</code> for <code>X:X::X:X/M</code> .
<code>le</code>	Maximum prefix length match
<code>ge</code>	Minimum prefix length match
<code>&lt;0-128&gt;</code>	Prefix length to match
<code>&lt;1-4294967295&gt;</code>	Sequence number of the prefix list.
<code>sequence-number</code>	



---

To suppress sequence number generation, give the `no ipv6 prefix-list sequence-number` command. If you disable the generating sequence numbers, you must specify the sequence number for each entry using the sequence number parameter in the `ipv6 prefix-list` command.

To enable sequence number generation, give the `ipv6 prefix-list sequence-number` command.

LINE

Up to 80 characters describing this prefix-list.

### Default

No default value is specified

### Command Mode

Configure mode

### Applicability

This command was introduced before OcnOS version 1.3.

### Examples

```
#configure terminal
(config)#ipv6 prefix-list mylist
(config-ipv6-prefix-list)#seq 12345 deny 3ffe:345::/16 le 22 ge 14
```

---

## ipv6 unnumbered

Use this command to enable IPv6 processing without an explicit address, on a point-to-point non multi-access link.

This command lets an interface borrow the IPv6 address of a specified interface to enable IPv6 processing on a point-to-point interface without assigning it an explicit IPv6 address. In this way, the IPv6 unnumbered interface can borrow the IPv6 address of another interface already configured on the router to conserve network and address space.

Use the `no` parameter with this command to remove this feature on an interface.

### Command Syntax

```
ipv6 unnumbered IFNAME
no ipv6 unnumbered
```

### Parameter

IFNAME                    Interface name.

### Default

No default value is specified

### Command Mode

Interface mode

### Applicability

This command was introduced before OcNOS version 1.3.

### Example

The following example creates a tunnel on eth1:

```
#configure terminal
(config)#interface lo
(config-if)#ipv6 address ::1/128
(config-if)#exit
(config)#interface eth1
(config-if)#ipv6 address fe80::20e:cff:fe6e:56dd/64
(config-if)#exit
(config)#interface Tunnel0
(config-if)#tunnel source 10.70.0.145
(config-if)#tunnel destination 10.70.0.77
(config-if)#tunnel ttl 255
(config-if)#tunnel path-mtu-discovery
(config-if)#tunnel mode vxlan
(config-if)#ipv6 unnumbered eth1
(config-if)#ipv6 router ospf area 0 tag 1
(config-if)#exit
(config)#router ipv6 ospf 1
(config-router)#router-id 10.70.0.145
```

---

## link-debounce-time

Use this command to set the debounce time for linkup and linkdown transitions for the interface.

User can set only one of the timers (either linkup or linkdown) by setting the other one to 0.

Use the `no` form of this command to turn off the link debounce timer on the interface.

### Command Syntax

```
link-debounce-time <0-5000> <0-5000>
no link-debounce-time
```

### Parameter

<0-5000>	timer value in milliseconds for the linkup transition
<0-5000>	timer value in milliseconds for the linkdown transition

### Default

By default, it is disabled.

### Command Mode

Interface mode

### Applicability

This command was introduced before OcnOS version 5.0.

### Example

```
#configure terminal
(config)#interface eth1
(config-if)#link-debounce-time 4000 5000
(config-if)#link-debounce-time 0 5000
(config-if)#link-debounce-time 3000 0
```

---

## load interval

Use this command to configure the interval for which average traffic rate need to be shown. Intervals can be configured in steps of 30 seconds.

Use the no parameter with this command to set the load interval to its default.

### Command Syntax

```
load-interval <30-300>
no load-interval
```

### Parameter

<30-300>            Load period in multiples of 30 seconds.

### Default

By default, load interval is 300 seconds

### Command Mode

Interface mode

### Applicability

This command was introduced before OcNOS version 1.3.

### Example

```
#configure terminal
(config)#interface xe1/1
(config-if)#load-interval 30
(config-if)#no load-interval
```

---

## loopback

Use this command to loopback TX or RX packets at MAC or PHY level.

Use the `no` form of the command to remove loopback configuration.

### Command Syntax

```
loopback (tx | rx) (mac | phy)
no loopback
```

### Parameter

<code>tx</code>	Loopback TX packets
<code>rx</code>	Loopback RX packets
<code>mac</code>	Loopback TX or RX packets at MAC level
<code>phy</code>	Loopback TX or RX packets ar PHY level

### Default

None

### Command Mode

Interface mode

### Applicability

This command was introduced before OcnOS version 5.0.

### Example

```
#configure terminal
(config)#int ce1/2
(config-if)#loopback rx phy

#configure terminal
(config)#int ce1/2
(config-if)#no loopback
```

---

## loss-measurement dynamic

This command enables the loss measurement. This command is tied to the delay measurement session already created to measure the delay. In case this command is issued without the delay-measurement command previously issued, an error is returned.

Use the `no` form of this command should be used to disable the loss measurement.

### Command Syntax

```
loss-measurement dynamic
no loss-measurement dynamic
```

### Parameter

None

### Command Mode

Interface mode

### Applicability

This command was introduced before OcNOS version 5.1.

### Example

```
#configure terminal
(config)#interface xe1
(config-if)#loss-measurement dynamic
(config-if)#no loss-measurement dynamic
```

---

## loss-measurement uni-link-loss

Use this command to advertise the loss (as a packet percentage) between two directly connected IS-IS/OSPF neighbors.

The A bit is set when the measured value of this parameter exceeds its configured maximum threshold. The A bit is cleared when the measured value falls below its configured reuse threshold.

Use the `no` parameter with this command to unset uni-link-loss on the current interface.

### Command Syntax

```
loss-measurement uni-link-loss ((static VALUE) | (a-bit-threshold min VALUE max VALUE))
no loss-measurement uni-link-loss (static | a-bit-threshold)
```

### Parameter

<code>static</code>	Static value
<code>VALUE</code>	Loss percentage in six precision float format. eg: 3.123456
<code>a-bit-threshold</code>	Threshold values to set/clear A-bit
<code>min</code>	Reuse threshold
<code>VALUE</code>	Reuse threshold percentage in six precision float format. eg:3.123456
<code>max</code>	Maximum threshold
<code>VALUE</code>	Maximum threshold percentage in six precision float format. eg:3.123456

### Command Mode

Interface mode

### Applicability

This command was introduced in OcNOS version 5.0.

### Examples

```
#configure terminal
(config)#interface eth1
(config-if)#loss-measurement uni-link-loss static 12.3
(config-if)#no loss-measurement uni-link-loss static
(config-if)#loss-measurement uni-link-loss a-bit-threshold min 1.12 max 2.2
(config-if)#no loss-measurement uni-link-loss a-bit-threshold
```

---

## monitor speed

Use this command to enable speed monitoring on interface.

Use the `no` parameter with this command to disable monitoring.

### Command Syntax

```
monitor speed
no monitor speed
```

### Default

By default, speed monitoring will be disabled

### Command Mode

Interface mode

### Applicability

This command was introduced in OcNOS version 3.0.

### Example

```
#configure terminal
(config)#interface xe1/1
(config-if)#monitor speed
(config-if)#no monitor speed
```



---

## monitor queue-drops

Use this command to enable queue-drops monitoring on interface.

Use the `no` parameter with this command to disable monitoring.

### Command Syntax

```
monitor queue-drops
no monitor queue-drops
```

### Default

By default, queue-drops monitoring will be disabled

### Command Mode

Interface mode

### Applicability

This command was introduced in OcNOS version 3.0.

### Example

```
#configure terminal
(config)#interface xe1/1
(config-if)#monitor queue-drops
(config-if)#no monitor queue-drops
```

---

## monitor speed threshold

Use this command to modify default speed monitor threshold on interface.

Use the `no` parameter with this command to set the monitor speed threshold to its default.

Note: Warning threshold must be greater than recovery threshold and it is recommended to keep a difference of 10 percent to avoid frequent notifications caused by variations in average speed.

### Command Syntax

```
monitor speed threshold warning <1-100> recovery <1-100>
no monitor speed threshold
```

### Parameter

<1-100>	Warning level threshold value in percentage
<1-100>	Recovery level threshold value in percentage

### Default

By default, warning threshold is 90 percentage and recovery is 80 percentage.

### Command Mode

Interface mode

### Applicability

This command was introduced in OcNOS version 3.0.

### Example

```
#configure terminal
(config)#interface xe1/1
(config-if)# monitor speed threshold warning 80 recovery 70
(config-if)#no monitor speed threshold
```

---

## mtu

Use this command to set the Maximum Transmission Unit (MTU) and Maximum Receive Unit (MRU) for an interface

Use the `no` parameter with this command to set the MTU to its default.

Note: To allow jumbo frames over SVI interfaces, it is mandatory to configure the applicable MTU for the specific SVI interfaces.

### Limitation for MTU configuration on Label-Switching:

Creating a sub-interface automatically increases the physical interface MTU size by 8 bytes to accommodate double VLAN tag encapsulation.

Configuring label switching for physical layer-3 interfaces adds 20 bytes internally to the MTU to accommodate up-to five labels. However, configuring label-switching on sub-interface does not change the MTU of physical interface. Hence, the physical interface requires a manual increase in MTU size.

During the BGP update, in case the control packet contains 1500 bytes when it reaches the hardware, the hardware adds the Encapsulation for the sub-interface and MPLS header (Additional bytes). Now, the hardware drops it as physical port MTU is limited to 1500 bytes.

While configuring MTU on label-switching enabled with Subinterface/SVI/LAG and the Parent Physical port follow guide lines mentioned below:

It is recommended to configure higher MTU on network ports in comparison with access ports. Hence, increase the MTU on both physical and sub-interfaces to accommodate the PDU.

When using sub-interface for MPLS network interfaces, considering the default MTU of 1500, minimum MTU configuration recommendation is as follows

- **Sub-interface:** MTU 1520 (to accommodate 5 MPLS labels)
- **Physical interface:** MTU 1528: (Default MTU 1500 + double encap 8 + MPLS up-to 5 labels 20) = 1528).

Note: MTU configuration is considered from IP header onwards. Hence, OcNOS adds 14 bytes to MTU internally to accommodate L2 header. The effective MTU in hardware will be  $1528+14 = 1542$ .

- **LAG interface:** MTU is applied on all members internally
- **SVI:** When label-switching enabled on VLAN interface, MTU value must be manually increased by at least 20 bytes on Parent interfaces of VLAN.  
Example, default MTU must be set as 1520 instead of 1500 on label-switching parent interface label switched VLAN interface. (Parent Interface MTU  $\geq$  label switched VLAN interface MTU + 20).

### Command Syntax

```
mtu <64-65536>
```

```
no mtu
```

### Parameter

<64-65536> Specify the size of MTU in bytes:  
 <64-16338> for L2 packet  
 <576-9216> for L3 IPv4 packet

<1280-9216> for L3 IPv6 packet  
<576-65536> for IPv4 packet  
<1280-65536> for IPv6 packet on loopback interface

### Default

By default, MTU is 1500 bytes

### Command Mode

Interface mode

### Applicability

This command was introduced before OcnOS version 1.3.

### Example

```
#configure terminal
(config)#interface eth3
(config-if)#mtu 120
```

---

## multicast

Use this command to set the multicast flag for the interface.

Use the `no` form of this command to disable this function.

### Command Syntax

```
multicast
no multicast
```

### Parameters

None

### Default

No default value is specified

### Command Mode

Interface mode

### Applicability

This command was introduced before OcNOS version 1.3.

### Example

```
#configure terminal
(config)#interface eth3
(config-if)#multicast
```

## show flowcontrol

Use this command to display flow control information.

### Command Syntax

```
show flowcontrol
show flowcontrol interface IFNAME
```

### Parameters

`interface IFNAME` Specify the name of the interface to be displayed.

### Command Mode

Exec mode and Privileged Exec mode

### Applicability

This command was introduced before OcNOS version 1.3.

### Example

The following is a sample output of the `show flowcontrol interface` command displaying flow control information:

```
#show flowcontrol interface ge1
Port      Send FlowControl   Receive FlowControl RxPause TxPause
          admin    oper      admin    oper
-----  -
ge1      on      on        on      on          0      0
#
```

[Table 21-47](#) explains the show command output fields.

**Table 21-47: show flow control output**

Entry	Description
Port	Interface being checked for flowcontrol.
Send admin	Displays whether the flowcontrol send process is administratively on or off.
FlowControl oper	Displays whether send flowcontrol is on or off on this interface.
Received admin	Displays whether the flowcontrol receive process is administratively on or off.
FlowControl oper	Displays whether receive flowcontrol is on or off on this interface.
RxPause	Number of received pause frames.
TxPause	Number of transmitted pause frames.

## show hardware-discard-counters

Use this command to check device level discard counters.

### Command Syntax

```
show hardware-discard-counters
```

### Parameters

None

### Command Mode

Exec mode

### Applicability

The command is introduced before OcNOS version 1.3.

Qumran devices do not support discard counters per interface. Only global level counters are available for advanced debugging using the [show hardware-discard-counters](#) command.

### Examples

```
#show hardware-discard-counters
+-----+-----+-----+
| Registers                                     | Core 0          |
+-----+-----+-----+
CGM_VOQ_SRAM_ENQ_RJCT_PKT_CTR                437
Reason : QNUM_NOT_VALID                       Y
EGQ_PQP_DISCARD_UNICAST_PACKET_COUNTER       8894
Reason : SRC_EQUAL_DEST_INT                   Y
```

See [Table 21-48](#) and [Table 21-49](#) for details:

**Table 21-48: Table detailing about counters supported**

Register	Description
CGM_VOQ_SRAM_ENQ_RJCT_PKT_CTR for QAX	Drop is due to PPdecision to drop, or invalid destination received from PPblocks.
IQM_QUEUE_ENQ_DISCARDED_PACKET_COUNTER for QMX	The packet DP (Drop Precedence) is higher than the configured Drop DP.
EGQ_PQP_DISCARD_UNICAST_PACKET_COUNTER	Seen with unknown unicast frames, source and destination learnt from same interface.

**Table 21-49: Table detailing about reasons supported**

Register	Description
QNUM_NOT_VALID for QAX QUEUE_NOT_VALID_STATUS for QMX DP_LEVEL_RJCT for QAX DP_LEVEL_STATUS for QMX	Seen with Vlan Discards, ACL Drops, Storm Control, STP Blocked Port.  Seen with Policer Discards.
SRC_EQUAL_DEST_INTF	Seen when traffic is not learned, but is still forwarded/flooded.



---

## show interface

Use this command to display interface configuration and status information.

### Command Syntax

```
show interface (IFNAME|)
```

### Parameter

IFNAME                    Interface name.

### Command Mode

Exec mode and Privileged Exec mode

### Applicability

This command was introduced before OcNOS version 1.3.

### Example

```
#show interface xe1/1
Interface xe1/1
  Scope: both
  Flexport: Breakout Control Port (Active): Break Out Enabled
  Hardware is ETH Current HW addr: ecf4.bb6e.934b
  Physical:ecf4.bb6e.934b Logical:(not set)
  Port Mode is access
  Interface index: 5001
  Metric 1 mtu 1500 duplex-full(auto) link-speed 1g(auto)
  <UP,BROADCAST,RUNNING,MULTICAST>
  VRF Binding: Not bound
  Label switching is disabled
  No Virtual Circuit configured
  DHCP client is disabled.
  Last Flapped: 2016 Nov 05 22:40:23 (00:19:25 ago)
  Statistics last cleared: 2016 Nov 05 04:49:55 (18:09:53 ago)
  5 minute input rate 0 bits/sec, 0 packets/sec
  5 minute output rate 256 bits/sec, 0 packets/sec
RX
  unicast packets 39215813 multicast packets 0 broadcast packets 0
  input packets 39215813 bytes 2666662432
  jumbo packets 0
  runts 0 giants 0 CRC 0 fragments 0 jabbers 0
  input error 0
  input with dribble 0 input discard 0
  Rx pause 0
TX
  unicast packets 38902 multicast packets 437 broadcast packets 0
  output packets 437 bytes 28018
  jumbo packets 0
  output errors 0 collision 0 deferred 0 late collision 0
  output discard 0
  Tx pause 0
```

Table 21-50 explains the output fields.

**Table 21-50: show interface output details**

Field	Description
Scope	Interface can be used for communication within the device and outside the device (Both).
Flexport	Specifies whether the ports has Breakout capabilities or is a Non-Control Port.
Breakout Control Port (Active)	Specifies whether Breakout is active or disabled.
Hardware is ETH Current HW addr	The MAC address of the interface.
Physical	Displays the physical MAC address of the interface.
Logical	Displays the logical MAC address (if any) of the interface.
Port Mode	Displays the port mode: Router, VLAN access, switch, or trunk.
Interface index	Index number, Metric, MTU size, duplex-full (auto) or half-duplex, minimum link speed in gigabits, and if the interface is up, broadcasting, and multicasting.
VRF Binding	Show whether the interface is VRF bound and (if bound) with what VRF, if Label Switching is enabled or disabled, and if a virtual circuit is configured.
DHCP client	The state of the DHCP client – whether this interface is connected to a DHCP server.
Last Flapped	Date and time when the interface last flapped.
Statistics last cleared	Date and time when the interface's statistics were cleared.
5 minute input rate	Input rate in bits/second and packets/second
5 minute output rate	Output rate in bits/second and packets/second
RX	Counters for unicast packets, multicast packets, broadcast packets, input packets, bytes, jumbo packets, runts, giants, CRC errors, fragments, jabbers, input errors, input with dribble input discards, and receive pause.
TX	Counters for unicast packets, multicast packets, broadcast packets, output packets, bytes, jumbo packets, output errors, collisions, differed packets, input late collisions, output discards, and transmit pause.

## show interface capabilities

Use this command to display interface capabilities

### Command Syntax

```
show interface (IFNAME|) capabilities
```

### Parameters

**IFNAME** Displays the name of a specific interface for which status and configuration data is desired.

### Command Mode

Exec mode

### Applicability

This command was introduced before OcNOS version 1.3.

### Example

```
#show interface xe1/1 capabilities
xe1/1
Speed(FD) : 10MB,100MB,1000MB,10GB,20GB,40GB
Interface : xgmii
Medium : copper
Loopback : none,MAC,PHY
Pause : pause_tx,pause_rx,pause_asymm
Flags : autoneg
Encap : IEEE,HIGIG,HIGIG2
```

[Table 21-51](#) explains the show command output fields.

**Table 21-51: show interface capabilities output details**

Field	Description
Interface number	The identifying ID number of the interface – eht0, xe1, etc.
Speed (FD)	The Flexible Data-Rates (FD) of the interface
interface	XAUI is a standard for extending the XGMII (10 Gigabit Media Independent Interface) between the MAC and PHY layer of Gigabit Ethernet.
Medium	Members have to have the same medium type configured. This only applies to Ethernet port-channel. Copper, fiber optics, etc.
Loop back	The loop back between the MAC and PHY layers.
Pause	Pause transmit, pause receive, pause asymmetrically.

**Table 21-51: show interface capabilities output details**

Field	Description
Flags	Interface flags set for Auto-negotiation.
Encap	Encapsulation – IEEE, HIGIG, and HIGIG2 specifications – HIGIG is a proprietary protocol that is implemented by Broadcom. The HIGIG protocol supports various switching functions. The physical signaling across the interface is XAUI, four differential pairs for receive and transmit (SerDes), each operating at 3.125 Gbit/s.

---

## show interface counters

Use this command to display the ingress and egress traffic counters on the interface.

Note: Counters are meant for debugging purpose and the accuracy of the transmit discard counter is not guaranteed in all scenarios.

### Command Syntax

```
show interface (IFNAME|) counters (active|)
show interface cpu counters
```

### Parameter

IFNAME	Interface name.
active	Statistics for link-up interfaces.
cpu	CPU interface.

### Command Mode

Exec mode and Privileged Exec mode

### Applicability

This command was introduced before OcNOS version 1.3.

### Example

```
#show interface xe1/1 counters
Interface xe1/1
  Scope: both
  Rx Packets: 1000
  Rx Bytes: 1000000
  Rx Unicast Packets: 1000
  Rx Packets from 512 to 1023 bytes: 1000
  Tx Packets: 3897
  Tx Bytes: 249408
  Tx Multicast Packets: 3897
  Tx Packets with 64 bytes: 3897
  Tx Packet rate: 1 pps
  Tx Bit rate: 255 bps

#show interface cpu counters
CPU Interface
  Tx Packets: 104508
  Tx Bytes: 7106272
  Tx Discard Packets: 89613672
  Tx Discard Bytes: 5735237844
  Rx Discard Packets: 11938
```

[Table 21-52](#) explains the output fields.

**Table 21-52: show interface counters output details**

Field	Description
Receive Counters	Rx Packets Rx Bytes Rx Unicast Packets Rx Multicast Packets Rx Broadcast Packets Rx Packets with 64 bytes Rx Packets from 65 to 127 bytes Rx Packets from 128 to 255 bytes Rx Packets from 256 to 511 bytes Rx Packets from 512 to 1023 bytes Rx Packets from 1024 to 1518 bytes Rx Packets from 1519 to 2047 bytes Rx Packets from 2048 to 4095 bytes Rx Packets from 4096 to 9216 bytes Rx Jumbo Packets Rx Discard Packets (not applicable for Qumran platform) Rx Packets with error Rx CRC Error Packets Rx Undersized Packets Rx Oversized Packets Rx Fragment Packets Rx Jabber Packets Rx MAC error Packets Rx Pause Packets Rx Unrecognized MAC Control Packets Rx Drop Events Rx Packet rate Rx Bit rate

**Table 21-52: show interface counters output details**

Field	Description
Transmit Counters	Tx Packets Tx Bytes Tx Unicast Packets Tx Multicast Packets Tx Broadcast Packets Tx Packets with 64 bytes Tx Packets from 65 to 127 bytes Tx Packets from 128 to 255 bytes Tx Packets from 256 to 511 bytes Tx Packets from 512 to 1023 bytes Tx Packets from 1024 to 1518 bytes Tx Packets from 1519 to 2047 bytes Tx Packets from 2048 to 4095 bytes Tx Packets from 4096 to 9216 bytes Tx Jumbo Packets Tx Discard Packets (not applicable for Qumran platform) Tx Packets with error Tx Collisions Tx Late Collisions Tx Excessive Collisions Tx Pause Packets Tx Packet rate Tx Bit rate
CPU Interface Counters	Tx Packets Tx Bytes Tx Discard Packets Tx Discard Bytes Rx Discard Packets

## show interface counters drop-stats

Use this command to display the ingress and egress traffic discard reason counters on the interface.

Note: You can only display statistics for physical ports and cpu ports, but not for the out-of-band management (OOB) management port or logical interfaces.

Note: Drops in the CPU queue are listed under Tx Multicast Queue Drops, whether the packet is unicast or multicast

### Command Syntax

```
show interface (IFNAME|) counters drop-stats
show interface cpu counters drop-stats
```

### Parameter

IFNAME	Physical interface name
cpu	CPU interface

### Command Mode

Exec mode and Privileged Exec mode

### Applicability

This command was introduced before OcNOS version 1.3.1.

For Qumran devices, only error statistics are applicable and discard counters are not applicable. Only global level counters are available for advanced debugging using the command [show hardware-discard-counters](#).

### Example

```
#show interface xe32/2 counters drop-stats
+-----+-----+-----+-----+
| Counter Description | Count          | Last Increment | Last Increment Time |
+-----+-----+-----+-----+
Rx Bad CRC errors    0                0
Rx Undersize errors  0                0
Rx Oversize errors   0                0
Rx Fragments errors  0                0
Rx Jabbers errors    0                0
Rx Port Block Drops  6                1                2016 Nov 09 08:59:33
Rx Vlan Discards     0                0
Rx ACL/QOS Drops     0                0
Rx Policy Discards   0                0
Rx EGR Port Unavail  38784           5                2016 Nov 09 18:19:31
Rx IBP Discards      0                0
Tx Port Block Drops  359             1                2016 Nov 09 08:59:33
Tx Vlan Discards     0                0
Tx TTL Discards      0                0
Tx Unknown Discards  359             1                2016 Nov 09 08:59:33
Tx Ucast Queue Drops 0                0
Tx Mcast Queue Drops 0                0
+-----+-----+-----+-----+
```

[Table 21-53](#) explains the output fields.



**Table 21-53: show interface counters drop-stats output details**

Field	Description
Counter Description	Shows the type of packet and/or the reason why the packet was dropped.
Count	The number of packets dropped for each reason.
Last Increment	Number of packets dropped since this command was last entered.
Last Increment Time	Date and time when the last packet was dropped.
Rx Bad CRC errors	Received packets dropped because they didn't pass the cyclic Redundancy Check (CRC).
Rx Undersize errors	Number of received runt packets dropped.
Rx Oversize errors	Number of received giant packets dropped
Rx Fragments errors	Number of received packet fragments dropped
Rx Jabbers errors	Received packets dropped because of jabber – long packet error.
Rx Port Block Drops	Received packets dropped because port blocking is enabled (not applicable for Qumran platform).
Rx Vlan Discards	VLAN received packets dropped because there is no VLAN configured on the port (not applicable for Qumran platform).
Rx ACL/QOS Drops	Received packets match a field processing entry with a drop or color drop action, such as: User-configured ACL that denies traffic Service policy with a police action that drops the traffic received at a rate higher than the configured limit. (not applicable for Qumran platform)
Rx Policy Discards	Received packets dropped because of device policies violated, such as a storm control rate violation (not applicable for Qumran platform).
Rx EGR Port Unavail	No output port can be determined for these received packets. This counter increments along with other counter types in this table because it is a "catchall" for multiple types of discards as shown below (not applicable for Qumran platform):  VLAN check failed MTU check failed ACL/QoS drops Policy discards Source MAC is null Destination IP/source IP address is null Source MAC address and destination MAC address are the same Forwarding lookup failure
Rx IBP Discards	Ingress Back Pressure (ingress congestion) when the ingress packets buffer is full for an interface. (not applicable for Qumran platform)
Tx Port Block Drops	Transmitted packets dropped because port blocking is enabled (not applicable for Qumran platform).
Tx Vlan Discards	Transmitted VLAN packets dropped because there is no VLAN configured on the port (not applicable for Qumran platform).

**Table 21-53: show interface counters drop-stats output details (Continued)**

<b>Field</b>	<b>Description</b>
Tx TTL Discards	Transmitted packets discarded because their Time To Live (TTL) has ended. (not applicable for Qumran platform)
Tx Unknown Discards	Transmitted packets dropped for unknown reason. May have something to do with the condition/configuration of the port at the other end of the connection (not applicable for Qumran platform).
Tx Ucast Queue Drops	Transmitted packets dropped as a result of Unicast buffer overflow.
Tx Mcast Queue Drops	Transmitted packets dropped as a result of Multicast buffer overflow.

## show interface counters error-stats

Use this command to display the ingress error traffic counters on the interface.

### Command Syntax

```
show interface (IFNAME|) counters error-stats
```

### Parameter

IFNAME                      Interface name.

### Command Mode

Exec mode and Privileged Exec mode

### Applicability

This command was introduced before OcNOS version 1.3.

### Example

```
#show interface xe1/1 counters error-stats
+-----+-----+-----+-----+-----+-----+-----+
|Interface|Total errors|Bad CRC|Undersize|Oversize|Fragments|Jabbers|
+-----+-----+-----+-----+-----+-----+-----+
|xe1/1    |120         |8      |100     |10      |2        |0       |
```

Table 21-54 explains the columns in the output.

**Table 21-54: error traffic counters**

Column	Description	Causes
Interface	Name of the interface	Point of interconnection in network.
Total errors	Total number of all types of errors	Number of errors in network.
Bad CRC	Number of packets received by the port from the network, where the packets have no CRC or a bad CRC.	Packet data modified making the CRC invalid.
Undersize	Total number of packets received that are less than 64 octets long (which exclude framing bits, but include the FCS) and have a good FCS value.	Bad frame generated by the connected device.
Oversize	Number of packets received by the port from the network, where the packets were more than maximum transmission unit size.	Faulty hardware, dot1q, or ISL trunking configuration issues.
Fragments	Total number of frames whose length is less than 64 octets (which exclude framing bits, but which include the FCS) and have a bad FCS value.	Ports are configured at half-duplex. Change the setting to full-duplex.
Jabbers	Total number of frames whose length is more than the maximum MTU size. (which exclude framing bits, but which include FCS) and have a bad FCS value.	Ports are configured at half-duplex. Change the setting to full-duplex.

## show interface counters (indiscard-stats|outdiscard-stats)

Use this command to display the ingress and egress traffic discard reason counters on the interface.

Note: You can only display statistics for data ports and CPU ports, not for the out-of-band management (OOB) management port or logical interfaces.

### Command Syntax

```
show interface (IFNAME|) counters (indiscard-stats|outdiscard-stats)
show interface cpu counters (indiscard-stats|outdiscard-stats)
```

### Parameter

IFNAME	Physical Interface name.
indiscard-stats	Discard reasons for ingress dropped packets.
outdiscard-stats	Discard reasons for egress dropped packets.
cpu	CPU Interface.

### Command Mode

Exec mode and Privileged Exec mode

### Applicability

This command was introduced before OcNOS version 1.3.

This command is not available on Qumran platforms.

### Examples

```
#show interface xe1/3 counters indiscard-stats
```

Counter Description	Count	Last Increment	Last Increment Time
STP Discards	0	0	
Vlan Discards	0	0	
ACL Drops	0	0	
Policy Discards	0	0	
EGR Port Unavail	1092867	1092867	2016 Oct 25 19:54:58
IBP Discards	0	0	

```
#show interface counters indiscard-stats
```

Interface	Port Block Drops	Vlan Discards	ACL/QOS Drops	Policy Discards	EGR Port Unavail	IBP Discards	Total Discards
xe1	0	0	35703	0	11	0	35714
xe2	0	0	295744	0	13604	0	309348
xe3	0	0	9501	0	20405	0	29906
xe5	0	0	0	0	13602	0	13602
xe49/1	0	0	0	0	0	20658	20658
xe52/1	0	3	856029	10	13613	0	869642
xe54/1	0	5371	0	0	5371	0	5371
cpu	0	0	0	0	6	0	N/A

```
#show interface counters outdiscard-stats
```

```

+-----+-----+-----+-----+-----+-----+-----+
| Interface | Port Block Drops | Vlan Discards | TTL Discards | Unknown Discards | UcastQ Drops | McastQ Drops | Total Discards |
+-----+-----+-----+-----+-----+-----+-----+
xe1         0           0           0           204338         0           0           204338
xe2         0           0           0           1094368        0           0           1094368
xe3         0           0           0           818672         0           0           818672
xe52/1      0           0           0           1275156        0           0           1275156
xe54/1      0           0           0           13575          0           0           13575
cpu         0           0           0           0              0           N/A         1014224         N/A

```

Table 21-55 explain the fields in the command output.

**Table 21-55: indiscard statistic output details**

Statistic	Description
STP Discards	Packets received when the ingress interface is not in STP forwarding state.
Port Block Drops	Packets discarded on an ingress interface where port blocking is configured.
VLAN Discards	VLAN tagged packets received on a port which is not a member of the VLAN or untagged packets received on a trunk port.
ACL/QoS Drops	Incoming packets match a field processing entry with a drop or color drop action, such as: <ol style="list-style-type: none"> <li>1. User-configured ACL that denies traffic</li> <li>2. Service policy with a police action that drops the traffic received at a rate higher than the configured limit</li> </ol>
Policy Discards	Device policies violated, such as a storm control rate violation, source or destination discards when L2 tagged traffic received on router interface.
EGR (Egress) Port Unavail	No output port can be determined for this packet. This counter increments along with other counter types in this table because it is a "catchall" for multiple types of discards as shown below: <ol style="list-style-type: none"> <li>1. VLAN check failed</li> <li>2. MTU check failed</li> <li>3. ACL/QoS drops</li> <li>4. Policy discards</li> <li>5. Source MAC is null</li> <li>6. Destination IP/source IP address is null</li> <li>7. Source MAC address and destination MAC address are the same</li> <li>8. Source MAC is configured as static on other interface</li> <li>9. Forwarding lookup failure</li> </ol>
IBP Drops	Ingress Back Pressure (ingress congestion) when the ingress packet buffer is full for an interface.
Total Discards	Total number of ingress dropped packets.

Table 21-56 explain the fields in the command output.

**Table 21-56: outdiscard statistics**

Statistics	Description
Port Block Drops	Packets discarded on an egress interface where port blocking is configured.
VLAN Discards	Packets discarded because an invalid VLAN tag is encountered at an egress interface.
TTL Discards	Packets discarded because the Time-To Live (TTL) of the outgoing packet has passed.

**Table 21-56: outdiscard statistics**

<b>Statistics</b>	<b>Description</b>
Unknown Discards	Packets discarded for other possible reasons like ACL drop in egress or a policer drop in egress. Discards caused by congestion at queues and drops at queues are not counted under unknown discards.
Unicast Queue Drops	Packets dropped in the unicast queues because of congestion.
Multicast Queue Drops	Packets dropped in the multicast queues because of congestion.
Total Discards	Total number of egress dropped packets.

---

## show interface counters protocol

Use this command to display protocol packets received at the CPU by the control plane.

### Command Syntax

```
show interface (IFNAME|) counters protocol
```

### Parameters

IFNAME                    Interface name.

### Command Mode

Exec mode and Privileged Exec mode

### Applicability

This command was introduced before OcNOS version 1.3.

This command is not available on Qumran platforms.

### Example

```
#show interface counters protocol
Interface ce1/1
  lacp                        : 4
  icmp6                      : 5
```

[Table 21-57](#) explain the fields in the command output.

**Table 21-57: show interface counters protocol output details**

Field	Description
Interface	Name of the configured interface.
lacp	Total number of lacp protocol in the interface.
icmp6	Total number of icmp6 protocol in the interface.

---

## show interface counters queue-drop-stats

Use this command to display dropped packets in the CPU queue and the last increment time.

### Command Syntax

```
show interface cpu counters queue-drop-stats
```

### Parameters

`cpu` CPU interface.

### Command Mode

Exec mode and Privileged Exec mode

### Applicability

This command was introduced before OcnOS version 1.3.

### Example

```
show interface cpu counters queue-drop-stats
```

```
+-----+-----+-----+-----+
| Queue Name | Count | Last Increment | Last Increment Time |
+-----+-----+-----+-----+
arp          169735545   9145653         2017 Oct 23 14:33:54
```

[Table 21-58](#) explain the fields in the command output.

**Table 21-58: show interface counters queue-drop-stats output details**

Field	Description
Queue Name	Name of the protocol.
Count	Number of arp protocols in the interface.
Last Increment	Final increment number in the protocol.
Last Increment time	Time of the last increment in the protocol.



## show interface counters queue-stats

Use this command to display transmitted and dropped packet and byte counts of individual queues.

Note: In Qumran devices, all packets dropped in a queue are counted (even policer drops).

### Command Syntax

```
show interface (IFNAME|) counters queue-stats
show interface cpu counters queue-stats
```

### Parameters

IFNAME	Interface name.
cpu	CPU interface.

### Command Mode

Exec mode and Privileged Exec mode

### Applicability

This command was introduced before OcNOS version 1.3.

Note: Default traffic counters are not supported on Qumran AX.

### Example

```
#show interface counters queue-stats
D - Default Queue, U - User-defined Queue
+-----+-----+-----+-----+-----+-----+
|Interface|Queue/Class-map|Q-Size|Output pkts|Output bytes|Dropped pkts|Dropped bytes |
+-----+-----+-----+-----+-----+-----+
xe1/1    q1          (D) 0    12        1368      0          0
xe1/1    mc-q7       (D) 0     1         82        0          0
xe25     q1          (D) 0     6         684      0          0

#show interface xe1/1 counters queue-stats
D - Default Queue, U - User-defined Queue
+-----+-----+-----+-----+-----+-----+
|Queue/Class-map|Q-Size|Tx pkts| Tx bytes |Dropped pkts|Dropped bytes |
+-----+-----+-----+-----+-----+-----+
q0        (D) 0     0         0         0         0
q1        (D) 0    12        1368      0         0
q2        (D) 0     0         0         0         0
q3        (D) 0     0         0         0         0
q4        (D) 0     0         0         0         0
q5        (D) 0     0         0         0         0
q6        (D) 0     0         0         0         0
q7        (D) 0     0         0         0         0
mc-q0     (D) 0     0         0         0         0
mc-q1     (D) 0     0         0         0         0
mc-q2     (D) 0     0         0         0         0
mc-q3     (D) 0     0         0         0         0
mc-q4     (D) 0     0         0         0         0
mc-q5     (D) 0     0         0         0         0
mc-q6     (D) 0     0         0         0         0
mc-q7     (D) 0     1         82        0         0

#show interface cpu counters queue-stats
E - Egress, I - Ingress, Q-Size is in bytes
+-----+-----+-----+-----+-----+-----+
| Queue/Class-map | Q-Size | Tx pkts | Tx bytes | Dropped pkts | Dropped bytes |
+-----+-----+-----+-----+-----+-----+
igmp          (E) 800592 14519    987292   1304163   88683084
```

```
arp (E) 1250496 1008785 68597380 0 0
```

Table 21-59 explain the fields in the command output.

**Table 21-59: queue flags detail**

Flag	Meaning
D	Default queue of the port.
U	User defined queue of the port.
E	Outgoing hello packet's queue in the port.
I	Incoming hello packet's queue in the port.
Q	Hello packet's queue size in bytes.

Table 21-60 explain the fields in the command output.

**Table 21-60: show interface counters queue-stats output details**

Field	Description
Interface	A defined physical interface to which the queue is associated.
Queue/Class-map	Queues associated with a QoS class-map.
Q-Size	The size of a specified queue in bytes.
Output pkts	The number of out bound packets residing in the queues.
Output Bytes	The number of bytes in the outbound queue.
Dropped pkts	The number of packets dropped because of queue overflow.
Dropped bytes	The number of bytes dropped because of queue overflow.
Tx pkts	The number of transmit packets contained in the out bound queue.
Tx bytes	The number of transmit bytes contained in the out bound queue.

## show interface counters rate

Use this command to display the average traffic rate over the load interval of the interface.

### Command Syntax

```
show interface (IFNAME|) counters rate (kbps|mbps|gbps|)
show interface cpu counters rate (kbps|mbps|gbps|)
```

### Parameter

IFNAME	Interface name.
kbps	Kilobits per second.
mbps	Megabits per second.
gbps	Gigabits per second.
cpu	CPU interface.

### Command Mode

Exec mode and Privileged Exec mode

### Applicability

This command was introduced before OcNOS version 1.3.

### Example

```
#show interface counters rate
```

Interface	Rx		Tx	
	bps	pps	bps	pps
xe1/1	548439552	1008160	544400	1000

```
#show interface cpu counters rate
```

```
Load interval: 30 second
```

CPU Queue (%)	Rx bps	Rx pps	Tx bps	Tx pps
isis ( 0%)	-	-	742	0
arp ( 0%)	-	-	6	0

[Table 21-61](#) explain the fields in the command output.

**Table 21-61: show interface counters rate output details**

Field	Description
Interface	The particular interface.
RX	Number of hello packets received from the neighbor.
TX	Number hello packets transmitted to the neighbor.
bps	Bytes per second.
pps	Packets per second.
CPU Queue	CPU Queues used for various functions. In the example the CPU is maintaining queues for ARP and the IS-IS routing facilities.
Load interval	The length of time for which data is used to compute load statistics.
RX bps	Number of hello packets received from the neighbor in bytes per second.
RX pps	Number of hello packets received from the neighbor in packets per second.
TX bps	Number hello packets transmitted to the neighbor in bytes per second.
Tx pps	Number hello packets transmitted to the neighbor in packets per second.

## show interface counters speed

Use this command to display the current average speed on the interface.

### Command Syntax

```
show interface (IFNAME|) counters speed (kbps|mbps|gbps|)
```

### Parameter

IFNAME	Interface name.
kbps	Kilobits per second.
mbps	Megabits per second.
gbps	Gigabits per second.

### Command Mode

Exec mode and Privileged Exec mode

### Applicability

This command was introduced in OcNOS version 3.0.

### Example

```
#show interface counters speed
* indicates monitor is active
+-----+-----+-----+-----+-----+-----+-----+-----+
| speed | | | Threshold(%) | | Current average |
| interface | configured | +-----+-----+-----+-----+
+-----+-----+
| | | speed ( bps) | Warning | Recovery | Rx ( bps) | % | Tx (
bps) | % |
+-----+-----+-----+-----+-----+-----+-----+-----+
+-----+-----+
ce45 100000000000 90 80 0 0.00 0
0.00
xe7 100000000000 90 80 0 0.00 0
0.00
xe31 100000000000 90 80 0 0.00 0
0.00
xe33 100000000000 90 80 0 0.00 0
0.00
xe39 100000000000 90 80 0 0.00 0
0.00
xe40 100000000000 90 80 0 0.00 0
0.00
#
```

## show interface counters summary

Use this command to display the summary of traffic counters on a specific interface or all interfaces.

Note: This command is supported for the out-of-band management (OOB) management interface.

### Command Syntax

```
show interface (IFNAME|) counters summary
```

### Parameter

IFNAME                      Interface name.

### Command Mode

Exec mode and Privileged Exec mode

### Applicability

This command was introduced before OcNOS version 1.3.

### Example

```
#show interface xe1/1 counters summary
```

```
+-----+-----+-----+-----+
|           |           Rx           |           Tx           |
| Interface |-----+-----+-----+-----+
|           | packets | bytes | packets | bytes |
+-----+-----+-----+-----+
xe1/1      11032977      11032960000      61          3904
```

```
#show interface counters summary
```

```
+-----+-----+-----+-----+-----+
| Interface | Rx packets | Rx bytes | Tx packets | Tx bytes |
+-----+-----+-----+-----+-----+
eth0       206222     13756391  235123     337010937
po1        809121     72989094  825221     90605534
xe1/1      0          0         1          114
xe3/1      43         4730     21         2298
xe5/1      29         3178     21         2298
xe8        10         1076     14         1532
xe9/1      16         1760     21         2298
xe11/1     0          0         7          766
xe19/1     12426292  1298526692  6          620
xe21/1     13         1386     14         1532
xe28/1     3144      202370   21         2298
xe30/1     3161      202304   7          766
xe32/1     694067    61687838  710274     79315093
xe32/2     115054    11301256  114947     11290441
xe32/3     603759    51208946  620502     68865557
xe32/4     7         766      7          766
```

[Table 21-62](#) explain the fields in the command output.

**Table 21-62: show interface counters summary output details**

<b>Field</b>	<b>Description</b>
Interface	The particular interface.
RX	Number of hello packets received from the neighbor.
TX	Number hello packets transmitted to the neighbor.
bps	Bytes per second.
pps	Packets per second.
RX bps	Number of hello packets received from the neighbor in bytes per second.
RX pps	Number of hello packets received from the neighbor in packets per second.
TX bps	Number hello packets transmitted to the neighbor in bytes per second.
Tx pps	Number hello packets transmitted to the neighbor in packets per second.

## show interface fec

Use this command to display the FEC (forward error correction) statistics for an interface.

Note: You can only display FEC statistics for physical interfaces and not for management or logical interfaces.

### Command Syntax

```
show interface (IFNAME|) fec
```

### Parameters

IFNAME                      Physical Interface name.

### Default

None

### Command Mode

Exec and Privileged Exec mode

### Applicability

This command was introduced before OcNOS version 1.3.

### Example

```
#sh int ce54 fec
+-----+-----+-----+-----+-----+-----+
| Interface | Config | HW Status | Oper Status | Corrected Block Count | Uncorrected Block Count |
+-----+-----+-----+-----+-----+-----+
| ce54     | on     | c191     | c191       | 0                   | 12                      |
+-----+-----+-----+-----+-----+-----+
```

```
#sh int ce53 fec
+-----+-----+-----+-----+-----+-----+
| Interface | Config | HW Status | Oper Status | Corrected Block Count | Uncorrected Block Count |
+-----+-----+-----+-----+-----+-----+
| ce53     | auto  | c191     | c191       | 0                   | 0                       |
+-----+-----+-----+-----+-----+-----+
```

```
#sh int ce52 fec
+-----+-----+-----+-----+-----+-----+
| Interface | Config | HW Status | Oper Status | Corrected Block Count | Uncorrected Block Count |
+-----+-----+-----+-----+-----+-----+
| ce52     | off   | off      | off        | 0                   | 0                       |
+-----+-----+-----+-----+-----+-----+
```

[Table 21-57](#) explain the fields in the command output.

**Table 21-63: show interface fec**

Field	Description
Interface	Name of the configured interface.
config	Configured value.
HW Status	FEC currently programmed in HW.
Oper Status	FEC currently operating over the link.



---

**Table 21-63: show interface fec (Continued)**

Corrected Block Count	Number of the corrected block count.
Uncorrected Block Count	Number of the uncorrected block count.

---

## show ip forwarding

Use this command to display the IP forwarding status.

### Command Syntax

```
show ip forwarding
```

### Parameters

None

### Command Mode

Exec mode and Privileged Exec mode

### Applicability

This command was introduced before OcNOS version 1.3.

### Example

The following is a sample output of the `show ip forwarding` command displaying the IP forwarding status.

```
#show ip forwarding
vrf (management) :IP forwarding is on
vrf (default) :IP forwarding is on
#
```

[Table 21-64](#) explain the fields in the command output.

**Table 21-64: show ip forwarding**

Field	Description
vrf (management)	Management VRF is for management purposes. IP forwarding packet is on.
vrf (default)	The default VRF uses the default routing context for ip forwarding. IP forwarding packet is on.

## show ip interface

Use this command to display brief information about interfaces and the IP addresses assigned to them. To display information about a specific interface, specify the interface name with the command.

### Command Syntax

```
show ip interface brief
show ip interface IFNAME brief
```

### Parameters

IFNAME	Interface name.
brief	Brief summary of IP status and configuration.

### Command Mode

Exec mode and Privileged Exec mode

### Applicability

This command was introduced before OcnOS version 1.3.

### Example

The following is a sample output from the `show ip interface brief` command:

```
#show ip interface brief

'*' - address is assigned by dhcp client

Interface          IP-Address      Admin-Status    Link-Status
eth0                *10.10.26.101   up              up
lo                  127.0.0.1       up              up
lo.management       127.0.0.1       up              up
xe1/1               10.1.1.1        up              up
xe1/2               unassigned      down            down
xe1/3               unassigned      down            down
xe1/4               unassigned      down            down
xe2                 unassigned      up              down
xe3/1               unassigned      up              up
xe3/2               unassigned      down            down
xe3/3               unassigned      down            down
```

[Table 21-65](#) explain the fields in the command output.

**Table 21-65: show ip interface output details**

Field	Description
Interface	Interface name, also specifies interface type (eth0, lo, xe1/1, and xe1/2).
IP-Address	The IP address assigned to the interface. An asterisks indicates that the IP address was provided by DHCP.

**Table 21-65: show ip interface output details (Continued)**

<b>Field</b>	<b>Description</b>
Admin-Status	Interface is up and functioning or down.
Link-Status	Interface is connected and passing traffic.

---

## show ip prefix-list

Use this command to display the prefix list entries for IPv4 interfaces.

### Syntax Description

```
show ip prefix-list
show ip prefix-list WORD
show ip prefix-list WORD seq <1-4294967295>
show ip prefix-list WORD A.B.C.D/M
show ip prefix-list WORD A.B.C.D/M longer
show ip prefix-list WORD A.B.C.D/M first-match
show ip prefix-list summary
show ip prefix-list summary WORD
show ip prefix-list detail
show ip prefix-list detail WORD
```

### Parameters

WORD	Name of a prefix list.
A.B.C.D/M	IP prefix <network>/<length> (for example, 35.0.0.0/8).
first-match	First matched prefix.
longer	Lookup longer prefix.
<1-4294967295>	Sequence number.
detail	Detail of prefix lists.
summary	Summary of prefix lists.

### Command Mode

Privileged Exec mode

### Applicability

This command was introduced before OcNOS version 1.3.

### Example

The following is a sample output of the `show ip prefix-list` command showing prefix-list entries.

```
#show ip prefix-list
ip prefix-list myPrefixList: 3 entries
  seq      5 permit 172.1.1.0/16
  seq     10 permit 173.1.1.0/16
  seq     15 permit 174.1.1.0/16
```

## show ip route

Use this command to display the IP routing table for a protocol or from a particular table.

When multiple entries are available for the same prefix, NSM uses an internal route selection mechanism based on protocol administrative distance and metric values to choose the best route. All best routes are entered into the FIB and can be viewed using this command. To display all routes (selected and not selected), use the `show ip route database` command.

Use this command to see all subnets of a specified network if they are present in the routing table. Please use this command with mask information.

### Command Syntax

```
show ip route A.B.C.D
show ip route (database|)
show ip route (database|) (bgp|connected|database|isis|fast-
  reroute|interface|isis|kernel|mbgp|mstatic|next-hop|ospf|rip|static)
show ip route summary
show ip route vrf WORD (database|)
show ip route vrf WORD (database|) (bgp|connected|isis|kernel|ospf|rip|static)
```

### Parameters

A.B.C.D	Network in the IP routing table.
A.B.C.D/M	IP prefix <network>/<length>, for example, 35.0.0.0/8.
bgp	Border Gateway Protocol.
connected	Connected.
database	Routing table database.
fast-reroute	Fast reroute repair paths.
interface	Interface.
isis	IS-IS.
kernel	Kernel.
mbgp	Multiprotocol BGP routes.
mstatic	Multicast static routes.
next-hop	Next hop address.
ospf	Open Shortest Path First.
rip	Routing Information Protocol.
static	Static routes.
summary	Summarize all routes.
WORD	Routes for a Virtual Routing/Forwarding instance.

### Command Mode

Exec mode and Privileged Exec mode

## Applicability

This command was introduced before OcnOS version 1.3.

## Example: Display FIB Routes

The following shows output for the best routes.

```
#show ip route
Codes: K - kernel, C - connected, S - static, R - RIP, B - BGP
       O - OSPF, IA - OSPF inter area
       N1 - OSPF NSSA external type 1, N2 - OSPF NSSA external type 2
       E1 - OSPF external type 1, E2 - OSPF external type 2
       i - IS-IS, L1 - IS-IS level-1, L2 - IS-IS level-2, ia - IS-IS inter area
       E - EVPN,
v - vrf leaked
   * - candidate default
```

---

## show ip route A.B.C.D/M longer-prefixes

Use this command to see all subnets of a specified network if they are present in the routing table. Please use this command with mask information.

### Command Syntax

```
show ip route A.B.C.D/M longer-prefixes
```

### Parameters

A.B.C.D/M

### Command Mode

Exec-mode and Privileged exec-mode

### Applicability

This command was introduced in OcnOS version 1.3.6.

### Example

```
#sh ip route
Codes: K - kernel, C - connected, S - static, R - RIP, B - BGP
O - OSPF, IA - OSPF inter area
N1 - OSPF NSSA external type 1, N2 - OSPF NSSA external type 2
E1 - OSPF external type 1, E2 - OSPF external type 2
i - IS-IS, L1 - IS-IS level-1, L2 - IS-IS level-2,
ia - IS-IS inter area, E - EVPN,
v - vrf leaked

- candidate default
```

IP Route Table for VRF "default"

```
C    10.1.1.0/24 is directly connected, eth1, 00:00:23
C    10.12.41.0/24 is directly connected, eth0, 00:00:23
S    55.0.0.0/8 [1/0] is directly connected, eth1, 00:00:23
S    55.0.0.0/12 [1/0] is directly connected, eth1, 00:00:23
S    55.0.0.0/24 [1/0] is directly connected, eth1, 00:00:23
S    55.1.0.0/16 [1/0] is directly connected, eth1, 00:00:23
S    55.1.1.0/24 [1/0] is directly connected, eth1, 00:00:23
C    127.0.0.0/8 is directly connected, lo, 00:00:23
```

Gateway of last resort is 10.30.0.11 to network 0.0.0.0

```
K*   0.0.0.0/0 via 10.30.0.11, eth0
O    9.9.9.9/32 [110/31] via 10.10.31.16, eth2, 00:18:56
K    10.10.0.0/24 via 10.30.0.11, eth0
C    10.10.31.0/24 is directly connected, eth2
S    10.10.34.0/24 [1/0] via 10.10.31.16, eth2
O    10.10.37.0/24 [110/11] via 10.10.31.16, eth2, 00:20:54
C    10.30.0.0/24 is directly connected, eth0
```



---

```
S      11.22.11.0/24 [1/0] via 10.10.31.16, eth2
O E2   14.5.1.0/24 [110/20] via 10.10.31.16, eth2, 00:18:56
S      16.16.16.16/32 [1/0] via 10.10.31.16, eth2
O      17.17.17.17/32 [110/31] via 10.10.31.16, eth2, 00:20:54
C      45.45.45.45/32 is directly connected, lo
O      55.55.55.55/32 [110/21] via 10.10.31.16, eth2, 00:20:54
C      127.0.0.0/8 is directly connected, lo
```

```
#sh ip route 55.0.0.0/7 longer-prefixes
```

```
Routing entry for 55.0.0.0/8
```

```
Known via "static", distance 1, metric 0, External Route Tag: 0, best
```

```
    directly connected, eth1
```

```
Routing entry for 55.0.0.0/12
```

```
Known via "static", distance 1, metric 0, External Route Tag: 0, best
```

```
    directly connected, eth1
```

```
Routing entry for 55.0.0.0/24
```

```
Known via "static", distance 1, metric 0, External Route Tag: 0, best
```

```
    directly connected, eth1
```

```
Routing entry for 55.1.0.0/16
```

```
Known via "static", distance 1, metric 0, External Route Tag: 0, best
```

```
    directly connected, eth1
```

```
Routing entry for 55.1.1.0/24
```

```
Known via "static", distance 1, metric 0, External Route Tag: 0, best
```

```
    directly connected, eth1
```

```
#sh ip route 55.0.0.0/8 longer-prefixes
```

```
Routing entry for 55.0.0.0/8
```

```
Known via "static", distance 1, metric 0, External Route Tag: 0, best
```

```
    directly connected, eth1
```

```
Routing entry for 55.0.0.0/12
```

```
Known via "static", distance 1, metric 0, External Route Tag: 0, best
```

```
    directly connected, eth1
```

```
Routing entry for 55.0.0.0/24
```

```
Known via "static", distance 1, metric 0, External Route Tag: 0, best
```

```
    directly connected, eth1
```

## Interface Commands

---

```
Routing entry for 55.1.0.0/16
Known via "static", distance 1, metric 0, External Route Tag: 0, best

    directly connected, eth1
```

```
Routing entry for 55.1.1.0/24
Known via "static", distance 1, metric 0, External Route Tag: 0, best

    directly connected, eth1
```

```
#sh ip route 55.0.0.0/11 longer-prefixes
Routing entry for 55.0.0.0/12
Known via "static", distance 1, metric 0, External Route Tag: 0, best

    directly connected, eth1
```

```
Routing entry for 55.0.0.0/24
Known via "static", distance 1, metric 0, External Route Tag: 0, best

    directly connected, eth1
```

```
Routing entry for 55.1.0.0/16
Known via "static", distance 1, metric 0, External Route Tag: 0, best

    directly connected, eth1
```

```
Routing entry for 55.1.1.0/24
Known via "static", distance 1, metric 0, External Route Tag: 0, best

    directly connected, eth1
```

```
#sh ip route 55.0.0.0/16 longer-prefixes
Routing entry for 55.0.0.0/24
Known via "static", distance 1, metric 0, External Route Tag: 0, best

    directly connected, eth1
```

```
#sh ip route 55.1.0.0/16 longer-prefixes
Routing entry for 55.1.0.0/16
Known via "static", distance 1, metric 0, External Route Tag: 0, best

    directly connected, eth1
```

```
Routing entry for 55.1.1.0/24
Known via "static", distance 1, metric 0, External Route Tag: 0, best

    directly connected, eth1
```

```
#sh ip route 55.1.0.0/20 longer-prefixes
Routing entry for 55.1.1.0/24
```

```
Known via "static", distance 1, metric 0, External Route Tag: 0, best
```

```
    directly connected, eth1
```

```
#sh ip route 55.1.0.0/24 longer-prefixes
```

```
% Network not in table
```

```
#
```

```
#sh ip route 55.1.1.0/24 longer-prefixes
```

```
Routing entry for 55.1.1.0/24
```

```
Known via "static", distance 1, metric 0, External Route Tag: 0, best
```

```
    directly connected, eth1
```

```
#
```

## Header

Each entry in this table has a code preceding it, indicating the source of the routing entry. For example, O indicates OSPF as the origin of the route and K indicates that the route has been learned from the kernel. [Table 21-66](#) shows these codes and modifiers.

[Table 21-66](#) explain the fields in the command output.

**Table 21-66: route codes and modifiers**

Code	Meaning	Description
K	kernel	Routes added through means other than by using the CLI; for example by using the operating system route command. Static routes added using kernel commands and static routes added using OcnOS commands are different. The kernel static routes are not redistributed when you give the <code>redistribute static</code> command in a protocol. However, the kernel static routes can be redistributed using the <code>redistribute kernel</code> command.
C	connected	Routes directly connected to the local device that were not distributed via IGP. The device inherently knows of these networks, so there is no need to learn about these from another device. Connected routes are preferred over routes for the same network learned from other routing protocols. Routes for connected networks always exist in the kernel routing table but as an exception are not marked as kernel routes because OcnOS always calculates entries for these routes upon learning interface information from the kernel.
S	static	Routes manually configured via CLI which are not updated dynamically by IGPs.
The codes below are for routes received and dynamically learned via IGP neighbors. These networks are not directly connected to this device and were announced by some other device on the network. IGPs update these routes as the network topology changes.		
R	RIP	RIP routing process and enter Router mode.
B	BGP	Route is from an Border Gateway Protocol.
O	OSPF	Modifiers for OSPF: IA - OSPF inter area N1 - OSPF NSSA external type 1 N2 - OSPF NSSA external type 2 E1 - OSPF external type 1 E2 - OSPF external type 2

**Table 21-66: route codes and modifiers**

Code	Meaning	Description
i	IS-IS	Modifiers for IS-IS: L1 - IS-IS level-1 L2 - IS-IS level-2 ia - IS-IS inter area
Other modifiers:		
v	vrf leaked	The device has two or more VRFs configured and each has at least one interface bound to it. While each VRF will have its own routing table, the VRFs can learn each other's routes.
*	candidate default	Route has been added to the FIB. With equal cost paths to a destination, the router does per-packet or per-destination load sharing. An asterisk ("*") means that the route is being used at that instant for forwarding packets. If you run the same <code>show ip route x.x.x.x</code> command over and over, you might see the * moving between the route entries.
>	selected route	When multiple routes are available for the same prefix, the best route. When multiple entries are available for the same prefix, OcNOS uses an internal route selection mechanism based on protocol administrative distance and metric values to choose the best route. OcNOS populates the FIB with the <i>best</i> route to each destination
p	stale info	A route information that is marked stale due to graceful restart.

After the codes, the header has default gateway information:

```
Gateway of last resort is 10.12.4.1 to network 0.0.0.0
```

The “gateway of last resort”, also called the default gateway, is a static route that routes IP address 0.0.0.0 (all destinations) through a single host (the gateway). The effect of setting a gateway is that if no routing table entry exists for a destination address, packets to that address will be forwarded to the gateway router.

### Route Entry Fields

[Table 21-67](#) explains the each route entry fields.

**Table 21-67: route entry output details**

Field	Description
Codes and modifiers	As explained in <a href="#">Table 21-66</a> .
IP address	IP address of the remote network.
Administrative distance and metric	The administrative distance determines how trustworthy this route is. If there is a similar route but with a smaller administrative distance, it is used instead, because it is more “trustworthy”. The smaller the administrative distance, the more trustworthy the route. Directly connected routes have an administrative distance of 0, which makes them the most trustworthy type of route. The metric varies from protocol to protocol, and for OSPF the metric is cost, which indicates the best quality path to use to forward packets. Other protocols, like RIP, use hop count as a metric. For neighboring routers, the metric value is 1.
Next hop router IP address	This route is available through the next hop router located at this IP address. This identifies exactly where packets go when they match this route.

**Table 21-67: route entry output details**

Field	Description
Outgoing interface name	Interface used to get to the next-hop address for this route.
Duration	Length of time that this route has been present in the routing table. This is also the length of time this route has existed without an update. If the route were removed and then re-added (if the cable was disconnected, for instance), this timer would begin again at 00:00:00.

### Route Entry Examples

- O        10.10.37.0/24 [110/11] via 10.10.31.16, eth2, 00:20:54
  - This route in the network 10.10.37.0/24 was added by OSPF.
  - This route has an administrative distance of 110 and metric/cost of 11.
  - This route is reachable via nexthop 10.10.31.16.
  - The outgoing local interface for this route is eth2.
  - This route was added 20 minutes and 54 seconds ago.
- O E2     14.5.1.0/24 [110/20] via 10.10.31.16, eth2, 00:18:56
  - This route is the same as the other OSPF route above; the only difference is that it is a Type 2 External OSPF route.
- C        10.10.31.0/24 is directly connected, eth2
  - This route is directly connected.
  - Route entries for network 10.10.31.0/24 are derived from the IP address of local interface eth2.
- K        10.10.0.0/24 via 10.30.0.11, eth0
  - This route in the network 10.10.0.0/24 was learned from the kernel routing table (route was statically added using kernel commands).
  - This route is reachable via nexthop 10.30.0.11.
  - The outgoing local interface for this route is eth0.
- K\*       0.0.0.0/0 via 10.30.0.11, eth0
  - This is a default route that was learned from the kernel (route was statically added using kernel commands).
  - This route is reachable via nexthop 10.30.0.11.
  - The local interface for this route is eth0.

### Example: Display OSPF Routes

The following is the output with the `ospf` parameter:

```
#show ip route ospf
O        1.1.1.0/24 [110/20] via 2.2.2.1, eth2, 00:00:44
O IA     4.4.4.0/24 [110/21] via 2.2.2.1, eth2, 00:00:44
#
```

### Example: Display Route Summary

The following is the output with the `summary` parameter.

```
#show ip route summary
IP routing table name is Default-IP-Routing-Table(0)
IP routing table maximum-paths is 4
Route Source        Networks
kernel              1
```

```

connected      5
ospf           2
Total          8
FIB            2

```

### Example: Display RIB Routes

The following shows displaying database routes.

```

#show ip route database
Codes: K - kernel, C - connected, S - static, R - RIP, B - BGP
       O - OSPF, IA - OSPF inter area
       N1 - OSPF NSSA external type 1, N2 - OSPF NSSA external type 2
       E1 - OSPF external type 1, E2 - OSPF external type 2
       i - IS-IS, L1 - IS-IS level-1, L2 - IS-IS level-2, ia - IS-IS inter area
       > - selected route, * - FIB route, p - stale info

K    *> 0.0.0.0/0 via 10.30.0.11, eth0
O    *> 9.9.9.9/32 [110/31] via 10.10.31.16, eth2, 00:19:21
K    *> 10.10.0.0/24 via 10.30.0.11, eth0
O    10.10.31.0/24 [110/1] is directly connected, eth2, 00:28:20
C    *> 10.10.31.0/24 is directly connected, eth2
S    *> 10.10.34.0/24 [1/0] via 10.10.31.16, eth2
O    10.10.34.0/24 [110/31] via 10.10.31.16, eth2, 00:21:19
O    *> 10.10.37.0/24 [110/11] via 10.10.31.16, eth2, 00:21:19
K    * 10.30.0.0/24 is directly connected, eth0
C    *> 10.30.0.0/24 is directly connected, eth0
S    *> 11.22.11.0/24 [1/0] via 10.10.31.16, eth2
O E2 *> 14.5.1.0/24 [110/20] via 10.10.31.16, eth2, 00:19:21
O    16.16.16.16/32 [110/11] via 10.10.31.16, eth2, 00:21:19
S    *> 16.16.16.16/32 [1/0] via 10.10.31.16, eth2
O    *> 17.17.17.17/32 [110/31] via 10.10.31.16, eth2, 00:21:19
C    *> 45.45.45.45/32 is directly connected, lo
O    *> 55.55.55.55/32 [110/21] via 10.10.31.16, eth2, 00:21:19
K    * 127.0.0.0/8 is directly connected, lo
C    *> 127.0.0.0/8 is directly connected, lo

```

The codes and modifier at the start of each route entry are explained in [Table 21-66](#).

Routes in the FIB are marked with a \*. When multiple routes are available for the same prefix, the best route is indicated with the > symbol. Unselected routes have neither the \* nor the > symbol.

### Route Database Entry Examples

This example shows 2 entries in the route database; one learned from the kernel and the other derived from interface information.

```

K    * 10.30.0.0/24 is directly connected, eth0
C    *> 10.30.0.0/24 is directly connected, eth0

```

- Both these routes are in the same network 10.30.0.0/24.
- The first route has originated from the kernel. The \* indicates that it has been added to the FIB.
- The second route is derived from the IP address of local interface eth0. It is marked as a connected route. Since a connected route has the lowest administrative distance, it is the selected route.

```

S    *> 10.10.34.0/24 [1/0] via 10.10.31.16, eth2

```

- O 10.10.34.0/24 [110/31] via 10.10.31.16, eth2, 00:21:19
  - The same prefix was learned from OSPF and from static route configuration.
  - Static routes are preferred over OSPF routes, so the static route is selected and installed in the FIB.
- Note: If the static route becomes unavailable, OcnOS automatically selects the OSPF route and installs it in the FIB.

### Example: Display VRF Routes

The following is the output with the `vrf` parameter:

```
#show ip route vrf vrf31
Codes: K - kernel, C - connected, S - static, R - RIP, B - BGP
O - OSPF, IA - OSPF inter area
N1 - OSPF NSSA external type 1, N2 - OSPF NSSA external type 2
E1 - OSPF external type 1, E2 - OSPF external type 2
i - IS-IS, L1 - IS-IS level-1, L2 - IS-IS level-2,
ia - IS-IS inter area, E - EVPN,
v - vrf leaked
* - candidate default

IP Route Table for VRF "vrf31"
O      2.2.2.2/32 [110/2] via 21.1.1.2, vlan1.4, 00:01:29
O      10.1.1.0/24 [110/2] via 21.1.1.2, vlan1.4, 00:01:29
O      20.1.1.0/24 [110/2] via 21.1.1.2, vlan1.4, 00:01:29
C      21.1.1.0/24 is directly connected, vlan1.4, 00:02:54
C      31.31.1.1/32 is directly connected, lo.vrf31, 00:03:02
O      40.40.1.1/32 [110/3] via 21.1.1.2, vlan1.4, 00:00:43
C      127.0.0.0/8 is directly connected, lo.vrf31, 00:03:05

Gateway of last resort is not set
```

The following is the output with the `vrf database` parameter:

```
#show ip route vrf vrf31 database
Codes: K - kernel, C - connected, S - static, R - RIP, B - BGP
O - OSPF, IA - OSPF inter area
N1 - OSPF NSSA external type 1, N2 - OSPF NSSA external type 2
E1 - OSPF external type 1, E2 - OSPF external type 2
i - IS-IS, L1 - IS-IS level-1, L2 - IS-IS level-2,
ia - IS-IS inter area, E - EVPN,
v - vrf leaked
> - selected route, * - FIB route, p - stale info

IP Route Table for VRF "vrf31"
O      *> 2.2.2.2/32 [110/2] via 21.1.1.2, vlan1.4, 00:01:32
O      *> 10.1.1.0/24 [110/2] via 21.1.1.2, vlan1.4, 00:01:32
O      *> 20.1.1.0/24 [110/2] via 21.1.1.2, vlan1.4, 00:01:32
C      *> 21.1.1.0/24 is directly connected, vlan1.4, 00:02:57
O      21.1.1.0/24 [110/1] is directly connected, vlan1.4, 00:02:57
C      *> 31.31.1.1/32 is directly connected, lo.vrf31, 00:03:05
O      31.31.1.1/32 [110/1] is directly connected, lo.vrf31, 00:03:00
O      *> 40.40.1.1/32 [110/3] via 21.1.1.2, vlan1.4, 00:00:46
B      > 50.1.1.0/24 [200/0] via 41.41.41.41, 00:00:18
C      *> 127.0.0.0/8 is directly connected, lo.vrf31, 00:03:08

Gateway of last resort is not set
```





## show ip vrf

This command displays routing information about VRFs.

### Command Syntax

```
show ip vrf
show ip vrf WORD
```

### Parameter

WORD                      Virtual Routing and Forwarding name.

### Command Mode

Exec mode and Privileged Exec mode

### Applicability

This command was introduced before OcNOS version 1.3.

### Example

```
#show ip forwarding
vrf (management) :IP forwarding is on
vrf (default) :IP forwarding is on
```

---

## show ipv6 forwarding

Use this command to display the IPv6 forwarding status.

### Command Syntax

```
show ipv6 forwarding
```

### Parameters

None

### Command Mode

Exec mode and Privileged Exec mode

### Applicability

This command was introduced before OcNOS version 1.3.

### Example

The following is a sample output of the `show ipv6 forwarding` command displaying the IPv6 forwarding status.

```
#show ipv6 forwarding
vrf (management) :IPv6 forwarding is on
vrf (default) :IPv6 forwarding is on#
```

---

## show ipv6 interface brief

Use this command to display information about interfaces. To display information about a specific interface, include the interface name.

### Command Syntax

```
show ipv6 interface brief
show ipv6 interface IFNAME brief
```

### Parameters

IFNAME                      Name of the interface.

### Command Mode

Exec mode and Privileged Exec mode

### Applicability

This command was introduced before OcNOS version 1.3.

### Example

```
#show ipv6 interface brief
Interface                      IPv6-Address                      Admin-Status
lo                                ::1                                [up/up]

gre0                              unassigned                        [admin down/down]

eth3                              3ffe:abcd:104::1                   [up/up]
                                 3ffe:abcd:103::1
                                 fe80::2e0:29ff:fe6f:cf0

eth1                              fe80::260:97ff:fe20:f257           [up/up]

eth2                              unassigned                        [admin down/down]

eth3                              unassigned                        [admin down/down]

sit0                              unassigned                        [admin down/down]

tun24                             unassigned                        [admin down/down]

tun10                             unassigned                        [admin down/down]
```

[Table 21-68](#) explains the each interface brief entry.

**Table 21-68: show interface brief output details**

Field	Description
Interface	Name of the interface.
IPv6-Address	IPv6 address. An asterisk (“*”) means the address was assigned by the DHCPv6 client.
Admin-Status	Status of the interface:  The first part of the field indicates if the interface is up. The second part indicates if the interface is running.

---

## show ipv6 route

Use this command to display the IP routing table for a protocol or from a particular table, including database entries known by NSM. When multiple entries are available for the same prefix, NSM uses an internal route selection mechanism based on protocol administrative distance and metric values to choose the best route. The best routes in the FIB can be viewed using `show ipv6 route`.

### Command Syntax

```
show ipv6 route vrf WORD (database|)
show ipv6 route vrf WORD (database|) (bgp|connected|isis|kernel|ospf|rip|static)
show ipv6 route (database)
show ipv6 route (database) (bgp|connected|isis|kernel|ospf|rip|static)
show ipv6 route X:X::X:X
show ipv6 route X:X::X:X/M
show ipv6 route summary
```

### Parameters

X:X::X:X	Network in the IP routing table.
X:X::X:X/M	Prefix <network>/<length>, e.g., 35.0.0.0/8
all	All IPv6 routes
bgp	Border Gateway Protocol.
connected	Connected.
database	IPv6 routing table database.
isis	IS-IS.
IFNAME	Interface name
kernel	Kernel.
ospf	Open Shortest Path First.
rip	Routing Information Protocol.
static	Static routes.
summary	Summarize all routes
WORD	Routes from a Virtual Routing and Forwarding instance

### Command Mode

Exec mode and Privileged Exec mode

### Applicability

This command was introduced before OcNOS version 1.3.

### Examples

See [Table 21-66](#) and [Table 21-67](#) for an explanation of the codes and fields in the output.

```
#show ipv6 route
Codes: K - kernel route, C - connected, S - static, R - RIPng, O - OSPFv3,
```

## Interface Commands

---

```
      I - IS-IS, B - BGP, > - selected route, * - FIB route, p - stale info.  
C> * ::1/128 is directly connected, lo  
C> * 3ffe:1::/48 is directly connected, eth1  
C> * 3ffe:2:2::/48 is directly connected, eth2  
#
```

---

## show ipv6 prefix-list

Use this command to display the prefix list entries for IPv6 interfaces.

### Syntax Description

```
show ipv6 prefix-list
show ipv6 prefix-list WORD
show ipv6 prefix-list WORD seq <1-4294967295>
show ipv6 prefix-list WORD X:X::X:X/M
show ipv6 prefix-list WORD X:X::X:X/M longer
show ipv6 prefix-list WORD X:X::X:X/M first-match
show ipv6 prefix-list summary
show ipv6 prefix-list summary WORD
show ipv6 prefix-list detail
show ipv6 prefix-list detail WORD
```

### Parameters

WORD	Name of prefix list.
X:X::X:X/M	IP prefix <network>/<length> (for example, 35.0.0.0/8).
first-match	First matched prefix.
longer	Look up longer prefix.
<1-4294967295>	Sequence number of an entry.
detail	Detail of prefix lists.
summary	Summary of prefix lists.

### Command Mode

Privileged Exec mode

### Applicability

This command was introduced before OcNOS version 1.3.

### Example

The following is a sample output of the `show ip prefix-list` command showing prefix-list entries.

```
#show ip prefix-list
ip prefix-list myPrefixList: 3 entries
  seq      5 permit 172.1.1.0/16
  seq     10 permit 173.1.1.0/16
  seq     15 permit 174.1.1.0/16
```

## show hosts

Use this command to display the IP domain-name, lookup style and any name server.

### Command Syntax

```
show hosts
```

### Parameters

None

### Command Mode

Exec mode and Privileged Exec mode

### Applicability

This command was introduced before OcNOS version 1.3.

### Example

```
#show hosts

      VRF: management

DNS lookup is enabled
Default domain      : .com
Additional Domain   : .in .ac
Name Servers        : 10.12.3.23
Host                Address
----              -
test               10.12.12.67
test               10::23

* - Values assigned by DHCP Client.
```

[Table 21-69](#) explains the output fields.

**Table 21-69: show hosts fields**

Entry	Description
VRF: management	DNS configuration of specified VRF
DNS lookup is enabled	DNS feature enabled or disabled
Default domain	Default domain name used to complete unqualified host names (names without a dotted decimal domain name).
Additional Domain	A list of default domain names used to complete unqualified host names. Each domain in the list is to be tried in turn.
Name Servers	DNS server addresses that are used to translate hostnames to IP addresses.



**Table 21-69: show hosts fields**

<b>Entry</b>	<b>Description</b>
Host    Address test  10.12.12.67 test  10::23	Static hostname-to-address mappings in DNS.
* - Values assigned by DHCP Client.	* in name-server indicates it has been learned dynamically.

## show running-config interface

Use this command to show the running system status and configuration for a specified interface, or a specified interface for a specified protocol.

### Command Syntax

```
show running-config interface IFNAME
show running-config interface IFNAME bridge
show running-config interface IFNAME ip igmp
show running-config interface IFNAME ip multicast
show running-config interface IFNAME ip pim
show running-config interface IFNAME ipv6 ospf
show running-config interface IFNAME ipv6 rip
show running-config interface IFNAME ipv6 pim
show running-config interface IFNAME isis
show running-config interface IFNAME lacp
show running-config interface IFNAME ldp
show running-config interface IFNAME mpls
show running-config interface IFNAME mstp
show running-config interface IFNAME ospf
show running-config interface IFNAME ptp
show running-config interface IFNAME rip
show running-config interface IFNAME rstp
show running-config interface IFNAME rsvp
show running-config interface IFNAME stp
show running-config interface IFNAME synce
```

### Parameters

bridge	Bridge.
ip	IPv4 (see also <a href="#">show running-config interface ip</a> ).
ipv6	IPv6 (see also <a href="#">show running-config interface ipv6</a> ).
isis	Intermediate System to Intermediate System.
lacp	Link Aggregation Control Protocol.
ldp	Label Distribution Protocol.
mpls	Multi-Protocol Label Switching.
mstp	Multiple Spanning Tree Protocol.
ospf	Open Shortest Path First.
ptp	Precision Time Protocol.
rip	Routing Information Protocol.

---

rstp	Rapid Spanning Tree Protocol.
rsvp	Resource Reservation Protocol.
stp	Spanning Tree Protocol.
synce	Synchronous Ethernet.

### Command Mode

Privileged Exec mode and Config Mode

### Applicability

This command was introduced before OcNOS version 1.3.

### Example

```
#show running-config interface eth1 bridge
!
interface eth1
  switchport
  bridge-group 1
  switchport mode access
  user-priority 3
  traffic-class-table user-priority 2 num-traffic-classes 3 value 3 traffic-
class-table user-priority 7 num-traffic-classes 1 value 2 traffic-class-table
user-priority 7 num-traffic-classes 2 value 0 traffic-class-table user-
priority 7 num-traffic-classes 3 value 0 traffic-class-table user-priority 7
num-traffic-classes 4 value 0 traffic-class-table user-priority 7 num-traffic-
classes 5 value 0 traffic-class-table user-priority 7 num-traffic-classes 6
```

---

## show running-config interface ip

Use this command to show the running system status and configuration for a specified IP.

### Command Syntax

```
show running-config interface IFNAME ip (igmp|multicast|pim|)
```

### Parameters

IFNAME	Interface name.
igmp	Internet Group Management Protocol.
multicast	Multicast.
pim	Protocol Independent Multicast.

### Command Mode

Privileged Exec mode

### Applicability

This command was introduced before OcNOS version 1.3.

### Example

```
#show running-config interface eth1 ip igmp
!  
interface eth1  
  switchport
```

---

## show running-config interface ipv6

Use this command to show the running system status and configuration for a specified IPv6 protocol.

### Command Syntax

```
show running-config interface IFNAME ipv6 (mld|multicast|ospf|pim|rip|)
```

### Parameters

IFNAME	Interface name.
mld	Multicast Listener Discovery
multicast	Multicast
ospf	Open Shortest Path First
pim	Protocol Independent Multicast
rip	Routing Information Protocol

### Command Mode

Privileged Exec mode

### Applicability

This command was introduced before OcNOS version 1.3.

### Example

```
#show running-config interface eth1 ipv6 rip
!
interface eth1
 switchport
```

---

## show running-config ip

Use this command to show the running system of IP configurations.

### Command Syntax

```
show running-config ip (dhcp|mroute|route)
```

### Parameters

dhcp	Dynamic Host Configuration Protocol.
mroute	Static IP multicast route.
route	Static IP route.

### Command Mode

Privileged Exec mode

### Applicability

This command was introduced before OcnOS version 1.3.

### Example

```
>enable
#show running-config ip route
!
ip route 3.3.3.3/32 eth3
ip route 3.3.3.3/32 eth2
ip route 200.0.0.0/16 lo
!
```

---

## show running-config ipv6

Use this command to show the running system status and configuration for IPv6.

### Command Syntax

```
show running-config ipv6 (access-list|mroute|neighbor|prefix-list|route|)
```

### Parameters

access-list	Access list.
mroute	Static IPv6 Multicast route.
neighbor	Static IPv6 neighbor entry.
prefix-list	IPv6 prefix-list.
route	Static IPv6 route.

### Command Mode

Privileged Exec mode

### Applicability

This command was introduced before OcNOS version 1.3.

### Example

```
>enable
#show running-config ipv6 access-list
!
ipv6 access-list abc permit any
!
#show running-config ipv6 prefix-list
!
ipv6 prefix-list sde
seq 5 permit any
!
#show running-config ipv6 route
!
ipv6 route 3e11::/64 lo
ipv6 route 3e11::/64 eth2
ipv6 route fe80::/64 eth2
!
```

---

## show running-config prefix-list

Use this command to display the running system status and configuration details for prefix lists.

### Command Syntax

```
show running-config prefix-list
```

### Parameters

None

### Command Mode

Privileged exec mode, configure mode, router-map mode

### Applicability

This command was introduced before OcNOS version 1.3.

### Example

```
>enable
(config)#show running-config prefix-list
!
ip prefix-list abc
  seq 5 permit any
!
ip prefix-list as
  description annai
!
ip prefix-list wer
  seq 45 permit any
!
(config)#
```



---

## shutdown

Use this command to shut down an interface.

Use the `no` form of this command to bring up an interface.

### Command Syntax

```
shutdown
no shutdown
```

### Parameters

None

### Default

No default value is specified

### Command Mode

Interface mode

### Applicability

This command was introduced before OcNOS version 1.3.

### Examples

The following example shows the use of the `shutdown` command to shut down the interface called `eth3`.

```
#configure terminal
(config)#interface eth3
(config-if)#shutdown
```

## speed

Use this command to set the link speed of the interface.

Use the `no` parameter to set the speed to its default value.

On copper ports, auto-negotiation is enabled by default and force speed is not supported.

On fiber optic ports, auto-negotiation is disabled by default. Auto-negotiation is not supported on fiber optic medium/AOC for speeds 10g and beyond. IP Infusion Inc. does not recommend using auto speed on such transceivers. On DAC cables, both force and auto-negotiation are supported.

IP Infusion Inc. recommends configuring the same speed mode on both peers.

When an interface is configured with the `speed auto` option, the negotiated parameters are `speed`, `duplex`, `flowcontrol`, and `fec`, each of which is configured separately. Please see the respective command for details.

Note: For 10g DAC/AOC, setting `speed auto` negotiates with a maximum of 1G.

Note: Interface speed setting is only supported on physical front-panel ports and not supported on Management interface `eth0`.

Note: Configuring or unconfiguring speed will reset FEC to auto mode.

[Table 21-70](#) shows the IP Infusion Inc. recommendations regarding front-panel port speed and transceivers.

**Table 21-70: Recommendations**

Supported/Recommended	Explanation
Not Supported	When front panel port capability is less than the transceiver's capability the behavior is undefined.
Not Recommended	When the transceiver's capability and front panel port capability is the same, reducing the speed is not recommended.
Recommended	When the transceiver's capability is less than the front panel port capability, the behavior is undefined and the link might even come up. So speed needs to be set to match the transceiver's capability.

[Table 21-71](#) show examples with front-panel configurations:

**Table 21-71: Front-panel configurations**

Front Panel Port	Explanation
Front Panel Port 100g	When 40g transceivers are used, make sure to use the command <code>speed 40g</code> . IP Infusion Inc. does not recommend using 40g on 100g speed transceivers.
Front Panel Port 40g	100g transceivers should not be used.

**Table 21-71: Front-panel configurations (Continued)**

Front Panel Port	Explanation
Front Panel Port 25g	<p>When 10g transceivers are used, make sure to use the <code>port-group</code> command to reduce the speed to 10g.  IP Infusion Inc. does not recommend to use 10g on 25g speed transceivers.  When using 1g transceivers, make sure to set the speed to 1g.</p> <p>Below 25g, port-speed can defer (10g or 1g) for ports under same port-group i.e. 1 port can have 1g &amp; remaining 10g but 1 port 25g &amp; remaining 10g not allowed.  When "no speed" command is used at interface level it tries to set speed "25g" to one of the port of port-group while other may be at 10g or 1g speed which is not allowed. Use "no port-group" command in such case.</p>
Front Panel Port 10g	<p>25g transceivers should not be used.  When using 1g transceivers, make sure to set the speed to 1g.</p>
Front Panel Port 1g	10g/25g transceivers should not be used.

**Command Syntax**

```
speed (10m | 100m | 1g | 2.5g | 10g | 20g | 25g | 40g | 50g | 100g | auto )
no speed
```

**Parameter**

10m	10 megabits
100m	100 megabits
1g	1 gigabit
2.5g	2.5 gigabits
10g	10 gigabits
20g	20 gigabits
25g	25 gigabits
40g	40 gigabits
50g	50 gigabits
100g	100 gigabits
auto	Negotiate the speed with a connected port

**Default**

No default value is specified

**Command Mode**

Interface mode

**Applicability**

This command was introduced before OcnOS version 1.3.

**Example**

Enable auto-negotiation:

## Interface Commands

---

```
#configure terminal
(config)#interface xe0
(config-if)#speed auto
```

---

## switchport

Use this command to set the mode of an interface to switched.

All interfaces are configured `routed` by default. To change the behavior of an interface from switched to routed, you must explicitly give the `no switchport` command.

**Note:** When you change the mode of an interface from switched to routed and vice-versa, all configurations for that interface are erased.

User should be prompted for confirmation, while executing `switchport/no switchport` command. To support this requirement, please refer the command `enable/disable confirmation-dialog`.

Use the `no` form of this command to set the mode to routed.

### Command Syntax

```
switchport
no switchport
```

### Parameters

None

### Default

No default value is specified

### Command Mode

Interface mode

### Applicability

This command was introduced before OcNOS version 1.3.

### Examples

```
#configure terminal
(config)#interface eth0
(config-if)#switchport

(config)#interface eth0
(config-if)#no switchport

#configure terminal
(config)#enable confirmation-dialog
(config)#interface xe5
(config-if)#switchport
Are you sure? (y/n): y
(config-if)#
(config-if)#exit

(config)#disable confirmation-dialog
(config)#
(config)#interface xe5
(config-if)#switchport
(config-if)#
```

---

## switchport allowed ethertype

Use this command to indicate which types of traffic will be allowed on the switchport.

Note: A maximum of 5 Ethertype values can be assigned on an interface.

### Command Syntax

```
switchport allowed ethertype {arp|ipv4|ipv6|mpls|ETHTYPE|log}
```

### Parameters

arp	ARP traffic
ipv4	IPv4 traffic
ipv6	IPv6 traffic
mpls	MPLS traffic
ETHTYPE	Traffic of any Ethertype value (0x600 - 0xFFFF).
log	Log unwanted ethertype packets.

### Default

No default value is specified

### Command Mode

Interface mode

### Applicability

This command was introduced before OcNOS version 1.3.

This command is not available on Qumran platforms.

### Example

```
(config)#interface xe32/1

(config-if)#switchport
(config-if)#switchport allowed ethertype ipv4
(config-if)#switchport allowed ethertype 0x800
```

---

## switchport protected

Use this command to enable or disable the protected port feature on an interface.

### Command Syntax

```
switchport protected (community | isolated | promiscuous)
no switchport protected
```

### Parameter

community	Community mode
isolated	Isolated mode type
promiscuous	Protected mode type

### Default

Promiscuous

### Command Mode

Interface mode

### Applicability

This command was introduced in OcNOS version 5.0.

### Example

```
#configure terminal
(config)#interface xe1
(config-if)#switchport protected isolated
(config-if)#no switchport protected

(config)#interface po1
(config-if)#switchport protected promiscuous
(config-if)#no switchport protected
```

---

## transceiver

Use this command to set the type of Small Form-factor Pluggable (SFP) transceiver inserted in the physical port.

Use the `no` form of this command to remove the setting.

### Command Syntax

```
transceiver (1000base-sx|1000base-lx|1000base-ex|1000base-cx|10gbase-sr|10gbase-  
lr|10gbase-er|10gbase-cr|25gbase-sr|25gbase-lr|25gbase-er|25gbase-cr|40gbase-  
sr4|40gbase-lr4|40gbase-er4|40gbase-cr4|100gbase-sr4|100gbase-lr4|100gbase-  
er4|100gbase-cr4)  
no transceiver
```

### Parameters

1000base-cx	SFP 1000base-cx
1000base-ex	SFP 1000base-ex
1000base-lx	SFP 1000base-lx
1000base-sx	SFP 1000base-sx
100gbase-cr4	QSFP28 100gbase-cr4
100gbase-er4	QSFP28 100gbase-er4
100gbase-lr4	QSFP28 100gbase-lr4
100gbase-sr4	QSFP28 100gbase-sr4
10gbase-cr	SFP+ 10gbase-cr
10gbase-er	SFP+ 10gbase-er
10gbase-lr	SFP+ 10gbase-lr
10gbase-sr	SFP+ 10gbase-sr
25gbase-cr	SFP+ 25gbase-cr
25gbase-ers	SFP+ 25gbase-er
25gbase-lr	SFP+ 25gbase-lr
25gbase-sr	SFP+ 25gbase-sr
40gbase-cr4	QSFP 40gbase-cr4
40gbase-er4	QSFP 40gbase-er4
40gbase-lr4	QSFP 40gbase-lr4
40gbase-sr4	QSFP 40gbase-sr4

### Default

No default value is specified

### Command Mode

Interface mode



**Applicability**

This command was introduced in OcNOS version 5.0.

**Examples**

```
(config)#interface ce1/1
(config-if)#transceiver 40gbase-lr4
```

---

## **poe-enable**

Use this command to enable Power over Ethernet feature for PoE supported interfaces.

Use the no form of this command to disable Power over Ethernet feature on PoE supported interfaces.

Note: Command is supported only for boards which supports PoE interfaces:

### **Command Syntax**

poe-enable

### **Parameter**

None

### **Default**

No default value is specified

### **Command Mode**

Interface mode

### **Applicability**

This command was introduced before OcnOS version 5.1.

### **Example**

```
#configure terminal
(config)#interface gel
(config-if)#poe-enable
(config)#gel
(config-if)#no poe-enable
```

---

## show interface poe-status

Use this command to display PoE enabled status for single interface or all the interface.

Note: Command is applicable only for boards which supports PoE interfaces.

### Command Syntax

```
show interface (IFNAME|) poe-status
```

### Parameters

**IFNAME** Interface name. If not specified, this command displays PoE enabled status for all the PoE applicable ports.

### Default

None

### Command Mode

Exec mode

### Applicability

This command was introduced before OcNOS version 5.1.

### Example

```
#show interface poe-status
-----
Interface          State
-----
ge1                 Enabled
ge2                 Enabled
ge3                 Disabled
ge4                 Disabled
xe27                Disabled
xe28                Disabled
#
#show interface ge1 poe-status
-----
Interface          State
-----
ge1                 Enabled
#
```



## CHAPTER 22 Access Control List Commands (Standard)

---

This chapter is a reference for the standard Access Control List (ACL) commands:

- [ip access-list standard](#)
- [ip access-list standard filter](#)
- [ipv6 access-list standard](#)
- [ipv6 access-list standard filter](#)

---

## ip access-list standard

Use this command to define a standard IP access control list (ACL) in which multiple specifications can be configured. A specification determines whether to accept or drop an incoming IP packet based on the source IP address, either an exact match or a range of prefixes.

Standard ACL can be used by L3 and SNMP protocols to permit or deny IP packets from a host or a range of prefixes.

Use the `no` form of this command to remove the ACL.

Note: Standard access-lists are not allowed to be attached on interfaces and are used for protocol level filtering purposes.

### Command Syntax

```
ip access-list standard NAME
no ip access-list standard NAME
```

### Parameters

NAME                      Standard IP access-list name.

### Default

No default value is specified

### Command Mode

Configure mode

### Applicability

This command was introduced in OcNOS version 3.0.

### Examples

```
#configure terminal
(config)#ip access-list standard ip-acl-01
(config-ip-acl-std)#exit
(config)#no ip access-list standard ip-acl-01
```

---

## ip access-list standard filter

Use this command to configure access control entry in an access control list (ACL).

This command determines whether to accept or drop a packet based on the configured source IP address.

Use the `no` form of this command to remove an ACL specification.

### Command Syntax

```
(deny|permit) (A.B.C.D/M|A.B.C.D A.B.C.D|host A.B.C.D|any)
no (deny|permit) (A.B.C.D/M|A.B.C.D A.B.C.D|host A.B.C.D|any)
```

### Parameters

<code>deny</code>	Drop the packet.
<code>permit</code>	Accept the packet.
<code>A.B.C.D/M</code>	Source IP prefix and length.
<code>A.B.C.D A.B.C.D</code>	Source IP address and mask.
<code>host A.B.C.D</code>	A single source host IP address.
<code>any</code>	Match any source IP address.

### Default

No default value is specified

### Command Mode

Standard IP access-list mode

### Applicability

This command was introduced in OcNOS version 3.0

### Examples

```
#configure terminal
(config)#ip access-list ip-acl-01
(config-ip-acl-std)#permit 30.30.30.0/24
(config-ip-acl-std)#no permit 30.30.30.0/24
```

---

## IPv6 access-list standard

Use this command to define a standard IPv6 access control list (ACL) in which multiple specifications can be configured. A specification determines whether to accept or drop an incoming IPv6 packet based on the source IPv6 address, either an exact match or a range of prefixes.

Standard IPv6 ACL can be used by L3 protocols to permit or deny IPv6 packets from a host or a range of prefixes.

Use the `no` form of this command to remove the ACL.

Note: Standard access-lists are not allowed to be attached on interfaces and are used for protocol level filtering purposes.

### Command Syntax

```
ipv6 access-list standard NAME
no ipv6 access-list standard NAME
```

### Parameters

NAME                      Standard IPv6 access-list name.

### Default

No default value is specified

### Command Mode

Configure mode

### Applicability

This command was introduced in OcnOS version 3.0.

### Examples

```
#configure terminal
(config)#ipv6 access-list standard ipv6-acl-01
(config-ipv6-acl-std)#exit
(config)#no ipv6 access-list standard ipv6-acl-01
```



---

## ipv6 access-list standard filter

Use this command to configure access control entry in an access control list (ACL). This determines whether to accept or drop a packet based on the configured IPv6 prefix.

Use the `no` form of this command to remove an ACL specification.

### Command Syntax

```
(deny|permit) (X:X::X:X/M|X:X::X:X X:X::X:X|any)
no (deny|permit) (X:X::X:X/M|X:X::X:X X:X::X:X|any)
```

### Parameters

<code>deny</code>	Drop the packet.
<code>permit</code>	Accept the packet.
<code>X:X::X:X/M</code>	Source address with network mask length.
<code>X:X::X:X X:X::X:X</code>	Source address with wild card mask.
<code>any</code>	Any source address.

### Default

No default value is specified

### Command Mode

Standard IPv6 access-list mode

### Applicability

This command was introduced in OcNOS version 3.0.

### Examples

```
#configure terminal
(config)#ipv6 access-list standard ipv6-acl-01
(config-ipv6-acl-std)#permit 2000::0/64
(config-ipv6-acl-std)#no permit 2000::0/64
```



---

## CHAPTER 23 Access Control List Commands

---

This chapter is a reference for the Access Control List (ACL) commands:

- `arp access-group`
- `arp access-list`
- `arp access-list default`
- `arp access-list remark`
- `arp access-list request`
- `arp access-list resequence`
- `arp access-list response`
- `clear access-list`
- `clear arp access-list`
- `clear ip access-list`
- `clear ipv6 access-list`
- `clear mac access-list`
- `ip access-group`
- `ip access-list`
- `ip access-list default`
- `ip access-list filter`
- `ip access-list icmp`
- `ip access-list remark`
- `ip access-list resequence`
- `ip access-list tcp|udp`
- `ipv6 access-group in`
- `ipv6 access-list`
- `ipv6 access-list default`
- `ipv6 access-list filter`
- `ipv6 access-list icmpv6`
- `ipv6 access-list remark`
- `ipv6 access-list resequence`
- `ipv6 access-list sctp`
- `ipv6 access-list tcp|udp`
- `mac access-group`
- `mac access-list`
- `mac access-list default`
- `mac access-list filter`
- `mac access-list remark`
- `mac access-list resequence`

- `show access-lists`
- `show arp access-lists`
- `show ip access-lists`
- `show ipv6 access-lists`
- `show mac access-lists`
- `show running-config access-list`
- `show running-config aclmgr`
- `show running-config ipv6 access-list`

---

## arp access-group

Use this command to attach an ARP access list to an interface to filter incoming ARP packets.

When you attach an ARP access list to a LAG interface as well as to a physical interface that is a member of that LAG interface, the priority order is:

1. LAG interface
2. Physical interface

Use the `no` form of this command to detach an ARP access group.

Note: An ARP access-list is supported only on switch ports.

Note: To attach an ARP access-group to an interface, the `ingress-arp` TCAM group should be enabled. See the [hardware-profile filter](#) command for details.

### Command Syntax

```
arp access-group NAME in
no arp access-group NAME in
```

### Parameters

NAME	ARP access list name
------	----------------------

### Command Mode

Interface mode

### Applicability

This command was introduced in OcNOS version 3.0.

### Example

```
#configure terminal
(config)#arp access-list arp1
(config-arp-acl)#permit ip any mac any
(config-arp-acl)#exit

(config)#interface xe1
(config-if)#arp access-group arp1 in
(config-if)#exit

(config)#interface xe1
(config-if)#no arp access-group arp1 in
(config-if)#exit
```

---

## arp access-list

Use this command to define a named access control list (ACL) that determines whether to accept or drop the ARP packets, based on the ARP request or response option configured.

An ACL is made up of one or more ACL specifications. You can repeat this command and add multiple specifications. Each time you give this command, the specification is added to the end of the list.

Each packet that arrives at the device is compared to each specification in each ACL in the order that they are defined. The device continues to look until it has a match. If no match is found and the device reaches the end of the list, the packet is denied. For this reason, place the most frequently occurring specifications at the top of the list.

The device stops checking the specifications after a match occurs.

There is an implied deny specification for traffic that is not permitted. A single-entry ACL with only one deny specification is the same as denying all traffic. You must have at least one permit specification in an ACL or all traffic is blocked.

Use the `no` form of this command to remove an ACL specification.

Note: An ARP access list is supported only on switch ports.

### Command Syntax

```
arp access-list NAME
no arp access-list NAME
```

### Parameters

NAME	ARP access list name
------	----------------------

### Command Mode

Configure mode

### Applicability

This command was introduced in OcNOS version 3.0.

### Example

```
#configure terminal
(config)#arp access-list arp1
```

---

## arp access-list default

Use this command to modify the default rule action of an access list.

The default rule is applicable only when an access list is attached to an interface. The default rule will have the lowest priority and only ARP packets not matching any of the user defined rules match the default rule.

### Command Syntax

```
default (deny-all|permit-all)
```

### Parameters

deny-all	Drop all packets.
permit-all	Accept all packets.

### Default

The default rule is `deny-all` when an access list is attached to an interface.

### Command Mode

ARP access-list mode

### Applicability

This command was introduced in OcNOS version 3.0.

### Examples

```
#configure terminal
(config)#arp access-list arp1
(config-arp-acl)#default permit-all
```

---

## arp access-list remark

Use this command to add a description to a named ARP access control list (ACL).

Use the `no` form of this command to remove an ACL description.

### Command Syntax

```
remark LINE
no remark
```

### Parameters

`LINE`                   ACL description up to 100 characters.

### Command Mode

ARP access-list mode

### Applicability

This command was introduced in OcNOS version 3.0.

### Example

```
#configure terminal
(config)#arp access-list arp1
(config-arp-acl)# remark Permit arp request packets
```



---

## arp access-list request

Use this command to configure ARP access control entry in an ARP access control list (ACL).

This command determines whether to accept or drop a packet based on the configured match criteria.

Use the `no` form of this command to remove an ACL specification.

**Note:** Configuring the same filter again with a change of sequence number or change of action will result in updating the sequence number or filter action.

### Command Syntax

```
(<1-268435453>|) (deny|permit) (request |) ip (A.B.C.D/M|A.B.C.D A.B.C.D|host
A.B.C.D|any) mac (any | ((XX-XX-XX-XX-XX-XX|XX:XX:XX:XX:XX:XX|XXXX.XXXX.XXXX)
(XX-XX-XX-XX-XX-XX|XX:XX:XX:XX:XX:XX|XXXX.XXXX.XXXX)) | (host (XX-XX-XX-XX-XX-
XX|XX:XX:XX:XX:XX:XX|XXXX.XXXX.XXXX))) (vlan <1-4094>|) (inner-vlan <1-4094>|)
no (<1-268435453>|) (deny|permit) (request |) ip (A.B.C.D/M|A.B.C.D A.B.C.D|host
A.B.C.D|any) mac (any | ((XX-XX-XX-XX-XX-XX|XX:XX:XX:XX:XX:XX|XXXX.XXXX.XXXX)
(XX-XX-XX-XX-XX-XX|XX:XX:XX:XX:XX:XX|XXXX.XXXX.XXXX)) | (host (XX-XX-XX-XX-XX-
XX|XX:XX:XX:XX:XX:XX|XXXX.XXXX.XXXX))) (vlan <1-4094>|) (inner-vlan <1-4094>|)
```

### Parameters

<1-268435453>	ARP ACL sequence number.
deny	Drop the packet.
permit	Accept the packet.
request	ARP request.
ip	Internet Protocol (IP).
A.B.C.D/M	Source IP prefix and length.
A.B.C.D A.B.C.D	Source IP address and mask.
host A.B.C.D	A single source host IP address.
any	Match any source IP address.
mac	MAC address configuration.
any	Match any source mac address.
XX-XX-XX-XX-XX-XX	Source MAC address (Option 1).
XX:XX:XX:XX:XX:XX	Source MAC address (Option 2).
XXXX.XXXX.XXXX	Source MAC address (Option 3).
XX-XX-XX-XX-XX-XX	Source wildcard (Option 1).
XX:XX:XX:XX:XX:XX	Source wildcard (Option 2).
XXXX.XXXX.XXXX	

Source wildcard (Option 3).

host (XX-XX-XX-XX-XX-XX)

A single source host MAC address.

vlan <1-4094> VLAN identifier.

inner-vlan <1-4094>

Inner VLAN identifier.

### Command Mode

ARP access-list mode

### Applicability

This command was introduced in OcNOS version 3.0.

### Examples

```
#configure terminal
(config)#arp access-list arp1
(config-arp-acl)#10 permit request ip 1.1.1.0/24 mac 0000.0000.0001 FFFF.FFFF.FFF0
(config-arp-acl)#no 10
```

---

## arp access-list resequence

Use this command to modify the sequence numbers of an ARP access list.

Note: IP Infusion Inc. recommends to use a non-overlapping sequence space for a new sequence number set to avoid unexpected rule matches during transition.

Note: Re-sequencing an ACL attached to a management interface clears the ACL counters associated to it.

### Command Syntax

```
resequence <1-268435453> INCREMENT
```

### Parameters

<1-268435453>	Starting sequence number.
INCREMENT	Sequence number increment steps.

### Command Mode

ARP access-list mode

### Applicability

This command was introduced in OcNOS version 3.0.

### Example

```
#configure terminal
(config)#arp access-list arp1
(config-arp-acl)#resequence 15 15
```

## arp access-list response

Use this command to configure an ARP access control entry in an ARP access control list (ACL).

This command determines whether to accept or drop an ARP response packet based on the configured match criteria.

Use the `no` form of this command to remove an ACL specification.

Note: Configuring the same filter again with a change of sequence number or change of action will result in updating the sequence number or filter action.

### Command Syntax

```
(<1-268435453>|) (deny|permit) response ip (A.B.C.D/M|A.B.C.D A.B.C.D|host
A.B.C.D|any) (A.B.C.D/M|A.B.C.D A.B.C.D|host A.B.C.D|any) mac (any | ((XX-XX-XX-
XX-XX-XX|XX:XX:XX:XX:XX:XX|XXXX.XXXX.XXXX) -XX-XX-XX-
XX|XX:XX:XX:XX:XX:XX|XXXX.XXXX.XXXX)) | (host (XX-XX-XX-XX-XX-
XX|XX:XX:XX:XX:XX:XX|XXXX.XXXX.XXXX)) (any | ((XX-XX-XX-XX-XX-
XX|XX:XX:XX:XX:XX:XX|XXXX.XXXX.XXXX) (XX-XX-XX-XX-XX-
XX|XX:XX:XX:XX:XX:XX|XXXX.XXXX.XXXX)) | (host (XX-XX-XX-XX-XX-
XX|XX:XX:XX:XX:XX:XX|XXXX.XXXX.XXXX))) (vlan <1-4094>|) (inner-vlan <1-4094>|)
no (<1-268435453>|) (deny|permit) response ip (A.B.C.D/M|A.B.C.D A.B.C.D|host
A.B.C.D|any) (A.B.C.D/M|A.B.C.D A.B.C.D|host A.B.C.D|any) mac (any | ((XX-XX-XX-
XX-XX-XX|XX:XX:XX:XX:XX:XX|XXXX.XXXX.XXXX) -XX-XX-XX-
XX|XX:XX:XX:XX:XX:XX|XXXX.XXXX.XXXX)) | (host (XX-XX-XX-XX-XX-
XX|XX:XX:XX:XX:XX:XX|XXXX.XXXX.XXXX)) (any | ((XX-XX-XX-XX-XX-
XX|XX:XX:XX:XX:XX:XX|XXXX.XXXX.XXXX) (XX-XX-XX-XX-XX-
XX|XX:XX:XX:XX:XX:XX|XXXX.XXXX.XXXX)) | (host (XX-XX-XX-XX-XX-
XX|XX:XX:XX:XX:XX:XX|XXXX.XXXX.XXXX))) (vlan <1-4094>|) (inner-vlan <1-4094>|)
```

### Parameters

<1-268435453>	ARP ACL sequence number.
deny	Drop the packet.
permit	Accept the packet.
response	ARP response
A.B.C.D/M	Source/destination IP prefix and length.
A.B.C.D A.B.C.D	Source/destination IP address and mask.
host A.B.C.D	A single source/destination host IP address.
any	Match any source/destination IP address.
mac	MAC address configuration.
any	Match any source/destination MAC address.
XX-XX-XX-XX-XX-XX	Source/destination MAC address (Option 1).
XX:XX:XX:XX:XX:XX	Source/destination MAC address (Option 2).
XXXX.XXXX.XXXX	Source/destination MAC address (Option 3).

XX-XX-XX-XX-XX-XX  
Source/destination wildcard (Option 1).

XX:XX:XX:XX:XX:XX  
Source/destination wildcard (Option 2).

XXXX.XXXX.XXXX Source/destination wildcard (Option 3).

vlan <1-4094> VLAN identifier.

inner-vlan <1-4094>  
Inner VLAN identifier.

### Command Mode

ARP access-list mode

### Applicability

This command was introduced in OcNOS version 3.0.

### Example

```
#configure terminal
(config)#arp access-list arp1
(config-arp-acl)#10 permit response ip 1.1.1.0/24 mac 0000.0000.0001 FFFF.FFFF.FFF0
(config-arp-acl)#no 10
```

---

## clear access-list

Use this command to clear the access-list counters.

### Command Syntax

```
clear access-list (NAME|) counters
```

### Parameters

NAME                      Access-list name.

### Command Mode

Exec mode and Privilege exec mode

### Applicability

This command was introduced before OcnOS version 1.3.

### Examples

```
#clear access-list counters
```

---

## clear arp access-list

Use this command to clear the ARP access-list counters.

### Command Syntax

```
clear arp access-list (NAME|) counters
```

### Parameters

NAME                      ARP access list name

### Command Mode

Exec mode and privileged exec mode

### Applicability

This command was introduced in OcNOS version 3.0.

### Example

```
#clear arp access-list counters
```

---

## clear ip access-list

Use this command to clear the IP access-list counters.

### Command Syntax

```
clear ip access-list (NAME|) counters
```

### Parameters

NAME                      Access-list name.

### Command Mode

Exec mode and Privilege exec mode

### Applicability

This command was introduced before OcnOS version 1.3.

### Examples

```
#clear ip access-list counters
```



---

## clear ipv6 access-list

Use this command to clear the IPv6 access-list counters.

### Command Syntax

```
clear ipv6 access-list (NAME|) counters
```

### Parameters

NAME                      Access-list name.

### Command Mode

Exec mode Privilege exec mode

### Applicability

This command was introduced before OcnOS version 1.3.

### Examples

```
#clear ipv6 access-list counters
```

---

## clear mac access-list

Use this command to clear the MAC access-list counters.

### Command Syntax

```
clear mac access-list (NAME|) counters
```

### Parameters

NAME                      Access-list name.

### Command Mode

Exec mode Privilege exec mode

### Applicability

This command was introduced before OcNOS version 1.3.

### Examples

```
#clear mac access-list counters
```

---

## ip access-group

Use this command to attach an IP access list to an interface or terminal line to filter incoming or outgoing IP packets.

The `time-range` parameter is optional. If used, the access-group is tied to the timer specified.

After the access-group has been configured with the time-range, to detach the access-group from the time-range, use the `no` form of this command with a time-range parameter as shown in the syntax and examples below.

To delete the access-group, use the `no` form of this command without a time-range.

**Note:** An egress IP ACL is supported on physical and lag interfaces only. An egress IP ACL will match only routed traffic and not switched traffic. VLAN and inner-VLAN options in ACL rules will match incoming packet VLANs even when ACL attached at egress.

### Command Syntax

```
ip access-group NAME (in|out) (time-range TR_NAME|)
no ip access-group NAME (in|out) (time-range TR_NAME|)
```

### Parameters

NAME	Access list name.
in	Filter incoming packets
out	Filter outgoing packets.
TR_NAME	Time range name set with the <a href="#">time-range</a> command.

### Command Mode

Line mode

Interface mode

### Applicability

This command was introduced before OcNOS version 3.0. The `time-range` parameter was added in OcNOS version 5.0.

### Examples

```
#configure terminal
(config)#ip access-list mylist
(config-ip-acl)#permit ip any any
(config-ip-acl)#exit

(config)#hardware-profile filter ingress-ipv4-ext enable

(config)#interface xe3
(config-if)#ip access-group mylist in
(config-if)#exit

(config)#interface xe3
(config-if)#no ip access-group mylist in time-range TIMER1
(config-if)#exit
```

```
(config)#line vty
(config-all-line)#no ip access-group mylist in
```

### Usage: VLANs and LAGs

When you attach an access list to a VLAN interface or LAG interface as well as to a physical interface that is a member of that LAG and/or VLAN interface, the priority order is:

1. VLAN interface
2. LAG interface
3. Physical interface

For example, if you attach access lists to both a LAG interface and a physical interface that is a member of that LAG, matching traffic rules are applied to the LAG interface, but not to the physical interface.

### Usage: TCAM Groups

An access-group in the egress direction uses the TCAM group used by the QoS output service policy. Therefore, actions are unpredictable when conflicting matches are configured on same interface. IP Infusion Inc. recommends to avoid such a configuration. Otherwise, you need to configure the priority (in QoS) or the sequence number (in ACL) carefully to handle such cases.

To attach an IP ACL in the ingress direction the `ingress-ipv4` or `ingress-ipv4-ext` TCAM group needs to be enabled and to attach an IP ACL in the egress direction the `egress-ipv4` TCAM group needs to be enabled. See the [hardware-profile filter](#) commands for details.

### Usage: VTY Interfaces

You can create ACLs for VTY interfaces to filter packets from management applications such as SSH, Telnet, NTP, SNMP, and SNMP traps. TCP, UDP, and ICMP are supported.

For an ACL for VTY, you create the ACL, configure it with rules, and associate the ACL to the terminal line in line mode.

VTY ACLs do not support the following:

- The default rule `deny all`. You must explicitly set up a `deny all` rule based on your requirements.
- VLAN-specific rules.
- Rules with TCP flags.
- Rules with `dscp`, `fragments`, `log`, `precedence`, and `sample` parameters.
- Rules with ICMP code and message types.

### Usage: Timed ACL on interfaces

You create a timer range that is identified by a name and configured with a start time, end time, and frequency. Once you create the time range, you can tie the ACL configuration to the time-range object. This allows you to create an access group that is enabled when the timer has started and disabled when the timer ends. You can also disassociate an access group from the timer if needed.

---

## ip access-list

Use this command to define a named access control list (ACL) that determines whether to accept or drop an incoming IP packet based on specifications configured under the ACL. An ACL is made up of one or more ACL specifications.

Each packet that arrives at the device is compared to each specification in each ACL in the order that they are defined. The device continues to look until it has a match. If no match is found and the device reaches the end of the list, the packet is denied by default. For this reason, place the most frequently occurring specifications at the top of the list.

The device stops checking the specifications after a match occurs.

There is an implied deny specification for traffic that is not permitted. Implied specification can be updated to permit if the use-case is to deny a certain set of traffic.

Use the `no` form of this command to remove an ACL.

### Command Syntax

```
ip access-list NAME
no ip access-list NAME
```

### Parameters

NAME	Access-list name.
------	-------------------

### Default

No default value is specified

### Command Mode

Configure mode

### Applicability

This command was introduced before OcnOS version 1.3.

### Examples

```
#configure terminal
(config)#ip access-list ip-acl-01
```

---

## ip access-list default

Use this command to modify the default rule action of access-list. Default rule is applicable only when access-list is attached to interface. Default rule will have the lowest priority and only the IP packets not matching any of the user defined rules match default rule.

### Command Syntax

```
default (deny-all|permit-all)
```

### Parameters

deny-all	Drop all packets.
permit-all	Accept all packets.

### Default

No default value is specified

### Command Mode

IP access-list mode

### Applicability

This command was introduced before OcnOS version 1.3.

### Examples

```
#configure terminal
(config)#ip access-list ip-acl-01
(config-ip-acl)#default permit-all
```

## ip access-list filter

Use this command to configure access control entry in an access control list (ACL).

This determines whether to accept or drop an IP packet based on the configured match criteria.

Use the `no` form of this command to remove an ACL specification. ACL specification can be removed using the sequence number as well.

**Note:** Configuring the same filter again with change of sequence number or change of action results in update of sequence number or filter action.

### Command Syntax

```
(<1-268435453>|) (deny|permit) (<0-255>|ahp|any|eigrp|esp|gre|ipip|ipcomp|ipv6ip
|ospf|pim|rsvp|vrrp) (A.B.C.D/ M|A.B.C.D A.B.C.D|host A.B.C.D|any) (A.B.C.D/
M|A.B.C.D A.B.C.D|host A.B.C.D|any) (dscp (<0-63>|af11| af12| af13| af21| af22|
af23| af31|af32| af33| af41| af42| af43| cs1| cs2| cs3| cs4| cs5|cs6| cs7|
default| ef )) (precedence (<0-7>| critical| flash | flashoverride| immediate|
internet| network| priority| routine))|) (vlan <1-4094>|) (inner-vlan <1-4094>|)
no (<1-268435453>|) (deny|permit) (<0-255> |ahp | any | eigrp | esp | gre | ipip |
ipcomp | ipv6ip | ospf | pim | rsvp| vrrp) (A.B.C.D/ M|A.B.C.D A.B.C.D | host
A.B.C.D|any) (A.B.C.D/M|A.B.C.D A.B.C.D|host A.B.C.D|any) (dscp (<0-63> |af11|
af12| af13| af21| af22| af23| af31|af32| af33| af41| af42| af43| cs1| cs2| cs3|
cs4| cs5|cs6| cs7| default| ef )) (precedence (<0-7>| critical| flash |
flashoverride| immediate| internet| network| priority| routine))|) (vlan <1-
4094>|) (inner-vlan <1-4094>|)
no (<1-268435453>)
```

### Parameters

<1-268435453>	IPv4 ACL sequence number.
deny	Drop the packet.
permit	Accept the packet.
<0-255>	IANA assigned protocol number.
any	Any protocol packet.
ahp	Authentication Header packet.
eigrp	Enhanced Interior Gateway Routing Protocol packet.
esp	Encapsulating Security Payload packet.
gre	Generic Routing Encapsulation packet.
ipip	IPv4 over IPv4 encapsulation packet.
ipcomp	IP Payload Compression Protocol packet.
ipv6ip	IPv6 over IPv4 encapsulation packet.
ospf	Open Shortest Path First packet.
pim	Protocol Independent Multicast packet
rsvp	Resource Reservation Protocol packet.
vrrp	Virtual Router Redundancy Protocol packet.
A.B.C.D/M	Source IP prefix and length.

A.B.C.D A.B.C.D	Source IP address and mask.
host A.B.C.D	A single source host IP address.
any	Match any source IP address.
A.B.C.D/M	Destination IP prefix and length.
A.B.C.D A.B.C.D	Destination IP address and mask.
host A.B.C.D	A single destination host IP address.
any	Match any destination IP address.
dscp	Match packets with given DSCP value.
<0-63>	Enter DSCP value between 0-63.
af11	AF11 DSCP (001010) decimal value 10.
af12	AF12 DSCP (001100) decimal value 12.
af13	AF13 DSCP (001110) decimal value 14.
af21	AF21 DSCP (010010) decimal value 18.
af22	AF22 DSCP (010100) decimal value 20.
af23	AF23 DSCP (010110) decimal value 22.
af31	AF31 DSCP (011010) decimal value 26.
af32	AF32 DSCP (011100) decimal value 28.
af33	AF33 DSCP (011110) decimal value 30.
af41	AF41 DSCP (100010) decimal value 34.
af42	AF42 DSCP (100100) decimal value 36.
af43	AF43 DSCP (100110) decimal value 38.
cs1	CS1 (precedence 1) DSCP (001000) decimal value 8.
cs2	CS2 (precedence 2) DSCP (010000) decimal value 16.
cs3	CS3 (precedence 3) DSCP (011000) decimal value 24.
cs4	CS4 (precedence 4) DSCP (100000) decimal value 32.
cs5	CS5 (precedence 5) DSCP (101000) decimal value 40.
cs6	CS6 (precedence 6) DSCP (110000) decimal value 48.
cs7	CS7 (precedence 7) DSCP (111000) decimal value 56.
default	Default DSCP (000000) decimal value 0.
ef	EF DSCP (101110) decimal value 46.
precedence	Match packets with given precedence value.
<0-7>	Enter precedence value 0-7.
critical	Match packets with critical precedence (5).
flash	Match packets with flash precedence (3).
flashoverride	Match packets with flash override precedence (4).
immediate	Match packets with immediate precedence (2).
internet	Match packets with internetwork control precedence (6).



network	Match packets with network control precedence (7).
priority	Match packets with priority precedence (1).
routine	Match packets with routine precedence (0).
vlan	Match packets with given vlan value.
<1 - 4094>	VLAN identifier.
inner-vlan	Match packets with given inner vlan value.
<1 - 4094>	VLAN identifier.

**Default**

No default value is specified

**Command Mode**

IP access-list mode

**Applicability**

This command was introduced before OcNOS version 1.3.

**Examples**

```
#configure terminal
(config)#ip access-list ip-acl-01
(config-ip-acl)#11 permit any 30.0.0.1 0.0.0.255 172.124.0.2 0.0.0.255
(config-ip-acl)#no 11
```

---

## ip access-list icmp

Use this command to permit or deny ICMP packets based on the given source and destination IP address. Even DSCP, precedence, vlan ID and inner vlan ID can be configured to permit or deny with the given values.

Use the `no` form of this command to remove an ACL specification.

Note: Configuring same filter again with change of sequence number or change of action will result in update of sequence number or filter action.

### Command Syntax

```
(<1-268435453>|) (deny|permit) (icmp) (A.B.C.D/M|A.B.C.D A.B.C.D|host A.B.C.D|any)
(A.B.C.D/M|A.B.C.D A.B.C.D|host A.B.C.D|any) ((dscp (<0-63>|af11| af12| af13|
af21| af22| af23| af31|af32| af33| af41| af42| af43| cs1| cs2| cs3| cs4| cs5|cs6|
cs7| default| ef ))| (precedence (<0-7>| critical| flash |
flashoverride|immediate| internet| network| priority| routine))) (vlan <1-
4094>|) (inner-vlan <1-4094>|)

no (<1-268435453>|) (deny|permit) (icmp) (A.B.C.D/M|A.B.C.D A.B.C.D|host
A.B.C.D|any) (A.B.C.D/M|A.B.C.D A.B.C.D|host A.B.C.D|any) (dscp (<0-63>|af11|
af12| af13| af21| af22| af23| af31|af32| af33| af41| af42| af43| cs1| cs2| cs3|
cs4| cs5|cs6| cs7| default| ef ))| (precedence (<0-7>| critical| flash |
flashoverride|immediate| internet| network| priority| routine))) (vlan <1-
4094>|) (inner-vlan <1-4094>|)
```

### Parameters

<1-268435453>	IPv4 ACL sequence number.
deny	Drop the packet.
permit	Accept the packet.
icmp	Internet Control Message Protocol packet.
A.B.C.D/M	Source IP prefix and length.
A.B.C.D A.B.C.D	Source IP address and mask.
host A.B.C.D	A single source host IP address.
any	Match any source IP address.
A.B.C.D/M	Destination IP prefix and length.
A.B.C.D A.B.C.D	Destination IP address and mask.
host A.B.C.D	A single destination host IP address.
any	Match any destination IP address.
dscp	Match packets with given DSCP value.
<0-63>	Enter DSCP value between 0-63.
af11	AF11 DSCP (001010) decimal value 10.
af12	AF12 DSCP (001100) decimal value 12.
af13	AF13 DSCP (001110) decimal value 14.
af21	AF21 DSCP (010010) decimal value 18.

---

af22	AF22 DSCP (010100) decimal value 20.
af23	AF23 DSCP (010110) decimal value 22.
af31	AF31 DSCP (011010) decimal value 26.
af32	AF32 DSCP (011100) decimal value 28.
af33	AF33 DSCP (011110) decimal value 30.
af41	AF41 DSCP (100010) decimal value 34.
af42	AF42 DSCP (100100) decimal value 36.
af43	AF43 DSCP (100110) decimal value 38.
cs1	CS1 (precedence 1) DSCP (001000) decimal value 8.
cs2	CS2 (precedence 2) DSCP (010000) decimal value 16.
cs3	CS3 (precedence 3) DSCP (011000) decimal value 24.
cs4	CS4 (precedence 4) DSCP (100000) decimal value 32.
cs5	CS5 (precedence 5) DSCP (101000) decimal value 40.
cs6	CS6 (precedence 6) DSCP (110000) decimal value 48.
cs7	CS7 (precedence 7) DSCP (111000) decimal value 56.
default	Default DSCP (000000) decimal value 0.
ef	EF DSCP (101110) decimal value 46.
precedence	Match packets with given precedence value.
<0-7>	Enter precedence value 0-7.
critical	Match packets with critical precedence (5).
flash	Match packets with flash precedence (3).
flashoverride	Match packets with flash override precedence (4).
immediate	Match packets with immediate precedence (2).
internet	Match packets with internetwork control precedence (6).
network	Match packets with network control precedence (7).
priority	Match packets with priority precedence (1).
routine	Match packets with routine precedence (0).
vlan	Match packets with given vlan value.
<1-4094>	VLAN identifier.
inner-vlan	Match packets with given inner-vlan value.
<1-4094>	VLAN identifier.

**Default**

No default value is specified

**Command Mode**

IP access-list mode

**Applicability**

This command was introduced before OcNOS version 1.3.

### Examples

```
#configure terminal
(config)#ip access-list ip-icmp
(config-ip-acl)#200 permit icmp any any
```

---

## ip access-list remark

Use this command to add a description to a named IPv4 access control list (ACL).

Use the `no` form of this command to remove an ACL description.

### Command Syntax

```
remark LINE
no remark
```

### Parameters

LINE                   ACL description up to 100 characters.

### Default

No default value is specified

### Command Mode

IP access-list mode

### Applicability

This command was introduced before OcnOS version 1.3.

### Examples

```
#configure terminal
(config)#ip access-list mylist
(config-ip-acl)#remark permit the inside admin address
(config-ip-acl)#exit
```

```
(config)#ip access-list mylist
(config-ip-acl)#no remark
(config-ip-acl)#exit
```

---

## ip access-list resequence

Use this command to modify sequence numbers of the IP access list specifications.

Note: Use a non-overlapping sequence space for new sequence number sets to avoid possible unexpected rule matches during transition.

Note: Re-sequencing an ACL attached to a management interface clears the ACL counters associated to it.

### Command Syntax

```
resequence <1-268435453> INCREMENT
```

### Parameters

<1-268435453>	Starting sequence number.
INCREMENT	Sequence number increment steps.

### Default

None

### Command Mode

IP access-list mode

### Applicability

This command was introduced before OcnOS version 1.3.

### Examples

```
#configure terminal
(config)#ip access-list mylist
(config-ip-acl)#resequence 5 5
(config-ip-acl)#end
```

## ip access-list tcp|udp

Use this command to define a named access control list (ACL) that determines whether to accept or drop an incoming TCP or UDP IP packet based on the specified match criteria. This form of command filters packets based on source and destination IP address along with protocol (TCP or UDP) and port.

Use the `no` form of this command to remove an ACL specification.

**Note:** Configuring same filter again with change of sequence number or change of action will result in update of sequence number or filter action.

**Note:** TCP flags options and range options like `neq`, `gt`, `lt` and `range` are not supported by hardware in egress direction.

**Note:** Both `Ack` and `established` flag in `tcp` have same functionality in hardware.

### Command Syntax

```
(<1-268435453>|) (deny|permit) tcp (A.B.C.D/M|A.B.C.D A.B.C.D|host A.B.C.D|any)
((eq|gt|lt|neq) (<0-65535>|bgp|chargen|cmd|daytime|discard|domain|drip|echo
|exec|finger|ftp |ftp-data|gopher|hostname|ident|irc|klogin|kshell|login
|lpd|nntp|pim-auto- rp|pop2|pop3|smtp|ssh|sunrpc|tacacs|talk|telnet|time|
uucp|whois|www) | range <0-65535> <0-65535>|) (A.B.C.D/M|A.B.C.D A.B.C.D|host
A.B.C.D|any) ((eq|gt|lt|neq) (<0-65535>|bgp|chargen|cmd|daytime|discard|domain|
drip|echo|exec|finger|ftp|ftp-data|gopher|hostname|ident|irc|klogin|kshell|login
|lpd|nntp|pim-auto- rp|pop2|pop3|smtp|ssh|sunrpc|tacacs|talk|telnet
|time|uucp|whois|www) | range <0-65535> <0-65535>|) ((dscp (<0-63>| af11| af12|
af13| af21| af22| af23| af31| af32| af33| af41| af42| af43| cs1| cs2| cs3| cs4|
cs5| cs6| cs7| default| ef)) |(precedence (<0-7>| critical| flash |
flashoverride| immediate| internet| network| priority| routine)) |)
({ack|established|fin|psh|rst|syn|urg}|) vlan <1-4094>|) (inner-vlan <1-4094>|)

(<1-268435453>|) (deny|permit) udp (A.B.C.D/M|A.B.C.D A.B.C.D|host A.B.C.D|any)
((eq|gt|lt|neq) (<0-65535>|biff|bootpc|bootps|discard|dnsix|domain|
echo|isakmp|mobile-ip |nameserver | netbios-dgm | netbios-ns| netbios-ss|non500-
isakmp|ntp|pim-auto-rp|rip|snmp|snmptrap|sunrpc|syslog|tacacs|talk|tftp
|time|who|xdmcp) | range <0-65535> <0-65535>|) (A.B.C.D/M|A.B.C.D A.B.C.D|host
A.B.C.D|any) ((eq|gt |lt|neq)(<0-65535> |biff |bootpc |bootps| discard| dnsix|
domain| echo| isakmp|mobile-ip|nameserver|netbios-dgm|netbios-ns|netbios-
ss|non500-isakmp |ntp|pim-auto- rp| rip| snmp| snmptrap| sunrpc| syslog| tacacs|
talk| tftp| time| who| xdmcp) | range <0-65535> <0-65535>|) ((dscp (<0-63>| af11|
af12| af13| af21| af22| af23| af31| af32| af33| af41| af42| af43| cs1| cs2| cs3|
cs4| cs5| cs6| cs7| default| ef)) |(precedence (<0-7>| critical| flash |
flashoverride| immediate| internet| network| priority| routine))|) (vlan <1-
4094>|) (inner-vlan <1-4094>|)

no (<1-268435453>|) (deny|permit) tcp (A.B.C.D/M|A.B.C.D A.B.C.D|host
A.B.C.D|any)((eq|gt|lt|neq) (<0-65535>| bgp| chargen| cmd| daytime| discard|
domain| drip| echo|exec|finger|ftp |ftp-data |gopher |hostname| ident| irc|
klogin| kshell|login|lpd|nntp|pim-auto-rp |pop2 |pop3 |smtp| ssh| sunrpc| tacacs
|talk|telnet|time|uucp|whois|www) | range <0-65535> <0-65535>|) (A.B.C.D/
M|A.B.C.D A.B.C.D|host A.B.C.D|any)((eq|gt|lt|neq) (<0-65535> |bgp |chargen |cmd
|daytime|discard|domain|drip|echo|exec|finger|ftp|ftp-data| gopher| hostname|
ident| irc| klogin| kshell| login| lpd| nntp| pim-auto-rp | pop2| pop3| smtp |ssh
|sunrpc|tacacs|talk|telnet|time|uucp|whois|www) | range <0-65535> <0-65535>|)
((dscp (<0-63>| af11| af12| af13| af21| af22| af23| af31| af32| af33| af41| af42|
af43| cs1| cs2| cs3| cs4| cs5| cs6| cs7| default| ef)) |(precedence (<0-7>|
```

```
critical| flash | flashoverride| immediate| internet| network| priority|
routine)) |) ((ack|established|fin|psh|rst|syn|urg}|) (vlan <1-4094>|) (inner-vlan
<1-4094>|)
no (<1-268435453>|) (deny|permit) udp (A.B.C.D/M|A.B.C.D A.B.C.D|host A.B.C.D|any)
((eq|gt|lt|neq) (<0-65535> |biff| bootpc| bootps| discard| dnsix|
domain|echo|isakmp|mobile-ip|nameserver|netbios-dgm|netbios-ns|netbios-
ss|non500-isakmp|ntp|pim-auto-rp|rip|snmp|snmptrap|sunrpc|syslog|tacacs|talk|
tftp|time|who|xmcp) | range <0-65535> <0-65535>|) (A.B.C.D/M|A.B.C.D A.B.C.D|host
A.B.C.D| any) ((eq|gt|lt|neq) (<0-65535> |biff| bootpc| bootps| discard| dnsix|
domain|echo| isakmp|mobile- ip|nameserver|netbios-dgm|netbios-ns|netbios-
ss|non500-isakmp| ntp|pim-auto-rp|rip|snmp|snmptrap|sunrpc|syslog|
tacacs|talk|tftp|time|who|xmcp) | range <0-65535> <0-65535>|) ((dscp (<0-63>|
af11| af12| af13| af21| af22| af23| af31| af32| af33| af41| af42| af43| cs1| cs2|
cs3| cs4| cs5| cs6| cs7| default| ef)) | (precedence (<0-7>| critical| flash |
flashoverride| immediate| internet| network| priority| routine)) |) (vlan <1-
4094>|) (inner-vlan <1-4094>|)
```

### Parameters

<1-268435453>	IPv4 ACL sequence number.
deny	Drop the packet.
permit	Accept the packet.
tcp	Transmission Control Protocol.
udp	User Datagram Protocol.
A.B.C.D/M	Source or destination IP prefix and length.
A.B.C.D A.B.C.D	Source or destination IP address and mask.
host A.B.C.D	Source or destination host IP address.
any	Any source or destination IP address.
eq	Source or destination port equal to.
gt	Source or destination port greater than.
lt	Source or destination port less than.
neq	Source or destination port not equal to.
<0-65535>	Source or destination port number.
range	Range of source or destination port numbers:
<0-65535>	Lowest value in the range.
<0-65535>	Highest value in the range.
bgp	Border Gateway Protocol.
chargen	Character generator.
cmd	Remote commands.
daytime	Daytime.
discard	Discard.
domain	Domain Name Service.
drip	Dynamic Routing Information Protocol.



---

echo	Echo.
exec	EXEC.
finger	Finger.
ftp	File Transfer Protocol.
ftp-data	FTP data connections.
gopher	Gopher.
hostname	NIC hostname server.
ident	Ident Protocol.
irc	Internet Relay Chat.
klogin	Kerberos login.
kshell	Kerberos shell.
login	Login.
lpd	Printer service.
nntp	Network News Transport Protocol.
pim-auto-rp	PIM Auto-RP.
pop2	Post Office Protocol v2.
pop3	Post Office Protocol v3.
smtp	Simple Mail Transport Protocol.
ssh	Secure Shell.
sunrpc	Sun Remote Procedure Call.
tacacs	TAC Access Control System.
talk	Talk.
telnet	Telnet.
time	Time.
uucp	UNIX-to-UNIX Copy Program.
whois	WHOIS/NICNAME
www	World Wide Web.
nntp	Range of source or destination port numbers:
dscp	Match packets with given DSCP value.
<0-63>	Enter DSCP value between 0-63.
af11	AF11 DSCP (001010) decimal value 10.
af12	AF12 DSCP (001100) decimal value 12.
af13	AF13 DSCP (001110) decimal value 14.
af21	AF21 DSCP (010010) decimal value 18.
af22	AF22 DSCP (010100) decimal value 20.
af23	AF23 DSCP (010110) decimal value 22.
af31	AF31 DSCP (011010) decimal value 26.
af32	AF32 DSCP (011100) decimal value 28.
af33	AF33 DSCP (011110) decimal value 30.

af41	AF41 DSCP (100010) decimal value 34.
af42	AF42 DSCP (100100) decimal value 36.
af43	AF43 DSCP (100110) decimal value 38.
cs1	CS1 (precedence 1) DSCP (001000) decimal value 8.
cs2	CS2 (precedence 2) DSCP (010000) decimal value 16.
cs3	CS3 (precedence 3) DSCP (011000) decimal value 24.
cs4	CS4 (precedence 4) DSCP (100000) decimal value 32.
cs5	CS5 (precedence 5) DSCP (101000) decimal value 40.
cs6	CS6 (precedence 6) DSCP (110000) decimal value 48.
cs7	CS7 (precedence 7) DSCP (111000) decimal value 56.
default	Default DSCP (000000) decimal value 0.
ef	EF DSCP (101110) decimal value 46.
precedence	Match packets with given precedence value.
<0-7>	Precedence.
critical	Match packets with critical precedence (5).
flash	Match packets with flash precedence (3).
flashoverride	Match packets with flash override precedence (4).
immediate	Match packets with immediate precedence (2).
internet	Match packets with internetwork control precedence (6).
network	Match packets with network control precedence (7).
priority	Match packets with priority precedence (1).
routine	Match packets with routine precedence (0).
ack	Match on the Acknowledgment (ack) bit.
established	Matches only packets that belong to an established TCP connection.
fin	Match on the Finish (fin) bit.
psh	Match on the Push (psh) bit.
rst	Match on the Reset (rst) bit.
syn	Match on the Synchronize (syn) bit.
urg	Match on the Urgent (urg) bit.
biff	Biff.
bootpc	Bootstrap Protocol (BOOTP) client.
bootps	Bootstrap Protocol (BOOTP) server.
discard	Discard.
dnsix	DNSIX security protocol auditing.
domain	Domain Name Service.
echo	Echo.
isakmp	Internet Security Association and Key Management Protocol.
mobile-ip	Mobile IP registration.
nameserver	IEN116 name service.

---

netbios-dgm	Net BIOS datagram service.
netbios-ns	Net BIOS name service.
netbios-ss	Net BIOS session service.
non500-isakmp	Non500-Internet Security Association and Key Management Protocol.
ntp	Network Time Protocol.
pim-auto-rp	PIM Auto-RP.
rip	Routing Information Protocol.
snmp	Simple Network Management Protocol.
snmptrap	SNMP Traps.
sunrpc	Sun Remote Procedure Call.
syslogS	ystem Logger.
tacacs	TAC Access Control System.
talk	Talk.
tftp	Trivial File Transfer Protocol.
time	Time.
who	Who service.
xdmcp	X Display Manager Control Protocol.
vlan	Match packets with given vlan value.
<1-4094>	VLAN identifier.
inner-vlan	Match packets with given inner vlan value.
<1-4094>	VLAN identifier.

**Default**

No default value is specified

**Command Mode**

IP access-list mode

**Applicability**

This command was introduced before OcNOS version 1.3.

**Examples**

```
#configure terminal
(config)#ip access-list ip-acl-02
(config-ip-acl)#deny udp any any eq tftp
(config-ip-acl)#deny tcp any any eq ssh
(config-ip-acl)#end
```

## ipv6 access-group in

Use this command to attach an IPv6 access list to an interface to filter incoming IPv6 packets.

When you attach an access list to a VLAN interface or LAG interface as well as to a physical interface that is a member of that LAG and/or VLAN interface, the priority order is:

1. VLAN interface
2. LAG interface
3. Physical interface

For example, if you attach access lists to both a LAG interface and a physical interface that is a member of that LAG, matching traffic rules are applied to the LAG interface, but not to the physical interface.

The `time-range` parameter is optional. If used, the access-group is tied to the timer specified.

After the access-group has been configured with the time-range, to detach the access-group from the time-range, use the `no` form of this command with a time-range parameter as shown in the syntax and examples below.

To delete the access-group, use the `no` form of this command without a time-range.

Note: To attach IPv6 ACL in the ingress direction ingress-ipv6 TCAM group needs to be enabled. See the [hardware-profile filter](#) command for details.

### Command Syntax

```
ipv6 access-group NAME in (time-range TR_NAME|)
no ipv6 access-group NAME in (time-range TR_NAME|)
```

### Parameters

NAME	Access list name.
TR_NAME	Time range name set with the <a href="#">time-range</a> command.

### Default

No default value is specified

### Command Mode

Interface mode

### Applicability

This command was introduced before OcNOS version 1.3. The `time-range` parameter was added in OcNOS version 5.0.

### Examples

```
#configure terminal
(config)#ipv6 access-list mylist
(config-ipv6-acl)#permit ipv6 any any
(config-ipv6-acl)#exit
(config)#hardware-profile filter ingress-ipv6 enable

(config)#interface xe3
```

```
(config-if)#ipv6 access-group mylist in
```

```
(config)#interface xe3
```

```
(config-if)#no ipv6 access-group mylist in
```

```
(config)#interface xe3
```

```
(config-if)#ipv6 access-group mylist in time-range TIMER1
```

```
(config)#interface xe3
```

```
(config-if)#no ipv6 access-group mylist in time-range TIMER1
```

---

## ipv6 access-list

Use this command to define a IPv6 access control list (ACL) that determines whether to accept or drop an incoming IPv6 packet based on specifications configured under the ACL. An ACL is made up of one or more ACL specifications.

Each packet that arrives at the device is compared to each specification in each ACL in the order that they are defined. The device continues to look until it has a match. If no match is found and the device reaches the end of the list, the packet is denied by default. For this reason, place the most frequently occurring specifications at the top of the list.

The device stops checking the specifications after a match occurs.

There is an implied deny specification for traffic that is not permitted. Implied specification can be updated to permit if the use-case is to deny a certain set of traffic.

**Note:** IPv6 routing protocols need neighbor discovery to establish sessions. Applying IPv6 ACLs implicitly drops all the ICMPv6 packets, thereby affecting the protocol sessions. To overcome this problem, an implicit ICMPv6 permit rule is added to the IPv6 ACLs.

If required behavior is to deny the icmpv6, the implicit rule can be deleted. For example, create an IPv6 ACL:

```
(config)#ipv6 access-list ipv6-acl
```

```
#show ipv6 access-lists
IPv6 access list ip1
268435453 permit icmpv6 any any
```

To delete this rule:

```
(config)#ipv6 access-list ipv6-acl

(config-ipv6-acl)#no 268435453 permit icmpv6 any any
```

```
#show ipv6 access-lists
IPv6 access list ip1
```

Use the `no` form of this command to remove the ACL.

### Command Syntax

```
ipv6 access-list NAME
no ipv6 access-list NAME
```

### Parameters

NAME                      Access-list name.

### Default

No default value is specified

### Command Mode

Configure mode

### Applicability

This command was introduced before OcNOS version 1.3.

**Examples**

```
#configure terminal  
(config)#ipv6 access-list ipv6-acl-01  
(config-ipv6-acl)#exit
```

---

## ipv6 access-list default

Use this command to modify the default rule action of IPv6 access-list. Default rule is applicable only when IPv6 access-list is attached to interface. Default rule will have the lowest priority and only the IPv6 packets not matching any of the user defined rules match default rule.

### Command Syntax

```
default (deny-all|permit-all)
```

### Parameters

deny-all	Drop all packets.
permit-all	Accept all packets.

### Default

No default value is specified

### Command Mode

IPv6 access-list mode

### Applicability

This command was introduced before OcnOS version 1.3.

### Examples

```
#configure terminal
(config)#ip access-list ipv6-acl-01
(config-ipv6-acl)#default permit-all
```



## ipv6 access-list filter

Use this command to define an access-control entry in an access control list (ACL) that determines whether to accept or drop an IPv6 packet based on the criteria specified. This form of this command filters packets based on:

- Protocol
- Source IP address
- Destination IP address
- DSCP value
- VLAN identifier

Use the `no` form of this command to remove an ACL specification. ACL specification can be removed using the sequence number as well.

**Note:** Configuring same filter again with change of sequence number or change of action will result in update of sequence number or filter action.

**Note:** For IPv6 source and destination address filters, only the network part from the address (upper 64 bits) is supported due to hardware restriction. If the address length is more than 64 bits, it cannot be applied on the interfaces but it can be used with distributed lists in control plane protocols.

### Command Syntax

```
(<1-268435453>|) (deny|permit) (<0-255>|ahp|any|eigrp|esp|gre|ipip6|ipcomp
|ipv6ipv6|ospf|pim|rsvp|vrrp) (X:X::X:X/ M|X:X::X:X X:X::X:X|any) (X:X::X:X/
M|X:X::X:X X:X::X:X|any) (dscp (<0-63>|af11| af12| af13| af21| af22| af23|
af31|af32| af33| af41| af42| af43| cs1| cs2| cs3| cs4| cs5|cs6| cs7| default| ef
)|) (vlan <1-4094>|)
```

```
no (<1-268435453>|) (deny|permit) (<0-255>|ahp|any|eigrp|esp|gre|ipip6|ipcomp
|ipv6ipv6|ospf|pim|rsvp|vrrp) (X:X::X:X/ M|X:X::X:X X:X::X:X|any) (X:X::X:X/
M|X:X::X:X X:X::X:X|any) (dscp (<0-63>|af11| af12| af13| af21| af22| af23|
af31|af32| af33| af41| af42| af43| cs1| cs2| cs3| cs4| cs5|cs6| cs7| default| ef
)|) (vlan <1-4094>|)
```

```
no (<1-268435453>)
```

### Parameters

<code>&lt;1-268435453&gt;</code>	IPv6 ACL sequence number.
<code>deny</code>	Drop the packet.
<code>permit</code>	Accept the packet.
<code>&lt;0-255&gt;</code>	IANA assigned protocol number.
<code>any</code>	Any protocol packet.
<code>ahp</code>	Authentication Header packet.
<code>eigrp</code>	Enhanced Interior Gateway Routing Protocol packet.
<code>esp</code>	Encapsulating Security Payload packet.
<code>gre</code>	Generic Routing Encapsulation packet.
<code>ipip6</code>	IPv4 over IPv6 Encapsulation packet.
<code>ipcomp</code>	IP Payload Compression Protocol packet.
<code>ipv6ipv6</code>	IPv6 over IPv6 Encapsulation packet.

ospf	Open Shortest Path First packet.
pim	Protocol Independent Multicast packet
rsvp	Resource Reservation Protocol packet.
vrrp	Virtual Router Redundancy Protocol packet.
X:X::X:X/M	Source Address with network mask length.
X:X::X:X X:X::X:X	Source Address with wild card mask.
any	Any source address.
X:X::X:X/M	Destination address with network mask length.
X:X::X:X X:X::X:X	Destination address with wild card mask.
any	Any destination address
any	Match any destination IP address.
dscp	Match packets with given DSCP value.
<0-63>	Enter DSCP value between 0-63.
af11	AF11 DSCP (001010) decimal value 10.
af12	AF12 DSCP (001100) decimal value 12.
af13	AF13 DSCP (001110) decimal value 14.
af21	AF21 DSCP (010010) decimal value 18.
af22	AF22 DSCP (010100) decimal value 20.
af23	AF23 DSCP (010110) decimal value 22.
af31	AF31 DSCP (011010) decimal value 26.
af32	AF32 DSCP (011100) decimal value 28.
af33	AF33 DSCP (011110) decimal value 30.
af41	AF41 DSCP (100010) decimal value 34
af42	AF42 DSCP (100100) decimal value 36.
af43	AF43 DSCP (100110) decimal value 38.
cs1	CS1 (precedence 1) DSCP (001000) decimal value 8.
cs2	CS2 (precedence 2) DSCP (010000) decimal value 16.
cs3	CS3 (precedence 3) DSCP (011000) decimal value 24.
cs4	CS4 (precedence 4) DSCP (100000) decimal value 32.
cs5	CS5 (precedence 5) DSCP (101000) decimal value 40.
cs6	CS6 (precedence 6) DSCP (110000) decimal value 48.
cs7	CS7 (precedence 7) DSCP (111000) decimal value 56.
default	Default DSCP (000000) decimal value 0.
ef	EF DSCP (101110) decimal value 46.
vlan	Match packets with given vlan value.
<1-4094>	VLAN identifier.

**Default**

No default value is specified

**Command Mode**

IPv6 access-list mode

**Applicability**

This command was introduced before OcnOS version 1.3.

**Examples**

```
#configure terminal
(config)#ipv6 access-list ipv6-acl-01
(config-ipv6-acl)#permit ipipv6 any any
(config-ipv6-acl)#end
```

---

## ipv6 access-list icmpv6

Use this command to permit or deny IPv6 ICMP packets with the given source and destination IPv6 address, DSCP value and VLAN ID.

Use the `no` form of this command to remove an ACL specification.

Note: Configuring same filter again with change of sequence number or change of action will result in update of sequence number or filter action.

### Command Syntax

```
(<1-268435453>|) (deny|permit) (icmpv6) (X:X::X:X/M|X:X::X:X X:X::X:X|any)
(X:X::X:X/ M|X:X::X:X X:X::X:X|any) ((dscp (<0-63>|af11| af12| af13| af21| af22|
af23| af31|af32| af33| af41| af42| af43| cs1| cs2| cs3| cs4| cs5|cs6| cs7|
default| ef)|) (vlan <1-4094>|)

no (<1-268435453>|) (deny|permit) (icmpv6) (X:X::X:X/M|X:X::X:X X:X::X:X|any)
(X:X::X:X/M|X:X::X:X X:X::X:X|any) ((dscp (<0-63>|af11| af12| af13| af21| af22|
af23| af31|af32| af33| af41| af42| af43| cs1| cs2| cs3| cs4| cs5|cs6| cs7|
default| ef )|) (vlan <1-4094>|)
```

### Parameters

<1-268435453>	IPv6 ACL sequence number.
deny	Drop the packet.
permit	Accept the packet.
icmpv6	Internet Control Message Protocol packet.
X:X::X:X/M	Source Address with network mask length.
X:X::X:X X:X::X:X	Source Address with wild card mask.
any	Any source address.
X:X::X:X/M	Destination address with network mask length.
X:X::X:X X:X::X:X	Destination address with wild card mask.
any	Any destination address
dscp	Match packets with given DSCP value.
<0-63>	Enter DSCP value between 0-63.
af11	AF11 DSCP (001010) decimal value 10.
af12	AF12 DSCP (001100) decimal value 12.
af13	AF13 DSCP (001110) decimal value 14.
af21	AF21 DSCP (010010) decimal value 18.
af22	AF22 DSCP (010100) decimal value 20.
af23	AF23 DSCP (010110) decimal value 22.
af31	AF31 DSCP (011010) decimal value 26.
af32	AF32 DSCP (011100) decimal value 28.

---

af33	AF33 DSCP (011110) decimal value 30.
af41	AF41 DSCP (100010) decimal value 34
af42	AF42 DSCP (100100) decimal value 36.
af43	AF43 DSCP (100110) decimal value 38.
cs1	CS1 (precedence 1) DSCP (001000) decimal value 8.
cs2	CS2 (precedence 2) DSCP (010000) decimal value 16.
cs3	CS3 (precedence 3) DSCP (011000) decimal value 24.
cs4	CS4 (precedence 4) DSCP (100000) decimal value 32.
cs5	CS5 (precedence 5) DSCP (101000) decimal value 40.
cs6	CS6 (precedence 6) DSCP (110000) decimal value 48.
cs7	CS7 (precedence 7) DSCP (111000) decimal value 56.
default	Default DSCP (000000) decimal value 0.
ef	EF DSCP (101110) decimal value 46.
vlan	Match packets with given vlan value.
<1-4094>	VLAN identifier.

**Default**

No default value is specified

**Command Mode**

IPv6 access-list mode

**Applicability**

This command was introduced before OcnOS version 1.3.

**Examples**

```
#configure terminal
(config)#ipv6 access-list mylist
(config-ipv6-acl)#200 permit icmpv6 any any
```

---

## ipv6 access-list remark

Use this command to add a description to an IPv6 access control list (ACL).

Use the `no` form of this command to remove an access control list description.

### Command Syntax

```
remark LINE
no remark
```

### Parameters

`LINE` ACL description up to 100 characters.

### Default

No default value is specified

### Command Mode

IPv6 access-list mode

### Applicability

This command was introduced before OcNOS version 1.3.

### Examples

```
#configure terminal
(config)#ipv6 access-list mylist
(config-ipv6-acl)# remark Permit the inside admin address
```

---

## ipv6 access-list resequence

Use this command to modify sequence numbers of the IPv6 access list specifications.

Note: Use a non-overlapping sequence space for new sequence number sets to avoid possible unexpected rule matches during transition.

Note: Re-sequencing an ACL attached to a management interface clears the ACL counters associated to it.

### Command Syntax

```
resequence <1-268435453> INCREMENT
```

### Parameters

<1-268435453> Starting Sequence number.  
INCREMENT Sequence number increment steps.

### Default

No default value is specified

### Command Mode

IPv6 access-list mode

### Applicability

This command was introduced before OcnOS version 1.3.

### Examples

```
#configure terminal  
(config)#ipv6 access-list mylist  
(config-ipv6-acl)#resequence 15 15
```

## ipv6 access-list sctp

Use this command to allow ACL to permit or deny SCTP packets based on the given source and destination IPV6 address. Even DSCP and vlan ID can be configured to permit or deny with the given values.

Use the `no` form of this command to remove an ACL specification.

Note: Configuring same filter again with change of sequence number or change of action will result in update of sequence number or filter action.

Note: Range options like `neq`, `gt`, `lt` and `range` are not supported by hardware in egress direction.

### Command Syntax

```
(<1-268435453>|) (deny|permit) (sctp) (X:X::X:X/M|X:X::X:X X:X::X:X|any) (X:X::X:X/M|X:X::X:X X:X::X:X|any) {(eq|gt|lt|neq) (<0-65535>) | (range <0-65535> <0-65535>)| } (dscp (<0-63>| af11| af12| af13| af21| af22| af23| af31| af32| af33| af41| af42| af43| cs1| cs2| cs3| cs4| cs5| cs6| cs7| default| ef)|) (vlan <1-4094>|)
```

```
no (<1-268435453>|) (deny|permit) (sctp) (X:X::X:X/M|X:X::X:X X:X::X:X|any) (X:X::X:X/M|X:X::X:X X:X::X:X|any) {(eq|gt|lt|neq) (<0-65535>) | (range <0-65535> <0-65535>)| } (dscp (<0-63>| af11| af12| af13| af21| af22| af23| af31| af32| af33| af41| af42| af43| cs1| cs2| cs3| cs4| cs5| cs6| cs7| default| ef)|) (vlan <1-4094>|)
```

### Parameters

<1-268435453>	IPv6 ACL sequence number.
deny	Drop the packet.
permit	Accept the packet.
sctp	Stream Control Transmission Protocol packet.
X:X::X:X/M	Source address with network mask length.
X:X::X:X	Source address with wild card mask.
X:X::X:X	Source address's wild card mask (ignored bits).
any	Any source address.
X:X::X:X/M	Destination address with network mask length.
X:X::X:X	Destination address with wild card mask.
X:X::X:X	Destination address's wild card mask (ignored bits).
any	Any destination address.
eq	Source or destination port equal to.
gt	Source or destination port greater than.
lt	Source or destination port less than.
neq	Source or destination port not equal to.
<0-65535>	Source or destination port number.
range	Range of source or destination port numbers:
<0-65535>	Lowest value in the range.
<0-65535>	Highest value in the range.



---

dscp	Match packets with given DSCP value.
<0-63>	DSCP value.
af11	AF11 DSCP (001010) decimal value 10.
af12	AF12 DSCP (001100) decimal value 12.
af13	AF13 DSCP (001110) decimal value 14.
af21	AF21 DSCP (010010) decimal value 18.
af22	AF22 DSCP (010100) decimal value 20.
af23	AF23 DSCP (010110) decimal value 22.
af31	AF31 DSCP (011010) decimal value 26.
af32	AF32 DSCP (011100) decimal value 28.
af33	AF33 DSCP (011110) decimal value 30.
af41	AF41 DSCP (100010) decimal value 34.
af42	AF42 DSCP (100100) decimal value 36.
af43	AF43 DSCP (100110) decimal value 38.
cs1	CS1 (precedence 1) DSCP (001000) decimal value 8.
cs2	CS2 (precedence 2) DSCP (010000) decimal value 16.
cs3	CS3 (precedence 3) DSCP (011000) decimal value 24.
cs4	CS4 (precedence 4) DSCP (100000) decimal value 32.
cs5	CS5 (precedence 5) DSCP (101000) decimal value 40.
cs6	CS6 (precedence 6) DSCP (110000) decimal value 48.
cs7	CS7 (precedence 7) DSCP (111000) decimal value 56.
default	Default DSCP (000000) decimal value 0.
ef	EF DSCP (101110) decimal value 46.
vlan	Match packets with given vlan value.
<1-4094>	VLAN identifier.

**Default**

No default value is specified

**Command Mode**

IPv6 access-list mode

**Applicability**

This command was introduced before OcNOS version 1.3.

**Examples**

```
#configure terminal
(config)#ipv6 access-list mylist
(config-ipv6-acl)#200 permit sctp any any
```

## ipv6 access-list tcp|udp

Use this command to define a IPv6 access control list (ACL) specification that determines whether to accept or drop an incoming IPv6 packet based on the criteria that you specify. This form of this command filters packets based on source and destination IPv6 address along with protocol (TCP or UDP) and port.

Use the `no` form of this command to remove an ACL specification.

Note: Configuring same filter again with change of sequence number or change of action will result in update of sequence number or filter action.

Note: Range options such as `neq`, `gt`, `lt` and `range` are not supported by the hardware in the egress direction.

### Command Syntax

```
(<1-268435453>|) (deny|permit) tcp (X:X::X:X/M|X:X::X:X X:X::X:X|any)
((eq|gt|lt|neq) <0-65535> |bgp|chargin|cmd|daytime|discard|domain|drip
|echo|exec|finger|ftp |ftp- data|gopher|hostname|ident|irc|klogin|kshell
|login|lpd|nntp|pim-auto- rp|pop2|pop3|smtp|ssh|sunrpc|tacacs|talk|telnet
|time|uucp|whois|www) | (range <0-65535> <0-65535>|) |) (X:X::X:X/M|X:X::X:X
X:X::X:X|any) ((eq|gt|lt|neq) <0-65535>|bgp|chargin|cmd|daytime|discard|domain
|drip|echo|exec|finger|ftp|ftp-data|gopher|hostname|ident|irc|klogin|kshell
|login|lpd|nntp|pim-auto-rp|pop2|pop3|smtp|ssh|sunrpc|tacacs|talk| telnet|time
|uucp|whois|www) | (range <0-65535> <0-65535>|) (dscp (<0-63>| af11| af12| af13|
af21| af22| af23| af31| af32| af33| af41| af42| af43| cs1| cs2| cs3| cs4| cs5|
cs6| cs7| default| ef)) (vlan <1-4094>|)

(<1-268435453>|) (deny|permit) udp (X:X::X:X/M|X:X::X:X X:X::X:X|any)
((eq|gt|lt|neq) <0-65535>|biff|bootpc|bootps|discard|dnsix|domain
|echo|isakmp|mobile-ip|nameserver|netbios-dgm|netbios-ns|netbios-ss|non500-
isakmp|ntp|pim-auto-rp|rip|snmp|snmptrap|sunrpc|syslog|tacacs|talk
|tftp|time|who|xdmcp) | (range <0-65535> <0-65535>|) (X:X::X:X/M|X:X::X:X
X:X::X:X|any) ((eq|gt|lt|neq) <0-65535>|biff|bootpc|bootps|discard|dnsix
|domain|echo|isakmp|mobile-ip|nameserver|netbios-dgm|netbios-ns|netbios-
ss|non500-isakmp|ntp|pim-auto-rp|rip|snmp|snmptrap|sunrpc|syslog|tacacs|talk
|tftp|time|who|xdmcp) | (range <0-65535> <0-65535>|) (dscp (<0-63>| af11| af12|
af13| af21| af22| af23| af31| af32| af33| af41| af42| af43| cs1| cs2| cs3| cs4|
cs5| cs6| cs7| default| ef) (vlan <1-4094>|)

no (<1-268435453>|) (deny|permit) tcp (X:X::X:X/M|X:X::X:X X:X::X:X|any)
((eq|gt|lt|neq) <0-65535> |bgp|chargin|cmd|daytime|discard|domain|drip
|echo|exec|finger|ftp |ftp- data|gopher|hostname|ident|irc|klogin|kshell
|login|lpd|nntp|pim-auto- rp|pop2|pop3|smtp|ssh|sunrpc|tacacs|talk|telnet
|time|uucp|whois|www) | (range <0-65535> <0-65535>|) (X:X::X:X/M|X:X::X:X
X:X::X:X|any) ((eq|gt|lt|neq) <0-65535>|bgp|chargin|cmd|daytime|discard|domain|
drip|echo|exec|finger|ftp |ftp- data|gopher|hostname|ident|irc|klogin
|kshell|login|lpd|nntp|pim-auto- rp|pop2|pop3|smtp|ssh|sunrpc|tacacs|talk|telnet
|time|uucp|whois|www) | (range <0- 65535> <0-65535>|) (dscp (<0-63>| af11| af12|
af13| af21| af22| af23| af31| af32| af33| af41| af42| af43| cs1| cs2| cs3| cs4|
cs5| cs6| cs7| default| ef) | (vlan <1-4094>|)

no (<1-268435453>|) (deny|permit) udp (X:X::X:X/M|X:X::X:X X:X::X:X|any)
((eq|gt|lt|neq) <0-65535>|biff|bootpc|bootps|discard|dnsix|domain|echo
|isakmp|mobile-ip|nameserver|netbios-dgm|netbios-ns|netbios-ss|non500-
isakmp|ntp|pim-auto-rp|rip|snmp|snmptrap|sunrpc|syslog|tacacs|talk|tftp|time
|who|xdmcp) | (range <0-65535> <0-65535>|) (X:X::X:X/M|X:X::X:X X:X::X:X|any)
((eq|gt|lt|neq) <0-65535>|biff|bootpc|bootps|discard|dnsix|domain|echo
```

```
|isakmp|mobile-ip|nameserver|netbios-dgm|netbios-ns|netbios-ss|non500-
isakmp|ntp|pim-auto-rp|rip|snmp|snmptrap|sunrpc|syslog|tacacs|talk|tftp|time
|who|xdmcp) | (range <0-65535> <0-65535>)|) (dscp (<0-63>| af11| af12| af13|
af21| af22| af23| af31| af32| af33| af41| af42| af43| cs1| cs2| cs3| cs4| cs5|
cs6| cs7| default| ef) | (vlan <1-4094>|)
```

## Parameters

<1-268435453>	IPv6 ACL sequence number.
deny	Drop the packet.
permit	Accept the packet.
tcp	Transmission Control Protocol.
udp	User Datagram Protocol.
X:X::X:X/M	Source or destination IPv6 prefix and length.
X:X::X:X X:X::X:X	Source or destination IPv6 address and mask.
any	Any source or destination IPv6 address.
eq	Source or destination port equal to.
gt	Source or destination port greater than.
lt	Source or destination port less than.
neq	Source or destination port not equal to.
<0-65535>	Source or destination port number.
range	Range of source or destination port numbers:
<0-65535>	Lowest value in the range.
<0-65535>	Highest value in the range.
ftp	File Transfer Protocol (21).
ssh	Secure Shell (22).
telnet	Telnet (23).
www	World Wide Web (HTTP 80).
tftp	Trivial File Transfer Protocol (69).
bootp	Bootstrap Protocol (BOOTP) client (67).
bgp	Border Gateway Protocol.
chargen	Character generator.
cmd	Remote commands.
daytime	Daytime.
discard	Discard.
domain	Domain Name Service.
drip	Dynamic Routing Information Protocol.
echo	Echo.
exec	EXEC.
finger	Finger.

ftp	File Transfer Protocol.
ftp-data	FTP data connections.
gopher	Gopher.
hostname	NIC hostname server.
ident	Ident Protocol.
irc	Internet Relay Chat.
klogin	Kerberos login.
kshell	Kerberos shell.
login	Login.
lpd	Printer service.
nnt	Network News Transport Protocol.
pim-auto-rp	PIM Auto-RP.
pop2	Post Office Protocol v2.
pop3	Post Office Protocol v3.
smtp	Simple Mail Transport Protocol.
ssh	Secure Shell.
sunrpc	Sun Remote Procedure Call.
tacacs	TAC Access Control System.
talk	Talk.
telnet	Telnet.
time	Time.
uucp	UNIX-to-UNIX Copy Program.
whois	WHOIS/NICNAME
www	World Wide Web.
nntp	Range of source or destination port numbers:
dscp	Match packets with given DSCP value.
<0-63>	DSCP value.
af11	AF11 DSCP (001010) decimal value 10.
af12	AF12 DSCP (001100) decimal value 12.
af13	AF13 DSCP (001110) decimal value 14.
af21	AF21 DSCP (010010) decimal value 18.
af22	AF22 DSCP (010100) decimal value 20.
af23	AF23 DSCP (010110) decimal value 22.
af31	AF31 DSCP (011010) decimal value 26.
af32	AF32 DSCP (011100) decimal value 28.
af33	AF33 DSCP (011110) decimal value 30.
af41	AF41 DSCP (100010) decimal value 34
af42	AF42 DSCP (100100) decimal value 36.
af43	AF43 DSCP (100110) decimal value 38.

---

cs1	CS1 (precedence 1) DSCP (001000) decimal value 8.
cs2	CS2 (precedence 2) DSCP (010000) decimal value 16.
cs3	CS3 (precedence 3) DSCP (011000) decimal value 24.
cs4	CS4 (precedence 4) DSCP (100000) decimal value 32.
cs5	CS5 (precedence 5) DSCP (101000) decimal value 40.
cs6	CS6 (precedence 6) DSCP (110000) decimal value 48.
cs7	CS7 (precedence 7) DSCP (111000) decimal value 56.
default	Default DSCP (000000) decimal value 0.
ef	EF DSCP (101110) decimal value 46.
biff	Biff.
bootpc	Bootstrap Protocol (BOOTP) client.
bootps	Bootstrap Protocol (BOOTP) server.
discard	Discard.
dnsix	DNSIX security protocol auditing.
domain	Domain Name Service.
echo	Echo.
isakmp	Internet Security Association and Key Management Protocol.
mobile-ip	Mobile IP registration.
nameserver	IEN116 name service.
netbios-dgm	Net BIOS datagram service.
netbios-ns	Net BIOS name service.
netbios-ss	Net BIOS session service.
non500-isakmp	Non500-Internet Security Association and Key Management Protocol.
ntp	Network Time Protocol.
pim-auto-rp	PIM Auto-RP.
rip	Routing Information Protocol.
snmp	Simple Network Management Protocol.
snmptrap	SNMP Traps.
sunrpc	Sun Remote Procedure Call.
syslog	System Logger.
tacacs	TAC Access Control System.
talk	Talk.
tftp	Trivial File Transfer Protocol.
time	Time.
who	Who service.
xdmcp	X Display Manager Control Protocol.
vlan	Match packets with given vlan value.
<1-4094>	VLAN identifier.

### **Default**

No default value is specified

### **Command Mode**

IPv6 access-list mode

### **Applicability**

This command was introduced before OcnOS version 1.3.

### **Examples**

```
#configure terminal
(config)#ipv6 access-list mylist
(config-ipv6-acl)#deny udp any eq tftp any
(config-ipv6-acl)#deny tcp fd22:bf66:78a4:10a2::/64 fdf2:860a:746a:e49c::/64 eq ssh
```

---

## mac access-group

Use this command to attach a MAC access list to an interface to filter incoming packets.

When you attach an access list to a VLAN interface or LAG interface as well as to a physical interface that is a member of that LAG and/or VLAN interface, the priority order is:

1. VLAN interface
2. LAG interface
3. Physical interface

For example, if you attach access lists to both a LAG interface and a physical interface that is a member of that LAG, matching traffic rules are applied to the LAG interface, but not to the physical interface.

The `time-range` parameter is optional. If used, the access-group is tied to the timer specified.

After the access-group has been configured with the time-range, to detach the access-group from the time-range, use the `no` form of this command with a time-range parameter as shown in the syntax and examples below.

To delete the access-group, use the `no` form of this command without a time-range.

**Note:** To attach a MAC ACL in the ingress direction `ingress-l2` or `ingress-l2-ext` TCAM group needs to be enabled and to attach a MAC ACL in the egress direction `egress-l2` TCAM group needs to be enabled. See the [hardware-profile filter](#) command for details.

**Note:** An egress ACL is supported on physical and lag interfaces only. VLAN and inner-VLAN options in ACL rules will match incoming packet VLANs even when ACL attached at egress.

### Command Syntax

```
mac access-group NAME (in|out) (in|out) (time-range TR_NAME|)
no mac access-group NAME (in|out) (time-range TR_NAME|)
```

### Parameters

NAME	Access list name.
in	Filter incoming packets.
out	Filter outgoing packets.
TR_NAME	Time range name set with the <a href="#">time-range</a> command.

### Default

No default value is specified

### Command Mode

Interface mode

### Applicability

This command was introduced before OcNOS version 1.3. The `time-range` parameter was added in OcNOS version 5.0.

### Examples

```
#configure terminal
```

## Access Control List Commands

---

```
(config)#mac access-list mylist
(config-mac-acl)#permit any any
(config-mac-acl)#exit
```

```
(config)#hardware-profile filter ingress-l2-ext enable
```

```
(config)#interface xe3
(config-if)#mac access-group mylist in
(config-if)#exit
```

```
(config)#interface xe3
(config-if)#mac access-group mylist in time-range TIMER1
(config-if)#exit
```

```
(config)#interface xe3
(config-if)#no mac access-group mylist in time-range TIMER1
(config-if)#exit
```

```
(config)#interface xe3
(config-if)#no mac access-group mylist in
(config-if)#exit
```



---

## mac access-list

Use this command to define a MAC access control list (ACL) that determines whether to accept or drop an incoming packet based on specifications configured under the ACL. An ACL is made up of one or more ACL specifications.

Each packet that arrives at the device is compared to each specification in each ACL in the order that they are defined. The device continues to look until it has a match. If no match is found and the device reaches the end of the list, the packet is denied by default. For this reason, place the most frequently occurring specifications at the top of the list.

The device stops checking the specifications after a match occurs.

There is an implied deny specification for traffic that is not permitted. Implied specification can be updated to permit if the use-case is to deny a certain set of traffic.

Use the `no` form of this command to remove an ACL.

### Command Syntax

```
mac access-list NAME
no mac access-list NAME
```

### Parameters

NAME	Access-list name.
------	-------------------

### Default

No default value is specified

### Command Mode

Configure mode

### Applicability

This command was introduced before OcnOS version 1.3.

### Examples

```
#configure terminal
(config)#mac access-list mac-acl-01
(config-mac-acl)#exit
```

---

## mac access-list default

Use this command to modify the default rule action of mac access-list. Default rule is applicable only when access-list is attached to interface. Default rule will have the lowest priority and only the packets not matching any of the user defined rules match default rule.

### Command Syntax

```
default (deny-all|permit-all)
```

### Parameters

deny-all	Drop all packets.
permit-all	Accept all packets.

### Default

No default value is specified

### Command Mode

MAC access-list mode

### Applicability

This command was introduced before OcnOS version 1.3.

### Examples

```
#configure terminal
(config)#mac access-list mac-acl-01
(config-mac-acl)#default permit-all
```

## mac access-list filter

Use this command to define an access control entry (ACE) in a mac access control list (ACL) that determines whether to permit or deny packets with the given source and destination MAC, ether type, cos and VLAN values.

Use the `no` form of this command to remove an ACL specification. ACL specification can be removed using the sequence number as well.

Note: Configuring same filter again with change of sequence number or change of action will result in update of sequence number or filter action.

Note: Ether type option is not supported by hardware in egress direction

### Command Syntax

```
(<1-268435453>|) (deny|permit) (any | (XX-XX-XX-XX-XX-
XX|XX:XX:XX:XX:XX:XX|XXXX.XXXX.XXXX) (XX-XX-XX-XX-XX-
XX|XX:XX:XX:XX:XX:XX|XXXX.XXXX.XXXX) | host (XX-XX-XX-XX-XX-
XX|XX:XX:XX:XX:XX:XX|XXXX.XXXX.XXXX)) (any | (XX-XX-XX-XX-XX-
XX|XX:XX:XX:XX:XX:XX|XXXX.XXXX.XXXX) (XX-XX-XX-XX-XX-
XX|XX:XX:XX:XX:XX:XX|XXXX.XXXX.XXXX) | host (XX-XX-XX-XX-XX-
XX|XX:XX:XX:XX:XX:XX|XXXX.XXXX.XXXX)) (arp|appletalk|decnet-
iv|diagnostic|etype-6000|etype-8042 |ip4|ip6|mpls|lat|lavc-sca|mop-console|mop-
dump|vines-echo|WORD|) (cos <0-7>|) (vlan <1-4094>|) (inner-vlan <1-4094>|)

no (<1-268435453>|) (deny|permit) (any | (XX-XX-XX-XX-XX-
XX|XX:XX:XX:XX:XX:XX|XXXX.XXXX.XXXX) (XX-XX-XX-XX-XX-
XX|XX:XX:XX:XX:XX:XX|XXXX.XXXX.XXXX) | host (XX-XX-XX-XX-XX-
XX|XX:XX:XX:XX:XX:XX|XXXX.XXXX.XXXX)) (any | (XX-XX-XX-XX-XX-
XX|XX:XX:XX:XX:XX:XX|XXXX.XXXX.XXXX) (XX-XX-XX-XX-XX-
XX|XX:XX:XX:XX:XX:XX|XXXX.XXXX.XXXX) | host (XX-XX-XX-XX-XX-
XX|XX:XX:XX:XX:XX:XX|XXXX.XXXX.XXXX)) (arp|appletalk|decnet-
iv|diagnostic|etype-6000|etype-8042 |ip4|ip6|mpls|lat|lavc-sca|mop-console|mop-
dump|vines-echo|WORD|) (cos <0-7>|) (vlan <1-4094>|) (inner-vlan <1-4094>|)

no (<1-268435453>)
```

### Parameters

<code>deny</code>	Drop the packet.
<code>permit</code>	Accept the packet.
<code>&lt;1-268435453&gt;</code>	IPv4 ACL sequence number.
<code>any</code>	Source/Destination any.
<code>XX-XX-XX-XX-XX-XX</code>	Source/Destination MAC address (Option 1).
<code>XX:XX:XX:XX:XX:XX</code>	Source/Destination MAC address (Option 2).
<code>XXXX.XXXX.XXXX</code>	Source/Destination MAC address (Option 3).
<code>XX-XX-XX-XX-XX-XX</code>	Source/Destination wildcard (Option1).
<code>XX:XX:XX:XX:XX:XX</code>	

	Source/Destination wildcard (Option2).
XXXX.XXXX.XXXX	
	Source/Destination wildcard (Option3).
host	A single source/destination host.
aarp	Ethertype - 0x80f3.
appletalk	Ethertype - 0x809b.
decnet-iv	Ethertype - 0x6003.
diagnostic	Ethertype - 0x6005.
etype-6000	Ethertype - 0x6000.
etype-8042	Ethertype - 0x8042.
ip4	Ethertype - 0x0800.
ip6	Ethertype - 0x86dd.
mpls	Ethertype - 0x8847.
lat	Ethertype - 0x6004.
lavc-sca	Ethertype - 0x6007.
mop-console	Ethertype - 0x6002.
mop-dump	Ethertype - 0x6001.
vines-echo	Ethertype - 0x0baf.
WORD	Any Ethertype value.
cos <0-7>	Cos value.
vlan <1-4094>	VLAN identifier.
inner-vlan <1 - 4094>	Inner-VLAN identifier.

### Default

No default value is specified

### Command Mode

MAC access-list mode

### Applicability

This command was introduced before OcNOS version 1.3.

### Examples

```
#configure terminal
(config)#mac access-list mac-acl-01
(config-mac-acl)#permit 0000.1234.1234 0000.0000.0000 any
```

---

## mac access-list remark

Use this command to add a description to a MAC access control list (ACL).

Use the `no` form of this command to remove an ACL description.

### Command Syntax

```
remark LINE
no remark
```

### Parameters

LINE                   ACL description up to 100 characters.

### Default

No default value is specified

### Command Mode

MAC access-list mode

### Applicability

This command was introduced before OcnOS version 1.3.

### Examples

```
#configure terminal
(config)#mac access-list mylist
(config-mac-acl)# remark Permit the inside admin address
```

---

## mac access-list resequence

Use this command to modify sequence numbers of mac access list specifications.

Note: Use a non-overlapping sequence space for new sequence number sets to avoid possible unexpected rule matches during transition.

Note: Re-sequencing an ACL attached to a management interface clears the ACL counters associated to it.

### Command Syntax

```
resequence <1-268435453> INCREMENT
```

### Parameters

<1-268435453> Starting sequence number.  
INCREMENT Sequence number increment steps.

### Default

No default value is specified

### Command Mode

MAC access-list mode

### Applicability

This command was introduced before OcNOS version 1.3.

### Examples

```
#configure terminal  
(config)#mac access-list mylist  
(config-mac-acl)#resequence 15 15
```

---

## show access-lists

Use this command to display a list of access list

### Command Syntax

```
show access-lists (NAME|) (expanded|summary|)
```

### Parameters

NAME	Access-list name.
expanded	Expanded access-list.
summary	Summary of access-list.

### Default

None

### Command Mode

Privileged Exec mode

### Applicability

This command was introduced before OcNOS version 1.3.

### Example

```
#show access-lists expanded
IP access list Iprule1
11 permit ip 30.0.0.1 0.0.0.255 172.124.0.2 0.0.0.255
default deny-all
MAC access list Macrule1
10 permit host 0000.1234.1234 any
default deny-all
IPv6 access list ipv6-acl-01
10 deny ahp 3ffe::/64 4ffe::/64
default deny-all
```

```
#show access-lists summary
IPV4 ACL Iprule1
statistics enabled
Total ACEs Configured: 1
Configured on interfaces:
xe3/1 - egress (Router ACL)
Active on interfaces:
xe1/3 - ingress (Router ACL)
MAC ACL Macrule1
statistics enabled
Total ACEs Configured: 0
Configured on interfaces:
Active on interfaces:
IPV6 ACL ipv6-acl-01
```

## Access Control List Commands

---

```
statistics enabled
Total ACEs Configured: 2
Configured on interfaces:
xe7/1 - ingress (Router ACL)
Active on interfaces:
```



---

## show arp access-lists

Use this command to display ARP access lists.

Note: Broadcast ARP request packets are counted twice.

### Command Syntax

```
show arp access-lists (NAME|) (expanded|summary|)
```

### Parameters

NAME	ARP access-list name.
expanded	Expanded access-list.
summary	Access-list summary.

### Command Mode

Privileged Exec mode and Exec mode

### Applicability

This command was introduced in OcNOS version 3.0.

### Example

```
#show arp access-lists
ARP access list arp1
  10 permit ip 1.1.1.0/24 mac 0000.0000.0001 FFFF.FFFF.FFF0
  20 deny ip 2.2.2.0/24 mac any
  default deny-all
```

```
#show arp access-lists summary
ARP ACL arp1
  statistics enabled
  Total ACEs Configured: 2
  Configured on interfaces:
    xe1 - ingress (Port ACL)
  Active on interfaces:
    xe1 - ingress (Port ACL)
```

## show ip access-lists

Use this command to display IP access lists.

Note: In Qumran devices, when both ip access-list and mac access-list configured on the same interface with rules from both access-lists matching the packet, the match packet statistics is incremented only for the access-list whose hardware-profile filter is configured at the last. Also, when qos is configured on the same interface, along with ingress-acl statistics profile, ingress-qos statistics profile need to be enabled in order to get statistics for both qos entries and acl entries.

Note: See [hardware-profile filter](#) for filter groups and [hardware-profile statistics](#).

### Command Syntax

```
show ip access-lists (NAME|) (expanded|summary|)
```

### Parameters

NAME	Access-list name.
expanded	Expanded access-list.
summary	Access-list summary.

### Default

None

### Command Mode

Exec mode and Privileged Exec mode

### Applicability

This command was introduced before OcNOS version 1.3.

### Example

```
#show ip access-lists
IP access list Iprule2
11 permit ip 30.0.0.1 0.0.0.255 172.124.0.2 0.0.0.255
12 deny ip 30.0.0.2 0.0.0.255 182.124.0.3/24
default deny-all
```

```
#show ip access-lists summary
IPV4 ACL Iprule3
statistics enabled
Total ACEs Configured: 4
Configured on interfaces:
sa1 - ingress (Port ACL)
sa3 - ingress (Router ACL)
sa8 - ingress (Port ACL)
vlan1.3 - ingress (Router ACL)
xe1/1 - ingress (Port ACL)
xe1/2 - ingress (Router ACL)
xe1/3 - ingress (Router ACL)
```

xe3/1 - egress (Router ACL)  
Active on interfaces:  
sa1 - ingress (Port ACL)  
xe1/1 - ingress (Port ACL)  
xe1/2 - ingress (Router ACL)  
xe1/3 - ingress (Router ACL)

## show ipv6 access-lists

Use this command to display IPv6 access lists.

### Command Syntax

```
show ipv6 access-lists (NAME|) (expanded|summary|)
```

### Parameters

NAME	Access-list name.
expanded	Expanded access-list.
summary	Summary of access-list.

### Default

None

### Command Mode

Privileged Exec mode and Exec mode

### Applicability

This command was introduced before OcNOS version 1.3.

### Example

```
#show ipv6 access-lists
IPv6 access list ipv6-acl-01
10 deny ahp 3ffe::/64 4ffe::/64
20 permit ahp 78fe::1/48 68fe::1/48
30 permit ahp 3333::1/64 4444::1/48 fragments
40 permit ahp 5555::1/64 4444::1/48 dscp af23
default deny-all
```

```
#show ipv6 access-lists summary
IPV6 ACL ipv6-acl-01
statistics enabled
Total ACEs Configured: 4
Configured on interfaces:
sa3 - ingress (Router ACL)
vlan1.3 - ingress (Router ACL)
xe1/1 - ingress (Port ACL)
xe1/2 - ingress (Router ACL)
xe1/3 - ingress (Router ACL)
Active on interfaces:
xe1/1 - ingress (Port ACL)
xe1/2 - ingress (Router ACL)
xe1/3 - ingress (Router ACL)
```

---

## show mac access-lists

Use this command to display MAC access lists.

Note: In Qumran devices, when both ip access-list and mac access-list configured on the same interface with rules from both access-lists matching the packet, match packet statistics is incremented only for the access-list whose hardware-profile filter is configured at the last. Also, when qos is configured on the same interface, along with ingress-acl statistics profile, ingress-qos statistics profile need to be enabled in order to get statistics for both qos entries and acl entries.

Note: See [hardware-profile filter](#) for filter groups and [hardware-profile statistics](#).

### Command Syntax

```
show mac access-lists (NAME|) (expanded|summary|)
```

### Parameters

NAME	Access-list name.
expanded	Expanded access-list.
summary	Summary of access-list.

### Default

None

### Command Mode

Privileged Exec mode and Exec mode

### Applicability

This command was introduced before OcNOS version 1.3.

### Example

```
#show mac access-lists
MAC access list Macrule2
default deny-all
MAC access list Macrule3
10 permit host 0000.1234.1234 any
20 deny host 1111.1111.AAAA any 65535
30 permit host 2222.2222.AAAA any 65535
40 permit 0000.3333.3333 0000.0000.FFFF 4444.4444.4444 0000.0000.FFFF
default deny-all [match=1126931077]
```

```
# show mac access-lists summary
MAC ACL Macrule3
statistics enabled
Total ACEs Configured: 4
Configured on interfaces:
sa3 - ingress (Router ACL)
sa8 - ingress (Port ACL)
vlan1.3 - ingress (Router ACL)
```

## Access Control List Commands

---

```
xe1/1 - ingress (Port ACL)
xe1/2 - ingress (Router ACL)
xe1/3 - ingress (Router ACL)
Active on interfaces:
xe1/1 - ingress (Port ACL)
xe1/2 - ingress (Router ACL)
xe1/3 - ingress (Router ACL)
```

---

## show running-config access-list

Use this command to show the running system status and configuration details for MAC and IP access lists.

### Command Syntax

```
show running-config access-list
```

### Parameters

None

### Default

None

### Command Mode

Privileged Exec mode, configure mode, and route-map mode

### Applicability

This command was introduced before OcNOS version 1.3.

### Example

```
#show running-config access-list
ip access-list abd
10 deny any any any
!
mac access-list abc
remark test
10 deny any any
!
```

---

## show running-config aclmgr

Use this command to display the entire access list configurations along with the attachment to interfaces.

### Command Syntax

```
show running-config aclmgr (all|)
```

### Parameters

all	Show running config with defaults
-----	-----------------------------------

### Default

None

### Command Mode

Exec mode and Privileged Exec mode

### Applicability

This command was introduced before OcNOS version 1.3.

### Example

```
>enable
#show running-config aclmgr
ip access-list ip-acl-01
11 permit ip 30.0.0.1 0.0.0.255 172.124.0.2 0.0.0.255
12 deny ip 30.0.0.2 0.0.0.255 182.124.0.3/24
mac access-list mac-acl-01
10 permit host 0000.1234.1234 any
20 permit host 0000.1111.AAAA any ipv4 cos 3 vlan 3
!
ipv6 access-list ipv6-acl-01
10 deny ipv6 3ffe::/64 4ffe::/64 dscp af43
20 permit ipv6 78fe::/64 68fe::/64 dscp cs3
!
interface xel/1
ip access-group ip-acl-01 in
!
```



---

## show running-config ipv6 access-list

Use this command to show the running system status and configuration details for IPv6 access lists.

### Command Syntax

```
show running-config ipv6 access-list
```

### Parameters

None

### Default

None

### Command Mode

Privileged exec mode, configure mode, and route-map mode

### Applicability

This command was introduced before OcNOS version 1.3.

### Example

```
#show running-config ipv6 access-list
ipv6 access-list test
10 permit any any any
```



## CHAPTER 24 Time Range Commands

---

This chapter describes the commands used to create and manage time range objects which are used to add a timing boundary for specified activities. The activity starts, ends, and repeats at the specific times that you set.

- [end-time \(absolute\)](#)
- [end-time after \(relative\)](#)
- [frequency](#)
- [frequency days \(specific days\)](#)
- [start-time \(absolute\)](#)
- [start-time after \(relative\)](#)
- [start-time now \(current\)](#)
- [time-range](#)

---

## end-time (absolute)

Use this command to set the end time for the time range to an absolute time.

### Command Syntax

```
end-time HH:MM <1-31> (january | february | march | april | may | june | july |  
    august | september | october | november | december) <1995-2035>
```

### Parameters

HH:MM	End time hour and minutes
<1-31>	Day of the month
april	Month of April
august	Month of August
december	Month of December
february	Month of February
january	Month of January
july	Month of July
june	Month of June
march	Month of March
may	Month of May
november	Month of November
october	Month of October
september	Month of September
<1995-2035>	Year

### Default

N/A

### Command Mode

Time range mode

### Applicability

This command was introduced in OcNOS version 5.0.

### Example

```
(config)#time-range TIMER1  
(config-tr)#end-time 10:10 20 february 2021
```

---

## end-time after (relative)

Use this command to set the end time for the time range to a relative time in minutes, from the configured start time.

### Command Syntax

```
end-time after <1-129600>
```

### Parameters

<1-129600>      Number of minutes from the start time

### Default

N/A

### Command Mode

Time range mode

### Applicability

This command was introduced in OcNOS version 5.0.

### Example

```
(config)#time-range TIMER1  
(config-tr)#end-time after 100
```

---

## frequency

Use this command to set the frequency for the time range.

### Command Syntax

```
frequency (daily|hourly|weekly)
```

### Parameters

daily	Daily frequency
hourly	Hourly frequency
weekly	Weekly frequency

### Default

N/A

### Command Mode

Time range mode

### Applicability

This command was introduced in OcNOS version 5.0.

### Example

```
(config)#time-range TIMER1  
(config-tr)#frequency hourly
```

---

## frequency days (specific days)

Use this command to set the frequency for the time range to specific days of the week.

### Command Syntax

```
frequency days WORD
```

### Parameters

WORD

Colon-separated list of 3-letter days of the week for the days on which the range is repeated. For example:

```
mon:tue:wed:thu:fri:sat:sun
```

### Default

N/A

### Command Mode

Time range mode

### Applicability

This command was introduced in OcNOS version 5.0.

### Example

```
(config)#time-range TIMER1
(config-tr)#frequency days mon:wed:fri
(config)#exit
(config)#time-range TIMER2
(config-tr)#frequency days mon:tue:wed:thu:fri:sat:sun
```

---

## start-time (absolute)

Use this command to set the start time for the time range to an absolute time.

### Command Syntax

```
start-time HH:MM <1-31> (january | february | march | april | may | june | july |  
    august | september | october | november | december) <1995-2035>
```

### Parameters

HH:MM	End time hour and minutes
<1-31>	Day of the month
april	Month of April
august	Month of August
december	Month of December
february	Month of February
january	Month of January
july	Month of July
june	Month of June
march	Month of March
may	Month of May
november	Month of November
october	Month of October
september	Month of September
<1995-2035>	Year

### Default

N/A

### Command Mode

Time range mode

### Applicability

This command was introduced in OcNOS version 5.0.

### Example

```
(config)#time-range TIMER1  
(config-tr)#start-time 09:09 20 february 2021
```



---

## start-time after (relative)

Use this command to set the start time for the time range to a relative time in minutes, from the current time.

### Command Syntax

```
start-time after <1-129600>
```

### Parameters

<1-129600>      Number of minutes from the current time

### Default

N/A

### Command Mode

Time range mode

### Applicability

This command was introduced in OcNOS version 5.0.

### Example

```
(config)#time-range TIMER1  
(config-tr)#start-time after 100
```

---

## start-time now (current)

Use this command to set the start time for the time range to the current system time.

### Command Syntax

```
start-time now
```

### Parameters

None

### Default

N/A

### Command Mode

Time range mode

### Applicability

This command was introduced in OcNOS version 5.0.

### Example

```
(config)#time-range TIMER1  
(config-tr)#start-time now
```

---

## time-range

Use this command to create a time range and go into the time range mode to configure the time range. If the time range already exists, then it will be edited.

Use the `no` form of this command to remove a time range object.

### Command Syntax

```
time-range NAME
no time-range NAME
```

### Parameters

NAME	Name of the time range.
------	-------------------------

### Default

N/A

### Command Mode

Configuration mode

### Applicability

This command was introduced in OcNOS version 5.0.

### Example

```
#configure terminal
(config)# time-range TIMER1
(config-tr)#?
```

Time Range configuration commands:

WORD	String
abort	Abort Transaction
commit	commit
end	End current mode and change to EXEC mode
end-time	The end time for the Time Range
exit	End current mode and down to previous mode
frequency	The frequency of the Time Range
help	Description of the interactive help system
no	Delete
quit	Exit current mode and down to previous mode
show	Show running system information
start-time	The start time for the Time Range



## CHAPTER 25 IP Service Level Agreements Commands

---

IP Service Level Agreements (SLAs) is a diagnostic method which generates and analyses the traffic between an OcNOS device and your network. IP SLA monitors and reports network performance data which helps you to identify the actual root cause of a problem when the performance level drops.

This chapter describes the commands used to manage the IP SLA for ICMP echo.

- [clear ip sla statistics](#)
- [frequency](#)
- [icmp-echo](#)
- [ip sla](#)
- [ip sla schedule](#)
- [show ip sla statistics](#)
- [show ip sla summary](#)
- [show running-config ip sla](#)
- [threshold](#)
- [timeout](#)

---

## clear ip sla statistics

Use this command to clear the IP SLA statistics.

### Command Syntax

```
clear ip sla statistics <1-65535>
```

### Parameters

1-65535	IP SLA identifier
---------	-------------------

### Default

N/A

### Command Mode

Exec mode and Privileged Exec mode

### Applicability

This command was introduced in OcnOS version 5.0.

### Examples

```
#clear ip sla statistics 1
```

---

## frequency

Use this command to configure the frequency/interval to send ICMP echo packets one by one.

Use the `no` form of this command to remove the configured ICMP echo frequency.

### Command Syntax

```
frequency <1-60>
no frequency
```

### Parameters

1-60	Frequency in seconds
------	----------------------

### Default

5 seconds

### Command Mode

IP SLA ICMP Echo mode (config-ip-sla-echo)

### Applicability

This command was introduced in OcNOS version 5.0.

### Examples

```
#configure terminal
(config)#ip sla 1
(config-ip-sla)#icmp-echo ipv4 10.12.28.1 source-interface xe1
(config-ip-sla-echo)#frequency 3
```

---

## icmp-echo

Use this command to select and configure the ICMP echo SLA operation. ICMP echo packets are constructed in the device and sent to the destination address that you specify. These packets are transferred on a specific interface by setting the `source-interface` parameter.

Use the `no` form of this command to un-configure or remove the configured ICMP echo measurement sessions.

### Command Syntax

```
icmp-echo (ipv4 A.B.C.D|ipv6 X:X::X:X|HOSTNAME) (source-interface IFNAME|)
no icmp-echo (ipv4 A.B.C.D | ipv6 X:X::X:X | HOSTNAME)
```

### Parameters

A.B.C.D	IPv4 address
X:X::X:X	IPv6 address
HOSTNAME	Host name
IFNAME	Source interface name

### Default

N/A

### Command Mode

IP SLA mode (config-ip-sla)

### Applicability

This command was introduced in OcNOS version 5.0.

### Examples

```
#configure terminal
(config)#ip sla 1
(config-ip-sla)#icmp-echo ipv4 10.12.28.1 source-interface xe1
(config-ip-sla-echo)#
```



## ip sla

Use this command to create an IP SLA instance. One instance maps to a single SLA operation. You can create multiple SLA operations to perform multiple similar or different SLA operations.

Use the `no` form of this command to remove a configured IP SLA configurations.

### Command Syntax

```
ip sla <1-65535>
no ip sla <1-65535>
```

### Parameters

1-65535	IP SLA identifier
---------	-------------------

### Default

N/A

### Command Mode

Configuration mode

### Applicability

This command was introduced in OcNOS version 5.0.

### Example

```
#configure terminal
(config)#ip sla 1
(config-ip-sla)#
```

## ip sla schedule

Use this command to schedule an IP SLA operation by associating a [time-range](#) object with the IP SLA operation. Use the `no` form of this command to stop the configured IP SLA measurement.

### Command Syntax

```
ip sla schedule <1-65535> time-range WORD (vrf (NAME)|)
```

### Parameters

<code>&lt;1-65535&gt;</code>	IP SLA identifier.
<code>time-range</code>	Time Range
<code>TR_NAME</code>	Time range name that you set with the <a href="#">time-range</a> command.
<code>vrf</code>	VPN Routing/Forwarding instance
<code>NAME</code>	VPN Routing/Forwarding instance name. Maximum limit 32 characters

### Default

N/A

### Command Mode

Configuration mode

### Applicability

This command was introduced in OcNOS version 5.0.

### Examples

```
#configure terminal
(config)#ip sla schedule 1 time-range t1 vrf v1
```

## show ip sla statistics

Use this command to display the statistics of IP SLA measurement.

### Command Syntax

```
show ip sla statistics (1-65535) detail
```

### Parameters

1-65535 IP SLA identifier.

### Default

N/A

### Command Mode

Exec mode and Privileged Exec mode

### Applicability

This command was introduced in OcNOS version 5.0.

### Examples

```
#show ip sla statistics 1 detail
=====
                IP SLA Statistics
=====
IP SLA ID           : 1
Start Time          : 2021 Aug 30 17:40:04
Elapsed time(milli sec) : 46015
Packets Sent        : 23
Packets Received    : 23
Packet Loss(%)      : 0.0000
Invalid Tests       : 0
Round Trip Delay(usec)
  Minimum           : 1000
  Maximum           : 1000
  Average           : 1000
```

[Table 25-72](#) explains the output fields.

**Table 25-72: show ip sla statistics fields**

Field	Description
IP SLA ID	IP SLA Identifier (1-65535)
Start Time	Measurement start time
Elapsed time(milli sec)	Time taken to complete the measurement in milliseconds
Packets Sent	Number of packet sent

**Table 25-72: show ip sla statistics fields (Continued)**

<b>Field</b>	<b>Description</b>
Packets Received	Number of packet received
Packet Loss(%)	Packet lost in percentage
Invalid Tests	Received ICMP echo reply packets after configured threshold limit will be marked as invalid tests
Round Trip Delay(usec)	Round trip delay between ICMP echo request and ICMP echo reply: minimum, maximum and average round trip delay in microseconds

---

## show ip sla summary

Use this command to display the summary of all IP SLA measurements.

### Command Syntax

```
show ip sla summary
```

### Parameters

None

### Default

N/A

### Command Mode

Exec mode and Privileged Exec mode

### Applicability

This command was introduced in OcNOS version 5.0.

### Examples

```
#show ip sla summary
IPSLAs Latest Operation Summary
Codes: * active, ^ inactive
```

ID	Type	Destination	Stats (usec)	Return Code	Last Run
-----					
^1	icmp-echo	20.2.2.3	0	OK	2021 Aug 23 13:53:37

[Table 25-73](#) explains the output fields.

**Table 25-73: show ip sla summary fields**

Field	Description
ID	IP SLA Identifier (1-65535)
Type	Measurement type
Destination	Destination address
Stats (usec)	Round trip time in microseconds for the measurement
Return Code	Measurement status
Last Run	Measurement last run date and time

---

## show running-config ip sla

Use this command to display the IP SLA running configuration alone.

### Command Syntax

```
show running-config ip sla
```

### Parameters

None

### Default

N/A

### Command Mode

Exec mode and Privileged Exec mode

### Applicability

This command was introduced in OcNOS version 5.0.

### Examples

```
#show running-config ip sla
ip sla 1
  icmp-echo ipv4 20.2.2.3
  frequency 2
  threshold 2000
  timeout 5000
ip sla schedule 1 time-range t1 vrf v1
```

---

## threshold

Use this command to configure the threshold for every ICMP echo packet.

Use the `no` form of this command to remove the configured ICMP echo threshold.

### Command Syntax

```
threshold <1000-60000>
no threshold
```

### Parameters

1000-60000      Threshold in milliseconds.

### Default

10000 milliseconds

### Command Mode

IP SLA ICMP Echo mode (config-ip-sla-echo)

### Applicability

This command was introduced in OcNOS version 5.0.

### Examples

```
#configure terminal
(config)#ip sla 1
(config-ip-sla)#icmp-echo ipv4 10.12.28.1 source-interface xe1
(config-ip-sla-echo)#threshold 5000
```

---

## timeout

Use this command to configure the timeout for every ICMP echo packet. Any packet arriving beyond this interval is considered to be lost.

Use the `no` form of this command to remove the configured ICMP echo timeout.

### Command Syntax

```
timeout <1000-60000>
no timeout
```

### Parameters

1000-60000      Timeout in milliseconds.

### Default

10000 milliseconds

### Command Mode

IP SLA ICMP Echo mode (config-ip-sla-echo)

### Applicability

This command was introduced in OcnOS version 5.0.

### Examples

```
#configure terminal
(config)#ip sla 1
(config-ip-sla)#icmp-echo ipv4 10.12.28.1 source-interface xe1
(config-ip-sla-echo)#timeout 5000
```



## CHAPTER 26 Object Tracking Commands

---

This chapter describes the Layer 3 subinterface commands:

- `track ip sla reachability`
- `delay up down`
- `show track`
- `show track <1-500>`
- `show track summary`
- `show running-config track`

---

## track ip sla reachability

Use this command to configure an Object for tracking using IP SLA.

Use the `no` form of this command to delete to object tracking

### Command Syntax

```
track <1-500> ip sla <1-65535> reachability)
no track <1-500> ip sla <1-65535> reachability
```

### Parameters

`object-number` (1-500) Identifier for the tracked object  
`ip-sla-number` (1-65535) Identifier for IP SLA association with tracking object

### Command Mode

Configuration mode

### Applicability

This command is introduced in OcNOS version 5.1.

### Example

```
#configure terminal
OcNOS(config)#track 1 ip sla 1 reachability
OcNOS(config-object-track)#commit
```

```
OcNOS(config)#no track 1
OcNOS(config)#commit
```

---

## delay up down

Use This command is used to delay the state change notification of Object tracking.

Use the `no` form of this command to remove delay the state change notification of Object

### Command Syntax

```
delay (up <1-9999>|) (down <1-9999>|)
no delay (|up|down)
```

### Parameters

<1-999>                      Delay in Notification in seconds.

### Default

NA

### Command Mode

Object tracking Mode

### Applicability

This command is introduced in OcNOS version 5.1.

### Example

```
OcNOS(config-object-track)#delay up 10 down 20
OcNOS(config-object-track)#no delay
OcNOS(config-object-track)#commit
OcNOS(config-object-track)#
OcNOS(config-object-track)#delay down 10
OcNOS(config-object-track)#commit
OcNOS(config-object-track)#no delay down
OcNOS(config-object-track)#commit
OcNOS(config-object-track)#
OcNOS(config-object-track)#delay up 10
OcNOS(config-object-track)#commit
OcNOS(config-object-track)#no delay up
OcNOS(config-object-track)#commit
OcNOS(config-object-track)#
```

---

## show track

Use this command to display Sham link information.

### Command Syntax

```
show track
```

### Parameters

None

### Default

NA

### Command Mode

Exec mode

### Applicability

This command is introduced in OcNOS version 5.1.

### Example

```
OcNOS#sh track
TRACK Id: 1
  IP SLA 1 reachability
  Reachability is DOWN
  0 changes, last change : 2021 Dec 11 05:20:23
OcNOS#
```

---

## show track <1-500>

Use this command to display Sham link information.

### Command Syntax

```
show track <1-500>
```

### Parameters

<1-500>                    object identifier

### Default

NA

### Command Mode

Privileged Exec mode and Exec mode

### Applicability

This command is introduced in OcNOS version 5.1.

### Example

```
OcNOS#sh track 2
TRACK Id: 2
  IP SLA 2 reachability
  Reachability is DOWN
    0 changes, last change : 2021 Dec 11 05:29:49
OcNOS#
```

---

## show track summary

Use this command to display the summary of all object tracking.

### Command Syntax

```
show track summary
```

### Parameters

NA

### Default

NA

### Command Mode

Privileged Exec mode and Exec mode

### Applicability

This command is introduced in OcNOS version 5.1.

### Example

```
OcNOS#sh track summary
Object Tracking Summary
ID          Type          Type-Identifier      State
-----
1          ip-sla          1                   DOWN
2          ip-sla          2                   DOWN
OcNOS#
```

---

## show running-config track

Use this command to display object tracking running configuration alone.

### Command Syntax

```
show running-config track
```

### Parameters

NA

### Default

NA

### Command Mode

Privileged Exec mode and Exec mode

### Applicability

This command is introduced in OcNOS version 5.1.

### Example

```
OcNOS#sh running-config track
track 1 ip sla 1 reachability
  delay up 20
!
track 2 ip sla 2 reachability
!
OcNOS#
```





---

## CHAPTER 27 Chassis Management Module Commands

---

This chapter provides a description, syntax, and examples of CMM feature commands:

- [cpu-core-usage](#)
- [debug cmm](#)
- [disk-activity-monitoring interval](#)
- [disk-activity-monitoring threshold](#)
- [locator led](#)
- [show hardware-information](#)
- [show system fru](#)
- [show system-information](#)
- [system-load-average](#)

You can retrieve the same set of information through SNMP that these commands display. This MIB is defined in `CMM-CHASSIS-MIB.txt`:

IP Infusion Inc. enterprise identifier	36673
Chassis MIB identifier	100

The MIB definition is available at:

- <https://github.com/IPInfusion/OcNOS/branches>

Navigate to the directory for the version of OcNOS that you are using.

Note: Critical logs in the console are equivalent to alert traps and alert logs on the console is equivalent to critical trap in SNMP.

## cpu-core-usage

Use this command to set threshold percentage values for monitoring CPU core use.

Use the `no` form of this command to set the default thresholds.

### Command Syntax

```
cpu-core-usage warning <51-100> alarm <91-100>
no cpu-core-usage
```

### Parameters

<51-100>	Warning threshold percentage
<91-100>	Alarm threshold percentage

### Default

Check the default thresholds using the `show system-information` command with the `cpu-load` parameter.

### Command Mode

Config Mode

### Applicability

This command was introduced in OcNOS version 1.3.6.

### Example

```
(config)#cpu-core-usage warning 56 alarm 97
(config)#end

#show system-information cpu-load

System CPU-Load Information
=====

Uptime                : 64 Days 18 Hours 20 Minutes 12 Seconds

Load Average(1 min)   : 4.24% (Crit Thresh : 40%, Alert Thresh : 50%)
Load Average(5 min)   : 2.87% (Crit Thresh : N/A, Alert Thresh : 50%)
Load Average(15 min)  : 3.37% (Crit Thresh : N/A, Alert Thresh : 50%)

Avg CPU Usage         : 2.02%
CPU core 1 Usage      : 0.89% (Crit Thresh : 56%, Alert Thresh : 97%)
CPU core 2 Usage      : 0.00% (Crit Thresh : 56%, Alert Thresh : 97%)
CPU core 3 Usage      : 5.41% (Crit Thresh : 56%, Alert Thresh : 97%)
CPU core 4 Usage      : 2.68% (Crit Thresh : 56%, Alert Thresh : 97%)

#con t
Enter configuration commands, one per line. End with CNTL/Z.
(config)#no cpu-core-usage
(config)#end

#show system-information cpu-load
```

## System CPU-Load Information

=====

```
Uptime                : 64 Days 18 Hours 21 Minutes 46 Seconds
Load Average(1 min)   : 2.44% (Crit Thresh : 40%, Alert Thresh : 50%)
Load Average(5 min)   : 2.49% (Crit Thresh : N/A, Alert Thresh : 50%)
Load Average(15 min)  : 3.27% (Crit Thresh : N/A, Alert Thresh : 50%)
Avg CPU Usage         : 1.82%
CPU core 1 Usage      : 0.00% (Crit Thresh : 50%, Alert Thresh : 90%)
CPU core 2 Usage      : 0.00% (Crit Thresh : 50%, Alert Thresh : 90%)
CPU core 3 Usage      : 4.59% (Crit Thresh : 50%, Alert Thresh : 90%)
CPU core 4 Usage      : 1.82% (Crit Thresh : 50%, Alert Thresh : 90%)
#
```

---

## debug cmm

Use this command to enable or disable debugging for CMM.

### Command Syntax

```
debug cmm
no debug cmm
```

### Parameters

None

### Default

By default, CMM debugging is disabled.

### Command Mode

Configuration mode and exec mode

### Applicability

This command was introduced before OcNOS version 1.3.

### Example

```
#configure terminal
(config)#debug cmm
(config)#no debug cmm
```

---

## disk-activity-monitoring interval

Use this command to set the disk activity monitoring interval in seconds.

Use the `no` form of this command to set the disk activity monitoring interval to its default value of 600 seconds.

### Command Syntax

```
disk-activity-monitoring interval <30-1200>
no disk-activity-monitoring interval
```

### Parameters

<30-1200>            Monitoring interval in seconds.

### Default

The default monitoring interval is 600 seconds.

### Command Mode

Configuration mode

### Applicability

This command was introduced in OcNOS version 5.2.

### Example

```
(config)#disk-activity-monitoring interval 60
(config)#commit
#
```

---

## disk-activity-monitoring threshold

Use this command to set the threshold activity value for disk reads or writes. When the device reaches the threshold level, operator logs, SNMP traps, and NetConf notifications are displayed/sent. A threshold value of zero means that the monitoring is disabled.

Use the `no` form of this command to set the threshold activity for reads or writes in the default value of zero.

### Command Syntax

```
disk-activity-monitoring threshold (read <1-20000> | write <1-20000>)  
no disk-activity-monitoring threshold (read | write)
```

### Parameters

<code>read</code>	Threshold level for reads.
<code>&lt;1-20000&gt;</code>	Threshold level in KBps.
<code>write</code>	Threshold level for writes.
<code>&lt;1-20000&gt;</code>	Threshold level in KBps.

### Default

The default threshold activity value for reads and writes is zero (disabled).

### Command Mode

Configuration mode

### Applicability

This command was introduced in OcNOS version 5.2.

### Example

```
(config)#disk-activity-monitoring threshold read 3000  
(config)#commit  
#  
  
(config)#disk-activity-monitoring threshold write 4500  
(config)#commit
```

## locator led

Use this command to turn on the locator LED.

Use the `no` form of this command to turn off the locator LED.

### Command Syntax

```
locator-led on
no locator-led
```

### Parameters

None

### Default

By default, the locator LED is turned off.

### Command Mode

Configuration mode

### Applicability

This command was introduced before OcNOS version 1.3.

### Example

```
#configure terminal
(config)#locator-led on
(config)#no locator-led
```

---

## show hardware-information

Use this command to display hardware information.

### Command Syntax

```
show hardware-information (memory|fan|temperature|led|power (|monitoring-  
thresholds)|transceiver|system-status|all)
```

### Parameter

all	Hardware details of all modules.
fan	Fan status of the boards.
led	LED status of the boards.
memory	Memory information of the boards.
power	PSU information.
monitoring-thresholds	Monitoring thresholds (if provided by hardware).
temperature	Temperature sensor information of the boards.
transceiver	Transceiver presence status and supported list of transceivers.
system-status	System fault status.

### Default

None

### Command Mode

Exec mode

### Applicability

This command was introduced before OcNOS version 1.3. The `monitoring-thresholds` and `system-status` parameters were added in OcNOS version 5.2.

### Example

```
#show hardware-information all
```

```
-----  
RAM INFORMATION  
-----
```

```
Total           : 15930 MB  
Used             : 1073 MB (7 %)  
Free            : 14857 MB (93 %)  
Shared          : 25 MB  
Buffers         : 153 MB  
Total Swap      : 0 MB  
Free Swap       : 0 MB  
Current Processes : 253  
Total High Memory : 0 MB
```



```

Available High Memory      : 0 MB
Unit Size                  : 1 Bytes
Alert Threshold            : 90 %
Critical Threshold         : 80 %
    
```

HARD DISK INFORMATION

```

Serial Number              : 99009190902000000103
Model Number               : ATP I-Temp M.2 2242
Firmware Revision          : R0822A ATP I-Temp M.2 2242
Cylinders                  : 16383
Heads                      : 16
Sectors                   : 250000000
Unformatted Bytes/Track   : 0
Unformatted Bytes/Sector  : 0
Revision No                : 1008.0
Usage Alert Threshold      : 90 %
Usage Critical Threshold   : 80 %
    
```

Filesystem	Total	Used	Free	Use%
/	114365	10889	103476	10%
/cfg	476	79	397	17%
/installers	4911	282	4629	6%

-----System Sensors-----

```

Codes: LNR - Lower Non-Recoverable
       LCR - Lower Critical
       LNC - Lower Non-Critical
       UNC - Upper Non-Critical
       UCR - Upper Critical
       UNR - Upper Non-Recoverable
    
```

Note: For discrete sensor, thresholds and value columns are not applicable.

SENSOR	VALUE	UNITS	LNR	LCR	LNC	UNC
UCR	UNR	STATE				
Temp_MAC	41.000	degrees C	na	na	na	96.000
101.000	106.000	ok				
Temp_CPU	39.000	degrees C	na	na	na	92.000
97.000	102.000	ok				
Temp_BMC	33.000	degrees C	na	na	na	80.000
85.000	89.000	ok				
Temp_10GPHY	35.000	degrees C	na	na	na	92.000
95.000	98.000	ok				
Temp_DDR4	31.000	degrees C	na	na	na	85.000
90.000	92.000	ok				

## Chassis Management Module Commands

Temp_FANCARD1	29.000	degrees C	na	na	na	80.000
85.000	89.000	ok				
Temp_FANCARD2	28.000	degrees C	na	na	na	80.000
85.000	89.000	ok				
PSU0_Temp	38.000	degrees C	na	na	na	86.000
90.000	95.000	ok				
PSU1_Temp	27.000	degrees C	na	na	na	86.000
90.000	95.000	ok				
VSENSE_BMC_P12V	12.200	Volts	11.200	11.400	na	na
12.600	12.750	ok				
VSENSE_HEATER	0.000	Volts	na	na	na	9.900
10.000	10.100	ok				
VSENSE_BMC_P2V5	2.520	Volts	2.320	2.360	na	na
2.640	2.680	ok				
VSENSE_1VDDR	1.010	Volts	0.900	0.940	na	na
1.060	1.080	ok				
VSENSE_BMC_P5VT	5.040	Volts	4.680	4.740	na	na
5.250	5.310	ok				
VSENSE_P5V_SB	5.010	Volts	4.680	4.740	na	na
5.250	5.310	ok				
VSENSE_BMC_1.26V	1.260	Volts	1.150	1.200	na	na
1.320	1.360	ok				
VSENSE_BMC_1.53V	1.550	Volts	1.380	1.460	na	na
1.610	1.690	ok				
VSENSE_BMC_P3V3	3.280	Volts	3.020	3.140	na	na
3.480	3.640	ok				
FAN_0	12400.000	RPM	2400.000	3200.000	6000.000	na
na	na	ok				
FAN_1	12500.000	RPM	2400.000	3200.000	6000.000	na
na	na	ok				
FAN_2	11600.000	RPM	2400.000	3200.000	6000.000	na
na	na	ok				
FAN_3	11900.000	RPM	2400.000	3200.000	6000.000	na
na	na	ok				
FAN_4	12200.000	RPM	2400.000	3200.000	6000.000	na
na	na	ok				
PSU0_FAN	8190.000	RPM	3330.000	3600.000	3960.000	na
na	na	ok				
PSU1_FAN	0.000	RPM	3330.000	3600.000	3960.000	na
na	na	Lower Non-Recoverable				
HWM_VCORE_IN	1.000	Volts	0.910	0.940	na	na
1.060	1.090	ok				
HWM_P1V0_VIN	1.000	Volts	0.900	0.950	na	na
1.050	1.070	ok				
HWM_P1V2_VIN	1.180	Volts	1.110	1.140	na	na
1.260	1.290	ok				
HWM_P1V25_VIN	1.240	Volts	1.150	1.190	na	na
1.310	1.340	ok				
HWM_P1V8_VIN	1.770	Volts	1.660	1.710	na	na
1.900	1.950	ok				
HWM_P3V3_VIN	3.280	Volts	3.040	3.120	na	na
3.480	3.580	ok				
HWM_Temp_MAC	34.000	degrees C	-45.000	-42.000	-40.000	86.000
90.000	95.000	ok				
HWM_Temp_Heater	39.000	degrees C	-45.000	-42.000	-40.000	73.000
75.000	78.000	ok				

---

```

HWM_Temp_BMC      | 34.000      | degrees C | -45.000      | -42.000      | -40.000      | 80.000
| 85.000      | 89.000      | ok
HWM_Temp_CPU      | 33.000      | degrees C | -45.000      | -42.000      | -40.000      | 86.000
| 90.000      | 95.000      | ok
HWM_Temp_AMB      | 28.000      | degrees C | -45.000      | -42.000      | -40.000      | 76.000
| 80.000      | 84.000      | ok
HWM_Temp_PHY3     | 33.000      | degrees C | -45.000      | -42.000      | -40.000      | 86.000
| 90.000      | 95.000      | ok
CPU_PROC_HOT      | 0x0          | discrete  | na           | na           | na           | na
| na          | na          | Limit Not Exceed
CPU_CAT_ERROR     | 0x0          | discrete  | na           | na           | na           | na
| na          | na          | State Deasserted
CPU_THERMAL_TRIP  | 0x0          | discrete  | na           | na           | na           | na
| na          | na          | Limit Not Exceed
CPU_TO_BMC_INT    | 0x0          | discrete  | na           | na           | na           | na
| na          | na          | State Deasserted
Thermal_NMI       | 0x0          | discrete  | na           | na           | na           | na
| na          | na          | Limit Not Exceed
Thermal_BMC_ALRT  | 0x0          | discrete  | na           | na           | na           | na
| na          | na          | Limit Not Exceed
Thermal_PHY_ALRT  | 0x0          | discrete  | na           | na           | na           | na
| na          | na          | Limit Not Exceed
Thermal_MAC_ALRT  | 0x0          | discrete  | na           | na           | na           | na
| na          | na          | Limit Not Exceed
Thermal_DDR_ALRT  | 0x0          | discrete  | na           | na           | na           | na
| na          | na          | Limit Not Exceed
CPLD_NMI          | 0x0          | discrete  | na           | na           | na           | na
| na          | na          | State Deasserted
VCORE_Fault       | 0x0          | discrete  | na           | na           | na           | na
| na          | na          | State Deasserted
FAN_CARD_INT      | 0x0          | discrete  | na           | na           | na           | na
| na          | na          | State Deasserted
BMC_LOADDEFAULT   | 0x0          | discrete  | na           | na           | na           | na
| na          | na          | State Deasserted
CPU_BOOT_Done     | 0x0          | discrete  | na           | na           | na           | na
| na          | na          | Device Enabled
CPU_Presence      | 0x0          | discrete  | na           | na           | na           | na
| na          | na          | Device Present
Fan0_Presence     | 0x0          | discrete  | na           | na           | na           | na
| na          | na          | Device Present
Fan1_Presence     | 0x0          | discrete  | na           | na           | na           | na
| na          | na          | Device Present

```

---

## Chassis Management Module Commands

```

Fan2_Presence | 0x0 | discrete | na | na | na | na
| na | na | Device Present
Fan3_Presence | 0x0 | discrete | na | na | na | na
| na | na | Device Present
Fan4_Presence | 0x0 | discrete | na | na | na | na
| na | na | Device Present
CPU_POWEROK | 0x0 | discrete | na | na | na | na
| na | na | Device Enabled
MB_POWEROK | 0x0 | discrete | na | na | na | na
| na | na | Device Enabled
PSU0_Presence | 0x0 | discrete | na | na | na | na
| na | na | Device Present
PSU1_Presence | 0x0 | discrete | na | na | na | na
| na | na | Device Present
PSU0_POWEROK | 0x0 | discrete | na | na | na | na
| na | na | Device Enabled
PSU1_POWEROK | 0x0 | discrete | na | na | na | na
| na | na | Device Disabled
PSU0_INT1 | 0x0 | discrete | na | na | na | na
| na | na | State Deasserte
d
PSU1_INT1 | 0x0 | discrete | na | na | na | na
| na | na | State Deasserte
d
PSU0_VIN | 118.000 | Volts | na | na | na | na
| na | na | ok
PSU0_VOUT | 11.900 | Volts | na | na | na | na
| na | na | ok
PSU0_IIN | 0.850 | Amps | na | na | na | na
| na | na | ok
PSU0_IOUT | 2.480 | Amps | na | na | na | na
| na | na | ok
PSU1_VIN | 0.000 | Volts | na | na | na | na
| na | na | ok
PSU1_VOUT | 0.000 | Volts | na | na | na | na
| na | na | ok
PSU1_IIN | 0.000 | Amps | na | na | na | na
| na | na | ok
PSU1_IOUT | 0.000 | Amps | na | na | na | na
| na | na | ok

```

```

-----
LED          COLOR          DESCRIPTION
-----
POWER        GREEN          PSU operates Normally
SYSTEM       GREEN          Normal
GNSS         GREEN          GNSS in Normal State
SYNCE        GREEN          Synchronized to external timing source
-----

```

### Transceiver DDM support list

```

-----
Type          :SFP
Vendor Name   :FINISAR CORP.
Vendor Part Number :FTLF8519P2BNL
-----

```

---

```
DDM Supported           :Yes

Type                   :SFP
Vendor Name            :EVERTZ
Vendor Part Number     :SFP10G-TR13S
DDM Supported          :Yes

Type                   :SFP
Vendor Name            :FS
Vendor Part Number     :SFP-10GSR-85
DDM Supported          :Yes

Type                   :SFP
Vendor Name            :FS
Vendor Part Number     :SFP-10G-BX40
DDM Supported          :Yes

Type                   :SFP
Vendor Name            :FS
Vendor Part Number     :SFP-10G-BX
DDM Supported          :Yes

Type                   :SFP
Vendor Name            :FS
Vendor Part Number     :SFP-10GZRC-55
DDM Supported          :Yes

Type                   :SFP
Vendor Name            :FS
Vendor Part Number     :SFP-10G-BX80
DDM Supported          :Yes

Type                   :SFP
Vendor Name            :JDSU
Vendor Part Number     :PLRXPLSCS4322N
DDM Supported          :Yes

Type                   :SFP
Vendor Name            :DELL
Vendor Part Number     :CN04HG0091IAA1B
DDM Supported          :Yes

Type                   :SFP
Vendor Name            :DELL
Vendor Part Number     :WTRD1
DDM Supported          :Yes

Type                   :SFP
Vendor Name            :FINISAR CORP.
Vendor Part Number     :FTLF1318P3BTL-FC
```

---

## Chassis Management Module Commands

---

```
DDM Supported           :Yes

Type                   :SFP
Vendor Name           :DELL
Vendor Part Number    :RN84N
DDM Supported         :Yes

Type                   :SFP
Vendor Name           :E.C.I.NETWORKS
Vendor Part Number    :EN-SFP10G-LRi
DDM Supported         :Yes

Type                   :SFP
Vendor Name           :E.C.I.NETWORKS
Vendor Part Number    :EN-SFP10G-SRi
DDM Supported         :Yes

Type                   :SFP
Vendor Name           :E.C.I.NETWORKS
Vendor Part Number    :EN-SFP1G-SX
DDM Supported         :Yes

Type                   :SFP
Vendor Name           :E.C.I.NETWORKS
Vendor Part Number    :EN-SFP1G-LX
DDM Supported         :Yes

Type                   :SFP
Vendor Name           :E.C.I.NETWORKS
Vendor Part Number    :EN-SFP1G-EX
DDM Supported         :Yes

Type                   :SFP
Vendor Name           :E.C.I.NETWORKS
Vendor Part Number    :EN-SFP1G-ZX
DDM Supported         :Yes

Type                   :SFP
Vendor Name           :E.C.I.NETWORKS
Vendor Part Number    :EN-SFP10G-SR
DDM Supported         :Yes

Type                   :SFP
Vendor Name           :E.C.I.NETWORKS
Vendor Part Number    :EN-SFP10G-LR
DDM Supported         :Yes

Type                   :SFP
Vendor Name           :E.C.I.NETWORKS
Vendor Part Number    :EN-SFP10G-ER
```

---

```
DDM Supported           :Yes

Type                   :SFP
Vendor Name            :E.C.I.NETWORKS
Vendor Part Number     :EN-SFPP-ER
DDM Supported          :Yes

Type                   :SFP28
Vendor Name            :E.C.I.NETWORKS
Vendor Part Number     :EN-SFP28-SR
DDM Supported          :Yes

Type                   :SFP28
Vendor Name            :E.C.I.NETWORKS
Vendor Part Number     :EN-SFP28-LR
DDM Supported          :Yes

Type                   :SFP
Vendor Name            :E.C.I.NETWORKS
Vendor Part Number     :EN-SFP1G-SXi
DDM Supported          :Yes

Type                   :SFP
Vendor Name            :E.C.I.NETWORKS
Vendor Part Number     :EN-SFP1G-LXi
DDM Supported          :Yes

Type                   :SFP+
Vendor Name            :OCLARO, INC.
Vendor Part Number     :TRS7081AHCPA00A
DDM Supported          :Yes

Type                   :SFP
Vendor Name            :FINISAR CORP.
Vendor Part Number     :FTLX8574D3BCL
DDM Supported          :Yes

Type                   :SFP
Vendor Name            :FINISAR CORP.
Vendor Part Number     :FCLF8522P2BTL
DDM Supported          :NO

Type                   :SFP
Vendor Name            :Edgecore
Vendor Part Number     :ET5402-AOC-10M
DDM Supported          :Yes

Type                   :SFP
Vendor Name            :Hisense
Vendor Part Number     :LTE3680P-BH+
```

---

## Chassis Management Module Commands

---

DDM Supported :Yes

Type :SFP  
Vendor Name :Hisense  
Vendor Part Number :LTF5308B-BHA+  
DDM Supported :Yes

Type :SFP  
Vendor Name :Hisense  
Vendor Part Number :LTF7226B-BHA+  
DDM Supported :Yes

Type :QSFP  
Vendor Name :AVAGO  
Vendor Part Number :AFBR-79E4Z  
DDM Supported :Yes

Type :QSFP  
Vendor Name :FINISAR CORP  
Vendor Part Number :FCCN410QD3C  
DDM Supported :Yes

Type :QSFP  
Vendor Name :FINISAR CORP  
Vendor Part Number :FTL410QE4C  
DDM Supported :Yes

Type :QSFP  
Vendor Name :DELL  
Vendor Part Number :119N6  
DDM Supported :Yes

Type :QSFP  
Vendor Name :Skylane Optics  
Vendor Part Number :QFP85P1040PD000  
DDM Supported :Yes

Type :QSFP  
Vendor Name :Skylane Optics  
Vendor Part Number :QFPQL010400D000  
DDM Supported :Yes

Type :QSFP  
Vendor Name :Skylane Optics  
Vendor Part Number :QFPQL010400B000  
DDM Supported :Yes

Type :QSFP  
Vendor Name :Skylane Optics  
Vendor Part Number :QFPQL002400D000



---

```
DDM Supported           :Yes

Type                   :QSFP
Vendor Name            :Skylane Optics
Vendor Part Number     :QFP85P3040PD000
DDM Supported          :Yes

Type                   :QSFP
Vendor Name            :Skylane Optics
Vendor Part Number     :QFP85P1040PB000
DDM Supported          :Yes

Type                   :QSFP
Vendor Name            :Skylane Optics
Vendor Part Number     :DAPQQC504000000
DDM Supported          :NO

Type                   :QSFP
Vendor Name            :Skylane Optics
Vendor Part Number     :DAPQQM014000000
DDM Supported          :NO

Type                   :QSFP
Vendor Name            :Skylane Optics
Vendor Part Number     :DAPQQM034000000
DDM Supported          :NO

Type                   :QSFP
Vendor Name            :Skylane Optics
Vendor Part Number     :DAPQQM054000000
DDM Supported          :NO

Type                   :QSFP
Vendor Name            :Skylane Optics
Vendor Part Number     :QFP1301040PD000
DDM Supported          :Yes

Type                   :QSFP
Vendor Name            :Skylane Optics
Vendor Part Number     :QFPQL040400D000
DDM Supported          :Yes

Type                   :QSFP
Vendor Name            :E.C.I.NETWORKS
Vendor Part Number     :IPIENQSFP40GSR4
DDM Supported          :Yes

Type                   :QSFP28
Vendor Name            :DELL
Vendor Part Number     :4WJ41
```

---

## Chassis Management Module Commands

---

DDM Supported :Yes

Type :QSFP28  
Vendor Name :FINISAR CORP  
Vendor Part Number :FCBN425QE1C  
DDM Supported :Yes

Type :QSFP28  
Vendor Name :FINISAR CORP.  
Vendor Part Number :FTLC1151RDPL  
DDM Supported :Yes

Type :QSFP28  
Vendor Name :FINISAR CORP  
Vendor Part Number :FTLC9551REPM  
DDM Supported :Yes

Type :QSFP28  
Vendor Name :INPHI CORP  
Vendor Part Number :IN-Q2AY2  
DDM Supported :Yes

Type :QSFP28  
Vendor Name :FS  
Vendor Part Number :QSFP28-SR4-100G  
DDM Supported :Yes

Type :QSFP28  
Vendor Name :FS  
Vendor Part Number :QSFP-PC03  
DDM Supported :NO

Type :QSFP28  
Vendor Name :E.C.I.NETWORKS  
Vendor Part Number :EN-QSFP28-SR4  
DDM Supported :Yes

Type :QSFP28  
Vendor Name :E.C.I.NETWORKS  
Vendor Part Number :EN-QSFP28-LR4  
DDM Supported :Yes

Type :QSFP28  
Vendor Name :Skylane Optics  
Vendor Part Number :Q28QD010C07D000  
DDM Supported :Yes

Type :QSFP28  
Vendor Name :Skylane Optics  
Vendor Part Number :Q2885P30C0PF000

---

```
DDM Supported           :Yes

Type                   :QSFP28
Vendor Name            :Skylane Optics
Vendor Part Number     :Q28QD020C00D000
DDM Supported          :Yes

Type                   :QSFP28
Vendor Name            :Skylane Optics
Vendor Part Number     :DAOQQM01C00D000
DDM Supported          :Yes

Type                   :QSFP28
Vendor Name            :Skylane Optics
Vendor Part Number     :DAOQQM02C00D000
DDM Supported          :Yes

Type                   :QSFP28
Vendor Name            :Skylane Optics
Vendor Part Number     :DAOQQM03C00D000
DDM Supported          :Yes

Type                   :QSFP28
Vendor Name            :Skylane Optics
Vendor Part Number     :DAOQQM05C00D000
DDM Supported          :Yes

Type                   :QSFP28
Vendor Name            :Skylane Optics
Vendor Part Number     :DAOQQM07C00D000
DDM Supported          :Yes

Type                   :QSFP28
Vendor Name            :Skylane Optics
Vendor Part Number     :DAOQQM10C00D000
DDM Supported          :Yes

Type                   :QSFP28
Vendor Name            :Skylane Optics
Vendor Part Number     :DAOQQM20C00D000
DDM Supported          :Yes

Type                   :QSFP28
Vendor Name            :Skylane Optics
Vendor Part Number     :DAOQQM30C00D000
DDM Supported          :Yes

Type                   :QSFP28
Vendor Name            :Skylane Optics
Vendor Part Number     :DAOQQP10C00D000
```

---

## Chassis Management Module Commands

---

DDM Supported :Yes

Type :QSFP28  
Vendor Name :Skylane Optics  
Vendor Part Number :Q2885P10C0PF000  
DDM Supported :Yes

Type :QSFP28  
Vendor Name :Skylane Optics  
Vendor Part Number :Q28QD040C00F000  
DDM Supported :Yes

Type :QSFP28  
Vendor Name :Skylane Optics  
Vendor Part Number :Q28QD010C00D000  
DDM Supported :Yes

Type :QSFP28  
Vendor Name :Skylane Optics  
Vendor Part Number :Q28QD010C04D000  
DDM Supported :Yes

Type :QSFP28  
Vendor Name :Skylane Optics  
Vendor Part Number :Q28QD040C05F000  
DDM Supported :Yes

Type :QSFP28  
Vendor Name :Skylane Optics  
Vendor Part Number :Q28QD040C05D000  
DDM Supported :Yes

Type :QSFP28  
Vendor Name :Skylane Optics  
Vendor Part Number :DAPQQM03C000000  
DDM Supported :NO

Type :QSFP28  
Vendor Name :Skylane Optics  
Vendor Part Number :DAPQQM01C000000  
DDM Supported :NO

Type :QSFP28  
Vendor Name :Skylane Optics  
Vendor Part Number :DAPQQM02C000000  
DDM Supported :NO

Type :QSFP28  
Vendor Name :Skylane Optics  
Vendor Part Number :DAPQQM05C000000

```

DDM Supported          :NO

Type                  :QSFP28
Vendor Name           :Skylane Optics
Vendor Part Number    :DAPQQC50C000000
DDM Supported         :NO

Type                  :QSFP28
Vendor Name           :Skylane Optics
Vendor Part Number    :Q28QL002C00F000
DDM Supported         :Yes

Type                  :QSFP28
Vendor Name           :Skylane Optics
Vendor Part Number    :Q2C31002C00F000
DDM Supported         :Yes

Type                  :QSFP28
Vendor Name           :Skylane Optics
Vendor Part Number    :Q2C31P50C00F000
DDM Supported         :Yes

Type                  :QSFP28
Vendor Name           :Skylane Optics
Vendor Part Number    :Q2B85M70C00D000
DDM Supported         :Yes

Type                  :QSFP28
Vendor Name           :Skylane Optics
Vendor Part Number    :Q28QD080C05F000
DDM Supported         :Yes

Type                  :QSFP28
Vendor Name           :E.C.I.NETWORKS
Vendor Part Number    :IPIENQSFP28SR4
DDM Supported         :Yes

```

```

TX      : Transmit status
RX-Los  : Receive status
RESET   : Normal (Out of reset), Reset (In reset)
POWER   : Power level Low/High
-       : NotApplicable

```

SFP:[0-27]

```

-----
PORT  PRESENCE      Tx      Rx-Los
-----
0     Not Present   Off     -
1     Not Present   Off     -

```

## Chassis Management Module Commands

2	Not Present	Off	-
3	Present	On	-
4	Present	On	-
5	Not Present	Off	-
6	Present	On	-
7	Present	On	Off
8	Not Present	Off	-
9	Not Present	Off	-
10	Present	On	-
11	Present	On	-
12	Present	On	On
13	Not Present	Off	-
14	Not Present	Off	-
15	Present	On	Off
16	Present	On	Off
17	Not Present	Off	-
18	Present	On	-
19	Present	On	Off
20	Present	On	Off
21	Not Present	Off	-
22	Present	On	-
23	Present	On	-
24	Not Present	Off	-
25	Not Present	Off	-
26	Not Present	Off	-
27	Not Present	Off	-

QSFP:[0-1]

```

-----
-----
PORT      PRESENCE      RESET      POWER      LANE
-----
-----
                                1          2          3          4
-----
0         Not Present      Reset      Low      Tx      off      off      off      off
          Rx-Los      Off      Off      Off      Off      Off
          Tx-Los      Off      Off      Off      Off      Off
1         Present          Normal      High      Tx      on       on       on       on
          Rx-Los      Off      Off      Off      Off      Off
          Tx-Los      Off      Off      Off      Off      Off
  
```

System Over all status : Normal

-----  
 Components status  
 -----

CPU : Normal  
 RAM : Normal  
 DISK : Normal

SOFTWARE : Normal

Codes: H-Mi- High Minor H-Ma- High Major L-Mi- Low Minor L-Ma- Low Major

```
Component  Fault  Timestamp                Thresh  Violation-Status
-----  -
-----  -
-----  -
```

Table 27-74 explains the show command output fields.

**Table 27-74: show hardware-information all output**

Field	Description
Ram Information	Used memory, free memory, shared, buffers, total swap, and free swap memory.
Hard Disk Information	Hard drive serial number, model, firmware revision, cylinders, heads, and sectors, as well as revision number and total size.
Fans	Fan tray numbers, numbers of fans per tray, and their speed in RPM.
Board Temp Sensors Temperature	Sensor type, current temperature, and operating range.
BCM Chip Internal Temperature	Broadcom chip current internal temperature, Operating range and average temperature.
System Power Information	System power Information. Shows Voltage on all rails, and whether the power is up or has failed.
PSU	Main power supply statistics: Volts in, volts out, current in and out amperes, power in and out in watts, temperature of each power supply, and fan speed in RPM.
LED	What the LEDs represent, what state the LEDs mean, and a description of what the LEDs current color means.
Transceiver DDM support list	Transceivers: type, vendor name, part number, and whether Digital Diagnostic Monitoring (DDM) is supported.
Port Number	Port numbers, port type (SFP, QSFP, etc) and whether a transceiver is in the port.

```
#show hardware-information power
-----
Hardware Thresholds
-----
PSU1 [Input Voltage]
-----
Shutdown(O) : 62.00 Volts
Resume(O) : 60.00 Volts
Shutdown(U) : 38.00 Volts
Resume(U) : 36.00 Volts
PSU1 [Temperature 1]
-----
Shutdown(O) : 85.00 Celsius
Resume(O) : 80.00 Celsius
PSU2 [Input Voltage]
```

## Chassis Management Module Commands

```
-----
Shutdown(O)   : 62.00 Volts
Resume(O)     : 60.00 Volts
Shutdown(U)   : 38.00 Volts
Resume(U)     : 36.00 Volts
-----
```

### System Power Information

```
-----
CMM_PS1_12V_PG           : FAIL
CMM_PS2_12V_PG           : GOOD
CMM_PS1_AC_ALERT         : FAIL
CMM_PS2_AC_ALERT         : GOOD
-----
```

Codes:        \* Not Supported by device        NA Not Applicable        O Over        U Under

```
PSU            VOLT-IN        VOLT-OUT        CURR-IN        CURR-OUT        PWR-IN        PWR-OUT        TEMP-1
TEMP-2        FAN-1            FAN-2            PWR_
OUT_MAX
              (Volt)            (Volt)            (Ampere)        (Ampere)        (Watt)        (Watt)        (Celsius)
(Celsius)     (Rpm)            (Rpm)
```

```
-----
-----
2            225.00        12.00        1.47        25.50        330.00        306.00        27.00
31.00        4512            NA*            NA*
```

#

[Table 27-75](#) explains the show hardware-information power command output fields.

**Table 27-75: show hardware-information power output fields**

Field	Description
PSU Input Voltage	Shutdown and resume over and under voltages
PSU Temperature	Shutdown and resume over temperatures
System Power Information	Overall status of each PSU
PSU	Power supply unit identifier
VOLT-IN	Input voltage
VOLT-OUT	Output voltage
CURR-IN	Input current (ampere)
CURR-OUT	Output current (ampere)
PWR-IN	Input power (watts)
PWR-OUT	Output power (watts)



**Table 27-75: show hardware-information power output fields (Continued)**

Field	Description
TEMP-1	Temperature (Celsius)
TEMP-2	Temperature (Celsius)
FAN-1	FAN 1 RPM
FAN-2	FAN 2 RPM
PWR_OUT_MAX	Power out maximum

```
#show hardware-information power monitoring-thresholds
```

```
-----
      Input Voltage [PSU1]
-----
High Alarm      : 60.00 Volts
Low Alarm       : 40.00 Volts
High Warning    : 58.00 Volts
Low Warning     : 42.00 Volts
-----
      Temperature 1 [PSU1]
-----
High Alarm      : 75.00 Celsius
Low Alarm       : -10.00 Celsius
High Warning    : 73.00 Celsius
Low Warning     : -8.00 Celsius
-----
      Input Voltage [PSU2]
-----
High Alarm      : 60.00 Volts
Low Alarm       : 40.00 Volts
High Warning    : 58.00 Volts
Low Warning     : 42.00 Volts
```

[Table 27-76](#) explains the `show hardware-information power monitoring-thresholds` command output fields.

**Table 27-76: show hardware-information power monitoring-thresholds output fields**

Field	Description
Input Voltage	Voltages for high alarm, low alarm, high warning, and low warning thresholds
Temperature	Temperatures for high alarm, low alarm, high warning, and low warning thresholds

```
#show hardware-information system-status
```

```
System Over all status : Normal
```

## Chassis Management Module Commands

---

```
-----  
Components status  
-----  
CPU          : Normal  
RAM          : Normal  
DISK         : Normal  
FAN          : Normal  
POWER        : Normal  
SOFTWARE     : Normal  
  
Codes: H-Mi- High Minor H-Ma- High Major L-Mi- Low Minor L-Ma- Low Major  
  
Component  Fault  Timestamp          Thresh  Violation-Status  
-----  
DISK       H-Mi   12-02-2021 18:39:32  > 80.00  84.00%  
POWER      L-Mi   12-02-2021 18:43:46  < 42.00  Psu [1] of VOLT-IN is 42.00  
           12-02-2021 18:42:35          Psu [2] of VOLT-IN is 42.00  
           L-Ma   12-02-2021 18:41:44  < 40.00  Psu [1] of VOLT-IN is 24.00  
           H-Ma   12-02-2021 18:44:27  > 75.00  Psu [1] of TEMP1 is 80.00  
  
#
```

[Table 27-77](#) explains the `show hardware-information system-status` command output fields.

**Table 27-77: show hardware-information system-status output fields**

Field	Description
System Over all status	Self explanatory
Components status	Status of CPU, RAM, disk, fan, power, and software
Component	Component name

**Table 27-77: show hardware-information system-status output fields (Continued)**

<b>Field</b>	<b>Description</b>
Fault	Type of fault: H-Mi- High Minor H-Ma- High Major L-Mi- Low Minor L-Ma- Low Major
Timestamp	Date and time of the fault
Thresh	Threshold limit
Violation-Status	Explanation of violation

---

## show system fru

Use this command to display Field Replaceable Unit (FRU) information controlled by the baseboard management controller (BMC).

### Command Syntax

```
show system fru
```

### Parameter

None

### Command Mode

Execution mode

### Applicability

This command was introduced before OcNOS version 3.0.

### Example

```
#show system fru
-----System FRUs-----
FRU Device Description : MAINBOARD_FRU
Board Mfg Date       : 2018-09-17 13:34:00
Board Mfg            : UFISPACE
Board Product        : S9500-30XS-Board
Board Serial         : WB2N9470004
Product Manufacturer : UFISPACE
Product Name         : S9500-30XS
Product Version      : PVT
Product Serial       : WE61A47S00016
Product Asset Tag    : 00

FRU Device Description : PSU0_FRU
Product Manufacturer  : FSPGROUP
Product Name          : VICTO451AM
Product Part Number   : YNEB0450
Product Version       : BM-2R01P10
Product Serial        : T0A060Y322009000053
Product extra 1       : P3H800A03
Product extra 2       : A

FRU Device Description : PSU1_FRU
Product Manufacturer  : FSPGROUP
Product Name          : VICTO451AM
Product Part Number   : YNEB0450
Product Version       : BM-2R01P10
Product Serial        : T0A060Y322009000052
Product extra 1       : P3H800A03
Product extra 2       : A
```

---

## show system-information

Use this command to display system information.

### Command Syntax

```
show system-information (all|fan|psu|os|cpu|bios|cpu-load|board-info)
```

### Parameter

all	System information of all modules.
bios	BIOS information.
board-info	Board EEPROM details.
cpu	Processor information.
cpu-load	CPU load information.
fan	Fan Field Replaceable Units (FRU) EEPROM information.
os	OS and Kernel version information.
psu	Power Supply Field Replaceable Units (FRU) EEPROM information.

### Default

None

### Command Mode

Exec mode

### Applicability

This command was introduced before OcNOS version 1.3.

### Example

```
#show system-information psu
System PSU FRU Information
=====
PSU 2 Country of Origin           : CN
PSU 2 PPID Part Number           : 0T9FNW
PSU 2 PPID Part Number Rev       : A00
PSU 2 Manufacturer ID            : 28298
PSU 2 Date Code                  : 52R
PSU 2 Serial Number              : 0298
PSU 2 Part Number                : 0T9FNW
PSU 2 Part Number Revision       : A00
PSU 2 Number of Fans in the tray : 1
PSU 2 Type                       : AC Normal
PSU 2 Service Tag                : AEIOU
```

The following tables explain the show command output fields.

**Table 27-78: show system-information topics**

Topic	Description
all	Show all topics of system information..
bios	Display BIOS information.
board-info	Display information related to the board.
cpu	Displays Central Processing Unit information
cpu-load	Displays the load on the system's CPU.
fan	Displays fan information contain in the EEPROM.
os	Displays information regarding the host operating system
psu	Displays information regarding Field Replaceable Units (FRU).

**Table 27-79: Show fan topic displays**

System Fan FRU Information	Description
Fan Tray "#" PPID Part Number	The vendor's part number for the fan.
Fan Tray Serial Number	As stated
Service Tag	The Service Tag can help identify your device for on-line support and upgrading drivers
Vendor Name	As stated

**Table 27-80: Show system BIOS information**

BIOS Information	Description
# dmidecode	The dmidecode is a tool for dumping a computer's DMI table contents in a human-readable format. This table contains a description of the system's hardware components, as well as other useful pieces of information such as serial numbers and BIOS revisions.
SMBIOS	The System Management BIOS (SMBIOS) defines data structures (and access methods) that can be used to read management information produced by the BIOS of a computer.  Also, it is involved with the DMI Address –
Handle 0x0000, DMI type 0, 24 bytes	Handle of the Desktop Management Interface (DMI) and the DMI type, where type value identifies what the DMI contains. DMI = 0 indicates the following information is specific to BIOS properties, and is 24 bytes long.
BIOS Physical Information	<ul style="list-style-type: none"> <li>• Vendor – The manufacture of the BIOS.</li> <li>• Version – The Version number.</li> <li>• Release Date – as stated.</li> <li>• Address – starting address (in memory) of the BIOS.</li> </ul>

**Table 27-80: Show system BIOS information (Continued)**

BIOS Information	Description
Characteristics	<ul style="list-style-type: none"> <li>• Is PCI supported.</li> <li>• Is BIOS upgradeable.</li> <li>• Is boot from a CD supported.</li> <li>• Is selectable boot devices supported.</li> <li>• Is BIOS ROM socketed.</li> <li>• Is Enhanced Disk Drive (EDD) vectoring supported.</li> <li>• Is 5.25"/1.2 MB floppy services supported (int 13h)</li> <li>• Is 3.5"/720 kB floppy services supported (int 13h)</li> <li>• Is 3.5"/2.88 MB floppy services supported (int 13h)</li> <li>• Is Print screen service supported (int 5h)</li> <li>• Is 8042 keyboard services supported (int 9h)</li> <li>• Is Serial services supported (int 14h)</li> <li>• Is Printer services supported (int 17h)</li> <li>• Is Advanced Configuration and Power Interface (ACPI) supported</li> <li>• Is USB legacy supported</li> <li>• Is BIOS boot specification supported</li> <li>• Is Targeted content distribution supported</li> <li>• Is Unified Extensible Firmware Interface (UEFI) supported</li> </ul>
BIOS Revision	The BIOS revision number.
Handle 0x0043, DMI type 13, 22 bytes	Handle of the Desktop Management Interface (DMI) and the DMI type, where type value identifies what the DMI contains. DMI = 13 indicates the following information is specific to BIOS language information, and is 22 bytes long.
BIOS Language Information	<ul style="list-style-type: none"> <li>• Language Description Format – A term that describes the number of bits used to represent the BIOS Language information parameters.</li> <li>• Installable Languages – The number of languages that can be used by the BIOS at any time.</li> <li>• Currently Installed Language – United States English (or Latin-1) as described by the ISO standard, en US iso8859-1.</li> </ul>

**Table 27-81: Show CPU information**

System CPU Information	Description
processor	The processor number of each CPU
model name	Details about each CPU. For example, Intel(R) Atom(TM) CPU C2538 @ 2.40GHz.

**Table 27-82: Show system CPU load information**

Load Information	Description
Uptime	As stated in days, hours, minutes, and seconds.
Load Average for past 1min	As stated in percent.
Load Average for past 5 min	As stated in percent.

**Table 27-82: Show system CPU load information (Continued)**

Load Information	Description
Load Average for past 15 min	As stated in percent.
CPU Usage at this instant	As stated in percent.
Max threshold for CPU-usage	As stated in percent.

**Table 27-83: Show system board information**

System Information	Description
Product Name	Model number of the device.
Serial Number	As stated
Base MAC Address	As stated
Manufacture Date	As state
Platform Name	The platform on which the product is based.
ONIE Version	The version of the Open Network Install Environment (ONIE).
MAC addresses	Number of MAC addresses related to the device.
Manufacture	As stated
Country Code	The code that represents the country of manufacture. For example, US = United States, TW = Taiwan, and so on.
Diag Version	As stated
CRC-32	Cyclic Redundancy Check value.
Switch Chip Revision	As stated
MAIN BOARD REVISION	As stated
CPU CPLD VERSION	The version of the Complex Programmable Logic Device (CPLD) use by the CPU.
SW CPLD VERSION	The version of the Complex Programmable Logic Device (CPLD) use by the switch.
MAIN BOARD TYPE	An identifying string for the main board.
CPU BOARD ID	An identifying string for the CPU board.
CPU BOARD VERSION	As stated
SW BOARD ID	NA
SW BOARD VERSION	As stated
VCC 5V	The state of the VCC 5V power rail (Enabled \ Disabled)
MAC 1V	The state of the MAC 1V power rail Enabled \ Disabled



**Table 27-83: Show system board information (Continued)**

<b>System Information</b>	<b>Description</b>
VCC 1.8V	The state of the VCC 1.8V power rail (Enabled \ Disabled)
MAC AVS 1V	The state of the MAC AVS 1V power rail (Enabled \ Disabled)
HOT SWAP1	Enabled \ Disabled
HOT SWAP2	Enabled \ Disabled

**Table 27-84: Show host system details**

<b>Host Information</b>	<b>Description</b>
OS Distribution	The operating system on which the device is to run.
Kernel Version	A string that identifies the operating kernel.

## show system sensor

Use this command to display the system sensors controlled by the baseboard management controller (BMC).

### Command Syntax

```
show system sensor
```

### Parameter

None

### Command Mode

Execution mode

### Applicability

This command was introduced before OcNOS version 3.0.

### Example

```
#show system sensor
```

```
-----System Sensors-----
-----
Codes: LNR - Lower Non-Recoverable
LCR - Lower Critical
LNC - Lower Non-Critical
UNC - Upper Non-Critical
UCR - Upper Critical
UNR - Upper Non-Recoverable
Note: For discrete sensor, thresholds and value columns are not applicable.
```

SENSOR	VALUE	UNITS	LNR	LCR	LNC	UNC
UCR	UNR	STATE				
Temp_MAC	43.000	degrees C	na	na	na	96.000
101.000	106.000	ok				
Temp_CPU	40.000	degrees C	na	na	na	92.000
97.000	102.000	ok				
Temp_BMC	32.000	degrees C	na	na	na	80.000
85.000	89.000	ok				
Temp_10GPHY	35.000	degrees C	na	na	na	92.000
95.000	98.000	ok				
Temp_DDR4	33.000	degrees C	na	na	na	85.000
90.000	92.000	ok				
Temp_FANCARD1	29.000	degrees C	na	na	na	80.000
85.000	89.000	ok				
Temp_FANCARD2	27.000	degrees C	na	na	na	80.000
85.000	89.000	ok				
PSU0_Temp	37.000	degrees C	na	na	na	86.000
90.000	95.000	ok				
PSU1_Temp	28.000	degrees C	na	na	na	86.000
90.000	95.000	ok				

VSENSE_BMC_P12V	12.050	Volts	11.200	11.400	na	na
12.600	12.750	ok				
VSENSE_HEATER	0.000	Volts	na	na	na	9.900
10.000	10.100	ok				
VSENSE_BMC_P2V5	2.500	Volts	2.320	2.360	na	na
2.640	2.680	ok				
VSENSE_1VDDR	1.020	Volts	0.900	0.940	na	na
1.060	1.080	ok				
VSENSE_BMC_P5VT	5.040	Volts	4.680	4.740	na	na
5.250	5.310	ok				
VSENSE_P5V_SB	4.980	Volts	4.680	4.740	na	na
5.250	5.310	ok				
VSENSE_BMC_1.26V	1.250	Volts	1.150	1.200	na	na
1.320	1.360	ok				
VSENSE_BMC_1.53V	1.540	Volts	1.380	1.460	na	na
1.610	1.690	ok				
VSENSE_BMC_P3V3	3.280	Volts	3.020	3.140	na	na
3.480	3.640	ok				
FAN_0	12900.000	RPM	2400.000	3200.000	6000.000	na
na	na	ok				
FAN_1	13000.000	RPM	2400.000	3200.000	6000.000	na
na	na	ok				
FAN_2	12400.000	RPM	2400.000	3200.000	6000.000	na
na	na	ok				
FAN_3	12300.000	RPM	2400.000	3200.000	6000.000	na
na	na	ok				
FAN_4	11800.000	RPM	2400.000	3200.000	6000.000	na
na	na	ok				
PSU0_FAN	8280.000	RPM	3330.000	3600.000	3960.000	na
na	na	ok				
PSU1_FAN	0.000	RPM	3330.000	3600.000	3960.000	na
na	na	Lower Non-Recoverable				
HWM_VCORE_IN	1.000	Volts	0.910	0.940	na	na
1.060	1.090	ok				
HWM_P1V0_VIN	1.000	Volts	0.900	0.950	na	na
1.050	1.070	ok				
HWM_P1V2_VIN	1.210	Volts	1.110	1.140	na	na
1.260	1.290	ok				
HWM_P1V25_VIN	1.250	Volts	1.150	1.190	na	na
1.310	1.340	ok				
HWM_P1V8_VIN	1.780	Volts	1.660	1.710	na	na
1.900	1.950	ok				
HWM_P3V3_VIN	3.300	Volts	3.040	3.120	na	na
3.480	3.580	ok				
HWM_Temp_MAC	35.000	degrees C	-45.000	-42.000	-40.000	86.000
90.000	95.000	ok				
HWM_Temp_Heater	39.000	degrees C	-45.000	-42.000	-40.000	73.000
75.000	78.000	ok				
HWM_Temp_BMC	33.000	degrees C	-45.000	-42.000	-40.000	80.000
85.000	89.000	ok				
HWM_Temp_CPU	33.000	degrees C	-45.000	-42.000	-40.000	86.000
90.000	95.000	ok				
HWM_Temp_AMB	28.000	degrees C	-45.000	-42.000	-40.000	76.000
80.000	84.000	ok				
HWM_Temp_PHY3	35.000	degrees C	-45.000	-42.000	-40.000	86.000
90.000	95.000	ok				

## Chassis Management Module Commands

---

CPU_PROC_HOT	0x0	discrete	na	na	na	na
na	na	Limit Not Exceeded				
CPU_CAT_ERROR	0x0	discrete	na	na	na	na
na	na	State Deasserted				
CPU_THERMAL_TRIP	0x0	discrete	na	na	na	na
na	na	Limit Not Exceeded				
CPU_TO_BMC_INT	0x0	discrete	na	na	na	na
na	na	State Deasserted				
Thermal_NMI	0x0	discrete	na	na	na	na
na	na	Limit Not Exceeded				
Thermal_BMC_ALRT	0x0	discrete	na	na	na	na
na	na	Limit Not Exceeded				
Thermal_PHY_ALRT	0x0	discrete	na	na	na	na
na	na	Limit Not Exceeded				
Thermal_MAC_ALRT	0x0	discrete	na	na	na	na
na	na	Limit Not Exceeded				
Thermal_DDR_ALRT	0x0	discrete	na	na	na	na
na	na	Limit Not Exceeded				
CPLD_NMI	0x0	discrete	na	na	na	na
na	na	State Deasserted				
VCORE_Fault	0x0	discrete	na	na	na	na
na	na	State Deasserted				
FAN_CARD_INT	0x0	discrete	na	na	na	na
na	na	State Deasserted				
BMC_LOADDEFAULT	0x0	discrete	na	na	na	na
na	na	State Deasserted				
CPU_BOOT_Done	0x0	discrete	na	na	na	na
na	na	Device Enabled				
CPU_Presence	0x0	discrete	na	na	na	na
na	na	Device Present				
Fan0_Presence	0x0	discrete	na	na	na	na
na	na	Device Present				
Fan1_Presence	0x0	discrete	na	na	na	na
na	na	Device Present				
Fan2_Presence	0x0	discrete	na	na	na	na
na	na	Device Present				
Fan3_Presence	0x0	discrete	na	na	na	na
na	na	Device Present				
Fan4_Presence	0x0	discrete	na	na	na	na
na	na	Device Present				
CPU_POWEROK	0x0	discrete	na	na	na	na
na	na	Device Enabled				
MB_POWEROK	0x0	discrete	na	na	na	na
na	na	Device Enabled				
PSU0_Presence	0x0	discrete	na	na	na	na
na	na	Device Present				
PSU1_Presence	0x0	discrete	na	na	na	na
na	na	Device Present				
PSU0_POWEROK	0x0	discrete	na	na	na	na
na	na	Device Enabled				
PSU1_POWEROK	0x0	discrete	na	na	na	na
na	na	Device Disabled				
PSU0_INT1	0x0	discrete	na	na	na	na
na	na	State Deasserted				
PSU1_INT1	0x0	discrete	na	na	na	na
na	na	State Deasserted				

---

---

PSU0_VIN		99.000		Volts		na		na		na		na
na		na		ok								
PSU0_VOUT		11.900		Volts		na		na		na		na
na		na		ok								
PSU0_IIN		0.420		Amps		na		na		na		na
na		na		ok								
PSU0_IOUT		0.850		Amps		na		na		na		na
na		na		ok								
PSU1_VIN		0.000		Volts		na		na		na		na
na		na		ok								
PSU1_VOUT		0.000		Volts		na		na		na		na
na		na		ok								
PSU1_IIN		0.000		Amps		na		na		na		na
na		na		ok								
PSU1_IOUT		1.950		Amps		na		na		na		na
na		na		ok								

#

## system-load-average

Use this command to set threshold percentage values for monitoring the system load average for the last 1 minute, 5 minutes, and 15 minutes.

Use the `no` form of this command to set the default thresholds.

### Command Syntax

```
system-load-average (1min warning <41-100> alarm <51-100> 5min alarm <51-100> 15min
alarm <51-100>)
no system-load-average
```

### Parameters

1min warning	Load average for last 1 minute
<41-100>	Warning threshold in percent
alarm	Alarm
<51-100>	Alarm threshold in percent
5min alarm	Load average for last 5 minutes
<51-100>	Alarm threshold in percent
15min alarm	Load average for last 15 minutes
<51-100>	Alarm threshold in percent

### Default

Check the default thresholds using the `show system-information` command with the `cpu-load` parameter.

### Command Mode

Config Mode

### Applicability

This command was introduced in OcNOS version 1.3.6.

### Example

```
(config)#system-load-average 1min warning 45 alarm 55 5min alarm 65 15min
alarm 75
(config)#end

#show system-information cpu-load

System CPU-Load Information
=====

Uptime                : 64 Days 17 Hours 56 Minutes 22 Seconds

Load Average(1 min)   : 5.74% (Crit Thresh : 45%, Alert Thresh : 55%)
Load Average(5 min)   : 3.71% (Crit Thresh : N/A, Alert Thresh : 65%)
Load Average(15 min)  : 3.21% (Crit Thresh : N/A, Alert Thresh : 75%)

Avg CPU Usage         : 4.67%
```

---

```
CPU core 1 Usage      : 4.42% (Crit Thresh : 50%, Alert Thresh : 90%)
CPU core 2 Usage      : 2.68% (Crit Thresh : 50%, Alert Thresh : 90%)
CPU core 3 Usage      : 6.19% (Crit Thresh : 50%, Alert Thresh : 90%)
CPU core 4 Usage      : 5.36% (Crit Thresh : 50%, Alert Thresh : 90%)
```

```
#con t
```

```
Enter configuration commands, one per line.  End with CNTL/Z.
```

```
(config)#no system-load-average
```

```
(config)#end
```

```
#show system-information cpu-load
```

```
System CPU-Load Information
```

```
=====
```

```
Uptime                : 64 Days 18 Hours 16 Minutes 34 Seconds
```

```
Load Average(1 min)   : 0.63% (Crit Thresh : 40%, Alert Thresh : 50%)
```

```
Load Average(5 min)   : 1.90% (Crit Thresh : N/A, Alert Thresh : 50%)
```

```
Load Average(15 min)  : 3.11% (Crit Thresh : N/A, Alert Thresh : 50%)
```

```
Avg CPU Usage         : 2.07%
```

```
CPU core 1 Usage      : 1.83% (Crit Thresh : 50%, Alert Thresh : 90%)
```

```
CPU core 2 Usage      : 0.00% (Crit Thresh : 50%, Alert Thresh : 90%)
```

```
CPU core 3 Usage      : 6.36% (Crit Thresh : 50%, Alert Thresh : 90%)
```

```
CPU core 4 Usage      : 0.93% (Crit Thresh : 50%, Alert Thresh : 90%)
```





## CHAPTER 28 Digital Diagnostic Monitoring Commands

---

This chapter is a reference for Digital Diagnostic Monitoring (DDM) commands:

- [clear ddm transceiver alarm](#)
- [clear ddm transceiver alarm all](#)
- [ddm monitor](#)
- [ddm monitor all](#)
- [ddm monitor interval](#)
- [debug ddm](#)
- [service unsupported-transceiver](#)
- [show controller details](#)
- [show interface frequency grid](#)
- [show interface transceiver details](#)
- [show supported-transceiver](#)
- [tx-disable](#)
- [wavelength](#)

---

## clear ddm transceiver alarm

Use this command to clear the transceiver alarm in the DDM monitor interface.

### Command Syntax

```
clear ddm transceiver alarm
```

### Default

None

### Command Mode

Interface mode

### Applicability

This command was introduced before OcNOS version 1.3.

### Example

```
#configure terminal
(config)#interface xe1
(config-if)#clear ddm transceiver alarm
(config-if)#exit
```

---

## clear ddm transceiver alarm all

Use this command to clear the transceiver DDM alarm for all interface.

### Command Syntax

```
clear ddm transceiver alarm all
```

### Parameters

None

### Default

None

### Command Mode

Exec mode

### Applicability

This command was introduced before OcNOS version 1.3.

### Example

```
# clear ddm transceiver alarm all
```

---

## ddm monitor

Use this command to enable or disable DDM monitoring for interfaces which have a supported transceiver.

Use the `no` form of this command to remove DDM monitoring for all transceivers.

### Command Syntax

```
ddm monitor (disable|enable)
no ddm monitor
```

### Parameters

<code>enable</code>	Enable DDM monitoring.
<code>disable</code>	Disable DDM monitoring.

### Default

By default, DDM monitoring is disabled.

### Command Mode

Interface mode

### Applicability

This command was introduced before OcnOS version 1.3.

### Example

```
#configure terminal
(config)#interface xe1
(config-if)#ddm monitor enable
(config-if)#ddm monitor disable
(config-if)#exit

(config)#interface xe1
(config-if)#no ddm monitor
(config-if)#exit
```

---

## ddm monitor all

Use this command to enable DDM monitoring for all transceiver.s

Use the `no` form of this command to disable DDM monitoring for all transceivers.

### Command Syntax

```
ddm monitor all
no ddm monitor all
```

### Parameters

None

### Default

By default, DDM monitoring is disabled.

### Command Mode

Configuration mode

### Applicability

This command was introduced before OcNOS version 1.3.

### Example

```
#configure terminal
(config)#ddm monitor all

(config)#no ddm monitor all
```

---

## ddm monitor interval

Use this command to set the monitoring interval for the transceiver.

Use no form with this command to set the monitoring interval to its default.

### Command Syntax

```
ddm monitor interval <60-3600>
no ddm monitor interval
```

### Parameters

<60-3600> Interval period in seconds.

### Default

The default monitoring interval is 60 seconds.

### Command Mode

Configuration mode

### Applicability

This command was introduced before OcNOS version 1.3.

### Example

```
#configure terminal
(config)#ddm monitor interval 60
```

## debug ddm

Use this command to enable or disable debugging for DDM.

### Command Syntax

```
debug ddm
no debug ddm
```

### Parameters

None

### Default

By default, debug command is not configured.

### Command Mode

Configuration mode

### Applicability

This command was introduced before OcNOS version 1.3.

### Example

```
#configure terminal
(config)#debug ddm
(config)#no debug ddm
```

---

## service unsupported-transceiver

Use this command to allow an unsupported transceiver to be enabled for DDM monitoring.

Use the `no` form of this command to disable DDM on an unsupported transceiver.

### Command Syntax

```
service unsupported-transceiver
no service unsupported-transceiver
```

### Parameters

None

### Default

By default, DDM on an unsupported transceiver is disabled.

### Command Mode

Configuration mode

### Applicability

This command was introduced before OcNOS version 1.3.

### Example

```
#configure terminal
(config)#service unsupported-transceiver

(config)#no service unsupported-transceiver
```



---

## show controller details

Use this command to display the EEPROM details of transceivers.

### Command Syntax

```
show interface (IFNAME|) controllers
```

### Parameters

**IFNAME** Interface name. If not specified, this command displays details of all connected transceivers.

### Default

None

### Command Mode

Exec mode

### Applicability

This command was introduced before OcNOS version 1.3.

### Example

```
#show interface xe52/1 controllers
Port Number           : 52
Vendor oui            : 0x0 0x17 0x6a
Vendor name           : AVAGO
Vendor part_no        : AFBR-79E4Z
serial_number         : QB380161
transceiver_type      : QSFP OR LATER
connector_type        : MPO 1x12
qsfp_transceiver_code : 1X-LX
vendor_rev            : 01
date_code             : 110920      (yyymmddvv, v=vendor specific)
encoding              : SONET
br_nominal            : 103         (100 MHz)
length_km             : 0
length_mtr            : 50
length_50mt          : 0
length_62_5mt        : 0
length_cu             : 0
cc_base               : 0x7d
cc_ext                : 0x28
DDM Support          : yes
```

---

## show interface frequency grid

Use this command to display channel-number and wavelength mapping.

### Command Syntax

```
show interface (IFNAME) frequency-grid
```

### Parameters

IFNAME                    Interface name.

### Default

None

### Command Mode

Exec mode

### Applicability

This command was introduced in OcNOS version 4.1.

### Example

```
#show interface xe7 frequency-grid
-----
Channel Number  Frequency (THz)  Wavelength (nm)
-----
1               191.40           1566.314
2               191.50           1565.496
3               191.60           1564.679
4               191.70           1563.862
5               191.80           1563.047
6               191.90           1562.233
7               192.00           1561.419
8               192.10           1560.606
9               192.20           1559.794
10              192.30           1558.983
11              192.40           1558.172
12              192.50           1557.363
13              192.60           1556.554
14              192.70           1555.746
15              192.80           1554.939
16              192.90           1554.133
17              193.00           1553.328
18              193.10           1552.524
19              193.20           1551.720
20              193.30           1550.917
21              193.40           1550.115
22              193.50           1549.314
23              193.60           1548.514
24              193.70           1547.714
25              193.80           1546.916*
26              193.90           1546.118
27              194.00           1545.321
```

28	194.10	1544.525
29	194.20	1543.729
30	194.30	1542.934
31	194.40	1542.141
32	194.50	1541.348
33	194.60	1540.556
34	194.70	1539.765
35	194.80	1538.974
36	194.90	1538.184
37	195.00	1537.396
38	195.10	1536.607
39	195.20	1535.820
40	195.30	1535.034
41	195.40	1534.248
42	195.50	1533.463
43	195.60	1532.679
44	195.70	1531.896
45	195.80	1531.114
46	195.90	1530.332
47	196.00	1529.551
48	196.10	1528.771
#		

## show interface transceiver details

Use this command to display details of transceivers and threshold violations.

### Command Syntax

```
show interface (IFNAME|) transceiver (detail|threshold violation|)
```

### Parameters

- IFNAME                    Interface name. If not specified, this command displays details of all connected transceivers.
- detail                    Transceiver information such as voltage, temperature, power, and current.
- threshold violation      Transceiver threshold violations.
- Codes                    \* Not Qualified By IP Infusion, \*\* Not Supported By Module.

### Default

None

### Command Mode

Exec mode

### Applicability

This command was introduced before OcNOS version 1.3.

### Example

```
OcNOS#sh int transceiver detail
Codes: * Not Qualified By IP Infusion, ** Not Supported By Module, -- No
Power, - Not Applicable
```

Intf	DDM	Temp (Celsius)	AlertMax (Celsius)	CritMax (Celsius)	CritMin (Celsius)	AlertMin (Celsius)
ce0	Active*	+22.52	+85.00	+80.00	-5.00	-10.00
ce2	Active	+20.32	+75.00	+70.00	+0.00	-5.00
xe4	Active*	+23.62	+95.00	+85.00	-40.00	-50.00
xe5	Active*	+19.79	+100.00	+95.00	-35.00	-40.00
xe16	Active*	+25.84	+95.00	+85.00	-10.00	-50.00
xe26	Active	+19.01	+95.00	+90.00	-20.00	-25.00

Intf	DDM	Volt (Volts)	AlertMax (Volts)	CritMax (Volts)	CritMin (Volts)	AlertMin (Volts)
ce0	Active*	+3.314	+3.600	+3.500	+3.100	+2.900

ce2	Active	+3.260	+3.630	+3.465	+3.135	+2.970
xe4	Active*	+3.260	+3.600	+3.500	+3.100	+3.000
xe5	Active*	+3.253	+3.600	+3.500	+2.900	+2.800
xe16	Active*	+3.284	+3.630	+3.500	+3.030	+2.930
xe26	Active	+3.289	+3.900	+3.700	+2.900	+2.700

Intf AlertMin (mA)	DDM	Lane	Curr (mA)	AlertMax (mA)	CritMax (mA)	CritMin (mA)
--------------------------	-----	------	--------------	------------------	-----------------	-----------------

ce0 +0.000 +0.000 +0.000	Active*	1	+6.114	+15.000	+12.000	+2.000
		2	+6.120	+15.000	+12.000	+2.000
		3	+6.110	+15.000	+12.000	+2.000
		4	+6.116	+15.000	+12.000	+2.000
ce2 +3.000 +3.000 +3.000	Active	1	+7.464	+13.000	+11.000	+5.000
		2	+7.540	+13.000	+11.000	+5.000
		3	+7.444	+13.000	+11.000	+5.000
		4	+7.474	+13.000	+11.000	+5.000
xe4 +1.000	Active*	-	+6.100	+110.000	+100.000	+1.000
xe5 +1.000	Active*	-	+7.552	+15.000	+13.000	+2.000
xe16 +2.000	Active*	-	+5.800	+15.000	+12.000	+3.000
xe26 +1.000	Active	-	+7.050	+17.000	+14.000	+2.000

Intf AlertMin (dBm)	DDM	Lane	RxPwr (dBm)	AlertMax (dBm)	CritMax (dBm)	CritMin (dBm)
---------------------------	-----	------	----------------	-------------------	------------------	------------------

ce0 14.306 14.306 14.306	Active*	1	-0.185	+4.400	+3.400	-13.298	-
		2	+0.342	+4.400	+3.400	-13.298	-
		3	+0.396	+4.400	+3.400	-13.298	-
		4	-2.927	+4.400	+3.400	-13.298	-
ce2 14.001 14.001	Active	1	+1.302	+3.400	+2.400	-11.002	-
		2	+1.486	+3.400	+2.400	-11.002	-

Digital Diagnostic Monitoring Commands

14.001		3	+1.581	+3.400	+2.400	-11.002	-
14.001		4	+1.594	+3.400	+2.400	-11.002	-
xe4	Active*	-	-1.890	+2.500	+0.500	-14.401	-
16.402							
xe5	Active*	-	-40.000	+3.000	+0.000	-13.002	-
16.003							
xe16	Active*	-	--	+2.000	+1.000	-14.401	-
16.402							
xe26	Active	-	-5.933	+1.000	-1.002	-18.013	-
20.000							

Intf	DDM	Lane	TxPwr	AlertMax	CritMax	CritMin	
AlertMin			(dBm)	(dBm)	(dBm)	(dBm)	
(dBm)							

ce0	Active*	1	-0.085	+4.400	+3.400	-9.201	-
10.205		2	-0.161	+4.400	+3.400	-9.201	-
10.205		3	+0.217	+4.400	+3.400	-9.201	-
10.205		4	+0.204	+4.400	+3.400	-9.201	-
10.205							
ce2	Active	1	+0.297	+5.000	+3.000	-8.000	-
10.000		2	-0.078	+5.000	+3.000	-8.000	-
10.000		3	+0.131	+5.000	+3.000	-8.000	-
10.000		4	+0.323	+5.000	+3.000	-8.000	-
10.000							
xe4	Active*	-	-1.316	+2.500	+0.500	-8.199	-
10.200							
xe5	Active*	-	-2.299	+1.000	+0.000	-7.001	-
8.000							
xe16	Active*	-	-1.000	+2.500	+2.000	-8.199	-
10.200							
xe26	Active	-	-4.441	-2.000	-2.000	-11.024	-
11.739							

Intf	DDM	Lane	Freq-Err	AlertMax	CritMax	CritMin	
AlertMin			(GHz)	(GHz)	(GHz)	(GHz)	
(GHz)							

Intf	DDM	Lane	Wave-Err	AlertMax	CritMax	CritMin	
AlertMin			(nm)	(nm)	(nm)	(nm)	
(nm)							

Intf	DDM	Lane	Tx	Rx-LOS	Tx-LOS		
------	-----	------	----	--------	--------	--	--

ce0	Active*	1	On	Off	Off
		2	On	Off	Off
		3	On	Off	Off
		4	On	Off	Off
ce2	Active	1	On	Off	Off
		2	On	Off	Off
		3	On	Off	Off
		4	On	Off	Off
xe4	Active*	-	On	Off	-
xe5	Active*	-	On	On	-
xe9	Inactive*	-	On	On	-
xe11	Inactive*	-	On	On	-
xe13	Inactive*	-	On	On	-
xe14	Inactive*	-	On	On	-
xe16	Active*	-	On	On	-
xe26	Active	-	On	Off	-

Table 28-85 explains the output fields.

**Table 28-85: show interface transceiver details output**

Field	Description
Port	The number of the transceiver port.
Temp	Temperature in degrees Celsius of the transceiver.
Voltage	Voltage in Volts on the transceiver.
Current	Current in Milliampere used by the transceiver.
Rx Power	Power received in Decibel-milliwatts (dBm) by the transceiver.
Tx Power	Power being transmitted in milliWatts by the transceiver.
High Alarm	The level that is needed to be reached to trigger a high alarm.
High Warn	The level that is needed to be reached to trigger a high warning.
Low Warn	The level that is needed to be reached to trigger a low warning.
Low Alarm	The level that is needed to be reached to trigger a low alarm.
Codes *	Not Qualified By IP Infusion, ** Not Supported By Module

---

## show supported-transceiver

Use this command to display supported transceivers.

### Command Syntax

```
show supported-transceiver
```

### Parameters

None

### Default

None

### Command Mode

Exec mode

### Applicability

This command was introduced before OcNOS version 1.3.

### Example

```
#show supported-transceiver
-----
                Transceiver DDM support list
-----
Type                :SFP
Vendor Name         :FINISAR CORP
Vendor Part Number  :FTLF8519P2BNL
DDM Supported       :Yes

Type                :SFP
Vendor Name         :EVERTZ
Vendor Part Number  :SFP10G-TR13S
DDM Supported       :Yes

Type                :QSFP
Vendor Name         :AVAGO
Vendor Part Number  :AFBR-79E4Z
DDM Supported       :Yes
```



## tx-disable

Use this command to disable the transceiver tx-power (disable laser).

Use the `no` form of this command to enable tx-power (enable laser).

### Command Syntax

```
tx-disable
no tx-disable
```

### Default

By default, `tx-disable` is false.

### Command Mode

Interface mode

### Applicability

This command was introduced before OcnOS version 4.2.

### Example

```
#configure terminal
(config)#interface xe1
(config-if)#tx-disable
(config-if)#exit

(config)#interface xe1
(config-if)#no tx-disable
(config-if)#exit
```

---

## wavelength

Use this command to set the transceiver wavelength using the channel-number or the wavelength for interfaces having a supported transceiver.

Use the no form of this command to remove the wavelength configuration.

### Command Syntax

```
wavelength ((channel-number <1-96>) | (update <1528773-1566723>))
```

### Parameters

channel-number	Sets wavelength corresponding to the channel number
update	Sets wavelength value

### Default

By default, the interface comes up with a random wavelength chosen by autotuning.

### Command Mode

Interface mode

### Applicability

This command was introduced in OcNOS version 4.1.

### Example

```
(config)#int xe7
(config-if)#wavelength channel-number 10
(config-if)#no wavelength
(config-if)#

(config-if)#wavelength update 1528773
(config-if)#no wavelength
(config-if)#
```

## CHAPTER 29 sFlow Commands

---

This chapter describes the Sampled Flow (sFlow) commands.

- [clear sflow statistics](#)
- [debug sflow](#)
- [feature sflow](#)
- [sflow agent-ip](#)
- [sflow collector](#)
- [sflow enable](#)
- [sflow poll-interval](#)
- [sflow rate-limit](#)
- [sflow sampling-rate](#)
- [show sflow](#)
- [show sflow interface](#)
- [show sflow statistics](#)

---

## clear sflow statistics

Use this command to clear sFlow sampling-related counters such as the number of packets sampled and the number of counters sampled.

### Command Syntax

```
clear sflow statistics (interface IFNAME|)
```

### Parameters

IFNAME	Interface name
--------	----------------

### Default

None

### Command Mode

Exec mode

### Applicability

This command was introduced before OcNOS version 1.3.

### Example

```
#clear sflow statistics
```

## debug sflow

Use this command to display sFlow debugging messages.

### Command Syntax

```
debug sflow (all|agent|sampling|polling|)
```

### Parameters

all	Debug all (agent,sampling,polling)
agent	Debug sFlow agent
sampling	Debug sFlow sampling
polling	Debug sFlow polling

### Default

By default, debug command is disabled.

### Command Mode

Exec mode and Configure mode

### Applicability

This command was introduced before OcnOS version 1.3.

### Example

```
#debug sflow all
#debug sflow agent

#configure terminal
(config)#debug sflow agent
```

---

## feature sflow

Use this command to enable the sFlow feature.

Use the no form to disable the sFlow feature.

### Command Syntax

```
feature sflow
no feature sflow
```

### Parameters

None

### Default

By default, sFlow feature is disabled.

### Command Mode

Configure mode

### Applicability

This command was introduced before OcNOS version 1.3.

### Example

```
(config)#feature sflow
```

## sflow agent-ip

Use this command to set the agent IP address for receivers.

Use the `no` form of this or remove an agent IP address.

### Command Syntax

```
sflow agent-ip A.B.C.D  
no sflow agent-ip
```

### Parameter

A.B.C.D            IPv4 address

### Default

The default IP address is zero (0).

### Command Mode

Configure mode

### Applicability

This command was introduced before OcnOS version 1.3.

### Example

```
#configure terminal  
(config)#sflow agent-ip 10.0.0.12
```

---

## sflow collector

Use this command to configure the collector details such as the collector IPv4 address, port number, receiver time-out and datagram size.

Use the `no` form of this command to disable the sFlow collector.

### Command Syntax

```
sflow collector A.B.C.D port <1024-65535> receiver-time-out <0-2147483647>
max-datagram-size <200-9000>
no sflow collector (A.B.C.D port <1024-65535>|)
```

### Parameter

A.B.C.D	Collector IPv4 address. This address must be reachable via the management VRF.
<1024-65535>	Collector UDP Port number. The standard sFlow UDP port: 6343
<0-2147483647>	Receiver time out value in seconds. Zero means no timeout. Upon timeout, value collector information is removed, stopping any ongoing sampling.
<200-9000>	Maximum datagram size in bytes that can be sent to the collector

### Default

By default, the sFlow collector is disabled. The default port number is 6343.

### Command Mode

Configure mode

### Applicability

This command was introduced before OcnOS version 1.3.

### Example

```
#configure terminal
(config)#sflow collector 2.2.2.2 port 1111 receiver time-out 30 max-datagram-
size 500

(config)#no sflow collector
```



---

## sflow enable

Use this command to enable or disable sampling on an interface after giving the [sflow sampling-rate](#) command on the same interface.

### Command Syntax

```
sflow enable
no sflow enable
```

### Default

By default, sFlow sampling is disabled.

### Parameters

None

### Command Mode

Interface mode

### Applicability

This command was introduced before OcNOS version 1.3.

### Example

```
(config)#interface xe1
(config-if)#sflow sampling-rate 1024 direction ingress max-datagram-size 200
(config-if)#sflow enable
(config-if)#no sflow enable
```

---

## **sflow poll-interval**

Use this command to configure the sFlow counter polling interval. Any change in the polling interval restarts ongoing polling of existing data source interfaces, if any.

Use the `no` form of this command to disable the sFlow counter polling interval.

### **Command Syntax**

```
sflow poll-interval <5-60>
no sflow poll-interval
```

### **Parameters**

<5-60>                    Interface counter. Polling interval in seconds

### **Default**

By default, sFlow counter polling interval is disabled.

### **Command Mode**

Interface mode

### **Applicability**

This command was introduced before OcnOS version 1.3.

### **Examples**

```
#configure terminal
(config)#interface xe1
(config-if)#sflow poll-interval 25
(config-if)#no sflow poll-interval
```

## **sflow rate-limit**

Use this command to set the CPU rate limit in packets per second.

Use the `no` form of this command to set the CPU rate limit to its default (0).

### **Command Syntax**

```
sflow rate-limit <2000-100000>  
no sflow rate-limit
```

### **Parameters**

<2000-100000> Rate limit in packets per second

### **Default**

The default rate limit is zero (0).

### **Command Mode**

Configure mode

### **Applicability**

This command was introduced before OcnOS version 1.3.

This command is not available on Qumran platforms.

### **Examples**

```
#configure terminal  
(config)#sflow rate-limit 5000
```

## sflow sampling-rate

Use this command to set the sampling rate on an interface. Any change in the sampling rate restarts the ongoing sampling of existing data-source interfaces, if any.

Use the `no` form of this command to disable the sFlow sampling rate.

Note: Packets to CPU is rate limited. In case of unknown unicast, rate limit is applied to such packets as well as sampled data packets.

### Command Syntax

```
sflow sampling-rate <1024-16777215> direction (ingress | egress) max-header-size
<128-256>
no sflow sampling-rate direction (ingress | egress)
```

### Parameters

<1024-16777215>	Sampling rate
direction	The direction of sampling an interface:
ingress	Ingress traffic
egress	Egress traffic
<128-256>	Maximum header size in bytes

### Default

By default, sFlow sampling rate is disabled.

### Command Mode

Interface mode

### Applicability

This command was introduced before OcNOS version 1.3.

### Examples

```
#configure terminal
(config)#interface xe1
(config-if)#sflow sampling-rate 1024 direction ingress max-header-size 200
(config-if)#no sflow sampling-rate direction ingress
```

---

## show sflow

Use this command to display sFlow agent configuration along with statistics for all interfaces.

### Command Syntax

```
show sflow (brief | detail)
```

### Parameters

brief	Display configuration parameters on interfaces along with sampling rate and poll interval.
detail	Same as <code>brief</code> along with configured and default attributes and values of sFlow agent, sFlow collector, and sampling information.

### Default

None

### Command Mode

Exec mode

### Applicability

This command was introduced before OcNOS version 1.3.

### Example

```
#show sflow
sFlow Feature: Enabled
sFlow Version: 5
sFlow Global Information :
Agent      IP: 10.12.16.38
Collector IP: 2.2.2.2      Port: 6343
Maximum Datagram Size(bytes): 200
Receiver timeout(sec)      : 0

sFlow Port Detailed Information:
Interface  Packet-Sampling      Packet-Sampling      Counter-Polling      Maximum Header
           Rate         Count                 Interval             Count               Size(bytes)
           Ingress    Egress              Ingress              Egress              Ingress    Egress
-----
xe1         1024             0                   0                   0                   6           3           128             0

#
#show sflow brief
sFlow Feature: Enabled
Collector IP: 2.2.2.2      Port: 6343
Maximum Datagram Size(bytes): 200
Receiver timeout(sec)      : 0

sFlow Port Configuration:
Interface  Status              Sample Rate          Counter-Polling
           Ingress    Egress              Ingress              Egress              Interval(sec)
-----
xe1         Enabled    Disabled           1024                 0                   6
```

**Table 29-86: Show sflow output**

Entry	Description
sFlow feature	Shows whether sFlow is enabled or disabled.
sFlow Version	Displays the sFlow version. Version 5 is the current global standard.
sFlow Global Information	Global Information consists of the Agent IP address, Collector IP, Port number, Maximum Datagram Size, and the Receiver timeout.
Agent IP	IPv4 address of this switch/router.
Collector IP	IPv4 address of the sFlow collector server.
Port	Port number on the sFlow collector server. Standard is port 6343.
Maximum Datagram Size	The maximum size of the datagrams sent by the agent
Receiver timeout	The number of seconds between each sampling – zero means sample continuously.
sFlow Port Interface	The interface of this switch/router on which sFlow is running (e.g. xe1/1).
Packet-Sampling Rate	the number of packets received or transmitted before a sample is taken.
Packet-Sampling Count	The number of sample packets that have been sampled on both the ingress and egress of the interface.
Counter-Polling	Shows the amount of time between polling samples and the count of the total number of polling samples taken.
Maximum Header Size	The maximum header size for both the ingress and egress of the interface.

---

## show sflow interface

Use this command to display the sFlow configuration for the input interface.

### Command Syntax

```
show sflow interface IFNAME
```

### Parameters

IFNAME	Interface name
--------	----------------

### Default

None

### Command Mode

Exec mode

### Applicability

This command was introduced before OcNOS version 1.3.

### Example

Note: For information on the output values of this command, see the [show sflow](#) command.

```
#show sflow interface xe1
sFlow feature: Enabled
sFlow Version: 5
sFlow Global Information :
Agent      IP: 10.10.26.104
Collector IP: 2.2.2.2      Port: 6343
Maximum Datagram Size(bytes): 200
Receiver timeout(sec)      : 0

sFlow Port Detailed Information:
Interface  Packet-Sampling      Counter-Polling      Maximum Header
           Rate         Count                Interval(sec) Count    Size(bytes)
-----
xe1                1024                 0                    6          41      128
```

---

## show sflow statistics

Use this command to display sFlow counter information.

### Command Syntax

```
show sflow statistics (interface IFNAME|)
```

### Parameters

IFNAME                    Interface name.

### Default

None

### Command Mode

Exec mode

### Applicability

This command was introduced before OcNOS version 1.3.

### Example

Note: For information on the output values of this command, see the [show sflow](#) command.

```
#show sflow statistics
```

```
sFlow Port Statistics:
Interface  Packet-Sampling  Counter-Polling
           Count          Count
-----
xe1                0                19
```



## CHAPTER 30 Trigger Failover Commands

---

This chapter describes the trigger failover (TFO) commands.

- `clear tfo counter`
- `fog`
- `fog tfo`
- `fog type`
- `link-type`
- `show tfo`
- `tfo`

---

## clear tfo counter

Use this command to clear the TFO counters. If you do not specify a parameter, this command clears counters for all FOG indexes.

### Command Syntax

```
clear tfo counter
clear tfo counter fog <1-64>
```

### Parameters

<1-64>                    Clear counters for this Failover Group Index

### Default

None

### Command Mode

Exec mode

### Applicability

This command was introduced before OcnOS version 1.3.

### Example

```
#clear tfo counter
```

---

## fog

Use this command to:

- Create or delete a failover group (FOG)
- Enable or disable an existing FOG

Even if FOG index does not exist, FOG can be created as enabled with “enable” option in CLI.

If the FOG index already exists:

- When the FOG status is disabled and Control Port Group (CPG) links are previously disabled (because of TFO), then the links are enabled. If a particular CPG member belongs to multiple CPGs, then this CPG member is enabled only if all corresponding Monitor Port Groups (MPG) are enabled.
- When the FOG status is enabled and MPG is down, then the corresponding CPG links are disabled.

Use the `no` form of this command to delete a FOG.

### Command Syntax

```
fog <1-64> (enable|disable)
no fog <1-64>
```

### Parameters

<1-64>	Failover Group Index
enable	Enable Failover Group
disable	Disable Failover Group

### Default

None

### Command Mode

Configure mode

### Applicability

This command was introduced before OcNOS version 1.3.

### Example

```
#configure terminal
(config)#fog 5 enable
```

---

## fog tfc

Use this command to set the number of links to trigger failover for a Monitor Port Groups (MPG).

Use the no form of this command to remove the configuration and use default value of 0.

### Command Syntax

```
fog <1-64> tfc <0-63>
```

```
no fog <1-64> tfc
```

### Parameters

<1-64>                      Failover Group index

<0-63>                      Trigger failover count

### Default

None

### Command Mode

Configure mode

### Applicability

This command was introduced before OcNOS version 1.3. The no version of the command was introduced in OcNOS version 4.0.

### Example

```
#configure terminal
(config)#fog 5 tfc 7
(config)# no fog 5 tfc
```

## fog type

Use this command to map upstream/downstream links in a FOG as a Monitor Port Group (MPG) or Control Port Group (CPG).

Use the `no` form of this command to unmap upstream/downstream links.

### Command Syntax

```
fog <1-64> type (mpg|cpg)
no fog <1-64> type (mpg|cpg)
```

### Parameters

<1-64>	Failover Group Index
mpg	Map the interface to an MPG
cpg	Map the interface to a CPG

### Default

None

### Command Mode

Interface mode

### Applicability

This command was introduced before OcnOS version 1.3.

### Example

```
#configure terminal
#interface eth1
(config-if)#fog 5 type mpg
```

---

## link-type

Use this command to make a port an uplink or downlink.

Use the `no` form of this command to remove the configuration.

### Command Syntax

```
link-type (uplink|downlink)
no link-type
```

### Parameters

<code>uplink</code>	Make the port an uplink
<code>downlink</code>	Make the port a downlink

### Default

None

### Command Mode

Interface mode

### Applicability

This command was introduced before OcNOS version 1.3.

### Example

```
#configure terminal
#interface eth1
(config-if)#link-type downlink
```

---

## show tfo

Use this command to display FOG configuration and statistics.

### Command Syntax

```
show tfo
```

### Parameters

None

### Default

None

### Command Mode

Exec mode

### Applicability

This command was introduced before OcNOS version 1.3.

### Example

```
#show tfo

TFO : Enable

Failover Group 1 : Enable
Failover Status : MPG Link Failure
No. of links to trigger failover : 0
MPG Port(s) :
xe9   Status : DOWN
xe12  Status : DOWN
CPG Port :
xe4   Status : DOWN
No. of times MPG link failure : 1
No. of times MPG link recovered : 0
No. of times CPG got auto disabled : 1
No. of times CPG got auto enable : 0
```

[Table 30-87](#) Explains the show command output fields.

**Table 30-87: show tfo output fields**

Field	Description
Failover Group	Enable the failover group.
Failover Status	Display the failover status.
No. of links to trigger failover	Number of links to trigger the failover group.

## Trigger Failover Commands

---

<b>Field</b>	<b>Description</b>
MPG Port	Details of the monitor port group.
CPG Port	Details of the control port group.



## tfo

Use this command to enable or disable trigger failover (TFO).

### Command Syntax

```
tfo (enable|disable)
```

### Parameters

enable	Enables Trigger failover
disable	Disables Trigger failover

### Default

By default, TFO is disabled.

### Command Mode

Configure mode

### Applicability

This command was introduced before OcNOS version 1.3.

### Example

```
#configure terminal  
(config)#tfo enable
```



## CHAPTER 31 VLOG Commands

---

This chapter describes virtual router log (VLOG) commands.

- [show vlog all](#)
- [show vlog clients](#)
- [show vlog terminals](#)
- [show vlog virtual-routers](#)

## show vlog all

Use this command to display the output of all virtual router log `show` commands. For column descriptions, refer to descriptions of the individual commands.

### Command Syntax

```
show vlog all
```

### Parameters

None

### Default

None

### Command Mode

Exec mode and Privileged Exec mode

### Applicability

This command was introduced before OcNOS version 1.3.

### Example

```
>enable
#show vlog all
```

```
Type      Name      FD  UserVR  AllVrs  VRCnt
tty       /dev/pts/8  12  vr222   ---     1
tty       /dev/pts/4  13  <PVR>   ---     1
```

```
VR-Name  VR-Id  PVR-Terms  VR-Terms  LogFile
CurSize
<PVR>    0      1          0          /var/local/zebos/log/pvr/my-log
1624320
vr111    1      0          0          n/a
n/a
vr222    2      0          1          /var/local/zebos/log/vr222/log-
vr222    0
vr333    3      0          0          /var/local/zebos/log/vr333/log-
vr333    0
```

```
Name  Id  MsgCnt      ConTime      ReadTime
NSM   1   1  Fri May-15 21:05:04  Fri May-15 21:05:04
IMI   19  1  Fri May-15 21:05:02  Fri May-15 21:05:02
```

[Table 31-88](#) explains the output:

**Table 31-88: show vlog all details**

Name	Name of protocol module
Id	Protocol module identifier

**Table 31-88: show vlog all details**

MsgCnt	Number of log messages received from protocol module
ConTime	Time the connection was established
ReadTime	Time the last log message was received

Table 31-89 explains the output:

**Table 31-89: show vlog all details**

Type	Type of terminal
Name	Device name
FD	File descriptor
UserVR	Name of the Virtual Router where in which the user is logged in
AllVRs	Whether the PVR user requested debug output from all VRs
VRCnt	Number of VRs to which a terminal is attached

Table 31-90 explains the output:

**Table 31-90: show vlog all details**

VR-Name	Virtual router name
VR-Id	Virtual router identifier
PVR-Terms	Number of attached PVR terminals
VR-Terms	Number of attached VR terminals
LogFile	Name of VR log file (this column is empty if writing to a log file is disabled)
CurSize	Log file current size

---

## show vlog clients

Use this command to display all attached virtual router log clients (protocol modules).

### Command Syntax

```
show vlog clients
```

### Parameters

None

### Default

None

### Command Mode

Privileged Exec mode

### Applicability

This command was introduced before OcNOS version 1.3.

### Example

```
>enable
#show vlog clients
```

```
Name  Id  MsgCnt          ConTime          ReadTime
NSM   1   1      Fri May-15 21:05:04  Fri May-15 21:05:04
IMI   19  1      Fri May-15 21:05:02  Fri May-15 21:05:02
```

[Table 31-91](#) explains the output:

**Table 31-91: show vlog clients details**

Name	Name of protocol module
Id	Protocol module identifier
MsgCnt	Number of log messages received from protocol module
ConTime	Time the connection was established
ReadTime	Time the last log message was received

---

## show vlog terminals

Use this command to display all active connections where VLOGD is forwarding log output.

### Command Syntax

```
show vlog terminals
```

### Parameters

None

### Default

None

### Command Mode

Privileged exec mode

### Applicability

This command was introduced before OcNOS version 1.3.

### Example

```
>enable
#show vlog terminals

Type      Name      FD  UserVR  AllVrs  VRCnt
tty       /dev/pts/8  12  vr222   ---     1
tty       /dev/pts/4  13  <PVR>   ---     1
```

[Table 31-92](#) explains the output:

**Table 31-92: show virtual router log terminals details**

Type	Type of terminal
Name	Device name
FD	File descriptor
UserVR	Name of the Virtual Router where in which the user is logged in
AllVRs	Whether the PVR user requested debug output from all VRs
VRCnt	Number of VRs to which a terminal is attached

## show vlog virtual-routers

Use this command to display virtual router statistics such as the number of terminals attached.

### Command Syntax

```
show vlog virtual-routers
```

### Parameters

None

### Default

None

### Command Mode

Privileged exec mode

### Applicability

This command was introduced before OcNOS version 1.3.

### Example

```
>enable
#show vlog virtual-routers

VR-Name  VR-Id  PVR-Terms  VR-Terms  LogFile
CurSize
<PVR>    0  1          0          /var/local/zebos/log/pvr/my-log
1624320
vr111    1  0          0          n/a
vr222    2  0          1          /var/local/zebos/log/vr222/log-vr222  0
vr333    3  0          0          /var/local/zebos/log/vr333/log-vr333  0
```

[Table 31-93](#) explains the output:

**Table 31-93: show vlog virtual-routers details**

VR-Name	Virtual router name
VR-Id	Virtual router identifier
PVR-Terms	Number of attached PVR terminals
VR-Terms	Number of attached VR terminals
LogFile	Name of VR log file (this column is empty if writing to a log file is disabled)
CurSize	Log file current size



---

## CHAPTER 32 Syslog Commands

---

This chapter is a reference for the `syslog` commands.

Linux applications use the `syslog` utility to collect, identify, time-stamp, filter, store, alert, and forward logging data. The `syslog` utility can track and log all manner of system messages from informational to extremely critical. Each system message sent to a `syslog` server has two descriptive labels associated with it:

- The function (facility) of the application that generated it. For example, an application such as `mail` and `cron` generates messages with a facility names “mail” and “cron”.
- Eight degrees of severity (numbered 0-7) of the message which are explained in [Table 32-94](#).

This chapter contains these commands:

- [clear logging logfile](#)
- [feature rsyslog](#)
- [log syslog](#)
- [logging console](#)
- [logging level](#)
- [logging logfile](#)
- [logging monitor](#)
- [logging remote server](#)
- [logging timestamp](#)
- [show logging](#)
- [show logging last](#)
- [show logging logfile](#)
- [show logging logfile last-index](#)
- [show logging logfile start-seqn end-seqn](#)
- [show logging logfile start-time end-time](#)
- [show running-config logging](#)

## Syslog Severities

In the example log entries in [Table 32-94](#), the prefixes are removed. For example, this is a complete log entry with the prefix:

```
2020 Apr 12 11:20:27.612 : 17U-18U : PSERV : MERG : !!! hsl Module crashed, System
reboot halted as it rebooted continuously 2 times
```

This is the same log entry without the prefix:

```
hsl Module crashed, System reboot halted as it rebooted continuously 2 times
```

**Table 32-94: Syslog severities (Sheet 1 of 2)**

Severity Level	Keyword	Description
0	emergency	The whole system is unusable and needs operator intervention to recover. If only a particular port or component is unusable, but the system as a whole is still usable it is not categorized at an emergency level. Examples of this type of message: Output Power of PSU XX (psu_no) XX Watt] has exceeded Maximum Output Power Limit[XX Watt] OSPF Initialization failed.
1	alert	The operator needs to act immediately or the system might go into emergency state. The system or one of its component's functionality might be critically affected. Examples of this type of message: Temperature of sensor is (curr_temp)C. It is nearing Emergency Condition. OSPF has exceed lsdB limit OSPF Detected router with duplicate router ID [ID]
2	critical	A critical system event happened which requires the operator's attention. The event might not require immediate action, but this event can affect functionality or behavior of a system component. Examples of this type of message: OSPF Neighbor session went down. Interface %s changed state to down
3	error	An error event happened which does not require immediate attention. This log message provides details about error conditions in the system or its components which you can use to troubleshoot problems. These events are not logged directly even if the logging level is set to include this level. You also need to enable the protocol debug filters (such as <code>debug ospf all</code> ). Examples of this type of message: Device i2c bus open error.!!! [DECODE] Attr ASPATH: Invalid AS Path value. OSPF MD5 authentication error

Table 32-94: Syslog severities (Sheet 2 of 2)

Severity Level	Keyword	Description
4	notification	<p>Notifications about important system and protocol events to assure the operator that the system is running properly. If a critical/alert condition has happened and has been corrected, that is also logged at this level.</p> <p>Examples of this type of message:</p> <pre>OSPF Received link up for interface: xe1 OSPF neighbour [10.1.1.1] Status change Exstart -&gt; Exchange Interface %s changed state to UP</pre>
5	informational	<p>Detailed informational events happening across the system and protocol modules. These events are not necessarily important and are useful only to find details about the functionality being executed in the system and its components. Some of these events might be periodic events like hello or keep alive messages along with packet dumps. Also, this level includes logs for control packets that are ignored and do not impact the protocol states.</p> <p>IP Infusion Inc. recommends to use proper debug filters to log only relevant events and switch off other events; otherwise the logs can get verbose. For example:</p> <pre>debug ospf all no debug ospf packet hello</pre> <p>The above enables all OSPF debugging, but disables the periodic hello messages.</p> <p>Examples of this type of message:</p> <pre>Successfully added dynamic neighbour [DECODE] KAlive: Received! [FSM] Ignoring Unsupported event &lt;EVENT&gt; in state &lt;STATE&gt; Unknown ICMP packet type" OSPF RECV[%s]: From %r via %s: Version number mismatch OSPF RECV[%s]: From %r via %s: Network address mismatch</pre>
6	debug informational	<p>Developer notification events that might not be readable by an operator. However these logs are useful for debugging by a developer and if required, this level needs to be enabled and provided to technical support for analysis.</p>
7	debug detailed	<p>Developer notification events that might not be readable by an operator. However these logs are useful for debugging by a developer and if required, this level needs to be enabled and provided to technical support for analysis.</p>

---

## Log File Rotation

Log rotation is important to maintain the stability of the device, because the larger log files are difficult to manipulate and file system would run out of space. The solution to this common problem is log file rotation.

Log rotation is scheduled to happen for every 5 minutes, here the log file size is used as the condition to perform rotation.

Log rotate operation creates a backup of the current log file, and clears the current log file content. Also these rotated log files are compressed to save disk space. Excluding the current log file, four backup files are maintained in the system, and the older logs are removed as part of the rotation operation.

Default log file `/var/log/messages` rotated, if the size is greater than 100 MB. The following are the rotated log files generated in the path `/var/log`

## Syslog Commands

---

```
root@host:/var/log# ls messages*
messages  messages.1  messages.2.gz  messages.3.gz  messages.4.gz
```

Manually configured log file `/log/LOG1` gets rotated, if its size is greater than configured size. Here `LOG1` is the manually configured using the command `logging logfile <filename>` and the log file size in bytes can be configured using the command `logging logfile LOG1 <severity> size <4096-419430400>`

```
(config)#logging logfile LOG1 7 size 4096
```

Here configured logging file `/log/LOG1` is rotated if the size is greater than 4096 bytes. The following are the rotated log files generated in the path `/log`

```
root@host:/log# ls LOG*
LOG1  LOG1.1  LOG1.2.gz  LOG1.3.gz  LOG1.4.gz
```

---

## clear logging logfile

Use this command to clear the existing contents of the configured logging logfile.

Note: If the name of the configured logging log file is “mylogfile”, this command clears only the log file mylogfile. But the other rotated or compressed log files are untouched.

### Command Syntax

```
clear logging logfile
```

### Parameters

None

### Default

No default value is specified

### Command Mode

Executive mode

### Applicability

This command was introduced before OcNOS version 3.0.

### Example

```
#clear logging logfile
```

---

## feature rsyslog

Use this command to enable the rsyslog server.

Use the `no` form of this command to disable the rsyslog server.

### Command Syntax

```
feature rsyslog vrf (management|)
no feature rsyslog vrf (management|)
```

### Parameters

management      Virtual Routing and Forwarding name

### Default

No default value is specified

### Command Mode

Configure mode

### Applicability

This command was introduced before OcNOS version 1.3.

### Example

```
#configure terminal
(config)#feature rsyslog vrf management
```

---

## log syslog

Use this command to begin logging to the system log and set the level to debug.

Syslog enables centrally logging and analyzing of configuration events and system error messages. This helps monitor interface status, security alerts, and CPU process overloads. It also allows real-time capturing of client debug sessions. The command instructs the `VLOGD` daemon to forward all PVR debug output from all active `terminal monitor` sessions to the syslog file.

Use the `no` parameter to disable logging to the system log.

### Command Syntax

```
log syslog
no log syslog
```

### Parameters

None

### Default

No default value is specified

### Command Mode

Configure mode

### Applicability

This command was introduced before OcNOS version 1.3.

### Example

```
#configure terminal
(config)#log syslog
```

## logging console

Use this command to set the severity level that a message must reach before the messages is sent to the console. The severity levels are from 0 to 7 as shown in [Table 32-94](#).

Use the command `logging console disable` to disable logging console messages.

Use the `no` form of this command to remove logging console configuration and return to the default severity level.

Note: Below message will be displayed if console severity is set to 6 or 7:

% Warning : If debug volume is huge it can degrade system performance and makes console to be non-responsive

Note: For CMMD, Critical logs in the console are equivalent to Alert traps & Alert logs on the console is equivalent to critical trap in SNMP.

### Command Syntax

```
logging console (<0-7>|)
logging console disable
no logging console
```

### Parameters

<0-7> Maximum logging level for console messages as shown in [Table 32-94](#).

Note: Setting the level above 5 might affect performance and is not recommended in a production network.

disable Disables the logging console

### Default

If not specified, the default logging level is 2 (Critical).

### Command Mode

Configure mode

### Applicability

This command was introduced before OcnOS version 1.3 and the command `logging console disable` was introduced in the OcnOS version 5.1.

### Example

```
#configure terminal
(config)#logging console 6
(config)#commit
(config)#logging console disable
(config)#commit
```



---

## logging level

Use this command to set the severity level that a message for a specific process must reach before the messages is logged. The severity levels are from 0 to 7 as shown in [Table 32-94](#). Logging happens for the messages less than or equal to the configured severity level.

Use the `no` form of this command to disable logging messages.

Note: Default log level is 2 to report Emergency-0, Alert-1 and Critical-2 level events.

### Command Syntax

```
logging level (all|auth|bgp|dvmp|hostp|hsl|isis|l2mrib|lacp|lagd|ldp|mrib|
mstp|ndd|nsm|onm|oam|ospf|ospf6|pim|pon|pservd|ptp|rib|rip|ripng|rmon|rsvp|sflow
|vrrp) <0-7>

no logging level (all|auth|bgp|dvmp|hostp|hsl|isis|l2mrib|lacp|lagd|ldp|mrib|
mstp|ndd|nsm|oam|onm|ospf|ospf6|pim|pon|pservd|ptp|rib|rip|ripng|rmon|rsvp|sflow
|vrrp)
```

### Parameters

<code>all</code>	All messages
<code>auth</code>	Auth messages
<code>bgp</code>	BGP messages
<code>dvmp</code>	DVMRP messages
<code>hostp</code>	Hostp messages
<code>hsl</code>	HSL messages
<code>isis</code>	ISIS messages
<code>l2mrib</code>	L2MRIB messages
<code>lacp</code>	LACP messages
<code>lagd</code>	LAGD messages
<code>ldp</code>	LDP messages
<code>mrib</code>	MRIB messages
<code>mstp</code>	MSTP messages
<code>ndd</code>	NDD messages
<code>nsm</code>	NSM messages
<code>oam</code>	OAM messages
<code>onm</code>	ONM messages
<code>ospf</code>	OSPF messages
<code>ospf6</code>	OSPF6 messages
<code>pim</code>	PIM messages
<code>pon</code>	PON messages
<code>pservd</code>	PSERVD messages
<code>ptp</code>	PTP messages
<code>rib</code>	RIB messages

rip	RIP messages
ripng	RIPNG messages
rmon	RMON messages
rsvp	RSVP messages
sflow	Sflow messages
vrrp	VRRP messages
<0-7>	Severity level as shown in <a href="#">Table 32-94</a> .

### Default

By default, the logging level is 2 (critical).

### Command Mode

Configure mode

### Applicability

This command was introduced before OcNOS version 1.3.

### Examples

Note: From OcNOS version 4.2, the behavior of the option `all` for the logging level command has changed for the running-config. Now the command logging level `all` is displayed in the running-config with its respective level defined by the user instead of one command for each process. If the user have some logging level configured for some specific process in the system when the logging level `all` command is executed, the level of process that is already configured stays with the level and all other process are configured with the level defined by the `all` option. This change is necessary to support the option `all` for logging level in the Netconf also.

```
#configure terminal
(config)#logging level all 7
(config)#do show running-config logging
logging level ospf 3
logging level hostp 5
logging level all 7
feature rsyslog
(config)#
```

---

## logging logfile

Use this command to specify the log file controls and where to save the logs in a configuration file. This command enables writing debug output and command history to the disk file in the directory `/log/`.

When logging logfile is enabled, OcNOS log information is stored in user configured logging file which is present in `/log` directory. The log is spread across four files total of these files size is the user configured size.

For example, if the name of the logging log file is "mylogFile" and logging file size configured is 4 MB then each file will be maximum size of 1MB. The logging file names will be "mylogFile", "mylogfile.0", "mylogfile.1" and "mylogfile.2".

"mylogFile" will have the latest log information. As soon as it's size becomes 1 MB this file is renamed as mylogFile.0 and newlog information is written to new "mylogFile". As a result oldest log information stored in mylogfile.2 and is lost in order to accommodate new set of logs in mylogFile.

Use option `no` to cancel writing to a specific log file.

Note: Changing logfile parameters (name/size/severity) will be taken into effect for the next OcNOS session.

### Command Syntax

```
logging logfile LOGFILENAME <0-7> ((size <4096-419430400>)|)
no logging logfile
```

### Parameter

LOGFILENAME	Specify the snmp user name (Min 5 to Max 32 alphanumeric characters).
<0-7>	Severity level as shown in <a href="#">Table 32-94</a> .
<4096-419430400>	Log file size in bytes.

### Default

By default, log file size is 419430400 bytes.

### Command Mode

Configure mode

### Applicability

This command was introduced before OcNOS version 1.3.

### Examples

This command is used to log the debug messages of a particular protocol daemon to the specified file.

```
#configure terminal
(config)#logging logfile test123 7
```

---

## logging monitor

Use this command to set the severity level that a message must reach before a monitor message is logged. The severity levels are shown in [Table 32-94](#).

Use the command `logging monitor disable` to disable the logging monitor messages.

Use the `no` form of this command to remove logging monitor config and return to the default severity level.

### Command Syntax

```
logging monitor (<0-7>|)
logging monitor disable
no logging monitor
```

### Parameters

<0-7>                    Maximum logging level for monitor messages as shown in [Table 32-94](#).

Note: Setting the level above 5 might affect performance and is not recommended in a production network.

disable                 Disables logging monitor

### Default

If not specified, the default logging level is 7 (debug-details).

### Command Mode

Configure mode

### Applicability

This command was introduced before OcnOS version 1.3 and the command `logging monitor disable` was introduced in the OcnOS version 5.1.

### Example

```
#configure terminal
(config)#logging monitor 6
(config)#commit
(config)#logging monitor disable
(config)#commit
```

---

## logging remote facility

Use this command to set a syslog servers facility.

OcNOS supports logging messages to one or more remote syslog servers. but the same facility is used for all the servers.

Use the `no` form of this command to use the default facility value, which is `local7`.

Note: Only one facility is supported for all protocol modules across all the configured logging servers.

### Command Syntax

```
logging remote facility
    (local0|local1|local2|local3|local4|local5|local6|local7|user)
no logging remote facility
```

### Parameters

<code>facility</code>	Entity logging the message (user defined); if not specified, the default is <code>local7</code>
<code>local0</code>	Local0 entity
<code>local1</code>	Local1 entity
<code>local2</code>	Local2 entity
<code>local3</code>	Local3 entity
<code>local4</code>	Local4 entity
<code>local5</code>	Local5 entity
<code>local6</code>	Local6 entity
<code>local7</code>	Local7 entity (default)
<code>user</code>	User entity

### Default

If not specified, the default `facility` is `local7`.

### Command Mode

Configure mode

### Applicability

This command was introduced in OcNOS version 4.1.

### Examples

```
#configure terminal
(config)#logging remote facility local 6
(config)#no logging remote facility
```

---

## logging remote server

Use this command to set a syslog server.

OcNOS supports logging messages to a syslog server in addition to logging to a file or the console (local or SSH/telnet console). OcNOS messages can be logged to a local syslog server (the machine on which OcNOS executes) as well as to one or more remote syslog servers.

Use the `no` form of this command to remove a syslog server.

Note: Maximum 8 remote log servers can be configured.

### Command Syntax

```
logging remote server (A.B.C.D|X:X::X:X|HOSTNAME) ((0|1|2|3|4|5|6|7)|) (port <1024-65535>|) (vrf management|)
```

```
no logging remote server (A.B.C.D|X:X::X:X|HOSTNAME) ((0|1|2|3|4|5|6|7)|) (port|) (vrf management|)
```

### Parameters

A.B.C.D	IPv4 address
X:X::X:X	IPv6 address
HOSTNAME	Host name; specify <code>localhost</code> to log locally
0	Emergency
1	Alert
2	Critical
3	Error
4	Notification
5	Informational
6	Debug informational
7	Debug detailed
<1024-65535>	Port number Default port is 514
vrf management	Virtual Routing and Forwarding name

Note: Severity at which messages are logged as shown in [Table 32-94](#). If not specified, the default is 7.

### Default

If not specified, the default severity at which messages are logged is 7 (debug detailed).

### Command Mode

Configure mode

### Applicability

This command was introduced in OcNOS version 6.3.0.

### Examples

```
#configure terminal
```

```
(config)#logging remote server MyLogHost vrf management
(config)#no feature rsyslog vrf management
(config)# (config)#feature rsyslog
(config)#logging remote server 10.10.10.10 7
```

**Note:** In the latter configuration, the default VRF does not need not to be specified in the command.

---

## logging timestamp

Use this command to set the logging timestamp granularity.

Use the `no` form of this command to reset the logging timestamp granularity to its default (milliseconds).

**Note:** Any change in timestamp configurations will result in timestamp configured for event logged by protocol modules except for CLI history for the current and active sessions. The timestamp configuration is reflected in CLI history for new CLI sessions.

Changing logging timestamp will be taken into effect for the next OcNOS session.

### Command Syntax

```
logging timestamp (microseconds|milliseconds|seconds|none)
no logging timestamp
```

### Parameters

<code>microseconds</code>	Microseconds granularity
<code>milliseconds</code>	Milliseconds granularity
<code>seconds</code>	Seconds granularity
<code>none</code>	no timestamp in log message

### Default

By default, logging time stamp granularity is milliseconds.

### Command Mode

Configure mode

### Applicability

This command was introduced before OcNOS version 1.3.

### Examples

```
#configure terminal
(config)#logging timestamp milliseconds
```



---

## show logging

Use this command to display the logging configuration.

### Command Syntax

```
show logging (info|level|server|console|timestamp|monitor)
```

### Parameters

info	Show server logging configuration
level	Show facility logging configuration
server	Syslog server configuration
console	Console configuration
timestamp	Timestamp configuration
monitor	Monitor configuration

### Command Mode

Exec mode

### Applicability

This command was introduced before OcNOS version 1.3.

### Examples

```
#show logging console
```

```
Console logging      : enabled Severity: Operator (critical) Level : 2
```

```
#show logging monitor
```

```
Logging monitor     : enabled Severity: Operator (debugging) Level: 7
```

```
#show logging server
```

```
Remote Servers:
```

```
    1.1.1.1
    severity: Operator (informational)
    facility: local7
    VRF : management
```

```
#sh logging info
```

```
Remote Servers:
```

```
    1.1.1.1
    severity: Operator (informational)
    facility: local7
    VRF : management
```

```
Logging console     : enabled Severity: operator (critical) Level : 2
```

```
Logging monitor     : enabled Severity: Operator (debugging) Level : 7
```

```
Logging timestamp   : seconds
```

```
File logging        : enabled File Name   : /log/abc Severity   : Operator (de
```

## Syslog Commands

---

bugging) Level : 7 Size : 4194304  
Cli logging : enabled

Facility	Default Severity	Current Session Severity
nsm	2	2
ripd	2	2
ripngd	2	2
ospfd	2	2
ospf6d	2	2
isisd	2	2
hostpd	2	2
mribd	2	2
pimd	2	2
authd	2	2
mstpd	2	2
onmd	2	2
HSL	2	2
oamd	2	2
vlogd	2	2
vrrpd	2	2
ndd	2	2
ribd	2	2
bgpd	2	2
l2mribd	2	2
hslrasmgr	2	2
lagd	2	2
pservd	2	2
cmmd	2	2

---

## show logging last

Use this command to display lines from the end of the log file.

### Command Syntax

```
show logging last (<1-9999>)
```

### Parameters

<1-9999>            Number of lines to display from end of the log file

### Command Mode

Exec mode

### Applicability

This command was introduced before OcnOS version 1.3.

### Examples

```
#show logging last 100
2016 Mar 03 00:02:32 x86_64-debian NSM-3: AgentX: failed to send open message:
Connection refused
2016 Mar 03 00:02:33 x86_64-debian OSPF-3: AgentX: failed to send open message:
Connection refused
2016 Mar 03 00:02:33 x86_64-debian OSPFv3-3: AgentX: failed to send open message:
Connection refused
2016 Mar 03 00:02:33 x86_64-debian IS-IS-3: AgentX: failed to send open message:
Connection refused
2016 Mar 03 00:02:33 x86_64-debian BGP-3: AgentX: failed to send open message:
Connection refused
2016 Mar 03 00:02:33 x86_64-debian RIP-3: AgentX: failed to send open message:
Connection refused
```

---

## show logging logfile

Use this command to display whether logging is enabled, the log file name, and the logging severity.

### Command Syntax

```
show logging logfile
```

### Parameters

None

### Command Mode

Exec mode

### Applicability

This command was introduced before OcNOS version 1.3.

### Examples

```
#sh logging logfile
File logging      : enabled  File Name    : /log/abc  Severity   : (7)
2017 Sep 25 17:18:14 : OcNOS : CMLSH : CLI_HIST : User root@/dev/ttyS1 : CLI : '
logging server 1.1.1.1 5 vrf management '
```

```
2017 Sep 25 17:18:14 : OcNOS : CMLSH : CLI_HIST : User root@/dev/ttyS1 : CLI : '
ex'
```

```
2017 Sep 25 17:18:17 : OcNOS : CMLSH : CLI_HIST : User root@/dev/ttyS1 : CLI : '
sh logging info '
```

```
2017 Sep 25 17:19:15 : OcNOS : CMLSH : CLI_HIST : User root@/dev/ttyS1 : CLI : '
sh logging console '
```

```
2017 Sep 25 17:19:20 : OcNOS : CMLSH : CLI_HIST : User root@/dev/ttyS1 : CLI : '
sh logging monitor '
```

```
2017 Sep 25 17:19:32 : OcNOS : CMLSH : CLI_HIST : User root@/dev/ttyS1 : CLI : '
sh logging logfile '
```

```
2017 Sep 25 17:19:44 : OcNOS : CMLSH : CLI_HIST : User root@/dev/ttyS1 : CLI : '
sh logging server '
```

```
2017 Sep 25 17:28:26 : OcNOS : CMLSH : CLI_HIST : User root@/dev/ttyS1 : CLI : '
sh logging info '
```

```
2017 Sep 25 17:29:02 : OcNOS : CMLSH : CLI_HIST : User root@/dev/ttyS1 : CLI : '
sh logging console
```

---

## show logging logfile last-index

Use this command to display the number of line in the log file.

### Command Syntax

```
show logging logfile last-index
```

### Parameters

None

### Command Mode

Exec mode

### Applicability

This command was introduced before OcNOS version 1.3.

### Examples

```
#show logging logfile last-index  
logfile last-index : 10
```

[Table 32-95](#) explains the output fields.

**Table 32-95: show logging logfile last-index fields**

Entry	Description
logfile last-index	Number of line in the logfile.

---

## show logging logfile start-seqn end-seqn

Use this command to display a range of lines in the log file.

### Command Syntax

```
show logging logfile start-seqn (<0-2147483647>) (| (end-seqn <0-2147483647>))
```

### Parameters

start-seqn	Starting line number
end-seqn	Ending line number

### Command Mode

Exec mode

### Applicability

This command was introduced before OcNOS version 1.3.

### Examples

```
#show logging logfile start-seqn 2 end-seqn 7
2
3 2019 Jan 04 06:20:49.611 : NE4-router : CMLSH : CLI_HIST : User root@/dev/
ttyS0 : CLI : sh logging logfile
4
5 2019 Jan 04 06:21:08.512 : NE4-router : CMLSH : CLI_HIST : User root@/dev/
ttyS0 : CLI : show logging logfile last-index
6
7 2019 Jan 04 06:21:16.246 : NE4-router : CMLSH : CLI_HIST : User root@/dev/
ttyS0 : CLI : show logging logfile last-index
NE4-router#
```

[Table 32-96](#) explains the output fields.

**Table 32-96: show logging logfile start-seqn end-seqn fields**

Entry	Description
start-seqn	Starting line number
end-seqn	Ending line number

---

## show logging logfile start-time end-time

Use this command to display lines from the log file within a given date-time range.

### Command Syntax

```
show logging logfile start-time (<2000-2030> WORD <1-31> WORD) (|(end-time <2000-2030> WORD <1-31> WORD))
```

### Parameters

start-time	Starting date and time:
<2000-2030>	Year in YYYY format
WORD	Month as jan, feb, mar,..., oct, nov, or dec (maximum length 3 characters)
<1-31>	Day of month in DD format
WORD	Hour, minutes, seconds in HH:MM:SS format (maximum length 8 characters); range <0-23>:<0-59>:<0-59>
end-time	Ending date and time:
<2000-2030>	Year in YYYY format
WORD	Month as jan, feb, mar,..., oct, nov, or dec (maximum length 3 characters)
<1-31>	Day of month in DD format
WORD	Hour, minutes, seconds in HH:MM:SS format (maximum length 8 characters); range <0-23>:<0-59>:<0-59>

### Command Mode

Exec mode

### Applicability

This command was introduced before OcNOS version 1.3.

### Examples

```
#sh logging logfile start-time 2019 Jan 04 06:20:49 end-time 2019 Jan 04
06:21:16
2019 Jan 04 06:20:49.611 : NE4-router : CMLSH : CLI_HIST : User root@/dev/
ttyS0 : CLI : sh logging logfile

2019 Jan 04 06:21:08.512 : NE4-router : CMLSH : CLI_HIST : User root@/dev/
ttyS0 : CLI : show logging logfile last-index

2019 Jan 04 06:21:16.246 : NE4-router : CMLSH : CLI_HIST : User root@/dev/
ttyS0 : CLI : show logging logfile last-index
#
```

---

## show running-config logging

Use this command to display the logging configuration.

### Command Syntax

```
show running-config logging
```

### Parameters

None

### Command Mode

Exec mode and Configure mode

### Applicability

This command was introduced before OcNOS version 1.3.

### Examples

```
#show running-config logging
no Logging console
no Logging monitor
logging timestamp milliseconds
```



## CHAPTER 33 Linux Shell Commands

This chapter is a reference for Linux shell commands that you can run at the OcNOS prompt.

Table 33-97 describes the commands. Note the following:

- You must be in privileged exec mode to run these commands.
- You cannot use the pipe ("|") or redirect (">") operators.

**Table 33-97: Linux shell commands**

Command	Description
<code>cat file</code>	Display contents of <i>file</i>
<code>cd</code>	Change to home directory
<code>cd dir</code>	Change directory to <i>dir</i>
<code>cp file1 file2</code>	Copy <i>file1</i> to <i>file2</i>
<code>cp -r dir1 dir2</code>	Copy <i>dir1</i> to <i>dir2</i> ; create <i>dir2</i> if it does not exist
<code>dir</code>	Display contents of current directory
<code>less file</code>	Display the contents of <i>file</i>
<code>ls options</code>	Display contents of current directory
<code>mkdir dir</code>	Create a directory <i>dir</i>
<code>more file</code>	Display the contents of <i>file</i>
<code>mv file1 file2</code>	Rename <i>file1</i> to <i>file2</i>
<code>mv file dir</code>	Move <i>file</i> to directory <i>dir</i>
<code>pwd</code>	Display current directory
<code>rmdir dir</code>	Remove a directory <i>dir</i> (only if empty)



## CHAPTER 34 System Configure Mode Commands

---

This chapter provides a reference for the system configure mode commands.

- [delay-profile interfaces](#)
- [delay-profile interfaces subcommands](#)
- [forwarding profile](#)
- [hardware-profile filter](#)
- [hardware-profile flowcontrol](#)
- [hardware-profile service-queue](#)
- [hardware-profile statistics](#)
- [hardware-profile bgp-flowspec-mode](#)
- [ip redirects](#)
- [load-balance enable](#)
- [show forwarding profile limit](#)
- [show hardware-profile filters](#)
- [show nsm forwarding-timer](#)
- [show queue remapping](#)
- [snmp restart](#)

---

## delay-profile interfaces

Use this command to go into the delay-profile mode to edit the parameters of the "interfaces" profile. In this mode, the user is able to edit the delay measurement profile parameters.

### Command Syntax

```
delay-profile interfaces
```

### Parameters

None

### Command Mode

Configure mode

### Applicability

This command was introduced in OcNOS version 5.1.

### Examples

```
#configure terminal  
(config)#delay-profile interfaces  
(config-dp-intf)#
```

---

## delay-profile interfaces subcommands

The following commands are to edit the delay-profile parameters.

### Command Syntax

```

mode <two-way>
burst-interval <1000-15000>
burst-count <1-5>
interval < 30-3600>
sender-port <VALUE>
advertisement periodic
advertisement periodic threshold <1-100>
advertisement periodic minimum-change <0-10000>
no advertisement periodic
advertisement accelerated
advertisement accelerated threshold <1-100>
advertisement accelerated minimum-change <0-10000>
no advertisement accelerated

```

### Parameters

two-way	Sets the mode of the measurement. Only "two-way" is supported for now.
<1000-15000>	Set the burst interval in milliseconds. The default value is 3000 milliseconds and the range is 1000-15000 milliseconds
<1-5>	Set the number of packets to be sent at each burst interval. The default value is 1 and the range is 1-5
<30-3600>	Set the computation interval in seconds. The default computation interval is 30 seconds. The range is 30-3600 seconds. This will be used also as the periodic advertisement interval.
<1-100>	Set the advertisement threshold percentage in the range of 1-100 (for periodic, default=10% and for accelerated, default=20%)
<1025-65535>	Set the TWAMP sender port value in the range 1025-65535. If not specified, the default value is 862.
<0-10000>	Set the advertisement minimum change in microseconds in the range 0-10000 (for periodic, default=1000 and for accelerated, default=2000)

### Command Mode

delay-profile interfaces mode

### Applicability

This command was introduced in OcNOS version 5.1.

### Examples

```
#configure terminal
```

```
(config)#delay-profile interfaces
(config-dp-intf)#mode two-way
(config-dp-intf)#burst-count 5
(config-dp-intf)#burst-interval 3000
(config-dp-intf)#interval 30
(config-dp-int)#sender-port 862
(config-dp-intf)#advertisement periodic threshold 10
(config-dp-intf)#advertisement periodic minimum-change 1000
(config-dp-intf)#advertisement accelerated
(config-dp-intf)#advertisement accelerated threshold 20
(config-dp-intf)#advertisement accelerated minimum-change 2000
(config-dp-intf)#no advertisement periodic
(config-dp-intf)#commit
(config-dp-intf)#exit
(config)#
```

## forwarding profile

Use this command to configure different forwarding profiles in hardware.

Use the no form of this command to set the forwarding profile to default.

Note: It is required to save the configuration and reboot the board for the new forwarding profile to come into effect in the hardware.

Use [show forwarding profile limit](#) to verify the configured profile.

### Command Syntax

```
forwarding profile (kaps (profile-one | profile-two)) | (elk-tcam (profile-one |
  profile-two | profile-three | custom-profile))
no forwarding profile (kaps) | (elk-tcam (custom-profile))
```

### Parameters

For details about these profiles, see [show forwarding profile limit](#).

kaps	Internal KBP routing table
profile-one	KAPS profile one
profile-two	KAPS profile two
elk-tcam	External TCAM routing table
profile-one	external TCAM profile one
profile-two	external TCAM profile two
profile-three	external TCAM profile three
custom-profile	external TCAM custom profile
< 10-90>	percent of ipv4 routes
< 10-90>	percent of ipv6 routes

### Default

The default forwarding profile are as below

**Table 34-98:**

Is ELK-TCAM present	KAPS	ELK-TCAM
Yes	profile-two	profile-one
No	profile-one	N/A

Note:

1. elk-tcam profiles are supported only on hardware models which have external TCAM for routing.
2. forwarding profile-three is applicable on hardware model Agema AGC7648A.

## Command Mode

Configure mode

## Applicability

This command was introduced before OcNOS version SP 1.0. The `no` version of the command was introduced in OcNOS version 5.0.

## Examples

```
#configure terminal
(config)# forwarding profile elk-tcam profile-one
(config)# no forwarding profile elk-tcam
```



---

## hardware-profile filter

Use this command to enable or disable ingress IPv4 or IPv6, egress IPv6 filter groups, and TWAMP IPv4 and IPv6 groups. Disabling filter groups increases the configurable filter entries.

Disabling a TCAM filter group is not allowed if the group has any entries configured in hardware. Group dependent entries must be explicitly removed before disabling the TCAM group.

**Note:** The `qos`, `qos-ext`, and `qos-policer` filter groups can only be used for Layer 2 and IPv4 traffic. For IPv6 traffic QoS classification and actions, you must enable the `ingress-ipv6-qos` group and create an IPv6 ACL which can be matched in a class-map for applying QoS actions. For more, see the *Quality of Service Guide*.

Usually the number of extended ingress filter groups that can be created at the same time is 3. If the PIM bidirectional feature is enabled, only 2 ingress extended filter groups can be created.

The `ipv4-ext` and `qos-policer grp` parameters are not supported together.

For better utilization of TCAM resources, it is recommended to enable the large groups first and then smaller groups.

### Example 1:

```
(config)#hardware-profile filter ingress-ipv4-ext enable
(config)#hardware-profile filter ingress-ipv6 enable
(config)#hardware-profile filter qos-ext enable
(config)#hardware-profile filter ingress-l2 enable
```

### Example 2:

```
(config)#hardware-profile filter ingress-ipv4-qos enable
(config)#hardware-profile filter ipv4-bgp-flowspec enable
(config)#hardware-profile filter ingress-l2 enable
```

### Example 3:

```
(config)#hardware-profile filter qos-ext enable
(config)#hardware-profile filter egress-ipv4 enable
(config)#hardware-profile filter ipv4-bgp-flowspec enable
(config)#hardware-profile filter ingress-ipv4 enable
```

For EVPN multi-homing:

- Before enabling EVPN multi-homing (`evpn multi-homed` command), give this command.
- Before disabling the hardware-profile, disable EVPN multi-homing.

Enable `evpn mpls enable` after the hardware-profile filter commands.

Example:

```
(config)#hardware-profile filter qos-ext en
(config)#hardware-profile filter ipv4-bgp-flowspec enable
(config)#evpn mpls enable
```

## Command Syntax

```
hardware-profile filter (ingress-l2|ingress-l2-ext|ingress-ipv4|ingress-ipv4-  
ext|ingress-ipv4-qos|ingress-ipv6|ingress-ipv6-ext|ingress-ipv6-ext-  
vlan|ingress-ipv6-qos|qos-ipv6|ingress-arp|qos|qos-ext|qos-policer|egress-  
l2|egress-ipv4|cfm-domain-name-str|twamp-ipv4|twamp-ipv6|ipv4-bgp-flowspec|)  
(enable|disable)
```

## Parameter

<code>ingress-l2</code>	Ingress L2 ACL filter group.
<code>ingress-l2-ext</code>	Ingress L2 ACL, QoS, mirror filter group.
<code>ingress-ipv4</code>	Ingress IP ACL filter group.
<code>ingress-ipv4-ext</code>	Ingress IP ACL, mirror, PBR filter group.
<code>ingress-ipv4-qos</code>	Ingress IPv4 group for ACL match QoS.
<code>ingress-ipv6</code>	Ingress IPv6 ACL, mirror, PBR filter group.
<code>ingress-ipv6-ext</code>	Ingress IPv6 group to support 128-bit address qualification support on physical interface.
<code>ingress-ipv6-ext-vlan</code>	Ingress IPv6 group to support 128-bit address qualification support on vlan interface and subinterface.
<code>ingress-ipv6-qos</code>	Ingress IPv6 group for ACL match QoS.
<code>qos-ipv6</code>	Ingress QoS IPv6 group for IPv6 QoS support with statistics.
<code>ingress-arp</code>	Ingress ARP group.
<code>qos</code>	Ingress QoS filter group.
<code>qos-ext</code>	Ingress QoS extended filter group.
<code>qos-policer</code>	Ingress extended QoS group for hierarchical policer support.
<code>egress-l2</code>	Egress L2 ACL filter group.
<code>egress-ipv4</code>	Egress IP ACL filter group.
<code>cfm-domain-name-str</code>	Egress CFM domain group.
<code>twamp-ipv4</code>	TWAMP IPv4 filter group.
<code>twamp-ipv6</code>	TWAMP IPv6 filter group.
<code>ipv4-bgp-flowspec</code>	IPv4 BGP FlowSpec filter group.
<code>enable</code>	Enable filter group.
<code>disable</code>	Disable filter group.
<code>no</code>	Reset the group to as it was during init

**Default**

By default, all filter groups are disabled.

**Command Mode**

Configure mode

**Applicability**

This command was introduced before OcNOS version 1.3 and changed in OcNOS version 3.0.

**Examples**

```
#configure terminal
(config)#hardware-profile filter ingress-ipv4 enable
(config)#hardware-profile filter ingress-ipv4 disable

#(config)#hardware-profile filter egress-ipv4 enable
#(config)#hardware-profile filter egress-ipv4 disable
```

**Table 34-99: Supported groups and the feature dependency on the groups**

Group	Key Size	Security	QoS	PBR	Mirror	Statistics		
						QMX	QAX	QUX
ingress-l2	160	Yes	No	N/A	No	Yes	Yes	Yes
ingress-l2-ext	320	Yes	No	N/A	Yes	Yes	Yes	Yes
ingress-ipv4	160	Yes	No	No	No	Yes	Yes	Yes
ingress-ipv4-ext	320	Yes	No	Yes	Yes	Yes	Yes	Yes
ingress-ipv4-qos	320	N/A	Yes	N/A	N/A	Yes	Yes	Yes
ingress-ipv6	320	Yes	No	Yes	Yes	Yes	Yes	Yes
Ingress-ipv6-ext	320	N/A	Yes	No	Yes	Yes	Yes	Yes
Ingress-ipv6-ext-vlan	320	N/A	Yes	No	Yes	Yes	Yes	Yes
ingress-ipv6-qos	320	N/A	Yes	N/A	N/A	Yes	Yes	Yes
qos-ipv6	320	N/A	Yes	N/A	N/A	Yes	Yes	Yes
qos	160	N/A	Yes	N/A	N/A	No	No	No
qos-ext	320	N/A	Yes	N/A	N/A	Yes	Yes	Yes
qos-policer	320	N/A	Yes	N/A	N/A	Yes	Yes	Yes
egress-l2	320	Yes	N/A	N/A	N/A	Yes	Yes	Yes
egress-ipv4	320	Yes	N/A	N/A	N/A	Yes	Yes	Yes
cfm-domain-name-str	160	N/A	N/A	N/A	N/A	Yes	Yes	Yes
twamp-ipv4	320	N/A	N/A	N/A	N/A	Yes	Yes	Yes

**Table 34-99: Supported groups and the feature dependency on the groups (Continued)**

Group	Key Size	Security	QoS	PBR	Mirror	Statistics		
						QMX	QAX	QUX
twamp-ipv6	320	N/A	N/A	N/A	N/A	Yes	Yes	Yes
ipv4-bgp-flowspec	320	N/A	N/A	N/A	N/A	No	No	No

**Table 34-100: Comparison between basic and extended group qualifiers**

Basic Group	Qualifiers	Extended Group	Supported qualifiers
ingress-l2	Source MAC Destination MAC Ether Type (ip, ipv6, mpls, arp, cfm, fcoe) VLAN ID Inner VLAN ID	ingress-l2-ext	Source MAC Destination MAC Ether Type VLAN ID Inner VLAN ID COS
ingress-ipv4	Source IP Destination IP IP Protocols L4 Ports	ingress-ipv4-ext	Source IP Destination IP IP Protocols L4 Ports DSCP VLAN ID Inner VLAN ID TCP flags
qos	VLAN ID COS Inner VLAN ID Inner COS Ether Type DSCP Topmost EXP	qos-ext	VLAN ID COS Inner VLAN ID Inner COS Ether Type DSCP Topmost EXP IP RTP L4 Ports Destination MAC Traffic type

**Table 34-101: Qualifiers for other groups**

<b>Group</b>	<b>Qualifiers</b>
ingress-ipv6	Source IPv6 (n/w part) Destination IPv6 (n/w part) IPv6 Protocols L4 Ports
ingress-ipv6-ext	src ipv6 address full 128 bits dest ipv6 address full 128 bits L4ports Ipv6 protocols Physical interface
ingress-ipv6-ext-vlan	src ipv6 address full 128 bits dest ipv6 address full 128 bits L4ports Ipv6 protocols vlan interface subinterface
egress-l2	Source MAC Destination MAC VLAN ID Inner VLAN ID COS
egress-ipv4	Source IP Destination IP IP Protocols L4 Ports DSCP VLAN ID Inner VLAN ID
qos-policer	VLAN ID COS Inner VLAN ID Inner COS Ether Type DSCP Topmost EXP IP RTP L4 Ports
ingress-ipv4-qos	Source IP Destination IP IP Protocols L4 Ports DSCP VLAN ID Inner VLAN ID TCP flags

**Table 34-101: Qualifiers for other groups (Continued)**

Group	Qualifiers
ingress-ipv6-qos	Source IPv6 (n/w part) Destination IPv6 (n/w part) IPv6 Protocols L4 Ports
qos-ipv6	Source IPv6 (n/w part) Destination IPv6 (n/w part) IPv6 Protocols L4 Ports VLAN ID COS Inner VLAN ID Inner COS Ether Type DSCP
cfm-domain-name-str	MA ID
twamp-ipv4	IPv4 Source IP IPv4 Destination IP UDP Source port UDP Destination port IPv4 Type of Service
twamp-ipv6	UDP Source port UDP Destination port IPv6 Source IP IPv6 Destination IP IPv6 Traffic Class
Ipv4-bgp-flowspec	VRF ID Source IP Destination IP IP Protocols L4 Ports TCP Flags PacketSize DSCP IP Fragmentation

---

## hardware-profile flowcontrol

Use this command to globally enable or disable hardware-based flow control.

### Syntax

```
hardware-profile flowcontrol (disable|enable)
```

### Parameters

disable	Disable flow control globally
enable	Enable flow control globally

### Default

By default flow control is disabled.

### Command Mode

Configure mode

### Applicability

This command was introduced in OcNOS version 3.0.

### Examples

```
#configure terminal  
(config)#hardware-profile flowcontrol enable
```

---

## hardware-profile service-queue

Use this command to set the number of service-queue counts to create in hardware.

Use the no form of this command to set the service queue profile to default

Note: Reboot the switch after giving this command for the changes to take effect.

### Command Syntax

```
hardware-profile service-queue (profile1| profile2)
no hardware-profile service-queue
```

### Parameter

profile1	Supports new 4 queue-bundle per service (default)
profile2	Supports new 8 queue-bundle per service

### Default

By default, profile1 is enabled.

### Command Mode

Configure mode

### Applicability

This command was introduced before OcNOS version 1.3.

This command is only available on Qumran platforms.

### Examples

```
#configure terminal
(config)#hardware-profile service-queue profile2
(config)#no hardware-profile service-queue
```



---

## hardware-profile statistics

Use this command to enable or disable filter statistics in hardware.

Note: In Q1, you must reboot the switch after giving this command for the changes to take effect. For Q2, Statistic profiles are updated dynamically.

Note: If both ACL and QoS statistics are required on the same interface, then both ingress-acl and ingress-qos profiles must be enabled and this will limit other profiles from being enabled. More details on restrictions explained below.

Note: When any two or all of MAC ACL or IP ACL or QoS service-policy are configured on the same interface or in its dependent interface, their entries will use statistics entries from ingress-acl statistics profile, and as a result the statistics is updated on only one entry based on the hardware-profile filter created later.

Note: Cfm-slm statistics is supported only on Q2 devices.

### Command Syntax

```
hardware-profile statistics (ac-lif|cfm-ccm|cfm-lm |cfm-slm|ingress-acl|ingress-
qos|egress-acl|mpls-pwe|tunnel-lif|voq-full-color|voq-fwd-drop) (enable|disable)
```

### Parameter

ac-lif	VXLAN access ports statistics
cfm-ccm	Cfm ccm counter statistics
cfm-lm	Cfm Loss Measurements statistics
cfm-slm	Cfm Synthetic Loss Measurements statistics
tunnel-lif	VXLAN tunnels statistics
ingress-acl	Ingress ACL, QoS, and PBR statistics
ingress-qos	Ingress QoS statistics (explicit)
egress-acl	Egress ACL statistics
mpls-pwe	Pseudowire logical interfaces statistics
voq-full-color	Statistics for all VOQ counters
voq-fwd-drop	Statistics for forward drop VOQ counters
enable	Enable statistics
disable	Disable statistics

### Default

In Q1, By default, only ingress-acl statistics profile is enabled. Other statistics profiles are disabled.

In Q2, By default, voq-full-color, cfm-ccm statistics profile is enabled. Other statistics profiles are disabled

### Command Mode

Configure mode

### Applicability

This command was introduced before OcNOS version 1.3 and this command is applicable for Qumran. The voq-full-color and voq-fwd-drop, cfm-slm, cfm-lm and cfm-ccm options are applicable for Qumran2.

## Examples

```
#configure terminal
(config)#hardware-profile statistics tunnel-lif enable
```

Table 34-102 provides details of scalable numbers of each statistics profiles and the applications that use the statistics profiles. For example, the `ingress-acl` profile is used by ACL, QoS, and PBR applications and all of them share the statistics entries from this profile. So, consuming 8k statistics entries for ACL application means that QoS and PBR applications do not get any statistics.

There are limitations on the number of statistics profiles that can be enabled at a time. This limitation is based on the stages that each profile uses. Table 34-102 shows the four stages: ingress, ingress queuing, egress1, and egress2; and only two statistics profiles per stage can be configured.

For example, if both the `ingress-acl` and `mpls-acl` profiles are configured, then no more profiles that use the “ingress stage” can be enabled because only two profiles are allowed per stage. To use another “ingress-based” profile, you must first disable at least one of the profiles that are currently using the ingress stage.

**Table 34-102: Statistics profile capacity (maximum numbers in best case scenario)**

Statistics profile	Stage	QMX	QAX	QUX	Application
<code>ingress-acl</code>	Ingress	~8k	~6k	~1.5K	Ingress ACL, QoS, PBR
<code>egress-acl</code>	Egress1	~8k	~2k	~2k	Egress ACL
<code>ingress-qos</code>	Ingress	~8k	~6k	~1.5K	QoS
<code>voq-full-color</code>	Ingress queuing	~13k	~6k	~1.5K	QoS (queue statistics)
<code>voq-fwd-drop</code>	Ingress queuing	~32k	~16k	~4K	QoS (queue statistics)
<code>tunnel-lif</code>	Ingress	~16k	N/A	N/A	VXLAN and MPLS (LSP/tunnels)
	Egress2				
<code>mpls-pwe</code>	Ingress	~16k	~8k	~1K	MPLS (pseudowire)
	Egress2				
<code>cfm-ccm</code>	Ingress	~3k	~800	~800	CFM (ccm)
<code>cfm-lm</code>	Ingress	~6k	~1.5k	NA	CFM (loss measurement)
	Egress2				
<code>ac-lif</code>	Ingress	~32k	N/A	N/A	VXLAN and MPLS (access-port)
	Egress2				

---

## hardware-profile bgp-flowspec-mode

Use this command to set BGP flowspec mode that specifies the installation rules to the hardware.

Note: No support for Install-partial option in Q2.

Setting hardware profile to bgp-flowspec-mode requires, disabling and enabling the ipv4-bgp-flowspec to take effect.

Chose a appropriate option based on usage. Use `install-all` option for normal case.

### Syntax

```
hardware-profile bgp-flowspec-mode (install-all|install-partial|no-prioritizing)
```

### Parameters

<code>install-all</code>	FLowspec rules are prioritized. The already installed all rules are reinstalled when a new rule is added. (default)
<code>install-partial</code>	FLowspec rules are prioritized. Do not reinstall all previously installed rules when a new rule is added to avoid unnecessary reinstallation.
<code>no-prioritizing</code>	FLowspec rules are not prioritized. Install only rules requested to add but not reinstall any other rules when a new rule is added.

### Default

None

### Command Mode

Configure mode

### Applicability

This command was introduced in OcNOS version 6.3.5.

### Example

```
(config)#hardware-profile bgp-flowspec-mode install-all
(config)#commit
(config)#
```

---

## ip redirects

Use this global command to trap ICMP redirect packets to the CPU and on interface to enable ICMP redirects in kernel.

Use the no form of this command to disable the ICMP redirect message on an interface.

Note: This command is applicable for both ipv4 and ipv6 interfaces.

### Syntax

```
ip redirects
no ip redirects
```

### Parameters

None

### Default

None

### Command Mode

Configure and Interface mode

### Applicability

This command was introduced in OcNOS version 3.0.

### Example

```
#configure terminal
(config)#ip redirects
```

```
(config)#no ip redirects
```

```
#configure terminal
(config)#interface xe1/1
(config-if)#ip redirects
```

```
#configure terminal
(config)#interface xe1/1
(config-if)#no ip redirects
```

## ip redirects

Use this global command to trap ICMP redirect packets to the CPU and on interface to enable ICMP redirects in kernel. Use the no form of this command to disable the ICMP redirect message on an interface.

Note: This command is applicable for both ipv4 and ipv6 interfaces.

### Syntax

```
ip redirects
no ip redirects
```

### Parameters

None

### Default

None

### Command Mode

Configure and Interface mode

### Applicability

This command was introduced in OcNOS version 3.0.

### Example

```
#configure terminal
(config)#ip redirects
```

```
(config)#no ip redirects
```

```
#configure terminal
(config)#interface xe1/1
(config-if)#ip redirects
```

```
#configure terminal
(config)#interface xe1/1
(config-if)#no ip redirects
```

---

## load-balance enable

Use this command to enable load-balancing configurations in hardware.

Use the no option to reset the load balancing to default settings.

Note: When the command "load-balance enable" is issued, the default load-balance settings are unset. User then has to configure the new load-balancing parameters.

### Command Syntax

This form unsets load balancing globally:

```
load-balance enable
```

This form resets load balancing globally to default settings:

```
no load-balance enable
```

By default, load balancing is enabled for ECMP and LAG.

This form sets hashing based on IPv4 fields:

```
load-balance (ipv4 {src-ipv4 | dest-ipv4 | src14-port | dest14-port | protocol-id})
no load-balance (ipv4 {src-ipv4 | dest-ipv4 | src14-port | dest14-port | protocol-id})
```

This form sets hashing based on IPv6 fields:

```
load-balance (ipv6 {src-ipv6 | dest-ipv6 | src14-port | dest14-port | protocol-id})
no load-balance (ipv6 {src-ipv6 | dest-ipv6 | src14-port | dest14-port | protocol-id})
```

This form sets hashing based on L2 fields:

```
load-balance (l2 {src-dest-mac|non-symmetric|ether-type|vlan})
no load-balance (l2 {src-dest-mac|non-symmetric|ether-type|vlan})
```

This form sets hashing on an MPLS fields:

```
load-balance (mpls {labels})
no load-balance (mpls {labels})
```

Note: The configured load balancing parameters are global and will be applicable to all LAG & ECMP created in the hardware.

### Parameters

ipv4	Load balance IPv4 packets
src-ipv4	Source IPv4 based load balancing
dest-ipv4	Destination IPv4 based load balancing

---

<code>src14-port</code>	Source L4 port based load balancing
<code>dest14-port</code>	Destination L4 port based load balancing
<code>protocol-id</code>	Protocol ID based load balancing
<code>ipv6</code>	Load balance IPv6 packets
<code>src-ipv6</code>	Source IPv6 based load balancing
<code>dest-ipv6</code>	Destination IPv6 based load balancing
<code>src14-port</code>	Source L4 port based load balancing
<code>dest14-port</code>	Destination L4 port based load balancing
<code>l2</code>	Load balance L2 packets
<code>src-dest-mac</code>	Source Destination based load balancing
<code>non-symmetric</code>	Non symmetrical based load balancing
<code>ether-type</code>	Ether-type based load balancing
<code>Vlan</code>	VLAN-based load balancing
<code>mpls</code>	Load balance MPLS packets
<code>labels</code>	label stack based load balancing.

## Command Mode

Configure mode

## Applicability

This command was introduced before OcnOS version 3.0.

## Examples

```
(config)#load-balance enable
(config)#load-balance ipv4 src-ipv4
```

---

## show forwarding profile limit

Use this command to display the forwarding profile table sizes.

Note: 1k is 1024 entries.

### Command Syntax

```
show forwarding profile limit
```

### Parameters

None

### Default

None

### Command Mode

Exec mode

### Applicability

This command was introduced before OcNOS version SP 1.0.

### Examples

```
#show forwarding profile limit
```

```
-----
                L3 (Ipv4/Ipv6) KAPS Forwarding Profile
-----
Active (*)   Configured (*)  Profile-type   IPv4-db-size   IPv6-db-size
   *         *                profile-one     NA              NA
   *         *                profile-two     -               200k
-----
                L3 (Ipv4/Ipv6) ELK TCAM Forwarding Profile
-----
Active (*)   Configured (*)  Profile-type   IPv4-db-size   IPv6-db-size
   *         *                profile-one     ~1024k         -
   *         *                profile-two     -               ~1024k
   *         *                profile-three   ~2048k         -
-----
```

NOTE: for external-tcam profile-three, URPF should be disabled & number of vrf's limited to 255

```
-----
                L2 forwarding table
-----
                Max Entries: 768k
```

NOTE: 1k is 1024 entries

```
#
```



## show hardware-profile filters

Use this command to show details of TCAM filter groups which are enabled. By default, all filter groups are disabled.

### Command Syntax

```
show hardware-profile filters
```

### Parameter

None

### Command Mode

Exec mode

### Applicability

This command was introduced before OcNOS version 3.0.

### Examples

```
#show hardware-profile filters
```

Note: Shared count is the calculated number from available resources.

Dedicated count provides allocated resource to the group.

If group shares the dedicated resource with other groups, then dedicated count of group will reduce with every resource usage by other groups.

```
+-----+-----+-----+-----+
|          | Free  |      Used      |          Total Entries          |
| TCAMS    | Entries | % | Entries | Total | Dedicated | shared |
+-----+-----+-----+-----+
INGRESS-QOS-EXT  10495  0  1          10486  2048          8448
```

[Table 34-103](#) explains the output fields.

**Table 34-103: show hardware-profile filters**

Field	Description
Ingress	Ingress filtering is a method used to prevent suspicious traffic from entering a network.
TCAMS	Number of ternary content addressable memory (TCAM) entries a particular firewall filter.
Free Entries	Number of TCAM filter entries available for use by the filter group.
Used Entries	Number of TCAM filter entries used by the filter group.
Total Entries	Number of TCAM total filter entries to the filter group.

Table 34-103: show hardware-profile filters (Continued)

Field	Description
Dedicated Entries	Number of TCAM filter entries dedicated to the filter group.
Shared Entries	Number of TCAM filter entries shared to the filter groups.

## Operational details of TCAM profiles

TCAM group statistics comprises of three parts:

- **Total Entries** – Total configurable entries on the TCAM group. Total has two parts. One is dedicated and other is shared. Dedicated count is the guaranteed entry count for the group. Shared count a logical count calculated for the group from shared pool available at the time of show command execution
- **Used Entries** – Count of entries that have been configured on the TCAM group. Used entries are shown are shown in percentage format as well as an indication of how much TCAM space is used up. However, percentage calculation includes shared pool and subject to change drastically when shared pool is taken up by different group.
- **Free Entries** – Count of possible remaining entries on the TCAM group. Free entries count is not the guaranteed count as the count includes the shared pool count into account.

When a TCAM group is enabled in the device, no hardware resource (bank) is associated with the group. Thus, dedicated count will be initially zero. Total count will be same as shared count which is calculated based on the group width. Group width is determined by width consumed by the qualifiers or width consumed by the actions.

Example of show output when qos-ext group is enabled on QMX device is shown below:

```
#show hardware-profile filters
...
+-----+-----+-----+-----+
|          | Free   |      Used      |      Total Entries      | | |
| TCAMS    | Entries|-----|-----|
|          |      % | Entries | Total | Dedicated | shared |
+-----+-----+-----+-----+
INGRESS-QOS-EXT  10496  0  0  10496  0  10496
```

When an entry is created on the group for the first time, either a single bank or a bank pair is allocated to the group. A group consuming single bank or a bank pair is decided by group width. Groups like qos, ingress-l2, and ingress-ipv4 consume single bank and groups like qos-ext, qos-policer, ingress-l2-ext, ingress-ipv4-ext, ingress-ipv4-qos, ingress-ipv6, ingress-ipv6-qos, egress-l2, and egress-ipv4 consume a bank pair.

An example of output when a single entry is created in hardware for qos-ext group on QMX device is shown below:

```
#show hardware-profile filters
...
+-----+-----+-----+-----+
|          | Free   |      Used      |      Total Entries      | | |
| TCAMS    | Entries|-----|-----|
|          |      % | Entries | Total | Dedicated | shared |
+-----+-----+-----+-----+
INGRESS-QOS-EXT  10495  0  1  10496  2048  8448
```

In the above example, dedicated entry count has increased to 2048 as a bank pair is allocated for the group. Unallocated banks capacity is calculated for qos-ext group and counted under shared entries as 8448.

An example of output when 2048 entries are created in hardware for qos-ext group and ingress-l2 and ingress-ipv4-ext groups is enabled with no entries created on those groups for QMX device is shown below:

```
#show hardware-profile filters
```

```
...
```

TCAMS	Free	Used		Total Entries		
	Entries	%	Entries	Total	Dedicated	shared
INGRESS-QOS-EXT	8448	20	2048	10496	2048	8448
INGRESS L2	16896	0	0	16896	0	16896
INGRESS IPV4-EXT	8448	0	0	8448	0	8448

In the above example, note that the number of entries between ingress-l2 and ingress-ipv4-ext groups vary as ingress-l2 group is a 160-bit wide group consuming only one bank at a time. On the other hand, ingress-ipv4-ext group is 320 bit wide group consuming a group pair at a time. With a bank pair already being consumed by qos-ext group, ingress-ipv4-ext group gets possible total entries of 8448 in comparison to 10496 by qos-ext group.

When all the created entry count goes beyond the entries of dedicated bank pair (or a bank), group will be allocated with another bank pair (or a bank) and subsequently shared pool count will reduce across all other groups.

An example of output when 2049 entries are created in hardware for qos-ext group with ingress-l2 and ingress-ipv4-ext groups enabled with no entries created on those groups for QMX device is shown below:

```
#show hardware-profile filters
```

```
...
```

TCAMS	Free	Used		Total Entries		
	Entries	%	Entries	Total	Dedicated	shared
INGRESS-QOS-EXT	8447	20	2049	10496	4096	6400
INGRESS L2	12800	0	0	12800	0	12800
INGRESS IPV4-EXT	6400	0	0	6400	0	6400

When a bank is consumed by ingress-l2 group, effect on qos-ext group will still be the count of a bank pair with one bank not usable for qos-ext group even if it is available. The bank can be used by groups which consume single bank.

An example of output when an entry is created in hardware for ingress-l2 group with qos-ext and ingress-ipv4-ext groups in the state as mentioned in above example is shown below:

```
#show hardware-profile filters
```

```
...
```

TCAMS	Free	Used		Total Entries		
	Entries	%	Entries	Total	Dedicated	shared
INGRESS-QOS-EXT	6399	24	2049	8448	4096	4352
INGRESS L2	12799	0	1	12800	2048	10752
INGRESS IPV4-EXT	4352	0	0	4352	0	4352

In the above example scenario, it can be noted that the used entry percentage for qos-ext group jumped from 20 to 24 as a result of drastic reduction in total entry count due to bank movement from shared pool to dedicated bank.

Hardware doesn't optimize the utilization of banks when entries are removed from one of the banks resulting in entries used shown up less than capacity of one bank but still multiple banks would be dedicated to a group.

An extended example of above scenario with 10 entries removed from qos-ext group is shown below:

```
#show hardware-profile filters
```

```
...
```

TCAMS	Free Entries	Used %	Used Entries	Total	Dedicated	Entries shared
INGRESS-QOS-EXT	6409	24	2039	8448	4096	4352
INGRESS L2	12799	0	1	12800	2048	10752
INGRESS IPV4-EXT	4352	0	0	4352	0	4352

It can be noted that the used entry count has come down to 2039 which is less than the capacity of bank pair i.e. 2048. However, since entries are used up across two set of bank pairs, both bank pairs will still be dedicated. If there is a need to recover bank pair from dedicated pool, all the entries should be deleted and re-created in hardware.

TCAM groups are further divided into sub-categories which can share the dedicated banks between the groups. TCAM groups such as ingress-l2, ingress-l2-ext, ingress-ipv4, ingress-ipv4-ext, ingress-ipv4-qos, qos, qos-ext, qos-policer are considered under default sub-category and don't serve IPv6 traffic. TCAM groups such as ingress-ipv6, ingress-ipv6-qos, and qos-ipv6 are meant for IPv6 traffic and are considered under IPv6 sub-category.

Only four 320-bit wide groups that belong to same sub-category can be created. For default sub-category, number is limited to three as system group will be created by default.

When three default sub-category groups are created along with one group from IPv6 sub-category, one of the default sub-category group will share the bank pair with IPv6 group. This will result in dedicated count to be shown lesser by the number that the other shared group is consuming. With every single resource consumed by one group will reduce the same number from other shared group.

An example of above scenario is shown below:

```
#show hardware-profile filters
```

```
...
```

TCAMS	Free Entries	Used %	Used Entries	Total	Dedicated	Entries shared
QOS-EXT	6399	0	1	6400	2048	4352
INGRESS IPV4-ACL-EXT	6398	0	2	6400	2048	4352
INGRESS IPV4-QOS	6382	0	1	6383	2031	4352
INGRESS IPV6-ACL	6382	0	17	6399	2047	4352

Note that ingress-ipv4-qos group has shared the resource with ingress-ipv6 group. TCAM group ingress-ipv4-qos has consumed 1 entry and ingress-ipv6 group has consumed 17 entries. Hence, dedicated count for ingress-ipv4-qos group is shown as 2031 (2048 - 17) and dedicated count for ingress-ipv6 group is shown as 2047 (2048 - 1).

## Capacity of TCAM profiles

Entries created on other TCAM groups affect the capacity of a particular TCAM group. This dependency is explained in the section [Operational details of TCAM profiles](#).

In this section maximum configurable entries per group when no entries created on other groups are listed below.

**Table 34-104: Maximum configurable entries**

TCAM Groups	QMX	QAX	QUX
ingress-l2	20992 (2048 x 10 + 256 x 2)	9728 (1024 x 9 + 256 x 2)	3584
ingress-l2-ext	10496 (2048 x 5 + 256 x 1)	4352 (1024 x 4 + 256 x 1)	1792
ingress-ipv4	20992 (2048 x 10 + 256 x 2)	9728 (1024 x 9 + 256 x 2)	3584
ingress-ipv4-ext	10496 (2048 x 5 + 256 x 1)	4352 (1024 x 4 + 256 x 1)	1792
ingress-ipv4-qos	10496 (2048 x 5 + 256 x 1)	4352 (1024 x 4 + 256 x 1)	1792
ingress-ipv6	10496 (2048 x 5 + 256 x 1)	4352 (1024 x 4 + 256 x 1)	1792
ingress-ipv6-ext	10496 (2048 x 5 + 256 x 1)	4352 (1024 x 4 + 256 x 1)	1792
ingress-ipv6-ext-vlan	10496 (2048 x 5 + 256 x 1)	4352 (1024 x 4 + 256 x 1)	1792
ingress-ipv6-qos	10496 (2048 x 5 + 256 x 1)	4352 (1024 x 4 + 256 x 1)	1792
qos-ipv6	12288 (2048 x 6)	5120 (1024 x 5)	1792
qos	20992 (2048 x 10 + 256 x 2)	9728 (1024 x 9 + 256 x 2)	3584
qos-ext	10496 (2048 x 5 + 256 x 1)	4352 (1024 x 4 + 256 x 1)	1792
qos-policer	10496 (2048 x 5 + 256 x 1)	4352 (1024 x 4 + 256 x 1)	1792
egress-l2	10496 (2048 x 5 + 256 x 1)	4352 (1024 x 4 + 256 x 1)	1792
egress-ipv4	10496 (2048 x 5 + 256 x 1)	4352 (1024 x 4 + 256 x 1)	1792
cfm-domain-name-str	20992 (2048 x 10 + 256 x 2)	9728 (1024 x 9 + 256 x 2)	3584
ipv4-bgp-flowspec	10496 (2048 x 5 + 256 * 1)	8704 (1024 * 8 + 256 * 2)	

## Combination of TCAM profiles

Device supports configuration of only one egress group in the system. Hence out of the egress groups cfm-domain-name-str, egress-l2 and egress-ipv4, only one egress group can be enabled.

In other words, solution with CFM features enabled, cannot have egress security filters.

Configuration of ingress groups are subject to the sub-category to which a group belongs. Sub-category of each group is shown below:

**Table 34-105: Sub-category of groups**

<b>Category</b>	<b>Groups in the category</b>
default (ingress)	ingress-l2 ingress-l2-ext ingress-ipv4 ingress-ipv4-ext ingress-ipv4-qos qos qos-ext qos-policer ipv4-bgp-flowspec
ipv6 (ingress)	ingress-ipv6, ingress-ipv6-qos, qos-ipv6, ingress-ipv6-ext, ingress-ipv6-ext-vlan
default (egress)	egress-l2, egress-ipv4
cfm (egress)	cfm-domain-name-str

Note: Per sub-category, not more than three groups can be created if the group key size is 320 bits wide.

---

## show nsm forwarding-timer

Use this command to display the information of Graceful Restart capable MPLS clients to NSM that are currently shutdown. Use the option LDP or RSVP to see the particular module information.

### Command Syntax

```
show nsm (ldp| rsvp) forwarding-timer
```

### Parameters

ldp	Use this parameter to display the protocol LDP information.
rsvp	Use this parameter to display the protocol RSVP information.

### Command Mode

Privileged Exec mode

### Applicability

This command was introduced before OcNOS version 5.0.

### Example

```
#sh nsm rsvp forwarding-timer
Protocol-Name  GR-State  Time Remaining (sec)  Disconnected-time
  RSVP         ACTIVE    100                   2021/08/18 04:49:23
#sh nsm ldp forwarding-timer
Protocol-Name  GR-State  Time Remaining (sec)  Disconnected-time
  LDP          ACTIVE    111                   2021/08/18 04:50:37
#sh nsm forwarding-timer
Protocol-Name  GR-State  Time Remaining (sec)  Disconnected-time
  LDP          ACTIVE    110                   2021/08/18 04:50:37
  RSVP         ACTIVE    96                    2021/08/18 04:49:23
```

---

## show queue remapping

Use this command to display the traffic class-to-hardware-queue mapping in hardware.

### Command Syntax

```
show queue remapping
```

### Parameters

N/A

### Default

N/A

### Command Mode

Exec mode

### Applicability

This command was introduced before OcNOS version 1.3.

This command is only available on Qumran platforms.

### Examples

When service-queue profile1 is set:

```
#show queue remapping
```

```
Port queue remapping:
```

Queue/tc	hardware-queue
0	0
1	1
2	2
3	3
4	4
5	5
6	6
7	7

```
Service queue remapping:
```

Queue/tc	hardware-queue
0	0
1	1
2	1
3	1



---

4	2
5	2
6	3
7	3

When service-queue profile2 is set:

```
#show queue remapping
```

Port queue remapping:

Queue/tc	hardware-queue
0	0
1	1
2	2
3	3
4	4
5	5
6	6
7	7

Service queue remapping:

Queue/tc	hardware-queue
0	0
1	1
2	2
3	3
4	4
5	5
6	6
7	7

---

## snmp restart

Use this command to restart SNMP for a given process.

### Command Syntax

```
snmp restart (auth | bfd | bgp | isis | lacp| ldp | lldp | mrib | mstp | nsm | ospf  
| ospf6 | pim | rib| rip | rsvp |vrrp)
```

### Parameters

auth	Authentication
bfd	Bidirectional Forwarding Detection (BFD)
bgp	Border Gateway Protocol (BGP)
isis	Intermediate System - Intermediate System (IS-IS)
lacp	Link Aggregation Control Protocol (LACP)
ldp	Label Distribution Protocol (LDP)
lldp	Link Layer Discovery Protocol (LLDP)
mrib	Multicast Routing Information Base (MRIB)
mstp	Multiple Spanning Tree Protocol (MSTP)
nsm	Network Service Module (NSM)
ospf	Open Shortest Path First (OSPFv2)
ospf6	Open Shortest Path First (OSPFv3)
pim	Protocol Independent Multicast (PIM)
rib	Routing Information Base (RIB)
rip	Routing Information Protocol (RIP)
rsvp	Resource Reservation Protocol (RSVP)
vrrp	Virtual Router Redundancy Protocol (VRRP)

### Default

N/A

### Command Mode

Configure mode

### Applicability

This command was introduced before OcNOS version 1.3.

### Examples

```
(config)#snmp restart nsm
```

## CHAPTER 35 Control Plane Policing Commands

---

This chapter is a reference for the Control Plane Policing (CoPP) commands.

- [clear interface cpu counters](#)
- [cpu-queue](#)
- [show interface cpu counters queue-stats](#)
- [show cpu-queue details](#)

---

## clear interface cpu counters

Use this command to clear the CPU queue counters.

### Command Syntax

```
clear interface cpu counters
```

### Parameter

None

### Command Mode

Exec mode and Privileged Exec mode

### Applicability

This command was introduced before OcNOS version 1.3.

### Example

```
#clear interface cpu counters
```

---

## cpu-queue

Use this command to set protocol queues shaper and enable/disable queue monitoring for drop.

### Command Syntax

```
cpu-queue (cpu.q0|cpu.q1|cpu.q2|cpu.q3|cpu.q4|cpu.q5|cpu.q6|cpu.q7|
arp|bfd|bgp|bpdu|dsp|icmp|icmp-redirect|igmp|isis|link-
local|nhop|ospf|pim|reserved-mc|rsvp-ldp|sflow|vrrp-rip-dhcp|vxlan) (monitor|no-
monitor|rate <0-100000>)
```

```
no cpu-queue (cpu.q0|cpu.q1|cpu.q2|cpu.q3|cpu.q4|cpu.q5|cpu.q6|cpu.q7|
arp|bfd|bgp|bpdu|dsp|icmp|icmp-redirect|igmp|isis|link-
local|nhop|ospf|pim|reserved-mc|rsvp-ldp|sflow|vrrp-rip-dhcp|vxlan) (monitor|no-
monitor|rate <0-100000>)
```

### Parameters

arp	ARP queue parameters
bfd	BFD queue parameters
bgp	BGP queue parameters
bpdu	BPDU queue parameters
cpu.q0	cpu.q0
cpu.q1	cpu.q1
cpu.q2	cpu.q2
cpu.q3	cpu.q3
cpu.q4	cpu.q4
cpu.q5	cpu.q5
cpu.q6	cpu.q6
cpu.q7	cpu.q7
dsp	SP queue parameters
icmp	ICMP queue parameters
icmp-redirect	ICMP-redirect queue parameters
igmp	GMP queue parameters
isis	ISIS queue parameters
link-local	Link-local queue parameters
nhop	Next hop queue parameters
ospf	OSPF queue parameters
pim	PIM queue parameters
reserved-mc	Reserved-mc queue parameters
rsvp-ldp	RSVP/LDP queue parameters
sflow	Sflow queue parameters
vrrp-rip-dhcp	VRRP/RIP/DHCP queue parameters
vxlan	VXLAN queue parameters

monitor	Monitor CPU queue usage
no-monitor	Do not monitor CPU queue usage
rate	Set CPU queue rate <0-100000>

## Default

CPU queues are set with the default values as shown in [Table 29-2](#) and [Table 29-3](#).

## Command Mode

Exec mode and Privileged exec mode

## Applicability

This command was introduced before OcNOS-SP version 2.4.

## Example

Use the following command to configure rate/monitor/no-monitor for protocol queues:

```
#configure terminal
(config)#cpu-queue cpu-q0 rate 400
```

Use the following command to verify the rate received on each protocol queue:

```
#show int cpu counters rate kbps
```

Load interval: 30 second

CPU Queue (%)	Rx kbps	Rx pps	Tx kbps	Tx pps
CPU0.q0 (100%)	-	-	470.63	58
bpdu ( 0%)	-	-	0.54	1

Use the following command to verify the maximum, configured, and default configuration values:

```
#show cpu-queue details
```

\* - Can not configure the parameter

Cpu queue Name	Rate In Kbps			Monitor Status	
	Configured	Default	Max Rate Allowed	Configured	Default
cpu.q0	400	900	20000	-	* no-monitor
cpu.q1	-	900	900	-	* no-monitor
cpu.q2	-	900	900	-	* no-monitor
cpu.q3	-	900	900	-	* no-monitor
cpu.q4	-	900	900	-	* no-monitor
cpu.q5	-	900	900	-	* no-monitor
cpu.q6	-	900	20000	-	* no-monitor
cpu.q7	-	900	900	-	* no-monitor
igmp	-	1000	1000	-	* no-monitor
is-is	-	8000	8000	-	no-monitor
reserved mc	-	8000	8000	-	no-monitor
link-local	-	1000	1000	-	no-monitor

ospf	-	8000	8000	-	no-monitor
bgp	-	8000	8000	-	no-monitor
rsvp/ldp	-	1500	1500	-	no-monitor
vrrp/rip/dhcp	-	2000	2000	-	no-monitor
pim	-	8000	8000	-	* no-monitor
icmp	-	1000	1000	-	no-monitor
arp	-	1000	1000	-	no-monitor
bpdu	-	1000	1000	-	no-monitor
bfd	-	1000	1000	-	no-monitor
sflow	-	16384	16384	-	no-monitor
dsp	-	1500	1500	-	no-monitor
vxlan	-	500	500	-	no-monitor
nhop	-	500	500	-	no-monitor
icmp-redirect	-	400	400	-	no-monitor
guest-vm	-	8000	8000	-	* no-monitor

Use the following command to remove the configuration:

```
(config)#no cpu-queue cpu.q0
(config)#exit
```

```
#
#show cpu-queue details
* - Can not configure the parameter
```

Cpu queue Name	Rate In Kbps			Monitor Status	
	Configured	Default	Max Rate Allowed	Configured	Default
=====	=====	=====	=====	=====	=====
cpu.q0	-	900	20000	-	* no-monitor
cpu.q1	-	900	900	-	* no-monitor
cpu.q2	-	900	900	-	* no-monitor
cpu.q3	-	900	900	-	* no-monitor
cpu.q4	-	900	900	-	* no-monitor
cpu.q5	-	900	900	-	* no-monitor
cpu.q6	-	900	20000	-	* no-monitor
cpu.q7	-	900	900	-	* no-monitor
igmp	-	1000	1000	-	* no-monitor
is-is	-	8000	8000	-	no-monitor
reserved mc	-	8000	8000	-	no-monitor
link-local	-	1000	1000	-	no-monitor
ospf	-	8000	8000	-	no-monitor
bgp	-	8000	8000	-	no-monitor
rsvp/ldp	-	1500	1500	-	no-monitor
vrrp/rip/dhcp	-	2000	2000	-	no-monitor
pim	-	8000	8000	-	* no-monitor
icmp	-	1000	1000	-	no-monitor
arp	-	1000	1000	-	no-monitor
bpdu	-	1000	1000	-	no-monitor
bfd	-	1000	1000	-	no-monitor
sflow	-	16384	16384	-	no-monitor
dsp	-	1500	1500	-	no-monitor
vxlan	-	500	500	-	no-monitor

## Control Plane Policing Commands

---

nhop	-	500	500	-	no-monitor
icmp-redirect	-	400	400	-	no-monitor
guest-vm	-	8000	8000	-	* no-monitor



---

## show interface cpu counters queue-stats

Use this command to display the counters of packets destined to the CPU.

For details about this command, see [show interface counters queue-stats](#).

### Example

```
#show interface cpu counters queue-stats
E - Egress, I - Ingress, Q-Size is in bytes
```

Queue/Class-map	Q-Size	Tx pkts	Tx bytes	Dropped pkts	Dropped bytes
igmp	(E) 2097152	151	16258	0	0
reserved mc	(E) 2097152	62826	6324464	0	0
ospf	(E) 1048576	3184	308548	0	0
bgp	(E) 1048576	27587	3938124	0	0
rsvp/ldp	(E) 1048576	29138	3090385	0	0
icmp	(E) 1048576	176	20924	0	0
arp	(E) 1048576	751	48064	0	0
bpdu	(E) 1048576	26833	3129794	0	0
bfd	(E) 1048576	38	4028	0	0
dsp	(E) 78643200	507	34476	0	0

---

## show cpu-queue details

Use this command to display CPU queue details.

### Command Syntax

```
show cpu-queue details
```

### Parameters

None

### Default

Not applicable

### Command Mode

Exec mode and Privileged exec mode

### Applicability

This command was introduced before OcNOS-SP version 2.4.

### Example

Use the following command to configure rate/monitor/no-monitor for protocol queues:

```
#configure terminal
(config)#cpu-queue cpu-q0 rate 400
```

Use the following command to verify the maximum, configured, and default configuration values:

```
#show cpu-queue details
```

\* - Can not configure the parameter

Cpu queue Name	Rate In Kbps			Monitor Status	
	Configured	Default	Max Rate Allowed	Configured	Default
cpu.q0	400	900	20000	-	* no-monitor
cpu.q1	-	900	900	-	* no-monitor
cpu.q2	-	900	900	-	* no-monitor
cpu.q3	-	900	900	-	* no-monitor
cpu.q4	-	900	900	-	* no-monitor
cpu.q5	-	900	900	-	* no-monitor
cpu.q6	-	900	20000	-	* no-monitor
cpu.q7	-	900	900	-	* no-monitor
igmp	-	1000	1000	-	* no-monitor
is-is	-	8000	8000	-	no-monitor
reserved mc	-	8000	8000	-	no-monitor
link-local	-	1000	1000	-	no-monitor
ospf	-	8000	8000	-	no-monitor
bgp	-	8000	8000	-	no-monitor
rsvp/ldp	-	1500	1500	-	no-monitor

---

vrrp/rip/dhcp	-	2000	2000	-	no-monitor
pim	-	8000	8000	-	* no-monitor
icmp	-	1000	1000	-	no-monitor
arp	-	1000	1000	-	no-monitor
bpdu	-	1000	1000	-	no-monitor
bfd	-	1000	1000	-	no-monitor
sflow	-	16384	16384	-	no-monitor
dsp	-	1500	1500	-	no-monitor
vxlan	-	500	500	-	no-monitor
nhop	-	500	500	-	no-monitor
icmp-redirect	-	400	400	-	no-monitor
guest-vm	-	8000	8000	-	* no-monitor



---

## CHAPTER 36 Source Interface Commands

---

This chapter is a reference for source interface commands. The source Interface feature routes management traffic to a dedicated interface using `iptables` NAT rules.

The source interface feature is supported for the protocols shown in [Table 36-106](#).

**Table 36-106: Source interface protocols and port numbers**

Protocol	Default port number
Tacacs+	49
Radius	1812 and 1813
Snmp	161 and 162
Ntp	123
Syslog	514

Note: Because management applications are allowed only on the default and management VRF, the commands in this chapter are supported on the "management" and "default" VRFs only.

This chapter contains these commands:

- [ip source-interface](#)
- [ipv6 source-interface](#)
- [show ip source-interface detail](#)
- [show ipv6 source-interface detail](#)
- [show running-config ip source-interface](#)
- [show running-config ipv6 source-interface](#)

---

## ip source-interface

Use this command to configure the IPv4 source interface for a protocol.

Use the `no` form of this command to remove the IPv4 source interface for a protocol.

**Note:** It is possible that the router may establish an outgoing TCP connection using an interface that does not have a valid or routable IP address. In such case, the user must specify the address of a different interface to use as the source IP address for the outgoing connection. For this scenario, the command `ip source-interface` or `ipv6 source-interface` is used.

### Command Syntax

```
ip source-interface IFNAME (tacacs+|ntp|snmp|syslog|radius) (port (0|<1025-65535>)|) (vrf VRF_NAME|)
no ip source-interface IFNAME (tacacs+|ntp|snmp|syslog|radius)
```

### Parameters

IFNAME	Interface name (lo or physical interface)
tacacs+	Terminal Access Controller Access Control System
ntp	Network Time Protocol
snmp	Simple Network Management Protocol
syslog	syslog
radius	Remote Authentication Dial-In User Service
<1025-65535>	Port number. Default value is as per the protocol.
VRF_NAME	Virtual Routing and Forwarding name

### Default

The default port 0 is assigned to the protocol.

### Command Mode

Configure mode

### Applicability

This command was introduced in OcNOS version 4.0.

### Example

```
#configure terminal
(config)#ip source-interface xe1 ntp
(config)#ip source-interface xe2 radius port 1025
(config)#ip source-interface xe3 syslog port 65535 vrf management
```

---

## ipv6 source-interface

Use this command to configure the IPv6 source interface for a protocol.

Use the `no` form of this command to remove the IPv6 source interface for a protocol.

### Command Syntax

```
ipv6 source-interface IFNAME (tacacs+|ntp|snmp|syslog|radius) (port (0|<1025-65535>)|) (vrf VRF_NAME|)
```

```
no ipv6 source-interface IFNAME (tacacs+|ntp|snmp|syslog|radius)
```

### Parameters

IFNAME	Interface name (lo or physical interface)
tacacs+	Terminal Access Controller Access Control System protocol
ntp	Network Time Protocol
snmp	Simple Network Management Protocol
syslog	syslog
radius	Remote Authentication Dial-In User Service
<1025-65535>	Port number. Default value is as per the protocol.
VRF_NAME	Virtual Routing and Forwarding name

### Default

The default port 0 is assigned to the protocol.

### Command Mode

Configure mode

### Applicability

This command was introduced in OcNOS version 4.0.

### Example

```
#configure terminal
(config)#ipv6 source-interface xe1 ntp
(config)#ipv6 source-interface xe2 radius port 1025
(config)#ipv6 source-interface xe3 syslog port 65535 vrf management
```

---

## show ip source-interface detail

Use this command to display the IPv4 source interface status in detail.

### Command Syntax

```
show ip source-interface detail
```

### Parameters

None

### Command Mode

Exec mode and Privileged Exec mode

### Applicability

This command was introduced in OcnOS version 4.0.

### Example

```
#show ip source-interface detail
Source-Interface Detailed Information
=====
Protocol : tacacs+
Interface : lo
Address : 1.1.1.1
Status : Active
VRF Name : Default

Protocol : radius
Interface : lo
Address : 1.1.1.1
Status : Active
VRF Name : Default
```

[Table 36-107](#) explains the output fields.

**Table 36-107: Output fields**

Field	Description
Protocol	tacacs+, ntp, snmp, syslog, or radius
Interface	Interface name (lo or physical interface)
Address	IP address
Status	Whether active or inactive
VRF Name	Virtual Routing and Forwarding name



---

## show ipv6 source-interface detail

Use this command to display the IPv6 source interface status in detail.

### Command Syntax

```
show ipv6 source-interface detail
```

### Parameters

None

### Command Mode

Exec mode and Privileged Exec mode

### Applicability

This command was introduced in OcNOS version 4.0.

### Example

```
#show ipv6 source-interface detail
Source-Interface Detailed Information
```

```
=====
```

```
Protocol : tacacs+
Interface : lo
Address  : ::1
Status   : Active
VRF Name : Default
```

```
Protocol : radius
Interface : lo
Address  : ::1
Status   : Active
VRF Name : Default
```

[Table 36-107](#) explains the output fields.

---

## show running-config ip source-interface

Use this command to display the IPv4 source interface running configuration.

### Command Syntax

```
show running-config ip source-interface
```

### Parameters

None

### Command Mode

Exec mode and Privileged Exec mode

### Applicability

This command was introduced in OcNOS version 4.0

### Example

```
#show running-config ip source-interface
ip source-interface lo tacacs+ port 1025
ip source-interface lo radius
ip source-interface lo.management ntp vrf management
ip source-interface lo.management syslog port 1026 vrf management
ip source-interface ge3 snmp
```

---

## show running-config ipv6 source-interface

Use this command to display the IPv6 source interface running configuration.

### Command Syntax

```
show running-config ipv6 source-interface
```

### Parameters

None

### Command Mode

Exec mode and Privileged Exec mode

### Applicability

This command was introduced in OcNOS version 4.0.

### Example

```
#show running-config ipv6 source-interface
ipv6 source-interface lo tacacs+ port 1025
ipv6 source-interface lo radius
ipv6 source-interface lo.management ntp vrf management
ipv6 source-interface lo.management syslog port 1026 vrf management
ipv6 source-interface ge3 snmp
```



## CHAPTER 37 FMS Command Reference

---

This chapter describes the fault management system (FMS) commands:

- `fault-management (enable | disable)`
- `fault-management close`
- `fault-management flush-db`
- `fault-management shelve`
- `show alarm active`
- `show alarm closed`
- `show alarm history`
- `show alarm shelved`
- `show alarm statistics`
- `show alarm transitions`
- `show fms status`
- `show fms supported-alarm-types`
- `show running-config fault-management`

---

## fault-management (enable | disable)

Use this command to enable or disable the fault management system (FMS).

### Command Syntax

```
fault-management (enable | disable)
```

### Parameters

enable	Enable FMS
disable	Disable FMS

### Command Mode

Configuration mode

### Applicability

This command was introduced in OcNOS version 3.0.

### Example

Enable FMS:

```
(config)# fault-management enable
(config)#commit
%% Warning : FMS requires logging level all to be configured to minimum 4, please
configure accordingly
(config)#
```

Validation:

```
#show fms status
% FMS Status: Enabled
% FMS Node Application Status: Up
```

Disable FMS:

```
(config)# fault-management disable
(config)#commit
```

Validation:

```
#show fms status
% FMS Status: Disabled
```

---

## fault-management close

Use this command to close an active alarm.

### Command Syntax

```
fault-management close ACTIVE-ALARM-ID
```

### Parameter

ACTIVE-ALARM-ID

Identifier of an active alarm

### Command Mode

Exec and Privileged Exec mode

### Applicability

This command was introduced in OcNOS version 6.0.0.

### Example

After closing an active alarm, it should not be displayed in the active alarms list.

The alarm ID can be found with [show alarm history](#), specifying the `all` parameter.

```
#sh alarm history all
Alarm Count: 1
Severity   Alarm_Type_ID   Alarm_ID           Description
-----
MAJOR      EQPT             IFMGR_IF_DOWN::ce3/1   2019-02-18T15:07:57.755Z : OcNOS
[IFMGR_IF_DOWN] Interface ce3/1 changed state to down

#sh alarm active
Active Alarms received:-
Active Alarm Count: 1
Severity   Status   Alarm Description
-----
MAJOR      Active   OcNOS [IFMGR_IF_DOWN] Interface ce3/1 changed state to down

#
#fault-management close IFMGR_IF_DOWN::ce3/1
% FMS Response: IFMGR_IF_DOWN::ce3/1 closed
#
#sh alarm active
Active Alarms received:-
There are no active alarms present in the Database
```

---

## fault-management flush-db

Use this command to flush the alarms from the database.

### Command Syntax

```
fault-management flush-db
```

### Parameter

None

### Command Mode

Exec and Privileged Exec mode

### Applicability

This command was introduced in OcnOS version 3.0.

### Example

```
#fault-management flush-db
% FMS Response: Database flush completed
```

### Validation:

Check that after `fault-management flush-db`, all alarms in the database are flushed:

```
#show alarm active
Active Alarms received:-
There are no active alarms present in the Database
#show alarm history all
There are no alarms present in the Database
#show alarm closed
No alarms are manually closed
#show alarm shelved
No alarm-types are shelved
#show alarm statistics
There are no alarms present in the Database
#show alarm transitions
There are no transition alarms present in the Database
```



---

## fault-management shelve

Use this command to shelve (disable) an alarm type.

### Command Syntax

```
fault-management shelve ALARM-TYPE
```

### Parameter

ALARM-TYPE      Type of alarm as displayed by [show fms supported-alarm-types](#)

### Command Mode

Exec and Privileged Exec mode

### Applicability

This command was introduced in OcNOS version 6.0.0.

### Example

```
#fault-management shelve CMM_MONITOR_CPU
% FMS Response: Alarm-type CMM_MONTOR_CPU shelved.
#
```

### Validation:

Check that after shelving an alarm type, active alarms of that type are not being raised.

```
#fault-management shelve IFMGR_IF_DOWN
% FMS Response: Alarm-type IFMGR_IF_DOWN shelved.
#
#show alarm shelved
Alarm-type Count: 1
Alarm Type
-----
IFMGR_IF_DOWN
#
(config)#interface ce1/1
(config-if)#shutdown
(config-if)#commit
2019 Feb 18 15:21:31.229 : OcNOS : NSM : CRITI : [IFMGR_IF_DOWN_2]: Interface ce1/1
changed state to down
(config-if)#end
#
#show alarm history all
There are no alarms present in the Database
#show alarm active
Active Alarms received:-
There are no active alarms present in the Database
#
```

---

## show alarm active

Use this command to display the current active alarms in the database.

### Command Syntax

```
show alarm active
```

### Parameters

None

### Command Mode

Exec and Privileged Exec mode

### Applicability

This command was introduced in OcNOS version 3.0 and the output changed in OcNOS version 6.1.0.

### Example

```
#show alarm active
Active Alarms received:-
Active-Alarms-Count: 1
Alarm-Date-Time          Severity    Alarm-ID          Alarm-Description
-----
2019-02-15T19:57:14.525Z MAJOR      IFMGR_IF_DOWN::xe8  OcNOS [IFMGR_IF_DOWN]
Interface xe8 changed state to down
#
```

---

## show alarm closed

Use this command to display alarms that are manually closed.

### Command Syntax

```
show alarm closed
```

### Parameters

None

### Command Mode

Exec and Privileged Exec mode

### Applicability

This command was introduced in OcNOS version 6.0.0.

### Example

```
#show alarm closed
Alarm Count: 1
Severity   Alarm_Type_ID   Alarm_ID           Description
-----
MAJOR      EQPT              IFMGR_IF_DOWN::xe7  FMS [IFMGR_IF_DOWN] Interface xe7
changed state to down

#
```

## show alarm history

Use this command to show the alarm history.

### Command Syntax

```
show alarm history (1-day | 1-hr | 1-week | all)
```

### Parameters

1-day	Display alarms in the last 1 day
1-hr	Display alarms in the last 1 hour
1-week	Display alarms in the last 1 week
all	Display all the alarms

### Command Mode

Exec and Privileged Exec mode

### Applicability

This command was introduced in OcNOS version 3.0.

### Example

```
#show alarm history ?  
1-day  Display alarms in the last 1 day  
1-hr   Display alarms in the last 1 hour  
1-week Display alarms in the last 1 week  
all    Display all the alarms
```

---

## show alarm shelved

Use this command to display shelved (disabled) alarm types.

### Command Syntax

```
show alarm shelved
```

### Parameters

None

### Command Mode

Exec and Privileged Exec mode

### Applicability

This command was introduced in OcNOS version 6.0.0.

### Example

```
#show alarm shelved
Alarm-type Count: 1
Alarm Type
-----
IFMGR_IF_DOWN

#
```

---

## show alarm statistics

Use this command to display the alarm statistics.

### Command Syntax

```
show alarm statistics
```

### Parameters

None

### Command Mode

Exec and Privileged Exec mode

### Applicability

This command was introduced in OcNOS version 3.0.

### Example

```
#show alarm statistics
Alarm Statistics :-
Alarm Count: 1
Current Severity      Count      Alarm ID
-----
MAJOR                  1          IFMGR_IF_UP::ce3/1

#
#
```

---

## show alarm transitions

Use this command to display severity transitions for every alarm in the device.

### Command Syntax

```
show alarm transitions
```

### Parameters

None

### Command Mode

Exec and Privileged Exec mode

### Applicability

This command was introduced in OcNOS version 6.0.0.

### Example

```
#show alarm transitions
Alarms received:-
Alarm Count: 3
Downgraded      CRITI    MAJOR    CMM_MONITOR_CPU:1min_load:CPU
Upgraded        MAJOR    CRITI    CMM_MONITOR_CPU:1min_load:CPU
Downgraded      CRITI    MAJOR    CMM_MONITOR_CPU:1min_load:CPU
```

#

---

## show fms status

Use this command to display the FMS status.

### Command Syntax

```
show fms status
```

### Parameters

None

### Command Mode

Exec and Privileged Exec mode

### Applicability

This command was introduced in OcNOS version 3.0.

### Example

```
#  
#show fms status  
% FMS Status: Enabled  
% FMS Node Application Status: Up  
#
```



---

## show fms supported-alarm-types

Use this command to display the supported alarm types.

### Command Syntax

```
show fms supported-alarm-types
```

### Parameters

None

### Command Mode

Exec and Privileged Exec mode

### Applicability

This command was introduced in OcNOS version 6.0.0.

### Example

```
#show fms supported-alarm-types  
Alarm-types Count: 38
```

```
IFMGR_IF_DOWN  
IFMGR_IF_UP  
CMM_MONITOR_RAM  
CMM_MONITOR_CPU  
...  
#
```

---

## show running-config fault-management

Use this command to display FMS status in the running configuration.

### Command Syntax

```
show running-config fault-management
```

### Parameters

None

### Command Mode

Exec and Privileged Exec mode

### Applicability

This command was introduced in OcNOS version 3.0.

### Example

```
#show running-config fault-management
!  
fault-management enable  
!  
#
```

## CHAPTER 38 NetConf Call Home Commands

---

This chapter describes these commands:

- [callhome server](#)
- [debug callhome](#)
- [feature netconf callhome](#)
- [management-port](#)
- [netconf callhome](#)
- [reconnect](#)
- [retry-interval](#)
- [retry-max-attempts](#)
- [show \(xml\) running-config netconf-callhome](#)

## callhome server

Use this command to add a call home server. A maximum 5 servers can be configured.

Use the `no` form of this command to delete a call home server. If the specified call home server is already connected with the OcnOS NetConf server, deleting it will not disconnect it.

### Command Syntax

```
callhome server WORD (A.B.C.D|X:X::X:X|HOSTNAME) (port <1-65535>|)
no callhome server WORD
```

### Parameters

WORD	An arbitrary name for the NetConf listen endpoint. Any valid string with length 1-64 can be used.
A.B.C.D	IPv4 address of the call home server
X:X::X:X	IPv4 address of the call home server
HOSTNAME	Host name of the call home server
<1-65535>	Callhome server listening port

**Note:** The same address can be configured with different endpoint names, so use a different port number in those cases. For example:

```
callhome server name-1 1.1.1.1
callhome server name-2 1.1.1.1 # Avoid this is kind of redundant configuration
callhome server name-3 1.1.1.1 5555
```

### Default

Default value for the port is IANA assigned port 4334.

### Mode

NetConf call home mode

### Applicability

This command was introduced in OcnOS version 6.0.0.

### Example

```
(netconf-callhome)#do show running-config netconf-callhome
!
netconf callhome
  feature netconf callhome enable
!
(netconf-callhome)#
(netconf-callhome)#callhome server remote-client 169.154.45.12
(netconf-callhome)#callhome server nat-client 192.168.56.1 port 12234
(netconf-callhome)#commit
(netconf-callhome)#
config)#do show running-config netconf-callhome
(config)#
```

```
(netconf-callhome)#do show running-config netconf-callhome
!  
netconf callhome  
  feature netconf callhome enable  
  callhome server remote-client 169.154.45.12  
  callhome server nat-client 192.168.56.1 port 12234  
!  
(netconf-callhome)#  
(netconf-callhome)#no callhome server nat-client  
(netconf-callhome)#commit  
(netconf-callhome)#  
(netconf-callhome)#do show running-config netconf-callhome  
!  
netconf callhome  
  feature netconf callhome enable  
  callhome server remote-client 169.154.45.12  
!  
(netconf-callhome)#
```

---

## debug callhome

Use this command to enable debugging for the call home module. Once enabled, all debugging related information will be logged in the system logger file.

Use the `no` form of this command to disable debugging for the call home module.

### Command Syntax

```
debug callhome
no debug callhome
```

### Parameters

None

### Default

By default, debugging is disabled (only critical message are enabled).

### Mode

NetConf call home mode

### Applicability

This command was introduced in OcnOS version 6.0.0.

### Example

```
(config) #
(config) #netconf callhome
(netconf-callhome) #do show running-config netconf-callhome
(netconf-callhome) #
(netconf-callhome) #debug callhome
(netconf-callhome) #commit
(netconf-callhome) #
(netconf-callhome) #do show running-config netconf-callhome
!
netconf callhome
  debug callhome
!
(netconf-callhome) #no debug callhome
(netconf-callhome) #commit
(netconf-callhome) #do show running-config netconf-callhome
(netconf-callhome) #
```

---

## feature netconf callhome

Use this command to enable or disable the NetConf call home feature. When the feature is disabled, all other configurations are removed except [debug callhome](#).

Enabling the call home feature is required before doing any other call home configurations.

### Command Syntax

```
feature netconf callhome (enable|disable)
```

### Parameters

enable	Enable the call home feature
disable	Disable the call home feature

### Default

By default, the call home feature is disabled.

### Mode

NetConf call home mode

### Applicability

This command was introduced in OcNOS version 6.0.0.

### Example

```
(config)#do show running-config netconf-callhome
(config)#
(config)#netconf callhome
(netconf-callhome)#feature netconf callhome enable
(netconf-callhome)#commit
(netconf-callhome)#do show running-config netconf-callhome
!
netconf callhome
  feature netconf callhome enable
!
(netconf-callhome)#feature netconf callhome disable
(netconf-callhome)#commit
(netconf-callhome)#
(netconf-callhome)#do show running-config netconf-callhome
(netconf-callhome)#
```

---

## management-port

Use this command to add an interface to use to connect to a call home server. This is useful when in-band (front panel) ports are used as management ports.

Use the `no` form of this command to use `eth0` as the management port.

### Command Syntax

```
management-port IFNAME
no management-port
```

### Parameters

IFNAME	Interface used to connect to the call home server
--------	---

### Default

By default, `eth0` (out-of-band management port) is used as the management port.

### Mode

NetConf call home mode

### Applicability

This command was introduced in OcNOS version 6.0.0

### Example

```
(netconf-callhome)#do show running-config netconf-callhome
!
netconf callhome
  feature netconf callhome enable
!

(netconf-callhome)#management-port xe4
(netconf-callhome)#commit
(netconf-callhome)#
(netconf-callhome)#do show running-config netconf-callhome
!
netconf callhome
  feature netconf callhome enable
  management-port xe4
!
(netconf-callhome)#no management-port
(netconf-callhome)#commit
(netconf-callhome)#
(netconf-callhome)#do show running-config netconf-callhome
!
netconf callhome
  feature netconf callhome enable
!
(netconf-callhome)#
```



---

## netconf callhome

Use this command to enter NetConf call home configuration mode. All call home configurations are done in this mode.

### Command Syntax

```
netconf callhome
```

### Mode

Configure mode

### Applicability

This command was introduced in OcNOS version 6.0.0.

### Example

```
(config)#netconf callhome  
(netconf-callhome)#
```

---

## reconnect

Use this command to enable or disable the reconnect feature. If disabled, OcNOS only tries once and if it fails, the connection will not be re-attempted.

### Command Syntax

```
reconnect (enable|disable)
```

### Parameters

enable	Enable reconnect
disable	Disable reconnect

### Default

By default, the reconnect feature is not enabled.

### Mode

NetConf call home mode

### Applicability

This command was introduced in OcNOS version 6.0.0.

### Example

```
(netconf-callhome)#do show running-config netconf-callhome
!  
netconf callhome  
  feature netconf callhome enable  
!  
(netconf-callhome)#reconnect enable  
(netconf-callhome)#commit  
(netconf-callhome)#do show running-config netconf-callhome  
!  
netconf callhome  
  feature netconf callhome enable  
  reconnect enable  
!  
(netconf-callhome)#retry-max-attempts 10  
(netconf-callhome)#retry-interval 30  
(netconf-callhome)#commit  
(netconf-callhome)#  
(netconf-callhome)#do show running-config netconf-callhome  
!  
netconf callhome  
  feature netconf callhome enable  
  reconnect enable  
  retry-max-attempts 10  
  retry-interval 30  
!
```

```
(netconf-callhome)#reconnect disable
(netconf-callhome)#commit
(netconf-callhome)#
(netconf-callhome)#do show running-config netconf-callhome
!
netconf callhome
  feature netconf callhome enable
!
(netconf-callhome)#
```

---

## retry-interval

Use this command to specify the number of seconds to wait after a connect attempt to the call home server fails.

Use the `no` form of this command to reset the retry interval to its default (300 seconds).

### Command Syntax

```
retry-interval <1-86400>
no retry-interval
```

### Parameters

<1-86400>	Retry interval in seconds
-----------	---------------------------

### Default

By default, when the [reconnect](#) feature is enabled, the default retry interval is 300 seconds.

### Mode

NetConf call home mode

### Applicability

This command was introduced in OcNOS version 6.0.0.

### Example

```
(netconf-callhome)#do show running-config netconf-callhome
!
netconf callhome
  feature netconf callhome enable
  reconnect enable
!

(netconf-callhome)#retry-interval 100
(netconf-callhome)#commit
(netconf-callhome)#
(netconf-callhome)#do show running-config netconf-callhome
!
netconf callhome
  feature netconf callhome enable
  reconnect enable
  retry-interval 100
!
(netconf-callhome)#

(netconf-callhome)#no retry-interval
(netconf-callhome)#commit
(netconf-callhome)#
(netconf-callhome)#do show running-config netconf-callhome
!
netconf callhome
```

```
feature netconf callhome enable
reconnect enable
!
(netconf-callhome)#
```

## retry-max-attempts

Use this command to specify the number of retries the OcnOS should attempt to the call home server before giving up. Use the `no` form of this command to reset the maximum attempts to its default (3).

### Command Syntax

```
retry-max-attempts <0-255>
no retry-max-attempts
```

### Parameters

<0-255>                    Number of retries; specify zero (0) to retry infinitely

### Default

By default, when the [reconnect](#) feature is enabled, 3 attempts will be made.

### Mode

NetConf call home mode

### Applicability

This command was introduced in OcnOS version 6.0.0.

When reconnect parameters are updated:

- Servers for which the configured retry count has not completed, with updated configurations, those will also get counted.
- Servers for which the configured retry count has already completed, new configuration will restart retrieval.

### Example

```
(netconf-callhome)#do show running-config netconf-callhome
!
netconf callhome
  feature netconf callhome enable
  reconnect enable
!

(netconf-callhome)#retry-max-attempts 10
(netconf-callhome)#commit
(netconf-callhome)#do show running-config netconf-callhome
!
netconf callhome
  feature netconf callhome enable
  reconnect enable
  retry-max-attempts 10
!

(netconf-callhome)#no retry-max-attempts
(netconf-callhome)#commit
(netconf-callhome)#
```

```
(netconf-callhome)#do show running-config netconf-callhome
!  
netconf callhome  
  feature netconf callhome enable  
  reconnect enable  
!  
(netconf-callhome)#
```

## show (xml) running-config netconf-callhome

Use this command to display call home configurations.

### Command Syntax

```
show (xml) running-config netconf-callhome
```

### Parameters

xml	Display the output in XML format
-----	----------------------------------

### Mode

Exec mode

### Applicability

This command was introduced in OcNOS version 6.0.0.

### Example

```
#show running-config netconf-callhome
```

```
!
```

```
netconf callhome
  feature netconf callhome enable
  management-port xe10
  reconnect enable
  retry-max-attempts 10
  retry-interval 100
  callhome server local-nc 192.168.56.1
  debug callhome
```

```
!
```

```
#show xml running-config netconf-server
```

```
<netconf-server xmlns="http://www.ipinfusion.com/yang/ocnos/ipi-management-server">
  <callhome>
    <feature-enabled></feature-enabled>
    <management-port>xe10</management-port>
    <netconf-client>
      <name>local-nc</name>
      <address>192.168.56.1</address>
    </netconf-client>
    <reconnect>
      <enable></enable>
      <retry-max-attempts>10</retry-max-attempts>
      <retry-interval>100</retry-interval>
    </reconnect>
  </callhome>
  <debug>
    <callhome-debug></callhome-debug>
  </debug>
</netconf-server>
```



## CHAPTER 39 OSPFv3 IPsec Authentication Commands

---

This chapter is a reference for the Internet Protocol Security (IPsec) commands for OSPFv3 authentication.

- [crypto ipsec transform-set](#)
- [crypto map](#)
- [set peer](#)
- [set session-key](#)
- [set transform-set](#)
- [sequence](#)
- [show crypto ipsec transform-set](#)

---

## crypto ipsec transform-set

Use this command to configure a transform set that defines protocols and algorithm settings to apply to IPsec protected traffic.

During the IPsec security association negotiation, the peers agree to use a particular transform-set to be used for protecting a particular data flow.

Several transform-sets can be specified and associated with a crypto map entry.

A transform set defines the IPsec security protocols: Encapsulation Security Protocol (ESP) or Authentication Header (AH), and also specifies which algorithms to use with the selected security protocol.

### Command Syntax

```
crypto ipsec transform-set NAME ah (none|ah-md5|ah-sha1|ah-sha256|ah-sha384|ah-
sha512)
crypto ipsec transform-set NAME esp-auth (none|esp-md5|esp-sha1|esp-
sha256|espsa384|esp-sha512) esp-enc (esp-null|esp-3des|esp-aes|esp-aes192|esp-
aes256|espb1f|esp-blf192|esp-blf256|esp-cast)
crypto ipsec transform-set NAME mode (transport)
no crypto ipsec transform-set NAME mode
no crypto ipsec transform-set NAME
```

### Parameters

NAME	Name of the transform set.
mode	Change the transform-set mode to tunnel or transport.
transport	The payload (data) of the original IP packet is protected.
ah	Authentication Header protocol provides data authentication.
none	No authentication.
ah-md5	Authentication Header with Message Digest 5 (MD5) Hashed Message Authentication Code (HMAC) variant.
ah-sha1	Authentication Header with Secure Hash Algorithm 1 (SHA-1) Hashed Message Authentication Code (HMAC) variant.
ah-sha256	Authentication Header with Secure Hash Algorithm 256 (SHA-256) Hashed Message Authentication Code (HMAC) variant.
ah-sha384	Authentication Header with Secure Hash Algorithm 384 (SHA-384) Hashed Message Authentication Code (HMAC) variant.
ah-sha512	Authentication Header with Secure Hash Algorithm 512 (SHA-512) Hashed Message Authentication Code (HMAC) variant.
esp-auth	Encapsulating Security Payload authentication protocol provides data authentication.
none	No authentication.
esp-md5	Encapsulating Security Payload with Message Digest 5 (MD5) Hashed Message Authentication Code (HMAC) variant.
esp-sha1	Encapsulating Security Payload with Secure Hash Algorithm 1 (SHA-1) Hashed Message Authentication Code (HMAC) variant.

---

esp-sha256	Encapsulating Security Payload with Secure Hash Algorithm 256 (SHA-256) Hashed Message Authentication Code (HMAC) variant.
esp-sha384	Encapsulating Security Payload with Secure Hash Algorithm 384 (SHA-384) Hashed Message Authentication Code (HMAC) variant.
esp-sha512	Encapsulating Security Payload with Secure Hash Algorithm 512 (SHA-512) Hashed Message Authentication Code (HMAC) variant.
esp-enc	Encapsulating Security Payload encryption protocol
esp-null	Encapsulating Security Payload null encryption.
esp-3des	Encapsulating Security Payload with 168-bit DES encryption (3DES or Triple DES).
esp-aes	Alternative AES.
esp-aes192	Alternative AES192.
esp-aes256	Alternative AES256.
esp-blf	Alternative Blowfish.
esp-blf192	Alternative Blowfish192.
esp-blf256	Alternative Blowfish256.
esp-cast	Alternative Cast (IKEv1 not supported).

## Command Mode

Configure mode

## Example

```
#configure terminal
(config)#crypto ipsec transform-set TEST_ESP esp-auth esp-md5 esp-enc esp-3des
(config)#crypto ipsec transform-set TEST_AH ah ah-sha512
```

---

## crypto map

Use this command to create or change a crypto map entry and enter crypto map configuration mode.

Use the `no` form of this command to delete a crypto map entry or set.

### Command Syntax

```
crypto map MAP-NAME ipsec-manual
no crypto map MAP-NAME
```

### Parameters

<code>MAP-NAME</code>	Name of the crypto map set (maximum length 127).
<code>ipsec-manual</code>	Do not use IKE to establish IPsec security associations.

### Command Mode

Configure mode

### Example

```
(config)#crypto map MAP1 ipsec-manual
(config-crypto)#
```

---

## set peer

Use this command to specify an IPsec peer IPv4 or IPv6 for a crypto map.

Use the `no` form of this command to remove an IPsec peer from a crypto map entry.

### Command syntax

```
set peer (A.B.C.D | X:X::X:X) (spi (<0-4096>|))
no set peer (A.B.C.D | X:X::X:X)
```

### Parameters

A.B.C.D	IPv4 peer address
X:X:X:X	IPv6 peer address
spi	Specifies the security parameter index (SPI), a number that is used to uniquely identify a security association.
<0-4096>	Security parameter index (SPI) range

### Default

None

### Command Mode

Crypto map sequence mode

### Applicability

This command is introduced in OcNOS version 6.0.0

### Examples

```
#configure terminal
(config)#crypto map MAP1 ipsec-manual
(config-crypto)#sequence 1
(config-crypto-seq)#set transform-set TEST_ESP
(config-crypto-seq)#set peer fe80::3617:ebff:fe0e:1222 spi 200
```

## set session-key

Use this command to define IPsec keys for security associations via ipsec-manual crypto map entries.

When you define multiple IPsec session keys within a single crypto map, you can assign the same security parameter index (SPI) number to all the keys. The SPI is used to identify the security association used with the crypto map.

Session keys at one peer must match the session keys at the remote peer.

### Command syntax

```
set session-key (inbound|outbound) esp SPI cipher HEX-KEY-DATA authenticator HEX-KEY-DATA
no set session-key (inbound|outbound) esp SPI
```

### Parameters

inbound	Sets the inbound IPsec session key. Both inbound and outbound keys must be set.
outbound	Sets the outbound IPsec session key. Both inbound and outbound keys must be set.
esp	Sets the IPsec session key for the Encapsulation Security Protocol.
SPI	Specifies the security parameter index (SPI), a number that is used to uniquely identify a security association.
cipher	Indicates that the key string is to be used with the ESP encryption.
HEX-KEY-DATA	Specifies the session key in hexadecimal format.
authenticator	Indicates that the key string is to be used with the ESP authentication.

### Default

None

### Command Mode

Crypto map sequence mode

### Applicability

This command is introduced in OcNOS version 6.0.0

### Examples

```
#configure terminal
(config)#crypto map MAP1 ipsec-manual
(config-crypto)#sequence 1
(config-crypto-seq)#set session-key outbound esp 200 cipher
1234567812345678123456781234567812345678123456781234567812345678 authenticator
123456781234567812345678
(config-crypto-seq)#set session-key inbound esp 200 cipher
12345678123456781234567812345678123456781234567812345678 authenticator
123456781234567812345678
```

---

## set transform-set

Use this command to specify which transform sets to include in a crypto map entry.

Use no form of this command to unset the transform set.

### Command syntax

```
set transform-set NAME
no set transform-set NAME
```

### Parameters

NAME	Transform-set name
------	--------------------

### Default

None

### Command Mode

Crypto map sequence mode

### Applicability

This command is introduced in OcNOS version 6.0.0

### Examples

```
#configure terminal
(config)#crypto map MAP1 ipsec-manual
(config-crypto)#sequence 1
(config-crypto-seq)#set transform-set TEST_ESP
```

---

## sequence

The number you assign to the seq-num will be used to rank multiple crypto map entries within a crypto map set. This number defines the priority of crypto-map evaluation within a crypto map set.

### Command syntax

```
sequence <1-65535>
no sequence <1-65535>
```

### Parameters

<1-65535>      Value for crypto map sequence number

### Default

None

### Command Mode

Crypto map mode

### Applicability

This command is introduced in OcNOS version 6.0.0

### Examples

```
#configure terminal
(config)#crypto map MAP1 ipsec-manual
(config-crypto)#sequence 1
(config-crypto-seq)#
```



---

## show crypto ipsec transform-set

Use this command to show the IPsec transform-set entries.

### Command syntax

```
show crypto ipsec transform-set NAME
```

### Parameters

NAME	Transform-set name
------	--------------------

### Default

None

### Command Mode

Exec mode and Privileged Exec mode

### Applicability

This command is introduced in OcNOS version 6.0.0

### Examples

```
#show crypto ipsec transform-set TEST_ESP
Transform set t3
Mode is Transport
Algorithm none esp-3des esp-md5
```



---

## CHAPTER 40 QSFP-DD Laser Configuration and Status

---

This chapter is a reference for the QSFP-DD configuration and status commands:

- [application](#)
- [laser channel](#)
- [laser grid](#)
- [laser fine-tune-freq](#)
- [laser output-power](#)
- [loopback](#)
- [prbs](#)
- [qsfp-dd](#)
- [show qsfp-dd advertisement applications](#)
- [show qsfp-dd advertisement controls](#)
- [show qsfp-dd advertisement diagnostics host](#)
- [show qsfp-dd advertisement diagnostics media](#)
- [show qsfp-dd advertisement diagnostics module](#)
- [show qsfp-dd advertisement durations](#)
- [show qsfp-dd advertisement laser](#)
- [show qsfp-dd advertisement monitors host](#)
- [show qsfp-dd advertisement monitors media](#)
- [show qsfp-dd advertisement monitors module](#)
- [show qsfp-dd advertisement pages](#)
- [show qsfp-dd application](#)
- [show qsfp-dd diagnostics host](#)
- [show qsfp-dd diagnostics media](#)
- [show qsfp-dd eeprom](#)
- [show qsfp-dd laser grid](#)
- [show qsfp-dd laser grid](#)
- [show qsfp-dd monitors host](#)
- [show qsfp-dd monitors media](#)
- [show qsfp-dd monitors module](#)
- [show qsfp-dd state](#)

## application

Use this command to select the application ID to be configured for this QSFP-DD module.

Use the `no` parameter with this command to remove this configuration. If no application is configured then application ID 1 will be selected as per module default.

Note: Only 400G application modes are supported.

Note: For checking the supported applications modes show `qsfp-dd <port no.> advertisement applications` command, see the example.

### Example:

```
OcNOS#show qsfp-dd 49 application
```

```
Port Number                : 49
-----
User Config   |   H/W Config
-----
Application 2 |   Application 2
```

```
OcNOS#sh qsfp-dd 49 advertisement applications
```

```
Port Number                : 49
> Application 1:
  | Host |
    Interface                : 400GAUI-8 C2M
    Application BR           : 425.00
    Lane Count               : 8
    Lane Sig BR              : 26.5625
    Modulation Format         : PAM4
    Bits Per Unit Intvl     : 2.000000
    Lane Assigned            : Lane-1
  | Media |
    Interface                : 400ZR, DWDM, Amplified
    Application BR           : 478.75
    Lane Count               : 1
    Lane Sig BR              : 59.84375
    Modulation Format         : DP-16QAM
    Bits Per Unit Intvl     : 8.000000
    Lane Assigned            : Lane-1
Application 2:
  | Host |
    Interface                : 400GAUI-8 C2M
    Application BR           : 425.00
    Lane Count               : 8
    Lane Sig BR              : 26.5625
    Modulation Format         : PAM4
    Bits Per Unit Intvl     : 2.000000
    Lane Assigned            : Lane-1
  | Media |
    Interface                : 400ZR, Single Wavelen., Unamp.
    Application BR           : 478.75
    Lane Count               : 1
    Lane Sig BR              : 59.84375
    Modulation Format         : DP-16QAM
```

```

        Bits Per Unit Intvl : 8.000000
        Lane Assigned       : Lane-1
Application 3:
  | Host |
    Interface           : 100GAUI-2 C2M
    Application BR      : 106.25
    Lane Count         : 2
    Lane Sig BR        : 26.5625
    Modulation Format   : PAM4
    Bits Per Unit Intvl : 2.000000
    Lane Assigned      : Lane-7/Lane-5/Lane-3/Lane-1
  | Media |
    Interface           : 400ZR, DWDM, Amplified
    Application BR      : 478.75
    Lane Count         : 1
    Lane Sig BR        : 59.84375
    Modulation Format   : DP-16QAM
    Bits Per Unit Intvl : 8.000000
    Lane Assigned      : Lane-1
Application 4:
  | Host |
    Interface           : 400GAUI-8 C2M
    Application BR      : 425.00
    Lane Count         : 8
    Lane Sig BR        : 26.5625
    Modulation Format   : PAM4
    Bits Per Unit Intvl : 2.000000
    Lane Assigned      : Lane-1
  | Media |
    Interface           : ZR400-OFEC-16QAM
    Application BR      : 481.108374
    Lane Count         : 1
    Lane Sig BR        : 60.1385468
    Modulation Format   : DP-16QAM
    Bits Per Unit Intvl : 8.000000
    Lane Assigned      : Lane-1
Application 5:
  | Host |
    Interface           : 100GAUI-2 C2M
    Application BR      : 106.25
    Lane Count         : 2
    Lane Sig BR        : 26.5625
    Modulation Format   : PAM4
    Bits Per Unit Intvl : 2.000000
    Lane Assigned      : Lane-7/Lane-5/Lane-3/Lane-1
  | Media |
    Interface           : ZR400-OFEC-16QAM
    Application BR      : 481.108374
    Lane Count         : 1
    Lane Sig BR        : 60.1385468
    Modulation Format   : DP-16QAM
    Bits Per Unit Intvl : 8.000000
    Lane Assigned      : Lane-1
Application 6:
  | Host |
    Interface           : 100GAUI-2 C2M
    Application BR      : 106.25

```

## QSFP-DD Laser Configuration and Status

---

```

    Lane Count           : 2
    Lane Sig BR          : 26.5625
    Modulation Format     : PAM4
    Bits Per Unit Intvl  : 2.000000
    Lane Assigned        : Lane-7/Lane-5/Lane-3/Lane-1
| Media |
    Interface            : ZR300-OFEC-8QAM
    Application BR       : 360.831281
    Lane Count           : 1
    Lane Sig BR          : 60.1385468
    Modulation Format     : DP-8QAM
    Bits Per Unit Intvl  : 6.000000
    Lane Assigned        : Lane-1
Application 7:
| Host |
    Interface            : 100GAUI-2 C2M
    Application BR       : 106.25
    Lane Count           : 2
    Lane Sig BR          : 26.5625
    Modulation Format     : PAM4
    Bits Per Unit Intvl  : 2.000000
    Lane Assigned        : Lane-7/Lane-5/Lane-3/Lane-1
| Media |
    Interface            : ZR200-OFEC-QPSK
    Application BR       : 240.554187
    Lane Count           : 1
    Lane Sig BR          : 60.1385468
    Modulation Format     : DP-QPSK
    Bits Per Unit Intvl  : 4.000000
    Lane Assigned        : Lane-1
Application 8:
| Host |
    Interface            : 100GAUI-2 C2M
    Application BR       : 106.25
    Lane Count           : 2
    Lane Sig BR          : 26.5625
    Modulation Format     : PAM4
    Bits Per Unit Intvl  : 2.000000
    Lane Assigned        : Lane-7/Lane-5/Lane-3/Lane-1
| Media |
    Interface            : ZR100-OFEC-QPSK
    Application BR       : 120.277094
    Lane Count           : 1
    Lane Sig BR          : 30.069273
    Modulation Format     : DP-QPSK
    Bits Per Unit Intvl  : 4.000000
    Lane Assigned        : Lane-1
```

## Command Syntax

```
application <2-15>
```

## Parameters

```
<2-15>           Configurable application IDs
```

**Command Mode**

QSFP-DD mode

**Default**

By default, application ID 1 is selected.

**Applicability**

This command was introduced before OcNOS version 6.1.0.

**Example**

```
#configure terminal
(config)#qsfp-dd 0
(config-qsfp-dd)#application 8
(config-qsfp-dd)#commit
(config-qsfp-dd)#no application
(config-qsfp-dd)#commit
(config-qsfp-dd)#
```

---

## laser channel

Use this command to configure the laser channel number for the QSFP-DD module.

### Command Syntax

```
laser channel NUMBER
no laser channel
```

### Parameters

NUMBER                    channel number

### Default

None.

### Command Mode

QSFP-DD mode

### Applicability

This command was introduced in OcNOS version 6.2.0.

### Examples

```
#configure terminal
(config)#qsfp-dd 0
(config-qsfp-dd)#laser channel 10
(config-qsfp-dd)#commit
(config-qsfp-dd)#no laser channel
(config-qsfp-dd)#commit
(config-qsfp-dd)#
```



## laser grid

Use this command to configure the laser grid spacing frequency for the QSFP-DD module.

### Command Syntax

```
laser grid (3p125|6p25|12p5|25|33|50|75|100)
no laser grid
```

### Parameters

3p125	3.125 GHz
6p25	6.25 GHz
12p5	12.5 GHz
25	25 GHz
33	33 GHz
50	50 GHz
75	75 GHz
100	100 GHz

### Default

None.

### Command Mode

QSFP-DD mode

### Applicability

This command was introduced in OcNOS version 6.2.0.

### Examples

```
#configure terminal
(config)#qsfp-dd 0
(config-qsfp-dd)#laser grid 50
(config-qsfp-dd)#commit
(config-qsfp-dd)#no laser grid
(config-qsfp-dd)#commit
(config-qsfp-dd)#
```

---

## laser fine-tune-freq

Use this command to configure the laser fine tune frequency offset for the QSFP-DD module.

### Command Syntax

```
laser fine-tune-freq VALUE
no laser fine-tune-freq
```

### Parameters

VALUE	Fine tune frequency offset in GHz
-------	-----------------------------------

### Default

None.

### Command Mode

QSFP-DD mode

### Applicability

This command was introduced in OcNOS version 6.2.0.

### Examples

```
#configure terminal
(config)#qsfp-dd 0
(config-qsfp-dd)#laser fine-tune-freq 1.5
(config-qsfp-dd)#commit
(config-qsfp-dd)#no laser fine-tune-freq
(config-qsfp-dd)#commit
(config-qsfp-dd)#
```

---

## laser output-power

Use this command to configure the laser target output power for the QSFP-DD module.

### Command Syntax

```
laser output-power VALUE
no laser output-power
```

### Parameters

VALUE	Laser target output power
-------	---------------------------

### Default

None.

### Command Mode

QSFP-DD mode

### Applicability

This command was introduced in OcNOS version 6.2.0.

### Examples

```
#configure terminal
(config)#qsfp-dd 0
(config-qsfp-dd)#laser output-power -9.2
(config-qsfp-dd)#commit
(config-qsfp-dd)#no laser output-power
(config-qsfp-dd)#commit
(config-qsfp-dd)#
```

---

## loopback

Use this command to configure the loopback type (input, output, both) on the QSFP-DD module host/media side. If the loopback type is supported by the QSFP-DD module this will enable the loopback function.

Use the `no` parameter to remove this configuration and disable the loopback function.

### Command Syntax

```
loopback (in|out|both) (host|media)
no loopback (host|media)
```

### Parameters

<code>in</code>	Configure input loopback
<code>out</code>	Configure output loopback
<code>both</code>	Configure input and output loopback
<code>host</code>	Configure host side
<code>media</code>	Configure media side

### Command Mode

QSFP-DD mode

### Applicability

This command was introduced before OcNOS version 6.1.0.

### Example

```
(config)#qsfp-dd 0
(config-qsfp-dd)#loopback in host
(config-qsfp-dd)#loopback out media
(config-qsfp-dd)#commit
(config-qsfp-dd)#loopback both media
(config-qsfp-dd)#no loopback host
(config-qsfp-dd)#commit
(config-qsfp-dd)#
```

---

## prbs

Use these commands to configure the PRBS pattern generator/checker type to be used for diagnostics of the QSFP-DD module host/media side and to configure the PRBS pattern generator/checker location (pre-fec/post-fec) on the QSFP-DD module host/media side. If the generator/checker pattern type and location are supported by the QSFP-DD module this will enable the selected function.

Use the `no` parameter to remove this configuration and disable the generator/checker function.

### Command Syntax

```
prbs (generator|checker) type (31q|31|23q|23|15q|15|13q|13|9q|9|7q|7|ssprq)
    (host|media)

prbs (generator|checker) (pre-fec|post-fec) (host|media)

no prbs (generator|checker) type (host|media)

no prbs (generator|checker) (host|media)
```

### Parameters

<code>generator</code>	Configure the pattern generator
<code>checker</code>	Configure the pattern checker
<code>31q</code>	Configure PRBS-31Q type
<code>31</code>	Configure PRBS-31 type
<code>23q</code>	Configure PRBS-23Q type
<code>23</code>	Configure PRBS-23 type
<code>15q</code>	Configure PRBS-15Q type
<code>15</code>	Configure PRBS-15 type
<code>13q</code>	Configure PRBS-13Q type
<code>13</code>	Configure PRBS-13 type
<code>9q</code>	Configure PRBS-9Q type
<code>9</code>	Configure PRBS-9 type
<code>7q</code>	Configure PRBS-7q type
<code>7</code>	Configure PRBS-7 type
<code>ssprq</code>	Configure SSPRQ type
<code>pre-fec</code>	Configure to generate before the FEC encoder / check before the FEC decoder
<code>post-fec</code>	Configure to generate after the FEC encoder / check after the FEC decoder
<code>host</code>	Configure host side
<code>media</code>	Configure media side

### Command Mode

QSFP-DD mode

### Applicability

This command was introduced before OcNOS version 6.1.0.

## Example

```
#configure terminal
(config)#qsfp-dd 0
(config-qsfp-dd)#prbs generator type 15 host
(config-qsfp-dd)#prbs checker type 23q host
(config-qsfp-dd)#prbs generator type 7q media
(config-qsfp-dd)#prbs checker type ssprq media
(config-qsfp-dd)#commit
(config-qsfp-dd)#no prbs generator type host
(config-qsfp-dd)#no prbs checker type media
(config-qsfp-dd)#commit
(config-qsfp-dd)#
```

## qsfp-dd

Use this command to select a QSFP-DD port to configure and enter the `qsfp-dd` command mode. Use the `exit` command to quit from this mode.

### Command Syntax

```
qsfp-dd PORTNUM
```

### Parameters

PORTNUM                      QSFP-DD front panel port number

### Command Mode

Configure mode

### Applicability

This command was introduced before OcNOS version 6.1.0.

### Example

```
#configure terminal
(config)#qsfp-dd 0
(config-qsfp-dd)#
```

## show qsfp-dd advertisement applications

Use this command to show QSFP-DD module advertised applications.

### Command Syntax

```
show qsfp-dd PORTNUM advertisement applications
```

### Parameters

PORTNUM            QSFP-DD front panel port number

### Command Mode

Exec mode and Privileged Exec mode

### Applicability

This command was introduced before OcNOS version 6.1.0.

### Example

```
show qsfp-dd 0 advertisement applications
```

```
Port Number                                   : 0
> Application 1:
  | Host |
    Interface                                 : 400GAUI-8 C2M
    Application BR                            : 425.00
    Lane Count                                : 8
    Lane Sig BR                               : 26.5625
    Modulation Format                         : PAM4
    Bits Per Unit Intvl                      : 2
    Lane Assigned                             : Lane-1
  | Media |
    Interface                                 : 400ZR, DWDM, Amplified
    Application BR                            : 478.75
    Lane Count                                : 1
    Lane Sig BR                               : 59.84375
    Modulation Format                         : DP-16QAM
    Bits Per Unit Intvl                      : 8
    Lane Assigned                             : Lane-1
Application 2:
  | Host |
    Interface                                 : 400GAUI-8 C2M
    Application BR                            : 425.00
    Lane Count                                : 8
    Lane Sig BR                               : 26.5625
    Modulation Format                         : PAM4
    Bits Per Unit Intvl                      : 2
    Lane Assigned                             : Lane-1
  | Media |
    Interface                                 : 400ZR, Single Wavelen., Unamp.
    Application BR                            : 478.75
    Lane Count                                : 1
    Lane Sig BR                               : 59.84375
    Modulation Format                         : DP-16QAM
```



```

        Bits Per Unit Intvl : 8
        Lane Assigned       : Lane-1
Application 3:
  | Host |
    Interface           : 100GAUI-2 C2M
    Application BR       : 106.25
    Lane Count           : 2
    Lane Sig BR          : 26.5625
    Modulation Format     : PAM4
    Bits Per Unit Intvl : 2
    Lane Assigned        : Lane-7/Lane-5/Lane-3/Lane-1
  | Media |
    Interface           : 400ZR, DWDM, Amplified
    Application BR       : 478.75
    Lane Count           : 1
    Lane Sig BR          : 59.84375
    Modulation Format     : DP-16QAM
    Bits Per Unit Intvl : 8
    Lane Assigned        : Lane-1
Application 4:
  | Host |
    Interface           : 400GAUI-8 C2M
    Application BR       : 425.00
    Lane Count           : 8
    Lane Sig BR          : 26.5625
    Modulation Format     : PAM4
    Bits Per Unit Intvl : 2
    Lane Assigned        : Lane-1
  | Media |
    Interface           : 400ZRP, DWDM, amplified 120Km
    Application BR       : 481.108374
    Lane Count           : 1
    Lane Sig BR          : 60.1385468
    Modulation Format     : DP-16QAM
    Bits Per Unit Intvl : 8
    Lane Assigned        : Lane-1
Application 5:
  | Host |
    Interface           : 400GAUI-8 C2M
    Application BR       : 425.00
    Lane Count           : 8
    Lane Sig BR          : 26.5625
    Modulation Format     : PAM4
    Bits Per Unit Intvl : 2
    Lane Assigned        : Lane-1
  | Media |
    Interface           : 400ZRP, DWDM, Amplified 450Km
    Application BR       : 481.108374
    Lane Count           : 1
    Lane Sig BR          : 60.1385468
    Modulation Format     : DP-16QAM
    Bits Per Unit Intvl : 8
    Lane Assigned        : Lane-1
Application 6:
  | Host |
    Interface           : 100GAUI-2 C2M
    Application BR       : 106.25

```

## QSFP-DD Laser Configuration and Status

---

```

    Lane Count           : 2
    Lane Sig BR          : 26.5625
    Modulation Format     : PAM4
    Bits Per Unit Intvl  : 2
    Lane Assigned        : Lane-7/Lane-5/Lane-3/Lane-1
| Media |
    Interface           : 400ZRP, DWDM, Amplified 450Km
    Application BR      : 481.108374
    Lane Count          : 1
    Lane Sig BR         : 60.1385468
    Modulation Format    : DP-16QAM
    Bits Per Unit Intvl : 8
    Lane Assigned       : Lane-1
Application 7:
| Host |
    Interface           : 100GAUI-2 C2M
    Application BR      : 106.25
    Lane Count          : 2
    Lane Sig BR         : 26.5625
    Modulation Format    : PAM4
    Bits Per Unit Intvl : 2
    Lane Assigned       : Lane-7/Lane-5/Lane-3/Lane-1
| Media |
    Interface           : 100ZRP, DWDM, Amplified 600Km
    Application BR      : 360.831281
    Lane Count          : 1
    Lane Sig BR         : 60.1385468
    Modulation Format    : DP-8QAM
    Bits Per Unit Intvl : 6
    Lane Assigned       : Lane-1
Application 8:
| Host |
    Interface           : 400GAUI-8 C2M
    Application BR      : 425.00
    Lane Count          : 8
    Lane Sig BR         : 26.5625
    Modulation Format    : PAM4
    Bits Per Unit Intvl : 2
    Lane Assigned       : Lane-1
| Media |
    Interface           : 400ZRP, DWDM, amplified 450Km (Enhanced
Constellation)
    Application BR      : 481.108374
    Lane Count          : 1
    Lane Sig BR         : 60.1385468
    Modulation Format    : DP-16QAM
    Bits Per Unit Intvl : 8
    Lane Assigned       : Lane-1
Application 9:
| Host |
    Interface           : 100GAUI-2 C2M
    Application BR      : 106.25
    Lane Count          : 2
    Lane Sig BR         : 26.5625
    Modulation Format    : PAM4
    Bits Per Unit Intvl : 2
    Lane Assigned       : Lane-7/Lane-5/Lane-3/Lane-1
```

```

    | Media |
      Interface           : 400ZRP, DWDM, amplified 450Km (Enhanced
Constellation)
      Application BR      : 481.108374
      Lane Count         : 1
      Lane Sig BR        : 60.1385468
      Modulation Format   : DP-16QAM
      Bits Per Unit Intvl : 8
      Lane Assigned      : Lane-1
Application 10:
    | Host |
      Interface           : 100GAUI-2 C2M
      Application BR      : 106.25
      Lane Count         : 2
      Lane Sig BR        : 26.5625
      Modulation Format   : PAM4
      Bits Per Unit Intvl : 2
      Lane Assigned      : Lane-7/Lane-5/Lane-3/Lane-1
    | Media |
      Interface           : 100ZRP, DWDM, amplified 600Km (Enhanced
Constellation)
      Application BR      : 360.831281
      Lane Count         : 1
      Lane Sig BR        : 60.1385468
      Modulation Format   : DP-8QAM
      Bits Per Unit Intvl : 6
      Lane Assigned      : Lane-1
Application 11:
    | Host |
      Interface           : 100GAUI-2 C2M
      Application BR      : 106.25
      Lane Count         : 2
      Lane Sig BR        : 26.5625
      Modulation Format   : PAM4
      Bits Per Unit Intvl : 2
      Lane Assigned      : Lane-7/Lane-5/Lane-3/Lane-1
    | Media |
      Interface           : 100ZRP, DWDM, Amplified 1000Km
      Application BR      : 240.554187
      Lane Count         : 1
      Lane Sig BR        : 60.1385468
      Modulation Format   : DP-QPSK
      Bits Per Unit Intvl : 4
      Lane Assigned      : Lane-1
Application 12:
    | Host |
      Interface           : CAUI-4 C2M without FEC
      Application BR      : 103.13
      Lane Count         : 4
      Lane Sig BR        : 25.78125
      Modulation Format   : NRZ
      Bits Per Unit Intvl : 1
      Lane Assigned      : Lane-5/Lane-1
    | Media |
      Interface           : 100ZRP, DWDM, Amplified 1000Km
      Application BR      : 240.554187
      Lane Count         : 1

```

## QSFP-DD Laser Configuration and Status

---

```

    Lane Sig BR           : 60.1385468
    Modulation Format      : DP-QPSK
    Bits Per Unit Intvl   : 4
    Lane Assigned         : Lane-1
Application 13:
  | Host |
    Interface             : 100GAUI-2 C2M
    Application BR        : 106.25
    Lane Count            : 2
    Lane Sig BR           : 26.5625
    Modulation Format      : PAM4
    Bits Per Unit Intvl   : 2
    Lane Assigned         : Lane-7/Lane-5/Lane-3/Lane-1
  | Media |
    Interface             : 100ZRP, DWDM, amplified 2000Km
    Application BR        : 120.277094
    Lane Count            : 1
    Lane Sig BR           : 30.069273
    Modulation Format      : DP-QPSK
    Bits Per Unit Intvl   : 4
    Lane Assigned         : Lane-1
Application 14:
  | Host |
    Interface             : CAUI-4 C2M without FEC
    Application BR        : 103.13
    Lane Count            : 4
    Lane Sig BR           : 25.78125
    Modulation Format      : NRZ
    Bits Per Unit Intvl   : 1
    Lane Assigned         : Lane-5/Lane-1
  | Media |
    Interface             : 100ZRP, DWDM, amplified 2000Km
    Application BR        : 120.277094
    Lane Count            : 1
    Lane Sig BR           : 30.069273
    Modulation Format      : DP-QPSK
    Bits Per Unit Intvl   : 4
    Lane Assigned         : Lane-1
```













## show qsfp-dd advertisement laser

Use this command to show QSFP-DD module advertised laser controls.

### Command Syntax

```
show qsfp-dd PORTNUM advertisement laser
```

### Parameters

PORTNUM                    QSFP-DD front panel port number

### Command Mode

Exec mode and Privileged Exec mode

### Applicability

This command was introduced before OcNOS version 6.1.0.

### Example

```
show qsfp-dd 0 advertisement laser
```

```

Port Number                               : 0
Supported Grids                           : 6.25 GHz, 12.5 GHz, 25 GHz, 50 GHz, 100
GHz, 75 GHz
  6.25 GHz Channels                        : Low=191.275 THz, High=196.125 THz,
Total=776
  12.5 GHz Channels                        : Low=191.275 THz, High=196.125 THz,
Total=388
  25 GHz Channels                          : Low=191.275 THz, High=196.125 THz,
Total=194
  50 GHz Channels                          : Low=191.300 THz, High=196.100 THz,
Total=96
  100 GHz Channels                         : Low=191.300 THz, High=196.100 THz,
Total=48
  75 GHz Channels                          : Low=191.300 THz, High=196.100 THz,
Total=64
Fine Tuning Support                        : Yes
  Fine Tuning Resolution                    : 0.001 GHz
  Fine Tuning Low Offset                    : -6.000 GHz
  Fine Tuning High Offset                   : 6.000 GHz
Output Power Programmable Per Lane        : Yes
  Min Output Power Programmable            : -22.90 dBm
  Max Output Power Programmable            : 4.00 dBm

```





SOP ROC : Yes [Lane 1]  
 SOPMD - low granularity : Yes [Lane 1]

| FEC Performance |

Rx Bits : Yes  
 Rx Correct Bits : Yes  
 Rx Frames : Yes  
 Rx Uncorrect Frames : Yes

| Link Performance |

Rx DSP CCD : Yes  
 Rx DSP DGD : Yes  
 Rx SOPM : Yes  
 Rx PDL : Yes  
 Rx oSNR : Yes  
 Rx eSNR : Yes  
 Rx CFO : Yes  
 Rx EvmModem : No  
 Tx Power : Yes  
 Rx Input Optical Power : Yes  
 Rx input Optical Signal Power : Yes  
 Rx SOPCR : Yes  
 Rx SOPMD Low Granularity : No  
 Rx Clock Recovery Monitor : No  
 Rx FDD : Yes  
 Rx FEC : Yes

---

## show qsfp-dd advertisement monitors module

Use this command to show QSFP-DD module advertised monitors

### Command Syntax

```
show qsfp-dd PORTNUM advertisement monitors module
```

### Parameters

PORTNUM                    QSFP-DD front panel port number

### Command Mode

Exec mode and Privileged Exec mode

### Applicability

This command was introduced before OcNOS version 6.1.0.

### Example

```
show qsfp-dd 0 advertisement monitors module
```

```
Port Number                    : 0
Voltage                        : Yes
Temperature                    : Yes
TEC Current                    : Yes
Laser Temperature              : Yes
Laser Temperature [2]         : No

Rx Power                       : Yes
Rx Signal Power                : Yes
```









## QSFP-DD Laser Configuration and Status

---

		6		0	
		7		0	
		8		0	
Error Count (G)		1		0	
		2		0	
		3		0	
		4		0	
		5		0	
		6		0	
		7		0	
		8		0	
Bit Count (G)		1		0	
		2		0	
		3		0	
		4		0	
		5		0	
		6		0	
		7		0	
		8		0	



---

## show qsfp-dd eeprom

Use this command to show QSFP-DD module EEPROM information.

### Command Syntax

```
show qsfp-dd PORTNUM eeprom
```

### Parameters

PORTNUM                    QSFP-DD front panel port number

### Command Mode

Exec mode and Privileged Exec mode

### Applicability

This command was introduced before OcNOS version 6.1.0.

### Example

```
show qsfp-dd 0 eeprom
```

```
Port Number                    : 0
Identifier                     : QSFP-DD Double Density 8X Pluggable
Transceiver
Name                           : SmartOptics
OUI                            : 0x0 0x53 0x4f
Part No                        : SO-TQSFPDD4CCZRP
Revision Level                 : A
Serial_Number                 : 214156190
Manufacturing Date             : 220318    (yymmddvv, v=vendor specific)
Module Power Class             : 8
Module Max Power               : 23.75 Watt
Cooling Implemented             : Yes
Module Temperature Max         : 80 Celsius
Module Temperature Min         : 0 Celsius
Operating Voltage Min         : 3.12 Volt
Optical Detector               : PIN
Rx Power Measurement          : Average Power
Tx Disable Module Wide         : No
Cable Assembly Link Length    : Separable Media
Connector Type                 : LC (Lucent Connector)
Media Interface Technology     : 1550 nm DFB
CMIS Revision                  : 4.1
Memory Model                   : Paged
MCI Max Speed                 : 1000 kHz
Active Firmware Revision       : 61.20
Inactive Firmware Revision     : 61.20
Hardware Revision              : 49.48
Media Type                     : Optical SMF
Max SMF Link Length           : 630.0 Kilometer
Wavelength Nominal            : 1547.70 nm
Wavelength Tolerance          : 166.55 nm
```

## show qsfp-dd laser grid

Use this command to show QSFP-DD module laser grid spacing information for frequencies of 3.125, 6.25 12.5 25, 33, 50, 75 and 100 GHz.

### Command Syntax

```
show qsfp-dd PORTNUM laser grid (3p125|6p25|12p5|25|33|50|75|100)
```

### Parameters

PORTNUM	QSFP-DD front panel port number
3p125	3.125 GHz
6p25	6.25 GHz
12p5	12.5 GHz
25	25 GHz
33	33 GHz
50	50 GHz
75	75 GHz
100	100 GHz

### Default

None.

### Command Mode

Exec mode and Privileged Exec mode.

### Applicability

This command was introduced in OcNOS version 6.2.0.

### Examples

```
show qsfp-dd 0 laser grid 100
```

```
Port Number          : 0
```

```
-----
```

Channel Number	Frequency (THz)	Wavelength (nm)
-18	191.300000	1567.133
-17	191.400000	1566.314
-16	191.500000	1565.496
-15	191.600000	1564.679
-14	191.700000	1563.863
-13	191.800000	1563.047
-12	191.900000	1562.233
-11	192.000000	1561.419
-10	192.100000	1560.606
-9	192.200000	1559.794
-8	192.300000	1558.983

```
-----
```

## QSFP-DD Laser Configuration and Status

---

-7	192.400000	1558.173
-6	192.500000	1557.363
-5	192.600000	1556.555
-4	192.700000	1555.747
-3	192.800000	1554.940
-2	192.900000	1554.134
-1	193.000000	1553.329
0	193.100000	1552.524
1	193.200000	1551.721
2	193.300000	1550.918
3	193.400000	1550.116
4	193.500000	1549.315
5	193.600000	1548.515
6	193.700000	1547.715
7	193.800000	1546.917
8	193.900000	1546.119
9	194.000000	1545.322
10	194.100000	1544.526
11	194.200000	1543.730
12	194.300000	1542.936
13	194.400000	1542.142
14	194.500000	1541.349
15	194.600000	1540.557
16	194.700000	1539.766
17	194.800000	1538.976
18	194.900000	1538.186
19	195.000000	1537.397
20	195.100000	1536.609
21	195.200000	1535.822
22	195.300000	1535.036
23	195.400000	1534.250
24	195.500000	1533.465
25	195.600000	1532.681
26	195.700000	1531.898
27	195.800000	1531.116
28	195.900000	1530.334
29	196.000000	1529.553
30	196.100000	1528.773

## show qsfp-dd laser status

Use this command to show QSFP-DD module current laser configuration status and alarm flags.

### Command Syntax

```
show qsfp-dd PORTNUM laser status
```

### Parameters

PORTNUM                    QSFP-DD front panel port number

### Default

None.

### Command Mode

Exec mode and Privileged Exec mode.

### Applicability

This command was introduced in OcNOS version 6.2.0.

### Examples

```
show qsfp-dd 0 laser status
```

```
Port Number                    : 0
```

```
-----
```

Attribute	Lane	Value	Unit
Grid Spacing	1	100.000	GHz
Laser Frequency	1	191.900000	THz
Channel Number	1	-12	--
Wavelength	1	1562.23	nm

```
-----
```

Flag	Lane	Status
Tuning in progress	1	No
Wavelength locked	1	Yes

```
-----
```

Flag	Lane	Status (L)
Target output power OOR	1	No
Fine tuning out of range	1	No
Tuning accepted	1	Yes
Channel number valid	1	Yes

## show qsfp-dd monitors host

Use this command to show QSFP-DD module host side monitors information.

### Command Syntax

```
show qsfp-dd PORTNUM monitors host
```

### Parameters

PORTNUM                    QSFP-DD front panel port number

### Command Mode

Exec mode and Privileged Exec mode

### Applicability

This command was introduced before OcNOS version 6.1.0.

### Example

```
show qsfp-dd 0 monitors host
```

```
Alarm Codes: FDD - FEC Detected Degrade, FED - FEC Excessive Degrade
              LD - Local Degrade, RD - Remote Degrade
              FLOPB - Flexe Loss of Pad Block, FLOMF - Flexe Loss of Multi-
Frame
              FLOF - Flexe Loss of Frame, FIIDM - Flexe Instance Id Mismatch
              FCM - Flexe Calendar Mismatch, FIMM - Flexe Instance Map Mismatch
              FGIDM - Flexe GID Mismatch, TLF - Transmit Local Fault
              TRF - Transmit Remote Fault, TLOA - Transmit Loss of Alignment
              RLF - Receive Local Fault, RRF - Receive Remote Fault
              RLOA - Receive Loss of Alignment
```

```
Port Number                    : 0
```

Flag	Lane	Status (L)
Tx LOS	1	False
	2	False
	3	False
	4	False
	5	False
	6	False
	7	False
	8	False
Tx CDR LOL	1	False
	2	False
	3	False
	4	False
	5	False
	6	False
	7	False
	8	False
Tx Adaptive Input Eq	1	Good
	2	Good



	3	Good	
	4	Good	
	5	Good	
	6	Good	
	7	Good	
	8	Good	

-----  
 ---

Host Performance

-----  
 ---

Attribute	Lane	Value
-----------	------	-------

-----  
 ---

Alarm Status	1	LD
--------------	---	----

-----  
 ---

-----  
 FEC Performance

-----  
 ---

Attribute	Lane	Value
Tx Bits	1	2125037470720
Tx Corrected Bits	1	0
Tx Frames	1	390631888
Tx Uncorrected Frames	1	0



Rx LOS	1	False
Tx Failure	1	False
Rx CDR LOL	1	False

Link Performance

Attribute	Lane	Average	Minimum	Maximum	Unit
Rx DSP CCD	1	-1	-1	-1	ps/nm
Rx DSP DGD	1	1.00	1.00	1.00	ps
Rx SOPMD	1	40.00	40.00	40.00	ps <sup>2</sup>
Rx PDL	1	0.5	0.5	0.5	dB
Rx OSNR	1	36.4	36.4	36.4	dB
Rx ESNR	1	16.4	16.4	16.4	dB
Rx CFO	1	86	14	158	MHz
Tx Power	1	-7.77	-7.78	-7.76	dBm
Rx Input Optical Power	1	-18.90	-18.91	-18.90	dBm
Rx Input Optical Signal Power	1	-19.18	-19.19	-19.18	dBm
Rx SOPCR	1	0	0	0	krads/s
Rx MER	1	0.0	0.0	0.0	dB

Alarm Status	1	RLOLCD, RLOLD, RPF
--------------	---	--------------------

FEC Performance

Attribute	Lane	Value
Rx Bits	1	462238792192
Rx Corrected Bits	1	1398045784
Rx Frames	1	902810141
Rx Uncorrected Frames	1	0

---

## show qsfp-dd monitors module

Use this command to show QSFP-DD module monitors information.

### Command Syntax

```
show qsfp-dd PORTNUM monitors module
```

### Parameters

PORTNUM                    QSFP-DD front panel port number

### Command Mode

Exec mode and Privileged Exec mode

### Applicability

This command was introduced before OcNOS version 6.1.0.

### Example

```
show qsfp-dd 0 monitors module
```

Codes: [HA : High Alarm], [LA : Low Alarm], [HW : High Warning], [LW : Low Warning]

```
Port Number                    : 0
```

Attribute	Value	High Alarm	High Warning	Low Warning	Low Alarm	Units
Voltage	3.24	3.46	3.43	3.17	3.13	Volt
Temperature	42.0	80.0	75.0	15.0	-5.0	Celsius
TEC Current Magnitude	63.000	100.00	100.00	-100.00	-100.00	%
Laser Temperature	43.000	80.00	75.00	-40.00	-80.00	Celsius

---

## show qsfp-dd state

Use this command to show QSFP-DD module current state information.

### Command Syntax

```
show qsfp-dd PORTNUM state
```

### Parameters

PORTNUM                    QSFP-DD front panel port number

### Command Mode

Exec mode and Privileged Exec mode

### Applicability

This command was introduced before OcnOS version 6.1.0.

### Example

```
show qsfp-dd 0 state
```

```
Port Number                                   : 0
Module Fault State                           : No fault
Module State                                  : Ready
Data Path State                               : Activated [Starting On : Lane-1]
```



---

## CHAPTER 41 Smart SFP Commands

---

This chapter is a reference for the Smart SFP commands:

- `ddm raise`
- `show interface transceiver details`
- `show interface transceiver detail remote`
- `show interface transceiver protocol`
- `show interface transceiver protocol remote`
- `show interface transceiver protocol stats`
- `show interface transceiver remote`
- `show interface transceiver threshold violations remote`
- `xcvr <IFNAME> tx-disable <1-256> remote`
- `xcvr <IFNAME> reset remote`
- `xcvr loopback`

---

## ddm raise

Use this command to raise a false alarm on the remote smart SFP.

Use this command to clear the false alarm on the remote smart SFP.

### Command Syntax

```
ddm raise false alarm IFNAME
  ((temperature|voltage|voltage2|current|rxpower|txpower|frequency-
  error|wavelength-error|snr|resisi|leveltrans|tecurrent|prefecber|
  uncorrectedber|lasertemp) VALUE) | tec-fault) (remote|)

no ddm raise false alarm IFNAME
  (temperature|voltage|voltage2|current|rxpower|txpower|frequency-
  error|wavelength-error|tec-fault|snr|resisi|leveltrans|tecurrent|prefecber|
  uncorrectedber|lasertemp) (remote|)
```

### Parameters

None

### Default

By default, the debug command is not configured.

### Command Mode

Configuration mode

### Applicability

This command was introduced before OcNOS version 6.2.0.

### Example

The following command displays detailed information ddm raise.

```
OcNOS(config)#conf t
OcNOS(config)#ddm raise false alarm xe1 temperature +95.00 remote
OcNOS(config)#ddm raise false alarm xe1 voltage +3.50 remote
```



---

## show interface controller details

Use this command to display the EEPROM details.

### Command Syntax

```
show interface (IFNAME|) controllers (remote)
```

### Parameters

IFNAME	Interface name. If not specified, this command displays details of all connected transceivers.
remote	Interface name

### Default

None

### Command Mode

Exec mode

### Applicability

This command was introduced in OcNOS version 6.2.0

### Example

The following command displays detailed information of smart SFP.

```
OcNOS#show interface controllers remote
Codes: SMF - Single Mode Fiber, MMF - Multi Mode Fiber, FC - Fiber Channel
      OM1 - 62.5 Micron MMF [200MHzkm @ 850nm & 500MHzkm @ 1310nm]
      OM2 - 50 Micron MMF [500MHzkm @ 850nm & [500MHzkm @ 1310nm]
      OM3 - 50 Micron MMF [2000MHz*km @ 850nm], OUI - Vendor ID
      OM4 - 50 Micron MMF [4700MHz*km @ 850nm], BR - Bit Rate, CC - Check
Code
Class
      AOC - Active Optical Cable, ACC - Active Copper Cable, PC - Power
Identification
      CDR - Clock Data Recovery, CLEI - Common Language Equipment
      LR - Long Reach, SR - Short Reach, IR - Intermediate Reach
      CCA - Copper Cable Attenuation

#####
Port Number      : 24
Name             : WTD
OUI              : 0x0 0x1c 0xad
Part No         : RTX330-8921
Serial_Number   : ME223702430001
Identifier       : SFP/SFP+/SFP28
Ext. Identifier  : GBIC/SFP Is Defined By Two-Wire Interface ID
Only
Connector Type  : LC (Lucent Connector)
Ethernet/Ext-Eth Compliance : 100GBASE-LR4 or 25GBASE-LR
SONET Compliance :
```

## Smart SFP Commands

---

```
Infiniband Compliance      :
ESCON Compliance           :
FCLink Length              :
FC Technology               :
FC Transmission Media      :
FC Speed                    :
SFP+ Cable Technology      :
Length SMF                  : 10 (Kilometers)
Length SMF                  : 100 (X 100 Meters)
Length OM1                  : 0 (X 10 Meters)
Length OM2                  : 0 (X 10 Meters)
Length OM3                  : 0 (X 10 Meters)
Length OM4                  : 0 (X 10 Meters)
Revision Level              : V01
Wavelength                  : 1269nm
Manufacturing Date          : 220809 (yymmddvv, v=vendor specific)
Encoding Algorithm          : 64B/66B
CC                           : 0x25
CC Ext.                     : 0x68
Nominal BR                  : 255 (X 100 MBd)
Max BR                      : 103
Min BR                      : 0
Options Implemented         : Power Level 3
                             Paging
                             Internal Re-Timer Or CDR
                             Cooled Laser Trasnmitter
                             Power Level 2
                             RATE_SELECT
                             TX_DISABLE
                             TX_FAULT
                             Rx Loss Of Signal (LOS)
DDM Support                 : Yes
```

---

## show interface transceiver details

Use this command to display details of transceivers and threshold violations.

### Command Syntax

```
show interface (IFNAME|) transceiver (detail|threshold violation|(protocol
(stats|))|)(remote|)
```

### Parameters

IFNAME	Interface name. If not specified, this command displays details of all connected transceivers.
detail	Transceiver information such as voltage, temperature, power, and current.
threshold violation	Transceiver threshold violations.
Codes	* Not Qualified By IP Infusion, ** Not Supported By Module.

### Default

None

### Command Mode

Exec mode

### Applicability

This command was introduced before OcNOS version 6.2.0.

### Example

The following command displays detailed information of interface transceiver details.

```
OcNOS#show int transceiver detail
Codes: * Not Qualified By IP Infusion, ** Not Supported By Module, -- No
Power, - Not Applicable
```

Intf	DDM	Temp (Celsius)	AlertMax (Celsius)	CritMax (Celsius)	CritMin (Celsius)	AlertMin (Celsius)
------	-----	-------------------	-----------------------	----------------------	----------------------	-----------------------

---

ce0	Active*	+22.52	+85.00	+80.00	-5.00	-10.00
ce2	Active	+20.32	+75.00	+70.00	+0.00	-5.00
xe4	Active*	+23.62	+95.00	+85.00	-40.00	-50.00
xe5	Active*	+19.79	+100.00	+95.00	-35.00	-40.00
xe16	Active*	+25.84	+95.00	+85.00	-10.00	-50.00
xe26	Active	+19.01	+95.00	+90.00	-20.00	-25.00

Intf	DDM	Volt	AlertMax	CritMax	CritMin	AlertMin
------	-----	------	----------	---------	---------	----------

Smart SFP Commands

		(Volts)	(Volts)	(Volts)	(Volts)	(Volts)
ce0	Active*	+3.314	+3.600	+3.500	+3.100	+2.900
ce2	Active	+3.260	+3.630	+3.465	+3.135	+2.970
xe4	Active*	+3.260	+3.600	+3.500	+3.100	+3.000
xe5	Active*	+3.253	+3.600	+3.500	+2.900	+2.800
xe16	Active*	+3.284	+3.630	+3.500	+3.030	+2.930
xe26	Active	+3.289	+3.900	+3.700	+2.900	+2.700

Intf	DDM	Lane	Curr	AlertMax	CritMax	CritMin
AlertMin			(mA)	(mA)	(mA)	(mA)
(mA)						

ce0	Active*	1	+6.114	+15.000	+12.000	+2.000
+0.000		2	+6.120	+15.000	+12.000	+2.000
+0.000		3	+6.110	+15.000	+12.000	+2.000
+0.000		4	+6.116	+15.000	+12.000	+2.000
ce2	Active	1	+7.464	+13.000	+11.000	+5.000
+3.000		2	+7.540	+13.000	+11.000	+5.000
+3.000		3	+7.444	+13.000	+11.000	+5.000
+3.000		4	+7.474	+13.000	+11.000	+5.000
xe4	Active*	-	+6.100	+110.000	+100.000	+1.000
+1.000						
xe5	Active*	-	+7.552	+15.000	+13.000	+2.000
+1.000						
xe16	Active*	-	+5.800	+15.000	+12.000	+3.000
+2.000						
xe26	Active	-	+7.050	+17.000	+14.000	+2.000
+1.000						

Intf	DDM	Lane	RxPwr	AlertMax	CritMax	CritMin
AlertMin			(dBm)	(dBm)	(dBm)	(dBm)
(dBm)						

ce0	Active*	1	-0.185	+4.400	+3.400	-13.298	-
14.306		2	+0.342	+4.400	+3.400	-13.298	-
14.306		3	+0.396	+4.400	+3.400	-13.298	-
14.306		4	-2.927	+4.400	+3.400	-13.298	-
ce2	Active	1	+1.302	+3.400	+2.400	-11.002	-
14.001							

14.001		2	+1.486	+3.400	+2.400	-11.002	-
14.001		3	+1.581	+3.400	+2.400	-11.002	-
14.001		4	+1.594	+3.400	+2.400	-11.002	-
xe4	Active*	-	-1.890	+2.500	+0.500	-14.401	-
16.402							
xe5	Active*	-	-40.000	+3.000	+0.000	-13.002	-
16.003							
xe16	Active*	-	--	+2.000	+1.000	-14.401	-
16.402							
xe26	Active	-	-5.933	+1.000	-1.002	-18.013	-
20.000							

Intf	DDM	Lane	TxPwr	AlertMax	CritMax	CritMin
AlertMin			(dBm)	(dBm)	(dBm)	(dBm)
(dBm)						

ce0	Active*	1	-0.085	+4.400	+3.400	-9.201	-
10.205		2	-0.161	+4.400	+3.400	-9.201	-
10.205		3	+0.217	+4.400	+3.400	-9.201	-
10.205		4	+0.204	+4.400	+3.400	-9.201	-
ce2	Active	1	+0.297	+5.000	+3.000	-8.000	-
10.000		2	-0.078	+5.000	+3.000	-8.000	-
10.000		3	+0.131	+5.000	+3.000	-8.000	-
10.000		4	+0.323	+5.000	+3.000	-8.000	-
xe4	Active*	-	-1.316	+2.500	+0.500	-8.199	-
10.200							
xe5	Active*	-	-2.299	+1.000	+0.000	-7.001	-
8.000							
xe16	Active*	-	-1.000	+2.500	+2.000	-8.199	-
10.200							
xe26	Active	-	-4.441	-2.000	-2.000	-11.024	-
11.739							

Intf	DDM	Lane	Freq-Err	AlertMax	CritMax	CritMin
AlertMin			(GHz)	(GHz)	(GHz)	(GHz)
(GHz)						

Intf	DDM	Lane	Wave-Err	AlertMax	CritMax	CritMin
AlertMin			(nm)	(nm)	(nm)	(nm)
(nm)						

Intf	DDM	Lane	Tx	Rx-LOS	Tx-LOS
------	-----	------	----	--------	--------

```

-----
ce0      Active*  1      On      Off      Off
                   2      On      Off      Off
                   3      On      Off      Off
                   4      On      Off      Off
ce2      Active   1      On      Off      Off
                   2      On      Off      Off
                   3      On      Off      Off
                   4      On      Off      Off
xe4      Active*  -      On      Off      -
xe5      Active*  -      On      On       -
xe9      Inactive* -      On      On       -
xe11     Inactive* -      On      On       -
xe13     Inactive* -      On      On       -
xe14     Inactive* -      On      On       -
xe16     Active*  -      On      On       -
xe26     Active   -      On      Off      -
    
```

Table 41-108 explains the output fields.

**Table 41-108: show interface transceiver details output**

Field	Description
Port	The number of the transceiver port.
Temp	Temperature in degrees Celsius of the transceiver.
Voltage	Voltage in Volts on the transceiver.
Current	Current in Milliamperes used by the transceiver.
Rx Power	Power received in Decibel-milliwatts (dBm) by the transceiver.
Tx Power	Power being transmitted in milliWatts by the transceiver.
High Alarm	The level that is needed to be reached to trigger a high alarm.
High Warn	The level that is needed to be reached to trigger a high warning.
Low Warn	The level that is needed to be reached to trigger a low warning.
Low Alarm	The level that is needed to be reached to trigger a low alarm.
Codes *	Not Qualified By IP Infusion, ** Not Supported By Module

---

## show interface transceiver detail remote

Use this command to display all the threshold values for volt, temperature, and power for the remote transceiver.

### Command Syntax

```
show interface (IFNAME|) transceiver detail remote
```

### Parameters

IFNAME	Interface name. If not specified, this command displays details of all connected transceivers.
remote	Interface name
detail	Remote transceivers information

### Default

None.

### Command Mode

Exec mode

### Applicability

This command was introduced in OcNOS version 6.2.0.

### Example

The following command displays detailed information of interface transceiver detail remote.

```
OcNOS#show interface transceiver detail remote
```

```

      Intf      DDM      Temp      AlertMax  CritMax  CritMin
AlertMin
(Celsius)
-----

```

```

      Intf      DDM      Volt      AlertMax  CritMax  CritMin
AlertMin
(Volts)
-----

```

---

## show interface transceiver protocol

Use this command to display the OAM protocol status and module status of the local module.

### Command Syntax

```
show interface (IFNAME|) transceiver protocol
```

### Parameters

IFNAME	Interface name. If not specified, this command displays details for all connected transceivers.
protocol	OAM protocol status, and module status of local module.

### Default

None.

### Command Mode

Exec mode

### Applicability

This command was introduced in OcNOS version 6.2.0.

### Example

The following command displays detailed information of interface transceiver protocol.

```
OcNOS#show interface transceiver protocol

#####
Port Number           : 2
OAM status            : On
Local status          : Link failure
```



---

## show interface transceiver protocol remote

Use this command to display the OAM protocol status and module status of the remote module.

### Command Syntax

```
show interface (IFNAME|) transceiver protocol remote
```

### Parameters

IFNAME	Interface name. If not specified, this command displays details of all connected transceivers.
protocol	OAM protocol status, and module status of the remote module.
remote	Remote transceiver information

### Default

None

### Command Mode

Exec mode

### Applicability

This command was introduced in OcNOS version 6.2.0.

### Example

The following command displays detailed information of interface transceiver protocol remote.

```
OcNOS#show interface transceiver protocol remote

#####
Port Number           : 2
Remote status         : Remote TCVR Ready
```

---

## show interface transceiver protocol stats

Use this command to display the protocol frame statistics.

### Command Syntax

```
show interface (IFNAME|) transceiver protocol stats
```

### Parameters

IFNAME	Interface name. If not specified, this command displays details for all connected transceivers.
protocol	OAM protocol status, and module status of local module.
stats	Protocol frame statistics

### Default

None

### Command Mode

Exec mode

### Applicability

This command was introduced in OcNOS version 6.2.0.

### Example

The following command displays detailed information of interface transceiver protocol stats

```
OcNOS#show interface transceiver protocol stats

#####
Port Number                : 2
OAM frames Sent            : 1583
OAM frames received corretly : 1
OAM frames received with error: 2
```

---

## show interface transceiver remote

Use this command to display the remote transceiver information.

### Command Syntax

```
show interface (IFNAME|) transceiver remote
```

### Parameters

IFNAME	Interface name. If not specified, this command displays details for all connected transceivers.
remote	Remote transceiver information.

### Default

None

### Command Mode

Exec mode

### Applicability

This command was introduced in OcNOS version 6.2.0.

### Example

The following command displays detailed information of interface transceiver remote

```
OcNOS#show interface transceiver remote
```

Tx-	Intf	DDM	Temp	Voltage	Lane	Tx	Rx-Los
	Los	Current	TxPower	RxPower	Freq-Err	Wave-Err	
		(mA)	(Celsius)	(volt)	(GHZ)	(nm)	
		(dBm)	(dBm)	(dBm)			

-----  
-----

---

## show interface transceiver threshold violations remote

Use this command to display the details of remote transceivers and threshold violations.

### Command Syntax

```
show interface (IFNAME|) transceiver (detail|threshold violation|) remote
```

### Parameters

IFNAME	Interface name. If not specified, this command displays details of all connected transceivers.
detail	Transceiver information, such as voltage, temperature, power, and current.
threshold violation	Transceiver threshold violations.

### Default

None

### Command Mode

Exec mode

### Applicability

This command was introduced in OcNOS version 6.2.0.

### Example

The following command displays detailed information of interface transceiver threshold violations remote.

```
OcNOS#show interface transceiver threshold violations remote
      Intf      Lane      Timestamp      Type of alarm
      ----      ----      -
      ----      ----      -----      -
```

---

## **xcvr <IFNAME> tx-disable <1-256> remote**

Use this command to laser off the remote transceiver for <1-256> seconds and to turn the laser ON.

### **Command Syntax**

```
xcvr <IFNAME> tx-disable <1-256> remote
```

### **Parameters**

IFNAME	Interface name.
remote	Remote transceiver.

### **Default**

None

### **Command Mode**

Exec mode

### **Applicability**

This command was introduced in OcNOS version 6.2.0.

### **Example**

The following command displays detailed information of xcvr <IFNAME> tx-disable <1-256> remote.

```
OcNOS#xcvr xe2 tx-disable 2 remote
```

---

## **xcvr <IFNAME> reset remote**

Use this command to reset the remote transceiver.

### **Command Syntax**

```
xcvr <IFNAME> reset remote
```

### **Parameters**

<code>IFNAME</code>	Interface name.
<code>remote</code>	Remote transceiver.
<code>reset</code>	Reset remote transceiver

### **Default**

None

### **Command Mode**

Exec mode

### **Applicability**

This command was introduced in OcNOS version 6.2.0.

### **Example**

The following command displays detailed information of `xcvr <IFNAME> reset remote`.

```
OcNOS#xcvr xe2 reset remote
```

---

## xcvr loopback

Use this command to loopback Tx and Rx Input loop back for remote.

Use this command to loopback Tx and Rx Output loop back for remote.

### Command Syntax

```
xcvr loopback (in|out) remote
no xcvr loopback (in|out) remote
```

### Parameters

None

### Default

None

### Command Mode

Interface mode

### Applicability

This command was introduced in OcNOS version 6.2.0.

### Example

The following command displays detailed information of xcvr loopback.

```
OcNOS(config)#int xe2
OcNOS(config-if)#xcvr loopback in remote
OcNOS(config-if)#commit
OcNOS(config-if)#end
OcNOS#conf t
OcNOS(config)#int xe2
OcNOS(config-if)#xcvr loopback out remote
OcNOS(config-if)#commit
OcNOS(config-if)#end
```





## CHAPTER 42 Erbium-doped Fiber Amplifier Commands

---

This chapter is a reference for Erbium-doped fiber amplifier (EDFA) commands:

- [edfa operating-mode](#)
- [edfa target-gain](#)
- [edfa target-outpwr](#)
- [show edfa operating-mode](#)
- [show interface IFNAME transceiver](#)
- [show interface transceiver](#)
- [show interface IFNAME transceiver detail](#)
- [show interface transceiver detail](#)
- [show interface IFNAME transceiver threshold violations](#)
- [show interface transceiver threshold violations](#)

---

## edfa operating-mode

Use this command to configure EDFA interface operating-mode.

### Command Syntax

```
edfa operatingn-mode PARAM
```

### Parameters

PARAM	Specifies the operating-mode Automatic Power Control (apc) and Automatic Gain Control (agc).
-------	--

### Default

None

### Command Mode

Interface mode

### Applicability

This command was introduced before OcNOS version 6.3.0.

### Example

```
OcNOS(config-if)#edfa operating-mode agc  
OcNOS(config-if)#commit
```

---

## edfa target-gain

Use this command to configure EDFA interface target gain.

### Command Syntax

```
edfa target-gain VALUE
```

### Parameters

VALUE	Target gain value.
-------	--------------------

### Default

None

### Command Mode

Interface mode

### Applicability

This command was introduced in OcNOS version 6.3.0.

### Example

```
OcNOS(config-if)#edfa target-gain 15  
OcNOS(config-if)#commit
```

---

## edfa target-outpwr

Use this command to configure EDFA interface target output power.

### Command Syntax

```
edfa target-outpwr VALUE
```

### Parameters

VALUE                    Target output power value.

### Default

None

### Command Mode

Interface mode

### Applicability

This command was introduced before OcNOS version 6.3.0.

### Example

```
OcNOS(config-if)#edfa target-outpwr 7  
OcNOS(config-if)#commit
```

---

## show edfa operating-mode

Use this command for a EDFA operating-mode summary.

### Command Syntax

```
show edfa operating-mode
```

### Parameters

None

### Default

None

### Command Mode

Exec mode and Privileged Exec mode

### Applicability

This command was introduced before OcNOS version 6.3.0.

### Example

```
OcNOS>show edfa operating-mode
```

```
Default Operating Mode      : AGC
Default Target OutPwr(BA)   : 17.000
Default Target OutPwr(PA)   : 7.000
Default Target Gain         : 17.000
```

```
-----
Interface                    Operating-Mode
-----
ce5/1                        AGC
ce7/1                        AGC
ce11/1                       AGC
```

---

## show interface IFNAME transceiver detail

Use this command to display EDFA attributes and their thresholds

### Command Syntax

```
show interface IFNAME transceiver detail
```

### Parameters

IFNAME                    Interface name

### Default

None

### Command Mode

Exec mode and Privileged Exec mode

### Applicability

This command was introduced before OcNOS version 6.3.0.

### Example

```
OcNOS>show interface ce9/1 transceiver detail
Codes: * Not Qualified By IP Infusion, ** Not Supported By Module, -- No
Power, - Not Applicable
```

...

Intf	DDM	InPwr (dBm)	AlertMax (dBm)	CritMax (dBm)	CritMin (dBm)	AlertMin (dBm)
ce9/1	Inactive*	-2.00	-7.00	-9.00	-30.97	-32.22
Intf	DDM	OutPwr (dBm)	AlertMax (dBm)	CritMax (dBm)	CritMin (dBm)	AlertMin (dBm)
ce9/1	Inactive*	-7.00	+10.00	+8.00	-20.00	-20.97
Intf	DDM	PumpBias (Amp)	AlertMax (Amp)	CritMax (Amp)	CritMin (Amp)	AlertMin (Amp)
ce9/1	Inactive*	+0.35	+0.49	+0.45	+0.00	+0.00
Intf	DDM	Gain (dB)	AlertMax (dB)	CritMax (dB)	CritMin (dB)	AlertMin (dB)
ce9/1	Inactive*	+12.00	+26.00	+25.00	+8.00	+7.00

[Table 42-109](#) explains the output fields.

**Table 42-109: show interface transceiver details output**

<b>Field</b>	<b>Description</b>
Intf	Interface where the EDFA is present
DDM	Digital diagnostics monitor status for that particular interface
Inpwr	Input Power to the EDFA
OutPwr	Output Power from EDFA
PumpBias	Pump Bias
Gain	The total gain over the Input Power

---

## show interface IFNAME transceiver threshold violations

Use this command to show EDFA module input power, output power, pump bias and gain thresholds violations from a specific port.

### Command Syntax

```
show interface IFNAME transceiver threshold violations
```

### Parameters

IFNAME	Interface Name
--------	----------------

### Default

None

### Command Mode

Exec mode and Privileged Exec mode

### Applicability

This command was introduced before OcNOS version 6.3.0.

### Example

```
OcNOS>show interface cell1/1 transceiver threshold violations
```

Intf	Lane	Timestamp	Type of alarm
----	----	-----	-----
cell1/1	1	02-14-2019 12:39:04	Pump Bias low alarm, value 0.000A threshold 0.000A
		02-14-2019 12:38:04	Gain low warning, value 7.500dB threshold 8.000dB
		02-14-2019 12:38:04	Output power low warning, value -11.000dBm threshold -10.000dBm
		02-14-2019 12:38:04	Input power low warning, value -21.000dBm threshold -20.969dBm



---

## show interface IFNAME transceiver

Use this command to show EDFA module input power, output power, pump bias and gain current values from a specific port.

### Command Syntax

```
show interface IFNAME transceiver
```

### Parameters

IFNAME                      Interface Name

### Default

None

### Command Mode

Exec mode and Privileged Exec mode

### Applicability

This command was introduced before OcNOS version 6.3.0.

### Example

```
Cassini-3>show interface ce9/1 transceiver
```

```
Codes: * Not Qualified By IP Infusion, ** Not Supported By Module, -- No Power,
- Not Applicable
```

Intf	DDM	InPwr (dBm)	OutPwr (dBm)	PumpBias (Amp)	Gain (dB)
ce9/1	Inactive*	-2.00	-7.00	+0.35	+12.00

```
OcNOS>show interface ce9/1 transceiver detail
```

```
Codes: * Not Qualified By IP Infusion, ** Not Supported By Module, -- No Power,
- Not Applicable
```

...

Intf	DDM	InPwr (dBm)	AlertMax (dBm)	CritMax (dBm)	CritMin (dBm)	AlertMin (dBm)
ce9/1	Inactive*	-2.00	-7.00	-9.00	-30.97	-32.22

```
ce9/1            Inactive*   -2.00       -7.00       -9.00       -30.97       -32.22
```

Intf	DDM	OutPwr (dBm)	AlertMax (dBm)	CritMax (dBm)	CritMin (dBm)	AlertMin (dBm)
ce9/1	Inactive*	-7.00	+10.00	+8.00	-20.00	-20.97

```
ce9/1            Inactive*   -7.00       +10.00       +8.00       -20.00       -20.97
```

Intf	DDM	PumpBias (Amp)	AlertMax (Amp)	CritMax (Amp)	CritMin (Amp)	AlertMin (Amp)
ce9/1	Inactive*	+0.35	+0.49	+0.45	+0.00	+0.00

```
ce9/1            Inactive*   +0.35       +0.49       +0.45       +0.00       +0.00
```

Intf	DDM	Gain (dB)	AlertMax (dB)	CritMax (dB)	CritMin (dB)	AlertMin (dB)
ce9/1	Inactive*	+12.00				

```
ce9/1            Inactive*   +12.00                                                             
```

## Erbium-doped Fiber Amplifier Commands

---

ce9/1	Inactive*	+12.00	+26.00	+25.00	+8.00	+7.00
-------	-----------	--------	--------	--------	-------	-------

---

## show interface transceiver

Use this command to show EDFA module input power, output power, pump bias and gain current values from all ports.

### Command Syntax

```
show interface transceiver
```

### Parameters

None

### Default

None

### Command Mode

Exec mode and Privileged Exec mode

### Applicability

This command was introduced before OcNOS version 6.3.0.

### Example

```
Cassini-3>show interface transceiver
Codes: * Not Qualified By IP Infusion, ** Not Supported By Module, -- No Power, - Not
Applicable
```

Intf	DDM	Temp (Celsius)	Voltage (volt)	InPwr (dBm)	OutPwr (dBm)	PumpBias (Amp)	Gain (dB)
ce0	Inactive*	+33.10	+3.28	-8.12	+8.85	+0.11	+16.97

---

## show interface transceiver detail

Use this command to show EDFA module input power, output power, pump bias and gain threshold and current values from all ports.

### Command Syntax

```
show interface transceiver detail
```

### Parameters

None

### Default

None

### Command Mode

Exec mode and Privileged Exec mode

### Applicability

This command was introduced before OcNOS version 6.3.0.

### Example

```
OcNOS>show interface transceiver detail
Codes: * Not Qualified By IP Infusion, ** Not Supported By Module, -- No
Power, - Not Applicable
```

...

Intf	DDM	InPwr (dBm)	AlertMax (dBm)	CritMax (dBm)	CritMin (dBm)	AlertMin (dBm)
ce0	Inactive*	-8.12	+5.00	+4.00	-20.97	-21.94
Intf	DDM	OutPwr (dBm)	AlertMax (dBm)	CritMax (dBm)	CritMin (dBm)	AlertMin (dBm)
ce0	Inactive*	+8.83	+20.00	+18.00	-10.00	-11.94
Intf	DDM	PumpBias (Amp)	AlertMax (Amp)	CritMax (Amp)	CritMin (Amp)	AlertMin (Amp)
ce0	Inactive*	+0.11	+0.59	+0.53	+0.00	+0.00
Intf	DDM	Gain (dB)	AlertMax (dB)	CritMax (dB)	CritMin (dB)	AlertMin (dB)
ce0	Inactive*	+16.97	+26.00	+25.00	+8.00	+7.00

---

## show interface transceiver threshold violations

Use this command to show EDFA EDFA module input power, output power, pump bias and gain thresholds violations.

### Command Syntax

```
show interface transceiver threshold violations
```

### Parameters

None

### Default

None

### Command Mode

Exec mode and Privileged Exec mode

### Applicability

This command was introduced before OcNOS version 6.3.0.

### Example

```
OcNOS>show interface transceiver threshold violations
Intf      Lane      Timestamp      Type of alarm
----      -
ce9/1     1         03-05-2019 08:53:31 Gain high alarm, value 100.000dB threshold 26.000dB
          03-05-2019 08:53:31 Pump bias high alarm, value 100.000A threshold 0.579A
          03-05-2019 08:53:31 Output power high alarm, value 100.000dBm threshold 20.000dBm
          03-05-2019 08:53:31 Input power high alarm, value 100.000dBm threshold 5.000dBm

OcNOS>show interface ce9/1 transceiver threshold violations
Intf      Lane      Timestamp      Type of alarm
----      -
ce9/1     1         03-05-2019 08:57:09 Gain low alarm, value -100.000dB threshold 7.000dB
          03-05-2019 08:57:09 Pump Bias low alarm, value -100.000A threshold 0.000A
          03-05-2019 08:57:09 Output power low alarm, value -100.000dBm threshold -11.938dBm
          03-05-2019 08:57:09 Input power low alarm, value -100.000dBm threshold -21.938dBm

OcNOS>show interface ce9/1 transceiver threshold violations
Intf      Lane      Timestamp      Type of alarm
----      -
ce9/1     1         03-05-2019 09:03:36 Gain high warning, value 25.500db threshold 25.000db
          03-05-2019 09:03:36 Pump bias high warning, value 0.550A threshold 0.526A
          03-05-2019 09:03:36 Output power high warning, value 19.000dbm threshold 18.000dbm
          03-05-2019 09:03:36 Input power high warning, value 4.500dbm threshold 4.000dbm

OcNOS>show interface ce9/1 transceiver threshold violations
Intf      Lane      Timestamp      Type of alarm
----      -
ce9/1     1         03-05-2019 09:07:05 Gain low warning, value 7.500dB threshold 8.000dB
          03-05-2019 09:07:05 Pump Bias low alarm, value 0.000A threshold 0.000A
          03-05-2019 09:07:05 Output power low warning, value -11.000dBm threshold -10.000dBm
          03-05-2019 09:07:05 Input power low warning, value -21.000dBm threshold -20.969dBm
```



# Index

## A

- aaa accounting default 680
- aaa accounting details 681
- aaa authentication attempts login 680
- aaa authentication login 680
- aaa authentication login console 682
- aaa authentication login default 682
- aaa authentication login default fallback error 684
- aaa authorization config-commands default 685
- aaa group server 685
- aaa local authentication attempts max-fail 686
- abort transaction 389
- Access Lists 137
- arp A.B.C.D MAC 333
- Authentication 137
- authentication 1168

## B

- banner 319
- begin modifier 30
- BGP community value
  - command syntax 28
- braces
  - command syntax 27

## C

- Chassis Management Module Commands 975
- clear crypto sa map 1168
- clear ip prefix-list 753
- clear ipv6 neighbors 754
- clear ntp statistics 590
- clear ssh hosts 567
- clear tfo counter 1048
- Client 137
- clock timezone 321
- cml force-unlock config-datastore 391
- cml lock config-datastore 392
- cml logging 393
- cml netconf translation 394
- cml unlock config-datastore 396
- cmlsh multiple-config-session 398
- cmlsh transaction 401
- cmlsh transaction limit 402
- command abbreviations 26
- command completion 26
- command line
  - errors 26
  - help 25
  - keyboard operations 29
- command modes 33
  - configure 33
  - exec 33

- interface 33
  - privileged exec 33
  - router 33
- command negation 27
- command syntax
  - ? 28
  - . 28
  - () 27
  - { } 27
  - | 27
  - A.B.C.D/M 28
  - AA:NN 28
  - BGP community value 28
  - braces 27
  - conventions 27
  - curly brackets 27
  - HH:MM:SS 28
  - IFNAME 28
  - interface name 28
  - IPv4 address 28
  - IPv6 address 28
  - LINE 28
  - lowercase 27
  - MAC address 28
  - monospaced font 27
  - numeric range 28
  - parentheses 27
  - parentheses 27
  - period 28
  - question mark 28
  - square brackets 28
  - time 28
  - uppercase 27
  - variable placeholders 28
  - vertical bars 27
  - WORD 28
  - X:X::X:X 28
  - X:X::X:X/M 28
  - XX:XX:XX:XX:XX:XX 28
- commit 403
- common commands
  - banner 319
  - clear ip prefix-list 753
  - configure terminal 322
  - copy running-config startup-config 327
  - disable 330, 356
  - enable 332
  - enable password 333
  - end 334
  - exit 336
  - ip prefix-list 774
  - ip remote-address 777
  - ip unnumbered 778
  - ipv6 prefix-list 782
  - ipv6 unnumbered 784
  - log syslog 1069
  - reload 351, 352
  - service advanced-vty 352
  - service password-encryption 353

---

- service terminal-length 354
- show access-list 356
- show cli 356
- show ip prefix-list 845
- show list 361
- show startup-config 368
- show version 376
- write terminal 386
- Common NSM Layer 2 commands
  - flowcontrol off 765
  - show flowcontrol interface 796
- configuration 225
- configure mode 33
- configure terminal 322
- configuring sFlow 223
- Control Port Group 225, 1049, 1051
- copy 706
- copy ftp running-config (interactive) 709
- copy ftp startup-config 704, 705
- copy ftp startup-config (interactive) 710
- copy http startup-config 709
- copy http startup-config (interactive) 714
- copy running-config 698
- copy running-config (interactive) 699
- copy running-config start-config 327
- copy scp (startup-config|running-config) 706
- copy scp startup-config 706
- copy scp startup-config (interactive) 711
- copy sftp (startup-config|running-config) 707
- copy sftp startup-config 707
- copy sftp startup-config (interactive) 712
- copy startup-config 700
- copy startup-config (interactive) 701
- copy system file 702
- copy system file (interactive) 703
- copy tftp startup-config 708
- copy tftp startup-config (interactive) 713
- crypto ipsec transform-set 1168
- crypto isakmp policy 1170
- crypto map (Configure Mode) 1170
- curly brackets
  - command syntax 27

**D**

- ddm monitor 1016
- debug cml 408
- debug cmm 978
- debug ddm 1019, 1022
- debug dns client 530
- debug ntp 592
- debug radius 633
- debug sflow 1035
- debug snmp-server 649
- debug ssh server 569
- debug tacacs+ 621
- debug telnet server 556
- debug user-mgmt 426
- disable 330, 356

- do 331
- domain-name, ip 533

**E**

- enable 332
- enable password 333
- end 334
- exec command mode 33
- exit 336

**F**

- Fail Over Group 225
- feature dhcp 432
- feature ntp 592
- feature sflow 1036
- feature ssh 570
- feature tacacs+ 622
- feature telnet 557
- fec 764
- flowcontrol off 765
- fog tfc 1050
- fog type 1051

**H**

- hardware-profile portmode 768
- hardware-profile portmode bundle 768

**I**

- if-arbiter 769
- IFNAME 28
- interface 770
- Interface Commands 741
- interface mode 33
- ip address 771
- ip address dhcp 433, 772
- ip dhcp client request 434
- ip dhcp relay 447, 448, 454
- ip dhcp relay address 449
- ip dhcp relay information option 451
- ip domain-list 531
- ip domain-lookup 532
- ip domain-name 533
- ip forwarding 773
- ip host 534
- ip name-server 535
- ip prefix-list 774
- ip proxy-arp 776
- ip remote-address 777
- ip unnumbered 778
- ip vrf 779
- ip vrf forwarding 779
- IPv4 address
  - command syntax 28
- IPv6 address
  - command syntax 28



- ipv6 address 780
- ipv6 dhcp relay 455, 461
- ipv6 dhcp relay address 457
- ipv6 dhcp relay subscriber-id 460
- ipv6 forwarding 781
- ipv6 prefix-list 782
- ipv6 unnumbered 784

## L

- LINE 28
- link-type 1052
- locator led 981
- log syslog 1069
- Logging Console Configuration 211
- logging level 1071
- logging logfile 1073
- logging source-interface 1078
- logging timestamp 1078
- logout 344

## M

- MAC address
  - command syntax 28
- Maxpoll and Minpoll Configuration 139
- Monitor Port Group 225, 1049, 1050, 1051
- Monitor Port Groups 1050
- multicast 795
- Multicast Commands
  - multicast 795
  - show ip rpf 822

## N

- NSM Commands
  - arp A.B.C.D MAC 333
  - clear ipv6 neighbors 754
  - if-arbiter 769
  - interface 770
  - ip address 771
  - ip address dhcp 772
  - ip forwarding 773
  - ip proxy-arp 776
  - ipv6 address 780
  - ipv6 forwarding 781
  - multicast 795
  - show debugging nsm 359
  - show ip forwarding 824
  - show ip interface brief 825
  - show ipv6 forwarding 840
  - show ipv6 interface brief 841
  - show ipv6 route 843
  - show nsm client 363
  - show router-id 1110
- ntp access-group 594
- ntp authenticate 594
- NTP Authentication 139
- ntp authentication-key 595

- NTP Configuration 138
- ntp enable 596
- ntp logging 598
- ntp master 601
- ntp peer 601
- ntp server 604
- ntp trusted-key 607

## P

- parentheses
  - command syntax 27
- parentheses
  - command syntax 27
- Peer 137
- period
  - command syntax 28
- ping 346
- port breakout configuration 307
- port bundle enable 795
- prefix-list 774
- privileged exec mode 33

## Q

- question mark
  - command syntax 28

## R

- RADIUS Server Accounting 180
- RADIUS Server Authentication 173
- radius-server deadtime 634
- radius-server directed-request 634
- radius-server host 634
- radius-server host acct-port 636
- radius-server host auth-port 637
- radius-server host key 640
- radius-server key 640
- radius-server retransmit 641
- radius-server timeout 641
- reload 351, 352
- reset log file 1058
- router mode 33

## S

- Server 137
- server 689
- service 352
- service advanced-vty 352
- service password-encryption 353
- service terminal-length 354
- set security-association lifetime 1172
- set session-key 1172
- set transform-set 1173
- sFlow 1036
- sflow collector 1038
- show aaa accounting 690

- 
- show aaa authentication 690
  - show aaa authentication login 691
  - show access-list 356
  - show cli 356
  - show cmlsh multiple-config-session status 412
  - show commands 30
    - exclude modifier 31
    - include modifier 31
    - redirect modifier 32
  - show crypto ipsec transform-set 1175
  - show debug radius 642
  - show debug ssh server 571
  - show debug tacacs+ 623
  - show debug telnet server 558
  - show debugging nsm 359
  - show errdisable details 1110
  - show flowcontrol interface 796
  - show hardware-information 982
  - show hosts 536
  - show ip dhcp relay 462
  - show ip dhcp relay address interface 463
  - show ip forwarding 824
  - show ip interface brief 825
  - show ip prefix-list 845
  - show ip vrf 839
  - show ipv6 dhcp relay 467
  - show ipv6 dhcp relay address 468
  - show ipv6 forwarding 840
  - show ipv6 interface brief 841
  - show ipv6 route 843
  - show list 361
  - show logging 1079
  - show logging last 1081
  - show logging logfile 1082
  - show logging logfile last-index 1083
  - show logging logfile start-seqn end-seqn 1084
  - show logging logfile start-time end-time 1085
  - show max-transaction limit 414
  - show nsm client 363
  - show ntp authentication-keys 608
  - show ntp authentication-status 609
  - show ntp client 610
  - show ntp logging-status 610
  - show ntp peers 613
  - show ntp peer-status 611
  - show ntp statistics 614
  - show ntp status 616
  - show ntp trusted-keys 616
  - show priority-flow-control details 1022
  - show process 364
  - show radius-server 643
  - show role name 428
  - show router-id 1110
  - show running-config 365
  - show running-config aaa 695
  - show running-config dhcp 469
  - show running-config dns 538
  - show running-config interface 848
  - show running-config interface ip 850
  - show running-config interface ipv6 851
  - show running-config ipv6 access-list 853
  - show running-config ntp 617
  - show running-config prefix-list 854
  - show running-config radius 645
  - show running-config snmp 650
  - show running-config ssh server 572
  - show running-config switch 366
  - show running-config syslog 1086
  - show running-config tacacs+ 624
  - show running-config telnet server 559
  - show sflow 1043
  - show sflow interface 1045
  - show snmp 651
  - show snmp community 652
  - show snmp engine-id 654
  - show snmp group 655
  - show snmp host 656
  - show snmp user 657
  - show snmp view 658
  - show ssh server 575
  - show startup-config 368
  - show system restore failures 418
  - show system-information 1003
  - show tacacs-server 625
  - show telnet server 560
  - show tfo 1053
  - show transaction current 419
  - show transaction last-aborted 420
  - show transceivers details 1030
  - show user-account 428
  - show username 576
  - show users 374
  - show version 376
  - show vlog all 1058
  - show vlog clients 1060
  - show vlog terminals 1061
  - show vlog virtual-routers 1062
  - Simple Network Management Protocol 183
  - snmp-server community 660
  - snmp-server contact 662
  - snmp-server enable snmp 665
  - snmp-server enable traps 666
  - snmp-server group 671
  - snmp-server host 671
  - snmp-server location 673
  - snmp-server tcp-session 675
  - snmp-server user 676
  - snmp-server view 678
  - square brackets
    - command syntax 28
  - SSH Client session 50
  - ssh key 582
  - ssh login-attempts 584
  - ssh server port 585
- T**
- tacacs-server deadline 627
-

---

tacacs-server directed-request 627  
tacacs-server host 627  
tacacs-server key 629  
Telnet 555  
telnet server port 563  
time  
    command syntax 28  
traceroute 383  
trigger failover 1055  
Trigger Failover Commands 1047

**U**

username 429  
username keypair 588  
username sshkey 587

**V**

vertical bars  
    command syntax 27  
VLOG commands 1057  
    reset log file 1058  
    show vlog all 1058  
    show vlog clients 1060  
    show vlog terminals 1061  
    show vlog virtual-routers 1062  
VPN Commands  
    ip vrf 779  
    ip vrf forwarding 779  
    show ip vrf 839

**W**

WORD 28  
write terminal 386

