

ipinfusion™

OcNOS®

**Open Compute
Network Operating System
for Service Providers
Version 6.3.5**

Layer 3 Guide

June 2024

© 2024 IP Infusion Inc. All Rights Reserved.

This documentation is subject to change without notice. The software described in this document and this documentation are furnished under a license agreement or nondisclosure agreement. The software and documentation may be used or copied only in accordance with the terms of the applicable agreement. No part of this publication may be reproduced, stored in a retrieval system, or transmitted in any form or any means electronic or mechanical, including photocopying and recording for any purpose other than the purchaser's internal use without the written permission of IP Infusion Inc.

IP Infusion Inc.

3965 Freedom Circle, Suite 200

Santa Clara, CA 95054

+1 408-400-1900

<http://www.ipinfusion.com/>

For support, questions, or comments via E-mail, contact:

support@ipinfusion.com

Trademarks:

IP Infusion and OcNOS are trademarks or registered trademarks of IP Infusion. All other trademarks, service marks, registered trademarks, or registered service marks are the property of their respective owners.

Use of certain software included in this equipment is subject to the IP Infusion, Inc. End User License Agreement at <http://www.ipinfusion.com/license>. By using the equipment, you accept the terms of the End User License Agreement.

Contents

Preface	xxxi
IP Maestro Supportxxxi
Audiencexxxi
Conventionsxxxi
Chapter Organizationxxxi
Related Documentationxxxi
Feature Availabilityxxxii
Migration Guidexxxii
Supportxxxii
Commentsxxxii
Command Line Interface	33
Overview	33
Command Line Interface Help	33
Command Completion	34
Command Abbreviations	34
Command Line Errors	34
Command Negation	35
Syntax Conventions	35
Variable Placeholders	36
Command Description Format	37
Keyboard Operations	37
Show Command Modifiers	38
String Parameters	41
Command Modes	41
Transaction-based Command-line Interface	43
Layer 3 Unicast Configuration Guide	45
CHAPTER 1 BGP	47
Enable BGP Routers in the Same Autonomous System	47
Enable BGP Between Different Autonomous Systems	49
Route-Map	50
Route Reflector	52
Multiple Route Reflectors	56
BGP Confederations	67
Dynamic BGP Peering	81
Enable eBGP Multihop	111
Enable Peer Groups	115
Route Redistribution in BGP	127
Add Multiple Instances of the Same Autonomous System	128
Remove the Multi-Exit Disc Attribute from Update Messages	130
Removing Sent and Received MED values	131
BGP Four-Byte Autonomous System	133

4-Octet ASN Capability Enabled on R1 and R2	133
4-Octet ASN Capability Enabled on R1 and Disabled on R2	134
BGP Extended Community Attribute	137
Nexthop Tracking	158
Nexthop Tracking Delay Timer	160
BGP Distance	167
BGP Weight per Peer	171
OSPF as PE-CE Protocol for VPNs	174
BGP Multipath for IPv4	177
Multipath eBGP	180
Multipath eiBGP	183
6BGP AS-PATH Multipath-relax	188
BGP FIB Install (Selective Route Download)	191
Route Target Constraint	198
BGP Best Path Selection Process	207
BGP Dampening	208
BGP Authentication	215
BGP Unnumbered	217
BGP Blackhole Community Attribute	226
Accumulated Interior Gateway Protocol	229
CHAPTER 2 BGP4+	241
Enable iBGP Peering Using a Global Address	241
Configuration	241
Validation	242
Enable iBGP Peering Using Link-local Address	244
Configuration	244
Validation	245
Enable eBGP Peering Between Different Autonomous Systems	247
Configuration	248
Validation	248
Route-Map	250
Configuration	251
Validation	252
Route Reflector	254
Configuration	255
Validation	256
Confederations	256
Configuration	257
Validation	259
BGP4+ Graceful Restart	259
Configuration	260
Validation	261
Configure BGP4+ Distance	266
Configuration	267
Validation	268
BGP4+ Graceful Reset	268

Configuration	269
Validation	269
VPNv4 NLRI with IPv6 Nexthop	270
Configuration	270
CHAPTER 3 BGP Graceful Restart Configuration	277
CHAPTER 4 BGP Labeled Unicast	285
BGP Labeled Unicast as Transport	285
BGP Labeled Unicast with Seamless MPLS	297
BGP Labeled Unicast with Inter-AS	317
BGP Peer Groups for Address-Family IPv4 Labeled Unicast	330
CHAPTER 5 BGP MPLS Next Hop Tracking Configuration	343
CHAPTER 6 BGP IPv4 Additional Paths Configuration	357
Overview	357
Topology	358
Initial Configuration	358
Additional Paths at the AF Level	362
Additional Paths at the Neighbor Level	371
Additional Path Selection (Best2/Best3)	380
BGP Additional Paths for VPNv4	385
Additional Paths for 6VPE	442
BGP Labeled Unicast IPv4 with Add Path	480
CHAPTER 7 BGP4+ Additional Paths Configuration	599
Overview	599
Topology	600
Additional Paths at the Global Level	604
Additional Paths at the Neighbor Level	605
Additional Paths Send and Receive at Address-family level	610
Additional Paths at the Neighbor Level	610
Selection of all Additional Paths at the Address-family Level	617
Selection of all Additional Paths at the Neighbor Level	617
Selection of Best 2 Additional Paths at AF Level	619
Selection of Best 2 Additional Paths at the Neighbor Level	620
Selection of Best 3 Additional Paths at the AF Level	622
Selection of Best 3 Additional Paths at the Neighbor Level	622
CHAPTER 8 OSPFv2	625
Enable OSPF on an Interface	625
Set Priority	629
Area Border Router	634
Redistribute Routes into OSPF	639
Cost	640
Path MTU for IPv4 and IPv6	646
Virtual Links	648
OSPF Authentication	653
Multiple OSPF Instances	657

Multiple OSPF Instances on Same Subnet.....	667
Multi-Area Adjacency Configuration.....	670
LSA Throttling.....	674
Loop-Free Alternate Fast Reroute.....	685
Loop-Free Alternate (LFA) ECMP PATH.....	695
SNMP Support for Multiple Instance of OSPF Configuration.....	703
OSPF Stub Router Advertisement.....	725
CHAPTER 9 OSPF Sham-link for VPN Sites Configuration.....	733
CHAPTER 10 OSPF TE-Metric Extension.....	743
CHAPTER 11 OSPFv2 LDP Remote Loop-Free Alternate (RLFA).....	751
RLFA Terminology.....	751
Establishing RLFA Tunnel.....	752
Assumptions and Limitations.....	753
Topology.....	753
CHAPTER 12 OSPFv3.....	769
Enable OSPFv3 on an Interface.....	769
Set Priority.....	772
Area Border Router.....	776
Redistribute Routes into OSPFv3.....	782
Cost.....	788
Virtual Links.....	798
Multiple Instances.....	805
Not-So-Stubby Area.....	816
NSSA with the Summary Address Option.....	820
NSSA with the Translator Role Option.....	824
Link LSA Suppression.....	828
Originate Type-7 LSAs and Translate to Type-5.....	830
Summarize Inter-Area and External Routes.....	835
Distribute List.....	840
OSPFv3 Authentication.....	844
CHAPTER 13 IS-IS IPv4.....	851
Enable IS-IS on an Interface.....	851
Set Priority.....	854
Dynamic hostname.....	856
Redistribute Routes into IS-IS.....	858
Metric.....	864
L1-L2 Area Routing with a Single Instance.....	872
L1-L2 Area Routing with Multiple Instances.....	879
Route Leaking.....	884
Route Summarization.....	890
IS-IS Distance.....	895
Passive Interface.....	901
IS-IS IPv4 Loop-Free Alternate Fast Reroute.....	906
Overview.....	906
Basic Configuration.....	907

Backup Path based on Route-Map Prefixes	914
LFA Tie-Breaker	916
LFA Termination	918
LFA For ECMP Paths	921
CHAPTER 14 IS-IS IPv6 Configuration	931
Enable IS-ISv6 on an Interface	931
Set Priority	933
Dynamic hostname	936
Redistribute Routes into IS-IS	938
Interface Metric	941
Route Summarization	945
Passive Interface	951
Enable BFD over IS-ISv6	957
Originate Default Route to ISISv6 Neighbors	959
CHAPTER 15 IS-IS-TE IPv4	963
Enable MPLS-TE in Level-1 and Level-2 on L1-L2 IS	963
Maximum Link Bandwidth and Reservable Bandwidth	969
Administrative Group Constraints	977
CHAPTER 16 IS-IS IPv4 TE-Metric Extension	985
CHAPTER 17 IS-IS Graceful Restart Configuration	991
CHAPTER 18 Forwarding Plane Load Balancing	993
Enable Load Balancing	993
Configuration	993
CHAPTER 19 VLAN Interfaces	997
Overview	997
Create a VLAN Interface	997
CHAPTER 20 Layer 3 Link Aggregation	1001
Configuration	1001
CHAPTER 21 Static Routes	1005
Configuration	1005
IPv6 Static Routing	1010
Configuration	1010
CHAPTER 22 Static Route Discard Configuration	1017
Overview	1017
IPv4 Route Discard	1017
IPv6 Route Discard	1020
CHAPTER 23 Static Route Object Tracking using IP SLA	1025
Topology	1025
Configuration	1026
Validation	1027
CHAPTER 24 RIP	1033
Enable RIP	1033

Specify RIP Version	1037
Authentication with a Single Key	1040
Text Authentication with Multiple Keys	1045
MD5 Authentication with Multiple Keys	1053
RIPV2 VRF Configuration	1060
CHAPTER 25 RIPng	1063
Configuration	1063
CHAPTER 26 Layer 3 Subinterface Configuration	1067
Topology	1067
Creating a Subinterface	1067
CHAPTER 27 Two-way Active Measurement Protocol	1073
CHAPTER 28 Two-way Active Measurement Protocol Server	1083
Topology	1083
Configuration	1083
Validation	1084
CHAPTER 29 Hybrid Switch Router Configuration	1087
Overview	1087
Configuring Layer 2 Interfaces	1090
Configuring Layer 3 Interfaces	1090
CHAPTER 30 Policy Based Routing Configuration	1093
Overview	1093
Topology	1093
IPv4 Configurations for PBR	1094
IPv6 Configurations for PBR	1098
CHAPTER 31 Route-map Continue Configuration	1103
Overview	1103
Topology	1103
Validation	1106
CHAPTER 32 TOS based Queue Distribution Configuration	1111
Precedence-to-queue	1111
Precedence-to-precedence	1112
CHAPTER 33 BGP Flowspec Support for IPv4	1115
Validation	1127
With RR	1192
Fundamental Layer 3 Command Reference	1279
CHAPTER 1 Fundamental Layer 3 Commands	1281
automatic-router-id-selection enable	1282
clear ip route kernel	1283
clear ip route	1284
clear ip route vrf NAME	1285
clear router-id	1286

debug rib	1287
description	1289
fib retain	1290
ip route	1291
ip route vrf <vrf-name>	1294
ip urpf enable	1295
ip urpf allow-default	1296
ip verify unicast source reachable-via	1297
ip vrf	1298
ipv6 route	1299
maximum-paths	1302
max-static-routes	1303
router-id	1304
show debugging rib	1305
show ip route track-table	1306
show ip rpf	1307
Show ipv6 route track-table	1309
show ipv6 rpf	1310
show router-id	1312
show running-config router	1313
show running-config router-id	1314
show running-config urpf	1315
show running-config vrf	1316
snmp restart rib	1317
CHAPTER 2 Route-Map Commands	1319
continue	1321
match as-path	1323
match community	1324
match extcommunity	1325
match interface	1326
match ip address	1327
match ip address prefix-list	1328
match ip next-hop	1329
match ip next-hop prefix-list	1330
match ip peer	1331
match ipv6 address	1332
match ipv6 address prefix-list	1333
match ipv6 next-hop	1334
match ipv6 next-hop prefix-list	1335
match ipv6 peer	1336
match metric	1337
match origin	1338
match route-type	1339
match tag	1340
route-map	1341
set aggregator	1342

set as-path	1343
set atomic-aggregate	1344
set comm-list	1345
set community	1346
set dampening	1348
set extcommunity	1349
set interface null0	1351
set ip next-hop	1352
set ipv6 next-hop	1353
set level	1354
set local-preference	1355
set metric	1356
set metric-type	1357
set origin	1358
set originator-id	1359
set tag	1360
set vpnv4 next-hop	1361
set weight	1362
show route-map	1363
show running-config route-map	1364

VRF Lite Configuration Guide1365

CHAPTER 1 BGP Configuration	1367
Overview	1367
Configuration	1367
CHAPTER 2 VRF Configuration	1371
Overview	1371
Default VRF	1371
User-Defined VRF	1371
CHAPTER 3 Static Inter-VRF Route Leaking Configuration	1375
Overview	1375
Topology	1375
CHAPTER 4 OSPF Configuration	1381
Overview	1381
Configuration IPv4 VRF	1381
CHAPTER 5 ISIS Configuration	1383
Overview	1383
Topology	1383
Configuration IPv4 VRF	1383
CHAPTER 6 ISIS IPv6 VRF Configuration	1387
Overview	1387
Topology	1387
Validation	1388

Border Gateway Protocol Command Reference	1391
CHAPTER 1 BGP Commands	1393
address-family	1397
aggregate-address	1399
auto-summary	1400
bgp aggregate-nexthop-check	1401
bgp always-compare-med	1402
bgp as-local-count	1403
bgp bestpath as-path ignore	1404
bgp bestpath as-path multipath-relax	1405
bgp bestpath compare-confed-asp-path	1406
bgp bestpath compare-routerid	1407
bgp bestpath dont-compare-originator-id	1408
bgp bestpath med	1409
bgp bestpath tie-break-on-age	1411
bgp client-to-client reflection	1412
bgp cluster-id	1413
bgp confederation identifier	1414
bgp confederation peers	1415
bgp config-type	1416
bgp dampening	1417
bgp default local-preference	1419
bgp deterministic-med	1420
bgp enforce-first-as	1421
bgp extended-asn-cap	1422
bgp fast-external-failover	1423
bgp graceful-restart	1424
bgp g-shut	1426
bgp g-shut-capable	1427
bgp g-shut-local-preference	1428
bgp log-neighbor-changes	1429
mpls-nexthop-tracking	1431
bgp nexthop-trigger delay	1432
bgp nexthop-trigger enable	1433
bgp rfc1771-path-select	1434
bgp rfc1771-strict	1435
bgp router-id	1436
bgp scan-time	1437
bgp table-map	1438
bgp update-delay	1440
clear bgp (A.B.C.D X:X::X:X)	1441
clear bgp *	1442
clear bgp * I2vpn evpn	1444
clear bgp <1-4294967295>	1445
clear bgp <1-4294967295> I2vpn evpn	1447
clear bgp A.B.C.D I2vpn evpn	1448

clear bgp dampening	1449
clear bgp external	1450
clear bgp flap-statistics	1452
clear bgp peer-group	1453
clear bgp peer-group WORD l2vpn evpn	1455
clear bgp statistics	1456
clear ip bgp * (description LINE)*	1457
clear ip bgp (A.B.C.D X:X::X:X WORD) (description LINE)	1458
clear ip bgp A.B.C.D	1459
clear ip bgp A.B.C.D vrf	1461
clear ip bgp all vrf (VRFNAME all default) (description LINE)	1462
clear ip bgp table-map	1463
clear ip bgp vrf WORD (A.B.C.D X:X::X:X WORD) (description LINE)	1464
debug bgp	1465
distance bgp	1467
exit-address-family	1468
ip as-path access-list	1469
ip community-list <1-99>	1470
ip community-list <100-500>	1471
ip community-list expanded	1472
ip community-list standard	1473
ip community-list WORD	1474
ip extcommunity-list <1-99>	1475
ip extcommunity-list <100-500>	1476
ip extcommunity-list expanded	1477
ip extcommunity-list standard	1478
l2vpn-unnumbered-mode	1479
match ip peer	1480
match large-community	1481
max-paths	1482
max-paths eigbp	1483
neighbor activate	1485
neighbor advertisement-interval	1486
neighbor allowas-in	1487
neighbor as-origination-interval	1489
neighbor attribute-unchanged	1490
neighbor authentication-key	1491
neighbor capability dynamic	1492
neighbor capability graceful-restart	1493
neighbor capability orf prefix-list	1494
neighbor collide-established	1496
neighbor de-activate	1497
neighbor default-originate	1499
neighbor description	1500
neighbor disallow-infinite-holdtime	1501
neighbor distribute-list	1502
neighbor dont-capability-negotiate	1503

neighbor ebgp-multihop	1504
neighbor enforce-multihop	1505
neighbor extended-optional-param	1506
neighbor fall-over bfd	1507
neighbor filter-list	1508
neighbor g-shut	1509
neighbor g-shut-timer	1510
neighbor limit	1511
neighbor local-as	1512
neighbor maximum-prefix	1513
neighbor next-hop-self	1514
neighbor optional-as	1515
neighbor override-capability	1516
neighbor passive	1517
neighbor peer-group	1518
neighbor WORD peer-group range	1521
neighbor port	1522
neighbor prefix-list	1523
neighbor remote-as	1525
neighbor remove-private-AS	1527
neighbor restart-time	1528
neighbor route-map	1529
neighbor route-reflector-client	1531
neighbor route-server-client	1532
neighbor send-community	1533
neighbor send-community large	1534
neighbor shutdown	1535
neighbor strict-capability-match	1537
neighbor timers	1538
neighbor unsuppress-map	1540
neighbor update-source	1541
neighbor version	1542
neighbor weight	1543
neighbor WORD peer-group	1545
network	1546
network synchronization	1548
redistribute	1549
restart bgp graceful	1551
router bgp	1552
set large-community	1553
snmp restart bgp	1554
synchronization	1555
timers bgp	1556
v4-unnumbered-mode	1557
undebg bgp	1558
bgp unnumbered-mode	1559

CHAPTER 2	BGP Additional Paths Commands	1561
	bgp additional-paths	1562
	bgp additional-paths install	1563
	neighbor additional-paths	1564
	neighbor advertise additional-paths	1565
CHAPTER 3	BGP Graceful Restart Commands	1567
	bgp graceful-restart	1568
	bgp g-shut	1570
	bgp g-shut-capable	1571
	bgp g-shut-local-preference	1572
	bgp update-delay	1573
	neighbor capability graceful-restart	1574
	neighbor g-shut	1575
	neighbor g-shut-timer	1576
	neighbor restart-time	1577
CHAPTER 4	BGP Labeled Unicast Commands	1579
	address-family labeled-unicast	1580
	allocate-label	1582
	clear ip bgp A.B.C.D ipv4 labeled-unicast	1583
	clear ip bgp peer-group WORD ipv4 labeled-unicast	1584
	clear ip bgp * ipv4 labeled-unicast	1585
CHAPTER 5	BGP4+ Commands	1587
	aggregate-address X:X::X:X/M	1589
	clear bgp * ipv6	1591
	clear bgp ipv6 (A.B.C.D X:X::X:X)	1593
	clear bgp ipv6 <1-4294967295>	1594
	clear bgp ipv6 external	1595
	clear bgp ipv6 peer-group	1596
	clear bgp ipv6 unicast flap-statistics	1597
	clear ipv6 bgp * vrf	1598
	clear ipv6 bgp X:X::X:X vrf	1599
	clear ip bpg ipv6 unicast table-map	1600
	network X:X::X:X	1601
CHAPTER 6	BGP Virtual Private Network Commands	1603
	bgp inbound-route-filter	1604
	clear bgp * I2vpn vpls	1605
	clear ip bgp * vpv4	1606
	clear bgp <1-4294967295> I2vpn vpls	1607
	clear ip bgp <1-4294967295> vpv4	1608
	clear bgp A.B.C.D I2vpn vpls	1609
	clear ip bgp A.B.C.D vpv4	1610
	debug bgp mpls	1611
	export map	1612
	import map	1613
	ip vrf	1614

neighbor allow-ebgp-vpn	1615
neighbor as-override	1616
neighbor send-community	1617
neighbor soo	1618
rd (route distinguisher)	1619
route-target	1620
CHAPTER 7 BGP Show Commands	1621
show bgp	1623
show bgp A.B.C.D	1624
show bgp A.B.C.D/M	1626
show bgp client	1627
show bgp community	1628
show bgp community-list	1630
show bgp dampening dampened-paths	1631
show bgp dampening flap-statistics	1633
show bgp dampening parameters	1635
show bgp filter-list	1637
show bgp inconsistent-as	1639
show bgp ipv6	1640
show bgp ipv6 peer-group	1643
show bgp l2vpn vpls	1644
show bgp neighbors	1647
show bgp neighbors advertised-routes	1651
show bgp neighbors received prefix-filter	1652
show bgp neighbors received-routes	1653
show bgp neighbors routes	1655
show bgp nexthop-tracking	1657
show bgp nexthop-tree-details	1659
show bgp paths	1660
show bgp prefix-list	1661
show bgp quote-regexp	1662
show bgp regexp	1663
show bgp route-map	1664
show bgp statistics	1665
show bgp summary	1667
show bgp X:X::X:X	1670
show bgp X:X::X:X/M longer prefixes	1671
show debugging bgp	1672
show ip bgp	1673
show ip bgp cidr-only	1676
show ip bgp community-info	1677
show ip bgp peer-group	1678
show ip bgp peer-group vrf all	1679
show ip bgp rfilter all	1680
show ip bgp scan	1681
show ip bgp vpnv4	1682

show ip bgp vpnv6 all neighbors	1686
show ip bgp vpnv6 rd neighbors	1690
show ip extcommunity-list	1692
show ip protocols	1693
show ip vrf	1695
show running-config as-path access-list	1696
show running-config community-list	1697
CHAPTER 8 BGP Flowspec Commands	1699
address-family	1700
address-family ipv4 flowspec vrf	1701
class-map type traffic match-all	1702
drop	1703
flowspec	1704
hardware filter ipv4-bgp-flowspec	1705
local-install	1706
match dscp	1707
match destination-address	1708
match destination-port	1709
match fragment-type	1710
match icmp-code	1711
match icmp-type	1712
match packet-length	1713
match port	1714
match protocol	1715
match source-address	1716
match source-port	1717
match tcp-flag	1718
neighbor flowspec-validation-disable	1719
policy-map	1720
police rate	1721
policy-map class type traffic	1722
redirect	1723
set dscp	1724
service-policy type pbr	1725
show ip bgp	1726
vrf	1733
Appendix A Regular Expressions	1735
Open Shortest Path First Command Reference	1737
CHAPTER 1 OSPFv2 Commands	1739
area authentication	1743
area default-cost	1744
area filter-list	1745
area interface	1746
area interface authentication	1747

area interface cost	1748
area interface database-filter	1749
area interface dead-interval	1750
area interface IFNAME bfd	1751
area interface IFNAME priority	1752
area interface hello-interval	1753
area interface mpls ldp-igp	1754
area interface mpls ldp-igp sync ospf holddown-timer	1755
area interface network-type	1756
area interface passive	1757
area interface retransmit-interval	1758
area interface te-metric	1759
area nssa	1760
area range	1762
area sham-link	1763
area shortcut	1764
area stub	1765
area virtual-link	1766
auto-cost reference bandwidth	1769
bfd all-interfaces	1770
capability cspf	1771
capability lls	1772
capability opaque	1773
capability traffic-engineering	1774
capability vrf-lite	1775
clear ip ospf	1776
compatible rfc1583	1777
debug ip ospf dist-ls	1778
debug ip ospf lfa	1779
debug ip ospf redist	1780
debug ip ospf retransmission	1781
debug ospf	1782
debug ospf database-timer rate-limit	1784
debug ospf events	1785
debug ospf ifsm	1786
debug ospf lsa	1787
debug ospf nfsm	1788
debug ospf nsm	1789
debug ospf packet	1790
debug ospf rib	1791
debug ospf route	1792
default-information originate	1793
default-metric	1795
distance	1796
distribute-list	1797
enable db-summary-opt	1799
enable ext-ospf-multi-inst	1800

fast-reroute keep-all-paths	1801
fast-reroute per-prefix remote-lfa area	1802
fast-reroute per-prefix route-map	1803
fast-reroute terminate-hold-on interval	1804
fast-reroute tie-break	1805
host area	1807
ip ospf authentication	1808
ip ospf authentication-key	1809
ip ospf bfd	1811
ip ospf cost	1812
ip ospf database-filter	1813
ip ospf dead-interval	1814
ip ospf demand-circuit	1815
ip ospf disable	1816
ip ospf fast-reroute per-prefix candidate disable	1817
ip ospf flood-reduction	1818
ip ospf hello-interval	1819
ip ospf multi-area	1820
ip ospf message-digest-key	1821
ip ospf mtu	1823
ip ospf mtu-ignore	1824
ip ospf network	1825
ip ospf priority	1826
ip ospf resync-timeout	1827
ip ospf retransmit-interval	1828
ip ospf transmit-delay	1829
log-adjacency-changes	1830
max-concurrent-dd	1831
maximum-area	1832
neighbor	1833
network	1834
ospf abr-type	1836
ospf area-interface-config-mode	1837
ospf flood-reduction	1838
ospf point-point rfc-incompatible	1839
ospf router-id	1840
overflow database	1841
overflow database external	1842
passive-interface	1843
redistribute	1844
router ospf	1846
show cspf rsvp forwarding-timer	1847
show debugging ospf	1848
show ip ospf	1849
show ip ospf border-routers	1853
show ip ospf database brief	1854
show ip ospf database detail	1856

show ip ospf igp-shortcut-lsp	1863
show ip ospf igp-shortcut-route	1864
show ip ospf interface	1865
show ip ospf multi-area-adjacencies	1868
show ip ospf neighbor	1870
show ip ospf route	1874
show ip ospf sham-links	1876
show ip ospf valid	1878
show ip ospf virtual-links	1879
show ip protocols	1881
show ip route fast-reroute	1883
shutdown	1884
snmp context-name	1885
snmp restart ospf	1886
summary-address	1887
te-metric	1888
timers lsa arrival	1889
timers spf exp	1890
timers throttle lsa	1891
CHAPTER 2 OSPFv2 Graceful Restart Commands	1893
action interface	1894
capability restart	1895
debug ip ospf graceful-restart	1896
event nbr	1897
if-event-track ospf event	1898
ospf restart grace-period	1899
ospf restart helper	1900
restart ip ospf graceful	1901
CHAPTER 3 OSPFv3 Commands	1903
abr-type	1905
area default-cost	1906
area nssa	1907
area range	1909
area stub	1910
area virtual-link	1911
auto-cost reference bandwidth	1913
bfd all-interfaces	1914
clear ipv6 ospf process	1915
debug ipv6 ospf	1916
debug ipv6 ospf bfd	1917
debug ipv6 ospf events	1918
debug ipv6 ospf ifsm	1919
debug ipv6 ospf lsa	1920
debug ipv6 ospf n fsm	1921
debug ipv6 ospf nsm	1922
debug ipv6 ospf packet	1923

debug ipv6 ospf retransmission	1924
debug ipv6 ospf rib	1925
debug ipv6 ospf route	1926
default-information originate	1927
default-metric	1929
distance	1930
distribute bgp-ls	1931
distribute-list	1932
enable db-summary-opt	1934
ipv6 ospf authentication	1935
ipv6 ospf bfd	1936
ipv6 ospf cost	1937
ipv6 ospf dead-interval	1938
ipv6 ospf display route single-line	1939
ipv6 ospf hello-interval	1940
ipv6 ospf link-lsa-suppression	1941
ipv6 ospf mtu	1942
ipv6 ospf mtu-ignore	1943
ipv6 ospf neighbor	1944
ipv6 ospf network	1946
ipv6 ospf priority	1947
ipv6 ospf retransmit-interval	1948
ipv6 ospf transmit-delay	1949
ipv6 router ospf	1950
ipv6 te-metric	1952
log-adjacency-changes	1953
max-concurrent-dd	1954
passive-interface	1955
redistribute	1956
router-id	1958
router ipv6 ospf	1959
show debugging ipv6 ospf	1960
show ipv6 ospf	1961
show ipv6 ospf database	1963
show ipv6 ospf interface	1967
show ipv6 ospf neighbor	1969
show ipv6 ospf route	1972
show ipv6 route fast-reroute	1974
show ipv6 ospfv3 topology	1975
show ipv6 ospf virtual-links	1977
show ipv6 vrf	1979
shutdown	1980
snmp restart ospf6	1981
summary-address	1982
timers spf exp	1984

CHAPTER 4	OSPFv3 Graceful Restart Commands	1985
	capability restart	1986
	ipv6 ospf restart grace-period	1987
	ipv6 ospf restart helper	1988
	ipv6 ospf restart planned-only	1989
	restart ipv6 ospf graceful	1990
CHAPTER 5	OSPF VPN Commands	1991
	capability vrf-lite	1992
	router ospf vrf	1993
	domain-id	1994
CHAPTER 6	CSPF-TE Commands	1997
	cspf default-retry-interval	1998
	cspf disable-better-protection	1999
	cspf enable-better-protection	2000
	cspf enable-resource-constraint-crankback	2001
	cspf tie-break	2002
Intermediate System to Intermediate System Command Reference		2003
CHAPTER 1	IS-IS Commands	2005
	accept-lifetime	2008
	address-family ipv6	2010
	adjacency-check	2011
	area-password	2012
	authentication key-chain	2013
	authentication mode	2014
	authentication send-only	2015
	bfd all-interfaces	2016
	capability cspf	2017
	clear clns neighbors	2018
	clear clns is-neighbors	2019
	clear ip isis route	2020
	clear isis adjacency	2021
	clear isis counter	2022
	clear isis interface counter	2023
	clear isis process	2024
	debug isis	2025
	default-information originate	2027
	distance (IPv4)	2028
	distance (IPv6)	2029
	domain-password	2030
	dynamic-hostname	2031
	fast-reroute per-prefix	2032
	fast-reroute per-prefix remote-lfa	2033
	fast-reroute terminate-hold-on interval	2034
	fast-reroute tie-break	2035
	ignore-lsp-errors	2037

ip router isis	2038
ipv6 router isis	2039
isis authentication key-chain	2040
isis authentication mode md5	2041
isis authentication send-only	2042
isis bfd	2043
isis circuit-type	2044
isis csnp-interval	2045
isis fast-reroute per-prefix candidate disable	2046
isis hello-interval	2047
isis hello-multiplier	2048
isis hello padding	2049
isis lsp-interval	2050
isis mesh-group	2051
isis metric	2052
isis network	2053
isis password	2054
isis priority	2055
isis retransmit-interval	2056
ispf	2057
isis wait-timer	2058
isis wide-metric	2059
isis tag	2060
isis te-metric	2061
is-type	2062
key chain	2063
key-id	2064
key-string	2065
key-string encrypted	2066
lsp-gen-interval	2067
lsp-mtu	2068
lsp-refresh-interval	2069
max-area-address	2070
max-lsp-lifetime	2071
metric-style	2072
mpls traffic-eng	2074
mpls traffic-eng router-id	2075
net	2076
passive-interface	2077
prc-interval-exp	2078
redistribute	2079
redistribute isis	2081
redistribute isis WORD	2082
router isis	2083
send-lifetime	2084
snmp restart isis	2086
spf-interval-exp	2087

summary-address	2088
summary-prefix	2089
CHAPTER 2 IS-IS Graceful Restart Commands	2091
capability restart graceful	2092
isis restart grace-period	2093
isis restart-hello-interval	2094
isis restart helper	2095
isis restart suppress-adjacency	2096
restart isis graceful	2097
restart-timer	2098
CHAPTER 3 IS-IS Microloop-Avoidance Commands	2099
microloop-avoidance	2100
microloop-avoidance hold-timer	2101
microloop-avoidance max-fib	2102
show isis microloop-avoidance	2103
CHAPTER 4 IS-IS Show Commands	2105
show clns is-neighbors	2106
show clns neighbors	2108
show cspf rsvp forwarding-timer	2110
show debugging isis	2111
show ip isis igp-shortcut-lsp	2112
show ip isis route	2113
show ip isis route igp-shortcut	2115
show ip protocols	2117
show ip route fast-reroute	2118
show ip isis route fast-reroute	2119
show ip isis lfa-config	2120
show ipv6 isis topology	2121
show isis counter	2123
show isis database	2124
show isis interface	2127
show isis microloop-avoidance	2130
show isis spf-logs	2132
show isis topology	2133
show running-config interface isis	2135
show running-config router isis	2136
Routing Information Protocol Command Reference	2137
CHAPTER 1 Routing Information Protocol Commands	2139
accept-lifetime	2141
cisco-metric-behavior	2143
clear ip rip route	2144
clear ip rip route vrf NAME	2145
clear ip rip statistics	2146
debug rip	2147

default-information originate	2149
default-metric	2150
distance	2151
distribute-list	2152
ip rip authentication key-chain	2153
ip rip authentication mode	2154
ip rip authentication string	2155
ip rip receive-packet	2156
ip rip receive version	2157
ip rip send-packet	2158
ip rip send version	2159
ip rip split-horizon	2160
key-id	2161
key chain	2162
key-string	2163
key-string encrypted	2164
maximum-prefix	2165
neighbor	2166
network	2167
offset-list	2168
passive-interface	2169
rcv-buffer-size	2170
redistribute	2171
route	2173
router rip	2174
send-lifetime	2175
show debugging rip	2176
show ip protocols rip	2177
show ip rip	2179
show ip rip interface	2181
show ip rip statistics	2183
snmp restart rip	2185
timers basic	2186
version	2187
CHAPTER 2 RIPng Commands	2189
aggregate-address	2190
cisco-metric-behavior	2191
clear ipv6 rip route	2192
debug ipv6 rip	2193
default-information originate	2195
default-metric	2196
distance	2197
distribute-list	2198
ipv6 rip metric-offset	2199
ipv6 rip split-horizon	2200
ipv6 router rip	2201

neighbor	2202
offset-list	2203
passive-interface	2204
recv-buffer-size	2205
redistribute	2206
route	2207
route-map	2208
router ipv6 rip	2209
show debugging ipv6 rip	2210
show ipv6 protocols rip	2211
show ipv6 rip	2212
show ipv6 rip interface	2213
timers basic	2214
CHAPTER 3 Routing Information Protocol VPN Commands	2215
show ip rip interface vrf	2216
show ip rip vrf	2218
show ip vrf	2220
Appendix A Routing Information Protocol Authentication	2221
Single Key Authentication	2221
Multiple Keys Authentication	2221
Two-Way Active Measurement Protocol Command Reference	2223
CHAPTER 1 TWAMP Commands	2225
control-admin-state	2226
reflector-admin-state	2227
reflector-name	2228
show debugging twamp	2229
show running-config twamp	2230
show twamp server sessions information	2231
show twamp statistics	2232
show twamp server status	2234
test-session-name (Deprecated)	2235
twamp-light control	2237
twamp-light reflector	2238
twamp server	2239
twamp server port	2240
twamp server max-connection-duration	2241
twamp server max-connections	2242
twamp server max-connections-per-client	2243
twamp server maximum-sessions	2244
twamp server maximum-sessions-per-connection	2245
twamp server inactivity-timeout	2246
twamp server listen-vrf	2247
twamp server admin state	2248
twamp start-test-session (Deprecated)	2249

twamp stop-test-session (Deprecated)	2250
Show twamp server connections information	2251
Layer 3 Subinterface Commands	2253
CHAPTER 1 Layer 3 Subinterface Commands	2255
encapsulation	2256
interface IFNAME.SUBINTERFACE_ID	2257
show interface IFNAME.SUBINTERFACE_ID	2258
Neighbor Discovery Configuration Guide	2261
CHAPTER 3 Neighbor Discovery Configuration	2263
ARP/Neighbor Discovery Operation	2263
Configuring ARP for IPv4	2264
Configuring Neighbor Discovery for IPv6	2265
Neighbor Discovery Command Reference	2267
CHAPTER 1 Neighbor Discovery Commands	2269
arp-ageing-timeout	2270
arp-reachable-time	2271
clear arp	2272
clear ipv6 neighbors	2273
debug ip arp	2274
debug ipv6 nd	2275
ip arp	2276
ip arp vrf	2277
ip proxy-arp	2278
ipv6 nd current-hoplimit	2279
ipv6 nd link-mtu	2280
ipv6 nd managed-config-flag	2281
ipv6 nd other-config-flag	2282
ipv6 nd prefix	2283
ipv6 nd ra-interval	2285
ipv6 nd ra-lifetime	2286
ipv6 nd reachable-time	2287
ipv6 nd retransmission-time	2288
ipv6 nd suppress-ra	2289
ipv6 neighbor	2290
nd-ageing-timeout	2291
nd-reachable-time	2292
no debug all	2293
show arp	2294
show debugging ip arp	2296
show debugging ipv6 nd	2297
show ipv6 neighbors	2298

Bidirectional Forwarding Detection Configuration Guide	2301
CHAPTER 1 Base BFD Configuration	2303
Validation:	2307
Validation:	2309
CHAPTER 2 BFD Protocol Configurations.	2313
OSPF—BFD Single-Hop Session	2313
OSPF—BFD Multi-Hop Session	2322
BFD Configuration in IS-IS	2326
BFD Configuration in BGP	2329
CHAPTER 3 BFD Static Route Configuration	2339
CHAPTER 4 BFD Authentication	2343
Overview	2343
CHAPTER 5 BFD with VRF Configuration	2349
Topology	2349
BFD Over Static Routing IPv4 and IPv6	2356
Bidirectional Forwarding Detection Command Reference	2361
CHAPTER 1 Bidirectional Forwarding Commands	2363
accept-lifetime	2364
bfd auth type	2366
bfd	2367
bfd echo	2368
bfd echo interval	2369
bfd echo ipv4 source	2370
bfd interval	2371
bfd multihop-peer	2372
bfd multihop-peer A.B.C.D interval	2374
bfd multihop-peer X:X::X:X interval	2375
bfd notification	2376
bfd session	2377
bfd slow-timer	2378
debug bfd	2379
hardware-profile micro-bfd	2380
hardware-profile seamless-bfd	2381
key-id	2382
key chain	2383
key-string	2384
key-string encrypted	2385
send-lifetime	2386
show bfd	2387
show bfd interface	2388
show bfd session	2390
show bfd session A.B.C.D	2394
show bfd session ipv6	2397

show debugging bfd	2400
snmp restart bfd	2401
CHAPTER 2 Protocol Commands for BFD	2403
area virtual-link	2404
bfd all-interfaces	2405
debug bgp bfd	2406
debug isis bfd	2407
debug ospf bfd	2408
ip ospf bfd	2409
isis bfd	2410
CHAPTER 3 BFD Static Route Commands	2411
ip bfd static all-interfaces	2412
ip static fall-over-bfd	2413
ip static bfd	2414
ipv6 bfd static all-interfaces	2415
ipv6 static fall-over-bfd	2416
ipv6 static bfd	2417
Virtual Router Redundancy Protocol Configuration Guide	2419
CHAPTER 1 VRRP Configuration	2421
Terminology	2421
VRRP Process	2421
One Virtual Router	2423
Two Virtual Routers	2426
Two Backup Routers	2430
Interface Tracking	2435
VRRP-Backward Compatibility	2442
Redundancy Using VRRP and OSPF: Two Virtual Routers	2445
VRRP Over MLAG	2450
CHAPTER 2 Object Tracking Using IP SLA	2459
Topology	2460
Validation	2462
CHAPTER 3 VRRP IPv6 Configuration	2467
Configuration	2467
Disabling the Master	2470
GLOBAL IPV6 SUPPORT FOR VRRP	2471
Virtual Router Redundancy Protocol Command Reference	2477
CHAPTER 1 VRRP Commands	2479
accept-mode	2480
advertisement-interval	2481
authentication text	2482
circuit-failover	2483
debug vrrp	2484

disable	2485
enable	2486
ipv4-exclude-pseudo-header	2487
ip pim redundancy	2488
operational-ip	2489
preempt-mode	2490
priority	2491
router vrrp	2492
show debugging vrrp	2493
show running-config vrrpv6	2494
show running-config router vrrp	2495
show vrrp	2496
show vrrp summary	2498
show vrrp	2499
show vrrp (global ipv4) statistics	2500
snmp restart vrrp	2501
switch-back-delay	2502
track decrement	2503
undebg vrrp	2504
virtual-ip	2505
vrrp compatible-v2	2506
vrrp ipv4-exclude-pseudo-header	2507
vrrp vmac	2508
CHAPTER 2 VRRP v6 Commands	2509
advertisement-interval	2510
circuit-failover	2511
disable	2512
enable	2513
preempt-mode	2514
priority	2515
router ipv6 vrrp	2516
router ipv6 vrrp vlan	2517
show running-config router ipv6 vrrp	2518
virtual-ipv6	2519
Index	2521

Preface

This guide describes how to configure OcNOS.

IP Maestro Support

Monitor devices running OcNOS Release 6.3.4-70 and above using IP Maestro software.

Audience

This guide is intended for network administrators and other engineering professionals who configure OcNOS.

Conventions

[Table P-1](#) shows the conventions used in this guide.

Table P-1: Conventions

Convention	Description
Italics	Emphasized terms; titles of books
Note:	Special instructions, suggestions, or warnings
<code>monospaced type</code>	Code elements such as commands, parameters, files, and directories

Chapter Organization

The chapters in command references are organized as described in [Command Description Format](#).

The chapters in configuration guides are organized into these major sections:

- An overview that explains a configuration in words
 - Topology with a diagram that shows the devices and connections used in the configuration
 - Configuration steps in a table for each device where the left-hand side shows the commands you enter and the right-hand side explains the actions that the commands perform
 - Validation which shows commands and their output that verify the configuration
-

Related Documentation

For information about installing OcNOS, see the *Installation Guide* for your platform.

Feature Availability

The features described in this document that are available depend upon the OcNOS SKU that you purchased. See the *Feature Matrix* for a description of the OcNOS SKUs.

Migration Guide

Check the *Migration Guide* for configuration changes to make when migrating from one version of OcNOS to another.

Support

For support-related questions, contact support@ipinfusion.com.

Comments

If you have comments, or need to report a problem with the content, contact techpubs@ipinfusion.com.

Command Line Interface

This chapter introduces the OcNOS Command Line Interface (CLI) and how to use its features.

Overview

You use the CLI to configure, monitor, and maintain OcNOS devices. The CLI is text-based and each command is usually associated with a specific task.

You can give the commands described in this manual locally from the console of a device running OcNOS or remotely from a terminal emulator such as `putty` or `xterm`. You can also use the commands in scripts to automate configuration tasks.

Command Line Interface Help

You access the CLI help by entering a full or partial command string and a question mark “?”. The CLI displays the command keywords or parameters along with a short description. For example, at the CLI command prompt, type:

```
> show ?
```

The CLI displays this keyword list with short descriptions for each keyword:

```
show ?
  application-priority      Application Priority
  arp                      Internet Protocol (IP)
  bfd                      Bidirectional Forwarding Detection (BFD)
  bgp                      Border Gateway Protocol (BGP)
  bi-lsp                   Bi-directional lsp status and configuration
  bridge                   Bridge group commands
  ce-vlan                  COS Preservation for Customer Edge VLAN
  class-map                Class map entry
  cli                     Show CLI tree of current mode
  clns                    Connectionless-Mode Network Service (CLNS)
  control-adjacency       Control Adjacency status and configuration
  control-channel         Control Channel status and configuration
  cspf                    CSPF Information
  customer                Display Customer spanning-tree
  cvlan                   Display CVLAN information
  debugging               Debugging functions (see also 'undebug')
  etherchannel            LACP etherchannel
  ethernet                Layer-2
  ...
```

If you type the ? in the middle of a keyword, the CLI displays help for that keyword only.

```
> show de?
debugging Debugging functions (see also 'undebug')
```

If you type the ? in the middle of a keyword, but the incomplete keyword matches several other keywords, OcNOS displays help for all matching keywords.

```
> show i? (CLI does not display the question mark).
interface Interface status and configuration
ip IP information
isis ISIS information
```

Command Completion

The CLI can complete the spelling of a command or a parameter. Begin typing the command or parameter and then press the tab key. For example, at the CLI command prompt type `sh`:

```
> sh
```

Press the tab key. The CLI displays:

```
> show
```

If the spelling of a command or parameter is ambiguous, the CLI displays the choices that match the abbreviation. Type `show i` and press the tab key. The CLI displays:

```
> show i
  interface ip          ipv6          isis
> show i
```

The CLI displays the `interface` and `ip` keywords. Type `n` to select `interface` and press the tab key. The CLI displays:

```
> show in
> show interface
```

Type `?` and the CLI displays the list of parameters for the `show interface` command.

```
> show interface
  IFNAME  Interface name
  |       Output modifiers
  >       Output redirection
  <cr>
```

The CLI displays the only parameter associated with this command, the `IFNAME` parameter.

Command Abbreviations

The CLI accepts abbreviations that uniquely identify a keyword in commands. For example:

```
> sh int xe0
```

is an abbreviation for:

```
> show interface xe0
```

Command Line Errors

Any unknown spelling causes the CLI to display the error `Unrecognized command` in response to the `?`. The CLI displays the command again as last entered.

```
> show dd?
% Unrecognized command
> show dd
```

When you press the Enter key after typing an invalid command, the CLI displays:

```
(config)#router ospf here
                        ^
% Invalid input detected at '^' marker.
```

where the `^` points to the first character in error in the command.

If a command is incomplete, the CLI displays the following message:

```
> show
% Incomplete command.
```

Some commands are too long for the display line and can wrap mid-parameter or mid-keyword, as shown below. This does *not* cause an error and the command performs as expected:

```
area 10.10.0.18 virtual-link 10.10.0.19 authent
ication-key 57393
```

Command Negation

Many commands have a `no` form that resets a feature to its default value or disables the feature. For example:

- The `ip address` command assigns an IPv4 address to an interface
- The `no ip address` command removes an IPv4 address from an interface

Syntax Conventions

[Table P-2](#) describes the conventions used to represent command syntax in this reference.

Table P-2: Syntax conventions

Convention	Description	Example
monospaced font	Command strings entered on a command line	<code>show ip ospf</code>
lowercase	Keywords that you enter exactly as shown in the command syntax.	<code>show ip ospf</code>
UPPERCASE	See Variable Placeholders	<code>IFNAME</code>
()	Optional parameters, from which you must select one. Vertical bars delimit the selections. Do not enter the parentheses or vertical bars as part of the command.	<code>(A.B.C.D <0-4294967295>)</code>
()	Optional parameters, from which you select one or none. Vertical bars delimit the selections. Do not enter the parentheses or vertical bars as part of the command.	<code>(A.B.C.D <0-4294967295>)</code>
()	Optional parameter which you can specify or omit. Do not enter the parentheses or vertical bar as part of the command.	<code>(IFNAME)</code>
{ }	Optional parameters, from which you must select one or more. Vertical bars delimit the selections. Do not enter the braces or vertical bars as part of the command.	<code>{intra-area <1-255> inter-area <1-255> external <1-255>}</code>

Table P-2: Syntax conventions (Continued)

Convention	Description	Example
[]	Optional parameters, from which you select zero or more. Vertical bars delimit the selections. Do not enter the brackets or vertical bars as part of the command.	[<1-65535> AA:NN internet local-AS no-advertise no-export]
?	Nonrepeatable parameter. The parameter that follows a question mark can only appear once in a command string. Do not enter the question mark as part of the command.	?route-map WORD
.	Repeatable parameter. The parameter that follows a period can be repeated more than once. Do not enter the period as part of the command.	set as-path prepend .<1-65535>

Variable Placeholders

Table P-3 shows the tokens used in command syntax use to represent variables for which you supply a value.

Table P-3: Variable placeholders

Token	Description
WORD	A contiguous text string (excluding spaces)
LINE	A text string, including spaces; no other parameters can follow this parameter
IFNAME	Interface name whose format varies depending on the platform; examples are: eth0, Ethernet0, ethernet0, xe0
A.B.C.D	IPv4 address
A.B.C.D/M	IPv4 address and mask/prefix
X:X::X:X	IPv6 address
X:X::X:X/M	IPv6 address and mask/prefix
HH:MM:SS	Time format
AA:NN	BGP community value
XX:XX:XX:XX:XX:XX	MAC address
<1-5> <1-65535> <0-2147483647> <0-4294967295>	Numeric range

Command Description Format

Table P-4 explains the sections used to describe each command in this reference.

Table P-4: Command descriptions

Section	Description
Command Name	The name of the command, followed by what the command does and when should it be used
Command Syntax	The syntax of the command
Parameters	Parameters and options for the command
Default	The state before the command is executed
Command Mode	The mode in which the command runs; see Command Modes
Example	An example of the command being executed

Keyboard Operations

Table P-5 lists the operations you can perform from the keyboard.

Table P-5: Keyboard operations

Key combination	Operation
Left arrow or Ctrl+b	Moves one character to the left. When a command extends beyond a single line, you can press left arrow or Ctrl+b repeatedly to scroll toward the beginning of the line, or you can press Ctrl+a to go directly to the beginning of the line.
Right arrow or Ctrl-f	Moves one character to the right. When a command extends beyond a single line, you can press right arrow or Ctrl+f repeatedly to scroll toward the end of the line, or you can press Ctrl+e to go directly to the end of the line.
Esc, b	Moves back one word
Esc, f	Moves forward one word
Ctrl+e	Moves to end of the line
Ctrl+a	Moves to the beginning of the line
Ctrl+u	Deletes the line
Ctrl+w	Deletes from the cursor to the previous whitespace
Alt+d	Deletes the current word
Ctrl+k	Deletes from the cursor to the end of line
Ctrl+y	Pastes text previously deleted with Ctrl+k, Alt+d, Ctrl+w, or Ctrl+u at the cursor

Table P-5: Keyboard operations (Continued)

Key combination	Operation
Ctrl+t	Transposes the current character with the previous character
Ctrl+c	Ignores the current line and redisplay the command prompt
Ctrl+z	Ends configuration mode and returns to exec mode
Ctrl+l	Clears the screen
Up Arrow or Ctrl+p	Scroll backward through command history
Down Arrow or Ctrl+n	Scroll forward through command history

Show Command Modifiers

You can use two tokens to modify the output of a `show` command. Enter a question mark to display these tokens:

```
# show users ?
  | Output modifiers
  > Output redirection
```

You can type the | (vertical bar character) to use output modifiers. For example:

```
> show rsvp | ?
begin      Begin with the line that matches
exclude    Exclude lines that match
include    Include lines that match
last       Last few lines
redirect   Redirect output
```

Begin Modifier

The `begin` modifier displays the output beginning with the first line that contains the input string (everything typed after the `begin` keyword). For example:

```
# show running-config | begin xe1
...skipping
interface xe1
  ipv6 address fe80::204:75ff:fee6:5393/64
!
interface xe2
  ipv6 address fe80::20d:56ff:fe96:725a/64
!
line con 0
  login
!
end
```

You can specify a regular expression after the `begin` keyword. This example begins the output at a line with either “xe2” or “xe4”:

```
# show running-config | begin xe[3-4]
...skipping
```

```

interface xe3
 shutdown
 !
interface xe4
 shutdown
 !
interface svlan0.1
 no shutdown
 !
route-map myroute permit 3
 !
route-map mymap1 permit 10
 !
route-map rmap1 permit 3
 !
line con 0
 login
line vty 0 4
 login
 !
end

```

Include Modifier

The `include` modifier includes only those lines of output that contain the input string. In the output below, all lines containing the word “input” are included:

```

# show interface xe1 | include input
input packets 80434552, bytes 2147483647, dropped 0, multicast packets 0
input errors 0, length 0, overrun 0, CRC 0, frame 0, fifo 1, missed 0

```

You can specify a regular expression after the `include` keyword. This examples includes all lines with “input” or “output”:

```

#show interface xe0 | include (in|out)put
input packets 597058, bytes 338081476, dropped 0, multicast packets 0
input errors 0, length 0, overrun 0, CRC 0, frame 0, fifo 0, missed 0
output packets 613147, bytes 126055987, dropped 0
output errors 0, aborted 0, carrier 0, fifo 0, heartbeat 0, window 0

```

Exclude Modifier

The `exclude` modifier excludes all lines of output that contain the input string. In the following output example, all lines containing the word “input” are excluded:

```

# show interface xe1 | exclude input
Interface xe1
Scope: both
Hardware is Ethernet, address is 0004.75e6.5393
index 3 metric 1 mtu 1500 <UP,BROADCAST,RUNNING,MULTICAST>
VRF Binding: Not bound
Administrative Group(s): None
DSTE Bandwidth Constraint Mode is MAM
inet6 fe80::204:75ff:fee6:5393/64
output packets 4438, bytes 394940, dropped 0
output errors 0, aborted 0, carrier 0, fifo 0, heartbeat 0, window 0
collisions 0

```

You can specify a regular expression after the `exclude` keyword. This example excludes lines with “output” or “input”:

```
# show interface xe0 | exclude (in|out)put
Interface xe0
  Scope: both
  Hardware is Ethernet Current HW addr: 001b.2139.6c4a
  Physical:001b.2139.6c4a Logical:(not set)
  index 2 metric 1 mtu 1500 duplex-full arp ageing timeout 3000
  <UP,BROADCAST,RUNNING,MULTICAST>
  VRF Binding: Not bound
  Bandwidth 100m
  DHCP client is disabled.
  inet 10.1.2.173/24 broadcast 10.1.2.255
  VRRP Master of : VRRP is not configured on this interface.
  inet6 fe80::21b:21ff:fe39:6c4a/64
  collisions 0
```

Redirect Modifier

The `redirect` modifier writes the output into a file. The output is not displayed.

```
# show cli history | redirect /var/frame.txt
```

The output redirection token (`>`) does the same thing:

```
# show cli history >/var/frame.txt
```

Last Modifier

The `last` modifier displays the output of last few number of lines (As per the user input). The last number ranges from 1 to 9999.

For example:

```
#show running-config | last 10
```

String Parameters

The restrictions in [Table P-6](#) apply for all string parameters used in OcnOS commands, unless some other restrictions are noted for a particular command.

Table P-6: String parameter restrictions

Restriction	Description
Input length	1965 characters or less
Restricted special characters	“?”, “,”, “>”, “ ”, and “=” The “ ” character is allowed only for the <code>description</code> command in interface mode.

Command Modes

Commands are grouped into modes arranged in a hierarchy. Each mode has its own set of commands. [Table P-7](#) lists the command modes common to all protocols.

Table P-7: Common command modes

Name	Description
Executive mode	Also called <i>view</i> mode, this is the first mode to appear after you start the CLI. It is a base mode from where you can perform basic commands such as <code>show</code> , <code>exit</code> , <code>quit</code> , <code>help</code> , and <code>enable</code> .
Privileged executive mode	Also called <i>enable</i> mode, in this mode you can run additional basic commands such as <code>debug</code> , <code>write</code> , and <code>show</code> .
Configure mode	Also called <i>configure terminal</i> mode, in this mode you can run configuration commands and go into other modes such as <code>interface</code> , <code>router</code> , <code>route map</code> , <code>key chain</code> , and <code>address family</code> . Configure mode is single user. Only one user at a time can be in configure mode.
Interface mode	In this mode you can configure protocol-specific settings for a particular interface. Any setting you configure in this mode overrides a setting configured in router mode.
Router mode	This mode is used to configure router-specific settings for a protocol such as BGP or OSPF.

Command Mode Tree

The diagram below shows the common command mode hierarchy.

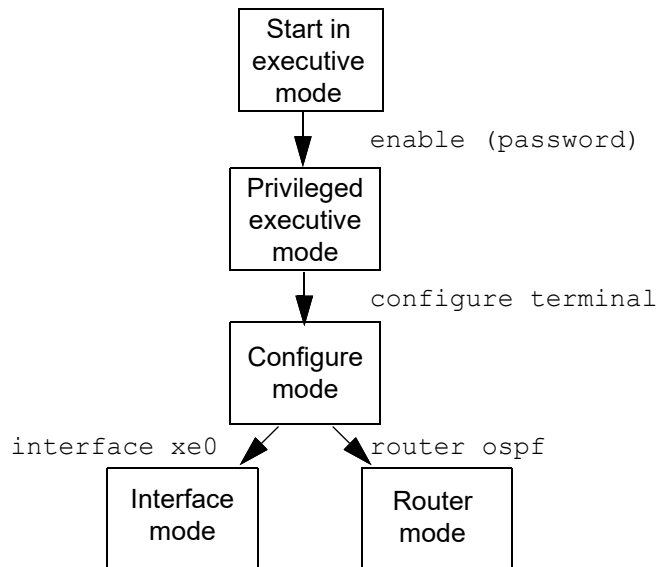

Figure P-1: Common command modes

To change modes:

1. Enter privileged executive mode by entering `enable` in Executive mode.
2. Enter configure mode by entering `configure terminal` in Privileged Executive mode.

The example below shows moving from executive mode to privileged executive mode to configure mode and finally to router mode:

```

> enable mypassword
# configure terminal
Enter configuration commands, one per line. End with CNTL/Z.
(config)# router ospf
(config-router)#
  
```

Note: Each protocol can have modes in addition to the common command modes. See the command reference for the respective protocol for details.

Transaction-based Command-line Interface

The OcNOS command line interface is transaction based:

- Any changes done in configure mode are stored in a separate *candidate* configuration that you can view with the `show transaction current` command.
- When a configuration is complete, apply the candidate configuration to the running configuration with the `commit` command.
- If a `commit` fails, no configuration is applied as the entire transaction is considered failed. You can continue to change the candidate configuration and then retry the `commit`.
- Discard the candidate configuration with the `abort transaction` command.
- Check the last aborted transaction with the `show transaction last-aborted` command.
- Multiple configurations cannot be removed with a single `commit`. You must remove each configuration followed by a `commit`.

Note: All commands MUST be executed only in the default CML shell (`cmlsh`). If you log in as root and start `imish`, then the system configurations will go out of sync. The `imish` shell is not supported and should not be started manually.

Layer 3 Unicast Configuration Guide

CHAPTER 1 BGP

This chapter contains basic Border Gateway Protocol configuration examples.

Enable BGP Routers in the Same Autonomous System

Figure 1-1 shows the minimum configuration required to enable BGP on an interface. R1 and R2 are two routers belonging to the same AS, AS200, connecting to network 10.10.10.0/24. First, define the routing process and the AS number to which the routers belong. Then, define BGP neighbors to start exchanging routing updates.

Topology

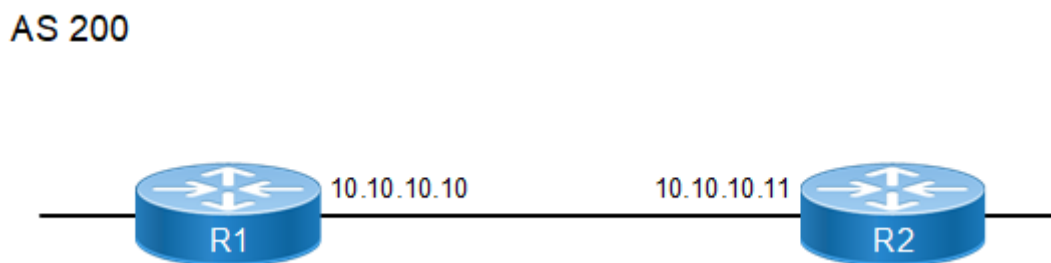

Figure 1-1: Routers in the Same Autonomous System

R1

#configure terminal	Enter configure mode.
(config)#router bgp 200	Define the routing process. The number 200 specifies the AS number of R1.
(config-router)#neighbor 10.10.10.11 remote-as 200	Define BGP neighbors, and establish a TCP session. 10.10.10.11 is the IP address of the neighbor (R2), and 200 is the neighbor's AS number.
(config-router)# address-family ipv4 unicast	Enter address-family ipv4 unicast mode
(config-router-af)# neighbor 10.10.10.11 activate	Activate the neighbor in the Ipv4 address family.
(config-router-af)# exit-address-family	Exit address-family mode.
(config-router)#commit	Commit the candidate configuration to the running configuration.

R2

#configure terminal	Enter configure mode.
(config)#router bgp 200	Define the routing process. The number 200 specifies the AS number of R2.
(config-router)#neighbor 10.10.10.10 remote-as 200	Define BGP neighbors, and establish a TCP session. 10.10.10.10 is the IP address of the neighbor (R1), and 200 is the neighbor's AS number.
(config-router)# address-family ipv4 unicast	Enter address-family ipv4 unicast mode

BGP

(config-router-af)# neighbor 10.10.10.10 activate	Activate the neighbor in the Ipv4 address family.
(config-router-af)# exit-address-family	Exit address-family mode.
(config-router)# commit	Commit the candidate configuration to the running configuration.

Validation

```
#show ip bgp summary
BGP router identifier 192.168.52.2, local AS number 200
BGP table version is 1
0 BGP AS-PATH entries
0 BGP community entries
```

Neighbor	Down	State/PfxRcd	V	AS	MsgRcv	MsgSen	TblVer	InQ	OutQ	Up/
10.10.10.11			4	200	387	390	1	0	0	
00:00:04			0							

Total number of neighbors 1

Total number of Established sessions 1

```
#show ip bgp neighbors
BGP neighbor is 10.10.10.11, remote AS 200, local AS 200, internal link
BGP version 4, local router ID 192.168.52.2, remote router ID 192.168.52.3
BGP state = Established, up for 00:01:41
Last read 00:00:11, hold time is 90, keepalive interval is 30 seconds
Neighbor capabilities:
  Route refresh: advertised and received (old and new)
  Address family IPv4 Unicast: advertised and received
Received 5 messages, 0 notifications, 0 in queue
Sent 6 messages, 0 notifications, 0 in queue
Route refresh request: received 0, sent 0
Minimum time between advertisement runs is 5 seconds
For address family: IPv4 Unicast
BGP table version 1, neighbor version 1
Index 1, Offset 0, Mask 0x2
Community attribute sent to this neighbor (both)
0 accepted prefixes
0 announced prefixes
```

```
Connections established 1; dropped 0
Local host: 10.10.10.10, Local port: 179
Foreign host: 10.10.10.11, Foreign port: 33931
NextHop: 10.10.10.10
NextHop global: ::
NextHop local: ::
BGP connection: non shared network
```

Enable BGP Between Different Autonomous Systems

This example shows the minimum configuration required for enabling BGP on an interface, when the routers belong to different autonomous systems. R1 and R2 are two routers in different autonomous system, AS200 and AS300, connecting to network 10.10.10.0/24.

Topology

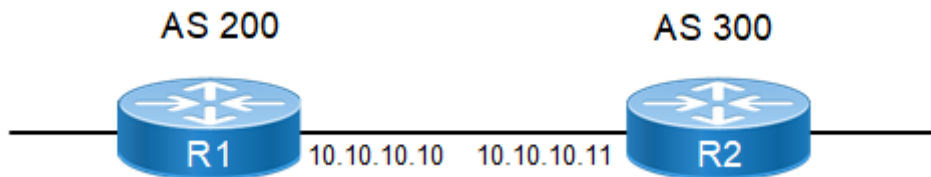

Figure 1-2: Routers in Different Autonomous Systems

R1

#configure terminal	Enter configure mode.
(config)#router bgp 200	Define the routing process. The number 200 specifies the AS number of R1.
(config-router)#neighbor 10.10.10.11 remote-as 300	Define BGP neighbors, and establish a TCP session. 10.10.10.11 is the IP address of the neighbor (R2), and 300 is the neighbor's AS number.
(config-router)# address-family ipv4 unicast	Enter address-family ipv4 unicast mode
(config-router-af)# neighbor 10.10.10.11 activate	Activate the neighbor in the ipv4 address family.
(config-router-af)# exit-address-family	Exit address-family mode.
(config-router)#commit	Commit the candidate configuration to the running configuration.

R2

#configure terminal	Enter configure mode.
(config)#router bgp 300	Define the routing process. The number 300 specifies the AS number of R2.
(config-router)#neighbor 10.10.10.10 remote-as 200	Define BGP neighbors, and establish a TCP session. 10.10.10.10 is the IP address of the neighbor (R1), and 200 is the neighbor's AS number.
(config-router)# address-family ipv4 unicast	Enter address-family ipv4 unicast mode
(config-router-af)# neighbor 10.10.10.10 activate	Activate the neighbor in the ipv4 address family.
(config-router-af)# exit-address-family	Exit address-family mode.
(config-router)#commit	Commit the candidate configuration to the running configuration.

Validation

```
#show ip bgp neighbors
BGP neighbor is 10.10.10.10, remote AS 200, local AS 300, external link
  BGP version 4, local router ID 192.168.52.3, remote router ID 192.168.52.2
  BGP state = Established, up for 00:00:15
  Last read 00:00:15, hold time is 90, keepalive interval is 30 seconds
  Neighbor capabilities:
    Route refresh: advertised and received (old and new)
    Address family IPv4 Unicast: advertised and received
  Received 2 messages, 0 notifications, 0 in queue
  Sent 2 messages, 0 notifications, 0 in queue
  Route refresh request: received 0, sent 0
  Minimum time between advertisement runs is 30 seconds
For address family: IPv4 Unicast
  BGP table version 1, neighbor version 1
  Index 1, Offset 0, Mask 0x2
  Community attribute sent to this neighbor (both)
  0 accepted prefixes
  0 announced prefixes

  Connections established 1; dropped 0
Local host: 10.10.10.11, Local port: 56091
Foreign host: 10.10.10.10, Foreign port: 179
Nexthop: 10.10.10.11
Nexthop global: ::
Nexthop local: ::
BGP connection: non shared network

#show ip bgp summary
BGP router identifier 192.168.52.3, local AS number 300
BGP table version is 1
0 BGP AS-PATH entries
0 BGP community entries

Neighbor          V    AS  MsgRcv   MsgSen  TblVer   InQ   OutQ   Up/
Down  State/PfxRcd
10.10.10.10      4    200     3       3        1     0     0
00:00:50         0

Total number of neighbors 1

Total number of Established sessions 1
```

Route-Map

Use route maps to filter incoming updates from a BGP peer. In this example, the prefix-list ABC on R1 is configured to deny entry of any routes with the IP address 1.1.1.0/M (M = 26, 27, 28). To test the filter, R2 is configured to generate network addresses 1.1.1.0/27 and 1.1.2.0/24. To verify, use the `show ip bgp` command on R1; it displays R1 receiving updates from only 1.1.2.0/24.

Topology

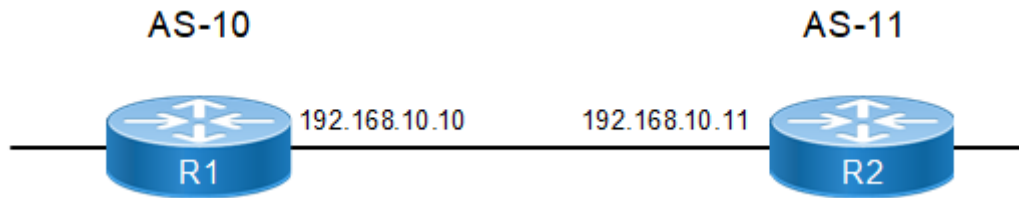

Figure 1-3: Configure Route-Map

R1

#configure terminal	Enter configure mode.
(config)#ip prefix-list ABC	Create an entry in the prefix-list. The ABC parameter is the name of the map that is created above. 5 specifies the sequence number or position of this specific route map. deny specifies the packets are to be rejected. 26 and 28 are the minimum and maximum prefix lengths to be matched.
(config-ip-prefix-list)#seq 5 deny 1.1.1.0/24 ge 26 le 28	5 specifies the sequence number or position of this specific route map. deny specifies the packets are to be rejected. 26 and 28 are the minimum and maximum prefix lengths to be matched.
(config-ip-prefix-list)#seq 10 permit any	10 specifies the sequence number or position of this specific route map. The permit parameter any specifies accept all packets of any length.
(config-ip-prefix-list)#exit	Exit the prefix-list mode
(config)#commit	Commit the candidate configuration to the running configuration.
(config)#route-map ABC permit 1	Enter Route-map mode to set the match operation.
(config-route-map)#match ip address prefix-list ABC	Set the match criteria. In this case, if the route-map name matches ABC, the packets from the first sequence are denied.
(config-route-map)#exit	Exit Route-map mode, and return to Configure mode.
(config)#router bgp 10	Define the routing process, and establish a TCP session. The number 10 specifies the AS number of R1.
(config-router)#neighbor 192.168.10.11 remote-as 11	Define BGP neighbors, and establish a TCP session. 192.168.10.11 is the IP address of the neighbor (R2), and 11 is the neighbor's AS number.
(config-router)# address-family ipv4 unicast	Enter address-family ipv4 unicast mode
(config-router-af)# neighbor 192.168.10.11 activate	Activate the neighbor in the Ipv4 address family.
(config-router-af)#neighbor 192.168.10.11 route-map ABC in	Apply a route map to routes. 192.168.10.11 specifies the IP address of BGP neighbor. The ABC parameter is the name of the route map, and in specifies that the access list applies to incoming advertisements.
(config-router-af)#exit-address-family	Exit address-family mode.
(config-router)#commit	Commit the candidate configuration to the running configuration.

R2

(config)#interface lo	Enter loopback interface mode.
(config-if)#ip address 1.1.1.1/27 secondary	Specify the interface address.
(config-if)#ip address 1.1.2.1/24 secondary	Specify the interface address.
(config-if)#exit	Exit loopback interface mode.
(config)#router bgp 11	Define the routing process, and establish a TCP session. The number 11 specifies the AS number of R2.
(config-router)#neighbor 192.168.10.10 remote-as 10	Define BGP neighbors, and establish a TCP session. 192.168.10.10 is the IP address of the neighbor (R1), and 10 is the neighbor's AS number.
(config-router)# address-family ipv4 unicast	Enter address-family ipv4 unicast mode
(config-router-af)# neighbor 192.168.10.10 activate	Activate the neighbor in the ipv4 address family.
(config-router-af)#network 1.1.1.0/27	Specify the network to be advertised by the BGP routing process.
(config-router-af)#network 1.1.2.0/24	Specify the network to be advertised by the BGP routing process.
(config-router-af)#exit-address-family	Exit router mode.
(config-router)#commit	Commit the candidate configuration to the running configuration.

Validation

```
#show ip bgp
BGP table version is 2, local router ID is 192.168.52.2
Status codes: s suppressed, d damped, h history, * valid, > best, i -
internal,
              l - labeled, S Stale
Origin codes: i - IGP, e - EGP, ? - incomplete

   Network          Next Hop           Metric      LocPrf      Weight Path
*>  1.1.1.0/27       0.0.0.0             0           100        32768  i
*>  1.1.2.0/24       192.168.10.11      0           100         0  11 i

Total number of prefixes 1
```

Route Reflector

The configurations in this section apply to BGP Route Reflectors (RR).

Reduce the iBGP Mesh Inside an Autonomous System

Use Route Reflectors to reduce the iBGP mesh inside an Autonomous System (AS).

Topology

In this example, R2, R5, and R4 would have to maintain a full mesh among themselves, but by making R5 the Route Reflector, R2 (Client1) has an iBGP session with the RR only, but not with R4 (Client 2). The routes learned from R2 are advertised to the other clients, and to iBGP peers outside the cluster; the iBGP routes learned from iBGP peers outside the cluster are advertised to R2. This reduces the iBGP peer connections in AS1.

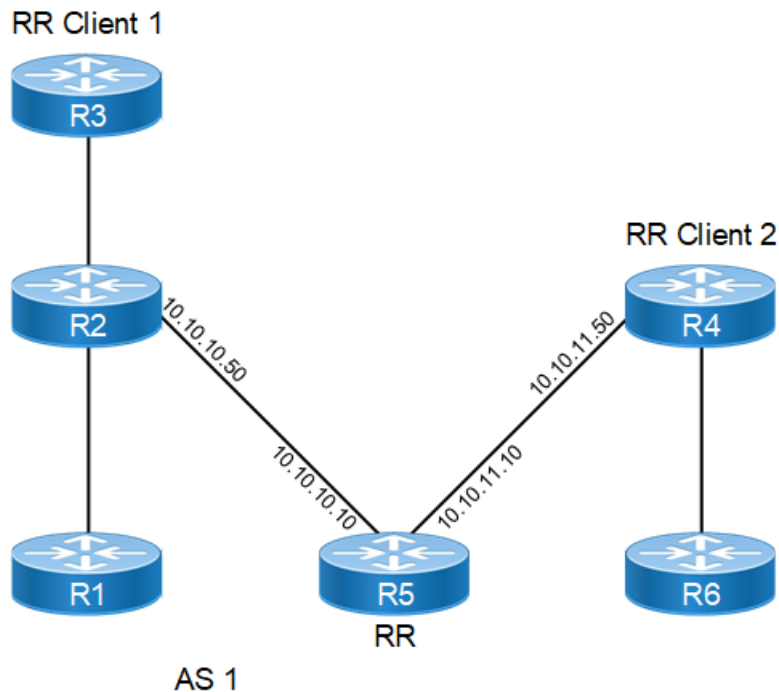

Figure 1-4: BGP Route Reflector

RR (R5)

#configure terminal	Enter configure mode.
(config)#router bgp 1	Define the routing process. The number 1 identifies the AS number of R5.
(config-router)#neighbor 10.10.10.50 remote-as 1	Define the BGP neighbor, and establish a TCP session. 10.10.10.50 is the IP address of one of the neighbors (R2), and 1 is the neighbor's AS number.
(config-router)#neighbor 10.10.11.50 remote-as 1	Define the BGP neighbor, and establish a TCP session. 10.10.11.50 is the IP address of one of the neighbors (R4), and 1 is the neighbor's AS number.
(config-router)# address-family ipv4 unicast	Enter address-family ipv4 unicast mode
(config-router-af)# neighbor 10.10.10.50 activate	Activate the neighbor in the Ipv4 address family.
(config-router-af)#neighbor 10.10.11.50 activate	Activate the neighbor in the Ipv4 address family.
(config-router-af)#neighbor 10.10.10.50 route-reflector-client	Configure R5 as the Route-Reflector (RR) and neighbor R2 as its client.
(config-router-af)#neighbor 10.10.11.50 route-reflector-client	Configure R5 as the Route-Reflector (RR) and neighbor R4 as its client.

BGP

<code>(config-router-af)#exit-address-family</code>	Exit address-family mode.
<code>(config-router)#commit</code>	Commit the candidate configuration to the running configuration.

RR Client 1 (R2)

<code>(config)#router bgp 1</code>	Define the routing process. The number 1 specifies the AS number of R2.
<code>(config-router)#neighbor 10.10.10.10 remote-as 1</code>	Define the BGP neighbor, and establish a TCP session. 10.10.10.10 is the IP address of the neighbor (R5), and 1 is the neighbor's AS number.
<code>(config-router)# address-family ipv4 unicast</code>	Enter address-family ipv4 unicast mode
<code>(config-router-af)# neighbor 10.10.10.10 activate</code>	Activate the neighbor in the lpv4 address family.
<code>(config-router-af)#exit-address-family</code>	Exit address-family mode.
<code>(config-router)#exit</code>	Exit router mode.
<code>(config)#commit</code>	Commit the candidate configuration to the running configuration.

RR Client 2 (R4)

<code>(config)#router bgp 1</code>	Define the routing process. The number 1 identifies the AS number of R4.
<code>(config-router)#neighbor 10.10.11.10 remote-as 1</code>	Define BGP neighbor, and establish a TCP session. 10.10.11.10 is the IP address of the neighbor (R5), and 1 is the neighbor's AS number.
<code>(config-router)# address-family ipv4 unicast</code>	Enter address-family ipv4 unicast mode
<code>(config-router-af)# neighbor 10.10.11.10 activate</code>	Activate the neighbor in the lpv4 address family.
<code>(config-router-af)#exit-address-family</code>	Exit address-family mode.
<code>(config-router)#exit</code>	Exit router mode.
<code>(config)#commit</code>	Commit the candidate configuration to the running configuration.

Validation

R5

```
#show ip bgp neighbors
BGP neighbor is 10.10.10.50, remote AS 1, local AS 1, internal link
  BGP version 4, local router ID 192.160.50.3, remote router ID 10.12.4.152
  BGP state = Established, up for 00:01:04
  Last read 00:01:04, hold time is 90, keepalive interval is 30 seconds
  Neighbor capabilities:
    Route refresh: advertised and received (old and new)
    Address family IPv4 Unicast: advertised and received
  Received 4 messages, 0 notifications, 0 in queue
  Sent 4 messages, 0 notifications, 0 in queue
  Route refresh request: received 0, sent 0
```

```
Minimum time between advertisement runs is 5 seconds
For address family: IPv4 Unicast
BGP table version 1, neighbor version 1
Index 1, Offset 0, Mask 0x2
Route-Reflector Client
Community attribute sent to this neighbor (both)
0 accepted prefixes
0 announced prefixes
```

```
Connections established 1; dropped 0
Local host: 10.10.10.10, Local port: 47983
Foreign host: 10.10.10.50, Foreign port: 179
Next hop: 10.10.10.10
Next hop global: fe80::a00:27ff:fe09:fd25
Next hop local: ::
BGP connection: non shared network
```

```
BGP neighbor is 10.10.11.50, remote AS 1, local AS 1, internal link
BGP version 4, remote router ID 10.12.4.197
local router ID 192.160.50.3
BGP state = Established, up for 00:01:04
Last read 00:01:04, hold time is 90, keepalive interval is 30 seconds
Neighbor capabilities:
  Route refresh: advertised and received (old and new)
  Address family IPv4 Unicast: advertised and received
Received 4 messages, 0 notifications, 0 in queue
Sent 4 messages, 0 notifications, 0 in queue
Route refresh request: received 0, sent 0
Minimum time between advertisement runs is 5 seconds
For address family: IPv4 Unicast
BGP table version 1, neighbor version 1
Index 2, Offset 0, Mask 0x4
Route-Reflector Client
Community attribute sent to this neighbor (both)
0 accepted prefixes
0 announced prefixes
```

```
Connections established 1; dropped 0
Local host: 10.10.11.10, Local port: 39851
Foreign host: 10.10.11.50, Foreign port: 179
Next hop: 10.10.11.10
Next hop global: fe80::a00:27ff:fe52:45f6
Next hop local: ::
BGP connection: non shared network
```

R3

```
#show ip bgp neighbors
BGP neighbor is 10.10.11.10, remote AS 1, local AS 1, internal link
BGP version 4, local router ID 192.160.50.4, remote router ID 10.12.4.185
BGP state = Established, up for 00:00:56
Last read 00:00:56, hold time is 90, keepalive interval is 30 seconds
Neighbor capabilities:
  Route refresh: advertised and received (old and new)
  Address family IPv4 Unicast: advertised and received
Received 3 messages, 0 notifications, 0 in queue
Sent 3 messages, 0 notifications, 0 in queue
```

```
Route refresh request: received 0, sent 0
Minimum time between advertisement runs is 5 seconds
For address family: IPv4 Unicast
BGP table version 1, neighbor version 1
Index 1, Offset 0, Mask 0x2
Community attribute sent to this neighbor (both)
0 accepted prefixes
0 announced prefixes
```

```
Connections established 1; dropped 0
Local host: 10.10.11.50, Local port: 179
Foreign host: 10.10.11.10, Foreign port: 39851
Next hop: 10.10.11.50
Next hop global: fe80::a00:27ff:fe42:fb7a
Next hop local: ::
BGP connection: non shared network
```

R2

```
#show ip bgp neighbors
BGP neighbor is 10.10.10.10, remote AS 1, local AS 1, internal link
  BGP version 4, local router ID 192.160.50.2, remote router ID 10.12.4.185
  BGP state = Established, up for 00:01:23
  Last read 00:01:23, hold time is 90, keepalive interval is 30 seconds
  Neighbor capabilities:
    Route refresh: advertised and received (old and new)
    Address family IPv4 Unicast: advertised and received
  Received 4 messages, 0 notifications, 0 in queue
  Sent 4 messages, 0 notifications, 0 in queue
  Route refresh request: received 0, sent 0
  Minimum time between advertisement runs is 5 seconds
For address family: IPv4 Unicast
BGP table version 1, neighbor version 1
Index 1, Offset 0, Mask 0x2
Community attribute sent to this neighbor (both)
0 accepted prefixes
0 announced prefixes

Connections established 1; dropped 0
Local host: 10.10.10.50, Local port: 179
Foreign host: 10.10.10.10, Foreign port: 47983
Next hop: 10.10.10.50
Next hop global: fe80::a00:27ff:fe9c:f35d
Next hop local: ::
BGP connection: non shared network
```

Multiple Route Reflectors

The basic rule of BGP is that a BGP speaker cannot advertise a route to an iBGP neighbor if that route was learned from another iBGP neighbor. Configuring a route reflector provides a means to circumvent this rule. The entire route reflector process is transparent to the clients, and no configuration is necessary on these clients.

Whenever an iBGP-speaking router receives a route update, it forwards the route to the neighbor without changing the next hop IP address, thus making it an unreachable route, unless verified by an iGP (for example, neighbor x.x.x.x route-reflector-client).

- A route learned from a non-RR client is advertised to RR clients but not to non-RR clients.

- A route learned from a RR client is advertised to both RR clients and non-RR clients. Even the RR client that advertised the route will receive a copy and discards it because it sees itself as the originator.
- A route learned from an EBGP neighbor is advertised to both RR clients and non-RR clients.

Topology

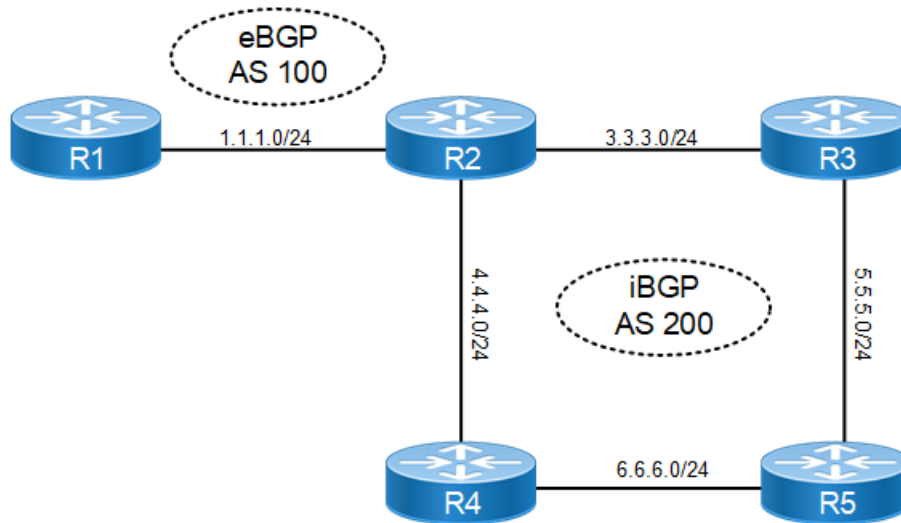

Figure 1-5: eBGP and iBGP Route Reflector Topology

R1

#configure terminal	Enter configure mode.
(config)#interface eth1	Enter interface mode
(config-if)#ip addr 1.1.1.1/24	Specify IP address for the interface.
(config-if)#exit	Exit interface mode
(config)#interface lo	Enter loopback interface mode.
(config-if)#ip address 100.100.100.100/32 secondary	Specify IP address for the interface.
(config-if)#exit	Exit loopback interface mode.
(config)#router bgp 100	Define the routing process with AS number 100.
(config-router)#neighbor 1.1.1.2 remote-as 200	Define the eBGP neighbor (R2).
(config-router)# address-family ipv4 unicast	Enter address-family ipv4 unicast mode
(config-router-af)# neighbor 1.1.1.2 activate	Activate the neighbor under address family mode
(config-router-af)#network 100.100.100.100/32	Advertise a route via eBGP connection to R2.
(config-router-af)#exit-address-family	Exit router mode.
(config-router)#commit	Commit the candidate configuration to the running configuration.

R2

#configure terminal	Enter configure mode.
(config)#interface eth1	Enter interface mode
(config-if)#ip address 1.1.1.2/24	Specify IP address for the interface.
(config-if)#exit	Exit interface mode
(config)#interface eth2	Enter interface mode
(config-if)#ip address 3.3.3.2/24	Specify IP address for the interface.
(config-if)#exit	Exit interface mode
(config)#interface eth3	Enter interface mode
(config-if)#ip address 4.4.4.2/24	Specify IP address for the interface.
(config-if)#exit	Exit interface mode
(config)#router bgp 200	Define the routing process with AS number 200.
(config-router)#neighbor 1.1.1.1 remote-as 100	Define the eBGP neighbor (R1).
(config-router)#neighbor 4.4.4.1 remote-as 200	Define the iBGP neighbor (R4).
(config-router)#neighbor 3.3.3.1 remote-as 200	Define the iBGP neighbor (R3).
(config-router)#bgp cluster-id 4	Define a cluster ID (4) when multiple Route Reflectors exist.
(config-router)# address-family ipv4 unicast	Enter address-family ipv4 unicast mode
(config-router-af)# neighbor 1.1.1.1 activate	Activate the neighbor under address family mode
(config-router-af)# neighbor 4.4.4.1 activate	Activate the neighbor under address family mode
(config-router-af)# neighbor 3.3.3.1 activate	Activate the neighbor under address family mode
(config-router-af)#neighbor 3.3.3.1 route-reflector-client	Configure R2 as the Route-Reflector and neighbor R3 as its client.
(config-router-af)#neighbor 4.4.4.1 route-reflector-client	Configure R2 as the Route-Reflector and neighbor R4 as its client.
(config-router-af)#exit-address-family	Exit address-family mode.
(config-router)#commit	Commit the candidate configuration to the running configuration.

R3

#configure terminal	Enter configure mode.
(config)#interface eth2	Enter interface mode
(config-if)#ip address 3.3.3.1/24	Assign an IP address
(config-if)#exit	Exit interface mode
(config)#interface eth1	Enter interface mode
(config-if)#ip addr 5.5.5.1/24	Assign an IP address
(config-if)#exit	Exit interface mode
(config)#router bgp 200	Define the routing process with AS number 200.

(config-router)#neighbor 3.3.3.2 remote-as 200	Define the iBGP neighbor (R2).
(config-router)#neighbor 5.5.5.2 remote-as 200	Define the iBGP neighbor (R5).
(config-router)# address-family ipv4 unicast	Enter address-family ipv4 unicast mode
(config-router-af)# neighbor 3.3.3.2 activate	Activate the neighbor under address family mode
(config-router-af)# neighbor 5.5.5.2 activate	Activate the neighbor under address family mode
(config-router-af)#neighbor 5.5.5.2 route-reflector-client	Configure R3 as the Route-Reflector and neighbor R5 as its client.
(config-router-af)#exit-address-family	Exit address-family mode.
(config-router)#commit	Commit the candidate configuration to the running configuration.

R4

#configure terminal	Enter configure mode
(config)#interface eth2	Enter interface mode
(config-if)#ip address 6.6.6.1/24	Specify an IP address for the interface.
(config-if)#exit	Exit interface mode
(config)#interface eth4	Enter interface mode
(config-if)#ip address 4.4.4.1/24	Specify an IP address for the interface.
(config-if)#exit	Exit interface mode
(config)#router bgp 200	Define the routing process with AS number 200.
(config-router)#neighbor 4.4.4.2 remote-as 200	Define the iBGP neighbor (R2).
(config-router)#neighbor 6.6.6.2 remote-as 200	Define the iBGP neighbor (R5).
(config-router)# address-family ipv4 unicast	Enter address-family ipv4 unicast mode
(config-router-af)# neighbor 4.4.4.2 activate	Activate the neighbor under address family mode
(config-router-af)# neighbor 6.6.6.2 activate	Activate the neighbor under address family mode
(config-router-af)#exit-address-family	Exit address-family mode.
(config-router)#exit	Exit router mode.
(config)#commit	Commit the candidate configuration to the running configuration.

R5

#configure terminal	Enter configure mode
(config)#interface eth1	Enter interface mode
(config-if)#ip address 5.5.5.2/24	Specify an IP address for the interface.
(config-if)#exit	Exit interface mode
(config-if)#interface eth2	Enter interface mode
(config-if)#ip address 6.6.6.2/24	Specify an IP address for the interface.
(config-if)#exit	Exit interface mode
(config)#router bgp 200	Define the routing process with AS number 200.
(config-router)#neighbor 5.5.5.1 remote-as 200	Define the iBGP neighbor (R3).
(config-router)#neighbor 6.6.6.1 remote-as 200	Define the iBGP neighbor (R4).
(config-router)# address-family ipv4 unicast	Enter address-family ipv4 unicast mode
(config-router-af)# neighbor 5.5.5.1 activate	Activate the neighbor under address family mode
(config-router-af)# neighbor 6.6.6.1 activate	Activate the neighbor under address family mode
(config-router-af)#exit-address-family	Exit address-family mode.
(config-router)#commit	Commit the candidate configuration to the running configuration.

Validation**R2**

```
#show ip bgp neighbors
BGP neighbor is 1.1.1.1, remote AS 100, local AS 200, external link
  BGP version 4, local router ID 10.12.4.196, remote router ID 192.160.50.2
  BGP state = Established, up for 00:14:41
  Last read 00:00:11, hold time is 90, keepalive interval is 30 seconds
  Neighbor capabilities:
    Route refresh: advertised and received (old and new)
    Address family IPv4 Unicast: advertised and received
  Received 32 messages, 0 notifications, 0 in queue
  Sent 31 messages, 0 notifications, 0 in queue
  Route refresh request: received 0, sent 0
  Minimum time between advertisement runs is 30 seconds
For address family: IPv4 Unicast
  BGP table version 2, neighbor version 2
  Index 1, Offset 0, Mask 0x2
  Community attribute sent to this neighbor (both)
  1 accepted prefixes
  0 announced prefixes

Connections established 1; dropped 0
Local host: 1.1.1.2, Local port: 50649
Foreign host: 1.1.1.1, Foreign port: 179
Next hop: 1.1.1.2
Next hop global: ::
Next hop local: ::
```

BGP connection: non shared network

BGP neighbor is 3.3.3.1, remote AS 200, local AS 200, internal link
BGP version 4, local router ID 192.160.50.3, remote router ID 192.160.50.4
BGP state = Established, up for 00:04:17
Last read 00:00:17, hold time is 90, keepalive interval is 30 seconds
Neighbor capabilities:
Route refresh: advertised and received (old and new)
Address family IPv4 Unicast: advertised and received
Received 10 messages, 0 notifications, 0 in queue
Sent 13 messages, 0 notifications, 0 in queue
Route refresh request: received 0, sent 0
Minimum time between advertisement runs is 5 seconds
For address family: IPv4 Unicast
BGP table version 2, neighbor version 2
Index 3, Offset 0, Mask 0x8
Route-Reflector Client
Community attribute sent to this neighbor (both)
0 accepted prefixes
1 announced prefixes

Connections established 1; dropped 0
Local host: 3.3.3.2, Local port: 179
Foreign host: 3.3.3.1, Foreign port: 32973
Nexthop: 3.3.3.2
Nexthop global: ::
Nexthop local: ::
BGP connection: non shared network

BGP neighbor is 4.4.4.1, remote AS 200, local AS 200, internal link
BGP version 4, local router ID 192.160.50.3, remote router ID 192.160.50.6
BGP state = Established, up for 00:00:16
Last read 00:00:16, hold time is 90, keepalive interval is 30 seconds
Neighbor capabilities:
Route refresh: advertised and received (old and new)
Address family IPv4 Unicast: advertised and received
Received 2 messages, 0 notifications, 0 in queue
Sent 4 messages, 0 notifications, 0 in queue
Route refresh request: received 0, sent 0
Minimum time between advertisement runs is 5 seconds
For address family: IPv4 Unicast
BGP table version 2, neighbor version 2
Index 2, Offset 0, Mask 0x4
Route-Reflector Client
Community attribute sent to this neighbor (both)
0 accepted prefixes
1 announced prefixes

Connections established 1; dropped 0
Local host: 4.4.4.2, Local port: 179
Foreign host: 4.4.4.1, Foreign port: 60398
Nexthop: 4.4.4.2
Nexthop global: ::
Nexthop local: ::
BGP connection: non shared network

#show ip route

BGP

Codes: K - kernel, C - connected, S - static, R - RIP, B - BGP
O - OSPF, IA - OSPF inter area
N1 - OSPF NSSA external type 1, N2 - OSPF NSSA external type 2
E1 - OSPF external type 1, E2 - OSPF external type 2
i - IS-IS, L1 - IS-IS level-1, L2 - IS-IS level-2,
ia - IS-IS inter area, E - EVPN,
v - vrf leaked
* - candidate default

IP Route Table for VRF "default"

```
C 1.1.1.0/24 is directly connected, eth1, 00:16:10
C 3.3.3.0/24 is directly connected, eth2, 00:15:59
C 4.4.4.0/24 is directly connected, eth3, 00:15:49
B 100.100.100.100/32 [20/0] via 1.1.1.1, eth1, 00:14:53
C 127.0.0.0/8 is directly connected, lo, 00:32:26
C 192.160.50.0/24 is directly connected, eth0, 00:32:22
```

Gateway of last resort is not set

#show ip bgp

BGP table version is 2, local router ID is 192.160.50.3
Status codes: s suppressed, d damped, h history, * valid, > best, i -
internal,

l - labeled, S Stale

Origin codes: i - IGP, e - EGP, ? - incomplete

	Network	Next Hop	Metric	LocPrf	Weight	Path
*>	100.100.100.100/32					
i		1.1.1.1	0	100	0	100

Total number of prefixes 1

Total number of neighbors 3

R1

#show bgp neighbors

BGP neighbor is 1.1.1.2, remote AS 200, local AS 100, external link
BGP version 4, local router ID 10.12.4.142, remote router ID 10.12.4.196
BGP state = Established, up for 00:16:11

Last read 00:00:11, hold time is 90, keepalive interval is 30 seconds

Neighbor capabilities:

Route refresh: advertised and received (old and new)

Address family IPv4 Unicast: advertised and received

Received 34 messages, 0 notifications, 0 in queue

Sent 36 messages, 0 notifications, 0 in queue

Route refresh request: received 0, sent 0

Minimum time between advertisement runs is 30 seconds

For address family: IPv4 Unicast

BGP table version 1, neighbor version 1

Index 1, Offset 0, Mask 0x2

Community attribute sent to this neighbor (both)

0 accepted prefixes

1 announced prefixes

Connections established 1; dropped 0

Local host: 1.1.1.1, Local port: 179

```

Foreign host: 1.1.1.2, Foreign port: 50649
Nexthop: 1.1.1.1
Nexthop global: ::
Nexthop local: ::
BGP connection: non shared network

```

```

#show ip bgp summary
BGP router identifier 192.160.50.2, local AS number 100
BGP table version is 1
1 BGP AS-PATH entries
0 BGP community entries

```

Neighbor	Down	State/PfxRcd	V	AS	MsgRcv	MsgSen	TblVer	InQ	OutQ	Up/
1.1.1.2			4	200	34	36	1	0	0	
00:16:18			0							

Total number of neighbors 1

Total number of Established sessions 1

#

R3

```

#show ip bgp
BGP table version is 1, local router ID is 192.160.50.4
Status codes: s suppressed, d damped, h history, * valid, > best, i -
internal,
                l - labeled, S Stale
Origin codes: i - IGP, e - EGP, ? - incomplete

```

	Network	Next Hop	Metric	LocPrf	Weight	Path
* i	100.100.100.100/32	1.1.1.1	0	100	0	100
i						

Total number of prefixes 1

#

```

#show ip bgp neighbors
BGP neighbor is 3.3.3.2, remote AS 200, local AS 200, internal link
BGP version 4, local router ID 192.160.50.4, remote router ID 192.160.50.3
BGP state = Established, up for 00:06:15
Last read 00:00:15, hold time is 90, keepalive interval is 30 seconds
Neighbor capabilities:
Route refresh: advertised and received (old and new)
Address family IPv4 Unicast: advertised and received
Received 15 messages, 0 notifications, 0 in queue
Sent 14 messages, 0 notifications, 0 in queue
Route refresh request: received 0, sent 0
Minimum time between advertisement runs is 5 seconds
For address family: IPv4 Unicast
BGP table version 1, neighbor version 1
Index 1, Offset 0, Mask 0x2
Community attribute sent to this neighbor (both)
1 accepted prefixes
0 announced prefixes

```

```

Connections established 1; dropped 0
Local host: 3.3.3.1, Local port: 32973
Foreign host: 3.3.3.2, Foreign port: 179
Nexthop: 3.3.3.1
Nexthop global: ::
Nexthop local: ::
BGP connection: non shared network

```

```

BGP neighbor is 5.5.5.2, remote AS 200, local AS 200, internal link
BGP version 4, local router ID 192.160.50.4, remote router ID 192.160.50.5
BGP state = Established, up for 00:03:35
Last read 00:00:05, hold time is 90, keepalive interval is 30 seconds
Neighbor capabilities:
  Route refresh: advertised and received (old and new)
  Address family IPv4 Unicast: advertised and received
Received 9 messages, 0 notifications, 0 in queue
Sent 10 messages, 0 notifications, 0 in queue
Route refresh request: received 0, sent 0
Minimum time between advertisement runs is 5 seconds
For address family: IPv4 Unicast
BGP table version 1, neighbor version 1
Index 2, Offset 0, Mask 0x4
Route-Reflector Client
Community attribute sent to this neighbor (both)
0 accepted prefixes
0 announced prefixes

```

```

Connections established 1; dropped 0
Local host: 5.5.5.1, Local port: 179
Foreign host: 5.5.5.2, Foreign port: 39271
Nexthop: 5.5.5.1
Nexthop global: ::
Nexthop local: ::
BGP connection: non shared network

```

```
#
```

```

#show ip bgp summary
BGP router identifier 192.160.50.4, local AS number 200
BGP table version is 1
1 BGP AS-PATH entries
0 BGP community entries

```

Neighbor	V	AS	MsgRcv	MsgSen	TblVer	InQ	OutQ	Up/
Down State/PfxRcd								
3.3.3.2	4	200	15	14	1	0	0	
00:06:26	1							
5.5.5.2	4	200	9	10	1	0	0	
00:03:46	0							

```
Total number of neighbors 2
```

R4

```

#show ip bgp
BGP table version is 1, local router ID is 192.160.50.6

```

Status codes: s suppressed, d damped, h history, * valid, > best, i - internal,

l - labeled, S Stale

Origin codes: i - IGP, e - EGP, ? - incomplete

	Network	Next Hop	Metric	LocPrf	Weight	Path
* i	100.100.100.100/32	1.1.1.1	0	100	0	100
i						

Total number of prefixes 1

#

#sh ip bgp neighbors

BGP neighbor is 4.4.4.2, remote AS 200, local AS 200, internal link
 BGP version 4, local router ID 192.160.50.6, remote router ID 192.160.50.3
 BGP state = Established, up for 00:03:58
 Last read 00:00:28, hold time is 90, keepalive interval is 30 seconds
 Neighbor capabilities:
 Route refresh: advertised and received (old and new)
 Address family IPv4 Unicast: advertised and received
 Received 10 messages, 0 notifications, 0 in queue
 Sent 9 messages, 0 notifications, 0 in queue
 Route refresh request: received 0, sent 0
 Minimum time between advertisement runs is 5 seconds
 For address family: IPv4 Unicast
 BGP table version 1, neighbor version 1
 Index 1, Offset 0, Mask 0x2
 Community attribute sent to this neighbor (both)
 1 accepted prefixes
 0 announced prefixes

Connections established 1; dropped 0
 Local host: 4.4.4.1, Local port: 60398
 Foreign host: 4.4.4.2, Foreign port: 179
 Nexthop: 4.4.4.1
 Nexthop global: ::
 Nexthop local: ::
 BGP connection: non shared network

BGP neighbor is 6.6.6.2, remote AS 200, local AS 200, internal link
 BGP version 4, local router ID 192.160.50.6, remote router ID 192.160.50.5
 BGP state = Established, up for 00:03:52
 Last read 00:00:22, hold time is 90, keepalive interval is 30 seconds
 Neighbor capabilities:
 Route refresh: advertised and received (old and new)
 Address family IPv4 Unicast: advertised and received
 Received 9 messages, 0 notifications, 0 in queue
 Sent 9 messages, 0 notifications, 0 in queue
 Route refresh request: received 0, sent 0
 Minimum time between advertisement runs is 5 seconds
 For address family: IPv4 Unicast
 BGP table version 1, neighbor version 1
 Index 2, Offset 0, Mask 0x4
 Community attribute sent to this neighbor (both)
 0 accepted prefixes
 0 announced prefixes

BGP

```
Connections established 1; dropped 0
Local host: 6.6.6.1, Local port: 48257
Foreign host: 6.6.6.2, Foreign port: 179
Nexthop: 6.6.6.1
Nexthop global: ::
Nexthop local: ::
BGP connection: non shared network
```

#

```
#show ip bgp summary
BGP router identifier 192.160.50.6, local AS number 200
BGP table version is 1
1 BGP AS-PATH entries
0 BGP community entries
```

Neighbor	Down	State/PfxRcd	V	AS	MsgRcv	MsgSen	TblVer	InQ	OutQ	Up/
4.4.4.2			4	200	11	10	1	0	0	
00:04:09			1							
6.6.6.2			4	200	10	10	1	0	0	
00:04:03			0							

Total number of neighbors 2

Total number of Established sessions 2

R5

```
#show ip bgp neighbors
BGP neighbor is 5.5.5.1, remote AS 200, local AS 200, internal link
  BGP version 4, local router ID 192.160.50.5, remote router ID 192.160.50.4
  BGP state = Established, up for 00:09:04
  Last read 00:00:04, hold time is 90, keepalive interval is 30 seconds
  Neighbor capabilities:
    Route refresh: advertised and received (old and new)
    Address family IPv4 Unicast: advertised and received
  Received 20 messages, 0 notifications, 0 in queue
  Sent 20 messages, 0 notifications, 0 in queue
  Route refresh request: received 0, sent 0
  Minimum time between advertisement runs is 5 seconds
For address family: IPv4 Unicast
  BGP table version 1, neighbor version 1
  Index 1, Offset 0, Mask 0x2
  Community attribute sent to this neighbor (both)
  0 accepted prefixes
  0 announced prefixes
```

```
Connections established 1; dropped 0
Local host: 5.5.5.2, Local port: 39271
Foreign host: 5.5.5.1, Foreign port: 179
Nexthop: 5.5.5.2
Nexthop global: ::
Nexthop local: ::
BGP connection: non shared network
```

```

BGP neighbor is 6.6.6.1, remote AS 200, local AS 200, internal link
  BGP version 4, local router ID 192.160.50.5, remote router ID 192.160.50.6
  BGP state = Established, up for 00:07:36
  Last read 00:00:06, hold time is 90, keepalive interval is 30 seconds
  Neighbor capabilities:
    Route refresh: advertised and received (old and new)
    Address family IPv4 Unicast: advertised and received
  Received 17 messages, 0 notifications, 0 in queue
  Sent 18 messages, 0 notifications, 0 in queue
  Route refresh request: received 0, sent 0
  Minimum time between advertisement runs is 5 seconds
For address family: IPv4 Unicast
  BGP table version 1, neighbor version 1
  Index 2, Offset 0, Mask 0x4
  Community attribute sent to this neighbor (both)
  0 accepted prefixes
  0 announced prefixes

  Connections established 1; dropped 0
Local host: 6.6.6.2, Local port: 179
Foreign host: 6.6.6.1, Foreign port: 48257
Nexthop: 6.6.6.2
Nexthop global: ::
Nexthop local: ::
BGP connection: non shared network
#

#sh ip bgp summary
BGP router identifier 192.160.50.5, local AS number 200
BGP table version is 1
0 BGP AS-PATH entries
0 BGP community entries

Neighbor          V    AS  MsgRcv   MsgSen  TblVer   InQ   OutQ   Up/
Down  State/PfxRcd
5.5.5.1          4    200    20       20       1       0       0
00:09:20        0
6.6.6.1          4    200    17       18       1       0       0
00:07:52        0

Total number of neighbors 2

Total number of Established sessions 2
#

```

BGP Confederations

In BGP, nodes running iBGP protocols must be interconnected forming a full mesh. Confederation solves the iBGP full-mesh network complexity and inefficiency by splitting a large autonomous system domain into smaller autonomous system domains, called member autonomous systems. Member autonomous systems can form eBGP connections among themselves, to prevent full-mesh connections among each iBGP-running node.

The `bgp confederation identifier` command tells the router that it is a member of a confederation and the confederation ID. The `bgp confederation peers` command lists the member AS to which the router is connected.

In the following example, R1, R2, and R3 are members of the same confederation with different AS numbers.

Topology

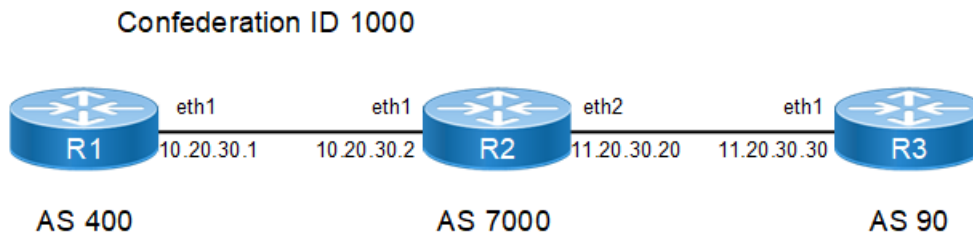

Figure 1-6: BGP Confederation

R1

<code>#configure terminal</code>	Enter configure mode.
<code>(config)#router bgp 400</code>	Assign the ASN value (400) to the router.
<code>(config-router)#bgp confederation identifier 1000</code>	Specify the BGP confederation ID, the externally visible autonomous system number that identifies the BGP confederation as a whole.
<code>(config-router)#bgp confederation peers 7000</code>	Specify the neighbor ASN value for confederation membership.
<code>(config-router)#neighbor 10.20.30.2 remote-as 7000</code>	Specify the neighbor's IP address (10.20.30.2) and the ASN value of the neighbor (7000).
<code>(config-router)# address-family ipv4 unicast</code>	Enter address-family ipv4 unicast mode
<code>(config-router-af)# neighbor 10.20.30.2 activate</code>	Activate the neighbor under address family mode
<code>(config-router-af)#exit-address-family</code>	Exit address-family mode.
<code>(config-router)#commit</code>	Commit the candidate configuration to the running configuration.

R2

<code>#configure terminal</code>	Enter configure mode.
<code>(config)#router bgp 7000</code>	Assign the ASN value (7000) to the router.
<code>(config-router)#bgp confederation identifier 1000</code>	Specify the BGP confederation ID.
<code>(config-router)#bgp confederation peers 400 90</code>	Specify the neighbor ASN values for confederation membership.
<code>(config-router)#neighbor 10.20.30.1 remote-as 400</code>	Specify the neighbor's IP address (10.20.30.1) and the ASN value of the neighbor (400).
<code>(config-router)#neighbor 11.20.30.30 remote-as 90</code>	Specify the neighbor's IP address (11.20.30.30) and the ASN value of the neighbor (90).
<code>(config-router)# address-family ipv4 unicast</code>	Enter address-family ipv4 unicast mode
<code>(config-router-af)# neighbor 10.20.30.1 activate</code>	Activate the neighbor under address family mode

(config-router-af)# neighbor 11.20.30.30 activate	Activate the neighbor under address family mode
(config-router-af)#exit-address-family	Exit address-family mode.
(config-router)#commit	Commit the candidate configuration to the running configuration.

R3

#configure terminal	Enter configure mode.
(config-router)#router bgp 90	Assign the ASN value (90) to the router.
(config-router)#bgp confederation identifier 1000	Specify the BGP confederation ID.
(config-router)#bgp confederation peers 7000	Specify the neighbor ASN value for confederation membership.
(config-router)#neighbor 11.20.30.20 remote-as 7000	Specify the neighbor's IP address (11.20.30.20) and the ASN value of the neighbor (7000).
(config-router)# address-family ipv4 unicast	Enter address-family ipv4 unicast mode
(config-router-af)# neighbor 11.20.30.20 activate	Exit address-family mode.
(config-router-af)#exit-address-family	Exit address-family mode.
(config-router)#commit	Commit the candidate configuration to the running configuration.

Validation**R2**

```
#sh ip bgp summary
BGP router identifier 192.168.52.3, local AS number 7000
BGP table version is 1
0 BGP AS-PATH entries
0 BGP community entries
```

Neighbor	Down	State/PfxRcd	V	AS	MsgRcv	MsgSen	TblVer	InQ	OutQ	Up/
10.20.30.1			4	400	5	5	1	0	0	
00:01:36			0							
11.20.30.30			4	90	2	3	1	0	0	
00:00:24			0							

Total number of neighbors 2

Total number of Established sessions 2

```
#show ip bgp neighbors
BGP neighbor is 10.20.30.1, remote AS 400, local AS 7000, external link
BGP version 4, local router ID 192.168.52.3, remote router ID 192.168.52.2
Neighbor under common administration
BGP state = Established, up for 00:01:25
Last read 00:01:25, hold time is 90, keepalive interval is 30 seconds
Neighbor capabilities:
Route refresh: advertised and received (old and new)
```

BGP

```
Address family IPv4 Unicast: advertised and received
Received 4 messages, 0 notifications, 0 in queue
Sent 4 messages, 0 notifications, 0 in queue
Route refresh request: received 0, sent 0
Minimum time between advertisement runs is 30 seconds
For address family: IPv4 Unicast
BGP table version 1, neighbor version 1
Index 1, Offset 0, Mask 0x2
Community attribute sent to this neighbor (both)
0 accepted prefixes
0 announced prefixes
```

```
Connections established 1; dropped 0
Local host: 10.20.30.2, Local port: 35108
Foreign host: 10.20.30.1, Foreign port: 179
Nexthop: 10.20.30.2
Nexthop global: fe80::a00:27ff:fe21:7ed2
Nexthop local: ::
BGP connection: non shared network
```

```
BGP neighbor is 11.20.30.30, remote AS 90, local AS 7000, external link
BGP version 4, remote router ID 192.168.56.103
Neighbor under common administration
BGP state = Established, up for 00:00:13
Last read 00:00:13, hold time is 90, keepalive interval is 30 seconds
Neighbor capabilities:
Route refresh: advertised and received (old and new)
Address family IPv4 Unicast: advertised and received
Received 2 messages, 0 notifications, 0 in queue
Sent 3 messages, 0 notifications, 0 in queue
Route refresh request: received 0, sent 0
Minimum time between advertisement runs is 30 seconds
For address family: IPv4 Unicast
BGP table version 1, neighbor version 1
Index 2, Offset 0, Mask 0x4
Community attribute sent to this neighbor (both)
0 accepted prefixes
0 announced prefixes
```

```
Connections established 1; dropped 0
Local host: 11.20.30.20, Local port: 179
Foreign host: 11.20.30.30, Foreign port: 33465
Nexthop: 11.20.30.20
Nexthop global: fe80::a00:27ff:fed0:57d1
Nexthop local: ::
BGP connection: non shared network
```

R1

```
#show ip bgp neighbors
BGP neighbor is 10.20.30.2, remote AS 7000, local AS 400, external link
BGP version 4, local router ID 192.168.52.2, remote router ID 192.168.52.3
Neighbor under common administration
BGP state = Established, up for 00:01:51
Last read 00:01:51, hold time is 90, keepalive interval is 30 seconds
```

```

Neighbor capabilities:
  Route refresh: advertised and received (old and new)
  Address family IPv4 Unicast: advertised and received
Received 5 messages, 0 notifications, 0 in queue
Sent 6 messages, 0 notifications, 0 in queue
Route refresh request: received 0, sent 0
Minimum time between advertisement runs is 30 seconds
For address family: IPv4 Unicast
  BGP table version 3, neighbor version 3
  Index 1, Offset 0, Mask 0x2
  Community attribute sent to this neighbor (both)
  0 accepted prefixes
  0 announced prefixes

Connections established 1; dropped 0
Local host: 10.20.30.1, Local port: 179
Foreign host: 10.20.30.2, Foreign port: 35108
Nexthop: 10.20.30.1
Nexthop global: fe80::a00:27ff:fe50:6a9b
Nexthop local: ::
BGP connection: non shared network

```

```

#sh ip bgp summary
BGP router identifier 192.168.52.3, local AS number 400
BGP table version is 3
1 BGP AS-PATH entries
0 BGP community entries

```

Neighbor	Down	State/PfxRcd	V	AS	MsgRcv	MsgSen	TblVer	InQ	OutQ	Up/
10.20.30.2	00:01:57		4	7000	5	6	3	0	0	

```
Total number of neighbors 1
```

```
Total number of Established sessions 1
```

R3

```

#sh ip bgp neighbors
BGP neighbor is 11.20.30.20, remote AS 7000, local AS 90, external link
  BGP version 4, local router ID 192.168.52.5, remote router ID 192.168.52.3
  Neighbor under common administration
  BGP state = Established, up for 00:00:04
  Last read 00:00:04, hold time is 90, keepalive interval is 30 seconds
Neighbor capabilities:
  Route refresh: advertised and received (old and new)
  Address family IPv4 Unicast: advertised and received
Received 2 messages, 0 notifications, 0 in queue
Sent 2 messages, 0 notifications, 0 in queue
Route refresh request: received 0, sent 0
Minimum time between advertisement runs is 30 seconds
For address family: IPv4 Unicast
  BGP table version 1, neighbor version 1
  Index 1, Offset 0, Mask 0x2
  Community attribute sent to this neighbor (both)

```

```
0 accepted prefixes
0 announced prefixes
```

```
Connections established 1; dropped 0
Local host: 11.20.30.30, Local port: 33465
Foreign host: 11.20.30.20, Foreign port: 179
NextHop: 11.20.30.30
NextHop global: fe80::a00:27ff:fe24:5dc9
NextHop local: ::
BGP connection: non shared network
```

```
#sh ip bgp summary
BGP router identifier 192.168.56.103, local AS number 90
BGP table version is 1
0 BGP AS-PATH entries
0 BGP community entries
```

Neighbor	Down	State/PfxRcd	V	AS	MsgRcv	MsgSen	TblVer	InQ	OutQ	Up/
11.20.30.20			4	7000	3	3	1	0	0	
00:00:55			0							

```
Total number of neighbors 1
```

```
Total number of Established sessions 1
```

Multiple Autonomous Systems

In the following example, R1 and R2 are members of the same confederation with the same AS numbers, and R3 is a member of the same confederation with a different AS number.

Topology

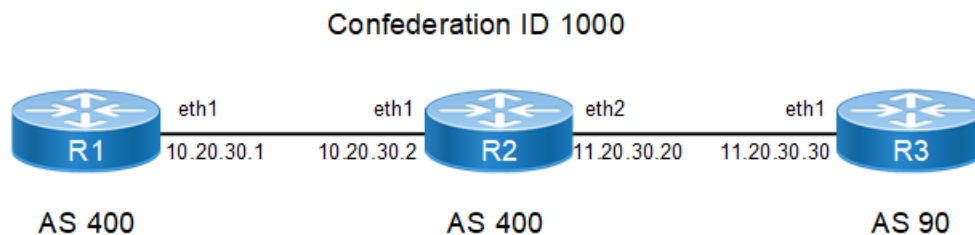

R1

#configure terminal	Enter Configure Mode
(config)#router bgp 400	Assign the ASN value (400) to the router.
(config-router)#bgp confederation identifier 1000	Specify the BGP confederation ID.
(config-router)#neighbor 10.20.30.2 remote-as 400	Specify the neighbor's IP address (10.20.30.2) and the ASN value of the neighbor (400).
(config-router)# address-family ipv4 unicast	Enter address-family ipv4 unicast mode

(config-router-af)# neighbor 10.20.30.2 activate	Activate the neighbor under address family mode
(config-router-af)#exit-address-family	Exit address-family mode.
(config-router)#commit	Commit the candidate configuration to the running configuration.

R2

#configure terminal	Enter configure mode.
(config)#router bgp 400	Assign the ASN value (400) to the router.
(config-router)#bgp confederation identifier 1000	Specify the BGP confederation ID.
(config-router)#bgp confederation peers 90	Specify the neighbor ASN value for confederation membership.
(config-router)#neighbor 10.20.30.1 remote-as 400	Specify the neighbor's IP address (10.20.30.1) and the ASN value of the neighbor (400).
(config-router)#neighbor 11.20.30.30 remote-as 90	Specify the neighbor's IP address (11.20.30.30) and the ASN value of the neighbor (90).
(config-router)# address-family ipv4 unicast	Enter address-family ipv4 unicast mode
(config-router-af)# neighbor 10.20.30.1 activate	Activate the neighbor under address family mode
(config-router-af)# neighbor 11.20.30.30 activate	Activate the neighbor under address family mode
(config-router-af)#exit-address-family	Exit address-family mode.
(config-router)#commit	Commit the candidate configuration to the running configuration.

R3

#configure terminal	Enter configure mode.
(config)#router bgp 90	Assign the ASN value (90) to the router.
(config-router)#bgp confederation identifier 1000	Specify the BGP confederation ID.
(config-router)#bgp confederation peers 400	Specify the neighbor ASN value for confederation membership.
(config-router)#neighbor 11.20.30.20 remote-as 400	Specify the neighbor's IP address (11.20.30.20) and the ASN value of the neighbor (400).
(config-router)# address-family ipv4 unicast	Enter address-family ipv4 unicast mode
(config-router-af)# neighbor 11.20.30.20 activate	Activate the neighbor under address family mode
(config-router-af)#exit-address-family	Exit address-family mode.
(config-router)#commit	Commit the candidate configuration to the running configuration.

Validation

R2

```
#show ip bgp summary
BGP router identifier 192.168.52.3, local AS number 400
BGP table version is 1
0 BGP AS-PATH entries
0 BGP community entries
```

Neighbor Down State/PfxRcd	V	AS	MsgRcv	MsgSen	TblVer	InQ	OutQ	Up/
10.20.30.1 00:07:27	4	400	16	16	1	0	0	
11.20.30.30 00:00:27	4	90	32	42	1	0	0	

Total number of neighbors 2

Total number of Established sessions 2

```
#show ip bgp neighbors
```

```
BGP neighbor is 10.20.30.1, remote AS 400, local AS 400, internal link
  BGP version 4, local router ID 192.168.52.3, remote router ID 192.168.52.2
  BGP state = Established, up for 00:08:10
  Last read 00:08:10, hold time is 90, keepalive interval is 30 seconds
  Neighbor capabilities:
```

```
  Route refresh: advertised and received (old and new)
```

```
  Address family IPv4 Unicast: advertised and received
```

```
  Received 18 messages, 0 notifications, 0 in queue
```

```
  Sent 18 messages, 0 notifications, 0 in queue
```

```
  Route refresh request: received 0, sent 0
```

```
  Minimum time between advertisement runs is 5 seconds
```

```
For address family: IPv4 Unicast
```

```
  BGP table version 1, neighbor version 1
```

```
  Index 1, Offset 0, Mask 0x2
```

```
  Community attribute sent to this neighbor (both)
```

```
  0 accepted prefixes
```

```
  0 announced prefixes
```

```
  Connections established 1; dropped 0
```

```
Local host: 10.20.30.2, Local port: 35214
```

```
Foreign host: 10.20.30.1, Foreign port: 179
```

```
Nexthop: 10.20.30.2
```

```
Nexthop global: fe80::a00:27ff:fe21:7ed2
```

```
Nexthop local: ::
```

```
BGP connection: non shared network
```

```
BGP neighbor is 11.20.30.30, remote AS 90, local AS 400, external link
```

```
  BGP version 4, remote router ID 192.168.56.103
```

```
  Neighbor under common administration
```

```
  BGP state = Established, up for 00:01:10
```

```
  Last read 00:01:10, hold time is 90, keepalive interval is 30 seconds
```

```
  Neighbor capabilities:
```

```
  Route refresh: advertised and received (old and new)
```

```
  Address family IPv4 Unicast: advertised and received
```

```
  Received 20 messages, 14 notifications, 0 in queue
```

```
  Sent 42 messages, 2 notifications, 0 in queue
```

```
Route refresh request: received 0, sent 0
Minimum time between advertisement runs is 30 seconds
For address family: IPv4 Unicast
BGP table version 1, neighbor version 1
Index 2, Offset 0, Mask 0x4
Community attribute sent to this neighbor (both)
0 accepted prefixes
0 announced prefixes

Connections established 1; dropped 0
Local host: 11.20.30.20, Local port: 179
Foreign host: 11.20.30.30, Foreign port: 33623
Nexthop: 11.20.30.20
Nexthop global: fe80::a00:27ff:fed0:57d1
Nexthop local: ::
BGP connection: non shared network
Last Reset: 00:01:36, due to BGP Notification sent
Notification Error Message: (OPEN Message Error/Bad Peer AS.)
```

R1

```
#show ip bgp neighbors
BGP neighbor is 10.20.30.2, remote AS 400, local AS 400, internal link
  BGP version 4, local router ID 192.168.52.2, remote router ID 192.168.52.3
  BGP state = Established, up for 00:08:41
  Last read 00:08:41, hold time is 90, keepalive interval is 30 seconds
  Neighbor capabilities:
    Route refresh: advertised and received (old and new)
    Address family IPv4 Unicast: advertised and received
  Received 34 messages, 0 notifications, 0 in queue
  Sent 35 messages, 3 notifications, 0 in queue
  Route refresh request: received 0, sent 0
  Minimum time between advertisement runs is 5 seconds
For address family: IPv4 Unicast
BGP table version 16, neighbor version 16
Index 1, Offset 0, Mask 0x2
Community attribute sent to this neighbor (both)
0 accepted prefixes
0 announced prefixes

Connections established 2; dropped 1
Local host: 10.20.30.1, Local port: 179
Foreign host: 10.20.30.2, Foreign port: 35214
Nexthop: 10.20.30.1
Nexthop global: fe80::a00:27ff:fe50:6a9b
Nexthop local: ::
BGP connection: non shared network
Last Reset: 00:09:03, due to BGP Notification sent
Notification Error Message: (OPEN Message Error/Bad Peer AS.)

#show ip bgp summary
BGP router identifier 192.168.52.2, local AS number 400
BGP table version is 16
1 BGP AS-PATH entries
0 BGP community entries
```

BGP

Neighbor Down State/PfxRcd	V	AS	MsgRcv	MsgSen	TblVer	InQ	OutQ	Up/
10.20.30.2 00:08:44	4	400	34	38	16	0	0	

Total number of neighbors 1

Total number of Established sessions 1

R3

```
#show ip bgp summary
BGP router identifier 192.168.52.5, local AS number 90
BGP table version is 1
0 BGP AS-PATH entries
0 BGP community entries
```

Neighbor Down State/PfxRcd	V	AS	MsgRcv	MsgSen	TblVer	InQ	OutQ	Up/
11.20.30.20 00:00:15	4	400	2	2	1	0	0	

Total number of neighbors 1

Total number of Established sessions 1

```
#show ip bgp neighbors
BGP neighbor is 11.20.30.20, remote AS 400, local AS 90, external link
  BGP version 4, local router ID 192.168.52.5, remote router ID 192.168.52.3
  Neighbor under common administration
  BGP state = Established, up for 00:02:24
  Last read 00:02:24, hold time is 90, keepalive interval is 30 seconds
  Neighbor capabilities:
    Route refresh: advertised and received (old and new)
    Address family IPv4 Unicast: advertised and received
  Received 6 messages, 0 notifications, 0 in queue
  Sent 6 messages, 0 notifications, 0 in queue
  Route refresh request: received 0, sent 0
  Minimum time between advertisement runs is 30 seconds
  For address family: IPv4 Unicast
  BGP table version 1, neighbor version 1
  Index 1, Offset 0, Mask 0x2
  Community attribute sent to this neighbor (both)
  0 accepted prefixes
  0 announced prefixes

  Connections established 1; dropped 0
  Local host: 11.20.30.30, Local port: 33623
  Foreign host: 11.20.30.20, Foreign port: 179
  Nexthop: 11.20.30.30
  Nexthop global: fe80::a00:27ff:fe24:5dc9
  Nexthop local: ::
  BGP connection: non shared network
```

Outside Autonomous System

In the following example, R1 and R2 are members of the same confederation with different AS numbers, and R3 is a member outside the confederation.

Topology

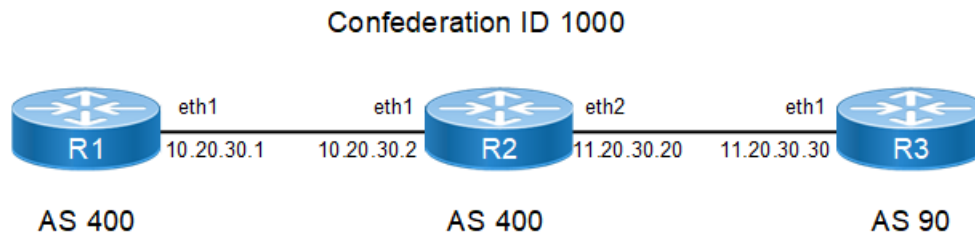

Figure 1-8: Single Confederation with Outside AS

R1

#configure terminal	Enter configure mode.
(config)#router bgp 400	Assign the ASN value (400) to the router.
(config-router)#bgp confederation identifier 1000	Specify the BGP confederation ID.
(config-router)#bgp confederation peers 7000	Specify the neighbor ASN value for confederation membership.
(config-router)#neighbor 10.20.30.2 remote-as 7000	Specify the neighbor's IP address (10.20.30.2) and the ASN value of the neighbor (7000).
(config-router)# address-family ipv4 unicast	Enter address-family ipv4 unicast mode
(config-router-af)# neighbor 10.20.30.2 activate	Activate the neighbor under address family mode
(config-router-af)#exit-address-family	Exit address-family mode.
(config-router)#commit	Commit the candidate configuration to the running configuration.

R2

(config)#configure terminal	Enter configure mode
(config)#router bgp 7000	Assign the ASN value (7000) to the router.
(config-router)#bgp confederation identifier 1000	Specify the BGP confederation ID.
(config-router)#bgp confederation peers 400	Specify the neighbor ASN value for confederation membership.
(config-router)#neighbor 10.20.30.1 remote-as 400	Specify the neighbor's IP address (10.20.30.1) and the ASN value of the neighbor (400).
(config-router)#neighbor 11.20.30.30 remote-as 90	Specify the neighbor's IP address (11.20.30.30) and the ASN value of the neighbor (90).
(config-router)# address-family ipv4 unicast	Enter address-family ipv4 unicast mode
(config-router-af)# neighbor 10.20.30.1 activate	Activate the neighbor under address family mode
(config-router-af)# neighbor 11.20.30.30 activate	Activate the neighbor under address family mode

BGP

(config-router-af)#exit-address-family	Exit address-family mode.
(config-router)#commit	Commit the candidate configuration to the running configuration.

R3

#configure terminal	Enter configure mode.
(config)#router bgp 90	Assign the ASN value (90) to the router.
(config-router)#neighbor 11.20.30.20 remote-as 1000	Specify the neighbor's IP address (11.20.30.20) and the BGP confederation ID (1000).
(config-router)# address-family ipv4 unicast	Enter address-family ipv4 unicast mode
(config-router-af)# neighbor 11.20.30.20 activate	Activate the neighbor under address family mode
(config-router-af)#exit-address-family	Exit address-family mode.
(config-router)#commit	Commit the candidate configuration to the running configuration.

Validation

R3

```
#show ip bgp neighbors
BGP neighbor is 11.20.30.20, remote AS 1000, local AS 90, external link
  BGP version 4, local router ID 192.168.52.5, remote router ID 192.168.52.3
  BGP state = Established, up for 00:01:10
  Last read 00:01:10, hold time is 90, keepalive interval is 30 seconds
  Neighbor capabilities:
    Route refresh: advertised and received (old and new)
    Address family IPv4 Unicast: advertised and received
  Received 112 messages, 1 notifications, 0 in queue
  Sent 142 messages, 88 notifications, 0 in queue
  Route refresh request: received 0, sent 0
  Minimum time between advertisement runs is 30 seconds
For address family: IPv4 Unicast
  BGP table version 1, neighbor version 1
  Index 1, Offset 0, Mask 0x2
  Community attribute sent to this neighbor (both)
  0 accepted prefixes
  0 announced prefixes

Connections established 2; dropped 1
Local host: 11.20.30.30, Local port: 33951
Foreign host: 11.20.30.20, Foreign port: 179
Nexthop: 11.20.30.30
Nexthop global: fe80::a00:27ff:fe24:5dc9
Nexthop local: ::
BGP connection: non shared network
Last Reset: 00:01:26, due to BGP Notification sent
Notification Error Message: (OPEN Message Error/Bad Peer AS.)

#sh ip bgp summary
BGP router identifier 192.168.52.5, local AS number 90
```

BGP table version is 1
 0 BGP AS-PATH entries
 0 BGP community entries

Neighbor Down State/PfxRcd	V	AS	MsgRcv	MsgSen	TblVer	InQ	OutQ	Up/
11.20.30.20 00:01:13	4	1000	113	230	1	0	0	

Total number of neighbors 1

Total number of Established sessions 1

R2

```
#show ip bgp summary
BGP router identifier 192.168.52.3, local AS number 7000
BGP table version is 1
0 BGP AS-PATH entries
0 BGP community entries
```

Neighbor Down State/PfxRcd	V	AS	MsgRcv	MsgSen	TblVer	InQ	OutQ	Up/
10.20.30.1 00:10:04	4	400	22	22	1	0	0	
11.20.30.30 00:00:42	4	90	179	202	1	0	0	

Total number of neighbors 2

Total number of Established sessions 2

```
#show ip bgp neighbors
BGP neighbor is 10.20.30.1, remote AS 400, local AS 7000, external link
  BGP version 4, local router ID 192.168.52.3, remote router ID 192.168.52.3
  Neighbor under common administration
  BGP state = Established, up for 00:11:06
  Last read 00:11:06, hold time is 90, keepalive interval is 30 seconds
  Neighbor capabilities:
    Route refresh: advertised and received (old and new)
    Address family IPv4 Unicast: advertised and received
  Received 24 messages, 0 notifications, 0 in queue
  Sent 24 messages, 0 notifications, 0 in queue
  Route refresh request: received 0, sent 0
  Minimum time between advertisement runs is 30 seconds
For address family: IPv4 Unicast
  BGP table version 1, neighbor version 1
  Index 1, Offset 0, Mask 0x2
  Community attribute sent to this neighbor (both)
  0 accepted prefixes
  0 announced prefixes
```

```
Connections established 1; dropped 0
Local host: 10.20.30.2, Local port: 35444
Foreign host: 10.20.30.1, Foreign port: 179
Next hop: 10.20.30.2
Next hop global: fe80::a00:27ff:fe21:7ed2
```

BGP

```
Nexthop local: ::
BGP connection: non shared network

BGP neighbor is 11.20.30.30, remote AS 90, local AS 1000, external link
  BGP version 4, remote router ID 192.168.56.103
  BGP state = Established, up for 00:01:44
  Last read 00:01:44, hold time is 90, keepalive interval is 30 seconds
  Neighbor capabilities:
    Route refresh: advertised and received (old and new)
    Address family IPv4 Unicast: advertised and received
  Received 93 messages, 88 notifications, 0 in queue
  Sent 204 messages, 0 notifications, 0 in queue
  Route refresh request: received 0, sent 0
  Minimum time between advertisement runs is 30 seconds
For address family: IPv4 Unicast
  BGP table version 1, neighbor version 1
  Index 2, Offset 0, Mask 0x4
  Community attribute sent to this neighbor (both)
  0 accepted prefixes
  0 announced prefixes

Connections established 1; dropped 0
Local host: 11.20.30.20, Local port: 179
Foreign host: 11.20.30.30, Foreign port: 33951
Nexthop: 11.20.30.20
Nexthop global: fe80::a00:27ff:fed0:57d1
Nexthop local: ::
BGP connection: non shared network
Last Reset: 00:02:00, due to BGP Notification received
Notification Error Message: (OPEN Message Error/Bad Peer AS.)
```

R1

```
#sh ip bgp summary
BGP router identifier 192.168.52.2, local AS number 400
BGP table version is 34
1 BGP AS-PATH entries
0 BGP community entries

Neighbor          V    AS  MsgRcv   MsgSen  TblVer   InQ   OutQ   Up/
Down    State/PfxRcd
10.20.30.2      4  7000    77       91     34     0     0
00:10:18             0

Total number of neighbors 1

Total number of Established sessions 1
#sh ip bgp neighbors
BGP neighbor is 10.20.30.2, remote AS 7000, local AS 400, external link
  BGP version 4, local router ID 192.168.52.2, remote router ID 192.168.52.3
  Neighbor under common administration
  BGP state = Established, up for 00:11:40
  Last read 00:11:40, hold time is 90, keepalive interval is 30 seconds
  Neighbor capabilities:
    Route refresh: advertised and received (old and new)
    Address family IPv4 Unicast: advertised and received
  Received 80 messages, 0 notifications, 0 in queue
```

```
Sent 82 messages, 12 notifications, 0 in queue
Route refresh request: received 0, sent 0
Minimum time between advertisement runs is 30 seconds
For address family: IPv4 Unicast
BGP table version 35, neighbor version 35
Index 1, Offset 0, Mask 0x2
Community attribute sent to this neighbor (both)
0 accepted prefixes
0 announced prefixes

Connections established 3; dropped 2
Local host: 10.20.30.1, Local port: 179
Foreign host: 10.20.30.2, Foreign port: 35444
Next hop: 10.20.30.1
Next hop global: fe80::a00:27ff:fe50:6a9b
Next hop local: ::
BGP connection: non shared network
Last Reset: 00:12:47, due to BGP Notification sent
Notification Error Message: (OPEN Message Error/Bad Peer AS.)
```

Dynamic BGP Peering

BGP Dynamic Neighbors is a quick way of setting up BGP on device like a Hub router where user is expecting numerous BGP neighbors. Before dynamic neighbors, user had to provide a large amount of configuration to work with all these neighbors. This new feature dramatically reduces the amount and complexity of CLI configuration on the router and save CPU and memory usage.

BGP dynamic neighbor support allows BGP peering to a group of remote neighbors that are defined by a range of IP addresses. Each range can be configured as a subnet IP address. BGP dynamic neighbors are configured using a range of IP addresses and BGP peer groups.

After a subnet range is configured for a BGP peer group and a TCP session is initiated by another router for an IP address in the subnet range, a new BGP neighbor is dynamically created as a member of that group. After the initial configuration of subnet ranges and activation of the peer group, dynamic BGP neighbor creation does not require any further CLI configuration on the initial router. Other routers can establish a BGP session with the initial router, but the initial router need not establish a BGP session to other routers if the IP address of the remote peer used for the BGP session is not within the configured range.

A dynamic BGP neighbor will inherit any configuration for the peer group. In larger BGP networks, implementing BGP dynamic neighbors can reduce the amount and complexity of CLI configuration and save CPU and memory usage. Both IPv4 and IPV6 peering is supported.

IPv4 IBGP Configuration

Below figure displays the minimum configuration required to enable BGP on an interface. R1 and R2 are two routers belonging to the same AS, AS100, connecting to network 11.11.11.0/24 and 11.11.12.0/24. First, define the routing process and the AS number to which the routers belong. Then, define BGP neighbors to start exchanging routing updates.

Topology

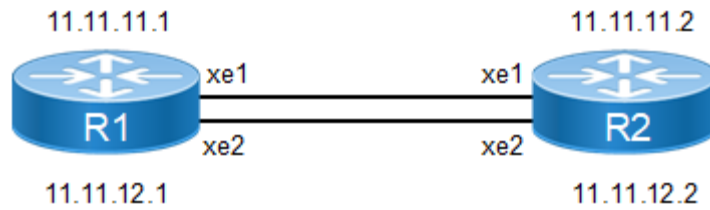

Figure 1-9: IPv4 IBGP Peering

R1

#configure terminal	Enter configure mode.
(config)#interface lo	Enter interface mode for loopback.
(config-if)#ip address 33.33.33.33/32 secondary	Assign a secondary IP address.
(config-if)#exit	Exit interface mode.
(config)#interface xe1	Enter interface mode for xe1.
(config-if)#ip address 11.11.11.1/24	Assign IP address to the interface.
(config-if)#exit	Exit interface mode.
(config)#interface xe2	Enter interface mode for xe2.
(config-if)#ip add 11.11.12.1/24	Assign IP address to the interface.
(config-if)#exit	Exit interface mode.
(config)#router bgp 100	Enter Router BGP mode.
(config-router)#bgp router-id 1.1.1.1	Assign a BGP router ID.
(config-router)#neighbor IPV4_IBGP_PEER peer- group range 11.11.0.0/16	Create a dynamic peer-group, IPV4_IBGP_PEER with a dynamic range 11.11.0.0/16
(config-router)#neighbor IPV4_IBGP_PEER remote-as 100	Assign a remote AS for the peer-group, IPV4_IBGP_PEER.
(config-router)#address-family ipv4 unicast	Enter address-family ipv4 unicast mode
(config-router-af)# neighbor IPV4_IBGP_PEER activate	Activate peer-group in the address family
(config-router-af)#exit-address-family	Exit from address family mode.
(config-router)#commit	Commit the candidate configuration to the running configuration.

R2

#configure terminal	Enter configure mode.
(config)#interface lo	Enter interface mode for loopback.
(config-if)#ip address 22.22.22.22/32 secondary	Assign a secondary IP address.
(config-if)#exit	Exit interface mode.
(config)#interface xe1	Enter interface mode for xe1.
(config-if)#ip address 11.11.11.2/24	Assign IP address to the interface.

(config-if)#exit	Exit interface mode.
(config)#interface xe2	Enter interface mode for xe2.
(config-if)#ip add 11.11.12.2/24	Assign IP address to the interface.
(config-if)#exit	Exit interface mode.
(config)#router bgp 100	Enter Router BGP mode.
(config-router)#bgp router-id 2.2.2.2	Assign a BGP router ID.
(config-router)#neighbor 11.11.11.1 remote-as 100	Create a static BGP neighbor 11.11.11.1 in remote AS 100.
(config-router)#neighbor 11.11.12.1 remote-as 100	Create a static BGP neighbor 11.11.12.1 in remote AS 100.
(config-router)#address-family ipv4 unicast	Enter address-family ipv4 unicast mode
(config-router-af)# neighbor 11.11.12.1 activate	Activate the neighbor under address family mode
(config-router-af)# neighbor 11.11.12.1 activate	Activate the neighbor under address family mode
(config-router-af)# network 22.22.22.22/32	Advertise the loopback network into BGP.
(config-router-af)#exit-address-family	Exit address-family mode.
(config-router)#commit	Commit the candidate configuration to the running configuration.

Validation

R1

```
#show ip bgp summary
```

```
BGP router identifier 1.1.1.1, local AS number 100
BGP table version is 2
1 BGP AS-PATH entries
0 BGP community entries
```

```
Neighbor          V    AS  MsgRcv   MsgSen  TblVer   InQ   OutQ   Up/
Down  State/PfxRcd
*11.11.11.2        4    100    42      43       2     0     0
00:20:25          1
*11.11.12.2        4    100    42      43       2     0     0
00:20:25          1
* Dynamically created based on a listen range command
```

```
BGP dynamic peer-group: IPV4_IBGP_PEER
listen range: 11.11.0.0/16
Total number of dynamically created neighbors/limit: 2/(200)
```

```
Total number of dynamically created neighbors: 2
Total number of activated dynamic peer-groups for IPv4 Unicast address-family:
1
```

```
Total number of neighbors 2
Total number of Established sessions 2
```

```
#show ip bgp neighbors
```

```
BGP neighbor is 11.11.11.2, remote AS 100, local AS 100, internal link
Member of peer-group IPV4_IBGP_PEER for session parameters
  BGP version 4, local router ID 1.1.1.1, remote router ID 2.2.2.2
  BGP state = Established, up for 00:21:56
  Last read 00:00:27, hold time is 90, keepalive interval is 30 seconds
  Neighbor capabilities:
    Route refresh: advertised and received (old and new)
    Address family IPv4 Unicast: advertised and received
  Received 46 messages, 0 notifications, 0 in queue
  Sent 46 messages, 0 notifications, 0 in queue
  Route refresh request: received 0, sent 0
  Minimum time between advertisement runs is 5 seconds
For address family: IPv4 Unicast
  BGP table version 3, neighbor version 3
  Index 0, Offset 0, Mask 0x1
  IPV4_IBGP_PEER peer-group member
  Community attribute sent to this neighbor (both)
  1 accepted prefixes
  1 announced prefixes

  Connections established 1; dropped 0
Local host: 11.11.11.1, Local port: 40361
Foreign host: 11.11.11.2, Foreign port: 179
Nexthop: 11.11.11.1
Nexthop global: ::
Nexthop local: ::
BGP connection: non shared network
```

```
BGP neighbor is 11.11.12.2, remote AS 100, local AS 100, internal link
Member of peer-group IPV4_IBGP_PEER for session parameters
  BGP version 4, local router ID 1.1.1.1, remote router ID 2.2.2.2
  BGP state = Established, up for 00:21:56
  Last read 00:00:27, hold time is 90, keepalive interval is 30 seconds
  Neighbor capabilities:
    Route refresh: advertised and received (old and new)
    Address family IPv4 Unicast: advertised and received
  Received 46 messages, 0 notifications, 0 in queue
  Sent 46 messages, 0 notifications, 0 in queue
  Route refresh request: received 0, sent 0
  Minimum time between advertisement runs is 5 seconds
For address family: IPv4 Unicast
  BGP table version 3, neighbor version 3
  Index 1, Offset 0, Mask 0x2
  IPV4_IBGP_PEER peer-group member
  Community attribute sent to this neighbor (both)
  1 accepted prefixes
  1 announced prefixes

  Connections established 1; dropped 0
Local host: 11.11.12.1, Local port: 33478
Foreign host: 11.11.12.2, Foreign port: 179
Nexthop: 11.11.12.1
Nexthop global: ::
Nexthop local: ::
BGP connection: non shared network
```



```
#show running-config bgp
router bgp 100
bgp router-id 1.1.1.1 network 33.33.33.33/32
neighbor IPV4_IBGP_PEER peer-group range 11.11.0.0/16 neighbor IPV4_IBGP_PEER
remote-as 100
!
address-family ipv4 unicast
neighbor IPV4_IBGP_PEER activate
exit-address-family

#show ip bgp
BGP table version is 2, local router ID is 1.1.1.1
Status codes: s suppressed, d damped, h history, * valid, > best, i -
internal,
l - labeled, S Stale
Origin codes: i - IGP, e - EGP, ? - incomplete

NetworkNext HopMetricLocPrfWeight Path
*>i22.22.22.22/3211.11.11.201000i
* i11.11.12.201000i
*>33.33.33.33/320.0.0.0010032768i

Total number of prefixes 2
```

R2

```
#show ip bgp summary
BGP router identifier 2.2.2.2, local AS number 100
BGP table version is 3
1 BGP AS-PATH entries
0 BGP community entries

Neighbor          V    AS  MsgRcv   MsgSen TblVer   InQ   OutQ   Up/
Down    State/PfxRcd
11.11.11.1        4   100    55      56      3      0      0
00:26:21          1
11.11.12.1        4   100    55      56      3      0      0
00:26:21          1

Total number of neighbors 2
Total number of Established sessions 2

#show bgp neighbors
BGP neighbor is 11.11.11.1, remote AS 100, local AS 100, internal link
BGP version 4, local router ID 2.2.2.2, remote router ID 1.1.1.1
BGP state = Established, up for 00:26:43
Last read 00:00:14, hold time is 90, keepalive interval is 30 seconds
Neighbor capabilities:
  Route refresh: advertised and received (old and new)
  Address family IPv4 Unicast: advertised and received
Received 56 messages, 0 notifications, 0 in queue
Sent 57 messages, 0 notifications, 0 in queue
Route refresh request: received 0, sent 0
Minimum time between advertisement runs is 5 seconds
For address family: IPv4 Unicast
```

```

BGP table version 3, neighbor version 3
Index 0, Offset 0, Mask 0x1
Community attribute sent to this neighbor (both)
1 accepted prefixes
1 announced prefixes

```

```

Connections established 1; dropped 0
Local host: 11.11.11.2, Local port: 179
Foreign host: 11.11.11.1, Foreign port: 40361
Nexthop: 11.11.11.2
Nexthop global: ::
Nexthop local: ::
BGP connection: non shared network

```

```

BGP neighbor is 11.11.12.1, remote AS 100, local AS 100, internal link
BGP version 4, local router ID 2.2.2.2, remote router ID 1.1.1.1
BGP state = Established, up for 00:26:43
Last read 00:00:14, hold time is 90, keepalive interval is 30 seconds
Neighbor capabilities:

```

```

Route refresh: advertised and received (old and new)
Address family IPv4 Unicast: advertised and received
Received 56 messages, 0 notifications, 0 in queue
Sent 57 messages, 0 notifications, 0 in queue
Route refresh request: received 0, sent 0
Minimum time between advertisement runs is 5 seconds

```

```

For address family: IPv4 Unicast
BGP table version 3, neighbor version 3
Index 1, Offset 0, Mask 0x2
Community attribute sent to this neighbor (both)
1 accepted prefixes
1 announced prefixes

```

```

Connections established 1; dropped 0
Local host: 11.11.12.2, Local port: 179
Foreign host: 11.11.12.1, Foreign port: 33478
Nexthop: 11.11.12.2
Nexthop global: ::
Nexthop local: ::
BGP connection: non shared network

```

```

#show ip bgp
BGP table version is 3, local router ID is 2.2.2.2
Status codes: s suppressed, d damped, h history, * valid, > best, i -
internal,

```

```

l - labeled, S Stale

```

```

Origin codes: i - IGP, e - EGP, ? - incomplete

```

	Network	Next Hop	Metric	LocPrf	Weight	Path
*>	22.22.22.22/32	0.0.0.0	0	100	32768	i
*>i	33.33.33.33/32	11.11.11.1	0	100	0	i
* i		11.11.12.1	0	100	0	i

```

Total number of prefixes 2

```

IPv4 IBGP VRF Configuration

Below figure displays the minimum configuration required to enable BGP on an interface with vrf enabled on the device and interface being part of vrf. R1 and R2 are two routers belonging to the same AS, AS100, connecting to network 11.11.11.0/24 and 11.11.12.0/24. First, define the routing process and the AS number to which the routers belong. Then, define BGP neighbors to start exchanging routing updates.

Topology

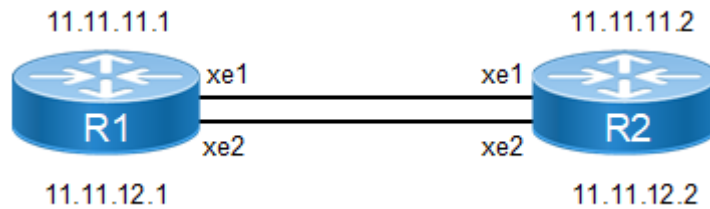

Figure 1-10: IPv4 VRF IBGP Peering

R1

#Configure terminal	Enter Configuration mode.
(config)#ip vrf vrfA	Create a VRF, vrfA on the router.
(config-vrf)#rd 1:1	Assign a route distinguisher to VRF.
(config-if)#exit	Exit VRF mode and return to Configure mode.
(config)#interface xe1	Enter interface mode for xe1.
(config-if)# ip vrf forwarding vrfA	Assign IP address to VRF.
(config-if)#ip address 11.11.11.1/24	Assign IP address to the interface.
(config-if)#exit	Exit interface mode.
(config)#interface xe2	Enter interface mode for xe2.
(config-if)# ip vrf forwarding vrfA	Assign IP address to VRF.
(config-if)#ip add 11.11.12.1/24	Assign IP address to the interface.
(config-if)#exit	Exit interface mode.
(config)#router bgp 100	Enter Router BGP mode.
(config-router)#bgp router-id 1.1.1.1	Assign a BGP router ID.
(config-router)#address-family ipv4 vrf vrfA	Enter IPv4 VRF Address Family.
(config-router-af)#neighbor IPV4_IBGP_PEER peer-group range 11.11.0.0/16	Create a dynamic peer-group, IPV4_IBGP_PEER with a dynamic range 11.11.0.0/16.
(config-router-af)#neighbor IPV4_IBGP_PEER remote-as 100	Assign a remote AS for the peer-group, IPV4_IBGP_PEER.
(config-router-af)# neighbor IPV4_IBGP_PEER activate	Activate peer-group in the address family
(config-router-af)#network 33.33.33.33/32	Advertise the loopback network into BGP
(config-router-af)#exit-address-family	Exit address-family mode.
(config-router)#commit	Commit the candidate configuration to the running configuration.

R2

#configure terminal	Enter configure mode.
(config)#ip vrf vrfA	Create a VRF, vrfA on router.
(config-vrf)#rd 2:1	Assign a route distinguisher to VRF.
(config-if)#exit	Exit VRF mode and return to Configure mode.
(config)#interface xe1	Enter interface mode for xe1.
(config-if)# ip vrf forwarding vrfA	Assign IP address to VRF.
(config-if)#ip address 11.11.11.2/24	Assign IP address to the interface.
(config-if)#exit	Exit interface mode.
(config)#interface xe2	Enter interface mode for xe2.
(config-if)# ip vrf forwarding vrfA	Assign IP address to VRF.
(config-if)#ip add 11.11.12.2/24	Assign IP address to the interface.
(config-if)#exit	Exit interface mode.
(config)#router bgp 100	Enter Router BGP mode.
(config-router)#bgp router-id 2.2.2.2	Assign a BGP router ID.
(config-router)#address-family ipv4 vrf vrfA	Enter IPv4 VRF Address Family.
(config-router-af)#neighbor 11.11.11.1 remote-as 100	Create a static BGP neighbor 11.11.11.1 in remote AS 100.
(config-router-af)# neighbor 11.11.11.1 activate	Activate neighbor in the address family
(config-router-af)#neighbor 11.11.12.1 remote-as 100	Create a static BGP neighbor 11.11.12.1 in remote AS 100
(config-router-af)# neighbor 11.11.12.1 activate	Activate neighbor in the address family
(config-router-af)#network 22.22.22.22/32	Advertise the loopback network into BGP.
(config-router-af)#exit-address-family	Exit address-family mode.
(config-router)#commit	Commit the candidate configuration to the running configuration.

Validation**R1**

```
#show running-config bgp
!
router bgp 100
  bgp router-id 1.1.1.1
  !
  address-family ipv4 vrf vrfA
    neighbor IPV4_VRF_IBGP_PEER peer-group range 11.11.0.0/16
    neighbor IPV4_VRF_IBGP_PEER remote-as 100
    neighbor IPV4_VRF_IBGP_PEER activate
  network 33.33.33.33/32
  exit-address-family
!
```

```

#show ip bgp summary vrf vrfA
BGP router identifier 11.11.11.1, local AS number 100
BGP VRF vrfA Route Distinguisher: 1:1
BGP table version is 1
1 BGP AS-PATH entries
0 BGP community entries

Neighbor          V    AS    MsgRcv   MsgSen  TblVer   InQ   OutQ   Up/
Down  State/PfxRcd
*11.11.11.2      4    100     3        3        1      0      0
00:01:00         0
*11.11.12.2     4    100     3        3        1      0      0
00:00:55         0
* Dynamically created based on a listen range command

BGP dynamic peer-group: IPV4_IBGP_PEER
  listen range: 11.11.0.0/16
  Total number of dynamically created neighbors/limit: 2/(200)

Total number of dynamically created neighbors: 2
Total number of activated dynamic peer-groups for IPv4 Unicast address-family:
1

Total number of neighbors 2

Total number of Established sessions 2

#show bgp neighbors
BGP neighbor is 11.11.11.2, vrf vrfA, remote AS 100, local AS 100, internal
link
Member of peer-group IPV4_IBGP_PEER for session parameters
  BGP version 4, local router ID 11.11.11.1, remote router ID 11.11.11.2
  BGP state = Established, up for 00:07:26
  Last read 00:00:26, hold time is 90, keepalive interval is 30 seconds
  Neighbor capabilities:
    Route refresh: advertised and received (old and new)
    Address family IPv4 Unicast: advertised and received
  Received 16 messages, 0 notifications, 0 in queue
  Sent 16 messages, 0 notifications, 0 in queue
  Route refresh request: received 0, sent 0
  Minimum time between advertisement runs is 5 seconds
For address family: IPv4 Unicast
  BGP table version 1, neighbor version 1
  Index 1, Offset 0, Mask 0x2
  IPV4_IBGP_PEER peer-group member
  Community attribute sent to this neighbor (both)
  0 accepted prefixes
  0 announced prefixes

Connections established 1; dropped 0
Local host: 11.11.11.1, Local port: 36365
Foreign host: 11.11.11.2, Foreign port: 179
Nexthop: 11.11.11.1
Nexthop global: ::
Nexthop local: ::
BGP connection: non shared network

```

```

BGP neighbor is 11.11.12.2, vrf vrfA, remote AS 100, local AS 100, internal
link
Member of peer-group IPV4_IBGP_PEER for session parameters
  BGP version 4, local router ID 11.11.11.1, remote router ID 11.11.11.2
  BGP state = Established, up for 00:07:21
  Last read 00:00:21, hold time is 90, keepalive interval is 30 seconds
  Neighbor capabilities:
    Route refresh: advertised and received (old and new)
    Address family IPv4 Unicast: advertised and received
  Received 16 messages, 0 notifications, 0 in queue
  Sent 16 messages, 0 notifications, 0 in queue
  Route refresh request: received 0, sent 0
  Minimum time between advertisement runs is 5 seconds
For address family: IPv4 Unicast
  BGP table version 1, neighbor version 1
  Index 2, Offset 0, Mask 0x4
  IPV4_IBGP_PEER peer-group member
  Community attribute sent to this neighbor (both)
  0 accepted prefixes
  0 announced prefixes

Connections established 1; dropped 0
Local host: 11.11.12.1, Local port: 38144
Foreign host: 11.11.12.2, Foreign port: 179
Next hop: 11.11.12.1
Next hop global: ::
Next hop local: ::
BGP connection: non shared network

```

IPv4 EBGP Configuration

Below figure displays the minimum configuration required to enable BGP on an interface. R1, R2 and R3 are three routers belonging to the different AS, AS100 AS200 and AS300, connecting to network 11.11.11.0/24 and 11.11.12.0/24. First, define the routing process and the AS number to which the routers belong. Then, define BGP neighbors to start exchanging routing updates.

Topology



Figure 1-11: IPv4 EBGP Peering

R1

#configure terminal	Enter configure mode.
(config)#interface lo	Enter interface mode for loopback.
(config-if)#ip address 33.33.33.33/32 secondary	Assign a secondary IP address.
(config-if)#exit	Exit interface mode.
(config)#interface xe1	Enter interface mode for xe1.
(config-if)#ip address 11.11.11.1/24	Assign IP address to the interface.

(config-if)#exit	Exit interface mode.
(config)#router bgp 100	Enter Router BGP mode.
(config-router)#bgp router-id 1.1.1.1	Assign a BGP router ID.
(config-router)#neighbor 11.11.11.2 remote-as 200	Create a static neighbor 11.11.11.2 with remote AS 200.
(config-router)# address-family ipv4 unicast	Enter address-family ipv4 unicast mode.
(config-router-af)# neighbor 11.11.11.2 activate	Activate the neighbor under address family mode
(config-router-af)#exit-address-family	Exit address-family mode.
(config-router)#commit	Commit the candidate configuration to the running configuration.

R2

#configure terminal	Enter configure mode.
(config)#interface lo	Enter interface mode for loopback.
(config-if)#ip address 22.22.22.22/32 secondary	Assign a secondary IP address.
(config-if)#exit	Exit interface mode.
(config)#interface xe1	Enter interface mode for xe1.
(config-if)#ip address 11.11.11.2/24	Assign IP address to the interface.
(config-if)#exit	Exit interface mode.
(config)#interface xe2	Enter interface mode for xe2.
(config-if)#ip add 11.11.12.2/24	Assign IP address to the interface.
(config-if)#exit	Exit interface mode.
(config)#router bgp 200	Enter Router BGP mode.
(config-router)#bgp router-id 2.2.2.2	Assign a BGP router ID.
(config-router)#neighbor IPV4_EBGP_PEER peer-group range 11.11.0.0/16	Create a dynamic peer-group, IPV4_EBGP_PEER.
(config-router)#neighbor IPV4_EBGP_PEER remote-as 100	Assign remote AS with the peer-group IPV4_EBGP_PEER.
(config-router)#neighbor IPV4_EBGP_PEER optional-as 300	Assign optional AS with the peer-group IPV4_EBGP_PEER
(config-router)#address-family ipv4 unicast	Enter address-family ipv4 unicast mode
(config-router-af)# neighbor IPV4_EBGP_PEER activate	Activate the peer-group in address family
(config-router-af)#network 22.22.22.22/32	Advertise the loopback network into BGP.
(config-router-af)#exit-address-family	Exit address-family mode.
(config-router)#commit	Commit the candidate configuration to the running configuration.

R3

#configure terminal	Enter configure mode.
(config)#interface lo	Enter interface mode for loopback.

BGP

(config-if)#ip address 44.44.44.44/32 secondary	Assign a secondary IP address.
(config-if)#exit	Exit interface mode.
(config)#interface xe2	Enter interface mode for xe2.
(config-if)#ip add 11.11.12.3/24	Assign IP address to the interface.
(config-if)#exit	Exit interface mode.
(config)#router bgp 300	Enter Router BGP mode.
(config-router)#bgp router-id 3.3.3.3	Assign a BGP router ID.
(config-router)#neighbor 11.11.12.2 remote- as 200	Create a static BGP neighbor 11.11.12.2 with remote AS 200.
(config-router)#address-family ipv4 unicast	Enter address-family ipv4 unicast mode
(config-router-af)# neighbor 11.11.12.2 activate	Activate the neighbor under address family mode
(config-router-af)#network 44.44.44.44/32	Advertise the loopback network into BGP.
(config-router-af)#exit-address-family	Exit address-family mode.
(config-router)#commit	Commit the candidate configuration to the running configuration.

Validation

R2

```
#show ip bgp summary
BGP router identifier 2.2.2.2, local AS number 200
BGP table version is 3
2 BGP AS-PATH entries
0 BGP community entries
Neighbor          V    AS  MsgRcv   MsgSen  TblVer   InQ   OutQ   Up/
Down    State/PfxRcd
*11.11.11.1      4    100    29       29       3       0     0
00:13:10        1
*11.11.12.3     4    300    27       27       3       0     0
00:12:20        1
* Dynamically created based on a listen range command

BGP dynamic peer-group: IPV4_EBGP_PEER
  listen range: 11.11.0.0/16
  Total number of dynamically created neighbors/limit: 2/(200)
Total number of dynamically created neighbors: 2
Total number of activated dynamic peer-groups for IPv4 Unicast address-family:
1
Total number of neighbors 2
Total number of Established sessions 2

#show running-config bgp
!
router bgp 200
  bgp router-id 2.2.2.2
  neighbor IPV4_EBGP_PEER peer-group range 11.11.0.0/16
  neighbor IPV4_EBGP_PEER remote-as 100
  neighbor IPV4_EBGP_PEER optional-as 300
!
```



```
address-family ipv4 unicast
neighbor IPV4_EBGP_PEER activate
network 22.22.22.22/32
exit-address-family
!
```

```
#show bgp neighbors
```

```
BGP neighbor is 11.11.11.1, remote AS 100, local AS 200, external link
Member of peer-group IPV4_EBGP_PEER for session parameters
BGP version 4, local router ID 2.2.2.2, remote router ID 1.1.1.1
BGP state = Established, up for 00:17:15
Last read 00:00:15, hold time is 90, keepalive interval is 30 seconds
Neighbor capabilities:
  Route refresh: advertised and received (old and new)
  Address family IPv4 Unicast: advertised and received
Received 37 messages, 0 notifications, 0 in queue
Sent 38 messages, 0 notifications, 0 in queue
Route refresh request: received 0, sent 0
Minimum time between advertisement runs is 30 seconds
For address family: IPv4 Unicast
BGP table version 3, neighbor version 3
Index 1, Offset 0, Mask 0x2
IPV4_EBGP_PEER peer-group member
Community attribute sent to this neighbor (both)
1 accepted prefixes
2 announced prefixes
```

```
Connections established 1; dropped 0
Local host: 11.11.11.2, Local port: 42252
Foreign host: 11.11.11.1, Foreign port: 179
Nexthop: 11.11.11.2
Nexthop global: ::
Nexthop local: ::
BGP connection: non shared network
```

```
BGP neighbor is 11.11.12.3, remote AS 300, local AS 200, external link
Member of peer-group IPV4_EBGP_PEER for session parameters
BGP version 4, local router ID 2.2.2.2, remote router ID 3.3.3.3
BGP state = Established, up for 00:13:17
Last read 00:00:17, hold time is 90, keepalive interval is 30 seconds
Neighbor capabilities:
  Route refresh: advertised and received (old and new)
  Address family IPv4 Unicast: advertised and received
Received 29 messages, 0 notifications, 0 in queue
Sent 30 messages, 0 notifications, 0 in queue
Route refresh request: received 0, sent 0
Minimum time between advertisement runs is 30 seconds
For address family: IPv4 Unicast
BGP table version 3, neighbor version 3
Index 2, Offset 0, Mask 0x4
IPV4_EBGP_PEER peer-group member
Community attribute sent to this neighbor (both)
1 accepted prefixes
2 announced prefixes
```

```
Connections established 1; dropped 0
```

```

Local host: 11.11.12.2, Local port: 59839
Foreign host: 11.11.12.3, Foreign port: 179
Nexthop: 11.11.12.2
Nexthop global: ::
Nexthop local: ::
BGP connection: non shared network

```

IPv6 IBGP Configuration

Below figure displays the minimum configuration required to enable BGP on an interface. R1 and R2 are two routers belonging to the same AS, AS100, connecting to network 11:11:11::1/64 and 11:11:12::1/64. First, define the routing process and the AS number to which the routers belong. Then, define BGP neighbors to start exchanging routing updates.

Topology

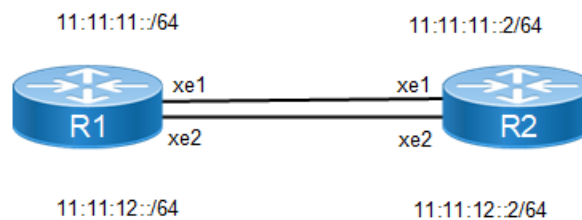

Figure 1-12: IPv6 IBGP Peering

R1

#Configure terminal	Enter configure mode.
(config)#interface lo	Enter interface mode for loopback.
(config-if)#ipv6 address 33::1/128	Assign an IPv6 address.
(config-if)#exit	Exit interface mode.
(config)#interface xe1	Enter interface mode for xe1.
(config-if)#ipv6 address 11:11:11::1/64	Assign an IPv6 address to the interface.
(config-if)#exit	Exit interface mode.
(config)#interface xe2	Enter interface mode for xe2.
(config-if)#ipv6 address 11:11:12::1/64	Assign an IPv6 address to the interface.
(config-if)#exit	Exit interface mode.
(config)#router bgp 100	Enter Router BGP mode.
(config-router)#bgp router-id 1.1.1.1	Assign a BGP router ID.
(config-router)#neighbor IPV6_IBGP_PEER peer-group range 11:11::/16	Create a dynamic peer-group, IPV6_IBGP_PEER with a dynamic range 11:11::/16
(config-router)#neighbor IPV6_IBGP_PEER remote-as 100	Configure a remote AS with the peer group, IPV6_IBGP_PEER.
(config-router)#neighbor IPV6_IBGP_PEER limit 1	Set peer group neighbors limit to 1. Only one BGP session will be up.
(config-router)#address-family ipv6 unicast	Enter the IPv6 Unicast Address Family.
(config-router-af)#neighbor IPV6_IBGP_PEER activate	Activate the peer group, IPV6_IBGP_PEER in the IPv6 address family.

(config-router-af)#network 33::1/128	Advertise the loopback network into the BGP IPv6 address family.
(config-router-af)#exit-address-family	Exit address-family mode.
(config-router)#commit	Commit the candidate configuration to the running configuration.

R2

#Configure terminal	Enter Configuration mode.
(config)#interface lo	Enter interface mode for loopback.
(config-if)#ipv6 address 22::2/128	Assign an IPv6 address.
(config-if)#exit	Exit interface mode.
(config)#interface xe1	Enter interface mode for xe1.
(config-if)#ipv6 address 11:11:11::2/64	Assign an IPv6 address to the interface.
(config-if)#exit	Exit interface mode.
(config)#interface xe2	Enter interface mode for xe2.
(config-if)#ipv6 address 11:11:12::2/64	Assign an IPv6 address to the interface.
(config-if)#exit	Exit interface mode.
(config)#router bgp 100	Enter Router BGP mode.
(config-router)#bgp router-id 2.2.2.2	Assign a BGP router ID.
(config-router)#neighbor 11:11:11::1 remote-as 100	Configure BGP neighbor by specifying the neighbor IP address.
(config-router)#neighbor 11:11:12::1 remote-as 100	Configure BGP neighbor by specifying the neighbor IP address.
(config-router)#address-family ipv4 unicast	Enter the Ipv4 Unicast Address Family.
(config-router-af)# neighbor 11:11:11::1 activate	Activate the neighbor under address family mode
(config-router-af)# neighbor 11:11:12::1 activate	Activate the neighbor under address family mode
(config-router-af)# exit-address-family	Exit address-family mode.
(config-router)#address-family ipv6 unicast	Enter the IPv6 Unicast Address Family.
(config-router-af)#network 22::2/128	Advertise the loopback network into BGP.
(config-router-af)#neighbor 11:11:12::1 activate	Activate the neighbor in the IPv6 address family.
(config-router-af)#neighbor 11:11:11::1 activate	Activate the neighbor in the IPv6 address family.
(config-router-af)#exit-address-family	Exit address-family mode.
(config-router)#commit	Commit the candidate configuration to the running configuration.

Validation

R1

```
#show ipv6 bgp summary
```

```

BGP router identifier 1.1.1.1, local AS number 100
BGP table version is 2
1 BGP AS-PATH entries
0 BGP community entries

```

```

Neighbor          V    AS  MsgRcv   MsgSen TblVer   InQ   OutQ   Up/
Down  State/PfxRcd
*11:11:11::2      4    100     6       6       2     0     0
00:01:41         1
* Dynamically created based on a listen range command

```

```

BGP dynamic peer-group: IPV6_IBGP_PEER
listen range: 11::/16
Total number of dynamically created neighbors/limit: 1/(1)

```

```

Total number of dynamically created neighbors: 1
Total number of activated dynamic peer-groups for IPv6 Unicast address-family:
1

```

```
Total number of neighbors 1
```

```
Total number of Established sessions 1
```

```
#show ip bgp peer-group IPV6_IBGP_PEER
```

```

BGP dynamic peer-group is IPV6_IBGP_PEER, IBGP, remote AS 100
BGP dynamic peer-group IPV6_IBGP_PEER listen range group members:
11::/16
BGP version 4

```

```
Minimum time between advertisement runs is 5 seconds
```

```
For address family: IPv4 Unicast
```

```
Peer-group member:
```

```
*11:11:11::2
```

```
Index 1, Offset 0, Mask 0x2
```

```
0 accepted prefixes, 0 announced prefixes
```

```
For address family: IPv6 Unicast
```

```
Peer-group member:
```

```
*11:11:11::2
```

```
Index 0, Offset 0, Mask 0x0
```

```
1 accepted prefixes, 1 announced prefixes
```

```
#show bgp ipv6
```

```
BGP table version is 2, local router ID is 1.1.1.1
```

```
Status codes: s suppressed, d damped, h history, * valid, > best, i -
internal,
```

```
l - labeled, S Stale
```

```
Origin codes: i - IGP, e - EGP, ? - incomplete
```

```

Network          Next Hop           Metric    LocPrf    Weight Path
*>i  22::2/128      11:11:11::2(fe80::5054:ff:fe95:85ec)
                                0          100         0         i
*>   33::1/128      ::                0          100        32768     i

```

```
Total number of prefixes 2
```

```
#show running-config bgp
```

```

!
router bgp 100
  bgp router-id 1.1.1.1
  neighbor IPV6_IBGP_PEER peer-group range 11::/16
  neighbor IPV6_IBGP_PEER remote-as 100
  neighbor IPV6_IBGP_PEER limit 1
  !
  address-family ipv6 unicast
  network 33::1/128
  neighbor IPV6_IBGP_PEER activate
  exit-address-family

#show bgp neighbors
BGP neighbor is 11:11:11::2, remote AS 100, local AS 100, internal link
Member of peer-group IPV6_IBGP_PEER for session parameters
  BGP version 4, local router ID 1.1.1.1, remote router ID 2.2.2.2
  BGP state = Established, up for 00:04:17
  Last read 00:00:18, hold time is 90, keepalive interval is 30 seconds
  Neighbor capabilities:
    Route refresh: advertised and received (old and new)
    Address family IPv4 Unicast: advertised and received
    Address family IPv6 Unicast: advertised and received
  Received 11 messages, 0 notifications, 0 in queue
  Sent 11 messages, 0 notifications, 0 in queue
  Route refresh request: received 0, sent 0
  Minimum time between advertisement runs is 5 seconds
For address family: IPv4 Unicast
  BGP table version 1, neighbor version 1
  Index 0, Offset 0, Mask 0x1
  IPV6_IBGP_PEER peer-group member
  Community attribute sent to this neighbor (both)
  0 accepted prefixes
  0 announced prefixes

For address family: IPv6 Unicast
  BGP table version 2, neighbor version 2
  Index 0, Offset 0, Mask 0x0
  IPV6_IBGP_PEER peer-group member
  Community attribute sent to this neighbor (both)
  1 accepted prefixes
  1 announced prefixes

Connections established 1; dropped 0
Local host: 11:11:11::1, Local port: 42410
Foreign host: 11:11:11::2, Foreign port: 179
Nexthop: 1.1.1.1
Nexthop global: 11:11:11::1
Nexthop local: fe80::5054:ff:fe51:f74
BGP connection: shared network

```

IPV6 IBGP VRF Configuration

Below figure displays the minimum configuration required to enable BGP on an interface with VRF enabled on the device and interface being part of VRF. R1 and R2 are two routers belonging to the same AS, AS100, connecting to

network 11:11:11::1 and 11:11:12::1. First, define the routing process and the AS number to which the routers belong. Then, define BGP neighbors to start exchanging routing updates.

Topology

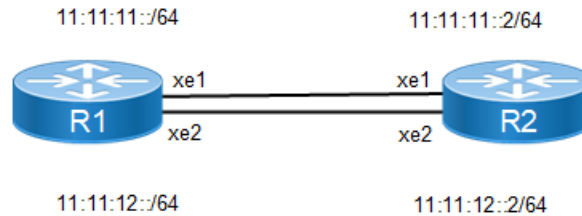

Figure 1-13: IPv6 VRF IBGP peering

R1

#Configure terminal	Enter Configuration mode.
(config)#ip vrf vrfA	Configure a VRF, vrfA.
(config-vrf)#rd 1:1	Configure a route distinguisher to VRF.
(config-vrf)#router-id 7.7.7.7	Configure a router ID.
(config-vrf)#exit	Exit from VRF mode and return to Configuration mode.
(config)#interface xe1	Enter interface mode for xe1.
(config-if)# ip vrf forwarding vrfA	Assign IP address to VRF.
(config-if)#ipv6 address 11:11:11::1/64	Assign an IPv6 address to the interface.
(config-if)#exit	Exit interface mode.
(config)#interface xe2	Enter interface mode for xe2.
(config-if)# ip vrf forwarding vrfA	Assign IP address to VRF.
(config-if)#ipv6 address 11:11:12::1/64	Assign an IPv6 address to the interface.
(config-if)#exit	Exit interface mode.
(config)#router bgp 100	Enter Router BGP mode.
(config-router)#address-family ipv6 vrf vrfA	Enter IPv6 VRF Address Family.
(config-router-af)#neighbor IPV6_VRF_IBGP_PEER peer-group range 11:11::1/ 16	Configure a dynamic peer group, IPV6_IBGP_PEER with a dynamic range value.
(config-router-af)#neighbor IPV6_VRF_IBGP_PEER remote-as 100	Configure a remote AS with the peer group, IPV6_IBGP_PEER.
(config-router-af)# neighbor IPV6_VRF_IBGP_PEER activate	Activate neighbor in the address family
(config-router-af)#exit-address-family	Exit address-family mode.
(config-router)#commit	Commit the candidate configuration to the running configuration.

R2

#configure terminal	Enter configure mode.
(config)#ip vrf vrfA	Configure a VRF, vrfA.
(config-vrf)#rd 2:1	Configure a route distinguisher to VRF.
(config-vrf)#router-id 1.1.1.1	Configure a router ID.
(config-vrf)#exit	Exit from VRF mode and return to Configuration mode.
(config)#interface xe1	Enter interface mode for xe1.
(config-if)# ip vrf forwarding vrfA	Assign IP address to VRF.
(config-if)#ipv6 address 11:11:11::2/64	Assign an IPv6 address to the interface.
(config-if)#exit	Exit interface mode.
(config)#interface xe2	Enter interface mode for xe2.
(config-if)# ip vrf forwarding vrfA	Assign IP address to vrf.
(config-if)#ipv6 address 11:11:12::2/64	Assign an IPv6 address to the interface.
(config-if)#exit	Exit interface mode.
(config)#router bgp 100	Enter Router BGP mode
(config-router)#address-family ipv6 vrf vrfA	Enter IPv6 VRF Address Family.
(config-router-af)#neighbor 11:11:12::1 remote-as 100	Configure BGP neighbor by specifying the neighbor IP address.
(config-router-af)# neighbor 11:11:12::1 activate	Activate neighbor in the address family
(config-router-af)#neighbor 11:11:11::1 remote-as 100	Configure BGP neighbor by specifying the neighbor IP address.
(config-router-af)# neighbor 11:11:11::1 activate	Activate neighbor in the address family
(config-router-af)#exit-address-family	Exit address-family mode.
(config-router)#commit	Commit the candidate configuration to the running configuration.

Validation**R1**

```
#show ipv6 bgp summary vrf vrfA
BGP router identifier 7.7.7.7, local AS number 100
BGP VRF vrfA Route Distinguisher: 1:1
BGP table version is 1
0 BGP AS-PATH entries
0 BGP community entries

Neighbor          V    AS  MsgRcv   MsgSen  TblVer   InQ   OutQ   Up/
Down    State/PfxRcd
*11:11:11::2      4    100     6         6         1     0     0
00:00:17          0
*11:11:12::2      4    100     7        10         1     0     0
00:00:15          0
* Dynamically created based on a listen range command
```

```
BGP dynamic peer-group: IPV6_VRF_IBGP_PEER
  listen range: 11::/16
  Total number of dynamically created neighbors/limit: 2/(200)

Total number of dynamically created neighbors: 2
Total number of activated dynamic peer-groups for IPv6 Unicast address-family:
1

Total number of neighbors 2

Total number of Established sessions 2

#show running-config bgp
!
router bgp 100
!
  address-family ipv6 vrf vrfA
  neighbor IPV6_VRF_IBGP_PEER peer-group range 11::/16
  neighbor IPV6_VRF_IBGP_PEER remote-as 100
  neighbor IPV6_VRF_IBGP_PEER activate
  exit-address-family
!

#show ip bgp peer-group vrf vrfA

BGP dynamic peer-group is IPV6_VRF_IBGP_PEER, IBGP, remote AS 100
  BGP dynamic peer-group IPV6_VRF_IBGP_PEER listen range group members:
  11::/16
  BGP version 4
  Minimum time between advertisement runs is 5 seconds
  For address family: IPv6 Unicast
  Peer-group member:
  *11:11:12::2
  Index 1, Offset 0, Mask 0x2
  0 accepted prefixes, 0 announced prefixes
  Peer-group member:
  *11:11:11::2
  Index 2, Offset 0, Mask 0x4
  0 accepted prefixes, 0 announced prefixes

#show running-config bgp
!
router bgp 100
!
  address-family ipv6 vrf vrfA
  neighbor IPV6_VRF_IBGP_PEER peer-group range 11::/16
  neighbor IPV6_VRF_IBGP_PEER remote-as 100
  neighbor IPV6_VRF_IBGP_PEER activate
  exit-address-family
!
#show bgp ipv6 neighbors
BGP neighbor is 11:11:11::2, vrf vrfA, remote AS 100, local AS 100, internal
link
  Member of peer-group IPV6_VRF_IBGP_PEER for session parameters
  BGP version 4, local router ID 7.7.7.7, remote router ID 1.1.1.1
  BGP state = Established, up for 00:02:13
```

```
Last read 00:00:14, hold time is 90, keepalive interval is 30 seconds
Neighbor capabilities:
  Route refresh: advertised and received (old and new)
  Address family IPv6 Unicast: advertised and received
  Received 8 messages, 2 notifications, 0 in queue
  Sent 10 messages, 0 notifications, 0 in queue
  Route refresh request: received 0, sent 0
  Minimum time between advertisement runs is 5 seconds
For address family: IPv6 Unicast
  BGP table version 1, neighbor version 1
  Index 2, Offset 0, Mask 0x4
  IPV6_VRF_IBGP_PEER peer-group member
  Community attribute sent to this neighbor (both)
  0 accepted prefixes
  0 announced prefixes

Connections established 1; dropped 0
Local host: 11:11:11::1, Local port: 179
Foreign host: 11:11:11::2, Foreign port: 48206
Nexthop: 7.7.7.7
Nexthop global: 11:11:11::1
Nexthop local: fe80::5054:ff:fe51:f74
BGP connection: shared network
Last Reset: 00:02:18, due to BGP Notification received
Notification Error Message: (OPEN Message Error/Bad BGP Identifier.)

BGP neighbor is 11:11:12::2, vrf vrfA, remote AS 100, local AS 100, internal
link
Member of peer-group IPV6_VRF_IBGP_PEER for session parameters
  BGP version 4, local router ID 7.7.7.7, remote router ID 1.1.1.1
  BGP state = Established, up for 00:02:11
  Last read 00:00:12, hold time is 90, keepalive interval is 30 seconds
Neighbor capabilities:
  Route refresh: advertised and received (old and new)
  Address family IPv6 Unicast: advertised and received
  Received 8 messages, 3 notifications, 0 in queue
  Sent 13 messages, 1 notifications, 0 in queue
  Route refresh request: received 0, sent 0
  Minimum time between advertisement runs is 5 seconds
For address family: IPv6 Unicast
  BGP table version 1, neighbor version 1
  Index 1, Offset 0, Mask 0x2
  IPV6_VRF_IBGP_PEER peer-group member
  Community attribute sent to this neighbor (both)
  0 accepted prefixes
  0 announced prefixes

Connections established 1; dropped 0
Local host: 11:11:12::1, Local port: 179
Foreign host: 11:11:12::2, Foreign port: 49010
Nexthop: 7.7.7.7
Nexthop global: 11:11:12::1
Nexthop local: fe80::5054:ff:fe8b:8f5c
BGP connection: shared network
Last Reset: 00:02:16, due to BGP Notification received
Notification Error Message: (OPEN Message Error/Bad BGP Identifier.)
```

IPv6 EBGP Configuration

Below figure displays the minimum configuration required to enable BGP on an interface. R1, R2 and R3 are three routers belonging to the different AS, AS100 AS200 and AS300, connecting to network 11:11:11::/64 and 11:11:12::/64. First, define the routing process and the AS number to which the routers belong. Then, define BGP neighbors to start exchanging routing updates.

Topology



Figure 1-14: IPv6 EBGP peering

R1

#configure terminal	Enter Configuration mode.
(config)#interface lo	Enter interface mode for loopback.
(config-if)#ipv6 address 33::1/128	Assign an IPv6 address.
(config-if)#exit	Exit interface mode.
(config)#interface xe1	Enter interface mode for xe1.
(config-if)#ipv6 address 11:11:11::1/64	Assign an IPv6 address to the interface.
(config-if)#exit	Exit interface mode.
(config)#router bgp 100	Enter Router BGP mode.
(config-router)#bgp router-id 1.1.1.1	Assign a BGP router ID.
(config-router)#neighbor 11:11:11::2 remote-as 200	Configure BGP neighbor by specifying the neighbor IP address.
(config-router)#address-family ipv6 unicast	Enter the IPv6 Unicast Address Family.
(config-router-af)#neighbor 11:11:11::2 activate	Activate the neighbor in the address family.
(config-router-af)#network 33::1/128	Advertise the loopback network into BGP.
(config-router-af)#exit-address-family	Exit address-family mode.
(config-router)#commit	Commit the candidate configuration to the running configuration.

R2

#configure terminal	Enter Configuration mode.
(config)#interface lo	Enter interface mode for loopback.
(config-if)#ipv6 address 22::1/128	Assign an IPv6 address.
(config-if)#exit	Exit interface mode.
(config)#interface xe1	Enter interface mode for xe1
(config-if)#ipv6 address 11:11:11::2/64	Assign an IPv6 address to the interface.
(config-if)#exit	Exit interface mode.
(config)#interface xe2	Enter interface mode for xe2.

(config-if)#ipv6 address 11:11:12::2/64	Assign an IPv6 address to the interface.
(config-if)#exit	Exit interface mode.
(config)#router bgp 200	Enter Router BGP mode.
(config-router)#bgp router-id 2.2.2.2	Assign a BGP router ID.
(config-router)#neighbor IPV6_EBGP_PEER peer-group range 11::1/16	Configure a dynamic peer group, IPV6_EBGP_PEER.
(config-router)#neighbor IPV6_EBGP_PEER remote-as 100	Configure remote AS with peer group, IPV6_EBGP_PEER.
(config-router)#neighbor IPV6_EBGP_PEER optional-as 300	Configure optional AS with peer group, IPV6_EBGP_PEER.
(config-router)#address-family ipv6 unicast	Enter IPv6 Unicast Address Family.
(config-router-af)#neighbor IPV6_EBGP_PEER activate	Activate peer group in the address family.
(config-router-af)#network 22::1/128	Advertise the loopback network into BGP.
(config-router-af)#exit-address-family	Exit address-family mode.
(config-router)#commit	Commit the candidate configuration to the running configuration.

R3

#Configure terminal	Enter Configuration mode.
(config)#interface lo	Enter interface mode for loopback.
(config-if)#ipv6 address 44::1/128	Assign an IPv6 address.
(config-if)#exit	Exit interface mode.
(config)#interface xe2	Enter interface mode for xe2
(config-if)#ipv6 address 11:11:12::3/64	Assign an IPv6 address.
(config-if)#exit	Exit interface mode.
(config)#router bgp 300	Enter Router BGP mode.
(config-router)#bgp router-id 3.3.3.3	Assign a BGP router ID.
(config-router)#neighbor 11:11:12::2 remote- as 200	Configure the BGP neighbor by specifying the neighbor IP address.
(config-router)#address-family ipv6 unicast	Enter the IPv6 Unicast Address Family.
(config-router-af)#neighbor 11:11:12::2 activate	Activate the neighbor in address family.
(config-router-af)#network 44::1/128	Advertise the loopback network into BGP.
(config-router-af)#exit-address-family	Exit address-family mode.
(config-router)#commit	Commit the candidate configuration to the running configuration.

Validation

R2

```
#show ipv6 bgp sum
```

```

BGP router identifier 2.2.2.2, local AS number 200
BGP table version is 5
3 BGP AS-PATH entries
0 BGP community entries

```

Neighbor Down State/PfxRcd	V	AS	MsgRcv	MsgSen	TblVer	InQ	OutQ	Up/
*11:11:11::1 00:01:28	4	100	9	11	5	0	0	
*11:11:12::3 00:01:14	4	300	6	6	5	0	0	

* Dynamically created based on a listen range command

```

BGP dynamic peer-group: IPV6_EBGP_PEER
listen range: 11::/16
Total number of dynamically created neighbors/limit: 2/(200)
Total number of dynamically created neighbors: 2
Total number of activated dynamic peer-groups for IPv6 Unicast address-family:
1
Total number of neighbors 2
Total number of Established sessions 2

```

```
#show running-config bgp
```

```

!
router bgp 200
  bgp router-id 2.2.2.2
  neighbor IPV6_EBGP_PEER peer-group range 11::/16
  neighbor IPV6_EBGP_PEER remote-as 100
  neighbor IPV6_EBGP_PEER optional-as 300
  !
  address-family ipv6 unicast
  network 22::1/128
  neighbor IPV6_EBGP_PEER activate
  exit-address-family
!

```

```
#show bgp ipv6 neighbors
```

```

BGP neighbor is 11:11:11::1, remote AS 100, local AS 200, external link
Member of peer-group IPV6_EBGP_PEER for session parameters
  BGP version 4, local router ID 2.2.2.2, remote router ID 1.1.1.1
  BGP state = Established, up for 00:02:15
  Last read 00:00:16, hold time is 90, keepalive interval is 30 seconds
  Neighbor capabilities:
    Route refresh: advertised and received (old and new)
    Address family IPv4 Unicast: advertised and received
    Address family IPv6 Unicast: advertised and received
  Received 11 messages, 0 notifications, 0 in queue
  Sent 12 messages, 1 notifications, 0 in queue
  Route refresh request: received 0, sent 0
  Minimum time between advertisement runs is 30 seconds
For address family: IPv4 Unicast
  BGP table version 1, neighbor version 1
  Index 0, Offset 0, Mask 0x1
  IPV6_EBGP_PEER peer-group member
  Community attribute sent to this neighbor (both)
  0 accepted prefixes

```

0 announced prefixes

For address family: IPv6 Unicast
BGP table version 5, neighbor version 5
Index 0, Offset 0, Mask 0x0
IPV6_EBGP_PEER peer-group member
Community attribute sent to this neighbor (both)
1 accepted prefixes
2 announced prefixes

Connections established 2; dropped 1
Local host: 11:11:11::2, Local port: 53043
Foreign host: 11:11:11::1, Foreign port: 179
Next hop: 2.2.2.2
Next hop global: 11:11:11::2
Next hop local: fe80::5054:ff:fe95:85ec
BGP connection: shared network
Last Reset: 00:02:20, due to BGP Notification sent
Notification Error Message: (Cease/Other Configuration Change.)

BGP neighbor is 11:11:12::3, remote AS 300, local AS 200, external link
Member of peer-group IPV6_EBGP_PEER for session parameters
BGP version 4, local router ID 2.2.2.2, remote router ID 3.3.3.3
BGP state = Established, up for 00:02:01
Last read 00:00:02, hold time is 90, keepalive interval is 30 seconds
Neighbor capabilities:
Route refresh: advertised and received (old and new)
Address family IPv4 Unicast: advertised and received
Address family IPv6 Unicast: advertised and received
Received 8 messages, 0 notifications, 0 in queue
Sent 8 messages, 0 notifications, 0 in queue
Route refresh request: received 0, sent 0
Minimum time between advertisement runs is 30 seconds
For address family: IPv4 Unicast
BGP table version 1, neighbor version 1
Index 0, Offset 0, Mask 0x1
IPV6_EBGP_PEER peer-group member
Community attribute sent to this neighbor (both)
0 accepted prefixes
0 announced prefixes

For address family: IPv6 Unicast
BGP table version 5, neighbor version 5
Index 0, Offset 0, Mask 0x0
IPV6_EBGP_PEER peer-group member
Community attribute sent to this neighbor (both)
1 accepted prefixes
2 announced prefixes

Connections established 1; dropped 0
Local host: 11:11:12::2, Local port: 47743
Foreign host: 11:11:12::3, Foreign port: 179
Next hop: 2.2.2.2
Next hop global: 11:11:12::2
Next hop local: fe80::5054:ff:fee5:b088
BGP connection: shared network

VPNv4 Configuration

Below mentioned topology displays bgp vpnv4 configuration on PE nodes, R1 and R3. IBGP peering will be formed on the loopback interface of R1 and R3; also IGP is running between all the routers.

Topology



Figure 1-15: IPv4 IBGP VPNv4 Configuration

R1

#Configure terminal	Enter Configuration mode.
(config)#ip vrf vrf1	Create a VRF, vrf1.
(config-vrf)#rd 100:1	Configure a route distinguisher value.
(config-vrf)#route-target export 100:1	Configure a route target export value to VRF.
(config-vrf)#route-target import 200:1	Configure a route target import value to VRF.
(config-vrf)#exit	Exit from VRF configuration mode.
(config)#router ldp	Enter Router LDP mode.
(config-router)#router-id 3.3.3.3	Configure an LDP router ID.
(config-router)#exit	Exit from Router LDP mode.
(config)#interface xe5	Enter Interface configuration mode.
(config-if)#ip vrf forwarding vrf1	Configure the interface to a VRF.
(config-if)#ip address 1.1.1.1/24	Assign an IP address to the interface.
(config-if)#exit	Exit from Interface configuration mode.
(config-if)#interface xe1	Enter another interface.
(config-if)#ip address 11.11.11.1/24	Assign an IP address to the interface.
(config-if)#label-switching	Enable label switching on interface.
(config-if)#enable-ldp ipv4	Enable IPv4 LDP configuration on interface.
(config-if)#exit	Exit from Interface configuration mode.
(config-if)#interface lo	Enter the loopback interface.
(config-if)#ip address 20.20.20.20/32 secondary	Assign a secondary IP address to the interface.
(config-router)#commit	Commit the candidate configuration to the running configuration.
(config-if)#exit	Exit from Interface Configuration mode.
(config)#router ospf 100	Enter Router OSPF mode.
(config-router)#network 11.11.11.0/24 area 0	Configure the interface on which OSPF runs, and associate the area ID.
(config-router)#network 20.20.20.20/32 area 0	Configure the interface on which OSPF runs, and associate the area ID.
(config-router)#exit	Exit from Router OSPF mode.
(config)#router ospf 200 vrf1	Create an OSPF process on VRF.

(config-router)#network 1.1.1.1/24 area 0	Configure the interface on which OSPF runs, and associate the area ID.
(config-router)#redistribute bgp	Redistribute BGP into OSPF.
(config-router)#exit	Exit from Router OSPF mode.
(config)#router bgp 100	Create a BGP process.
(config-router)#neighbor lo_peer peer-group range 30.30.30.30/32	Configure a dynamic peer group with the range command.
(config-router)#neighbor lo_peer remote-as 100	Configure remote AS to the peer group.
(config-router)#neighbor lo_peer update-source lo	Configure BGP neighbors to update the source routes.
(config-router)#address-family vpnv4 unicast	Enter the VPNv4 Address Family.
(config-router-af)#neighbor lo_peer activate	Activate the peer group in VPNv4 address family.
(config-router-af)#exit-address-family	Exit from VPNv4 address family.
(config-router)#address-family ipv4 vrf vrf1	Enter IPv4 VRF address family.
(config-router-af)#redistribute ospf 200	Redistribute OSPF into the IPv4 VRF address family.
(config-router-af)#exit-address-family	Exit address-family mode.
(config-router)#commit	Commit the candidate configuration to the running configuration.

R2

#Configure terminal	Enter Configuration mode.
(config)#router ldp	Enter Router LDP mode.
(config-router)#router-id 4.4.4.4	Configure an LDP router ID.
(config-router)#exit	Exit from Router LDP mode.
(config-if)#interface xe2	Enter Interface Configuration mode.
(config-if)#ip address 12.12.12.2/24	Assign an IP address to the interface.
(config-if)#label-switching	Enable label switching on the interface.
(config-if)#enable-ldp ipv4	Enable IPv4 LDP configuration on the interface.
(config-if)#exit	Exit from Interface configuration mode.
(config-if)#interface xe1	Enter another Interface.
(config-if)#ip address 11.11.11.2/24	Assign an IP address to the interface.
(config-if)#label-switching	Enable label switching on the interface.
(config-if)#enable-ldp ipv4	Enable IPv4 LDP configuration on the interface.
(config-if)#exit	Exit from Interface mode.
(config)#commit	Commit the candidate configuration to the running configuration.
(config)#router ospf 100	Create an OSPF process.
(config-router)#network 11.11.11.0/24 area 0	Define the interface on which OSPF runs, and associate the area ID
(config-router)#network 12.12.12.0/24 area 0	Define the interface on which OSPF runs, and associate the area ID

BGP

(config-router)#exit	Exit from Router BGP mode.
(config)#commit	Commit the candidate configuration to the running configuration.

R3

#Configure terminal	Enter Configuration mode.
(config)#router ldp	Enter Router LDP mode.
(config-router)#router-id 5.5.5.5	Configure an LDP router ID.
(config-router)#exit	Exit from Router LDP mode.
(config)#ip vrf vrf2	Create a VRF, vrf2.
(config-vrf)#rd 200:1	Configure a route distinguisher value.
(config-vrf)#route-target export 200:1	Configure a route target export value to VRF.
(config-vrf)#route-target import 100:1	Configure a route target import value to VRF.
(config-vrf)#exit	Exit from VRF configuration mode.
(config)#interface xe1	Enter Interface configuration mode.
(config-if)#ip vrf forwarding vrf2	Configure an interface to a VRF.
(config-if)#ip address 2.2.2.3/24	Assign an IP address to the interface.
(config-if)#exit	Exit from Interface configuration mode.
(config-if)#interface xe2	Enter another interface.
(config-if)#ip address 12.12.12.3/24	Assign an IP address to the interface.
(config-if)#label-switching	Enable label switching on interface.
(config-if)#enable-ldp ipv4	Enable IPv4 LDP configuration on the interface.
(config-if)#exit	Exit from Interface configuration mode.
(config-if)#interface lo	Enter loopback interface.
(config-if)#ip address 30.30.30.30/32 se	Assign a secondary IP address to the interface.
(config-if)#exit	Exit from Interface mode.
(config)#commit	Commit the candidate configuration to the running configuration.
(config)#router ospf 100	Enter Router OSPF mode.
(config-router)#network 12.12.12.0/24 area 0	Define the interface on which OSPF runs, and associate the area ID
(config-router)#network 30.30.30.30/32 area 0	Define the interface on which OSPF runs, and associate the area ID
(config-router)#exit	Exit from Router OSPF mode.
(config)#router ospf 200 vrf2	Create an OSPF process on VRF.
(config-router)#network 2.2.2.3/24 area 0	Define the interface on which OSPF runs, and associate the area ID.
(config-router)#redistribute bgp	Redistribute BGP into OSPF.
(config-router)#exit	Exit from Router OSPF mode.
(config)#commit	Commit the candidate configuration to the running configuration.
(config)#router bgp 100	Create a BGP process.

(config-router)#neighbor 20.20.20.20 remote-as 100	Configure BGP neighbor by specifying a neighbor IP address.
(config-router)#neighbor 20.20.20.20 update-source lo	Define the BGP neighbors to update the source routes.
(config-router)#address-family vpnv4 unicast	Enter VPNv4 Address Family.
(config-router-af)#neighbor 20.20.20.20 activate	Activate the neighbor in VPNv4 address family.
(config-router-af)#exit-address-family	Exit from VPNv4 address family.
(config-router)#address-family ipv4 vrf vrf2	Enter IPv4 VRF address family.
(config-router-af)#redistribute ospf 200	Redistribute OSPF into the IPv4 address family.
(config-router-af)#exit-address-family	Exit address-family mode.
(config-router)#commit	Commit the candidate configuration to the running configuration.

Validation

R1

```
#show running-config router bgp
router bgp 100
 neighbor lo_peer peer-group range 30.30.30.30/32
 neighbor lo_peer remote-as 100
 neighbor lo_peer update-source lo
 !
 address-family vpnv4 unicast
 neighbor lo_peer activate
 exit-address-family
 !
 address-family ipv4 vrf vrf1
 redistribute ospf 200
 exit-address-family
 !

#show ip bgp vpnv4 all summary
BGP router identifier 192.168.52.3, local AS number 100
BGP table version is 2
1 BGP AS-PATH entries
0 BGP community entries

Neighbor          V    AS    MsgRcv   MsgSen  TblVer   InQ   OutQ   Up/
Down    State/PfxRcd
*30.30.30.30      4    100     4         4         2     0     0
00:00:37                1
* Dynamically created based on a listen range command

BGP dynamic peer-group: lo_peer
 listen range: 30.30.30.30/32
 Total number of dynamically created neighbors/limit: 1/(200)

Total number of dynamically created neighbors: 1
Total number of activated dynamic peer-groups for VPNv4 Unicast address-
family: 1

Total number of neighbors 1
```

Total number of Established sessions 1

```
#show ip bgp vpnv4 all
```

```
Status codes: s suppressed, d damped, h history, * valid, > best, i -  
internal, l - labeled
```

```
          S Stale
```

```
Origin codes: i - IGP, e - EGP, ? - incomplete
```

Network	Next Hop	Metric	LocPrf	Weight	Path
Route Distinguisher: 100:1 (Default for VRF vrf1)					
*> 1.1.1.0/24	0.0.0.0	1	100	32768	?
*>i 2.2.2.0/24	30.30.30.30	1	100	0	?
Announced routes count = 1					
Accepted routes count = 1					
Route Distinguisher: 200:1					
*>i 2.2.2.0/24	30.30.30.30	1	100	0	?
Announced routes count = 0					
Accepted routes count = 1					

```
#show ip bgp vpnv4 all 1.1.1.0
```

```
Route Distinguisher: 100:1
```

```
Local
```

```
20.20.20.20 (metric 12) from 20.20.20.20 (192.178.50.2)
```

```
Origin incomplete, metric 1, localpref 100, label 24960, valid,  
internal, best
```

```
Extended Community: RT:100:1 0:0 OSPF-Route-type:0.0.0.0 :3:0
```

```
Last update: Tue Apr 23 10:29:10 2019
```

```
Route Distinguisher: 200:1 (Default for VRF vrf2)
```

```
Local
```

```
20.20.20.20 from 20.20.20.20 (192.178.50.2)
```

```
Origin incomplete, metric 1, localpref 100, label 24960, valid,  
internal, best
```

```
Extended Community: RT:100:1 0:0 OSPF-Route-type:0.0.0.0 :3:0
```

```
Last update: Tue Apr 23 10:29:10 2019
```

```
#show ip bgp peer-group
```

```
BGP dynamic peer-group is lo_peer, IBGP, remote AS 100
```

```
BGP dynamic peer-group lo_peer listen range group members:
```

```
30.30.30.30/32
```

```
BGP version 4
```

```
Minimum time between advertisement runs is 5 seconds
```

```
For address family: IPv4 Unicast
```

```
Peer-group member:
```

```
*30.30.30.30
```

```
Index 1, Offset 0, Mask 0x2
```

```
0 accepted prefixes, 0 announced prefixes
```

```
For address family: VPNv4 Unicast
```

```
Peer-group member:
```

```
*30.30.30.30
```

```

Index 0, Offset 0, Mask 0x0
1 accepted prefixes, 1 announced prefixes

```

R2

```

R2#show ip bgp vpnv4 all
Status codes: s suppressed, d damped, h history, * valid, > best, i - internal, l -
labeled
                S Stale
Origin codes: i - IGP, e - EGP, ? - incomplete

```

Network	Next Hop	Metric	LocPrf	Weight	Path
Route Distinguisher: 100:1 (Default for VRF vrf1)					
*> 1.1.1.0/24	0.0.0.0	1	100	32768	?
*>i 2.2.2.0/24	30.30.30.30	1	100	0	?
Announced routes count = 1					
Accepted routes count = 1					
Route Distinguisher: 200:1					
*>i 2.2.2.0/24	30.30.30.30	1	100	0	?
Announced routes count = 0					
Accepted routes count = 1					

```

R2#

```

R3

```

R3#show ip bgp vpnv4 all 1.1.1.0
Route Distinguisher: 100:1
  Local
    20.20.20.20 (metric 12) from 20.20.20.20 (192.178.50.2)
      Origin incomplete, metric 1, localpref 100, label 24960, valid, internal, best
      Extended Community: RT:100:1 0:0 OSPF-Route-type:0.0.0.0 :3:0

      Last update: Tue Apr 23 10:29:10 2019

Route Distinguisher: 200:1 (Default for VRF vrf2)
  Local
    20.20.20.20 from 20.20.20.20 (192.178.50.2)
      Origin incomplete, metric 1, localpref 100, label 24960, valid, internal, best
      Extended Community: RT:100:1 0:0 OSPF-Route-type:0.0.0.0 :3:0

      Last update: Tue Apr 23 10:29:10 2019

R3#

```

Enable eBGP Multihop

This example shows the minimum configuration required for enabling eBGP multihop on peers speaking BGP. eBGP multihop is used for routers that are not directly connected to each other. Typically, eBGP peers are directly connected, but if there is a requirement that necessitates this scenario, this configuration can be used.

Note: The IP addresses used in the configuration should be accessible through an IGP or static routing.

Topology

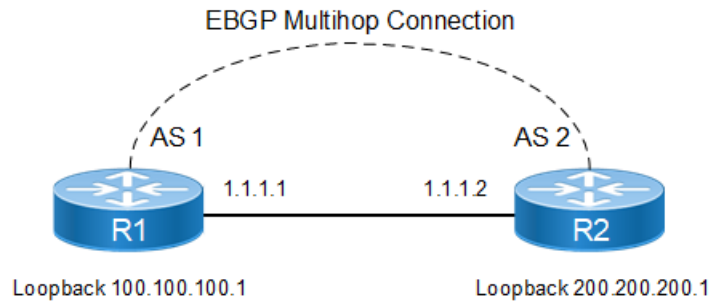

Figure 1-16: eBGP Multihop Connection

R1

#configure terminal	Enter configure mode.
(config)#interface lo	Enter loopback interface mode.
(config-if)#ip address 100.100.100.1/24 secondary	Specify IP address to the interface.
(config-if)#exit	Exit loopback interface mode.
(config)#ip route 200.200.200.0/24 1.1.1.2	Specify route IP address.
(config)#router bgp 1	Define the routing process. The number 1 specifies the AS number of R1.
(config-router)#neighbor 200.200.200.1 remote-as 2	Define BGP neighbors, and establish a TCP session. 200.200.200.1 is the IP address of the neighbor (R2), and 2 is the neighbor's AS number.
(config-router)#neighbor 200.200.200.1 update-source lo	Define BGP neighbors, to update the source routes.
(config-router)#neighbor 200.200.200.1 ebgp- multihop	Define the neighbor 200.200.200.1 for eBGP multihops.
(config-router)#address-family ipv4 unicast	Enter the Ipv4 Unicast Address Family.
(config-router-af)# neighbor 200.200.200.1 activate	Activate the neighbor under address family mode
(config-router-af)# exit-address-family	Exit address-family mode.
(config-router)#commit	Commit the candidate configuration to the running configuration.

R2

#configure terminal	Enter configure mode.
(config)#interface lo	Enter loopback interface mode.
(config-if)#ip address 200.200.200.1/24 secondary	Specify IP address to the interface.
(config-if)#exit	Exit loopback interface mode.
(config)#ip route 100.100.100.0/24 1.1.1.1	Specify route IP address.
(config)#router bgp 2	Define the routing process. The number 2 specifies the AS number of R1.

(config-router)#neighbor 100.100.100.1 remote-as 1	Define BGP neighbors, and establish a TCP session. 100.100.100.1 is the IP address of the neighbor (R2), and 1 is the neighbor's AS number.
(config-router)#neighbor 100.100.100.1 update-source lo	Define BGP neighbors, to update the source routes.
(config-router)#neighbor 100.100.100.1 ebgp- multihop	Define the neighbor 100.100.100.1 for eBGP multihops.
(config-router)#address-family ipv4 unicast	Config redistribute under address-family
(config-router-af)# neighbor 100.100.100.1 activate	Activate the neighbor under address family mode
(config-router-af)#redistribute static	Redistribute static route
(config-router-af)#exit-address-family	Exit address-family mode
(config-router)#commit	Commit the candidate configuration to the running configuration.

Validation

R1

```
#show ip bgp neighbors
BGP neighbor is 200.200.200.1, remote AS 2, local AS 1, external link
  BGP version 4, local router ID 192.168.52.2, remote router ID 192.168.52.3
  BGP state = Established, up for 00:00:22
  Last read 00:00:22, hold time is 90, keepalive interval is 30 seconds
  Neighbor capabilities:
    Route refresh: advertised and received (old and new)
    Address family IPv4 Unicast: advertised and received
  Received 2 messages, 0 notifications, 0 in queue
  Sent 3 messages, 0 notifications, 0 in queue
  Route refresh request: received 0, sent 0
  Minimum time between advertisement runs is 30 seconds
  Update source is lo
For address family: IPv4 Unicast
  BGP table version 1, neighbor version 1
  Index 1, Offset 0, Mask 0x2
  Community attribute sent to this neighbor (both)
  0 accepted prefixes
  0 announced prefixes

Connections established 1; dropped 0
  External BGP neighbor may be up to 255 hops away.
Local host: 100.100.100.1, Local port: 179
Foreign host: 200.200.200.1, Foreign port: 59458
Nexthop: 100.100.100.1
Nexthop global: ::
Nexthop local: ::
BGP connection: non shared network

#show ip bgp
```

BGP

BGP table version is 4, local router ID is 192.168.52.2
Status codes: s suppressed, d damped, h history, * valid, > best, i - internal,
l - labeled, S Stale
Origin codes: i - IGP, e - EGP, ? - incomplete

	Network	Next Hop	Metric	LocPrf	Weight	Path
*>	100.100.100.0/24	200.200.200.1	0	100	0	2 ?

Total number of prefixes 1

#show ip bgp neighbors

BGP neighbor is 200.200.200.1, remote AS 2, local AS 1, external link
BGP version 4, local router ID 192.168.52.2, remote router ID 192.168.52.3
BGP state = Established, up for 00:00:26
Last read 00:00:26, hold time is 90, keepalive interval is 30 seconds
Neighbor capabilities:
Route refresh: advertised and received (old and new)
Address family IPv4 Unicast: advertised and received
Received 5 messages, 0 notifications, 0 in queue
Sent 6 messages, 1 notifications, 0 in queue
Route refresh request: received 0, sent 0
Minimum time between advertisement runs is 30 seconds
Update source is lo
For address family: IPv4 Unicast
BGP table version 1, neighbor version 1
Index 1, Offset 0, Mask 0x2
Community attribute sent to this neighbor (both)
0 accepted prefixes
0 announced prefixes

Connections established 2; dropped 1

External BGP neighbor may be up to 255 hops away.

Local host: 100.100.100.1, Local port: 57260

Foreign host: 200.200.200.1, Foreign port: 179

Nexthop: 100.100.100.1

Nexthop global: ::

Nexthop local: ::

BGP connection: non shared network

Last Reset: 00:00:31, due to BGP Notification sent

Notification Error Message: (Cease/Administratively Reset.)

R2

#sh ip bgp neighbors

BGP neighbor is 100.100.100.1, remote AS 1, local AS 2, external link
BGP version 4, local router ID 192.168.52.3, remote router ID 192.168.52.2
BGP state = Established, up for 00:00:35
Last read 00:00:05, hold time is 90, keepalive interval is 30 seconds
Neighbor capabilities:

```

Route refresh: advertised and received (old and new)
Address family IPv4 Unicast: advertised and received
Received 6 messages, 1 notifications, 0 in queue
Sent 7 messages, 0 notifications, 0 in queue
Route refresh request: received 0, sent 0
Minimum time between advertisement runs is 30 seconds
Update source is lo
For address family: IPv4 Unicast
BGP table version 1, neighbor version 1
Index 1, Offset 0, Mask 0x2
Community attribute sent to this neighbor (both)
0 accepted prefixes
0 announced prefixes

Connections established 2; dropped 1
External BGP neighbor may be up to 255 hops away.
Local host: 200.200.200.1, Local port: 179
Foreign host: 100.100.100.1, Foreign port: 57260
Nexthop: 200.200.200.1
Nexthop global: ::
Nexthop local: ::
BGP connection: non shared network
Last Reset: 00:00:40, due to BGP Notification received
Notification Error Message: (Cease/Administratively Reset.)

```

```

#show ip bgp
BGP table version is 4, local router ID is 192.168.52.3
Status codes: s suppressed, d damped, h history, * valid, > best, i - internal,
               l - labeled, S Stale
Origin codes: i - IGP, e - EGP, ? - incomplete

```

Network	Next Hop	Metric	LocPrf	Weight	Path
*> 100.100.100.0/24	1.1.1.1	0	100	32768	?

```
Total number of prefixes 1
```

Enable Peer Groups

A BGP speaker might have the same update policies for a set of its peers. This is very useful if you have to change the update policies for all of the peers: Changing individual routers for separate policies can be very time-consuming, thus, peer groups play an important role in creating and assigning policies to a group of routers.

The peer group can be created dynamically or statically.

For dynamic peer groups all configuration can be done at group level only.

The static peer group configuration falls into two categories:

- Attributes that can be configured only at group level. Attempt to configure at member peer level will return error.
- Attributes that allow member peer level configuration. The member peer configuration has precedence.

Category A: Neighbor configuration allowed only at peer-group level

The outbound update impacting configurations of peer group will replace peer member configurations of same attributes when a peer becomes member of peer group. Outbound attribute modifications to group members are not allowed.

Following are the commands which are allowed at peer-group level.

- neighbor WORD activate - [neighbor activate](#)
- neighbor WORD as-origination-interval <1-65535> - [neighbor as-origination-interval](#)
- neighbor WORD attribute-unchanged ({as-path|next-hop|med|}) - [neighbor attribute-unchanged](#)
- neighbor WORD fall-over bfd - [neighbor extended-optional-param](#)
- neighbor WORD fall-over bfd multihop - [neighbor extended-optional-param](#)
- neighbor WORD next-hop-self - [neighbor next-hop-self](#)
- neighbor WORD remove-private-AS - [neighbor remove-private-AS](#)
- neighbor WORD route-reflector-client - [neighbor route-reflector-client](#)
- neighbor WORD route-server-client - [neighbor route-server-client](#)
- neighbor WORD send-community - [neighbor send-community](#)
- neighbor WORD distribute-list WORD out - [neighbor distribute-list](#)
- neighbor WORD dont-capability-negotiate - [neighbor dont-capability-negotiate](#)
- neighbor WORD capability orf prefix-list (both|receive|send) - [neighbor capability orf prefix-list](#)
- neighbor WORD filter-list WORD out - [neighbor filter-list](#)
- neighbor WORD prefix-list WORD out - [neighbor prefix-list](#)
- neighbor WORD route-map WORD out - [neighbor route-map](#)
- neighbor WORD advertisement-interval <1-65535> - [neighbor advertisement-interval](#)
- neighbor WORD disallow-infinite-holdtime - [neighbor disallow-infinite-holdtime](#)
- neighbor WORD local-as <1-4294967295> - [neighbor local-as](#)

Category: Neighbor configuration allowed at peer-group member level; precedence based

For the below configuration, member level configurations will take precedence over peer group configuration.

Following are the commands which are allowed at member level also.

- neighbor WORD authentication-key WORD - [neighbor authentication-key](#)
- neighbor WORD remote-as <1-4294967295> - [neighbor remote-as](#)
- neighbor WORD allowas-in <1-10> - [neighbor allowas-in](#)
- neighbor WORD description WORD - [neighbor description](#)
- neighbor WORD distribute-list WORD In - [neighbor distribute-list](#)
- neighbor WORD ebgp-multihop - [neighbor ebgp-multihop](#)
- neighbor WORD ebgp-multihop <1-255> - [neighbor ebgp-multihop](#)
- neighbor WORD maximum-prefix <1-4294967295> - [neighbor maximum-prefix](#)
- neighbor WORD update-source WORD - [neighbor update-source](#)
- neighbor WORD weight <0-65535> - [neighbor weight](#)
- neighbor WORD shutdown - [neighbor shutdown](#)

- neighbor WORD strict-capability-match - [neighbor strict-capability-match](#)
- neighbor WORD route-map WORD in - [neighbor route-map](#)
- neighbor WORD prefix-list WORD in - [neighbor prefix-list](#)
- neighbor WORD passive - [neighbor passive](#)
- neighbor WORD override-capability - [neighbor override-capability](#)
- neighbor WORD filter-list WORD in - [neighbor filter-list](#)
- neighbor WORD enforce-multihop - [neighbor enforce-multihop](#)
- neighbor WORD collide-established - [neighbor collide-established](#)

BGP Peer Groups for Address-Family IPv4 Unicast

In the following scenario, R1, R2, and R3 belong to the same peer group ABC. R1, R2 and R3 are in AS 200 and R1 is the route reflector. R4 and R1 are eBGP peers. R4 is in AS 100.

Topology

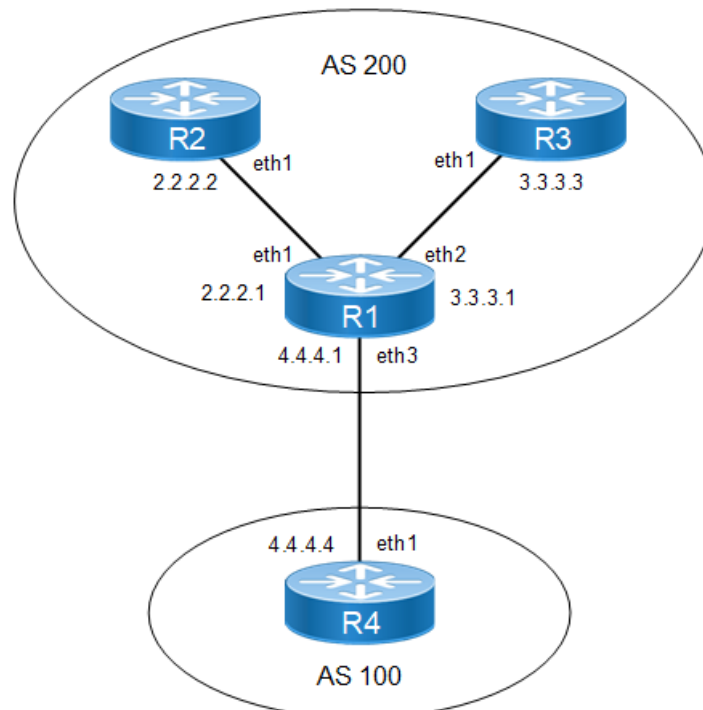

Figure 1-17: BGP Peer Groups with IPv4 Unicast Members

R1

#configure terminal	Enter configure mode.
(config)#router bgp 200	Define the routing process. The number 200 specifies the AS number of R2.
(config-router)#neighbor ABC peer-group	Configuring ABC peer-group
(config-router)#neighbor ABC remote-as 200	Assign options to the peer group named ABC.

BGP

(config-router)#neighbor 2.2.2.2 peer-group ABC	Define neighbor 2.2.2.2 (R2) as a peer group member.
(config-router)#neighbor 3.3.3.3 peer-group ABC	Define neighbor 3.3.3.3 (R3) as a peer group member.
(config-router)#neighbor 4.4.4.4 remote-as 100	Define neighbor 4.4.4.4 (R4) is the IP address of R4 and 100 is the AS number.
(config-router)#address-family ipv4 unicast	Enter address-family ipv4 unicast mode
(config-router-af)# neighbor ABC activate	Activate neighbor under address family mode
(config-router-af)# neighbor 4.4.4.4 activate	Activate neighbor under address family mode
(config-router-af)# neighbor ABC route-reflector-client	Configure the peer-group ABC to be route-reflector-client
(config-router-af)#network 1.1.1.1/32	Advertise the network 1.1.1.1/32
(config-router-af)#network 11.11.11.11/32	Advertise the network 11.11.11.11/32
(config-router-af)#exit-address-family	Exit address family mode
(config-router)#commit	Commit the candidate configuration to the running configuration.

R2

#configure terminal	Enter configure mode.
(config)#router bgp 200	Define the routing process. The number 200 specifies the AS number of R2.
(config-router)#neighbor 2.2.2.1 remote-as 200	Create a TCP connection with neighbor 2.2.2.1 of AS 200.
(config-router)#address-family ipv4 unicast	Enter address-family ipv4 unicast mode
(config-router-af)# neighbor 2.2.2.1 activate	Activate neighbor under address family mode
(config-router-af)#exit-address-family	Exit address family mode
(config-router)#commit	Commit the candidate configuration to the running configuration.

R3

#configure terminal	Enter configure mode.
(config)#router bgp 200	Define the routing process. The number 200 specifies the AS number of R3.
(config-router)#neighbor 3.3.3.1 remote-as 200	Create a TCP connection with neighbor 3.3.3.1 of AS 200.
(config-router)#address-family ipv4 unicast	Enter address-family ipv4 unicast mode
(config-router-af)# neighbor 3.3.3.1 activate	Activate neighbor under address family mode
(config-router-af)#exit-address-family	Exit address family mode
(config-router)#commit	Commit the candidate configuration to the running configuration.

R4

#configure terminal	Enter configure mode.
(config)#router bgp 100	Define the routing process. The number 100 specifies the AS number of R4.
(config-router)#neighbor 4.4.4.1 remote-as 200	Create a TCP connection with neighbor 4.4.4.1 of AS 200.
(config-router)#address-family ipv4 unicast	Enter address-family ipv4 unicast mode
(config-router-af)# neighbor 4.4.4.1 activate	Activate neighbor under address family mode
(config-router-af)#exit-address-family	Exit address family mode
(config-router)#commit	Commit the candidate configuration to the running configuration.

Validation**R1**

```

R1#show ip bgp neighbors
BGP neighbor is 2.2.2.2, remote AS 200, local AS 200, internal link
Member of peer-group ABC for session parameters
  BGP version 4, local router ID 192.168.52.2, remote router ID 10.12.7.155
  BGP state = Established, up for 00:04:55
  Last read 00:04:55, hold time is 90, keepalive interval is 30 seconds
Neighbor capabilities:
  Route refresh: advertised and received (old and new)
  Address family IPv4 Unicast: advertised and received
Received 11 messages, 0 notifications, 0 in queue
Sent 11 messages, 0 notifications, 0 in queue
Route refresh request: received 0, sent 0
Minimum time between advertisement runs is 5 seconds
For address family: IPv4 Unicast
BGP table version 1, neighbor version 1
Index 1, Offset 0, Mask 0x2
ABC peer-group member
Route-Reflector Client
Community attribute sent to this neighbor (both)
  0 accepted prefixes
  2 announced prefixes
Connections established 1; dropped 0
Local host: 2.2.2.1, Local port: 33865
Foreign host: 2.2.2.2, Foreign port: 179
Nexthop: 2.2.2.1
Nexthop global: 1111::1
Nexthop local: fe80::a00:27ff:fecc:47a6
BGP connection: non shared network

BGP neighbor is 3.3.3.3, remote AS 200, local AS 200, internal link
Member of peer-group ABC for session parameters
  BGP version 4, local router ID 192.168.52.2, remote router ID 10.12.7.153
  BGP state = Established, up for 00:04:55
  Last read 00:04:55, hold time is 90, keepalive interval is 30 seconds
Neighbor capabilities:

```

```

Route refresh: advertised and received (old and new)
Address family IPv4 Unicast: advertised and received
Received 11 messages, 0 notifications, 0 in queue
Sent 11 messages, 0 notifications, 0 in queue
Route refresh request: received 0, sent 0
Minimum time between advertisement runs is 5 seconds
For address family: IPv4 Unicast
BGP table version 1, neighbor version 1
Index 2, Offset 0, Mask 0x4
ABC peer-group member
Route-Reflector Client
Community attribute sent to this neighbor (both)
0 accepted prefixes
2 announced prefixes
Connections established 1; dropped 0
Local host: 3.3.3.1, Local port: 44280
Foreign host: 3.3.3.3, Foreign port: 179
NextHop: 3.3.3.1
NextHop global: fe80::a00:27ff:fe85:25d4
NextHop local: ::
BGP connection: non shared network

BGP neighbor is 4.4.4.4, remote AS 100, local AS 200, external link
BGP version 4, remote router ID 10.12.7.120
BGP state = Established, up for 00:04:55
Last read 00:04:55, hold time is 90, keepalive interval is 30 seconds
Neighbor capabilities:
Route refresh: advertised and received (old and new)
Address family IPv4 Unicast: advertised and received
Received 11 messages, 0 notifications, 0 in queue
Sent 11 messages, 0 notifications, 0 in queue
Route refresh request: received 0, sent 0
Minimum time between advertisement runs is 30 seconds
For address family: IPv4 Unicast
BGP table version 1, neighbor version 1
Index 3, Offset 0, Mask 0x8
Community attribute sent to this neighbor (both)
0 accepted prefixes
2 announced prefixes
Connections established 1; dropped 0
Local host: 4.4.4.1, Local port: 55493
Foreign host: 4.4.4.4, Foreign port: 179 NextHop: 4.4.4.1
NextHop global: fe80::a00:27ff:fe7e:674a
NextHop local: ::
BGP connection: non shared network

R1#show ip bgp summary
BGP router identifier 192.168.52.2, local AS number 200
BGP table version is 1
0 BGP AS-PATH entries
0 BGP community entries
Neighbor          V    AS    MsgRcv   MsgSen  TblVer   InQ   OutQ   Up/
Down  State/PfxRcd
2.2.2.2          4    200    12       12      1        0     0
00:05:02        0
3.3.3.3          4    200    12       12      1        0     0
00:05:02        0

```

```

4.4.4.4          4   100   12          12          1          0          0
00:05:02          0
Total number of neighbors 3
Total number of Established sessions 3

```

R2

```

R2#show ip bgp
BGP table version is 4, local router ID is 10.12.65.123
Status codes: s suppressed, d damped, h history, * valid, > best, i -
internal,
                l - labeled, S Stale
Origin codes: i - IGP, e - EGP, ? - incomplete

   Network          Next Hop          Metric      LocPrf      Weight Path
*>i  1.1.1.1/32       2.2.2.1           0           100         0          i
*>i  11.11.11.11/32  2.2.2.1           0           100         0          i

Total number of prefixes 2
R2#

```

R3

```

R3#show ip bgp
BGP table version is 8, local router ID is 10.12.65.121
Status codes: s suppressed, d damped, h history, * valid, > best, i -
internal,
                l - labeled, S Stale
Origin codes: i - IGP, e - EGP, ? - incomplete

   Network          Next Hop          Metric      LocPrf      Weight Path
*>i  1.1.1.1/32       3.3.3.1           0           100         0          i
*>i  11.11.11.11/32  3.3.3.1           0           100         0          i

Total number of prefixes 2
R3#

```

Peer-group can have either iBGP or eBGP peers but not both.**Validation**

The configuration above fails with an appropriate error:

```

R1(config)#router bgp 200
R1(config-router)#neighbor 4.4.4.4 peer-group ABC
%% Peer with AS 100 cannot be in this peer-group, members must be all internal
or all external
R1(config-router)#

```

Peer group members inherit the properties of Outbound Policies configured for Peer-group.**R1**

#configure terminal	Enter configure mode.
(config)# ip access-list permit-1	Configure access-list to permit 1.1.1.1/32
(config-ip-acl)# permit any 1.1.1.1/32 any	Configure a permit statement in the acl to permit 1.1.1.1/32

BGP

(config-ip-acl)#exit	Exit ip access-list mode
(config)# route-map permit-only-1	Configure route-map
(config-route-map)# match ip address permit-1	Configure a match statement in the route-map to match the access-list permit-1
(config-route-map)#set local-preference 250	Set local preference as 250
(config-route-map)#exit	Exit route-map mode
(config)#router bgp 200	Define the routing process. The number 200 specifies the AS number of R1.
(config-router)# address-family ipv4 unicast	Enter address-family ipv4 unicast mode
(config-router-af)# neighbor ABC route-map permit-only-1 out	Configure the peer-group ABC with route-map in the outbound direction
(config-router-af)#exit	Exit router BGP mode
(config-router)#exit	Exit router mode.
(config)#commit	Commit the candidate configuration to the running configuration.
(config)# exit	Exit configure terminal mode
#clear ip bgp peer-group ABC soft out	Do outbound soft reset for the peer-group ABC for the policy to take affect for the peer-group members

Validation

R1

```
R1#show bgp neighbors 2.2.2.2
BGP neighbor is 2.2.2.2, remote AS 200, local AS 200, internal link
Member of peer-group ABC for session parameters
  BGP version 4, local router ID 10.12.65.126, remote router ID 10.12.65.123
  BGP state = Established, up for 00:07:01
  Last read 00:00:15, hold time is 90, keepalive interval is 30 seconds
  Neighbor capabilities:
    Route refresh: advertised and received (old and new)
    Address family IPv4 Unicast: advertised and received
  Received 20 messages, 0 notifications, 0 in queue
  Sent 28 messages, 1 notifications, 0 in queue
  Route refresh request: received 0, sent 0
  Minimum time between advertisement runs is 5 seconds
For address family: IPv4 Unicast
  BGP table version 1, neighbor version 1
  Index 1, Offset 0, Mask 0x2
  ABC peer-group member
  Route-Reflector Client
  Community attribute sent to this neighbor (both)
  Outbound path policy configured
  Route map for outgoing advertisements is *permit-only-1
  0 accepted prefixes
  1 announced prefixes

Connections established 2; dropped 1
Local host: 2.2.2.1, Local port: 179
Foreign host: 2.2.2.2, Foreign port: 42657
Next hop: 2.2.2.1
```

```

Nexthop global: ::
Nexthop local: ::
BGP connection: non shared network
Last Reset: 00:08:39, due to Hold Timer Expired (Notification sent)
Notification Error Message: (Hold Timer Expired/No sub-error code)

R1#show bgp neighbors 3.3.3.3
BGP neighbor is 3.3.3.3, remote AS 200, local AS 200, internal link
Member of peer-group ABC for session parameters
  BGP version 4, local router ID 10.12.65.126, remote router ID 10.12.65.121
  BGP state = Established, up for 00:11:46
  Last read 00:00:18, hold time is 90, keepalive interval is 30 seconds
Neighbor capabilities:
  Route refresh: advertised and received (old and new)
  Address family IPv4 Unicast: advertised and received
  Received 29 messages, 0 notifications, 0 in queue
  Sent 32 messages, 0 notifications, 0 in queue
  Route refresh request: received 0, sent 0
  Minimum time between advertisement runs is 5 seconds
For address family: IPv4 Unicast
  BGP table version 1, neighbor version 1
  Index 2, Offset 0, Mask 0x4
  ABC peer-group member
  Route-Reflector Client
  Community attribute sent to this neighbor (both)
  Outbound path policy configured
  Route map for outgoing advertisements is *permit-only-1
  0 accepted prefixes
  1 announced prefixes

Connections established 1; dropped 0
Local host: 3.3.3.1, Local port: 179
Foreign host: 3.3.3.3, Foreign port: 48008
Nexthop: 3.3.3.1
Nexthop global: ::
Nexthop local: ::
BGP connection: non shared network

```

R2

```

R2#show ip bgp
BGP table version is 3, local router ID is 10.12.65.123
Status codes: s suppressed, d damped, h history, * valid, > best, i -
internal,
                l - labeled, S Stale
Origin codes: i - IGP, e - EGP, ? - incomplete

   Network          Next Hop           Metric      LocPrf        Weight Path
*>i  1.1.1.1/32       2.2.2.1             0           250           0           i

Total number of prefixes 1

```

R3

```

R3#show ip bgp
BGP table version is 7, local router ID is 10.12.65.121
Status codes: s suppressed, d damped, h history, * valid, > best, i -
internal,
                l - labeled, S Stale

```

BGP

Origin codes: i - IGP, e - EGP, ? - incomplete

Network	Next Hop	Metric	LocPrf	Weight	Path
*>i 1.1.1.1/32	3.3.3.1	0	250	0	i

Total number of prefixes 1

Peer-group-members cannot be configured with Outbound Policies.

Validation

The above configuration fails with an appropriate error:

```
R1(config)#router bgp 200
R1(config)#address-family ipv4 unicast
R1(config-router-af)#neighbor 2.2.2.2 route-map permit-only-11 out
%% Invalid command for a peer-group member
```

Peer-group-members inherit the properties of Inbound Policies configured for Peer-group.

R2

#configure terminal	Enter configure mode.
(config)# interface lo	Enter interface mode for Loopback interface
(config-if)#ip address 100.1.1.1/24 secondary	Configure IP address for Loopback interface
(config-if)#interface eth3	Enter interface mode for interface eth3
(config-if)#ip address 22.1.1.1/24	Configure IP address for interface eth3
(config-if)#exit	Exit interface mode
(config)#router bgp 200	Enter router bgp mode
(config-router)#address-family ipv4 unicast	Enter address-family ipv4 unicast mode
(config-router-af)#network 22.1.1.0/24	Advertise the network of eth3 in BGP
(config-router-af)#network 100.1.1.0/24	Advertise the network of Loopback in BGP
(config-router-af)#exit-address-family	Exit address family mode.
(config-router)#commit	Commit the candidate configuration to the running configuration.

R3

#configure terminal	Enter configure mode.
(config)# interface lo	Enter interface mode for Loopback interface
(config-if)#ip address 100.1.1.2/24 secondary	Configure IP address for Loopback interface
(config-if)#interface eth3	Enter interface mode for interface eth3
(config-if)#ip address 22.1.1.2/24	Configure IP address for interface eth3
(config-if)#exit	Exit interface mode
(config)#router bgp 200	Enter router bgp mode
(config-router)#address-family ipv4 unicast	Enter address-family ipv4 unicast mode

(config-router-af)#network 22.1.1.0/24	Advertise the network of eth3 in BGP
(config-router-af)#network 100.1.1.0/24	Advertise the network of Loopback in BGP
(config-router-af)#exit-address-family	Exit address family mode.
(config-router)#commit	Commit the candidate configuration to the running configuration.

R1

#configure terminal	Enter configure mode.
(config)#ip access-list permit-22	Configure access-list to permit 22.1.1.0/24
(config-ip-acl)# permit any 22.1.1.0/24 any	Configure a permit statement to permit 22.1.1.0/24
(config-ip-acl)#exit	Exit ip access-list mode
(config)#route-map permit-only-22	Configure route-map
(config-route-map)#match ip address permit-22	Configure match statement in route-map to match the access-list permit-22
(config-route-map)#exit	Exit route-map mode
(config)#router bgp 200	Enter BGP router mode
(config)# address-family ipv4 unicast	Enter address-family ipv4 unicast mode
(config-router-af)# neighbor ABC activate	Activate peer-group in the address family
(config-router-af)#neighbor ABC route-map permit-only-22 in	Configure the peer-group ABC with route-map in the inbound direction
(config-router)#exit	Exit router bgp mode
(config)#commit	Commit the candidate configuration to the running configuration.
(config)# exit	Exit configure terminal mode
#clear ip bgp peer-group ABC soft in	Do inbound soft reset for the peer-group ABC for the policy to take affect for the peer-group members

Validation**R1**

```
R1#show ip bgp
```

```
BGP table version is 7, local router ID is 1.1.1.1
Status codes: s suppressed, d damped, h history, a add-path, g group-best, *
valid, > best, i - internal, l - labeled
                S Stale
Origin codes: i - IGP, e - EGP, ? - incomplete
```

Weight	Network Path	Next Hop	Metric	LocPrf	
*>	1.1.1.1/32	0.0.0.0	0	100	32768
i					
*>	11.11.11.11/32	0.0.0.0	0	100	32768
i					
*>i	22.1.1.0/24	2.2.2.2	0	100	0
i					
* i		3.3.3.3	0	100	0
i					

Total number of prefixes 3

Peer group members can be configured with Inbound Policies

R1

#configure terminal	Enter configure mode.
(config)#ip access-list permit-100	Configure access-list to permit 100.1.1.0/24
(config-ip-acl)# permit any 100.1.1.0/24 any	Configure a permit statement to permit 100.1.1.0/24
(config-ip-acl)#exit	Exit ip access-list mode
(config)#route-map permit-only-100	Configure route-map
(config-route-map)#match ip address permit-100	Configure match statement in route-map to match the access-list permit-100
(config-route-map)#exit	Exit route-map mode
(config)#router bgp 200	Enter BGP router mode
(config)# address-family ipv4 unicast	Enter address-family ipv4 unicast mode
(config-router-af)# neighbor 2.2.2.2 activate	Activate neighbor in the address family
(config-router-af)#neighbor 2.2.2.2 route-map permit-only-100 in	Configure the peer-group-member R2(2.2.2.2) with route-map in the inbound direction
(config-router-af)#exit	Exit address-family mode
(config-router)#exit	Exit router bgp mode
(config-router)#commit	Commit the candidate configuration to the running configuration.
(config)# exit	Exit configure terminal mode
#clear ip bgp peer-group ABC soft in	Do inbound soft reset for the peer-group ABC for the policy to take affect for the peer-group members

Validation

R1

```
R1#show ip bgp
BGP table version is 4, local router ID is 10.12.65.126
Status codes: s suppressed, d damped, h history, * valid, > best, i -
internal,
                l - labeled, S Stale
Origin codes: i - IGP, e - EGP, ? - incomplete
```

	Network	Next Hop	Metric	LocPrf	Weight	Path
*>	1.1.1.1/32	0.0.0.0	0	100	32768	i
*>	11.11.11.11/32	0.0.0.0	0	100	32768	i
*>i	22.1.1.0/24	3.3.3.3	0	100	0	i
*>i	100.1.1.0/24	2.2.2.2	0	100	0	i

```
Total number of prefixes 4
R1#
```

Route Redistribution in BGP

If there are routers that run both OSPF and BGP, certain OSPF routes might have to be sent to other eBGP peers. This can be achieved using the redistribution feature. Consider the following topology, in which R1 and R2 are eBGP peers, and R2 and R3 are OSPF peers. R2 is redistributing OSPF routes into BGP. The OSPF routes are sent to the R1 BGP routing table. This configuration assumes that all OSPF and eBGP sessions are up and running, and that only the redistribution must be configured.

Topology

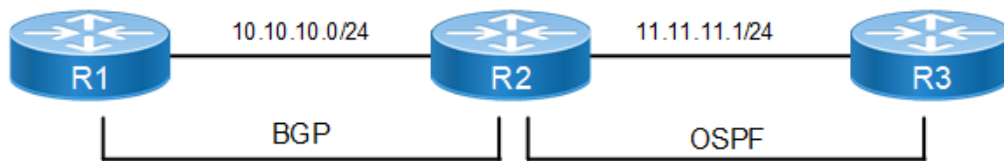

Figure 1-18: Redistribute with OSPF

R2

#configure terminal	Enter configure mode.
(config)#router bgp 100	Define the routing process. The number 100 specifies the AS number of R2.
(config-router)# address-family ipv4 unicast	Enter address-family ipv4 unicast mode
(config-router-af)# redistribute ospf	Redistribute OSPF routes in the R2 routing table into the R1 BGP routing table.
(config-router-af)# exit-address-family	Exit address-family mode.
(config-router)#commit	Commit the candidate configuration to the running configuration.

Validation

```
#show ip bgp
BGP table version is 3, local router ID is 192.168.52.2
Status codes: s suppressed, d damped, h history, * valid, > best, i -
internal,
                l - labeled, S Stale
Origin codes: i - IGP, e - EGP, ? - incomplete

   Network        Next Hop         Metric      LocPrf     Weight Path
*>  3.3.3.3/32     10.10.10.2        11           100         0   100
?
*>  11.11.11.0/24  10.10.10.2         1           100         0   100
?

Total number of prefixes 2
```

Add Multiple Instances of the Same Autonomous System

BGP supports adding the same AS number multiple times to influence the route selection process. This can be done using route maps, as described below.

Under normal circumstances, any route advertised by R1 is sent to R4 via two different routes, and then R4 selects the path from R2. This decision can be influenced by adding multiple instances of AS number 200 at R2.

Topology

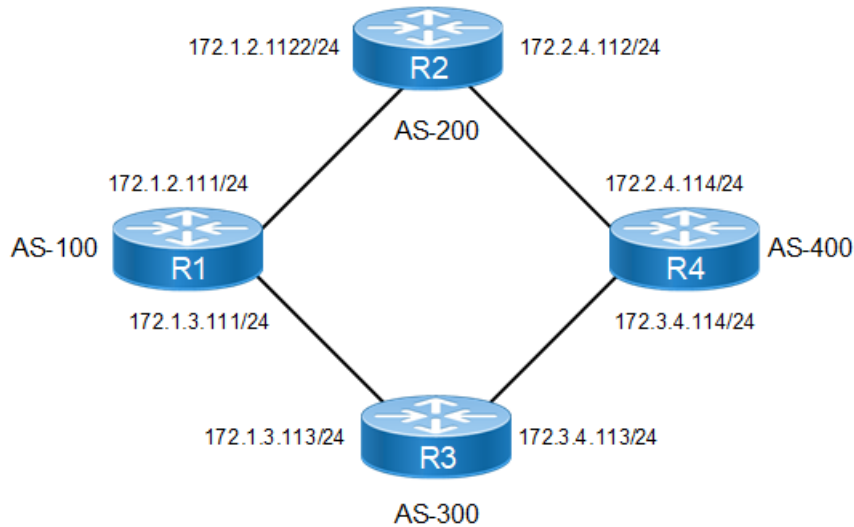

Figure 1-19: Multiple Instances of Same AS

R1

#configure terminal	Enter configure mode.
(config)#interface lo	Enter loopback interface mode.
(config-if)#ip address 44.44.44.1/24 secondary	Specify the IP address for the interface.
(config-if)#exit	Exit loopback interface mode.
(config)#router bgp 100	Define the routing process with AS number 100.
(config-router)#neighbor 172.1.2.112 remote-as 200	Define neighbor R2. 172.1.2.112 is the IP address of R2, and 200 is the AS number.
(config-router)#neighbor 172.1.3.113 remote-as 300	Define neighbor R3. 172.1.3.113 is the IP address of R2, and 300 is the AS number.
(config-router)#address-family ipv4 unicast	Enter address-family ipv4 unicast mode
(config-router-af)# neighbor 172.1.2.112 activate	Activate neighbor under address family mode
(config-router-af)# neighbor 172.1.2.113 activate	Activate neighbor under address family mode

(config-router-af)#network 44.44.44.0/24	Advertise network 44.44.44.0/24 through BGP. This route reaches R4 via R2 and R3.
(config-router-af)# exit-address-family	Exit address-family mode.
(config-router)#commit	Commit the candidate configuration to the running configuration.

R2

#configure terminal	Enter configure mode.
(config)#route-map mul_inst permit 10	Define the route-map multiple instance with permit definition sequence number 10.
(config-route-map)#set as-path prepend 200 200	Prepend AS number 200 two times to the AS_PATH attribute in the BGP Update message.
(config-route-map)#exit	Exit Route-map mode, and return to Configure mode.
(config)#router bgp 200	Define the routing process with AS number 200.
(config-router)#neighbor 172.1.2.111 remote-as 100	Define neighbor R1. 172.1.2.111 is the IP address of R1, and 100 is the AS number.
(config-router)#neighbor 172.2.4.114 remote-as 400	Define neighbor R4. 172.2.4.114 is the IP address of R2, and 400 is the AS number.
(config-router)#address-family ipv4 unicast	Enter address-family ipv4 unicast mode
(config-router-af)# neighbor 172.2.4.114 activate	Activate neighbor under address family mode
(config-router-af)# neighbor 172.1.2.111 activate	Activate neighbor under address family mode
(config-router-af)#neighbor 172.2.4.114 route-map mul_inst out	Apply route-map multi_inst to all outbound routes to R4
(config-router-af)# exit-address-family	Exit address-family mode.
(config-router)#commit	Commit the candidate configuration to the running configuration.

R3

#configure terminal	Enter configure mode.
(config)#router bgp 300	Define the routing process with AS number 300.
(config-router)#neighbor 172.1.3.111 remote-as 100	Define neighbor R1. 172.1.3.111 is the IP address of R1, and 100 is the AS number.
(config-router)#neighbor 172.3.4.114 remote-as 400	Define neighbor R4. 172.3.4.114 is the IP address of R4, and 400 is the AS number.
(config-router)#address-family ipv4 unicast	Enter address-family ipv4 unicast mode
(config-router-af)# neighbor 172.3.4.114 activate	Activate neighbor under address family mode
(config-router-af)# neighbor 172.1.3.111 activate	Activate neighbor under address family mode
(config-router-af)# exit-address-family	Exit address-family mode.
(config-router)#commit	Commit the candidate configuration to the running configuration.

R4

#configure terminal	Enter configure mode.
(config)#router bgp 400	Define the routing process with AS number 400.
(config-router)#neighbor 172.2.4.112 remote-as 200	Define neighbor R2. 172.2.4.112 is the IP address of R2, and 200 is the AS number.
(config-router)#neighbor 172.3.4.113 remote-as 300	Define neighbor R3. 172.3.4.113 is the IP address of R3, and 300 is the AS number.
(config-router)#address-family ipv4 unicast	Enter address-family ipv4 unicast mode
(config-router-af)# neighbor 172.2.4.112 activate	Activate neighbor under address family mode
(config-router-af)# neighbor 172.3.4.113 activate	Activate neighbor under address family mode
(config-router-af)# exit-address-family	Exit address-family mode.
(config-router)#commit	Commit the candidate configuration to the running configuration.

Validation

```
#show ip bgp
BGP table version is 1, local router ID is 44.44.44.1
Status codes: s suppressed, d damped, h history, * valid, > best, i -
internal, l - labeled, S Stale
Origin codes: i - IGP, e - EGP, ? - incomplete

Network Next Hop Metric LocPrf Weight Path
*> 44.44.44.0/24 0.0.0.0 0 100 32768 i

Total number of prefixes 1
```

Remove the Multi-Exit Disc Attribute from Update Messages

You can remove the Multi-Exit Disc (MED) attribute values from received update messages.

Topology

Figure 1-20: Remove MED Attribute

R1

#configure terminal	Enter configure mode.
(config)#route-map med permit 1	Define the route-map MED with permit definition sequence number 1.

(config-route-map)#set metric 400	Set the metric value.
(config-route-map)#exit	Exit Route-map mode, and return to Configure mode.
(config)#router bgp 100	Define the routing process with AS number 100.
(config-router)#neighbor 1.1.1.2 remote-as 200	Define neighbor R2. 1.1.1.2 is the IP address of R2, and 200 is the AS number.
(config-router)# address-family ipv4 unicast	Enter address-family ipv4 unicast mode
(config-router-af)# neighbor 1.1.1.2 activate	Activate neighbor under address family mode
(config-router-af)# exit-address-family	Exit address family mode
(config-router)#exit	Exit router BGP mode
(config)#interface xe2	Enter interface mode
(config-if)#ip ad 10.10.10.1/24	Assign IP address
(config-if)#no shutdown	Make interface administratively up
(config-router)#commit	Commit the candidate configuration to the running configuration.
(config-if)#exit	Exit interface mode
(config)#ip route 100.0.0.0/8 10.10.10.2	Configure the static route with the nexthop address.
(config-router)#commit	Commit the candidate configuration to the running configuration.

R3

#configure terminal	Enter configure mode.
(config)#router bgp 200	Define the routing process with AS number 200.
(config-router)#neighbor 2.2.2.1 remote-as 200	Define neighbor R2. 2.2.2.1 is the IP address of R2, and 200 is the AS number.
(config-router)# address-family ipv4 unicast	Enter address-family ipv4 unicast mode
(config-router-af)# neighbor 2.2.2.1 activate	Activate neighbor under address family mode
(config-router-af)# exit-address-family	Exit address family mode
(config-router)#commit	Commit the candidate configuration to the running configuration.

Removing Sent and Received MED values

The following describes how to remove the received and sent MED values, respectively.

R2 - Remove Received MED Value

#configure terminal	Enter configure mode.
(config)#router bgp 200	Define the routing process with AS number 200.
(config-router)#neighbor 1.1.1.1 remote-as 100	Define neighbor R1. 1.1.1.1 is the IP address of R1, and 100 is the AS number.
(config-router)#neighbor 2.2.2.2 remote-as 200	Define neighbor R3. 2.2.2.2 is the IP address of R3, and 200 is the AS number.

BGP

(config-router)#bgp bestpath med remove-recv- med	Enable the remove received MED value option.
(config-router)# address-family ipv4 unicast	Enter address-family ipv4 unicast mode
(config-router-af)# neighbor 1.1.1.1 activate	Activate neighbor under address family mode
(config-router-af)# neighbor 2.2.2.2 activate	Activate neighbor under address family mode
(config-router-af)# exit-address-family	Exit address family mode
(config-router)#commit	Commit the candidate configuration to the running configuration.

R1 - Add Static Route

(config)#router bgp 100	Enter to router bgp mode
(config)#address-family ipv4 unicast	Config redistribute under address-family
(config-router-af)#redistribute static	Redistribute the static routes
(config-router)#commit	Commit the candidate configuration to the running configuration.

R2 - Remove Send MED Value

#configure terminal	Enter configure mode.
(config)#router bgp 200	Define the routing process with AS number 200.
(config-router)#neighbor 1.1.1.1 remote-as 100	Define neighbor R1. 1.1.1.1 is the IP address of R1, and 100 is the AS number.
(config-router)#neighbor 2.2.2.2 remote-as 200	Define neighbor R3. 2.2.2.2 is the IP address of R3, and 200 is the AS number.
(config-router)#bgp bestpath med remove-send- med	Enable the remove sent MED value option.
(config-router)# address-family ipv4 unicast	Enter address-family ipv4 unicast mode
(config-router-af)# neighbor 1.1.1.1 activate	Activate neighbor under address family mode
(config-router-af)# neighbor 2.2.2.2 activate	Activate neighbor under address family mode
(config-router-af)# exit-address-family	Exit address family mode
(config-router)#commit	Commit the candidate configuration to the running configuration.

Validation

R2#show ip bgp

BGP table version is 2, local router ID is 192.168.52.3

Status codes: s suppressed, d damped, h history, * valid, > best, i - internal,
l - labeled, S Stale

Origin codes: i - IGP, e - EGP, ? - incomplete

Network	Next Hop	Metric	LocPrf	Weight	Path
---------	----------	--------	--------	--------	------

```
*> 100.0.0.0      1.1.1.1      removed      100          0          100 ?
```

Total number of prefixes 1

```
R3#show ip bgp
```

```
BGP table version is 1, local router ID is 192.168.52.4
```

```
Status codes: s suppressed, d damped, h history, * valid, > best, i - internal,
                l - labeled, S Stale
```

```
Origin codes: i - IGP, e - EGP, ? - incomplete
```

	Network	Next Hop	Metric	LocPrf	Weight	Path
* i	100.0.0.0	1.1.1.1	400	100	0	100 ?

Total number of prefixes 1

BGP Four-Byte Autonomous System

Extended AS numbers can be mapped to 2-byte AS numbers if the value is less than, or equal to, 65535. If the AS number is higher than 65535, it cannot be mapped to a 2-byte AS number. Therefore, if a BGP speaker is configured with a non-mappable AS number, it must enable the BGP extended ASN capability in OcNOS.

Note: Autonomous System number 23456 is a reserved IANA number for AS transition; thus, it is recommended that no system be configured with 23456 as its AS number.

The extended ASN capability is disabled by default. However, when it is enabled, it is able to interoperate with a 2-byte AS-numbered speaker, in compliance with RFC 4893.

If a 4-byte AS number is configured in the provider's network using BGP MPLS VPN or standard IPv4/IPv6 BGP, it is recommended that the PE routers be 4-byte AS-enabled before connecting to 4-byte AS-enabled customer networks. For implications related to AS number transition issues, refer to RFC 4893.

You can also set up 4-byte AS-specific extended communities and route distinguishers (RDs) with limited capabilities. However, it is recommended that 2-byte AS-specific RDs and extended communities be used for regular deployment.

BGP encodes an ASN into four octets, so that more autonomous systems can be supported. Extended ASN capability is advertised in the Open message capabilities when the 4-octet ASN capability is enabled. When the 4-octet ASN capability is enabled, the valid ASN value range is <1-4294967295>, with the exception discussed in the first Note, above.

Note: Four-octet capability is disabled by default.

4-Octet ASN Capability Enabled on R1 and R2

In this example, 4-Octet ASN capability is enabled on BGP speakers R1 and R2.

Topology

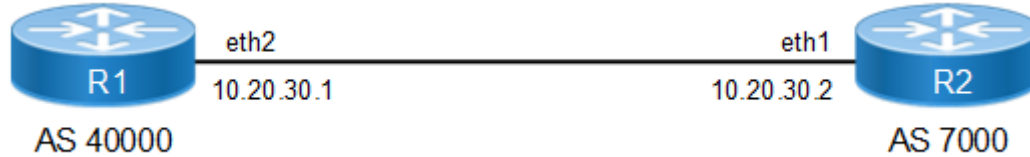

Figure 1-21: 4-Octet ASN on Both Routers

R1

#configure terminal	Enter configure mode.
(config)#bgp extended-asn-cap	Enable 4-octet ASN capability.
(config)#router bgp 400000	Assign the ASN value (400000) to the router.
(config-router)#neighbor 10.20.30.2 remote-as 7000	Specify the neighbor's IP address (10.20.30.2) and the ASN value of the neighbor (7000).
(config-router)# address-family ipv4 unicast	Enter address-family ipv4 unicast mode
(config-router-af)# neighbor 10.20.30.2 activate	Activate neighbor under address family mode
(config-router-af)# exit-address-family	Exit address family mode
(config-router)#commit	Commit the candidate configuration to the running configuration.

R2

#configure terminal	Enter configure mode.
(config)#bgp extended-asn-cap	Enable 4-octet ASN capability.
(config)#router bgp 7000	Assign the ASN value (7000) to the router.
(config-router)#neighbor 10.20.30.1 remote-as 400000	Specify the neighbor's IP address (10.20.30.1) and the ASN value of the neighbor (400000).
(config-router)# address-family ipv4 unicast	Enter address-family ipv4 unicast mode
(config-router-af)# neighbor 10.20.30.1 activate	Activate neighbor under address family mode
(config-router-af)# exit-address-family	Exit address family mode
(config-router)#commit	Commit the candidate configuration to the running configuration.

4-Octet ASN Capability Enabled on R1 and Disabled on R2

In the following two examples, 4-Octet ASN capability is enabled on BGP speaker R1 and disabled on R2.

Topology

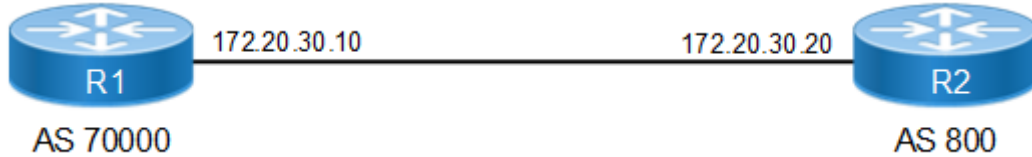

Figure 1-22: 4-Octet ASN on One Router

R1

#configure terminal	Enter configure mode.
(config)#bgp extended-asn-cap	Enable 4-octet ASN capability.
(config)#router bgp 70000	Assign the ASN value (70000) to the router.
(config-router)#neighbor 172.20.30.20 remote-as 800	Specify the neighbor's IP address (172.20.30.20) and the ASN value of the neighbor (800).
(config-router)# address-family ipv4 unicast	Enter address-family ipv4 unicast mode
(config-router-af)# neighbor 172.20.30.20 activate	Activate neighbor under address family mode
(config-router-af)# exit-address-family	Exit address family mode
(config-router)#commit	Commit the candidate configuration to the running configuration.

R2

#configure terminal	Enter configure mode.
(config)#no bgp extended-asn-cap	Disable 4-octet ASN capability.
(config)#router bgp 800	Assign the ASN value (800) to the router.
(config-router)#neighbor 172.20.30.10 remote-as 70000	Specify the neighbor's IP address (172.20.30.10) and the ASN value of the neighbor (70000).
(config-router)# address-family ipv4 unicast	Enter address-family ipv4 unicast mode
(config-router-af)# neighbor 172.20.30.10 activate	Activate neighbor under address family mode
(config-router-af)# exit-address-family	Exit address family mode
(config-router)#commit	Commit the candidate configuration to the running configuration.

Topology

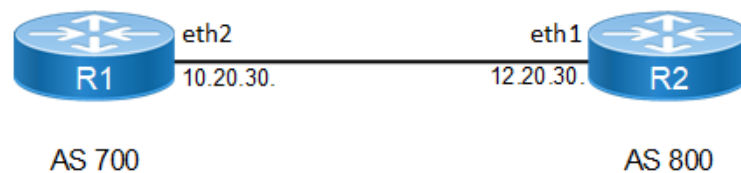

Figure 1-23: 4-Octet ASN

R1

#configure terminal	Enter configure mode.
(config)#bgp extended-asn-cap	Enable 4-octet ASN capability.
(config)#router bgp 700	Assign the ASN value (700) to the router.
(config-router)#neighbor 172.20.30.20 remote-as 800	Specify the neighbor's IP address (172.20.30.20) and the ASN value of the neighbor (800).
(config-router)# address-family ipv4 unicast	Enter address-family ipv4 unicast mode
(config-router-af)# neighbor 172.20.30.20 activate	Activate neighbor under address family mode
(config-router-af)# exit-address-family	Exit address family mode
(config-router)#commit	Commit the candidate configuration to the running configuration.

R2

#configure terminal	Enter configure mode.
(config)#no bgp extended-asn-cap	Disable 4-octet ASN capability.
(config)#router bgp 800	Assign the ASN value (800) to the router.
(config-router)#neighbor 172.20.30.10 remote-as 700	Specify the neighbor's IP address (172.20.30.10) and the ASN value of the neighbor (700).
(config-router)# address-family ipv4 unicast	Enter address-family ipv4 unicast mode
(config-router-af)# neighbor 172.20.30.10 activate	Activate neighbor under address family mode
(config-router-af)# exit-address-family	Exit address family mode
(config-router)#commit	Commit the candidate configuration to the running configuration.

Validation

```
#show ip bgp summary
BGP router identifier 192.168.52.2, local AS number 400000
BGP table version is 1
0 BGP AS-PATH entries
0 BGP community entries
```

Neighbor	V	AS	MsgRcv	MsgSen	TblVer	InQ	OutQ	Up/
Down State/PfxRcd								
10.20.30.2	4	7000	2	3	1	0	0	
00:00:08	0							

```
Total number of neighbors 1
```

```
Total number of Established sessions 1
```

```
#show ip bgp neighbors
BGP neighbor is 10.20.30.1, remote AS 400000, local AS 7000, external link
BGP version 4, local router ID 192.168.52.3, remote router ID 192.168.52.2
BGP state = Established, up for 00:02:20
```

```

Last read 00:00:20, hold time is 90, keepalive interval is 30 seconds
Neighbor capabilities:
  Route refresh: advertised and received (old and new)
  4-Octet ASN Capability: advertised and received
  Address family IPv4 Unicast: advertised and received
Received 6 messages, 0 notifications, 0 in queue
Sent 6 messages, 0 notifications, 0 in queue
Route refresh request: received 0, sent 0
Minimum time between advertisement runs is 30 seconds
For address family: IPv4 Unicast
  BGP table version 1, neighbor version 1
  Index 1, Offset 0, Mask 0x2
  Community attribute sent to this neighbor (both)
  0 accepted prefixes
  0 announced prefixes

Connections established 1; dropped 0
Local host: 10.20.30.2, Local port: 49434
Foreign host: 10.20.30.1, Foreign port: 179
Next hop: 10.20.30.2
Next hop global: ::
Next hop local: ::
BGP connection: non shared network

```

BGP Extended Community Attribute

The Extended Community Attribute provides a mechanism for labeling information carried in BGP.

Extended Community with a 2-Byte ASN

In the following example, CE1, PE1, PE2, and CE2 are 2-byte-ASN capable, and do not support 4-byte-ASN capability.

Topology

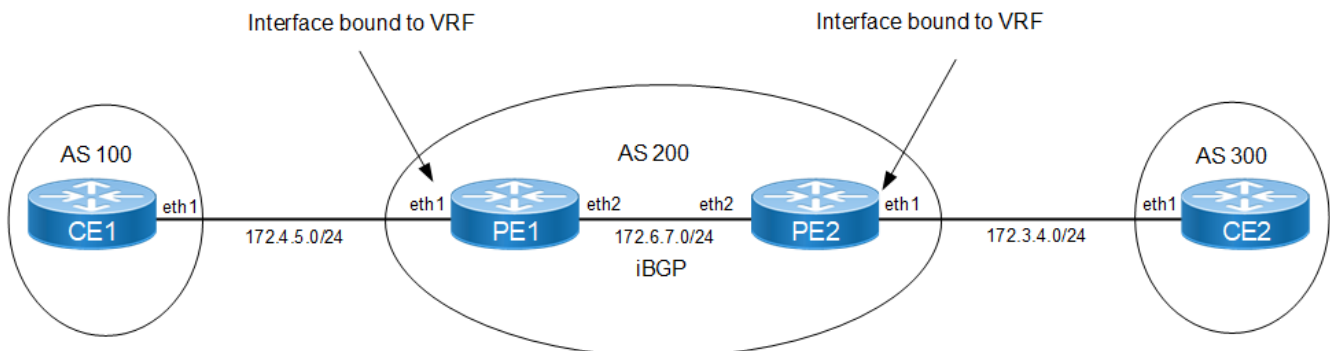

Figure 1-24: Extended Communities — 2-Byte ASN

CE1

#configure terminal	Enter configure mode.
(config)#interface eth1	Enter interface mode.
(config-if)#ip address 172.4.5.115/24	Configure the IP address on this interface
(config-if)#exit	Exit interface mode.
(config)#router bgp 100	Assign the ASN value (100) to the router. The ASN range is <1-65535>.
(config-router)#neighbor 172.4.5.116 remote-as 200	Specify the neighbor's IP address (172.4.5.116) and the ASN value of the neighbor (200).
(config-router)# address-family ipv4 unicast	Enter address-family ipv4 unicast mode
(config-router-af)# neighbor 172.4.5.116 activate	Activate neighbor under address family mode
(config-router-af)# exit-address-family	Exit address family mode
(config-router)#commit	Commit the candidate configuration to the running configuration.

CE2

#configure terminal	Enter configure mode.
(config)#interface eth1	Enter interface mode.
(config-if)#ip address 172.3.4.114/24	Configure the IP address on this interface
(config-if)#exit	Exit interface mode.
(config)#router bgp 300	Assign the ASN value (300) to the router. The ASN range is <1-65535>.
(config-router)#neighbor 172.3.4.117 remote-as 200	Specify the neighbor's IP address (172.3.4.117) and the ASN value of the neighbor (200).
(config-router)# address-family ipv4 unicast	Enter address-family ipv4 unicast mode
(config-router-af)# neighbor 172.3.4.117 activate	Activate neighbor under address family mode
(config-router-af)# exit-address-family	Exit address family mode
(config-router)#commit	Commit the candidate configuration to the running configuration.

PE1

#configure terminal	Enter configure mode.
(config)#ip vrf VRF1	Specify the name of the VRF (VRF1) to be created.
(config-vrf)#rd 100:10	Assign a route distinguisher (RD) for the VRF, which is a unique value on the router. The RD value can be in ASN:NN or A.B.C.D:NN format.
(config-vrf)#route-target both 100:10	Specify the 2-Octet AS specific or IPv4 specific Transitive Route-Target extended community attribute.
(config-vrf)#exit	Exit VRF mode, and return to Configure mode.
(config)#interface eth1	Enter interface mode.
(config-if)#ip vrf forwarding VRF1	Bind the interface (eth1) to the VRF (VRF1).
(config-if)#ip address 172.4.5.116/24	Configure the IP address on this interface
(config-if)#exit	Exit interface mode.
(config)#ip route vrf VRF1 75.1.1.0/24 eth1	Create a VRF static route.
(config)#interface eth2	Enter interface mode.
(config-if)#ip address 172.6.7.116/24	Configure the IP address on this interface
(config-if)#exit	Exit interface mode.
(config)#router bgp 200	Assign the ASN value (200) to the router.
(config-router)#neighbor 172.6.7.117 remote-as 200	Specify the neighbor's (PE2) IP address (172.6.7.117) and the ASN value of the neighbor (200). In this case, it is an iBGP connection, so both PE1 and PE2 are in the same AS.
(config-router)#address-family vpnv4 unicast	Enable the exchange of VPNv4 routing information among ISP PE-routers, and enter Address-Family-VPNv4 mode.
(config-router-af)#neighbor 172.6.7.117 activate	Activate the neighbor in address-family.
(config-router-af)#exit	Exit Address-Family-VPNv4 mode.
(config-router)#address-family ipv4 vrf VRF1	Enable the exchange of VRF routing information among ISP PE-routers, and enter Address-Family-VRF mode.
(config-router-af)#neighbor 172.4.5.115 remote-as 100	Specify the neighbor's (CE1) IP address and ASN value.
(config-router-af)#neighbor 172.4.5.115 activate	Activate the neighbor in address-family
(config-router-af)#neighbor 172.4.5.115 send-community both	Enable extended community attribute for the neighbor.
(config-router-af)#redistribute static	Configure static redistribution.
(config-router-af)# exit-address-family	Exit address family mode
(config-router)#commit	Commit the candidate configuration to the running configuration.

PE2

#configure terminal	Enter configure mode.
(config)#ip vrf VRF1	Specify the name of the VRF (VRF1) to be created.

BGP

<code>(config-vrf)#rd 100:10</code>	Assign a route distinguisher (RD) for the VRF.
<code>(config-vrf)#route-target both 100:10</code>	Specify the 2-Octet AS specific or IPv4 specific Transitive Route-Target extended community attribute.
<code>(config-vrf)#exit</code>	Exit VRF mode, and return to Configure mode.
<code>(config)#interface eth1</code>	Enter interface mode.
<code>(config-if)#ip vrf forwarding VRF1</code>	Bind the interface (eth1) to the VRF (VRF1).
<code>(config-if)#ip address 172.3.4.117/24</code>	Configure the IP address on this interface
<code>(config-if)#exit</code>	Exit interface mode.
<code>(config)#ip route vrf VRF1 100.1.1.0/24 eth1</code>	Create a VRF static route.
<code>(config)#interface eth2</code>	Enter interface mode.
<code>(config-if)#ip address 172.6.7.117/24</code>	Configure the IP address on this interface
<code>(config-if)#exit</code>	Exit interface mode.
<code>(config)#router bgp 200</code>	Assign the ASN value (200) to the router.
<code>(config-router)#neighbor 172.6.7.116 remote-as 200</code>	Specify the neighbor's (PE1) IP address (172.6.7.116) and the ASN value of the neighbor (200). In this case, it is an iBGP connection, so both PE1 and PE2 are in the same AS.
<code>(config-router)#address-family vpnv4 unicast</code>	Enable the exchange of VPNv4 routing information among ISP PE-routers, and enter Address-Family-VPNv4 mode.
<code>(config-router-af)#neighbor 172.6.7.116 activate</code>	Enable the exchange of routing information with a peer router.
<code>(config-router-af)#exit</code>	Exit Address-Family-VPNv4 mode.
<code>(config-router)#address-family ipv4 vrf VRF1</code>	Enable the exchange of VRF routing information among ISP PE-routers, and enter Address-Family-VRF mode.
<code>(config-router-af)#neighbor 172.3.4.114 remote-as 300</code>	Specify the neighbor's (CE2) IP address and ASN value.
<code>(config-router-af)# neighbor 17.3.4.114 activate</code>	Activate the neighbor in address family mode
<code>(config-router-af)#neighbor 172.3.4.114 send-community both</code>	Enable extended community attribute for the neighbor.
<code>(config-router-af)#redistribute static</code>	Configure static redistribution.
<code>(config-router-af)# exit-address-family</code>	Exit address family mode
<code>(config-router)#commit</code>	Commit the candidate configuration to the running configuration.

Validation

CE1

```
#show running-config
!  
no service password-encryption
!  
logging monitor 7
!  
ip vrf management
```

```
!  
ip domain-lookup feature telnet feature ssh  
snmp-server enable snmp  
snmp-server view all .1 included feature ntp  
ntp enable  
username ocnos role network-admin password encrypted $1$AUeGhbf0$HCHxemCQ39LPYOjC.Kb7/  
feature rsyslog  
!  
interface lo  
ip address 127.0.0.1/8 ipv6 address ::1/128 mtu 65536  
!  
interface eth0  
ip address 192.168.52.2/24  
!  
interface eth1  
ip address 172.4.5.115/24  
!  
interface eth2 shutdown  
!  
interface eth3 shutdown  
!  
interface eth4 shutdown  
!  
interface eth5 shutdown  
!  
router bgp 100  
neighbor 172.4.5.116 remote-as 200  
!  
  address-family ipv4 unicast  
  neighbor 172.4.5.116 activate  
  exit-address-family  
!  
line con 0 login  
line vty 0 39 login  
!  
end  
  
#  
#show ip bgp  
BGP table version is 8, local router ID is 192.168.52.2  
Status codes: s suppressed, d damped, h history, * valid, > best, i - internal, l -  
labeled, S Stale  
Origin codes: i - IGP, e - EGP, ? - incomplete  
  
      NetworkNext HopMetricLocPrfWeightPath  
*> 75.1.1.0/24172.4.5.11601000200?  
*> 100.1.1.0/24172.4.5.11601000200?  
  
Total number of prefixes 2 #
```

BGP

```
#show ip bgp neighbors
BGP neighbor is 172.4.5.116, remote AS 200, local AS 100, external link
BGP version 4, local router ID 192.168.52.2, remote router ID 172.4.5.116 BGP state =
Established, up for 00:04:22
Last read 00:00:22, hold time is 90, keepalive interval is 30 seconds Neighbor
capabilities:
Route refresh: advertised and received (old and new) Address family IPv4 Unicast:
advertised and received
Received 131 messages, 1 notifications, 0 in queue
Sent 129 messages, 0 notifications, 0 in queue Route refresh request: received 0, sent 0
Minimum time between advertisement runs is 30 seconds For address family: IPv4 Unicast
BGP table version 8, neighbor version 8 Index 1, Offset 0, Mask 0x2
Community attribute sent to this neighbor (both)
2 accepted prefixes
0 announced prefixes

Connections established 2; dropped 1
Local host: 172.4.5.115, Local port: 179
Foreign host: 172.4.5.116, Foreign port: 37982
Nexthop: 172.4.5.115 Nexthop global: ::
Nexthop local: ::
BGP connection: non shared network
Last Reset: 00:04:54, due to BGP Notification received Notification Error Message:
(Cease/Peer Unconfigured.)
```

```
#show ip bgp vrf all
BGP table version is 8, local router ID is 192.168.52.2
Status codes: s suppressed, d damped, h history, * valid, > best, i - internal, l -
labeled, S Stale
Origin codes: i - IGP, e - EGP, ? - incomplete
```

```
NetworkNext HopMetricLocPrfWeightPath
*> 75.1.1.0/24172.4.5.11601000200 ?
*> 100.1.1.0/24172.4.5.11601000200 ?
```

Total number of prefixes 2 #

```
#show ip bgp summary vrf all
BGP router identifier 192.168.52.2, local AS number 100 BGP table version is 8
1 BGP AS-PATH entries
0 BGP community entries
```

```
NeighborVASMsgRcvMsgSen TblVerInQOutQUp/DownState/ PfxRcd
172.4.5.116420016816580 0 00:22:04
2
```

Total number of neighbors 1

Total number of Established sessions 1

PE1

```
#show ip bgp vpnv4 all
Status codes: s suppressed, d damped, h history, * valid, > best, i - internal, l -
labeled
```

```
      S Stale
```

```
Origin codes: i - IGP, e - EGP, ? - incomplete
```

Network	Next Hop	Metric	LocPrf	Weight	Path
Route Distinguisher: 100:10 (Default for VRF VRF1)					
*> 75.1.1.0/24	0.0.0.0	0	100	32768	?
*>i 100.1.1.0/24	172.6.7.117	0	100	0	?
Announced routes count = 1					
Accepted routes count = 1					
Route Distinguisher: 100:10					
*>i 100.1.1.0/24	172.6.7.117	0	100	0	?
Announced routes count = 0					
Accepted routes count = 1					

```
#show ip bgp vrf all
BGP table version is 2, local router ID is 172.4.5.116
Status codes: s suppressed, d damped, h history, * valid, > best, i - internal,
              l - labeled, S Stale
Origin codes: i - IGP, e - EGP, ? - incomplete
```

Network	Next Hop	Metric	LocPrf	Weight	Path
BGP Route Table for VRF VRF1					
*> 75.1.1.0/24	0.0.0.0	0	100	32768	?
*>i 100.1.1.0/24	172.6.7.117	0	100	0	?

```
Total number of prefixes 2
```

```
#show ip bgp summary vrf all
BGP router identifier 172.4.5.116, local AS number 200
BGP VRF VRF1 Route Distinguisher: 100:10
BGP table version is 2
1 BGP AS-PATH entries
0 BGP community entries
```

Neighbor	V	AS	MsgRcv	MsgSen	TblVer	InQ	OutQ	Up/Down	State/
172.4.5.115	4	100	55	60	2	0	0	00:26:54	
0									

```
Total number of neighbors 1
```

```
Total number of Established sessions 1
BGP router identifier 192.168.52.3, local AS number 200
```

BGP

BGP table version is 1
1 BGP AS-PATH entries
0 BGP community entries

Neighbor PfxRcd	V	AS	MsgRcv	MsgSen	TblVer	InQ	OutQ	Up/Down	State/
172.6.7.117 0	4	200	80	101	1	0	0	00:37:47	

Total number of neighbors 1

Total number of Established sessions 1

#show ip bgp neighbors

BGP neighbor is 172.6.7.117, remote AS 200, local AS 200, internal link
BGP version 4, local router ID 192.168.52.3, remote router ID 192.168.52.5
BGP state = Established, up for 00:38:33
Last read 00:00:03, hold time is 90, keepalive interval is 30 seconds
Neighbor capabilities:
Route refresh: advertised and received (old and new)
Address family IPv4 Unicast: advertised and received
Address family VPNv4 Unicast: advertised and received
Received 82 messages, 0 notifications, 0 in queue
Sent 103 messages, 0 notifications, 0 in queue
Route refresh request: received 0, sent 0
Minimum time between advertisement runs is 5 seconds
For address family: IPv4 Unicast
BGP table version 1, neighbor version 1
Index 1, Offset 0, Mask 0x2
Community attribute sent to this neighbor (both)
0 accepted prefixes
0 announced prefixes

For address family: VPNv4 Unicast
BGP table version 4, neighbor version 4
Index 1, Offset 0, Mask 0x2
Community attribute sent to this neighbor (both)
1 accepted prefixes
1 announced prefixes

Connections established 1; dropped 0
Local host: 172.6.7.116, Local port: 179
Foreign host: 172.6.7.117, Foreign port: 57743
Nexthop: 172.6.7.116
Nexthop global: ::
Nexthop local: ::
BGP connection: non shared network

BGP neighbor is 172.4.5.115, vrf VRF1, remote AS 100, local AS 200, external link
BGP version 4, local router ID 172.4.5.116, remote router ID 192.168.52.2

```

BGP state = Established, up for 00:27:40
Last read 00:00:10, hold time is 90, keepalive interval is 30 seconds
Neighbor capabilities:
  Route refresh: advertised and received (old and new)
  Address family IPv4 Unicast: advertised and received
Received 57 messages, 0 notifications, 0 in queue
Sent 62 messages, 0 notifications, 0 in queue
Route refresh request: received 0, sent 0
Minimum time between advertisement runs is 30 seconds
For address family: IPv4 Unicast
  BGP table version 2, neighbor version 2
  Index 1, Offset 0, Mask 0x2
  Community attribute sent to this neighbor (both)
  0 accepted prefixes
  2 announced prefixes

Connections established 1; dropped 0
Local host: 172.4.5.116, Local port: 37982
Foreign host: 172.4.5.115, Foreign port: 179
Nexthop: 172.4.5.116
Nexthop global: ::
Nexthop local: ::
BGP connection: non shared network

#show ip bgp vrf all
BGP table version is 2, local router ID is 172.4.5.116
Status codes: s suppressed, d damped, h history, * valid, > best, i - internal,
               l - labeled, S Stale
Origin codes: i - IGP, e - EGP, ? - incomplete

      Network          Next Hop           Metric    LocPrf    Weight Path
BGP Route Table for VRF VRF1
*>  75.1.1.0/24        0.0.0.0            0         100       32768    ?
*>i 100.1.1.0/24       172.6.7.117        0         100        0        ?

Total number of prefixes 2

```

PE2

```

#show ip bgp vrf all
BGP table version is 1, local router ID is 172.3.4.117
Status codes: s suppressed, d damped, h history, * valid, > best, i - internal,
               l - labeled, S Stale
Origin codes: i - IGP, e - EGP, ? - incomplete

      Network          Next Hop           Metric    LocPrf    Weight Path
BGP Route Table for VRF VRF1

```

BGP

```
*>i 75.1.1.0/24      172.6.7.116      0      100      0      ?
*> 100.1.1.0/24     0.0.0.0          0      100      32768  ?
```

Total number of prefixes 2

```
#show ip bgp summary vrf all
```

```
BGP router identifier 172.3.4.117, local AS number 200
BGP VRF VRF1 Route Distinguisher: 100:10
BGP table version is 1
1 BGP AS-PATH entries
0 BGP community entries
```

Neighbor PfxRcd	V	AS	MsgRcv	MsgSen	TblVer	InQ	OutQ	Up/Down	State/
172.3.4.114 0	4	300	82	85	1	0	0	00:40:05	

Total number of neighbors 1

Total number of Established sessions 1

```
BGP router identifier 192.168.52.5, local AS number 200
BGP table version is 1
1 BGP AS-PATH entries
0 BGP community entries
```

Neighbor PfxRcd	V	AS	MsgRcv	MsgSen	TblVer	InQ	OutQ	Up/Down	State/
172.6.7.116 0	4	200	113	113	1	0	0	00:54:07	

Total number of neighbors 1

Total number of Established sessions 1#

```
#show ip bgp neighbors
```

```
BGP neighbor is 172.6.7.116, remote AS 200, local AS 200, internal link
  BGP version 4, local router ID 192.168.52.5, remote router ID 192.168.52.3
  BGP state = Established, up for 00:56:09
  Last read 00:00:09, hold time is 90, keepalive interval is 30 seconds
  Neighbor capabilities:
    Route refresh: advertised and received (old and new)
    Address family IPv4 Unicast: advertised and received
    Address family VPNv4 Unicast: advertised and received
  Received 117 messages, 0 notifications, 0 in queue
  Sent 117 messages, 0 notifications, 0 in queue
  Route refresh request: received 0, sent 0
  Minimum time between advertisement runs is 5 seconds
  For address family: IPv4 Unicast
  BGP table version 1, neighbor version 1
```

```
Index 1, Offset 0, Mask 0x2
Community attribute sent to this neighbor (both)
0 accepted prefixes
0 announced prefixes
```

```
For address family: VPNv4 Unicast
BGP table version 5, neighbor version 5
Index 1, Offset 0, Mask 0x2
Community attribute sent to this neighbor (both)
1 accepted prefixes
1 announced prefixes
```

```
Connections established 1; dropped 0
Local host: 172.6.7.117, Local port: 57743
Foreign host: 172.6.7.116, Foreign port: 179
Next hop: 172.6.7.117
Next hop global: ::
Next hop local: ::
BGP connection: non shared network
```

```
BGP neighbor is 172.3.4.114, vrf VRF1, remote AS 300, local AS 200, external link
BGP version 4, local router ID 172.3.4.117, remote router ID 192.168.52.4
BGP state = Established, up for 00:42:07
Last read 00:00:07, hold time is 90, keepalive interval is 30 seconds
Neighbor capabilities:
  Route refresh: advertised and received (old and new)
  Address family IPv4 Unicast: advertised and received
Received 86 messages, 0 notifications, 0 in queue
Sent 89 messages, 0 notifications, 0 in queue
Route refresh request: received 0, sent 0
Minimum time between advertisement runs is 30 seconds
For address family: IPv4 Unicast
BGP table version 1, neighbor version 1
Index 0, Offset 0, Mask 0x1
Community attribute sent to this neighbor (both)
0 accepted prefixes
2 announced prefixes
```

```
Connections established 1; dropped 0
Local host: 172.3.4.117, Local port: 54753
Foreign host: 172.3.4.114, Foreign port: 179
Next hop: 172.3.4.117
Next hop global: ::
Next hop local: ::
BGP connection: non shared network
```

CE2

```
#show ip bgp vpnv4 all
#show ip bgp
BGP table version is 3, local router ID is 192.168.52.4
```

Status codes: s suppressed, d damped, h history, * valid, > best, i - internal,

l - labeled, S Stale

Origin codes: i - IGP, e - EGP, ? - incomplete

	Network	Next Hop	Metric	LocPrf	Weight	Path
*>	75.1.1.0/24	172.3.4.117	0	100	0	200
?						
*>	100.1.1.0/24	172.3.4.117	0	100	0	200
?						

Total number of prefixes 2

#

#

#show ip bgp vrf all

BGP table version is 3, local router ID is 192.168.52.4

Status codes: s suppressed, d damped, h history, * valid, > best, i - internal,

l - labeled, S Stale

Origin codes: i - IGP, e - EGP, ? - incomplete

	Network	Next Hop	Metric	LocPrf	Weight	Path
*>	75.1.1.0/24	172.3.4.117	0	100	0	200
?						
*>	100.1.1.0/24	172.3.4.117	0	100	0	200
?						

Total number of prefixes 2

#

#

#show ip bgp summary vrf all

BGP router identifier 192.168.52.4, local AS number 300

BGP table version is 3

1 BGP AS-PATH entries

0 BGP community entries

Neighbor	Down	State/PfxRcd	V	AS	MsgRcv	MsgSen	TblVer	InQ	OutQ	Up/
172.3.4.117			4	200	382	414	3	0	0	
00:42:54			2							

Total number of neighbors 1

Total number of Established sessions 1

#

#

#show ip bgp neighbors

BGP neighbor is 172.3.4.117, remote AS 200, local AS 300, external link

BGP version 4, local router ID 192.168.52.4, remote router ID 172.3.4.117

BGP state = Established, up for 00:43:04

Last read 00:00:04, hold time is 90, keepalive interval is 30 seconds

Neighbor capabilities:

Route refresh: advertised and received (old and new)

Address family IPv4 Unicast: advertised and received

Received 236 messages, 147 notifications, 0 in queue

Sent 415 messages, 0 notifications, 0 in queue

Route refresh request: received 0, sent 0

Minimum time between advertisement runs is 30 seconds

For address family: IPv4 Unicast
BGP table version 3, neighbor version 3
Index 1, Offset 0, Mask 0x2
Community attribute sent to this neighbor (both)
2 accepted prefixes
0 announced prefixes

Connections established 1; dropped 0
Local host: 172.3.4.114, Local port: 179
Foreign host: 172.3.4.117, Foreign port: 54753
Nexthop: 172.3.4.114
Nexthop global: ::
Nexthop local: ::
BGP connection: non shared network
Last Reset: 00:43:32, due to BGP Notification received
Notification Error Message: (OPEN Message Error/Bad Peer AS.)

#

Extended Community with a 4-Byte ASN

In the following example, CE1, PE1, PE2, and CE2 support 4-byte ASN capability.

Note: PE1 and PE2 should both either be 4-byte-ASN capable or 2-byte-ASN capable. Support for the combination of one 4-byte-ASN capable PE with one 2-byte-ASN-capable PE is currently unavailable.

Topology

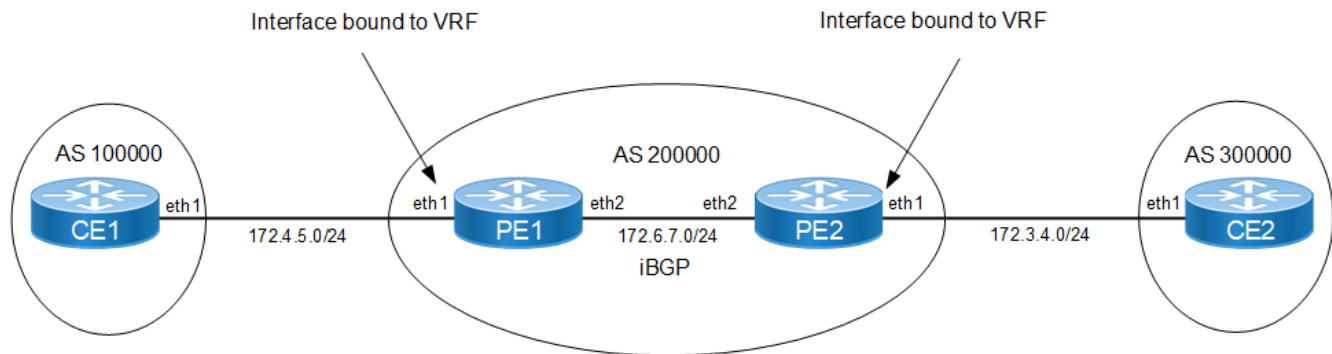

Figure 1-25: Extended Communities — 4-Byte ASN

CE1

#configure terminal	Enter configure mode.
(config)#interface eth1	Enter interface mode.
(config-if)#ip address 172.4.5.115/24	Configure the IP address on this interface
(config-if)#exit	Exit interface mode.
(config)#bgp extended-asn-cap	Enable 4-octet ASN capability.
(config)#router bgp 100000	Assign the ASN value (100000) to the router. The ASN range is <1-4294967295>.
(config-router)#neighbor 172.4.5.116 remote-as 200000	Specify the neighbor's IP address (172.4.5.116) and the ASN value of the neighbor (200000).
(config-router)# address-family ipv4 unicast	Enter address-family ipv4 unicast mode
(config-router-af)# neighbor 172.4.5.116 activate	Activate neighbor under address family mode
(config-router-af)# exit-address-family	Exit address family mode
(config-router)#commit	Commit the candidate configuration to the running configuration.

PE1

#configure terminal	Enter configure mode.
(config)#bgp extended-asn-cap	Enable 4-octet ASN capability. Dynamic change from 2- byte to 4-byte capability, or vice versa, is not allowed, unless the VRF is removed.
(config)#ip vrf VRF1	Specify the name of the VRF (VRF1) to be created.

(config-vrf)#rd 1.1.1.1:200	Assign a 4-byte route distinguisher (RD) for the VRF, which is a unique value on the router. The RD value can be in A.B.C.D:NN format.
(config-vrf)#route-target both 1.1.1.1:200	Specify the 4-Octet AS specific or IPv4 specific Transitive Route-Target extended community attribute.
(config-vrf)#exit	Exit VRF mode, and return to Configure mode.
(config)#interface eth1	Enter interface mode.
(config-if)#ip vrf forwarding VRF1	Bind the interface (eth1) to the VRF (VRF1).
(config-if)#ip address 172.4.5.116/24	Configure the IP address on this interface
(config-if)#exit	Exit interface mode.
(config)#ip route vrf VRF1 50.1.1.0/24 eth1	Create a VRF static route.
(config)#interface eth2	Enter interface mode.
(config-if)#ip address 172.6.7.116/24	Configure the IP address on this interface
(config-if)#exit	Exit interface mode.
(config)#router bgp 200000	Assign the ASN value (200000) to the router.
(config-router)#neighbor 172.6.7.117 remote-as 200000	Specify the neighbor's (PE2) IP address (172.6.7.117) and the ASN value of the neighbor (200000). In this case, it is an iBGP connection, so both PE1 and PE2 are in the same AS.
(config-router)#address-family vpnv4 unicast	Enable the exchange of VPNv4 routing information among ISP PE-routers, and enter Address-Family-VPNv4 mode.
(config-router-af)#neighbor 172.6.7.117 activate	Enable the exchange of routing information with a peer router.
(config-router-af)#exit	Exit Address-Family-VPNv4 mode.
(config-router)#address-family ipv4 vrf VRF1	Enable the exchange of VRF routing information among ISP PE-routers, and enter Address-Family-VRF mode.
(config-router-af)#neighbor 172.4.5.115 remote-as 100000	Specify the neighbor's (CE1) IP address and ASN value.
(config-router-af)# neighbor 172.4.5.115 activate	Activate neighbor in address family mode
(config-router-af)#neighbor 172.4.5.115 send-community both	Enable extended community attribute for the neighbor.
(config-router-af)#redistribute static	Configure static redistribution.
(config-router-af)# exit-address-family	Exit address family mode
(config-router)#commit	Commit the candidate configuration to the running configuration.

PE2

#configure terminal	Enter configure mode.
(config)#bgp extended-asn-cap	Enable 4-octet ASN capability. Dynamic change from 2- byte to 4-byte capability, or vice versa, is not allowed, unless the VRF is removed.
(config)#ip vrf VRF1	Specify the name of the VRF (VRF1) to be created.
(config-vrf)#rd 1.1.1.1:200	Assign a 4-byte route distinguisher (RD) for the VRF.
(config-vrf)#route-target both 1.1.1.1:200	Specify the 4-Octet AS specific or IPv4 specific Transitive Route-Target extended community attribute.

BGP

(config-vrf)#exit	Exit VRF mode, and return to Configure mode.
(config)#interface eth1	Enter interface mode.
(config-if)#ip vrf forwarding VRF1	Bind the interface (eth1) to the VRF (VRF1).
(config-if)#ip address 172.3.4.117/24	Configure the IP address on this interface
(config-if)#exit	Exit interface mode.
(config)#ip route vrf VRF1 200.1.1.0/24 eth1	Create a VRF static route.
(config)#interface eth2	Enter interface mode.
(config-if)#ip address 172.6.7.117/24	Configure the IP address on this interface
(config-if)#exit	Exit interface mode.
(config-router)#commit	Commit the candidate configuration to the running configuration.
(config)#router bgp 200000	Assign the ASN value (200000) to the router.
(config-router)#neighbor 172.6.7.116 remote-as 200000	Specify the neighbor's (PE2) IP address (172.6.7.116) and the ASN value of the neighbor (200000). In this case, it is an iBGP connection, so both PE1 and PE2 are in the same AS.
(config-router)#address-family vpnv4 unicast	Enable the exchange of VPNv4 routing information among ISP PE-routers, and enter Address-Family-VPNv4 mode.
(config-router-af)#neighbor 172.6.7.116 activate	Enable the exchange of routing information with a peer router.
(config-router-af)#exit	Exit Address-Family-VPNv4 mode.
(config-router)#address-family ipv4 vrf VRF1	Enable the exchange of VRF routing information among ISP PE-routers, and enter Address-Family-VRF mode.
(config-router-af)#neighbor 172.3.4.114 remote-as 300000	Specify the neighbor's (CE1) IP address and ASN value.
(config-router-af)# neighbor 172.3.4.114 activate	Activate neighbor under address family mode
(config-router-af)#neighbor 172.3.4.114 send-community both	Enable extended community attribute for the neighbor.
(config-router-af)#redistribute static	Configure static redistribution.
(config-router-af)# exit-address-family	Exit address family mode
(config-router)#commit	Commit the candidate configuration to the running configuration.

CE2

#configure terminal	Enter configure mode.
(config)#interface eth1	Enter interface mode.
(config-if)#ip address 172.3.4.114/24	Configure the IP address on this interface
(config-if)#exit	Exit interface mode.
(config)#bgp extended-asn-cap	Enable 4-octet ASN capability.
(config)#router bgp 300000	Assign the ASN value (300000) to the router.
(config-router)#neighbor 172.3.4.117 remote-as 200000	Specify the neighbor's IP address (172.3.4.117) and the ASN value of the neighbor (200000).
(config-router)# address-family ipv4 unicast	Enter address-family ipv4 unicast mode

(config-router-af)# neighbor 172.3.4.117 activate	Activate neighbor under address family mode
(config-router-af)# exit-address-family	Exit address family mode
(config-router)#commit	Commit the candidate configuration to the running configuration.

Validation

CE1

```
#show ip bgp neighbors
BGP neighbor is 172.4.5.116, remote AS 200000, local AS 100000, external link
  BGP version 4, local router ID 192.168.52.2, remote router ID 172.4.5.116
  BGP state = Established, up for 00:20:35
  Last read 00:00:05, hold time is 90, keepalive interval is 30 seconds
  Neighbor capabilities:
    Route refresh: advertised and received (old and new)
    4-Octet ASN Capability: advertised and received
    Address family IPv4 Unicast: advertised and received
  Received 45 messages, 0 notifications, 0 in queue
  Sent 47 messages, 0 notifications, 0 in queue
  Route refresh request: received 0, sent 0
  Minimum time between advertisement runs is 30 seconds
For address family: IPv4 Unicast
  BGP table version 3, neighbor version 3
  Index 1, Offset 0, Mask 0x2
  Community attribute sent to this neighbor (both)
  2 accepted prefixes
  0 announced prefixes

Connections established 1; dropped 0
Local host: 172.4.5.115, Local port: 179
Foreign host: 172.4.5.116, Foreign port: 58251
Nexthop: 172.4.5.115
Nexthop global: ::
Nexthop local: ::
BGP connection: non shared network

#show ip bgp vrf all
BGP table version is 3, local router ID is 192.168.52.2
Status codes: s suppressed, d damped, h history, * valid, > best, i - internal,
               l - labeled, S Stale
Origin codes: i - IGP, e - EGP, ? - incomplete

      Network          Next Hop           Metric      LocPrf      Weight Path
*>  50.1.1.0/24        172.4.5.116         0           100         0       200000 ?
*>  200.1.1.0          172.4.5.116         0           100         0       200000 ?

Total number of prefixes 2
```

BGP

```
#show ip bgp summary vrf all
```

```
BGP router identifier 192.168.52.2, local AS number 100000
```

```
BGP table version is 3
```

```
1 BGP AS-PATH entries
```

```
0 BGP community entries
```

Neighbor PfxRcd	V	AS	MsgRcv	MsgSen	TblVer	InQ	OutQ	Up/Down	State/
172.4.5.116 2	4	200000	46	48	3	0	0	00:21:12	

```
Total number of neighbors 1
```

```
Total number of Established sessions 1
```

PE1

```
#show ip bgp neighbors
```

```
BGP neighbor is 172.4.5.116, remote AS 200000, local AS 100000, external link
```

```
BGP version 4, local router ID 192.168.52.2, remote router ID 172.4.5.116
```

```
BGP state = Established, up for 00:20:35
```

```
Last read 00:00:05, hold time is 90, keepalive interval is 30 seconds
```

```
Neighbor capabilities:
```

```
Route refresh: advertised and received (old and new)
```

```
4-Octet ASN Capability: advertised and received
```

```
Address family IPv4 Unicast: advertised and received
```

```
Received 45 messages, 0 notifications, 0 in queue
```

```
Sent 47 messages, 0 notifications, 0 in queue
```

```
Route refresh request: received 0, sent 0
```

```
Minimum time between advertisement runs is 30 seconds
```

```
For address family: IPv4 Unicast
```

```
BGP table version 3, neighbor version 3
```

```
Index 1, Offset 0, Mask 0x2
```

```
Community attribute sent to this neighbor (both)
```

```
2 accepted prefixes
```

```
0 announced prefixes
```

```
Connections established 1; dropped 0
```

```
Local host: 172.4.5.115, Local port: 179
```

```
Foreign host: 172.4.5.116, Foreign port: 58251
```

```
Nexthop: 172.4.5.115
```

```
Nexthop global: ::
```

```
Nexthop local: ::
```

```
BGP connection: non shared network
```

```
#show ip bgp vrf all
```

```
BGP table version is 3, local router ID is 192.168.52.2
```

```
Status codes: s suppressed, d damped, h history, * valid, > best, i - internal,  
l - labeled, S Stale
```

Origin codes: i - IGP, e - EGP, ? - incomplete

	Network	Next Hop	Metric	LocPrf	Weight	Path
*>	50.1.1.0/24	172.4.5.116	0	100	0	200000 ?
*>	200.1.1.0	172.4.5.116	0	100	0	200000 ?

Total number of prefixes 2

```
#show ip bgp summary vrf all
BGP router identifier 192.168.52.2, local AS number 100000
BGP table version is 3
1 BGP AS-PATH entries
0 BGP community entries
```

Neighbor PfxRcd	V	AS	MsgRcv	MsgSen	TblVer	InQ	OutQ	Up/Down	State/
172.4.5.116 2	4	200000	46	48	3	0	0	00:21:12	

Total number of neighbors 1

Total number of Established sessions 1

```
#clear bgp *
2019 Mar 22 06:16:56.414 : NOS : BGP : CRITI : [BGP_OPR_NEIGH_STATE_DOWN_2]: Neighbour
[172.4.5.116] Session down due to peer clear
```

PE2

```
#show ip bgp neighbors
BGP neighbor is 172.4.5.116, remote AS 200000, local AS 100000, external link
  BGP version 4, local router ID 192.168.52.2, remote router ID 172.4.5.116
  BGP state = Established, up for 00:20:35
  Last read 00:00:05, hold time is 90, keepalive interval is 30 seconds
  Neighbor capabilities:
    Route refresh: advertised and received (old and new)
    4-Octet ASN Capability: advertised and received
    Address family IPv4 Unicast: advertised and received
  Received 45 messages, 0 notifications, 0 in queue
  Sent 47 messages, 0 notifications, 0 in queue
  Route refresh request: received 0, sent 0
  Minimum time between advertisement runs is 30 seconds
For address family: IPv4 Unicast
  BGP table version 3, neighbor version 3
  Index 1, Offset 0, Mask 0x2
  Community attribute sent to this neighbor (both)
  2 accepted prefixes
  0 announced prefixes
```

BGP

```
Connections established 1; dropped 0
Local host: 172.4.5.115, Local port: 179
Foreign host: 172.4.5.116, Foreign port: 58251
Nexthop: 172.4.5.115
Nexthop global: ::
Nexthop local: ::
BGP connection: non shared network
```

```
#show ip bgp vrf all
BGP table version is 1, local router ID is 172.3.4.117
Status codes: s suppressed, d damped, h history, * valid, > best, i - internal,
               l - labeled, S Stale
Origin codes: i - IGP, e - EGP, ? - incomplete
```

Network	Next Hop	Metric	LocPrf	Weight	Path
BGP Route Table for VRF VRF1					
*>i 50.1.1.0/24	172.6.7.116	0	100	0	?
*> 200.1.1.0	0.0.0.0	0	100	32768	?

Total number of prefixes 2

```
#show ip bgp summary vrf all
BGP router identifier 192.168.52.2, local AS number 100000
BGP table version is 3
1 BGP AS-PATH entries
0 BGP community entries
```

Neighbor PfxRcd	V	AS	MsgRcv	MsgSen	TblVer	InQ	OutQ	Up/Down	State/
172.4.5.116	4	200000	46	48	3	0	0	00:21:12	
2									

Total number of neighbors 1

Total number of Established sessions 1

```
#clear bgp *
2019 Mar 22 06:16:56.414 : NOS : BGP : CRITI : [BGP_OPR_NEIGH_STATE_DOWN_2]: Neighbour
[172.4.5.116] Session down due to peer clear
```

CE2

```
#show ip bgp vrf all
BGP table version is 4, local router ID is 192.168.52.4
Status codes: s suppressed, d damped, h history, * valid, > best, i - internal,
               l - labeled, S Stale
Origin codes: i - IGP, e - EGP, ? - incomplete
```

	Network	Next Hop	Metric	LocPrf	Weight	Path
*>	50.1.1.0/24	172.3.4.117	0	100	0	200000 ?
*>	200.1.1.0	172.3.4.117	0	100	0	200000 ?

Total number of prefixes 2

#show ip bgp summary vrf all

BGP router identifier 192.168.52.4, local AS number 300000

BGP table version is 4

1 BGP AS-PATH entries

0 BGP community entries

Neighbor PfxRcd	V	AS	MsgRcv	MsgSen	TblVer	InQ	OutQ	Up/Down	State/
172.3.4.117	4	200000	33	30	4	0	0	00:04:34	
2									

Total number of neighbors 1

Total number of Established sessions 1

#show ip bgp neighbors

BGP neighbor is 172.3.4.117, remote AS 200000, local AS 300000, external link

BGP version 4, local router ID 192.168.52.4, remote router ID 172.3.4.117

BGP state = Established, up for 00:04:40

Last read 00:00:10, hold time is 90, keepalive interval is 30 seconds

Neighbor capabilities:

Route refresh: advertised and received (old and new)

4-Octet ASN Capability: advertised and received

Address family IPv4 Unicast: advertised and received

Received 33 messages, 0 notifications, 0 in queue

Sent 29 messages, 1 notifications, 0 in queue

Route refresh request: received 0, sent 0

Minimum time between advertisement runs is 30 seconds

For address family: IPv4 Unicast

BGP table version 4, neighbor version 4

Index 1, Offset 0, Mask 0x2

Community attribute sent to this neighbor (both)

2 accepted prefixes

0 announced prefixes

Connections established 2; dropped 1

Local host: 172.3.4.114, Local port: 179

Foreign host: 172.3.4.117, Foreign port: 49361

Next hop: 172.3.4.114

Next hop global: ::

Next hop local: ::

BGP connection: non shared network

Last Reset: 00:04:40, due to BGP Notification sent

Notification Error Message: (Cease/Administratively Reset.)

Nexthop Tracking

Nexthop tracking is used to notify the BGP process asynchronously whenever there is any change in the IGP routes. It reduces the convergence time of BGP routes when IGP routes are changed.

Topology

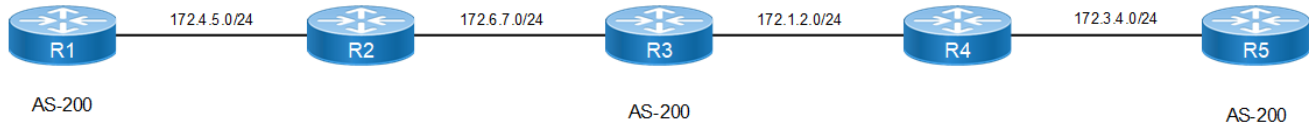

Figure 1-26: BGP Nexthop Tracking

R1

#configure terminal	Enter configure mode.
(config)#interface lo	Specify the loopback interface, and enter Interface mode.
(config-if)#ip address 100.100.100.100/32 secondary	Configure the IP address on this interface.
(config-if)#exit	Exit interface mode.
(config)#router bgp 200	Assign the ASN value (200) to the router. The ASN range is <1-65535>.
(config-router)#neighbor 200.200.200.200 remote-as 200	Specify the neighbor's IP address (200.200.200.200) and the ASN value of the neighbor (200).
(config-router)#neighbor 200.200.200.200 update-source lo	Specify the routing update source.
(config-router)# address-family ipv4 unicast	Enter address-family ipv4 unicast mode
(config-router-af)# neighbor 200.200.200.200 activate	Activate neighbor under address family mode
(config-router-af)# exit-address-family	Exit address family mode
(config-router)#exit	Exit Router mode, and return to Configure mode.
(config)#router ospf 1	Configure the OSPF process (1).
(config-router)#network 172.4.5.0/24 area 0	Advertise the network in Area 0.
(config-router)#redistribute connected	Redistribute the connected routes.
(config-router)#commit	Commit the candidate configuration to the running configuration.

R2

#configure terminal	Enter configure mode.
(config)#router ospf 1	Configure the OSPF process (1).
(config-router)#network 172.4.5.0/24 area 0	Advertise the network in Area 0.

(config-router)#network 172.6.7.0/24 area 0	Advertise the network in Area 0.
(config-router)#commit	Commit the candidate configuration to the running configuration.

R3

#configure terminal	Enter configure mode.
(config)#interface lo	Specify the loopback interface, and enter Interface mode.
(config-if) #ip address 150.150.150.150/32 secondary	Configure the IP address on this interface.
(config-if)#ip address 200.200.200.200/32 secondary	Configure the IP address on this interface.
(config-if)#exit	Exit interface mode.
(config)#router bgp 200	Assign the ASN value (200) to the router.
(config-router)#neighbor 100.100.100.100 remote-as 200	Specify the neighbor's IP address (100.100.100.100) and the ASN value of the neighbor (200).
(config-router)#neighbor 100.100.100.100 update-source 200.200.200.200	Specify the routing update source.
(config-router)#neighbor 220.220.220.220 remote-as 200	Specify the neighbor's IP address (220.220.220.220) and the ASN value of the neighbor (200).
(config-router)#neighbor 220.220.220.220 update-source 150.150.150.150	Specify the routing update source.
(config-router)# address-family ipv4 unicast	Enter address-family ipv4 unicast mode
(config-router-af) # neighbor 100.100.100.100 activate	Activate neighbor under address family mode
(config-router-af) # neighbor 220.220.220.220 activate	Activate neighbor under address family mode
(config-router-af) # exit-address-family	Exit address family mode
(config-router)#exit	Exit Router mode, and return to Configure mode.
(config)#router ospf 1	Configure the OSPF process (1).
(config-router)#network 172.6.7.0/24 area 0	Advertise the network in Area 0.
(config-router)#network 172.1.2.0/24 area 0	Advertise the network in Area 0.
(config-router)#redistribute connected	Redistribute the connected routes.
(config-router)#exit	Exit Router mode, and return to Configure mode.
(config)#bgp nexthop-trigger enable	Enable Nexthop tracking.
(config)#bgp nexthop-trigger delay 20	Configure the nexthop trigger-delay time interval.
(config-router)#commit	Commit the candidate configuration to the running configuration.

R4

#configure terminal	Enter configure mode.
(config)#router ospf 1	Configure the OSPF process (1).
(config-router)#network 172.1.2.0/24 area 0	Advertise the network in Area 0.

BGP

#configure terminal	Enter configure mode.
(config-router)#network 172.3.4.0/24 area 0	Advertise the network in Area 0.
(config-router)#commit	Commit the candidate configuration to the running configuration.

R5

#configure terminal	Enter configure mode.
(config)#interface lo	Specify the loopback interface, and enter Interface mode.
(config-if)#ip address 220.220.220.220/32 secondary	Configure the IP address on this interface.
(config-if)#exit	Exit interface mode.
(config)#router bgp 200	Assign the ASN value (200) to the router.
(config-router)#neighbor 150.150.150.150 remote-as 200	Specify the neighbor's IP address (150.150.150.150) and the ASN value of the neighbor (200).
(config-router)# address-family ipv4 unicast	Enter address-family ipv4 unicast mode
(config-router-af)# neighbor 150.150.150.150 activate	Activate neighbor under address family mode
(config-router)#commit	Commit the candidate configuration to the running configuration.
(config-router-af)# exit-address-family	Exit address family mode
#configure terminal	Enter configure mode.
(config)#interface lo	Specify the loopback interface, and enter Interface mode.
(config-if)#ip address 220.220.220.220/32 secondary	Configure the IP address on this interface.
(config-if)#exit	Exit interface mode.
(config-router)#neighbor 150.150.150.150 update-source lo	Specify the routing update source.
(config-router)#exit	Exit Router mode, and return to Configure mode.
(config)#router ospf 1	Configure the OSPF process (1).
(config-router)#network 172.3.4.0/24 area 0	Advertise the network in Area 0.
(config-router)#redistribute connected	Redistribute the connected routes.
(config-router)#commit	Commit the candidate configuration to the running configuration.

Validation

show ip bgp summary, show ip bgp neighbors, show bgp nexthop-tracking, show ip bgp scan

Nexthop Tracking Delay Timer

The delay interval between routing table walks can be configured for nexthop delay tracking. This time determines how long BGP waits before it starts walking the full BGP routing table after receiving notification from NSM about a next-hop change.

Topology

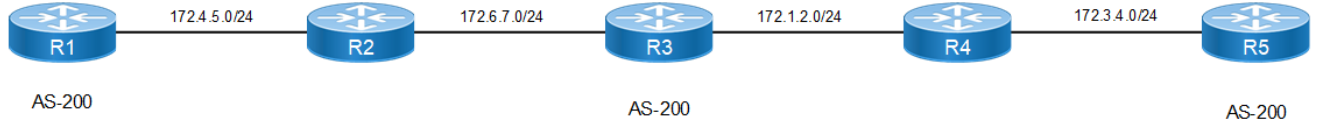

Figure 1-27: Topology for Nexthop Tracking Delay Timer

R1

#configure terminal	Enter configure mode.
(config)#interface lo	Specify the loopback interface, and enter Interface mode.
(config-if)#ip address 150.150.150.150/32 secondary	Configure the IP address on this interface.
(config-if)#ip address 100.100.100.100/32 secondary	Configure the IP address on this interface.
(config-if)#exit	Exit interface mode.
(config)#router bgp 200	Assign the ASN value (200) to the router. The ASN range is <1-65535>.
(config-router)#neighbor 200.200.200.200 remote-as 200	Specify the neighbor's IP address (200.200.200.200) and the ASN value of the neighbor (200).
(config-router)#neighbor 200.200.200.200 update-source lo	Specify the routing update source.
(config-router)# address-family ipv4 unicast	Enter address-family ipv4 unicast mode
(config-router-af) # neighbor 200.200.200.200 activate	Activate neighbor under address family mode
(config-router-af) # exit-address-family	Exit address family mode
#configure terminal	Enter configure mode.
(config)#interface lo	Specify the loopback interface, and enter Interface mode.
(config-if)#ip address 150.150.150.150/32 secondary	Configure the IP address on this interface.
(config-if)#ip address 100.100.100.100/32 secondary	Configure the IP address on this interface.
(config-if)#exit	Exit interface mode.
(config)#commit	Commit the candidate configuration to the running configuration.
(config)#router ospf 1	Configure the OSPF process (1).
(config-router)#network 172.4.5.0/24 area 0	Advertise the network in Area 0.
(config-router)#redistribute connected	Redistribute the connected routes.
(config-router)#commit	Commit the candidate configuration to the running configuration.

R2

#configure terminal	Enter configure mode.
(config)#router ospf 1	Configure the OSPF process (1).
(config-router)#network 172.4.5.0/24 area 0	Advertise the network in Area 0.

BGP

(config-router)#network 172.6.7.0/24 area 0	Advertise the network in Area 0.
(config-router)#commit	Commit the candidate configuration to the running configuration.

R3

#configure terminal	Enter configure mode.
(config)#interface lo	Specify the loopback interface, and enter Interface mode.
(config-if)#ip address 200.200.200.200/32	Configure the IP address on this interface.
(config-if)#exit	Exit interface mode.
(config)#router bgp 200	Assign the ASN value (200) to the router.
(config-router)#neighbor 100.100.100.100 remote-as 200	Specify the neighbor's IP address (100.100.100.100) and the ASN value of the neighbor (200).
(config-router)#neighbor 100.100.100.100 update-source 200.200.200.200	Specify the routing update source.
(config-router)#neighbor 220.220.220.220 remote-as 200	Specify the neighbor's IP address (220.220.220.220) and the ASN value of the neighbor (200).
(config-router)#neighbor 220.220.220.220 update-source 150.150.150.150	Specify the routing update source.
(config-router)# address-family ipv4 unicast	Enter address-family ipv4 unicast mode
(config-router-af)# neighbor 100.100.100.100 activate	Activate neighbor under address family mode
(config-router-af)# neighbor 220.220.220.220 activate	Activate neighbor under address family mode
(config-router-af)# exit-address-family	Exit address family mode
(config-router)#exit	Exit Router mode, and return to Configure mode.
(config)#router ospf 1	Configure the OSPF process (1).
(config-router)#network 172.6.7.0/24 area 0	Advertise the network in Area 0.
(config-router)#network 172.1.2.0/24 area 0	Advertise the network in Area 0.
(config-router)#redistribute connected	Redistribute the connected routes.
(config-router)#exit	Exit Router mode, and return to Configure mode.
(config-router)#commit	Commit the candidate configuration to the running configuration.
(config)#bgp nexthop-trigger enable	Enable nexthop tracking.
(config)#bgp nexthop-trigger delay 20	Configure the nexthop trigger-delay time interval.

R4

#configure terminal	Enter configure mode.
(config)#router ospf 1	Configure the OSPF process (1).
(config-router)#network 172.1.2.0/24 area 0	Advertise the network in Area 0.
(config-router)#network 172.3.4.0/24 area 0	Advertise the network in Area 0.
(config-router)#commit	Commit the candidate configuration to the running configuration.

R5

#configure terminal	Enter configure mode.
(config)#interface lo	Specify the loopback interface, and enter Interface mode.
(config-if)#ip address 220.220.220.220/32	Configure the IP address on this interface.
(config-if)#exit	Exit interface mode.
(config)#router bgp 200	Assign the ASN value (200) to the router.
(config-router)#neighbor 150.150.150.150 remote-as 200	Specify the neighbor's IP address (150.150.150.150) and the ASN value of the neighbor (200).
(config-router)#neighbor 150.150.150.150 update-source lo	Specify the routing update source.
(config-router)# address-family ipv4 unicast	Enter address-family ipv4 unicast mode
(config-router-af)# neighbor 150.150.150.150 activate	Activate neighbor under address family mode
(config-router-af)# exit-address-family	Exit address family mode
(config-router)#exit	Exit Router mode, and return to Configure mode.
(config)#router ospf 1	Configure the OSPF process (1).
(config-router)#network 172.3.4.0/24 area 0	Advertise the network in Area 0.
(config-router)#redistribute connected	Redistribute the connected routes.
(config-router)#commit	Commit the candidate configuration to the running configuration.

Validation**R1**

```
#show ip bgp summary
BGP router identifier 10.12.20.71, local AS number 200
BGP table version is 1
0 BGP AS-PATH entries
0 BGP community entries
```

Neighbor	Down	State/PfxRcd	V	AS	MsgRcv	MsgSen	TblVer	InQ	OutQ	Up/
200.200.200.200			4	200	15	16	1	0	0	
00:06:37			0							

Total number of neighbors 1

Total number of Established sessions 1

```
#show ip bgp neighbors
BGP neighbor is 200.200.200.200, remote AS 200, local AS 200, internal link
BGP version 4, local router ID 10.12.20.71, remote router ID 200.200.200.200
BGP state = Established, up for 00:06:40
Last read 00:06:40, hold time is 90, keepalive interval is 30 seconds
Neighbor capabilities:
  Route refresh: advertised and received (old and new)
  Address family IPv4 Unicast: advertised and received
Received 15 messages, 0 notifications, 0 in queue
Sent 16 messages, 0 notifications, 0 in queue
```

BGP

```
Route refresh request: received 0, sent 0
Minimum time between advertisement runs is 5 seconds
Update source is lo
For address family: IPv4 Unicast
BGP table version 1, neighbor version 1
Index 1, Offset 0, Mask 0x2
Community attribute sent to this neighbor (both)
0 accepted prefixes
0 announced prefixes
```

```
Connections established 1; dropped 0
Local host: 100.100.100.100, Local port: 37676
Foreign host: 200.200.200.200, Foreign port: 179
Next hop: 100.100.100.100
Next hop global: ::
Next hop local: ::
BGP connection: non shared network
```

```
#show bgp nexthop-tracking
Configured NHT: DISABLED
NHT Delay time-interval : 5
BGP VRF: (Default) VRF_ID 0
BGP Instance: (Default), AS: 200, router-id 10.12.20.71
```

```
#show ip bgp scan
BGP VRF: (Default) VRF_ID 0
BGP scan interval is 60
scan remain-time: 38
Current BGP nexthop cache:
```

R3

```
#show ip bgp summary
BGP router identifier 200.200.200.200, local AS number 200
BGP table version is 1
0 BGP AS-PATH entries
0 BGP community entries
```

Neighbor	V	AS	MsgRcv	MsgSen	TblVer	InQ	OutQ	Up/
Down State/PfxRcd								
100.100.100.100	4	200	17	19	1	0	0	
00:07:41	0							
220.220.220.220	4	200	95	101	1	0	0	
00:07:12	0							

```
Total number of neighbors 2
```

```
Total number of Established sessions 2
```

```
#show ip bgp neighbors
BGP neighbor is 100.100.100.100, remote AS 200, local AS 200, internal link
BGP version 4, local router ID 200.200.200.200, remote router ID 10.12.20.71
BGP state = Established, up for 00:07:46
Last read 00:07:46, hold time is 90, keepalive interval is 30 seconds
Neighbor capabilities:
Route refresh: advertised and received (old and new)
Address family IPv4 Unicast: advertised and received
Received 17 messages, 0 notifications, 0 in queue
```

```
Sent 19 messages, 0 notifications, 0 in queue
Route refresh request: received 0, sent 0
Minimum time between advertisement runs is 5 seconds
Update source is 200.200.200.200
For address family: IPv4 Unicast
BGP table version 1, neighbor version 1
Index 1, Offset 0, Mask 0x2
Community attribute sent to this neighbor (both)
0 accepted prefixes
0 announced prefixes

Connections established 1; dropped 0
Local host: 200.200.200.200, Local port: 179
Foreign host: 100.100.100.100, Foreign port: 37676
Nexthop: 200.200.200.200
Nexthop global: ::
Nexthop local: ::
BGP connection: non shared network

BGP neighbor is 220.220.220.220, remote AS 200, local AS 200, internal link
BGP version 4, remote router ID 220.220.220.220
local router ID 200.200.200.200
BGP state = Established, up for 00:07:17
Last read 00:07:17, hold time is 90, keepalive interval is 30 seconds
Neighbor capabilities:
  Route refresh: advertised and received (old and new)
  Address family IPv4 Unicast: advertised and received
Received 94 messages, 1 notifications, 0 in queue
Sent 97 messages, 4 notifications, 0 in queue
Route refresh request: received 0, sent 0
Minimum time between advertisement runs is 5 seconds
Update source is 150.150.150.150
For address family: IPv4 Unicast
BGP table version 1, neighbor version 1
Index 2, Offset 0, Mask 0x4
Community attribute sent to this neighbor (both)
0 accepted prefixes
0 announced prefixes

Connections established 6; dropped 5
Local host: 150.150.150.150, Local port: 39831
Foreign host: 220.220.220.220, Foreign port: 179
Nexthop: 150.150.150.150
Nexthop global: ::
Nexthop local: ::
BGP connection: non shared network
Last Reset: 00:07:22, due to BGP Notification received
Notification Error Message: (Cease/Other Configuration Change.)

#show bgp nexthop-tracking
Configured NHT: ENABLED
NHT Delay time-interval : 20
BGP VRF: (Default) VRF_ID 0
BGP Instance: (Default), AS: 200, router-id 200.200.200.200
NHT is Enabled
Rcvd Msg count from RIB: 0
NHT delay-timer remaining seconds: 0
```

BGP

```
BGP nexthop(s):
Total number of IPV4 nexthops : 0
Total number of IPV6 nexthops : 0
```

```
#show ip bgp scan
BGP VRF: (Default) VRF_ID 0
BGP scan interval is 60
scan remain-time: 11
Current BGP nexthop cache:
```

R5

```
#show ip bgp summary
BGP router identifier 220.220.220.220, local AS number 200
BGP table version is 1
0 BGP AS-PATH entries
0 BGP community entries
```

Neighbor	V	AS	MsgRcv	MsgSen	TblVer	InQ	OutQ	Up/
Down State/PfxRcd								
150.150.150.150	4	200	99	101	1	0	0	
00:08:26	0							

```
Total number of neighbors 1
```

```
Total number of Established sessions 1
```

```
#show ip bgp neighbors
BGP neighbor is 150.150.150.150, remote AS 200, local AS 200, internal link
BGP version 4, local router ID 220.220.220.220, remote router ID
200.200.200.200
```

```
BGP state = Established, up for 00:08:29
Last read 00:08:29, hold time is 90, keepalive interval is 30 seconds
Neighbor capabilities:
```

```
Route refresh: advertised and received (old and new)
Address family IPv4 Unicast: advertised and received
Received 96 messages, 3 notifications, 0 in queue
Sent 99 messages, 2 notifications, 0 in queue
Route refresh request: received 0, sent 0
Minimum time between advertisement runs is 5 seconds
Update source is lo
```

```
For address family: IPv4 Unicast
BGP table version 1, neighbor version 1
Index 1, Offset 0, Mask 0x2
Community attribute sent to this neighbor (both)
0 accepted prefixes
0 announced prefixes
```

```
Connections established 6; dropped 5
Local host: 220.220.220.220, Local port: 179
Foreign host: 150.150.150.150, Foreign port: 39831
Nexthop: 220.220.220.220
Nexthop global: ::
Nexthop local: ::
BGP connection: non shared network
Last Reset: 00:08:34, due to BGP Notification sent
Notification Error Message: (Cease/Other Configuration Change.)
```

```
#show bgp nexthop-tracking
Configured NHT: DISABLED
NHT Delay time-interval : 5
BGP VRF: (Default) VRF_ID 0
BGP Instance: (Default), AS: 200, router-id 220.220.220.220
```

```
#show ip bgp scan
BGP VRF: (Default) VRF_ID 0
BGP scan interval is 60
scan remain-time: 22
Current BGP nexthop cache:
```

BGP Distance

Administrative distance in BGP can be configured for a specific address family.

Topology

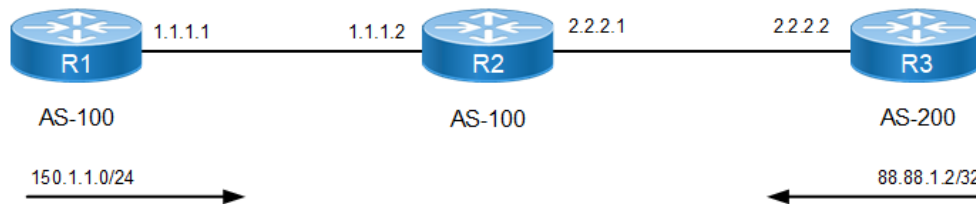

Figure 1-28: Administrative Distance for IPv4 BGP

R1

#configure terminal	Enter configure mode.
(config)#interface lo	Enter loopback interface mode.
(config-if)#ip address 150.1.1.1/24 secondary	Specify IP address for the interface.
(config-if)#exit	Exit loopback interface mode.
(config)#router bgp 100	Assign the ASN value (100) to the router.
(config-router)#neighbor 1.1.1.2 remote-as 100	Specify the neighbor's IP address and ASN value.
(config-router)#address-family ipv4 unicast	Enter address-family ipv4 unicast mode
(config-router-af)#neighbor 1.1.1.2 activate	Activate the neighbor in address family mode
(config-router-af)#network 150.1.1.0/24	Specify the network to be advertised by the BGP routing process.
(config-router-af)#exit-address-family	Exit address-family ipv4 unicast mode
(config-router)#commit	Commit the candidate configuration to the running configuration.

R2

#configure terminal	Enter configure mode.
(config)#router bgp 100	Assign the ASN value (100) to the router.

BGP

(config-router)#neighbor 2.2.2.2 remote-as 200	Specify the neighbor's IP address and ASN value.
(config-router)#neighbor 1.1.1.1 remote-as 100	Specify the neighbor's IP address and the ASN value of another neighbor.
(config-router)# address-family ipv4 unicast	Enter address-family ipv4 unicast mode
(config-router-af)#distance bgp 12 13 120	Configure the administrative distance for external, internal, and local routes received.
(config-router-af)#aggregate-address 150.1.0.0/16 summary-only	Configure a non-AS-set aggregate route on R2. The local distance is applied to this route.
(config-router-af)#neighbor 1.1.1.1 activate	Activate the neighbor in address family mode
(config-router-af)#neighbor 2.2.2.2 activate	Activate the neighbor in address family mode
(config-router-af)#exit-address-family	Exit address-family ipv4 unicast mode
(config-router)#commit	Commit the candidate configuration to the running configuration.

R3

#configure terminal	Enter configure mode.
(config)#interface lo	Enter loopback interface mode.
(config-if)#ip address 88.88.1.2/32 secondary	Specify IP address for the interface.
(config-if)#exit	Exit loopback interface mode.
(config)#router bgp 200	Assign the ASN value (200) to the router.
(config-router)#neighbor 2.2.2.1 remote-as 100	Specify the neighbor's IP address and ASN value.
(config-router)#address-family ipv4 unicast	Enter address-family ipv4 unicast mode
(config-router-af)#network 88.88.1.2/32	Specify the network to be advertised by the BGP routing process.
(config-router-af)#neighbor 2.2.2.1 activate	Activate the neighbor in address family mode
(config-router-af)#exit-address-family	Exit address-family ipv4 unicast mode
(config-router)#commit	Commit the candidate configuration to the running configuration.

Validation

```
#show ip bgp summary
BGP router identifier 192.168.56.102, local AS number 100
BGP table version is 7
2 BGP AS-PATH entries
0 BGP community entries
```

Neighbor	Down	State/PfxRcd	V	AS	MsgRcv	MsgSen	TblVer	InQ	OutQ	Up/
1.1.1.1			4	100	8	9	7	0	0	
00:02:39			1							
2.2.2.2			4	200	4	4	7	0	0	
00:00:38			1							

```
Total number of neighbors 2
```

```
Total number of Established sessions 2
#show ip bgp neighbors
BGP neighbor is 1.1.1.1, remote AS 100, local AS 100, internal link
  BGP version 4, local router ID 192.168.52.3, remote router ID 150.1.1.1
  BGP state = Established, up for 00:02:54
  Last read 00:02:54, hold time is 90, keepalive interval is 30 seconds
  Neighbor capabilities:
    Route refresh: advertised and received (old and new)
    Address family IPv4 Unicast: advertised and received
  Received 8 messages, 0 notifications, 0 in queue
  Sent 9 messages, 0 notifications, 0 in queue
  Route refresh request: received 0, sent 0
  Minimum time between advertisement runs is 5 seconds
For address family: IPv4 Unicast
  BGP table version 7, neighbor version 7
  Index 2, Offset 0, Mask 0x4
  Community attribute sent to this neighbor (both)
  1 accepted prefixes
  0 announced prefixes

Connections established 1; dropped 0
Local host: 1.1.1.2, Local port: 49238
Foreign host: 1.1.1.1, Foreign port: 179
Nexthop: 1.1.1.2
Nexthop global: fe80::a00:27ff:fea6:6e3
Nexthop local: ::
BGP connection: non shared network

BGP neighbor is 2.2.2.2, remote AS 200, local AS 100, external link
  BGP version 4, remote router ID 88.88.1.2
  local router ID 192.168.52.3
  BGP state = Established, up for 00:00:53
  Last read 00:00:53, hold time is 90, keepalive interval is 30 seconds
  Neighbor capabilities:
    Route refresh: advertised and received (old and new)
    Address family IPv4 Unicast: advertised and received
  Received 4 messages, 0 notifications, 0 in queue
  Sent 4 messages, 0 notifications, 0 in queue
  Route refresh request: received 0, sent 0
  Minimum time between advertisement runs is 30 seconds
For address family: IPv4 Unicast
  BGP table version 7, neighbor version 7
  Index 1, Offset 0, Mask 0x2
  Community attribute sent to this neighbor (both)
  1 accepted prefixes
  0 announced prefixes

Connections established 1; dropped 0
Local host: 2.2.2.1, Local port: 179
Foreign host: 2.2.2.2, Foreign port: 50072
Nexthop: 2.2.2.1
Nexthop global: fe80::a00:27ff:fe77:264e
Nexthop local: ::
BGP connection: non shared network

#show ip route database bgp
IP Route Table for VRF "default"
```

```
B    *> 88.88.1.2/32 [12/0] via 2.2.2.2, eth2, 00:01:19
B    *> 150.1.0.0/16 [120/0] is a summary, Null, 00:02:49
B    *> 150.1.1.0/24 [200/0] via 1.1.1.1, eth1, 00:02:49
```

Gateway of last resort is not set

```
#show ip route database
```

```
Codes: K - kernel, C - connected, S - static, R - RIP, B - BGP
       O - OSPF, IA - OSPF inter area
       N1 - OSPF NSSA external type 1, N2 - OSPF NSSA external type 2
       E1 - OSPF external type 1, E2 - OSPF external type 2
       i - IS-IS, L1 - IS-IS level-1, L2 - IS-IS level-2,
       ia - IS-IS inter area, E - EVPN,
       v - vrf leaked
       > - selected route, * - FIB route, p - stale info
```

IP Route Table for VRF "default"

```
C    *> 1.1.1.0/24 is directly connected, eth1, 00:13:39
C    *> 2.2.2.0/24 is directly connected, eth3, 00:13:04
B    *> 88.88.1.2/32 [12/0] via 2.2.2.2, eth3, 00:06:37
C    *> 127.0.0.0/8 is directly connected, lo, 00:22:15
B    *> 150.1.0.0/16 [120/0] is a summary, Null, 00:11:19
B    *> 150.1.1.0/24 [200/0] via 1.1.1.1, eth1, 00:11:19
C    *> 192.168.52.0/24 is directly connected, eth0, 00:22:13
```

Gateway of last resort is not set

```
#show ip route
```

```
Codes: K - kernel, C - connected, S - static, R - RIP, B - BGP
       O - OSPF, IA - OSPF inter area
       N1 - OSPF NSSA external type 1, N2 - OSPF NSSA external type 2
       E1 - OSPF external type 1, E2 - OSPF external type 2
       i - IS-IS, L1 - IS-IS level-1, L2 - IS-IS level-2,
       ia - IS-IS inter area, E - EVPN,
       v - vrf leaked
       * - candidate default
```

IP Route Table for VRF "default"

```
C    1.1.1.0/24 is directly connected, eth1, 00:17:38
C    2.2.2.0/24 is directly connected, eth3, 00:17:03
B    88.88.1.2/32 [12/0] via 2.2.2.2, eth3, 00:10:36
C    127.0.0.0/8 is directly connected, lo, 00:26:14
B    150.1.0.0/16 [120/0] is a summary, Null, 00:15:18
B    150.1.1.0/24 [200/0] via 1.1.1.1, eth1, 00:15:18
C    192.168.52.0/24 is directly connected, eth0, 00:26:12
```

Gateway of last resort is not set

```
#show ip bgp
```

```
BGP table version is 4, local router ID is 192.168.52.3
```

```
Status codes: s suppressed, d damped, h history, * valid, > best, i -
internal,
```

```
l - labeled, S Stale
```

```
Origin codes: i - IGP, e - EGP, ? - incomplete
```

	Network	Next Hop	Metric	LocPrf	Weight	Path
*>	88.88.1.2/32	2.2.2.2	0	100	0	200
i						

```
*> 150.1.0.0      0.0.0.0      0      100      32768      i
s>i 150.1.1.0/24  1.1.1.1      0      100      0          i
```

Total number of prefixes 3

BGP Weight per Peer

A different weight can be assigned per address family of a peer. For example, a system can be configured to prefer VPN4 routes from peer A and IPv4 routes from peer B.

If the neighbor weight command is given under a specific address-family mode, the peer weight is set for that specific address family. If the address family is not specifically set, the weight is updated for the default address-family.

Topology

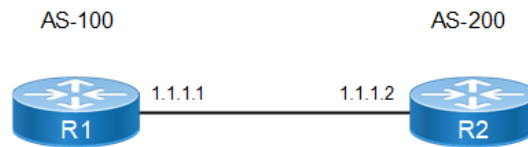

Figure 1-29: BGP Weight Per Peer

R1

#configure terminal	Enter configure mode.
(config)#router bgp 100	Assign the ASN value (100) to the router.
(config-router)#neighbor 1.1.1.2 remote-as 200	Specify the neighbor's IP address and ASN value.
(config-router)#address-family ipv4 unicast	Enter address-family ipv4 unicast mode
(config-router-af)#neighbor 1.1.1.2 activate	Activate the neighbor in address family mode
(config-router-af)#exit-address-family	Exit address-family ipv4 unicast mode
(config-router)#commit	Commit the candidate configuration to the running configuration.

R2

#configure terminal	Enter configure mode.
(config)#router bgp 200	Assign the ASN value (200) to the router.
(config-router)#neighbor 1.1.1.1 remote-as 100	Specify the neighbor's IP address and ASN value.
(config-router)# address-family ipv4 unicast	Enter address-family ipv4 unicast mode
(config-router-af)#neighbor 1.1.1.1 weight 500	Add a weight of 500 to all the routes coming from the neighbor, 1.1.1.1 (only IPv4 routes).
(config-router-af)#neighbor 1.1.1.1 activate	Activate the neighbor in address family mode
(config-router-af)#exit-address-family	Exit address-family ipv4 unicast mode
(config-router)#commit	Commit the candidate configuration to the running configuration.

Validation

R1

```
#show ip bgp summary
BGP router identifier 192.168.56.101, local AS number 100
BGP table version is 1
0 BGP AS-PATH entries
0 BGP community entries
Neighbor V AS MsgRcv MsgSen TblVer InQ OutQ Up/Dow
n State/PfxRcd
1.1.1.2 4 200 6 7 1 0 0 00:02:00
0
Total number of neighbors 1
Total number of Established sessions 1

#show ip bgp neighbors
BGP neighbor is 1.1.1.2, remote AS 200, local AS 100, external link
  BGP version 4, local router ID 192.168.52.2, remote router ID 192.168.52.3
  BGP state = Established, up for 00:01:17
  Last read 00:00:17, hold time is 90, keepalive interval is 30 seconds
  Neighbor capabilities:
    Route refresh: advertised and received (old and new)
    Address family IPv4 Unicast: advertised and received
  Received 4 messages, 0 notifications, 0 in queue
  Sent 5 messages, 0 notifications, 0 in queue
  Route refresh request: received 0, sent 0
  Minimum time between advertisement runs is 30 seconds
For address family: IPv4 Unicast
  BGP table version 1, neighbor version 1
  Index 1, Offset 0, Mask 0x2
  Community attribute sent to this neighbor (both)
  0 accepted prefixes
  0 announced prefixes

  Connections established 1; dropped 0
Local host: 1.1.1.1, Local port: 179
Foreign host: 1.1.1.2, Foreign port: 34619
Nexthop: 1.1.1.1
Nexthop global: ::
Nexthop local: ::
BGP connection: non shared network

#show ip route
Codes: K - kernel, C - connected, S - static, R - RIP, B - BGP
       O - OSPF, IA - OSPF inter area
       N1 - OSPF NSSA external type 1, N2 - OSPF NSSA external type 2
       E1 - OSPF external type 1, E2 - OSPF external type 2
       i - IS-IS, L1 - IS-IS level-1, L2 - IS-IS level-2,
       ia - IS-IS inter area, E - EVPN,
       v - vrf leaked
       * - candidate default

IP Route Table for VRF "default"
C      1.1.1.0/24 is directly connected, eth1, 00:09:10
C      127.0.0.0/8 is directly connected, lo, 00:15:56
```

C 192.168.52.0/24 is directly connected, eth0, 00:15:52

Gateway of last resort is not set

R2

```
#show ip bgp summary
BGP router identifier 192.168.56.102, local AS number 200
BGP table version is 1
0 BGP AS-PATH entries
0 BGP community entries
Neighbor V AS MsgRcv MsgSen TblVer InQ OutQ Up/Dow
n State/PfxRcd
1.1.1.1 4 100 3 3 1 0 0 00:00:34
0
Total number of neighbors 1
Total number of Established sessions 1
```

```
#show ip bgp neighbors
BGP neighbor is 1.1.1.1, remote AS 100, local AS 200, external link
  BGP version 4, local router ID 192.168.52.3, remote router ID 192.168.52.2
  BGP state = Established, up for 00:07:14
  Last read 00:00:14, hold time is 90, keepalive interval is 30 seconds
  Neighbor capabilities:
    Route refresh: advertised and received (old and new)
    Address family IPv4 Unicast: advertised and received
  Received 16 messages, 0 notifications, 0 in queue
  Sent 16 messages, 0 notifications, 0 in queue
  Route refresh request: received 0, sent 0
  Minimum time between advertisement runs is 30 seconds
For address family: IPv4 Unicast
  BGP table version 1, neighbor version 1
  Index 1, Offset 0, Mask 0x2
  Community attribute sent to this neighbor (both)
  Weight500
  0 accepted prefixes
  0 announced prefixes

Connections established 1; dropped 0
Local host: 1.1.1.2, Local port: 34619
Foreign host: 1.1.1.1, Foreign port: 179
Nexthop: 1.1.1.2
Nexthop global: ::
Nexthop local: ::
BGP connection: non shared network
```

```
#show ip route
Codes: K - kernel, C - connected, S - static, R - RIP, B - BGP
       O - OSPF, IA - OSPF inter area
       N1 - OSPF NSSA external type 1, N2 - OSPF NSSA external type 2
       E1 - OSPF external type 1, E2 - OSPF external type 2
       i - IS-IS, L1 - IS-IS level-1, L2 - IS-IS level-2,
       ia - IS-IS inter area, E - EVPN,
       v - vrf leaked
       * - candidate default
```

```
IP Route Table for VRF "default"
C    1.1.1.0/24 is directly connected, eth1, 00:11:26
C    127.0.0.0/8 is directly connected, lo, 00:21:36
C    192.168.52.0/24 is directly connected, eth0, 00:21:32
```

Gateway of last resort is not set

OSPF as PE-CE Protocol for VPNs

In an MPLS VPN environment, customer networks are connected to an MPLS VPN-enabled provider backbone. As shown in [Figure 1-30](#), Customer A areas, Areas 0 and 1, are connected to an MPLS VPN-enabled provider network. Area 0 and Area 1 have routers CE1 and CE2 running OSPF. MP-iBGP is used between PE1 and PE2 to propagate routes between Site 1 (Area 0) and Site 2 (Area 1). Traditional OSPF-BGP redistribution is performed at PE routers, PE1 and PE2. In this case, routes distributed by CE1 into the MP-iBGP cloud are sent to CE2 as external routes, even though both CE1 and CE2 belong to the same customer.

This behavior can be changed with the additional domain ID configuration. Each VRF should be configured a domain ID on the PE routers. If a PE router gets a route through the MP-iBGP cloud and has to send to any customer site, it checks the domain ID value against the list of stored domain ID values. If the incoming domain ID matches any of the stored IDs, that route is inserted into the customer site with the same type, as it was inserted into the MP-BGP cloud; otherwise, it is inserted as external route.

Topology

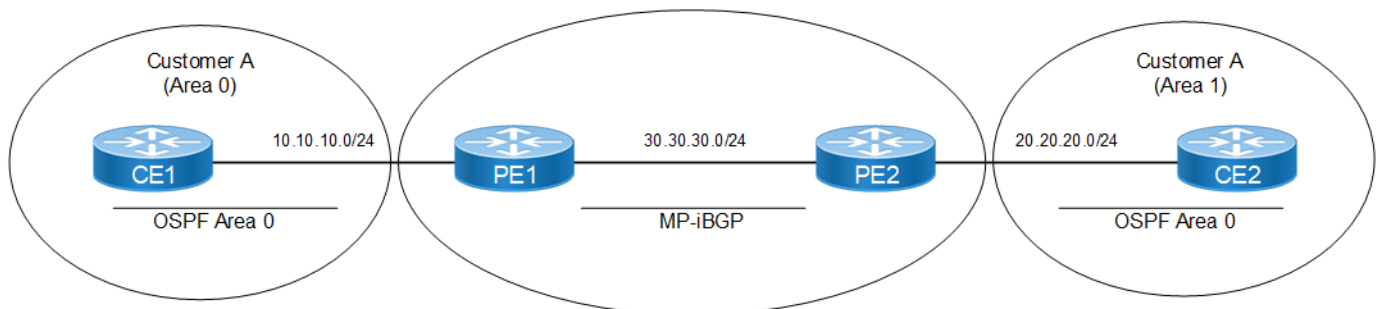

Figure 1-30: OSPF as PE-CE Protocol

Configuration

CE1

#configure terminal	Enter configure mode
(config)#interface lo	Enter loopback interface mode
(config-if)#ip address 60.1.1.1/24 secondary	Specify IP address for the interface
(config-if)#exit	Exit loopback interface mode
(config)#router ospf 1	Configure the routing process and specify the Process ID (1).
(config-router)#network 10.10.10.0/24 area 0	Advertise the network in OSPF

(config-router)#network 60.1.1.0/24 area 0	Advertise the loopback IP address in area 0 of router OSPF 1.
(config-router)#commit	Commit the candidate configuration to the running configuration.

PE1

#configure terminal	Enter configure mode.
(config)#ip vrf ABC	Specify the name of the VRF (ABC) to be created.
(config-vrf)#rd 10:100	Assign a route distinguisher (RD) for the VRF, which is a unique value on the router. The RD value can be in ASN:NN or A.B.C.D:NN format.
(config-vrf)#route-target both 10:100	Specify the 2-Octet AS specific or IPv4 specific Transitive Route-Target extended community attribute.
(config-vrf)#exit	Exit VRF mode, and return to Configure mode.
(config)#interface eth1	Enter interface mode.
(config-if)#ip vrf forwarding ABC	Associate interface eth1 to vrf ABC.
(config-if)#exit	Exit interface mode.
(config)#router ospf 1 ABC	Configure OSPF for VRF.
(config-router)#network 10.10.10.0/24 area 0	Advertise the network for OSPF adjacency with CE1.
(config-router)#domain-id 1.1.1.1	Configure the primary domain ID.
(config-router)#domain-id 2.2.2.2 secondary	Configure a secondary domain ID.
(config-router)#domain-id 3.3.3.3 secondary	Configure a secondary domain ID.
(config-router)#exit	Exit Router mode and return to Configure mode.
(config)#router bgp 100	Assign the ASN value (100) to the BGP router.
(config-router)#neighbor 30.30.30.2 remote-as 100	Configure neighbor 30.30.30.2 for iBGP.
(config-router)#address-family vpnv4 unicast	Enter Address-Family-VPNv4 mode.
(config-router-af)#neighbor 30.30.30.2 activate	Activate neighbor 30.30.30.2.
(config-router-af)#exit-address-family	Exit Address Family mode and return to Router mode.
(config-router)#address-family ipv4 vrf ABC	Enter Address-Family-VRF mode.
(config-router-af)#redistribute ospf	Specify redistributing routes from OSPF into BGP.
(config-router-af)#exit-address-family	Exit Address Family mode and return to Router mode.
(config-router)#commit	Commit the candidate configuration to the running configuration.

PE2

#configure terminal	Enter configure mode.
(config)#ip vrf ABC	Specify the name of the VRF (ABC) to be created.
(config-vrf)#rd 10:100	Assign a route distinguisher (RD) for the VRF, which is a unique value on the router. The RD value can be in ASN:NN or A.B.C.D:NN format.
(config-vrf)#route-target both 10:100	Specify the 2-Octet AS specific or IPv4 specific Transitive Route-Target extended community attribute.

BGP

(config-vrf)#exit	Exit VRF mode, and return to Configure mode.
(config)#interface eth1	Enter interface mode.
(config-if)#ip vrf forwarding ABC	Associate interface eth1 to vrf ABC.
(config-if)#exit	Exit interface mode.
(config)#commit	Commit the candidate configuration to the running configuration.
(config)#router ospf 1 ABC	Configure OSPF for VRF.
(config-router)#network 20.20.20.0/24 area 0	Advertise the network for OSPF adjacency with CE1.
(config-router)#domain-id 1.1.1.1	Configure the primary domain ID.
(config-router)#domain-id 2.2.2.2 secondary	Configure a secondary domain ID.
(config-router)#domain-id 3.3.3.3 secondary	Configure a secondary domain ID.
(config-router)#exit	Exit Router mode and return to Configure mode.
(config)#commit	Commit the candidate configuration to the running configuration.
(config)#router bgp 100	Assign the ASN value (100) to the BGP router.
(config-router)#neighbor 30.30.30.1 remote-as 100	Configure neighbor 30.30.30.1 for iBGP.
(config-router)#address-family vpnv4 unicast	Enter Address-Family-VPNv4 mode.
(config-router-af)#neighbor 30.30.30.1 activate	Activate neighbor 30.30.30.1.
(config-router-af)#exit-address-family	Exit Address Family mode and return to Router mode.
(config-router)#address-family ipv4 vrf ABC	Enter Address-Family-VRF mode.
(config-router-af)#redistribute ospf	Specify redistributing routes from OSPF into BGP.
(config-router-af)#exit-address-family	Exit Address Family mode and return to Router mode.
(config-router)#commit	Commit the candidate configuration to the running configuration.

CE2

#configure terminal	Enter configure mode.
(config)#router ospf 1	Configure the routing process, and specify the Process ID (1).
(config-router)#network 20.20.20.0/24 area 0	Advertise the network in OSPF.
(config-router)#commit	Commit the candidate configuration to the running configuration.

Validation

```
#show ip bgp vpnv4 all
Status codes: s suppressed, d damped, h history, * valid, > best, i -
internal, l - labeled
              S Stale
Origin codes: i - IGP, e - EGP, ? - incomplete

   Network          Next Hop           Metric      LocPrf      Weight Path
Route Distinguisher: 10:100 (Default for VRF ABC)
*>  10.10.10.0/24    0.0.0.0             2           100         32768      ?
```

```
*> 60.1.1.1/32      10.10.10.1      12      100      32768    ?
Announced routes count = 2
Accepted routes count = 0
#
```

BGP Multipath for IPv4

BGP supports multipath for IPv4 prefixes. BGP Multipath allows load-balancing traffic among multiple BGP routes. It supports both iBGP and eBGP routes. In case of eBGP, the routes should arrive from same AS number.

Topology

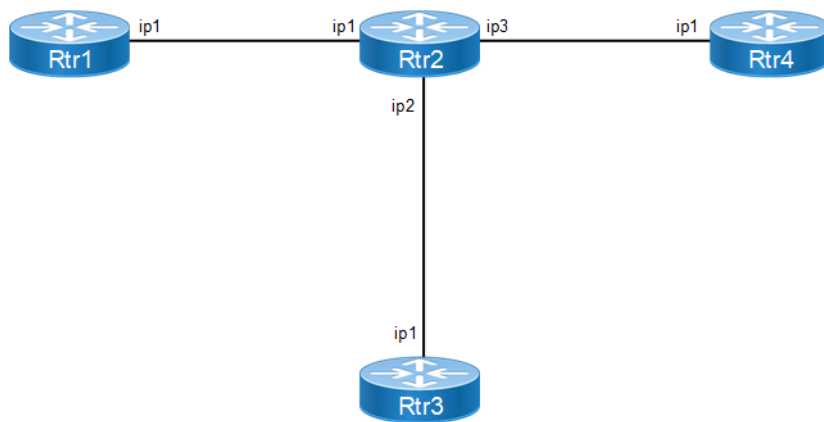

Figure 1-31: Multipath iBGP for IPv4

Configuration

Rtr1

#configure terminal	Enter the Configure mode.
(config)#router bgp 100	Assign the ASN value (100) to the BGP router.
(config-router)#bgp router-id 2.2.2.2	Configure a fixed Router ID (2.2.2.2).
(config-router)#neighbor 30.30.30.9 remote-as 100	Configure neighbor 30.30.30.9 for iBGP.
(config-router)# address-family ipv4 unicast	.Under address family, Redistribute the static routes.
(config-router-af)#redistribute static	Redistribute the static routes.
config-router-af)# neighbor 30.30.30.9 activate	Activate the neighbor
(config-router-af)#exit-address-family	Exit address-family mode.
(config-router)#exit	Exit the BGP Router mode and return to the Configure mode.
(config)#ip route 88.88.0.0/16 Null	Configure static route.
(config)#commit	Commit the candidate configuration to the running configuration.

Rtr3

#configure terminal	Enter the Configure mode.
(config)#router bgp 100	Assign the ASN value (100) to the BGP router.
(config-router)#bgp router-id 4.4.4.4	Configure a fixed Router ID (4.4.4.4).
(config-router)#neighbor 40.40.40.9 remote-as 100	Configure neighbor 40.40.40.9 for iBGP.
(config-router)# address-family ipv4 unicast	Enter address-family ipv4 unicast mode
(config-router-af)#redistribute static	Redistribute the static routes.
config-router-af)# neighbor 40.40.40.9 activate	Activate the neighbor
(config-router-af)#exit-address-family	Exit address-family mode
(config-router)#exit	Exit the BGP Router mode and return to the Configure mode.
(config)#ip route 88.88.0.0/16 Null	Configure static route.
(config)#commit	Commit the candidate configuration to the running configuration.

Rtr4

#configure terminal	Enter the Configure mode.
(config)#router bgp 100	Assign the ASN value (100) to the BGP router.
(config-router)#bgp router-id 6.6.6.6	Configure a fixed Router ID (6.6.6.6).
(config-router)#neighbor 50.50.50.9 remote-as 100	Configure neighbor 50.50.50.9 for iBGP.
(config-router)# address-family ipv4 unicast	Enter address-family ipv4 unicast mode
(config-router-af)#redistribute static	Redistribute the static routes.
config-router-af)# neighbor 50.50.50.9 activate	Activate the neighbor
(config-router-af)#exit-address-family	Exit address-family mode
(config-router)#exit	Exit the BGP Router mode and return to the Configure mode.
(config)#ip route 88.88.0.0/16 Null	Configure static route.
(config-router)#commit	Commit the candidate configuration to the running configuration.

Rtr2

#configure terminal	Enter the Configure mode.
(config)#router bgp 100	Assign the ASN value (100) to the BGP router.
(config)#bgp router-id 9.9.9.9	Configure a fixed Router ID (9.9.9.9).
(config-router)#neighbor 30.30.30.2 remote-as 100	Configure neighbor 30.30.30.2 for iBGP.
(config-router)#neighbor 40.40.40.4 remote-as 100	Configure neighbor 40.40.40.4 for iBGP.
(config-router)#neighbor 50.50.50.6 remote-as 100	Configure neighbor 50.50.50.6 for iBGP.

(config-router)#address-family ipv4 unicast	Enter address-family ipv4 unicast mode
config-router-af)# neighbor 30.30.30.2 activate	Activate the neighbor
config-router-af)# neighbor 40.40.40.4 activate	Activate the neighbor
config-router-af)# neighbor 50.50.50.6 activate	Activate the neighbor
config-router-af)# max-paths ibgp 2	Configure iBGP max-paths (2).
(config-router-af)#exit-address-family	Exit address-family mode
(config-router)#commit	Commit the candidate configuration to the running configuration.

Validation

```
#show ip bgp 88.88.0.0
BGP routing table entry for 88.88.0.0/16
Paths: (3 available, best #1, table Default-IP-Routing-Table) Not advertised to any peer
Local
30.30.30.2 from 30.30.30.2 (2.2.2.2)
Origin incomplete, metric 0, localpref 100, valid, internal, multipath- candidate,
installed, best
Last update: Wed Mar2 15:17:38 2016
```

```
Local
50.50.50.6 from 50.50.50.6 (6.6.6.6)
Origin incomplete, metric 0, localpref 100, valid, internal, multipath- candidate
Last update: Wed Mar2 15:23:58 2016
```

```
Local
40.40.40.4 from 40.40.40.4 (4.4.4.4)
Origin incomplete, metric 0, localpref 100, valid, internal, multipath- candidate,
installed
Last update: Wed Mar2 15:21:45 2016
```

```
#show ip route
Codes: K - kernel, C - connected, S - static, R - RIP, B - BGP O - OSPF, IA - OSPF inter
area
N1 - OSPF NSSA external type 1, N2 - OSPF NSSA external type 2 E1 - OSPF external type
1, E2 - OSPF external type 2
i - IS-IS, L1 - IS-IS level-1, L2 - IS-IS level-2,
ia - IS-IS inter area, E - EVPN, v - vrf leaked
* - candidate default
```

```
IP Route Table for VRF "default"
C 30.30.30.0/24 is directly connected, eth1, 00:15:04 C 40.40.40.0/24 is directly
connected, eth6, 00:14:30 C 50.50.50.0/24 is directly connected, eth3, 00:14:46 B
88.88.0.0/16 [200/0] via 40.40.40.4, eth6, 00:02:58
[200/0] via 30.30.30.2, eth1
C 127.0.0.0/8 is directly connected, lo, 00:19:21
C 192.168.52.0/24 is directly connected, eth0, 00:19:16 Gateway of last resort is not
set
```

BGP

Gateway of last resort is not set

```
#show running-config router bgp
!  
router bgp 100  
  
bgp router-id 9.9.9.9  
neighbor 30.30.30.2 remote-as 100  
neighbor 40.40.40.4 remote-as 100  
neighbor 50.50.50.6 remote-as 100  
  
!  
address-family ipv4 unicast  
max-paths ibgp 2  
  
neighbor 30.30.30.2 activate  
neighbor 40.40.40.4 activate  
neighbor 50.50.50.6 activate  
exit-address-family  
!
```

Multipath eBGP

Topology

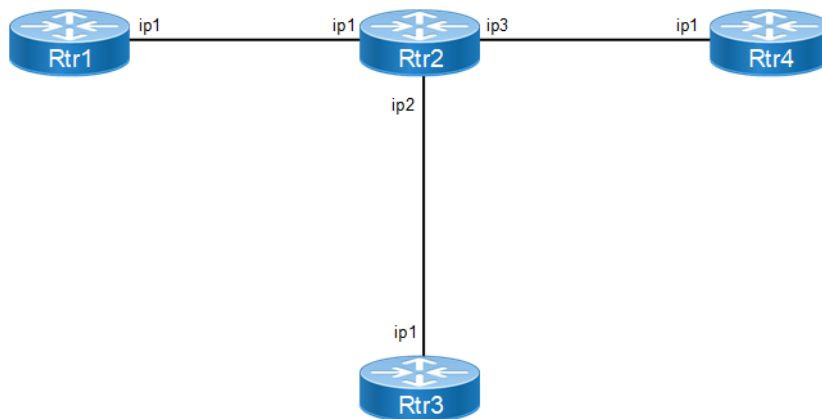

Figure 1-32: Multipath eBGP for IPv4

Configuration

Rtr1

#configure terminal	Enter the Configure mode.
(config)#router bgp 200	Assign the ASN value (200) to the BGP router.
(config-router)#bgp router-id 2.2.2.2	Configure a fixed Router ID (2.2.2.2).

(config-router)#neighbor 30.30.30.9 remote-as 100	Configure neighbor 30.30.30.9 for eBGP.
(config-router)# address-family ipv4 unicast	Enter address-family ipv4 unicast mode
(config-router-af)#redistribute static	Redistribute the static routes.
config-router-af)# neighbor 30.30.30.9 activate	Activate the neighbor
(config-router-af)#exit-address-family	Exit address-family mode
(config-router)#exit	Exit the BGP Router mode and return to the Configure mode.
(config)#ip route 88.88.0.0/16 Null	Configure static route.
(config)#commit	Commit the candidate configuration to the running configuration.

Rtr3

#configure terminal	Enter the Configure mode.
(config)#router bgp 200	Assign the ASN value (200) to the BGP router.
(config-router)#bgp router-id 4.4.4.4	Configure a fixed Router ID (4.4.4.4).
(config-router)#neighbor 40.40.40.9 remote-as 100	Configure neighbor 40.40.40.9 for eBGP.
(config-router)#address-family ipv4 unicast	Enter address-family ipv4 unicast mode
(config-router-af)#redistribute static	Redistribute the static routes.
config-router-af)# neighbor 40.40.40.9 activate	Activate the neighbor
(config-router-af)#exit-address-family	Exit address-family mode
(config-router)#exit	Exit the BGP Router mode and return to the Configure mode.
(config)#ip route 88.88.0.0/16 Null	Configure static route.
(config)#commit	Commit the candidate configuration to the running configuration.

Rtr4

#configure terminal	Enter the Configure mode.
(config)#router bgp 200	Assign the ASN value (200) to the BGP router.
(config-router)#bgp router-id 6.6.6.6	Configure a fixed Router ID (6.6.6.6).
(config-router)#neighbor 50.50.50.9 remote-as 100	Configure neighbor 50.50.50.9 for eBGP.
(config-router)# address-family ipv4 unicast	Enter address-family ipv4 unicast mode
(config-router-af)#redistribute static	Redistribute the static routes.
config-router-af)# neighbor 50.50.50.9 activate	Activate the neighbor
(config-router-af)#exit-address-family	Exit address-family mode
(config)#exit	Exit the BGP Router mode and return to the Configure mode.
(config)#ip route 88.88.0.0/16 Null	Configure static route.
(config)#commit	Commit the candidate configuration to the running configuration.

Rtr2

#configure terminal	Enter the Configure mode.
(config)#router bgp 100	Assign the ASN value (100) to the BGP router.
(config)#bgp router-id 9.9.9.9	Configure a fixed Router ID (9.9.9.9).
(config-router)#neighbor 30.30.30.2 remote-as 200	Configure neighbor 30.30.30.2 for eBGP.
(config-router)#neighbor 40.40.40.4 remote-as 200	Configure neighbor 40.40.40.4 for eBGP.
(config-router)#neighbor 50.50.50.6 remote-as 200	Configure neighbor 50.50.50.6 for eBGP.
(config-router)#address-family ipv4 unicast	Enter address-family ipv4 unicast mode
config-router-af)# neighbor 30.30.30.2 activate	Activate the neighbor
config-router-af)# neighbor 40.40.40.4 activate	Activate the neighbor
config-router-af)# neighbor 50.50.50.6 activate	Activate the neighbor
config-router-af)# max-paths ebgp 2	Configure eBGP max-paths (2).
(config-router-af)#exit-address-family	Exit address-family mode
(config-router)#exit	Exit the Router mode and return to Configure mode.
(config)#commit	Commit the candidate configuration to the running configuration.

Validation

```
#show ip bgp 88.88.0.0
```

```
BGP routing table entry for 88.88.0.0/16
```

```
Paths: (3 available, best #3, table Default-IP-Routing-Table) Advertised to non peer-group peers:
```

```
30.30.30.2 50.50.50.6
200
```

```
30.30.30.2 from 30.30.30.2 (2.2.2.2)
```

```
Origin incomplete metric 0, localpref 100, valid, external, multipath-candidate, installed
```

```
Last update: Sat Jan3 02:06:25 1970
```

```
200
```

```
50.50.50.6 from 50.50.50.6 (6.6.6.6)
```

```
Origin incomplete metric 0, localpref 100, valid, external, multipath-candidate Last update: Sat Jan3 02:05:39 1970
```

```
200
```

```
40.40.40.4 from 40.40.40.4 (4.4.4.4)
```

```
Origin incomplete metric 0, localpref 100, valid, external, multipath-candidate, installed, best
```

Last update: Sat Jan3 02:05:11 1970

```
#show ip route
```

```
Codes: K - kernel, C - connected, S - static, R - RIP, B - BGP O - OSPF, IA - OSPF inter
area
```

```
N1 - OSPF NSSA external type 1, N2 - OSPF NSSA external type 2 E1 - OSPF external type
1, E2 - OSPF external type 2
```

```
i - IS-IS, L1 - IS-IS level-1, L2 - IS-IS level-2,
```

```
ia - IS-IS inter area, E - EVPN, v - vrf leaked
```

```
* - candidate default
```

```
IP Route Table for VRF "default"
```

```
C 30.30.30.0/24 is directly connected, eth1, 05:26:26
```

```
C 40.40.40.0/24 is directly connected, eth6, 05:25:52
```

```
C 50.50.50.0/24 is directly connected, eth3, 05:26:08
```

```
B 88.88.0.0/16 [20/0] via 40.40.40.4, eth6, 00:01:38
   [20/0] via 30.30.30.2, eth1
```

```
C 127.0.0.0/8 is directly connected, lo, 05:30:43
```

```
C 192.168.52.0/24 is directly connected, eth0, 05:30:38
```

```
Gateway of last resort is not set #show running-config router bgp
```

```
!
```

```
router bgp 100
```

```
bgp router-id 9.9.9.9
```

```
max-paths ebgp 2
```

```
neighbor 30.30.30.2 remote-as 200
```

```
neighbor 40.40.40.4 remote-as 200
```

```
neighbor 50.50.50.6 remote-as 200
```

```
!
```

```
address-family ipv4 unicast
```

```
neighbor 30.30.30.2 activate
```

```
neighbor 40.40.40.4 activate
```

```
neighbor 50.50.50.6 activate
```

```
exit-address-family
```

```
!
```

Multipath eiBGP

Use this command to set the number of equal-cost multi-path (ECMP) routes for both eBGP and iBGP. This feature allows to configure multipath load balancing with both external BGP (eBGP) and internal BGP (iBGP) paths in Border Gateway Protocol.

When enabled, this feature can perform load balancing on eBGP and/or iBGP paths. With multiple eBGP and iBGP paths, selection is per all paths sorted according to BGP rules and hence either of all eBGP or iBGP or both will be marked as candidates for multipath programming i.e., it is possible either all eBGP paths or all iBGP paths or both eBGP and iBGP are programmed as multipaths.

Exceptions during path selections when eiBGP is enabled:

- AS Path length check is ignored.
- Origin Check is ignored.
- Peer type check is ignored.

IGP Metric check is ignored.

Topology

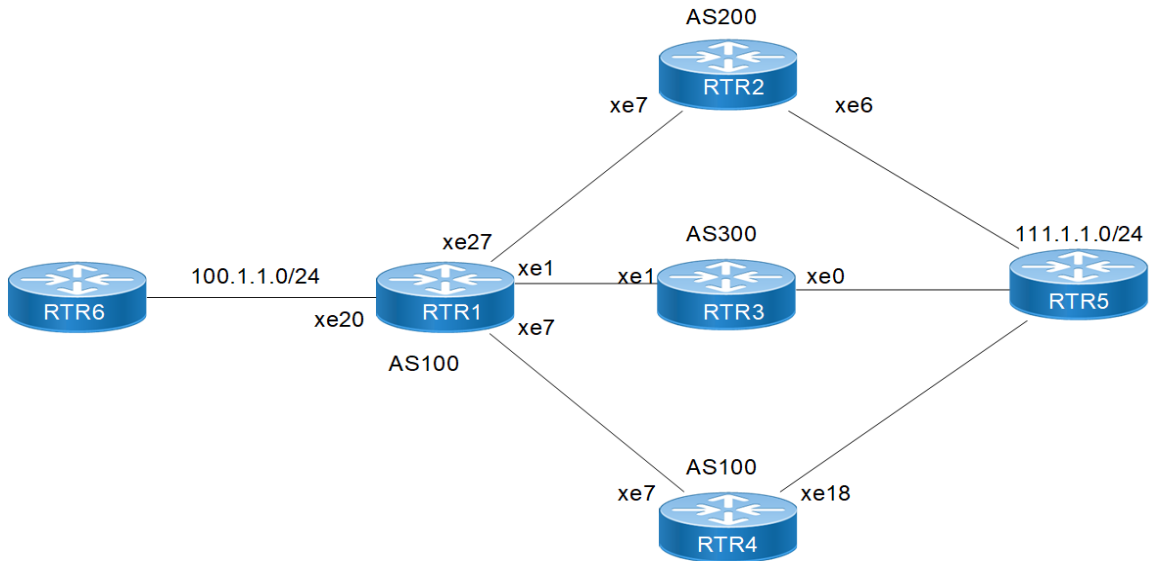

Figure 1-33: Multipath eIBGP topology

Configuration

RTR1

#configure terminal	Enter Configure mode.
(config)#interface lo	Enter Interface mode
(config-if)# ip address 41.41.41.41/32 secondary	Assign IP address to interface
(config-if)#exit	Exit interface mode
(config)#interface xe27	Enter Interface mode
(config-if)# ip address 21.1.1.1/24	Assign IP address to interface
(config-if)#exit	Exit interface mode
(config)#interface xe1	Enter Interface mode
(config-if)# ip address 22.1.1.1/24	Assign IP address to interface
(config-if)#exit	Exit interface mode
(config)#interface xe7	Enter Interface mode
(config-if)# ip address 23.1.1.1/24	Assign IP address to interface
(config-if)#exit	Exit interface mode
(config)#interface xe20	Enter Interface mode
(config-if)# ip address 100.1.1.1/24	Assign IP address to interface
(config-if)#exit	Exit interface mode
(config)# router bgp 100	Enter Router BGP mode

(config-router)# neighbor 21.1.1.2 remote-as 200	Define BGP neighbors. 21.1.1.2 is the IP address of the neighbor (RTR2) and 200 is the neighbors AS number
(config-router)# neighbor 22.1.1.2 remote-as 300	Define BGP neighbors. 22.1.1.2 is the IP address of the neighbor (RTR3) and 300 is the neighbors AS number
(config-router)# neighbor 23.1.1.2 remote-as 100	Define BGP neighbors. 23.1.1.2 is the IP address of the neighbor (RTR4) and 100 is the neighbors AS number
(config-router)# address-family ipv4 unicast	Enter into BGP address family IPv4
(config-router-af)#max-paths eibgp 4	Configure eiBGP max-paths (4).
(config-router-af)#redistribute connected	Redistribute connected routes into BGP
(config-router-af)#neighbor 21.1.1.2 activate	Activate the neighbor
(config-router-af)#neighbor 22.1.1.2 activate	Activate the neighbor
(config-router-af)#neighbor 23.1.1.2 activate	Activate the neighbor
(config-router-af)# commit	Commit the configurations
(config-router-af)# end	Return to privilege mode

RTR2

#configure terminal	Enter Configure mode.
(config)#interface lo	Enter Interface mode
(config-if)# ip address 45.45.45.45/32 secondary	Assign IP address to interface
(config-if)#exit	Exit interface mode
(config)#interface xe7	Enter Interface mode
(config-if)# ip address 21.1.1.2/24	Assign IP address to interface
(config-if)#exit	Exit interface mode
(config)#interface xe6	Enter Interface mode
(config-if)# ip address 111.1.1.11/24	Assign IP address to interface
(config-if)#exit	Exit interface mode
(config)# router bgp 200	Enter Router BGP mode
(config-router)# neighbor 21.1.1.1 remote-as 100	Define BGP neighbors. 21.1.1.1 is the IP address of the neighbor (RTR1) and 100 is the neighbors AS number
(config-router)# address-family ipv4 unicast	Enter into BGP address family IPv4
(config-router-af)#redistribute connected	Redistribute connected routes
(config-router-af)#neighbor 21.1.1.1 activate	Activate the neighbor
(config-router-af)# commit	Commit the configurations
(config-router-af)# end	Return to privilege mode

RTR3

#configure terminal	Enter Configure mode.
(config)#interface lo	Enter Interface mode

BGP

(config-if)# ip address 42.42.42.42/32 secondary	Assign IP address to interface
(config-if)#exit	Exit interface mode
(config)#interface xe0	Enter Interface mode
(config-if)# ip address 111.1.1.42/24	Assign IP address to interface
(config-if)#exit	Exit interface mode
(config)#interface xe1	Enter Interface mode
(config-if)# ip address 22.1.1.2/24	Assign IP address to interface
(config-if)#exit	Exit interface mode
(config)# router bgp 300	Enter Router BGP mode
(config-router)# neighbor 22.1.1.1 remote-as 100	Define BGP neighbors. 22.1.1.1 is the IP address of the neighbor (RTR1) and 100 is the neighbors AS number
(config-router)# address-family ipv4 unicast	Enter into BGP address family IPv4
(config-router-af)#redistribute connected	Redistribute connected routes
(config-router-af)#neighbor 22.1.1.1 activate	Activate the neighbor
(config-router-af)# commit	Commit the configurations
(config-router-af)# end	Return to privilege mode

RTR4

#configure terminal	Enter Configure mode.
(config)#interface lo	Enter Interface mode
(config-if)# ip address 43.43.43.43/32 secondary	Assign IP address to interface
(config-if)#exit	Exit interface mode
(config)#interface xe7	Enter Interface mode
(config-if)# ip address 23.1.1.2/24	Assign IP address to interface
(config-if)#exit	Exit interface mode
(config)#interface xe18	Enter Interface mode
(config-if)# ip address 111.1.1.43/24	Assign IP address to interface
(config-if)#exit	Exit interface mode
(config)# router bgp 100	Enter Router BGP mode
(config-router)# neighbor 23.1.1.1 remote-as 100	Define BGP neighbors. 23.1.1.1 is the IP address of the neighbor (RTR1) and 100 is the neighbors AS number
(config-router)# address-family ipv4 unicast	Enter into BGP address family IPv4
(config-router-af)#redistribute connected	Redistribute connected routes
(config-router-af)#neighbor 23.1.1.1 activate	Activate the neighbor
(config-router-af)# commit	Commit the configurations
(config-router-af)# end	Return to privilege mode

Validation

RTR1

```
# sh ip bgp summary
BGP router identifier 15.1.1.2, local AS number 100
BGP table version is 4
3 BGP AS-PATH entries
0 BGP community entries
4 Configured ebgp ECMP multipath: Currently set at 4
```

Neighbor	V	AS	MsgRcv	MsgSen	TblVer	InQ	OutQ	Up/Down	State/PfxRcd
21.1.1.2	4	200	13	16	4	0	0	00:04:28	3
22.1.1.2	4	300	10	14	4	0	0	00:03:05	4
23.1.1.2	4	100	7	9	4	0	0	00:01:49	4

Total number of neighbors 3

Total number of Established sessions 3

```
#sh ip route
Codes: K - kernel, C - connected, S - static, R - RIP, B - BGP
       O - OSPF, IA - OSPF inter area
       N1 - OSPF NSSA external type 1, N2 - OSPF NSSA external type 2
       E1 - OSPF external type 1, E2 - OSPF external type 2
       i - IS-IS, L1 - IS-IS level-1, L2 - IS-IS level-2,
       ia - IS-IS inter area, E - EVPN,
       v - vrf leaked
       * - candidate default
```

```
IP Route Table for VRF "default"
B      11.1.1.0/24 [200/0] via 23.1.1.2, xe7, 00:11:26
B      11.11.11.11/32 [20/0] via 21.1.1.2, xe27, 00:10:14
B      17.1.1.0/24 [20/0] via 22.1.1.2, xe1, 00:10:54
C      21.1.1.0/24 is directly connected, xe27, 00:47:36
C      22.1.1.0/24 is directly connected, xe1, 00:49:33
C      23.1.1.0/24 is directly connected, xe7, 00:49:11
C      41.41.41.41/32 is directly connected, lo, 01:30:34
B      42.42.42.42/32 [20/0] via 22.1.1.2, xe1, 00:10:54
B      43.43.43.43/32 [200/0] via 23.1.1.2, xe7, 00:11:26
B      45.45.45.45/32 [20/0] via 21.1.1.2, xe27, 00:10:56
C      100.1.1.0/24 is directly connected, xe20, 00:08:31
B      111.1.1.0/24 [200/0] via 23.1.1.2, xe7, 00:11:26
           [200/0] via 22.1.1.2, xe1,
           [200/0] Via 21.1.1.2, xe27
C      127.0.0.0/8 is directly connected, lo, 01:39:19
```

Gateway of last resort is not set

```
#sh interface counters rate mbps
```

Interface

Rx mbps

Rx pps

Tx mbps

Tx pps

xe1	0.00	0	264.30	22024
xe7	0.00	0	254.86	21238
xe20	822.35	68529	0.02	3
xe27	0.00	0	215.04	17920

6BGP AS-PATH Multipath-relax

BGP will not load balance across multiple paths by default. We can configure it to do so with the `max-paths ebgp <no-of-multipaths>` command. The criterion of this command is that all attributes must match (Weight, Local preference, AS Path, etc). This is acceptable if we are multi-homed to a single AS, but what if we are multi-homed to different AS.

BGP AS PATH multipath relax effectively allows for ECMP to be done across different neighboring ASN's.

Topology

Below topology explains about BGP AS PATH multipath relax functionality.

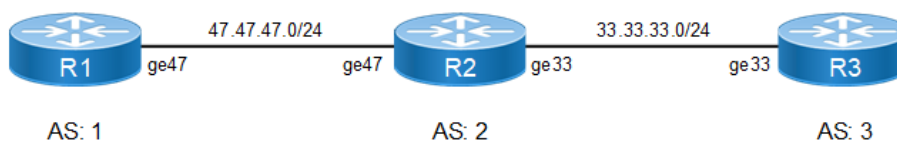

Figure 1-34: BGP AS-PATH Multipath-relax Topology

Configuration

R1

#configure terminal	Enter the Configure mode.
(config)#interface lo	Enter Interface loopback
(config-if)#ip address 100.1.1.1/24 secondary	Configure IP address for interface
(config-if)#exit	Exit interface mode
(config)#interface ge47	Enter Interface loopback

(config-if)#ip address 47.47.47.1/24	Configure IP address for interface
(config-if)#exit	Exit from interface mode and enter the Configure mode
(config)#router bgp 1	Assign the ASN value (1) to the BGP router
(config-router)#neighbor 47.47.47.2 remote-as 2	Configure eBGP neighbor.
(config-router)#address-family ipv4 unicast	Enter address-family ipv4 unicast mode
(config-router-af)#neighbor 47.47.47.2 activate	Activate neighbor
(config-router-af)#network 100.1.1.0/24	Advertise the loopback network into BGP.
(config-router-af)#exit-address-family	Exit address-family config mode
(config-router)#commit	Commit the candidate configuration to the running configuration.

R2

#configure terminal	Enter the Configure mode.
(config)#interface ge33	Enter interface mode
(config-if)#ip address 33.33.33.2/24	Configure IP address for interface
(config-if)#exit	Exit from interface mode and enter the Configure mode
(config)#interface ge47	Enter interface mode
(config-if)#ip address 47.47.47.2/24	Configure IP address for interface.
(config-if)#exit	Exit from interface mode and enter the Configure mode
(config)#router bgp 2	Assign the ASN value (2) to the BGP router.
(config-router)#neighbor 33.33.33.3 remote-as 3	Configure eBGP neighbor.
(config-router)#neighbor 47.47.47.1 remote-as 1	Configure eBGP neighbor.
(config-router)#address-family ipv4 unicast	Enter the address family IPv4 unicast mode
(config-router-af)# neighbor 33.33.33.3 activate	Activate the neighbor
(config-router-af)# neighbor 47.47.47.1 activate	Activate the neighbor
(config-router-af)# max-paths ebgp 8	Configure eBGP Multipath.
(config-router-af)#exit	Exit from address family mode and enter the Router configure mode
(config-router)# bgp bestpath as-path multipath-relax	Configure BGP AS PATH Multipath relax.
(config-router-af)#exit-address-family	Exit address-family mode
(config-router)#commit	Commit the candidate configuration to the running configuration.

R3

#configure terminal	Enter the Configure mode.
(config)#interface lo	Enter Interface loopback.

BGP

(config-if)#ip address 100.1.1.1/24 secondary	Configure IP address for interface.
(config-if)#exit	Exit from interface mode and enter the Configure mode.
(config)#interface ge33	Enter Interface loopback.
(config-if)#ip address 33.33.33.3/24	Configure IP address for interface.
(config-if)#exit	Exit from interface mode and enter the Configure mode.
(config)#router bgp 3	Assign the ASN value (3) to the BGP router.
(config-router)#neighbor 33.33.33.2 remote- as 2	Configure eBGP neighbor.
(config-router)#address-family ipv4 unicast	Enter address-family ipv4 unicast mode
(config-router-af)# neighbor 33.33.33.2 activate	Activate the neighbor
(config-router-af)#network 100.1.1.0/24	Advertise the loopback network into BGP.
(config-router-af)#exit-address-family	Exit from router BGP and address-family config mode
(config-router)#commit	Commit the candidate configuration to the running configuration.

Validation

```
R2#show running-config bgp
```

```
!  
router bgp 2  
bgp bestpath as-path multipath-relax max-paths ebgp 8  
neighbor 33.33.33.3 remote-as 3  
neighbor 47.47.47.1 remote-as 1  
!  
address-family ipv4 unicast  
neighbor 33.33.33.3 activate  
neighbor 47.47.47.1 activate  
max-paths ebgp 8  
bgp bestpath as-path  
multipath-relax
```

```
exit-address-family
```

```
!  
R2#show ip bgp 100.1.1.0  
BGP routing table entry for 100.1.1.0/24  
Paths: (2 available, best #1, table Default-IP-Routing-Table) Advertised to non peer-  
group peers:  
47.47.47.1  
3  
33.33.33.3 from 33.33.33.3 (33.33.33.3)  
Origin IGP, metric 0, localpref 100, valid, external, multipath- candidate, installed,  
best  
Last update: Tue Feb 23 03:13:14 2016  
1  
47.47.47.1 from 47.47.47.1 (62.57.1.1)  
Origin IGP, metric 0, localpref 100, valid, external, multipath-
```

```

candidate, installed
Last update: Tue Feb 23 03:13:15 2016

R2#show ip bgp summary
BGP router identifier 192.168.52.3, local AS number 2 BGP table version is 2
2 BGP AS-PATH entries

0 BGP community entries
8  Configured ebgp ECMP multipath: Currently set at 8
1  Configured ibgp ECMP multipath: Currently set at 1
1  Configured eibgp ECMP multipath: Currently set at 1

NeighborVASMsgRcvMsgSen TblVerInQOutQUp/ DownState/PfxRcd
33.33.33.3
00:01:101
47.47.47.1
00:06:331

Total number of neighbors 2

Total number of Established sessions 2

R2#show ip bgp
BGP table version is 2, local router ID is 192.168.52.3
Status codes: s suppressed, d damped, h history, * valid, > best, i - internal,
l - labeled, S Stale
Origin codes: i - IGP, e - EGP, ? - incomplete

NetworkNext HopMetricLocPrfWeightPath
*> 100.1.1.0/2447.47.47.1010001 i
* 33.33.33.301000 3 i

Total number of prefixes 1

```

BGP FIB Install (Selective Route Download)

The BGP—Selective Route Download feature allows a network administrator to selectively download some or none of the BGP routes into the Routing Information Base (RIB). The primary application for this feature is to suppress the unnecessary downloading of certain BGP routes to the RIB or Forwarding Information Base (FIB) on a dedicated route reflector, which propagates BGP updates without carrying transit traffic. The feature thereby helps to maximize resources available and to improve routing scalability and convergence on the dedicated route reflector.

With RFC 4456, the concept of route reflection was defined; this would allow configuring designated one or more BGP routers in iBGP network as route reflectors. BGP relaxes the re-advertising restriction on these route reflectors, allowing them to accept and propagate iBGP routes to their clients.

The role of a dedicated route reflector (RR) is to propagate BGP updates without participating in the actual forwarding of transit traffic. That means the RR does not need to have all BGP routes downloaded into its RIB or FIB. It is beneficial for the RR to preserve its resources by not processing and storing those routes.

By default, BGP routes are downloaded to the RIB. To save resources on a dedicated route reflector, such downloading can be reduced or prevented by configuring a table map. A table map is so named because it controls what is put into the BGP routing table.

By reducing the route installation in the dedicated route reflectors, we can maximize availability of resources and improve routing scalability and convergence.

A new command 'table map' is being introduced to achieve this. A table map controls what is put into the BGP routing table. When configured it would reduce or prevent downloading routes to RIB.

Table map command references 'route map' rules available in BGP to control the routes going into the BGP routing table.

Table-map command can be used in two ways:

- When a simple table-map command is given (without filter option), the route map referenced in the table-map command shall be used to set certain properties (such as the traffic index) of the routes for installation into the RIB. The route is always downloaded, regardless of whether it is permitted or denied by the route map.
- When the option 'filter' is given in the table map command, the route map referenced is used to control whether a BGP route is to be downloaded to the IP RIB (hence the filter). A BGP route is not downloaded to the RIB if it is denied by the route map.

Topology

Below topology explains about BGP FIB Install functionality

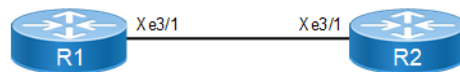

Figure 1-35: BFP FIB Install Topology

Configuration

R1

#configure terminal	Enter the Configure mode.
(config)#interface xe3/1	Enter interface mode.
(config-if)#ip address 20.1.1.1/24	Configure IP address for interface
(config-if)#exit	Exit interface mode
(config)# router bgp 100	Assign the ASN value (100) to the BGP router.
(config-router)#neighbor 20.1.1.2 remote-as 100	Configure neighbor in IBGP
(config-router)#address-family ipv4 unicast	Enter address-family ipv4 unicast mode
(config-router-af)#redistribute static	Redistribute static routes to advertise to its neighbor
(config-router-af)#neighbor 20.1.1.2 activate	Activate the neighbor
(config-router-af)#exit-address-family	Exit address-family mode
(config-router)#exit	Exit Router mode and enter Configure mode
(config)#ip route 1.1.1.0/24 xe3/1	Configure static route.
(config)#ip route 2.2.2.0/24 xe3/1	Configure static route.
(config)#ip route 3.3.3.0/24 xe3/1	Configure static route.

(config)#ip route 4.4.4.0/24 xe3/1	Configure static route.
(config)#ip route 5.5.5.0/24 xe3/1	Configure static route.
(config)#ip route 6.6.6.0/24 xe3/1	Configure static route.
(config)#commit	Commit the candidate configuration to the running configuration.

R2

#configure terminal	Enter the Configure mode.
(config)#interface xe3/1	Configure IP address for interface
(config-if)#ip address 20.1.1.2/24	Configure IP address for interface
(config-if)#exit	Exit from interface mode and enter into Configure mode
(config)#router bgp 100	Assign the ASN value (100) to the BGP router.
(config-router)#neighbor 20.1.1.1 remote-as 100	Configure neighbor iBGP.
(config-router)#address-family ipv4 unicast	Enter address-family ipv4 unicast mode
(config-router-af)#redistribute static	Redistribute the static routes.
(config-router-af)#neighbor 20.1.1.1 activate	Activate the neighbor
(config-router-af)#exit-address-family	Exit address-family mode
(config-router)#exit	Exit the BGP Router mode and return to the Configure mode.
(config)#ip access-list 1	Login to Configure access-list parameters
(config-ip-acl)#permit ipip 2.2.2.0 0.0.0.225 any	Configure access-list by allowing only one route to install in FIB table.
(config-ip-acl)#exit	Exit assess list mode
(config)# route-map test permit 1	Configure route-map to match access-list
(config-route-map)# match ip address 1	Match the above configured access-list 1
(config-route-map)#exit	Exit from route-map Configure mode and enter into Configure mode
(config)#router bgp 100	Enter into BGP router mode
(config-router)# address-family ipv4 unicast	Enter address-family ipv4 unicast mode
(config-router-af)# table-map test filter	Apply table-map with route-map created and with filter option
(config-router-af)#exit-address-family	Exit address family mode
(config-router)#commit	Commit the candidate configuration to the running configuration.

Validation

Table-map with Filter Option

Verify BGP neighborhood is up between R1 and R2. Before applying table-map in R2, all routes will be installed in FIB table, as in below output.

R1

```
#show ip bgp summary
```

BGP

BGP router identifier 20.1.1.1, local AS BGP table version is 3

1 BGP AS-PATH entries

0 BGP community entries

number 100

NeighborVASMsgRcvMsgSen TblVerInQOutQUp/Dow

n State/PfxRcd

20.1.1.241005

6 3

0

0

00:01:31

0

Total number of neighbors 1

Total number of Established sessions 1

#show ip bgp

BGP table version is 1, local router ID is 192.168.52.4

Status codes: s suppressed, d damped, h history, * valid, > best, i - internal, l - labeled, S Stale

Origin codes: i - IGP, e - EGP, ? - incomplete

NetworkNext HopMetricLocPrfWeight Path

*> 1.1.1.0/240.0.0.0010032768?

*> 2.2.2.0/240.0.0.0010032768?

*> 3.3.3.0/240.0.0.0010032768?

*> 4.4.4.0/240.0.0.0010032768?

*> 5.5.5.0/240.0.0.0010032768?

*> 6.6.6.0/240.0.0.0010032768?

Total number of prefixes 6 #

#show ip route

Codes: K - kernel, C - connected, S - static, R - RIP, B - BGP O - OSPF, IA - OSPF inter area

N1 - OSPF NSSA external type 1, N2 - OSPF NSSA external type 2 E1 - OSPF external type 1, E2 - OSPF external type 2

i - IS-IS, L1 - IS-IS level-1, L2 - IS-IS level-2,

ia - IS-IS inter area, E - EVPN, v - vrf leaked

* - candidate default

IP Route Table for VRF "default"

S 1.1.1.0/24[1/0]isdirectlyconnected,eth1,00:06:54

S 2.2.2.0/24[1/0]isdirectlyconnected,eth1,00:06:35

S 3.3.3.0/24[1/0]isdirectlyconnected,eth1,00:06:26

S 4.4.4.0/24[1/0]isdirectlyconnected,eth1,00:06:17

S 5.5.5.0/24[1/0]isdirectlyconnected,eth1,00:06:09

S 6.6.6.0/24[1/0]isdirectlyconnected,eth1,00:06:01

C 20.1.1.0/24 is directly connected, eth1, 00:07:32 C127.0.0.0/8 is directly connected, lo, 00:08:21

C 192.168.52.0/24 is directly connected, eth0, 00:08:17

Gateway of last resort is not set #

R2

```
#show ip bgp
BGP table version is 1, local router ID is 192.168.52.4
Status codes: s suppressed, d damped, h history, * valid, > best, i - internal, l -
labeled, S Stale
Origin codes: i - IGP, e - EGP, ? - incomplete
```

```
      NetworkNext HopMetricLocPrfWeight Path
*> 1.1.1.0/240.0.0.0010032768?
*> 2.2.2.0/240.0.0.0010032768?
*> 3.3.3.0/240.0.0.0010032768?
*> 4.4.4.0/240.0.0.0010032768?
*> 5.5.5.0/240.0.0.0010032768?
*> 6.6.6.0/240.0.0.0010032768?
```

Total number of prefixes 6 #

```
#show ip route
Codes: K - kernel, C - connected, S - static, R - RIP, B - BGP O - OSPF, IA - OSPF inter
area
N1 - OSPF NSSA external type 1, N2 - OSPF NSSA external type 2 E1 - OSPF external type
1, E2 - OSPF external type 2
i - IS-IS, L1 - IS-IS level-1, L2 - IS-IS level-2,
ia - IS-IS inter area, E - EVPN, v - vrf leaked
* - candidate default
```

```
IP Route Table for VRF "default"
B 1.1.1.0/24[200/0]via20.1.1.1,eth1,00:13:44
B 2.2.2.0/24[200/0]via20.1.1.1,eth1,00:13:44
B 3.3.3.0/24[200/0]via20.1.1.1,eth1,00:13:44
B 4.4.4.0/24[200/0]via20.1.1.1,eth1,00:13:44
B 5.5.5.0/24[200/0]via20.1.1.1,eth1,00:13:44
B 6.6.6.0/24[200/0]via20.1.1.1,eth1,00:13:44
C 20.1.1.0/24 is directly connected, eth1, 00:14:12 C127.0.0.0/8 is directly
connected, lo, 00:25:26
C 192.168.52.0/24 is directly connected, eth0, 00:25:23
```

Gateway of last resort is not set #

Table-map With Filter Option

Now verify after applying table-map with filter option, only one route will be installed in FIB table according to route-map and access-list configured, BGP table remains same, table-map effect will be seen only for FIB table.

After applying table-map, clear BGP with "clear ip bgp table-map."

```
(config)#router bgp 100
(config-router)#address-family ipv4-unicast
```

BGP

```
(config-router-af)#table-map test filter
(config-router-af)#end
#clear ip bgp table-map
```

```
#show ip bgp
```

```
BGP table version is 2, local router ID is 192.168.52.5
Status codes: s suppressed, d damped, h history, * valid, > best, i - internal, l -
labeled, S Stale
Origin codes: i - IGP, e - EGP, ? - incomplete
```

```
NetworkNext HopMetricLocPrfWeightPath
```

```
*>i 1.1.1.0/2420.1.1.101000?
*>i 2.2.2.0/2420.1.1.101000?
*>i 3.3.3.0/2420.1.1.101000?
*>i 4.4.4.0/2420.1.1.101000?
```

```
*>i 5.5.5.0/2420.1.1.101000?
*>i 6.6.6.0/2420.1.1.101000?
```

```
Total number of prefixes 6 #
```

```
#show ip bgp summary
```

```
BGP router identifier 192.168.52.5, local AS number 100 BGP table version is 2
1 BGP AS-PATH entries
0 BGP community entries
```

```
NeighborVASMsgRcvMsgSen TblVerInQOutQUp/DownState/ PfxRcd
20.1.1.141004039 2 0 0 00:18:33
6
```

```
Total number of neighbors 1
```

```
Total number of Established sessions 1 #
```

```
#show ip route
```

```
Codes: K - kernel, C - connected, S - static, R - RIP, B - BGP O - OSPF, IA - OSPF inter
area
N1 - OSPF NSSA external type 1, N2 - OSPF NSSA external type 2 E1 - OSPF external type
1, E2 - OSPF external type 2
i - IS-IS, L1 - IS-IS level-1, L2 - IS-IS level-2,
ia - IS-IS inter area, E - EVPN, v - vrf leaked
* - candidate default
```

```
IP Route Table for VRF "default"
```

```
B 2.2.2.0/24 [200/0] via 20.1.1.1, eth1, 00:00:26
C 20.1.1.0/24 is directly connected, eth1, 00:19:01 C127.0.0.0/8 is directly
connected, lo, 00:30:15
C 192.168.52.0/24 is directly connected, eth0, 00:30:12
```

```
Gateway of last resort is not set
```

Table-map Without Filter Option

Remove filter option while applying table-map as below in R2

#configure terminal	Enter the Configure mode.
(config)#router bgp 100	Enter into BGP router mode
(config-router)# address-family ipv4 unicast	Enter address-family ipv4 unicast mode
(config-router-af)# table-map test	Apply table-map with route-map created and with filter option
(config-router-af)#exit-address-family	Exit address family mode
(config-router)#commit	Commit the candidate configuration to the running configuration.

```
#show running-config bgp
!
router bgp 100 redistribute static
neighbor 20.1.1.1 remote-as 100 table-map test
!
 address-family ipv4 unicast
 neighbor 20.1.1.1 activate
 exit-address-family
!
#clear ip bgp table-map
```

```
#show ip route
Codes: K - kernel, C - connected, S - static, R - RIP, B - BGP O - OSPF, IA - OSPF inter
area
N1 - OSPF NSSA external type 1, N2 - OSPF NSSA external type 2 E1 - OSPF external type
1, E2 - OSPF external type 2
i - IS-IS, L1 - IS-IS level-1, L2 - IS-IS level-2,
ia - IS-IS inter area, E - EVPN, v - vrf leaked
* - candidate default
```

```
IP Route Table for VRF "default"
B 1.1.1.0/24[200/0]via20.1.1.1,eth1,00:00:04
B 2.2.2.0/24[200/0]via20.1.1.1,eth1,00:00:04
B 3.3.3.0/24[200/0]via20.1.1.1,eth1,00:00:04
B 4.4.4.0/24[200/0]via20.1.1.1,eth1,00:00:04
B 5.5.5.0/24[200/0]via20.1.1.1,eth1,00:00:04
B 6.6.6.0/24[200/0]via20.1.1.1,eth1,00:00:04
C 20.1.1.0/24 is directly connected, eth1, 00:31:16 C127.0.0.0/8 is directly
connected, lo, 00:42:30
C 192.168.52.0/24 is directly connected, eth0, 00:42:27
```

Gateway of last resort is not set #

Note: Same can be tried with IPV6 VRF-v4 and VRF-v6 address-families and this feature is not supported for VPNV4 address-family

Route Target Constraint

BGP/MPLS IP VPNs use PE routers to Route Target (RT) extended communities and control the distribution of routes into the VRFs. Within a given iBGP mesh, PE routers hold routes marked with RouteTargets pertaining to VRFs that have local CE attachments.

BGP RT Constrained Route Distribution is a feature that can be used by service providers in Multiprotocol Label Switching (MPLS) Layer 3 VPNs to reduce the number of unnecessary routing updates that route reflectors (RRs) send to Provider Edge (PE) routers. The reduction in “routing updates” saves resources by allowing RRs, Autonomous System Boundary Routers (ASBRs), and PEs to carry fewer routes. Route targets are used to constrain routing updates.

With (MPLS)VPNs, the (iBGP) peers or Route Reflectors send all VPN4 and/or VPN6 prefixes to the PE routers. The PE routers drop the VPN4/6 prefixes for which there is no importing VPN route forwarding (VRF).

Topology

The topology below shows Route-target filtering in an L3VPN—with Route Target Constraint (RTC), the RR sends only wanted VPN4/6 prefixes to the PE; “wanted” means that the PEs have the VRFs importing the specific prefixes.

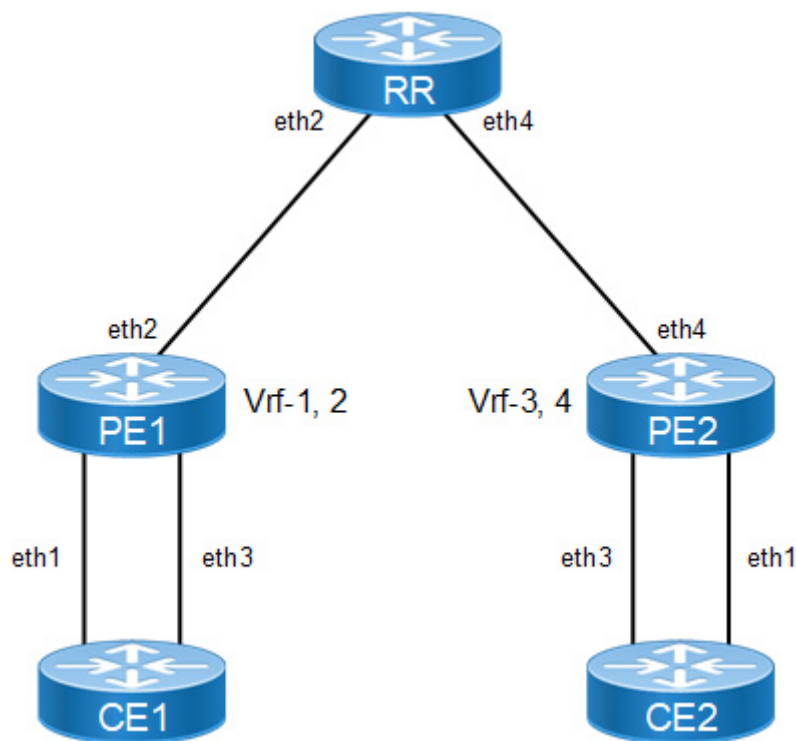

Figure 1-36: Route-target Filter Topology

Configuration

CE1

#configure terminal	Enter configure mode.
(config)#interface eth1	Enter interface mode

(config-if)#ip address 80.1.1.1/24	Configure IP address for interface
(config-if)#exit	Exit from interface mode and enter into Configure mode
(config)#interface eth3	Enter interface mode
(config-if)#ip address 90.1.1.1/24	Configure IP address for interface
(config-if)#exit	Exit from interface mode and enter into Configure mode
(config)# router bgp 200	Assign the ASN value (100) to the BGP router
(config-router)#neighbor 80.1.1.2 remote-as 100	Configure neighbor (RR) in IBGP
(config-router)#neighbor 90.1.1.2 remote-as 100	Configure neighbor (RR) in IBGP
(config-router)# address-family ipv4 unicast	Enter address-family ipv4 unicast mode
(config-router-af)#redistribute static	Redistribute static routes into BGP
(config-router-af)#neighbor 80.1.1.2 activate	Activate neighbor
(config-router-af)#neighbor 90.1.1.2 activate	Activate neighbor
(config-router-af)#exit-address-family	Exit address-family mode
(config-router)#exit	Exit from router mode and enter configure mode
(config)#ip route vrf 1 1.1.1.0/24 eth1	Configure static route with VRF 1 instance
(config)#ip route vrf 2 3.3.3.0/24 eth3	Configure static route with VRF 2 instance
(config)#ip route vrf 2 4.4.4.0/24 eth3	Configure static route with VRF 2 instance
(config)#commit	Commit the candidate configuration to the running configuration.

CE2

#configure terminal	Enter configure mode.
(config)#interface eth1	Enter interface mode
(config-if)#ip address 101.1.1.1/24	Configure IP address for interface
(config-if)#exit	Exit from interface mode and enter into Configure mode
(config)#interface eth3	Enter interface mode
(config-if)#ip address 100.1.1.1/24	Configure IP address for interface
(config-if)#exit	Exit from interface mode and enter into Configure mode
(config)# router bgp 200	Assign the ASN value (100) to the BGP router
(config-router)#neighbor 100.1.1.2 remote-as 100	Configure neighbor (RR) in IBGP
(config-router)#neighbor 101.1.1.2 remote-as 100	Configure neighbor (RR) in IBGP
(config-router)# address-family ipv4 unicast	Enter address-family ipv4 unicast mode
(config-router-af)#neighbor 100.1.1.2 activate	Activate neighbor
(config-router-af)#neighbor 101.1.1.2 activate	Activate neighbor
(config-router-af)#exit-address-family	Exit from address family ipv4 unicast mode

BGP

(config-router)#exit	Exit from router and configure mode
(config)#commit	Commit the candidate configuration to the running configuration.

PE1

#configure terminal	Enter configure mode.
(config)#ip vrf 1	Create a VRF instance 1
(config-vrf)#rd 1:100	Configure unique RD value for VRF to identify VRF instance
(config-vrf)#route-target export 1:200	Configure route-target (rt) value for exporting routes into other VRFs (for other PE's)
(config-vrf)#exit	Exit VRF mode and enter Configure mode
(config)#ip vrf 2	Create a VRF instance 2
(config-vrf)#rd 1:300	Configure unique RD value for VRF to identify VRF instance
(config-vrf)#route-target both 1:400	Configure route-target (rt) value for exporting routes into other VRFs (for other PE's)
(config-vrf)#exit	Exit VRF mode and enter Configure mode
(config)#router ldp	Enable LDP.
(config-router)#exit	Exit router LDP mode
(config)#interface lo	Enter loopback interface mode
(config-if)#ip address 11.11.11.11/32 secondary	Configure IP address for loopback interface
(config-if)#enable-ldp ipv4	Enable LDP on loopback interface
(config-if)#exit	Exit interface mode
(config)#interface eth1	Enter interface mode
(config-if)#ip vrf forwarding 1	Bind interface to VRF 1
(config-if)#ip address 80.1.1.2/24	Configure IP address for VRF binded interface
(config-if)#exit	Exit interface mode
(config)#interface eth2	Enter interface mode
(config-if)#ip address 40.1.1.1/24	Configure an IP address for interface
(config-if)#label-switching	Enable label-switching on interface
(config-if)#enable-ldp ipv4	Enable LDP on connected interface between PE1 and RR
(config-if)#exit	Exit interface mode
(config)#interface eth3	Enter interface mode
(config-if)#ip vrf forwarding 2	Bind interface to VRF 1
(config-if)#ip address 90.1.1.2/24	Configure IP address for VRF binded interface
(config-if)#exit	Exit interface mode
(config)#commit	Commit the candidate configuration to the running configuration.
(config)#router ospf	Enable OSPF process between PE1 and RR

(config-router)#network 11.11.11.11/32 area 0.0.0.0	Advertise loopback network in OSPF area 0
(config-router)#network 40.1.1.0/24 area 0.0.0.0	
(config-router)#exit	Exit router OSPF mode
(config)#commit	Commit the candidate configuration to the running configuration.
(config)#router bgp 100	Assign the ASN value (100) to the BGP router
(config-router)#neighbor 22.22.22.22 remote-as 100	Configure neighbor (RR) in IBGP
(config-router)#neighbor 22.22.22.22 update-source lo	Enable neighbor with loopback interface.
(config-router)#address-family vpnv4 unicast	Enter Address-Family-VPNv4 mode.
(config-router-af)#neighbor 22.22.22.22 activate	Activate RR neighbor
(config-router-af)#exit-address-family	Exit Address Family mode and return to Router mode.
(config-router)#address-family rtfiler unicast	Enable RT filter address-family mode
(config-router-af)#neighbor 22.22.22.22 activate	Activate neighbor
(config-router-af)#exit-address-family	Exit RTfilter Address Family mode and return to Router mode.
(config-router)#address-family ipv4 vrf 1	Enter Address-Family-VRF mode.
(config-router-af)#neighbor 80.1.1.1 remote-as 200	Configure CE neighbor in VRF mode
(config-router-af)#neighbor 80.1.1.1 activate	Activate neighbor in VRF
(config-router-af)#exit-address-family	Exit Address Family mode and return to Router mode.
(config-router)#address-family ipv4 vrf 2	Enter Address-Family-VRF mode.
(config-router-af)#neighbor 90.1.1.1 remote-as 200	Configure CE neighbor in VRF mode
(config-router-af)#neighbor 90.1.1.1 activate	Activate neighbor in VRF
(config-router-af)#exit-address-family	Exit Address Family mode and return to Router mode.
(config-router)#exit	Exit from router mode and configure mode
(config-router)#commit	Commit the candidate configuration to the running configuration.

RR

(config)#router ldp	Enable LDP
(config-router)#exit	Exit router LDP mode
(config)#interface lo	Enter loopback interface
(config-if)#ip address 22.22.22.22/32 secondary	Configure IP address for loopback interface
(config-if)#ip address 44.44.44.44/32 secondary	
(config-if)#enable-ldp ipv4	Enable LDP on loopback interface
(config-if)#exit	Exit interface mode

BGP

(config)#interface eth2	Enter interface mode
(config-if)#ip address 40.1.1.2/24	Configure IP address for interface connecting to PE2
(config-if)#label-switching	Enable label-switching on interface
(config-if)# enable-ldp ipv4	Enable LDP on connected interface between PE1 and RR
(config-if)#exit	Exit interface mode
(config)#interface eth4	Enter into interface mode
(config-if)#ip address 50.1.1.1/24	Configure an IP address for interface connecting to PE1
(config-if)#label-switching	Enable label-switching on interface
(config-if)# enable-ldp ipv4	Enable LDP on connected interface between PE1 and RR
(config-if)#exit	Exit interface mode
(config)#commit	Commit the candidate configuration to the running configuration.
(config)#router ospf	Enable OSPF process between PE1 and RR
(config-router)#network 22.22.22.22/32 area 0.0.0.0	Advertise loopback network in OSPF area 0
(config-router)#network 40.1.1.0/24 area 0 (config-router)#network 44.44.44.44/32 area 0.0.0.0 (config-router)#network 50.1.1.0/24 area 0.0.0.0	Advertise PE1 to RR connected network in OSPF
(config-router)#exit	Exit from router OSPF mode
(config)#commit	Commit the candidate configuration to the running configuration.
(config)# router bgp 100	Assign the ASN value (100) to the BGP router
(config-router)#neighbor 11.11.11.11 remote-as 100	Configure neighbor (PE1) in IBGP
(config-router)#neighbor 11.11.11.11 update-source 22.22.22.22	Enable neighbor with loopback interface
(config-router)#neighbor 33.33.33.33 remote-as 100	Configure neighbor (PE2) in IBGP
(config-router)#neighbor 33.33.33.33 update-source 44.44.44.44	Enable neighbor with loopback interface
(config-router)#address-family vpv4 unicast	Enter Address-Family-VPNv4 mode.
(config-router-af)#neighbor 11.11.11.11 activate	Activate PE1 neighbor
(config-router-af)#neighbor 33.33.33.33 activate	Activate PE2 neighbor
(config-router-af)#neighbor 11.11.11.11 route-reflector-client	Configure PE1 as Route Reflector client
(config-router-af)#neighbor 33.33.33.33 route-reflector-client	Configure PE2 as Route Reflector client
(config-router-af)#exit-address-family	Exit Address Family mode and return to Router mode.
(config-router)#address-family rtfilter unicast	Enable RT filter address-family mode
(config-router-af)#neighbor 11.11.11.11 activate	Activate PE1 neighbor in RTfilter family

(config-router-af)#neighbor 33.33.33.33 activate	Activate PE2 neighbor in RTfilter family
(config-router-af)#neighbor 33.33.33.33 route-reflector-client	Configure PE2 as Route Reflector client
(config-router-af)#neighbor 11.11.11.11 route-reflector-client	Configure PE1 as Route Reflector client
(config-router-af)#exit-address-family	Exit RTfilter Address-Family mode
(config-router)#exit	Exit from Address-Family, Router and Configure mode.
(config)#commit	Commit the candidate configuration to the running configuration.

PE2

#configure terminal	Enter configure mode.
(config)#ip vrf 3	Create a VRF instance 3
(config-vrf)#rd 1:600	Configure unique RD value for VRF to identify VRF instance
(config-vrf)#route-target export 1:200	Configure route-target (rt) value for exporting routes into other VRFs (for other PE's)
(config-vrf)#exit	Exit VRF mode and enter Configure mode
(config)#ip vrf 4	Create a VRF instance 4
(config-vrf)#rd 1:900	Configure unique RD value for VRF to identify VRF instance
(config-vrf)#route-target both 1:400	Configure route-target (rt) value for exporting routes into other VRFs (for other PE's)
(config-vrf)#exit	Exit VRF mode and enter Configure mode
(config)#router ldp	Enable LDP.
(config-router)#exit	Exit router LDP mode
(config)#interface lo	Enter loopback interface mode
(config-if)#ip address 33.33.33.33/32 secondary	Configure IP address for loopback interface
(config-if)#enable-ldp ipv4	Enable LDP on loopback interface
(config-if)#exit	Exit interface mode
(config)#interface eth1	Enter interface mode
(config-if)#ip vrf forwarding 3	Bind interface to VRF 3
(config-if)#ip address 101.1.1.2/24	Configure IP address for VRF binded interface
(config-if)#exit	Exit interface mode
(config)#interface eth3	Enter interface mode
(config-if)#ip vrf forwarding 4	Bind interface to VRF 3
(config-if)#ip address 100.1.1.2/24	Configure IP address for VRF binded interface
(config-if)#exit	Exit interface mode
(config)#interface eth4	Enter interface mode
(config-if)#ip address 50.1.1.2/24	Configure an IP address for interface
(config-if)#label-switching	Enable label-switching on interface

BGP

(config-if)# enable-ldp ipv4	Enable LDP on connected interface between PE2 and RR
(config-if)#exit	Exit interface mode
(config)#commit	Commit the candidate configuration to the running configuration.
(config)#router ospf	Enable OSPF process between PE2 and RR
(config-router)#network 33.33.33.33/32 area 0.0.0.0	Advertise loopback network in OSPF area 0
(config-router)#network 50.1.1.0/24 area 0	Advertise PE2 to RR connected network in OSPF
(config-router)#exit	Exit router OSPF mode
(config)#commit	Commit the candidate configuration to the running configuration.
(config)# router bgp 100	Assign the ASN value (100) to the BGP router
(config-router)#neighbor 44.44.44.44 remote-as 100	Configure neighbor (RR) in IBGP
(config-router)#neighbor 44.44.44.44 update-source 33.33.33.33	Enable neighbor with loopback interface.
(config-router)#address-family vpnv4 unicast	Enter Address-Family-VPNv4 mode.
(config-router-af)#neighbor 44.44.44.44 activate	Activate RR neighbor
(config-router-af)#exit-address-family	Exit Address Family mode and return to Router mode.
(config-router)#address-family rtfilter unicast	Enable RT filter address-family mode
(config-router-af)#neighbor 44.44.44.44 activate	Activate neighbor
(config-router-af)#exit-address-family	Exit RTfilter Address Family mode and return to Router mode.
(config-router)#address-family ipv4 vrf 3	Enter Address-Family-VRF mode.
(config-router-af)#neighbor 101.1.1.1 remote-as 200	Configure CE neighbor in VRF mode
(config-router-af)#neighbor 101.1.1.1 activate	Activate neighbor in VRF
(config-router-af)#exit-address-family	Exit Address Family mode and return to Router mode.
(config-router)#address-family ipv4 vrf 4	Enter Address-Family-VRF mode.
(config-router-af)#neighbor 100.1.1.1 remote-as 200	Configure CE neighbor in VRF mode
(config-router-af)#neighbor 100.1.1.1 activate	Activate neighbor in VRF
(config-router-af)#exit-address-family	Exit Address Family mode and return to Router mode.
(config-router)#exit	Exit router and configure mode
(config)#commit	Commit the candidate configuration to the running configuration.

Validation

Through RTfilter address-family RT values will be exchanged between RR and PE's. Neighbors are activated under this address-family and configured clients as well in this. RR will learn routes from PE's and send to other PE's if it has any peer requesting for that particular routes based on their RT import values

Below outputs shows the routes sent and learned in PE's and installed in VRF's and display's RT filter values exchanged between them.

CE1

```
CE1#show ip bgp
BGP table version is 6, local router ID is 192.160.50.5
Status codes: s suppressed, d damped, h history, * valid, > best, i -
internal,
                l - labeled, S Stale
Origin codes: i - IGP, e - EGP, ? - incomplete

      Network          Next Hop           Metric      LocPrf      Weight Path
*>  1.1.1.0/24         0.0.0.0             0           100         32768      ?
*>  3.3.3.0/24         0.0.0.0             0           100         32768      ?
*>  4.4.4.0/24         0.0.0.0             0           100         32768      ?

Total number of prefixes 3
```

PE1

```
PE1#sh ip bgp vpnv4 all
Status codes: s suppressed, d damped, h history, * valid, > best, i -
internal, l - labeled
                S Stale
Origin codes: i - IGP, e - EGP, ? - incomplete

      Network          Next Hop           Metric      LocPrf      Weight Path
Route Distinguisher: 1:100 (Default for VRF 1)
*>  1.1.1.0/24         80.1.1.1             0           100         0          200
?
*>  3.3.3.0/24         80.1.1.1             0           100         0          200
?
*>  4.4.4.0/24         80.1.1.1             0           100         0          200
?
  Announced routes count = 3
  Accepted routes count = 0
Route Distinguisher: 1:300 (Default for VRF 2)
*>  1.1.1.0/24         90.1.1.1             0           100         0          200
?
*>  3.3.3.0/24         90.1.1.1             0           100         0          200
?
*>  4.4.4.0/24         90.1.1.1             0           100         0          200
?
  Announced routes count = 3
  Accepted routes count = 0
PE1#
```

```
PE1#show ip bgp rtfiler all
RTFilter's Received
*****
peer-ip 22.22.22.22
100:2:1:400
RTFilter's Sent
*****
peer-ip 22.22.22.22
```

BGP

```
100:2:1:400
PE1#
```

RR

```
RR#sh ip bgp vpnv4 all
Status codes: s suppressed, d damped, h history, * valid, > best, i -
internal, l - labeled
              S Stale
Origin codes: i - IGP, e - EGP, ? - incomplete
```

Network	Next Hop	Metric	LocPrf	Weight	Path
Route Distinguisher: 1:300					
*>i 1.1.1.0/24	11.11.11.11	0	100	0	200
?					
*>i 3.3.3.0/24	11.11.11.11	0	100	0	200
?					
*>i 4.4.4.0/24	11.11.11.11	0	100	0	200
?					

```
Announced routes count = 0
Accepted routes count = 3
```

```
RR#
```

```
RR#show ip bgp rtfilter all
```

```
RTFilter's Received
```

```
*****
```

```
peer-ip 11.11.11.11
```

```
100:2:1:400
```

```
peer-ip 33.33.33.33
```

```
100:2:1:400
```

```
RTFilter's Sent
```

```
*****
```

```
peer-ip 11.11.11.11
```

```
100:2:1:400
```

```
peer-ip 33.33.33.33
```

```
100:2:1:400
```

PE2

```
PE2#show ip bgp vpnv4 all
Status codes: s suppressed, d damped, h history, * valid, > best, i -
internal, l - labeled
              S Stale
Origin codes: i - IGP, e - EGP, ? - incomplete
```

Network	Next Hop	Metric	LocPrf	Weight	Path
Route Distinguisher: 1:300					
*>i 1.1.1.0/24	11.11.11.11	0	100	0	200
?					
*>i 3.3.3.0/24	11.11.11.11	0	100	0	200
?					
*>i 4.4.4.0/24	11.11.11.11	0	100	0	200
?					

```
Announced routes count = 0
```

```
Accepted routes count = 3
```

```
Route Distinguisher: 1:900 (Default for VRF 4)
```

*>i 1.1.1.0/24	11.11.11.11	0	100	0	200
?					

```

*>i 3.3.3.0/24      11.11.11.11      0      100      0      200
?
*>i 4.4.4.0/24      11.11.11.11      0      100      0      200
?
Announced routes count = 0
Accepted routes count = 3
PE2#

```

```

PE2#show ip bgp rtfiler all
RTFilter's Received
*****
peer-ip 44.44.44.44
100:2:1:400
RTFilter's Sent
*****
peer-ip 44.44.44.44
100:2:1:400
PE2#

```

BGP Best Path Selection Process

BGP assigns the first valid path as the current best path. BGP then compares the best path with the next path in the list, until BGP reaches the end of the list of valid paths. Below steps provides the rules that are used to determine the best path:

1. Prefer the path with the highest WEIGHT.
2. Prefer the path with the highest LOCAL_PREF.
3. Prefer the path that was locally originated via a network or aggregate BGP subcommand or through redistribution from an IGP.
4. Prefer the path with the shortest AS_PATH.

Note: Beware of these items:

- This step is skipped if user has configured the `bgp bestpath as-path ignore` command.
- If `bgp bestpath compare-confed-aspath` is configured then Prefer the path with the shortest AS_CONFED path.

5. Prefer the path with the lowest ORIGIN type.

Note: Beware of below listed items:

- IGP is lower than Exterior Gateway Protocol (EGP), and EGP is lower than INCOMPLETE.

6. Prefer the path with the lowest multi-exit discriminator (MED).

Note: Beware of these items:

- By default, MED is compared in these cases:
 - MEDs are compared only if the first AS in the AS_SEQUENCE is the same for multiple paths
 - If both the paths are internal as routes
 - If paths have confederation as-path then MEDs are compared only if the first AS in the BGP_AS_CONFED_SEQUENCE is the same for multiple paths

- To override all above checks, user can configure `bgp always-compare-med` command

7. Prefer eBGP over iBGP paths.

Note: Beware of below listed item:

- EBGP is preferred over IGBP or EBGP is preferred over CONFED.

8. Path learned from LU Address-family is preferred over IPv4 Unicast Address-family.

Note: Beware of these items:

- This is Exception Rule for IPv4 Labeled-Unicast Address-family.
- This rule applicable only for IPv4 Labeled-Unicast/Unicast routes over default VRF.

9. Prefer the path with the lowest IGP metric to the BGP next hop.

10. Determine if multiple paths require installation in the routing table for BGP Multipath and mark the ECMP candidate.

11. When both paths are external, prefer the path that was received first (the oldest one). This step minimizes route-flap, since a newer path won't displace an older one, even if it was the preferred route based on the additional decision criteria below. This has to be enabled by BGP command `bestpath tie-break-on-age`

Note: Beware of these items:

- Skip this step if any of these items are true:
 - If `bgp bestpath compare-routerid` is configured in addition to `bestpath tie-break-on-age`, then this step will be skipped.
 - If the router ID is same for multiple paths, because the routes were received from the same router, then this step will be skipped.

12. Router ID and Originator Id:

- If `bgp bestpath compare-routerid` is configured, then prefer the route that comes from the BGP router with the lowest Router ID.
- If `bgp bestpath dont-compare-originator-id` is not configured, prefer the route that comes from the BGP router with the lowest Router ID.

Note: Beware of the below listed item:

- If a path contains Route Reflector (RR) attributes, the Originator ID is substituted for the Router ID in the path selection process.
- If `bgp bestpath dont-compare-originator-id` is configured, prefer the route that comes from the BGP router with the lowest router ID. In this case, Originator ID is not compared even if the RR attribute is present.

13. If the originator or Router ID is the same for multiple paths, prefer the path with the minimum cluster list length.

Prefer the path that comes from the lowest neighbor address.

BGP Dampening

BGP supports route dampening for IPv4 and IPv6 prefixes. Route dampening minimizes the instability caused by route flapping. A penalty is added for every flap in a flapping route. As soon as the total penalty reaches the suppress limit, the advertisement of the route is suppressed. This penalty is decayed according to the configured half time value. Once the penalty is lower than the reuse limit, the route advertisement is unsuppressed. The dampening information is purged from the router once the penalty becomes less than half of the reuse limit.

Topology

In this example, a successful TCP connection is being established between the routers.



Figure 1-37: BGP dampening

IPv4 Configuration

R1

#configure terminal	Enter configure mode
(config)#interface lo	Enter loopback interface mode
(config-if)#ip address 1.1.1.1/32 secondary	Configure the secondary loopback address
(config-if)#exit	Exit interface mode
(config)#interface eth2	Enter interface mode
(config-if)#ip address 10.1.1.1/24	Configure the IP address of the interface
(config-if)#exit	Exit interface mode
(config)#interface eth1	Enter interface mode
(config-if)#ip address 101.1.0.1/24	Configure the IP address of the interface
(config-if)#exit	Exit interface mode
(config)#commit	Commit the candidate configuration to the running configuration.
(config)#router bgp 100	Configure BGP with the AS number 100
(config-router)#neighbor 10.1.1.2 remote-as 200	Define the BGP neighbor, and establish a TCP session. 10.1.1.2 is the IP address of one of the neighbors (R2), and 200 is the neighbor's AS number.
(config-router)#neighbor 100.1.0.2 remote-as 300	Define the BGP neighbor, and establish a TCP session. 100.1.0.2 is the IP address of one of the neighbors on interface eth1, and 300 is the neighbor's AS number.
(config-router)# address-family ipv4 unicast	Enter address-family ipv4 unicast mode
(config-router-af)#redistribute connected	Enable redistribute connected
(config-router-af)#neighbor 10.1.1.2 activate	Activate the neighbor
(config-router-af)#neighbor 100.1.0.2 activate	Activate the neighbor
(config-router-af)#exit-address-family	Exit address-family mode
(config-router)#commit	Commit the candidate configuration to the running configuration.

R2

#configure terminal	Enter configure mode
(config)#interface lo	Enter loopback interface mode
(config-if)# ip address 2.2.2.2/32 secondary	Configure the secondary loopback address
(config-if)#exit	Exit interface mode
(config)#interface eth1	Enter interface mode
(config-if)#ip address 10.1.1.2/24	Configure the IP address of the interface
(config-if)#exit	Exit interface mode
(config)#interface eth2	Enter interface mode
(config-if)#ip address 101.1.0.1/24	Configure the IP address of the interface
(config-if)#exit	Exit interface mode
(config)#commit	Commit the candidate configuration to the running configuration.
(config)#router bgp 200	Configure BGP with the AS number 100
(config-router)#neighbor 10.1.1.1 remote-as 100	Define the BGP neighbor, and establish a TCP session. 10.1.1.1 is the IP address of one of the neighbors (R1), and 100 is the neighbor's AS number.
(config-router)#neighbor 101.1.0.2 remote-as 400	Define the BGP neighbor, and establish a TCP session. 101.1.0.2 is the IP address of one of the neighbors on eth2 interface, and 400 is the neighbor's AS number.
(config-router)#neighbor 100.1.0.2 remote-as 300	Define the BGP neighbor, and establish a TCP session. 100.1.0.2 is the IP address of one of the neighbors of router R1 on eth1 interface, and 300 is the neighbor's AS number.
(config-router)#neighbor 100.1.0.2 ebgp-multihop 2	Increase BGP neighbors with ebgp-multihop value
(config-router)# address-family ipv4 unicast	Enter address-family ipv4 unicast mode
(config-router-af)#neighbor 10.1.1.1 activate	Activate BGP neighbor
(config-router-af)#neighbor 101.1.0.2 activate	Activate BGP neighbor
(config-router-af)#redistribute connected	Enable redistribute connected
(config-router-af)#bgp dampening	Enable BGP dampening with default values: <ul style="list-style-type: none"> • Reachability half-life is 15 minutes • Reuse limit is 750: • Suppress limit is 2000 • Max-suppress value is 60 minutes • Un-reachability half-life is 15 minutes
(config-router-af)#exit-address-family	Exit address-family mode
(config-router)#commit	Commit the candidate configuration to the running configuration.

Validation

R2

Verify the BGP dampening parameters.

```
#show ip bgp dampening parameters
```

```
dampening 15 750 2000 60 15 Dampening Control Block(s):
Reachability Half-Life time : 15 min Reuse penalty: 750
Suppress penalty: 2000
Max suppress time: 60 min Un-reachability Half-Life time : 15 min Max penalty (ceil):
11999
Min penalty (floor): 375
```

Verify BGP dampened paths for flapping networks.

```
#show ip bgp dampening dampened-paths
BGP table version is 21, local router ID is 4.4.4.2
Status codes: s suppressed, d damped, h history, * valid, > best, i - internal, l -
labeled, S Stale
Origin codes: i - IGP, e - EGP, ? - incomplete
```

```
NetworkFromReusePath
d 200.1.0.010.1.1.100:29:00 100300i
d 200.2.0.010.1.1.100:28:20 100300i
d 200.3.0.010.1.1.100:28:20 100300i
d 200.4.0.010.1.1.100:28:20 100300i
d 200.5.0.010.1.1.100:28:20 100300i
d 200.6.0.010.1.1.100:28:20 100300i
d 200.7.0.010.1.1.100:28:20 100300i
d 200.8.0.010.1.1.100:28:20 100300i
d 200.9.0.010.1.1.100:28:20 100300i
d 200.10.0.010.1.1.100:28:20 100300i
```

Verify BGP dampening flap statistics for flapping networks.

```
#show ip bgp dampening flap-statistics
BGP table version is 21, local router ID is 4.4.4.2
Status codes: s suppressed, d damped, h history, * valid, > best, i - internal, l -
labeled, S Stale
Origin codes: i - IGP, e - EGP, ? - incomplete
```

```
NetworkFromFlapsDurationReusePath
d 200.1.0.010.1.1.1800:18:3700:29:10100 300i
d 200.2.0.010.1.1.1700:14:2200:29:00100 300i
d 200.3.0.010.1.1.1700:14:2200:29:00100 300i
d 200.4.0.010.1.1.1700:14:2200:29:00100 300i
d 200.5.0.010.1.1.1700:14:2200:29:00100 300i
d 200.6.0.010.1.1.1700:14:2200:29:00100 300i
d 200.7.0.010.1.1.1700:14:2200:29:00100 300i
d 200.8.0.010.1.1.1700:14:2200:29:00100 300i
```

```
d 200.9.0.010.1.1.1700:14:2200:29:00100 300i
d 200.10.0.010.1.1.1700:14:2200:29:00100 300i
```

IPv6 Configuration

R1

#configure terminal	Enter configure mode
(config)#interface eth1	Enter interface mode
(config-if)#ipv6 address 2000:0:0:1::1/64	Configure the IPv6 address of the interface
(config-if)#exit	Exit interface mode
(config)#interface eth2	Enter interface mode
(config-if)#ip address 2000:0:2:1::1/64	Configure the IPv6 address of the interface
(config-if)#exit	Exit interface mode
(config)#router bgp 100	Configure BGP with the AS number 100
(config-router)#neighbor 2000:0:0:1::2 remote-as 300	Define the BGP neighbor, and establish a TCP session. 2000:0:0:1::2 is the IP address of one of the neighbors on interface eth1, and 300 is the neighbor's AS number.
(config-router)#neighbor 2000:0:2:1::2 remote-as 200	Define the BGP neighbor, and establish a TCP session. 2000:0:2:1::2 is the IP address of one of the neighbors (R2), and 200 is the neighbor's AS number.
(config-router)#address-family ipv6 unicast	Enter IPv6 address family
(config-router)#redistribute connected	Enable redistribute connected
(config-router-af)#neighbor 2000:0:0:1::2 activate	Activate BGP neighbor
(config-router-af)#neighbor 2000:0:2:1::2 activate	Activate BGP neighbor
(config-router-af)#exit-address-family	Exit address-family mode
(config-router)#commit	Commit the candidate configuration to the running configuration.

R2

#configure terminal	Enter configure mode
(config)#interface eth1	Enter interface mode
(config-if)#ip address 2000:0:2:1::2/64	Configure the IPv6 address of the interface
(config-if)#exit	Exit interface mode
(config)#interface eth2	Enter interface mode
(config-if)#ip address 2000:0:1:1::1/64	Configure the IPv6 address of the interface
(config-if)#exit	Exit interface mode
(config)#router bgp 200	Configure BGP with the AS number 200
(config-router)#address-family ipv6 unicast	Enter IPv6 address family
(config-router-af)#redistribute connected	Enable redistribute connected
(config-router-af)#exit-address-family	Exit address-family mode.

(config-router)#neighbor 2000:0:1:1::2 remote-as 400	Define the BGP neighbor, and establish a TCP session. 2000:0:1:1::2 is the IP address of one of the neighbors on interface eth2, and 400 is the neighbor's AS number.
(config-router)#neighbor 2000:0:2:1::1 remote-as 100	Define the BGP neighbor, and establish a TCP session. 2000:0:2:1::1 is the IP address of one of the neighbors (R1), and 100 is the neighbor's AS number.
(config-router)#address-family ipv6 unicast	Enter IPv6 address-family
(config-router-af)#bgp dampening	Enable BGP dampening with default values: <ul style="list-style-type: none"> • Reachability half-life is 15 minutes • Reuse limit is 750 • Suppress limit is 2000 • Max-suppress value is 60 minutes • Un-reachability half-life is 15 minutes
(config-router-af)#neighbor 2000:0:1:1::2 activate	Activate BGP neighbor
(config-router-af)#neighbor 2000:0:2:1::1 activate	Activate BGP neighbor
(config-router-af)#exit-address-family	Exit address-family mode
(config-router)#commit	Commit the candidate configuration to the running configuration.

Validation

R2

Verify the IPv6 BGP dampening parameters.

```
#sh bgp dampening parameters
```

```
dampening 15 750 2000 60 15
Dampening Control Block(s):
  Reachability Half-Life time      : 15 min
  Reuse penalty                     : 750
  Suppress penalty                  : 2000
  Max suppress time                 : 60 min
  Un-reachability Half-Life time    : 15 min
  Max penalty (ceil)                : 11999
  Min penalty (floor)               : 375
```

Verify IPv6 BGP dampened paths for flapping networks.

```
#sh bgp dampening dampened-paths
BGP table version is 7, local router ID is 4.4.4.2
Status codes: s suppressed, d damped, h history, * valid, > best, i - internal,
               l - labeled, S Stale
Origin codes: i - IGP, e - EGP, ? - incomplete
```

```
Network          From          Reuse Path
*d 3000:0:1:1::/64 2000:0:2:1::1(fe80::ba6a:97ff:fed6:23d4)
                                00:18:30 100 300 i
```

BGP

```
*d 3000:0:2:1::/64 2000:0:2:1::1 (fe80::ba6a:97ff:fed6:23d4)
                                00:18:30 100 300 i
*d 3000:0:3:1::/64 2000:0:2:1::1 (fe80::ba6a:97ff:fed6:23d4)
                                00:18:30 100 300 i
*d 3000:0:4:1::/64 2000:0:2:1::1 (fe80::ba6a:97ff:fed6:23d4)
                                00:18:30 100 300 i
*d 3000:0:5:1::/64 2000:0:2:1::1 (fe80::ba6a:97ff:fed6:23d4)
                                00:18:30 100 300 i
*d 3000:0:6:1::/64 2000:0:2:1::1 (fe80::ba6a:97ff:fed6:23d4)
                                00:18:30 100 300 i
*d 3000:0:7:1::/64 2000:0:2:1::1 (fe80::ba6a:97ff:fed6:23d4)
                                00:18:30 100 300 i
*d 3000:0:8:1::/64 2000:0:2:1::1 (fe80::ba6a:97ff:fed6:23d4)
                                00:18:30 100 300 i
*d 3000:0:9:1::/64 2000:0:2:1::1 (fe80::ba6a:97ff:fed6:23d4)
                                00:18:30 100 300 i
*d 3000:0:a:1::/64 2000:0:2:1::1 (fe80::ba6a:97ff:fed6:23d4)
                                00:18:30 100 300 i
```

Verify IPv6 BGP dampening flap statistics for flapping networks.

```
#sh bgp dampening flap-statistics
BGP table version is 7, local router ID is 4.4.4.2
Status codes: s suppressed, d damped, h history, * valid, > best, i - internal,
               l - labeled, S Stale
Origin codes: i - IGP, e - EGP, ? - incomplete
```

Network	From	Flaps	Duration	Reuse	Path
*d 3000:0:1:1::/64	2000:0:2:1::1 (fe80::ba6a:97ff:fed6:23d4)	4	00:05:19	00:18:30	100 300 i
*d 3000:0:2:1::/64	2000:0:2:1::1 (fe80::ba6a:97ff:fed6:23d4)	4	00:05:19	00:18:30	100 300 i
*d 3000:0:3:1::/64	2000:0:2:1::1 (fe80::ba6a:97ff:fed6:23d4)	4	00:05:19	00:18:30	100 300 i
*d 3000:0:4:1::/64	2000:0:2:1::1 (fe80::ba6a:97ff:fed6:23d4)	4	00:05:19	00:18:30	100 300 i
*d 3000:0:5:1::/64	2000:0:2:1::1 (fe80::ba6a:97ff:fed6:23d4)	4	00:05:19	00:18:30	100 300 i
*d 3000:0:6:1::/64	2000:0:2:1::1 (fe80::ba6a:97ff:fed6:23d4)	4	00:05:19	00:18:30	100 300 i
*d 3000:0:7:1::/64	2000:0:2:1::1 (fe80::ba6a:97ff:fed6:23d4)	4	00:05:19	00:18:30	100 300 i
*d 3000:0:8:1::/64	2000:0:2:1::1 (fe80::ba6a:97ff:fed6:23d4)	4	00:05:19	00:18:30	100 300 i
*d 3000:0:9:1::/64	2000:0:2:1::1 (fe80::ba6a:97ff:fed6:23d4)	4	00:05:19	00:18:30	100 300 i
*d 3000:0:a:1::/64	2000:0:2:1::1 (fe80::ba6a:97ff:fed6:23d4)	4	00:05:19	00:18:30	100 300 i

BGP Authentication

BGP authentication allows users to receive selected routing information, enhancing security of their network traffic. When BGP authentication is enabled on a router, the router verifies routing packets it receives by exchanging a password that is configured on both the sending and receiving routers.

In this example, both R1 and R2 have ABC as the password. Configure the same password on all routers that are to communicate using BGP in a network.

Topology

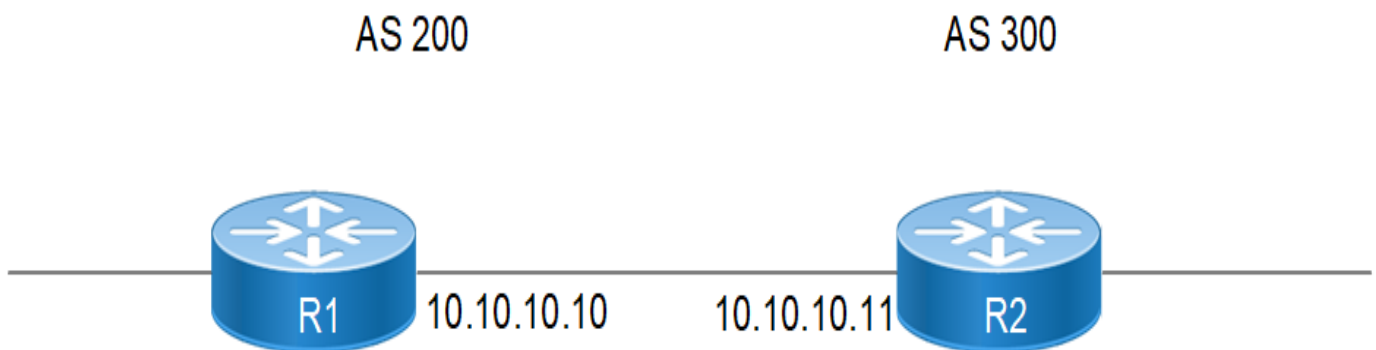

Figure 1-38: BGP Authentication

Configuration

R1

#configure terminal	Enter configure mode
(config)#interface xe0	Enter interface mode
(config-if)#ip address 10.10.10.10/24	Assign ip address
(config-if)#exit	Exit interface mode
(config)#router bgp 200	Enter BGP router mode
(config-router)#neighbor 10.10.10.11 remote-as 300	Configure neighborhood
(config-router)#neighbor 10.10.10.11 authentication-key 0 ABC	Configure authentication for BGP neighbors
(config-router)#address-family ipv4 unicast	Enter ipv4 address family
(config-router-af)#neighbor 10.10.10.11 activate	Activate neighborhood
(config-router-af)#exit-address-family	Exit address family
(config-router)#exit	End config mode
(config)#commit	Commit the candidate configuration to the running configuration.

R2

#configure terminal	Enter configure mode
(config)#interface ce2/1	Enter interface mode
(config-if)#ip address 10.10.10.11/24	Assign ip address
(config-if)#exit	Exit interface mode
(config)#router bgp 200	Enter BGP router mode
(config-router)#neighbor 10.10.10.10 remote-as 200	Configure neighborhood
(config-router)#neighbor 10.10.10.10 authentication-key 0 ABC	Configure authentication for BGP neighbors
(config-router)#address-family ipv4 unicast	Enter ipv4 address family
(config-router-af)#neighbor 10.10.10.10 activate	Activate neighborhood
(config-router-af)#exit-address-family	Exit address family
(config-router)#exit	End config mode
(config)#commit	Commit the candidate configuration to the running configuration.

Validation**R1**

```
#show running-config bgp
!
router bgp 200
 neighbor 10.10.10.11 remote-as 300
 neighbor 10.10.10.11 authentication-key 0x624ac41428f81e33
!
 address-family ipv4 unicast
 neighbor 10.10.10.11 activate
 exit-address-family
!
#show ip bgp neighbors
BGP neighbor is 10.10.10.11, remote AS 300, local AS 200, external link
BGP version 4, local router ID 22.22.22.22, remote router ID 2.2.2.2
BGP state = Established, up for 00:09:14
Last read 00:00:19, hold time is 90, keepalive interval is 30 seconds
Neighbor capabilities:
  Route refresh: advertised and received (old and new)
  Address family IPv4 Unicast: advertised and received
Received 23 messages, 0 notifications, 0 in queue
Sent 24 messages, 0 notifications, 0 in queue
Route refresh request: received 0, sent 0
Minimum time between advertisement runs is 30 seconds
For address family: IPv4 Unicast
BGP table version 1, neighbor version 1
Index 1, Offset 0, Mask 0x2
Community attribute sent to this neighbor (both)
0 accepted prefixes
0 announced prefixes
```

```

Connections established 1; dropped 0
Local host: 10.10.10.10, Local port: 179
Foreign host: 10.10.10.11, Foreign port: 37590
Nexthop: 10.10.10.10
Nexthop global: ::
Nexthop local: ::
BGP connection: non shared network

```

R2

```

#show running-config bgp
!
router bgp 300
 neighbor 10.10.10.10 remote-as 200
 neighbor 10.10.10.10 authentication-key 0x624ac41428f81e33
!
 address-family ipv4 unicast
 neighbor 10.10.10.10 activate
 exit-address-family
!
#show ip bgp neighbors
BGP neighbor is 10.10.10.10, remote AS 200, local AS 300, external link
 BGP version 4, local router ID 2.2.2.2, remote router ID 22.22.22.22
 BGP state = Established, up for 00:13:57
 Last read 00:00:22, hold time is 90, keepalive interval is 30 seconds
 Neighbor capabilities:
  Route refresh: advertised and received (old and new)
  Address family IPv4 Unicast: advertised and received
 Received 33 messages, 0 notifications, 0 in queue
 Sent 34 messages, 0 notifications, 0 in queue
 Route refresh request: received 0, sent 0
 Minimum time between advertisement runs is 30 seconds
 For address family: IPv4 Unicast
 BGP table version 1, neighbor version 1
 Index 1, Offset 0, Mask 0x2
 Community attribute sent to this neighbor (both)
 0 accepted prefixes
 0 announced prefixes

Connections established 1; dropped 0
Local host: 10.10.10.11, Local port: 37590
Foreign host: 10.10.10.10, Foreign port: 179
Nexthop: 10.10.10.11
Nexthop global: ::
Nexthop local: ::
BGP connection: non shared network

```

BGP Unnumbered

This chapter contains configurations for BGP unnumbered interface which provides BGP peering with minimal configuration.

Overview

BGP protocol is used to exchange IP prefixes between AS. For BGP neighbor ship to be established, IPv4 address configuration on peer is pre-requisite. In a large network, this can consume a lot of your address space, requiring a separate IP address for each peer-facing interface apart from administrator effort in configuration. When a BGP peer advertises an IPv4 prefix, it must include an IPv4 next hop address, which is usually the address of the advertising router; for this each BGP peer should have an IPv4 address. This feature is to enable BGP peering with minimal configuration, less IPv4 address-space.

For DC use-case, where hundreds of switches can be connected in CLOS topology, configuring each neighbor is both time consuming and (IPv4) address hungry.

To minimize this, BGP unnumbered can, avoid the need for an IP address on each BGP interface and by removing the need to configure the IP address and ASN of each neighbor. This feature uses link local ipv6 address of interface as per RFC-5549.

Topology

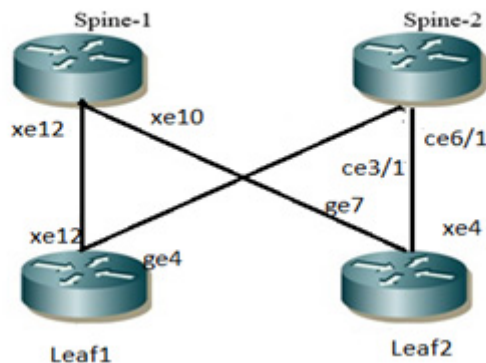

Figure 1-39: BGP unnumbered

Configuration

Spine 1

configure terminal	Enter configure mode
(config)#interface lo	Enter interface mode for loopback interface
(config-if)#ip add 1.1.1.1/32 secondary	Assign secondary interface to loopback
(config-if)#exit	Exit interface mode
(config)#interface xe12	Enter interface mode
(config-if)# ipv6 nd ra-interval 4	Assign the IPv6 Router Advertisements interval
(config-if)#exit	Exit interface mode
(config)#interface xe10	Enter interface mode
(config-if)# ip address 10.10.10.2/31	Assign IP address to the interface in /31 subnet
(config-if)#exit	Exit interface mode
(config)#router bgp 100	Enter bgp router mode
(config-router)#bgp router-id 1.1.1.1	Assign router id for BGP
(config-router)#bgp unnumbered-mode	Enter bgp unnumbered mode
(config-router-unnum)#neighbor xe12 remote-as internal	Configure iBGP neighborship
(config-router-unnum)#neighbor xe10 remote-as internal	Configure iBGP neighborship
(config-router-unnum)# exit-unnumbered-mode	Exit unnumbered mode
(config-router)#address-family ipv4 unicast	Enter address family mode for IPv4 unicast
(config-router-af)# bgp v4-unnumbered-mode	Enter unnumbered mode under ipv4 unicast af
(config-router-v4-unnum)# neighbor xe10 activate	Activate the neighbor
(config-router-v4-unnum)# neighbor xe12 activate	Activate the neighbor
(config-router-v4-unnum)# exit-v4-unnumbered-mode	Exit unnumbered mode under ipv4 unicast af
(config-router-af)# exit-address-family	Exit address family mode for IPv4 unicast
(config-router)#end	End Config mode

Spine 2

configure terminal	Enter configure mode
(config)#interface lo	Enter interface mode for loopback interface
(config-if)# ip address 2.2.2.2/32 secondary	Assign secondary interface to loopback
(config-if)#exit	Exit interface mode
(config)# interface ce6/1	Enter interface mode
(config-if)# ipv6 nd ra-interval 4	Assign the IPv6 Router Advertisements interval
(config-if)#exit	Exit interface mode
(config)# interface ce3/1	Enter interface mode

BGP

(config-if)# ip address 20.20.20.2/31	Assign IP address to the interface in /31 subnet
(config-if)#exit	Exit interface mode
(config)#router bgp 100	Enter bgp router mode
(config-router)#bgp router-id 2.2.2.2	Assign router id for BGP
(config-router)#bgp unnumbered-mode	Enter bgp unnumbered mode
(config-router-unnum)#neighbor ce3/1 remote-as internal	Configure iBGP neighborhood
(config-router-unnum)#neighbor ce6/1 remote-as internal	Configure iBGP neighborhood
(config-router-unnum)# exit-unnumbered-mode	Exit unnumbered mode
(config-router)#address-family ipv4 unicast	Enter address family mode for IPv4 unicast
(config-router-af)# bgp v4-unnumbered-mode	Enter unnumbered mode under ipv4 unicast af
(config-router-v4-unnum)# neighbor ce3/1 activate	Activate the neighbor
(config-router-v4-unnum)# neighbor ce6/1 activate	Activate the neighbor
(config-router-v4-unnum)# exit-v4-unnumbered-mode	Exit unnumbered mode under ipv4 unicast af
(config-router-af)# exit-address-family	Exit address family mode for IPv4 unicast
(config-router)#end	End Config mode

Leaf 1

configure terminal	Enter configure mode
(config)#interface lo	Enter interface mode for loopback interface
(config-if)# ip address 3.3.3.3/32 secondary	Assign secondary interface to loopback
(config-if)#exit	Exit interface mode
(config)#interface xe12	Enter interface mode
(config-if)# ipv6 nd ra-interval 4	Assign the IPv6 Router Advertisements interval
(config-if)#exit	Exit interface mode
(config)#interface ge4	Enter interface mode
(config-if)# ip address 10.10.10.3/31	Assign IP address to the interface in /31 subnet
(config-if)#exit	Exit interface mode
(config)#router bgp 100	Enter bgp router mode
(config-router)#bgp router-id 3.3.3.3	Assign router id for BGP
(config-router)#bgp unnumbered-mode	Enter bgp unnumbered mode
(config-router-unnum)#neighbor xe12 remote-as internal	Configure iBGP neighborhood
(config-router-unnum)#neighbor ge4 remote-as internal	Configure iBGP neighborhood
(config-router-unnum)# exit-unnumbered-mode	Exit unnumbered mode
(config-router)#address-family ipv4 unicast	Enter address family mode for IPv4 unicast
(config-router-af)# bgp v4-unnumbered-mode	Enter unnumbered mode under ipv4 unicast af

(config-router-v4-unnum)# neighbor ge4 activate	Activate the neighbor
(config-router-v4-unnum)# neighbor xe12 activate	Activate the neighbor
(config-router-v4-unnum)# exit-v4-unnumbered-mode	Exit unnumbered mode under ipv4 unicast af
(config-router-af)# exit-address-family	Exit address family mode for IPv4 unicast
(config-router)#end	End Config mode

Leaf 2

configure terminal	Enter configure mode
(config)#interface lo	Enter interface mode for loopback interface
(config-if)#ip address 4.4.4.4/32 secondary	Assign secondary interface to loopback
(config-if)#exit	Exit interface mode
(config)#interface xe4	Enter interface mode
(config-if)# ipv6 nd ra-interval 4	Assign the IPv6 Router Advertisements interval
(config-if)#exit	Exit interface mode
(config)#interface ge7	Enter interface mode
(config-if)# ip address 10.10.10.2/31	Assign IP address to the interface in /31 subnet
(config-if)#exit	Exit interface mode
(config)#router bgp 100	Enter bgp router mode
(config-router)#bgp router-id 4.4.4.4	Assign router id for BGP
(config-router)#bgp unnumbered-mode	Enter bgp unnumbered mode
(config-router-unnum)#neighbor xe4 remote-as internal	Configure iBGP neighborship
(config-router-unnum)#neighbor ge7 remote-as internal	Configure iBGP neighborship
(config-router-unnum)# exit-unnumbered-mode	Exit unnumbered mode
(config-router)#address-family ipv4 unicast	Enter address family mode for IPv4 unicast
(config-router-af)# bgp v4-unnumbered-mode	Enter unnumbered mode under ipv4 unicast af
(config-router-v4-unnum)# neighbor ge7 activate	Activate the neighbor
(config-router-v4-unnum)# neighbor xe4 activate	Activate the neighbor
(config-router-v4-unnum)# exit-v4-unnumbered-mode	Exit unnumbered mode under ipv4 unicast af
(config-router-af)# exit-address-family	Exit address family mode for IPv4 unicast
(config-router)#end	End Config mode

Validation

Spine 1:

```
Spine1#show ip bgp neighbors
```

```
BGP neighbor is 10.10.10.3, remote AS 100, local AS 100, internal link
  BGP version 4, local router ID 1.1.1.1, remote router ID 4.4.4.4
  BGP state = Established, up for 00:22:12
  Last read 00:00:06, hold time is 90, keepalive interval is 30 seconds
  Neighbor capabilities:
    Route refresh: advertised and received (old and new)
    Address family IPv4 Unicast: advertised and received
  Received 54 messages, 0 notifications, 0 in queue
  Sent 54 messages, 0 notifications, 0 in queue
  Route refresh request: received 0, sent 0
  Minimum time between advertisement runs is 5 seconds
For address family: IPv4 Unicast
  BGP table version 1, neighbor version 1
  Index 2, Offset 0, Mask 0x4
  Community attribute sent to this neighbor (both)
  0 accepted prefixes
  0 announced prefixes

Connections established 1; dropped 0
Local host: 10.10.10.2, Local port: 179
Foreign host: 10.10.10.3, Foreign port: 49242
Nexthop: 10.10.10.2
Nexthop global: ::
Nexthop local: ::
BGP connection: non shared network
```

```
BGP neighbor is fe80::eac5:7aff:fefe:97e0, remote AS 100, local AS 100, internal link
  BGP version 4, local router ID 1.1.1.1, remote router ID 3.3.3.3
  BGP state = Established, up for 00:29:54
  Last read 00:00:12, hold time is 90, keepalive interval is 30 seconds
  Neighbor capabilities:
    Route refresh: advertised and received (old and new)
    Address family IPv4 Unicast: advertised and received
  Received 71 messages, 0 notifications, 0 in queue
  Sent 74 messages, 0 notifications, 0 in queue
  Route refresh request: received 0, sent 0
  Minimum time between advertisement runs is 5 seconds
For address family: IPv4 Unicast
  BGP table version 1, neighbor version 1
  Index 1, Offset 0, Mask 0x2
  Community attribute sent to this neighbor (both)
  0 accepted prefixes
  0 announced prefixes

Connections established 1; dropped 0
```

Local host: fe80::eac5:7aff:fe8b:a82a, Local port: 179
Foreign host: fe80::eac5:7aff:fefe:97e0, Foreign port: 37116
Nexthop: 1.1.1.1
Nexthop global: fe80::eac5:7aff:fe8b:a82a
Nexthop local: fe80::eac5:7aff:fe8b:a82a
BGP connection: shared network

Spine 2:

```
Spine2#show ip bgp neighbors
BGP neighbor is 20.20.20.3, remote AS 100, local AS 100, internal link
  BGP version 4, local router ID 2.2.2.2, remote router ID 3.3.3.3
  BGP state = Established, up for 00:21:15
  Last read 00:00:12, hold time is 90, keepalive interval is 30 seconds
  Neighbor capabilities:
    Route refresh: advertised and received (old and new)
    Address family IPv4 Unicast: advertised and received
  Received 52 messages, 0 notifications, 0 in queue
  Sent 51 messages, 0 notifications, 0 in queue
  Route refresh request: received 0, sent 0
  Minimum time between advertisement runs is 5 seconds
For address family: IPv4 Unicast
  BGP table version 1, neighbor version 1
  Index 1, Offset 0, Mask 0x2
  Community attribute sent to this neighbor (both)
  0 accepted prefixes
  0 announced prefixes

Connections established 1; dropped 0
Local host: 20.20.20.2, Local port: 59380
Foreign host: 20.20.20.3, Foreign port: 179
Nexthop: 20.20.20.2
Nexthop global: ::
Nexthop local: ::
BGP connection: non shared network

BGP neighbor is fe80::36ef:b6ff:fe31:dd3f, remote AS 100, local AS 100, internal link
  BGP version 4, local router ID 2.2.2.2, remote router ID 4.4.4.4
  BGP state = Established, up for 00:29:31
  Last read 00:00:21, hold time is 90, keepalive interval is 30 seconds
  Neighbor capabilities:
    Route refresh: advertised and received (old and new)
    Address family IPv4 Unicast: advertised and received
  Received 70 messages, 0 notifications, 0 in queue
  Sent 72 messages, 0 notifications, 0 in queue
  Route refresh request: received 0, sent 0
  Minimum time between advertisement runs is 5 seconds
For address family: IPv4 Unicast
  BGP table version 1, neighbor version 1
  Index 2, Offset 0, Mask 0x4
```

```
Community attribute sent to this neighbor (both)
0 accepted prefixes
0 announced prefixes
```

```
Connections established 1; dropped 0
Local host: fe80::ce37:abff:fe3f:9f63, Local port: 179
Foreign host: fe80::36ef:b6ff:fe31:dd3f, Foreign port: 33368
Nexthop: 2.2.2.2
Nexthop global: fe80::ce37:abff:fe3f:9f63
Nexthop local: fe80::ce37:abff:fe3f:9f63
BGP connection: shared network
```

Leaf 1

```
Leaf1#show ip bgp neighbors
BGP neighbor is 20.20.20.2, remote AS 100, local AS 100, internal link
  BGP version 4, local router ID 3.3.3.3, remote router ID 2.2.2.2
  BGP state = Established, up for 00:21:32
  Last read 00:00:05, hold time is 90, keepalive interval is 30 seconds
  Neighbor capabilities:
    Route refresh: advertised and received (old and new)
    Address family IPv4 Unicast: advertised and received
  Received 52 messages, 0 notifications, 0 in queue
  Sent 54 messages, 0 notifications, 0 in queue
  Route refresh request: received 0, sent 0
  Minimum time between advertisement runs is 5 seconds
For address family: IPv4 Unicast
  BGP table version 1, neighbor version 1
  Index 1, Offset 0, Mask 0x2
  Community attribute sent to this neighbor (both)
  0 accepted prefixes
  0 announced prefixes
```

```
Connections established 1; dropped 0
Local host: 20.20.20.3, Local port: 179
Foreign host: 20.20.20.2, Foreign port: 59380
Nexthop: 20.20.20.3
Nexthop global: ::
Nexthop local: ::
BGP connection: non shared network
```

```
BGP neighbor is fe80::eac5:7aff:fe8b:a82a, remote AS 100, local AS 100, internal
link
  BGP version 4, local router ID 3.3.3.3, remote router ID 1.1.1.1
  BGP state = Established, up for 00:30:46
  Last read 00:00:06, hold time is 90, keepalive interval is 30 seconds
  Neighbor capabilities:
    Route refresh: advertised and received (old and new)
    Address family IPv4 Unicast: advertised and received
  Received 74 messages, 0 notifications, 0 in queue
  Sent 73 messages, 0 notifications, 0 in queue
```

```
Route refresh request: received 0, sent 0
Minimum time between advertisement runs is 5 seconds
For address family: IPv4 Unicast
  BGP table version 1, neighbor version 1
  Index 2, Offset 0, Mask 0x4
  Community attribute sent to this neighbor (both)
  0 accepted prefixes
  0 announced prefixes

Connections established 1; dropped 0
Local host: fe80::eac5:7aff:fefe:97e0, Local port: 37116
Foreign host: fe80::eac5:7aff:fe8b:a82a, Foreign port: 179
Nexthop: 3.3.3.3
Nexthop global: fe80::eac5:7aff:fefe:97e0
Nexthop local: fe80::eac5:7aff:fefe:97e0
BGP connection: shared network
```

Leaf 2

```
Leaf2#show ip bgp neighbors
BGP neighbor is 10.10.10.2, remote AS 100, local AS 100, internal link
  BGP version 4, local router ID 4.4.4.4, remote router ID 1.1.1.1
  BGP state = Established, up for 00:23:24
  Last read 00:00:09, hold time is 90, keepalive interval is 30 seconds
  Neighbor capabilities:
    Route refresh: advertised and received (old and new)
    Address family IPv4 Unicast: advertised and received
  Received 56 messages, 0 notifications, 0 in queue
  Sent 57 messages, 0 notifications, 0 in queue
  Route refresh request: received 0, sent 0
  Minimum time between advertisement runs is 5 seconds
For address family: IPv4 Unicast
  BGP table version 1, neighbor version 1
  Index 2, Offset 0, Mask 0x4
  Community attribute sent to this neighbor (both)
  0 accepted prefixes
  0 announced prefixes

Connections established 1; dropped 0
Local host: 10.10.10.3, Local port: 49242
Foreign host: 10.10.10.2, Foreign port: 179
Nexthop: 10.10.10.3
Nexthop global: ::
Nexthop local: ::
BGP connection: non shared network

BGP neighbor is fe80::ce37:abff:fe3f:9f63, remote AS 100, local AS 100, internal
link
  BGP version 4, local router ID 4.4.4.4, remote router ID 2.2.2.2
  BGP state = Established, up for 00:30:09
  Last read 00:00:08, hold time is 90, keepalive interval is 30 seconds
```

Neighbor capabilities:

Route refresh: advertised and received (old and new)

Address family IPv4 Unicast: advertised and received

Received 72 messages, 0 notifications, 0 in queue

Sent 72 messages, 0 notifications, 0 in queue

Route refresh request: received 0, sent 0

Minimum time between advertisement runs is 5 seconds

For address family: IPv4 Unicast

BGP table version 1, neighbor version 1

Index 1, Offset 0, Mask 0x2

Community attribute sent to this neighbor (both)

0 accepted prefixes

0 announced prefixes

Connections established 1; dropped 0

Local host: fe80::36ef:b6ff:fe31:dd3f, Local port: 33368

Foreign host: fe80::ce37:abff:fe3f:9f63, Foreign port: 179

Next hop: 4.4.4.4

Next hop global: fe80::36ef:b6ff:fe31:dd3f

Next hop local: fe80::36ef:b6ff:fe31:dd3f

BGP connection: shared network

BGP Blackhole Community Attribute

A blackhole route is used to forward unwanted or undesirable traffic into a black hole. In other words, a special logical interface called a null interface, is used to create the black hole. Static routes are created for destinations that are not desirable, and the static route configuration points to the null interface. Any traffic that has a destination address that has a best match of the black hole static route automatically will be dropped.

Note: 65535:666 is reserved for Blackhole community.

Topology

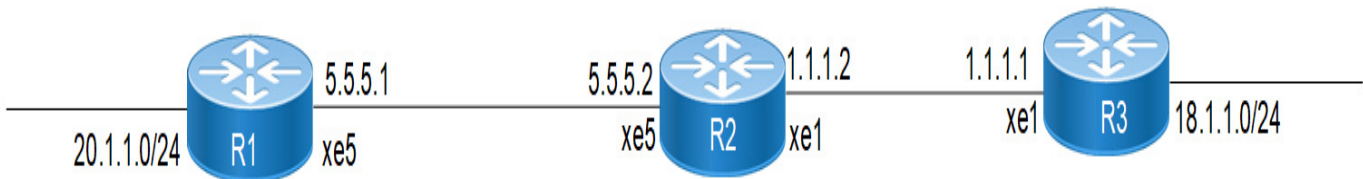

Figure 1-40: BGP Blackhole Community Attribute topology

Configuration

R1

#configure terminal	Enter Configure mode.
(config)#interface xe5	Enter Interface mode
(config-if)# ip address 5.5.5.1/24	Assign IP address to interface

(config-if)#exit	Exit interface mode
(config)#interface xe20	Enter Interface mode
(config-if)# ip address 20.1.1.1/24	Assign IP address to interface
(config-if)#exit	Exit interface mode
(config)# router bgp 100	Enter Router BGP mode
(config-router)# neighbor 5.5.5.2 remote-as 200	Define BGP neighbors. 5.5.5.2 is the IP address of the neighbor (R2) and 200 is the neighbors AS number
(config-router)# address-family ipv4 unicast	Enter into BGP address family IPv4
(config-router-af)#neighbor 5.5.5.2 activate	Activate the neighbor
(config-router-af)#network 20.1.1.0/24	Advertise networks with prefix
(config-router-af)# commit	Commit the configurations
(config-router-af)# end	Return to privilege mode

R2

#configure terminal	Enter Configure mode.
(config)#interface xe5	Enter Interface mode
(config-if)# ip address 5.5.5.2/24	Assign IP address to interface
(config-if)#exit	Exit interface mode
(config)#interface xe1	Enter Interface mode
(config-if)# ip address 1.1.1.2/24	Assign IP address to interface
(config-if)#exit	Exit interface mode
(config)# router bgp 200	Enter Router BGP mode
(config-router)# neighbor 5.5.5.1 remote-as 100	Define BGP neighbors. 5.5.5.1 is the IP address of the neighbor (R1) and 100 is the neighbors AS number
(config-router)# neighbor 1.1.1.1 remote-as 300	Define BGP neighbors. 1.1.1.1 is the IP address of the neighbor (R3) and 300 is the neighbors AS number
(config-router)# address-family ipv4 unicast	Enter into BGP address family IPv4
(config-router-af)#neighbor 5.5.5.1 activate	Activate the neighbor
(config-router-af)#neighbor 1.1.1.1 activate	Activate the neighbor
(config-router-af)# commit	Commit the configurations
(config-router-af)# end	Return to privilege mode

R3

#configure terminal	Enter Configure mode.
(config)#interface xe1	Enter Interface mode
(config-if)# ip address 1.1.1.1/24	Assign IP address to interface
(config-if)#exit	Exit interface mode
(config)#interface xe18	Enter Interface mode
(config-if)# ip address 18.1.1.1/24	Assign IP address to interface
(config-if)#exit	Exit interface mode
(config)# router bgp 300	Enter Router BGP mode

BGP

(config-router)# neighbor 1.1.1.2 remote-as 200	Define BGP neighbors. 1.1.1.2 is the IP address of the neighbor (R2) and 200 is the neighbors AS number
(config-router)# address-family ipv4 unicast	Enter into BGP address family IPv4
(config-router-af)#neighbor 1.1.1.2 activate	Activate the neighbor
(config-router-af)#network 18.1.1.0/24	Advertise networks with prefix
(config-router-af)# commit	Commit the configurations
(config-router-af)# end	Return to privilege mode

Black Hole configuration on R3

#configure terminal	Enter Configure mode.
(config)#route-map D permit 10	Enter Route-map mode to set the match operation
(config-route-map)#set community no-export 65535:666 additive	Configure Reserved Black hole community in Route-map mode
(config-route-map)#commit	Commit the configuration
(config-route-map)#exit	Return to configuration mode
(config)#router bgp 300	Enter Router BGP mode
(config-router)#address-family ipv4 unicast	Enter into BGP address family IPv4
(config-router-af)#neighbor 1.1.1.2 route-map D out	Apply Route-map for the neighbor 1.1.1.2 in out direction
(config-router-af)#commit	Commit the configurations
(config-router-af)#end	Return to privilege mode
#clear ip bgp * soft out	Soft reset after applying Route-map

Validation

R2

```
# show ip bgp community
BGP table version is 4, local router ID is 5.5.5.2
Status codes: s suppressed, d damped, h history, a add-path, * valid, > best,
i - internal,
                l - labeled, S Stale
Origin codes: i - IGP, e - EGP, ? - incomplete
```

```
      Network          Next Hop           Metric      LocPrf   Weight Path
*>  18.1.1.0/24        1.1.1.1              0           100       0   300 i
```

```
Total number of prefixes 1
```

```
#show ip bgp 18.1.1.0/24
BGP routing table entry for 18.1.1.0/24
Paths: (1 available, best #1, table Default-IP-Routing-Table, not advertised
to EBGp peer)
  Not advertised to any peer
  AS path:300
  Nexthop:1.1.1.1 from 1.1.1.1 (Remote Id:1.1.1.1)
    Origin IGP, metric 0, localpref 100          valid, external, best, source
safi: 1
  Community: 65535:666 no-export
```

Not advertised to any peer
 Last update: Tue Apr 16 21:48:01 2019

```
#show ip route
Codes: K - kernel, C - connected, S - static, R - RIP, B - BGP
       O - OSPF, IA - OSPF inter area
       N1 - OSPF NSSA external type 1, N2 - OSPF NSSA external type 2
       E1 - OSPF external type 1, E2 - OSPF external type 2
       i - IS-IS, L1 - IS-IS level-1, L2 - IS-IS level-2,
       ia - IS-IS inter area, E - EVPN,
       v - vrf leaked
       * - candidate default
```

```
IP Route Table for VRF "default"
C       1.1.1.0/24 is directly connected, xe1, 00:10:22
C       5.5.5.0/24 is directly connected, xe5, 00:10:49
B       18.1.1.0/24 [20/0] is a summary, Null, 00:02:00
B       20.1.1.0/24 [20/0] via 5.5.5.1, xe5, 00:05:46
C       127.0.0.0/8 is directly connected, lo, 00:35:31
```

Gateway of last resort is not set

R1

```
#sh ip route
Codes: K - kernel, C - connected, S - static, R - RIP, B - BGP
       O - OSPF, IA - OSPF inter area
       N1 - OSPF NSSA external type 1, N2 - OSPF NSSA external type 2
       E1 - OSPF external type 1, E2 - OSPF external type 2
       i - IS-IS, L1 - IS-IS level-1, L2 - IS-IS level-2,
       ia - IS-IS inter area, E - EVPN,
       v - vrf leaked
       * - candidate default
```

```
IP Route Table for VRF "default"
C       5.5.5.0/24 is directly connected, xe5, 00:15:41
C       20.1.1.0/24 is directly connected, xe20, 00:14:06
C       127.0.0.0/8 is directly connected, lo, 00:37:28
```

Gateway of last resort is not set

Accumulated Interior Gateway Protocol

Overview

This section includes step-by-step configuration of AIGP Metric Attribute for BGP. It also contains an overview of the concepts of AIGP. AIGP is a non-transitive attribute that includes the accumulated IGP metric. BGP routers advertise this AIGP metric to neighbors in other ASes. This allows BGP routers to select the best path based on the end-to-end IGP metric.

Topology

The diagram depicts the topology for the configuration examples that follow.

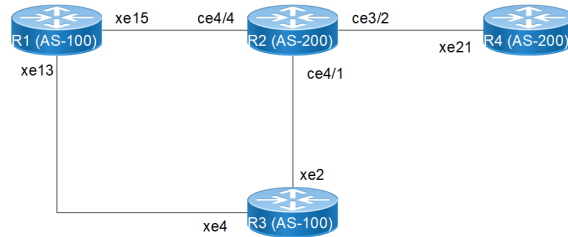

Figure 1-41: Accumulated Interior Gateway Protocol

Base Configurations

R1

Loopback Interface:

#configure terminal	Enter configuration mode.
(config)#interface lo	Enter the Interface mode for the loopback interface.
(config-if)#ip address 1.1.1.1/32 secondary	Configure IP address on loopback interface.
(config-if)#commit	Commit the transaction

Interface Configuration:

(config)#interface xe15	Enter the Interface mode for xe15.
(config-if)# ip address 10.10.10.1/24	Configure IP address on the interface.
(config-if)#exit	Exit interface mode
(config)#interface xe13	Enter the Interface mode for xe13.
(config-if)# ip address 11.11.11.1/24	Configure IP address on the interface.
(config)#interface xe12	Enter the Interface mode for xe12.
(config-if)# ip address 50.50.50.2/24	Configure IP address on the interface.
(config-if)#commit	Commit the transaction.

OSPF Configuration:

(config)#router ospf 100	Enter the Router OSPF mode.
(config-router)#ospf router-id 1.1.1.1	Router-id configurations
(config-router)# network 1.1.1.1/32 area 0	Advertise loopback address in OSPF.
(config-router)#network 10.10.10.0/24 area 0	Advertise network address in OSPF.
(config-router)#network 11.11.11.0/24 area 0	Advertise network address in OSPF.
(config-router)#commit	Commit the transaction

R2

Loopback Interface:

#configure terminal	Enter configuration mode.
(config)#interface lo	Enter the Interface mode for the loopback interface.
(config-if)#ip address 2.2.2.2/32 secondary	Configure IP address on loopback interface.
(config-if)#commit	Commit the transaction

Interface Configuration:

(config)#interface ce4/4	Enter the Interface mode for ce4/4.
(config-if)# ip address 10.10.10.2/24	Configure IP address on the interface.
(config-if)#interface ce4/1	Enter the Interface mode for ce4/1.
(config-if)# ip address 12.12.12.1/24	Configure IP address on the interface.
(config-if)#interface ce3/2	Enter the Interface mode for ce3/2.
(config-if)# ip address 13.13.13.1/24	Configure IP address on the interface.
(config-if)#commit	Commit the transaction.

OSPF Configuration:

(config)#router ospf 100	Enter the Router OSPF mode.
(config-router)#ospf router-id 2.2.2.2	Router-id configurations
(config-router)# network 2.2.2.2/32 area 0	Advertise loopback address in OSPF.
(config-router)#network 10.10.10.0/24 area 0	Advertise network address in OSPF.
(config-router)#network 12.12.12.0/24 area 0	Advertise network address in OSPF.
(config-router)#network 13.13.13.0/24 area 0	Advertise network address in OSPF.
(config-router)#commit	Commit the transaction

R3

Loopback Interface:

#configure terminal	Enter configuration mode.
(config)#interface lo	Enter the Interface mode for the loopback interface.
(config-if)#ip address 3.3.3.3/32 secondary	Configure IP address on loopback interface.
(config-if)#commit	Commit the transaction

Interface Configuration:

(config)#interface xe4	Enter the Interface mode for xe4.
(config-if)# ip address 11.11.11.2/24	Configure IP address on the interface.
(config)#interface xe2	Enter the Interface mode for xe2.
(config-if)# ip address 12.12.12.2/24	Configure IP address on the interface.
(config-if)#commit	Commit the transaction.

OSPF Configuration:

(config)#router ospf 100	Enter the Router OSPF mode.
(config-router)#ospf router-I 3.3.3.3	Router-id configurations
(config-router)# network 3.3.3.3/32 area 0	Advertise loopback address in OSPF.
(config-router)#network 11.11.11.0/24 area 0	Advertise network address in OSPF.
(config-router)#network 12.12.12.0/24 area 0	Advertise network address in OSPF.
(config-router)#commit	Commit the transaction

R4

Loopback Interface:

#configure terminal	Enter configuration mode.
(config)#interface lo	Enter the Interface mode for the loopback interface.
(config-if)#ip address 4.4.4.4/32 secondary	Configure IP address on loopback interface.
(config-if)#commit	Commit the transaction

Interface Configuration:

(config)#interface xe12	Enter the Interface mode for xe21.
(config-if)# ip address 13.13.13.2/24	Configure IP address on the interface.
(config-if)#commit	Commit the transaction.

OSPF Configuration:

(config)#router ospf 100	Enter the Router OSPF mode.
(config-router)#ospf router-id 4.4.4.4	Router-id configurations
(config-router)# network 4.4.4.4/32 area 0	Advertise loopback address in OSPF.
(config-router)#network 13.13.13.0/24 area 0	Advertise network address in OSPF.
(config-router)#commit	Commit the transaction

BGP Configurations

R1

Route Map Configuration:

(config)# route-map map1 permit 10	Configure route-map map1 with sequence number 10.
(config-route-map)#set aigp-metric 100	Set aigp metric as 100.
(config-route-map)#commit	Commit the transaction

BGP Configuration:

(config)# router bgp 100	Enter the BGP configuration mode.
(config-router)# neighbor 3.3.3.3 remote-as 100	Configure neighbor
(config-router)# neighbor 3.3.3.3 update-source 1.1.1.1	Update loopback address as source
(config-router)# address-family ipv4 unicast	Enter address family mode.
(config-router)#network 50.50.50.0/24 route-map map1	Apply a route map to routes.
(config-router-af)#neighbor 3.3.3.3 activate	Activate the neighbor.
(config-router-af)#exit	Exit address family mode.
(config-router)#exit	Exit Router BGP mode

R2

BGP Configuration:

(config)# router bgp 200	Enter the BGP configuration mode.
(config-router)#neighbor 3.3.3.3 remote-as 100	Configure neighbor
(config-router)#neighbor 4.4.4.4 remote-as 200	Configure neighbor
(config-router)# neighbor 3.3.3.3 update-source 2.2.2.2	Update loopback address as source
(config-router)# neighbor 4.4.4.4 update-source 2.2.2.2	Update loopback address as source
(config-router)# neighbor 3.3.3.3 ebgp-multihop 2	Enable multihop on eBGP session.
(config-router)#address-family ipv4	Enter address family mode.
(config-router-af)#neighbor 3.3.3.3 activate	Activate the neighbor.
(config-router-af)#neighbor 4.4.4.4 activate	Activate the neighbor.
(config-router-af)#neighbor 3.3.3.3 aigp enable	Enable aigp for the neighbor.
(config-router-af)#neighbor 4.4.4.4 aigp enable	Enable aigp for the neighbor.

BGP

(config-router-af)#neighbor 4.4.4.4 next-hop-self	Configure next-hop-self for the R4 neighbor.
(config-router-af)#commit	Commit the transaction.

R3

BGP Configuration:

(config)# router bgp 100	Enter the BGP configuration mode.
(config-router)#neighbor 1.1.1.1 remote-as 100	Configure neighbor
(config-router)#neighbor 2.2.2.2 remote-as 200	Configure neighbor
(config-router)#neighbor 4.4.4.4 remote-as 200	Configure neighbor
(config-router)#neighbor 1.1.1.1 update-source 3.3.3.3	Update loopback address as source
(config-router)#neighbor 2.2.2.2 update-source 3.3.3.3	Update loopback address as source
(config-router)#neighbor 4.4.4.4 update-source 3.3.3.3	Update loopback address as source
(config-router)# neighbor 2.2.2.2 ebgp-multihop 2	Enable multihop on eBGP session.
(config-router)# neighbor 4.4.4.4 ebgp-multihop 2	Enable multihop on eBGP session.
(config-router)#address-family ipv4	Enter address family mode.
(config-router-af)#neighbor 1.1.1.1 activate	Activate the neighbor.
(config-router-af)#neighbor 2.2.2.2 activate	Activate the neighbor.
(config-router-af)#neighbor 4.4.4.4 activate	Activate the neighbor.
(config-router-af)#neighbor 2.2.2.2 aigp enable	Enable aigp for the neighbor.
(config-router-af)#neighbor 4.4.4.4 aigp enable	Enable aigp for the neighbor.
(config-router-af)#commit	Exit address family mode.

R4

BGP Configuration:

(config)# router bgp 200	Enter the BGP configuration mode.
(config-router)#neighbor 3.3.3.3 remote-as 100	Configure neighbor
(config-router)#neighbor 2.2.2.2 remote-as 200	Configure neighbor
(config-router)# neighbor 3.3.3.3 update-source 4.4.4.4	Update loopback address as source
(config-router)# neighbor 2.2.2.2 update-source 4.4.4.4	Update loopback address as source

(config-router)# neighbor 3.3.3.3 ebgp-multihop 2	Enable multihop on eBGP session.
(config-router)#address-family ipv4	Enter address family mode.
(config-router-af)#neighbor 3.3.3.3 activate	Activate the neighbor.
(config-router-af)#neighbor 2.2.2.2 activate	Activate the neighbor.
(config-router-af)#neighbor 3.3.3.3 aigp enable	Enable aigp for the neighbor.
(config-router-af)#neighbor 2.2.2.2 aigp enable	Enable aigp for the neighbor.
(config-router-af)#neighbor 2.2.2.2 next-hop-self	Configure next-hop-self for the R4 neighbor.
(config-router-af)#commit	Commit the transaction.

Validation

R3

R3#sh ip ospf neighbor

Total number of full neighbors: 2

OSPF process 100 VRF(default):

Neighbor ID Instance ID	Pri	State	Dead Time	Address	Interface	
1.1.1.1	1	Full/DR	00:00:37	11.11.11.1	xe4	0
2.2.2.2	1	Full/Backup	00:00:37	12.12.12.1	xe2	0

R3#sh ip bgp summary

BGP router identifier 3.3.3.3, local AS number 100

BGP table version is 23

1 BGP AS-PATH entries

0 BGP community entries

Neighbor PfxRcd	V	AS	MsgRcv	MsgSen	TblVer	InQ	OutQ	Up/Down	State/
1.1.1.1 1	4	100	162	172	23	0	0	00:23:34	
2.2.2.2 0	4	200	60	68	23	0	0	00:08:50	
4.4.4.4 0	4	200	145	164	23	0	0	00:03:19	

Total number of neighbors 3

Total number of Established sessions 3

R3#sh ip bgp

BGP table version is 23, local router ID is 3.3.3.3

Status codes: s suppressed, d damped, h history, a add-path, * valid, > best, i - internal,

l - labeled, S Stale

Origin codes: i - IGP, e - EGP, ? - incomplete

Network	Next Hop	Metric	LocPrf	Weight	Path
*>i 50.50.50.0/24	1.1.1.1	0	100	0	i

BGP

Total number of prefixes 1

R3#sh ip bgp 50.50.50.0

BGP routing table entry for 50.50.50.0/24

Paths: (1 available, best #1, table Default-IP-Routing-Table)

Advertised to non peer-group peers:

2.2.2.2 4.4.4.4

Local

NextHop:1.1.1.1 (metric 2) from 1.1.1.1 (Remote Id:1.1.1.1)

Origin IGP, metric 0, localpref 100, aigp metric 100 valid, internal, best,
source safi: 1

Not advertised to any peer

Total AIGP metric 102

Last update: Wed Jun 22 06:41:17 2022

R4

R4#sh ip ospf neighbor

Total number of full neighbors: 1

OSPF process 100 VRF(default):

Neighbor ID Instance ID	Pri	State	Dead Time	Address	Interface	
2.2.2.2	1	Full/Backup	00:00:37	13.13.13.1	xe21	0

R4#sh ip bgp summary

BGP router identifier 4.4.4.4, local AS number 200

BGP table version is 4

2 BGP AS-PATH entries

0 BGP community entries

Neighbor PfxRcd	V	AS	MsgRcv	MsgSen	TblVer	InQ	OutQ	Up/Down	State/
2.2.2.2	4	200	82	85	4	0	0	00:04:28	
1									
3.3.3.3	4	100	100	96	4	0	0	00:04:28	
1									

Total number of neighbors 2

Total number of Established sessions 2

R4#sh ip bgp

BGP table version is 4, local router ID is 4.4.4.4

Status codes: s suppressed, d damped, h history, a add-path, * valid, > best, i -
internal,

l - labeled, S Stale

Origin codes: i - IGP, e - EGP, ? - incomplete

	Network	Next Hop	Metric	LocPrf	Weight	Path
*>	50.50.50.0/24	3.3.3.3	0	100	0	100 i
* i		2.2.2.2	0	100	0	100 i

Total number of prefixes 1

R4#sh ip bgp 50.50.50.0

```

BGP routing table entry for 50.50.50.0/24
Paths: (2 available, best #1, table Default-IP-Routing-Table)
  Advertised to non-peer-group peers:
    2.2.2.2
  AS path:100
    Nexthop:3.3.3.3 (metric 3) from 3.3.3.3 (Remote Id:3.3.3.3)
      Origin IGP, metric 0, localpref 100, aigp metric 102      valid, external, best,
source safi: 1
      Not advertised to any peer
      Total AIGP metric 105
      Last update: Wed Jun 22 06:57:49 2022

  AS path:100
    Nexthop:2.2.2.2 (metric 2) from 2.2.2.2 (Remote Id:2.2.2.2)
      Origin IGP, metric 0, localpref 100, aigp metric 104      valid, internal, source
safi: 1
      Not advertised to any peer
      Total AIGP metric 106
      Last update: Wed Jun 22 06:57:53 2022

```

R4#

Extended Community Attribute

Follow the base configuration as mentioned above.

R1

Route Map Configuration:

(config)# route-map map1 permit 10	Configure route-map map1 with sequence number 10.
(config-route-map)#set aigp-metric 100	Set aigp metric as 100.
(config)# route-map map2 permit 20	Configure route-map map2 with sequence number 20.
(config-route-map)#set aigp-metric igp-metric	Set aigp metric as igp-metric.
(config-route-map)#commit	Commit the transaction

BGP Configuration:

(config)# router bgp 100	Enter the BGP configuration mode.
(config-router)# neighbor 3.3.3.3 remote-as 100	Configure neighbor
(config-router)# neighbor 2.2.2.2 remote-as 100	Configure neighbor
(config-router)# neighbor 3.3.3.3 update-source 1.1.1.1	Update loopback address as source
(config-router)# neighbor 2.2.2.2 update-source 1.1.1.1	Update loopback address as source
(config-router)# address-family ipv4 unicast	Enter address family mode.

BGP

(config-router)#network 50.50.50.0/24	Advertise the network.
(config-router-af)#neighbor 3.3.3.3 activate	Activate the neighbor.
(config-router-af)#neighbor 2.2.2.2 activate	Activate the neighbor.
(config-router-af)#neighbor 3.3.3.3 route-map map1 out	Attach the route-map map1 for the neighbor 3.3.3.3 in out direction
(config-router-af)#neighbor 2.2.2.2 route-map map2 out	Attach the route-map map2 for the neighbor 2.2.2.2 in out direction
(config-router-af)#neighbor 3.3.3.3 aigp disable	Disable the aigp neighbor.
(config-router-af)#neighbor 2.2.2.2 aigp disable	Disable the aigp neighbor.
config-router-af)#neighbor 2.2.2.2 aigp send cost-community 10 poi igp-cost	Enable extended community attribute for the neighbor.
config-router-af)#neighbor 3.3.3.3 aigp send cost-community 10 poi pre-bestpath	Enable extended community attribute for the neighbor.
(config-router-af)#commit	Commit the transaction.

R2

BGP Configuration:

(config)# router bgp 100	Enter the BGP configuration mode.
(config-router)# neighbor 3.3.3.3 remote-as 100	Configure neighbor
(config-router)# neighbor 1.1.1.1 remote-as 100	Configure neighbor
(config-router)# neighbor 4.4.4.4 remote-as 200	Configure neighbor
(config-router)# neighbor 3.3.3.3 update-source 2.2.2.2	Update loopback address as source
(config-router)# neighbor 1.1.1.1 update-source 2.2.2.2	Update loopback address as source
(config-router)# neighbor 4.4.4.4 update-source 2.2.2.2	Update loopback address as source
(config-router)# neighbor 4.4.4.4 ebgp-multihop 2	Enable multihop on eBGP session.
(config-router)# address-family ipv4 unicast	Enter address family mode.
(config-router-af)#neighbor 3.3.3.3 activate	Activate the neighbor.
(config-router-af)#neighbor 1.1.1.1 activate	Activate the neighbor.
(config-router-af)#neighbor 4.4.4.4 activate	Activate the neighbor.
(config-router-af)#commit	Exit address family mode.

R3**BGP Configuration:**

(config)# router bgp 100	Enter the BGP configuration mode.
(config-router)#neighbor 1.1.1.1 remote-as 100	Configure neighbor
(config-router)#neighbor 2.2.2.2 remote-as 100	Configure neighbor
(config-router)#neighbor 4.4.4.4 remote-as 200	Configure neighbor
(config-router)#neighbor 1.1.1.1 update-source 3.3.3.3	Update loopback address as source
(config-router)#neighbor 2.2.2.2 update-source 3.3.3.3	Update loopback address as source
(config-router)#neighbor 4.4.4.4 update-source 3.3.3.3	Update loopback address as source
(config-router)# neighbor 4.4.4.4 ebgp-multihop 2	Enable multihop on eBGP session.
(config-router)#address-family ipv4	Enter address family mode.
(config-router-af)#neighbor 1.1.1.1 activate	Activate the neighbor.
(config-router-af)#neighbor 2.2.2.2 activate	Activate the neighbor.
(config-router-af)#neighbor 4.4.4.4 activate	Activate the neighbor.
(config-router-af)#commit	Exit address family mode.

R4**BGP Configuration:**

(config)# router bgp 200	Enter the BGP configuration mode.
(config-router)#neighbor 3.3.3.3 remote-as 100	Configure neighbor
(config-router)#neighbor 2.2.2.2 remote-as 100	Configure neighbor
(config-router)# neighbor 3.3.3.3 update-source 4.4.4.4	Update loopback address as source
(config-router)# neighbor 2.2.2.2 update-source 4.4.4.4	Update loopback address as source
(config-router)# neighbor 3.3.3.3 ebgp-multihop 2	Enable multihop on eBGP session.
(config-router)# neighbor 2.2.2.2 ebgp-multihop 2	Enable multihop on eBGP session.
(config-router)#address-family ipv4	Enter address family mode.
(config-router-af)#neighbor 3.3.3.3 activate	Activate the neighbor.
(config-router-af)#neighbor 2.2.2.2 activate	Activate the neighbor.
(config-router-af)#commit	Commit the transaction.

Validation

```
R4#show ip bgp summary
BGP router identifier 4.4.4.4, local AS number 200
BGP table version is 4
1 BGP AS-PATH entries
0 BGP community entries
```

Neighbor PfxRcd	V	AS	MsgRcv	MsgSen	TblVer	InQ	OutQ	Up/Down	State/
2.2.2.2 1	4	100	164	157	4	0	0	00:02:43	
3.3.3.3 1	4	100	177	194	4	0	0	00:00:28	

Total number of neighbors 2

Total number of Established sessions 2

```
R4#show ip bgp
BGP table version is 4, local router ID is 4.4.4.4
Status codes: s suppressed, d damped, h history, a add-path, * valid, > best, i -
internal,
                l - labeled, S Stale
Origin codes: i - IGP, e - EGP, ? - incomplete
```

	Network	Next Hop	Metric	LocPrf	Weight	Path
*>	50.50.50.0/24	2.2.2.2	0	100	0	100 i
*		3.3.3.3	0	100	0	100 i

Total number of prefixes 1

```
R4#show ip bgp 50.50.50.0
BGP routing table entry for 50.50.50.0/24
Paths: (2 available, best #1, table Default-IP-Routing-Table)
  Advertised to non peer-group peers:
    3.3.3.3
  AS path:100
    Nexthop:2.2.2.2 (metric 2) from 2.2.2.2 (Remote Id:2.2.2.2)
      Origin IGP, metric 0, localpref 100          valid, external, best, source safi: 1
      Extended Community:
        cost(transitive)igp_metric:10:0
      Not advertised to any peer
      Last update: Wed Jun 22 17:57:32 2022
```

```
AS path:100
  Nexthop:3.3.3.3 (metric 3) from 3.3.3.3 (Remote Id:3.3.3.3)
    Origin IGP, metric 0, localpref 100          valid, external, source safi: 1
    Extended Community:
      cost(transitive)pre-bestpath:10:200
    Not advertised to any peer
    Last update: Wed Jun 22 17:59:46 2022
```

CHAPTER 2 BGP4+

This chapter contains basic BGP4+ configuration examples.

For details about the commands used in these examples, see the *Border Gateway Protocol Command Reference*.

Enable iBGP Peering Using a Global Address

This example shows the minimum configuration required to enable BGP on an interface. R1 and R2 are two routers belonging to the same Autonomous System (AS), AS200, connecting to network 3ffe:10::/48. First, specify the IPv6 global address, then define the routing process and AS number to which the routers belong. Configure a fixed Router ID, then, define BGP neighbors to start exchanging routing updates.

Topology

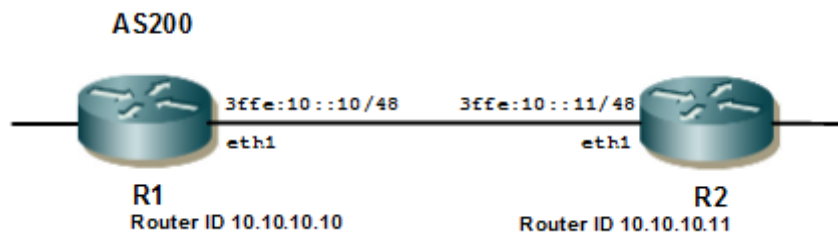

Figure 2-42: iBGP Peering

Configuration

R1

#configure terminal	Enter Configure mode.
(config)#interface eth1	Specify the interface (eth1) to configure.
(config-if)#ipv6 address 3ffe:10::10/48	Specify the IPv6 global address.
(config-if)#exit	Enter Configure mode.
(config)#router bgp 200	Define the routing process. The number 200 specifies the AS number of R2.
(config-router)#bgp router-id 10.10.10.11	Configure a fixed Router ID (10.10.10.11) for the BGP4+ routing process.
(config-router)#neighbor 3ffe:10::10 remote-as 200	Define the BGP neighbor (R1), and establish a TCP session by specifying the global IPv6 address (3ffe:10::10) and the AS number (200) of neighbor R1.
(config-router)#address-family ipv6	Enter Address Family mode for configuring routing sessions that use IPv6 address prefixes.
(config-router-af)#neighbor 3ffe:10::10 activate	Activate the neighbor R1 (3ffe:10::10), and enable exchange of IPv6 address prefix types with this neighbor.

BGP4+

(config-router-af)#exit-address-family	Exit address family
(config-router)#commit	Commit the candidate configuration to the running configuration

R2

#configure terminal	Enter Configure mode.
(config)#interface eth1	Specify the interface (eth1) to configure.
(config-if)#ipv6 address 3ffe:10::11/48	Specify the IPv6 global address.
(config-if)#exit	Enter Configure mode.
(config)#router bgp 200	Define the routing process. The number 200 specifies the AS number of R2.
(config-router)#bgp router-id 10.10.10.11	Configure a fixed Router ID (10.10.10.11) for the BGP4+ routing process.
(config-router)#neighbor 3ffe:10::10 remote-as 200	Define the BGP neighbor (R1), and establish a TCP session by specifying the global IPv6 address (3ffe:10::10) and the AS number (200) of neighbor R1.
(config-router)#address-family ipv6	Enter Address Family mode for configuring routing sessions that use IPv6 address prefixes.
(config-router-af)#neighbor 3ffe:10::10 activate	Activate the neighbor R1 (3ffe:10::10), and enable exchange of IPv6 address prefix types with this neighbor.
(config-router-af)#exit-address-family	Exit address family
(config-router)#commit	Commit the candidate configuration to the running configuration

Validation

show bgp ipv6 summary, show bgp ipv6 neighbors.

R1

```
#show bgp ipv6 summary
BGP router identifier 10.10.10.10, local AS number 200
BGP table version is 1
0 BGP AS-PATH entries
0 BGP community entries
```

Neighbor PfxRcd	V	AS	MsgRcv	MsgSen	TblVer	InQ	OutQ	Up/Down	State/
3ffe:10::11 0	4	200	10	10	1	0	0	00:03:36	

Total number of neighbors 1

Total number of Established sessions 1

```
#show bgp ipv6 neighbors
BGP neighbor is 3ffe:10::11, remote AS 200, local AS 200, internal link
```

```

BGP version 4, local router ID 10.10.10.10, remote router ID 10.10.10.11
BGP state = Established, up for 00:05:39
Last read 00:00:03, hold time is 90, keepalive interval is 30 seconds
Neighbor capabilities:
  Route refresh: advertised and received (old and new)
  Address family IPv6 Unicast: advertised and received
Received 15 messages, 0 notifications, 0 in queue
Sent 14 messages, 0 notifications, 0 in queue
Route refresh request: received 0, sent 0
Minimum time between advertisement runs is 5 seconds
For address family: IPv6 Unicast
  BGP table version 1, neighbor version 1
  Index 1, Offset 0, Mask 0x2
  Community attribute sent to this neighbor (both)
  0 accepted prefixes
  0 announced prefixes

Connections established 1; dropped 0
Local host: 3ffe:10::10, Local port: 44754
Foreign host: 3ffe:10::11, Foreign port: 179
Nexthop: 10.10.10.10
Nexthop global: 3ffe:10::10
Nexthop local: fe80::5054:ff:fe11:d4f5
BGP connection: shared network

```

R2

```

R2#show bgp ipv6 summary
BGP router identifier 10.10.10.11, local AS number 200
BGP table version is 1
0 BGP AS-PATH entries
0 BGP community entries

Neighbor          V  AS  MsgRcv  MsgSen  TblVer  InQ  OutQ  Up/Down  State/
PfxRcd
3ffe:10::10      4  200   31     32     1     0     0  00:12:53
0

Total number of neighbors 1

Total number of Established sessions 1

R2#show bgp ipv6 neighbors
BGP neighbor is 3ffe:10::10, remote AS 200, local AS 200, internal link
  BGP version 4, local router ID 10.10.10.11, remote router ID 10.10.10.10
  BGP state = Established, up for 00:15:29
  Last read 00:00:19, hold time is 90, keepalive interval is 30 seconds
  Neighbor capabilities:
    Route refresh: advertised and received (old and new)
    Address family IPv6 Unicast: advertised and received
  Received 37 messages, 0 notifications, 0 in queue

```

```

Sent 39 messages, 0 notifications, 0 in queue
Route refresh request: received 0, sent 0
Minimum time between advertisement runs is 5 seconds
For address family: IPv6 Unicast
BGP table version 1, neighbor version 1
Index 1, Offset 0, Mask 0x2
Community attribute sent to this neighbor (both)
0 accepted prefixes
0 announced prefixes

```

```

Connections established 1; dropped 0
Local host: 3ffe:10::11, Local port: 179
Foreign host: 3ffe:10::10, Foreign port: 44754
Nexthop: 10.10.10.11
Nexthop global: 3ffe:10::11
Nexthop local: fe80::5054:ff:fe82:8dcc
BGP connection: shared network

```

Enable iBGP Peering Using Link-local Address

This example shows the minimum configuration required to enable iBGP on an interface. R1 and R2 are two routers belonging to the same AS, AS200, connecting to network fe80::/10. First, define the routing process and AS number to which the routers belong. Configure a fixed Router ID for the BGP4+ routing process, then, define BGP neighbors to start exchanging routing updates.

Topology

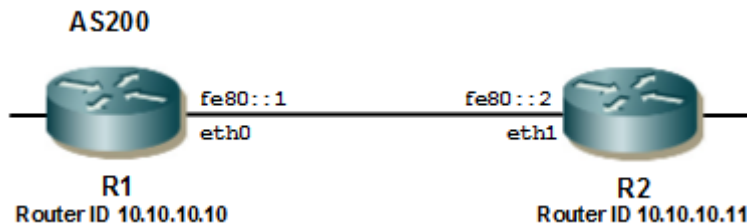

Figure 2-43: iBGP Peering Link-Local Address

Configuration

R1

#configure terminal	Enter Configure mode.
(config)#router bgp 200	Define the routing process. The number 200 specifies the AS number of R1.
(config-router)#bgp router-id 10.10.10.10	Configure a fixed Router ID (10.10.10.10) for the BGP4+ routing process.

#configure terminal	Enter Configure mode.
(config-router)#neighbor fe80::2 remote-as 200	Define BGP neighbor (R2), and establish a TCP session by specifying the link-local address (fe80::2) and the AS number (200) of neighbor R2.
(config-router)#neighbor fe80::2 interface eth0	To specify a link-local neighbor, configure the interface name of the neighbor fe80::2.
(config-router)#address-family ipv6	Enter Address Family mode for configuring routing sessions that use IPv6 address prefixes.
(config-router-af)#neighbor fe80::2 activate	Activate the neighbor R2 (fe80::2), and enable exchange of IPv6 address prefix types with this neighbor.
(config-router-af)#exit-address-family	Exit address family
(config-router)#commit	Commit the candidate configuration to the running configuration

R2

(config)#router bgp 200	Define the routing process. The number 200 specifies the AS number of R2.
(config-router)#bgp router-id 10.10.10.11	Configure a fixed Router ID (10.10.10.11) for the BGP4+ routing process.
(config-router)#neighbor fe80::1 remote-as 200	Define the BGP neighbor (R1), and establish a TCP session by specifying the link-local address R1(fe80::1) and the AS number (200) of neighbor R1.
(config-router)#neighbor fe80::1 interface eth1	To specify a link-local neighbor, configure the interface name of the neighbor fe80::1.
(config-router)#address-family ipv6	Enter Address Family mode for configuring routing sessions that use IPv6 address prefixes.
(config-router-af)#neighbor fe80::1 activate	Activate the neighbor R1 (fe80::1), and enable exchange of IPv6 address prefix types with this neighbor.
(config-router-af)#exit-address-family	Exit address family
(config-router)#commit	Commit the candidate configuration to the running configuration

Validation

show bgp ipv6 summary, show bgp ipv6, show bgp ipv6 neighbors

R1

R1#show bgp ipv6 summary

BGP router identifier 10.10.10.10, local AS number 200

BGP table version is 1

0 BGP AS-PATH entries

0 BGP community entries

Neighbor	V	AS	MsgRcv	MsgSen	TblVer	InQ	OutQ	Up/Down	State/
PfxRcd fe80::2	4	200	68	67	1	0	0	00:27:49	0

BGP4+

Total number of neighbors 1

Total number of Established sessions 1

R1#show bgp ipv6 neighbors

```
BGP neighbor is fe80::2, remote AS 200, local AS 200, internal link
  BGP version 4, local router ID 10.10.10.10, remote router ID 10.10.10.11
  BGP state = Established, up for 00:28:14
  Last read 00:00:28, hold time is 90, keepalive interval is 30 seconds
  Neighbor capabilities:
    Route refresh: advertised and received (old and new)
    Address family IPv6 Unicast: advertised and received
  Received 68 messages, 0 notifications, 0 in queue
  Sent 68 messages, 0 notifications, 0 in queue
  Route refresh request: received 0, sent 0
  Minimum time between advertisement runs is 5 seconds
For address family: IPv6 Unicast
  BGP table version 1, neighbor version 1
  Index 1, Offset 0, Mask 0x2
  Community attribute sent to this neighbor (both)
  0 accepted prefixes
  0 announced prefixes
```

Connections established 1; dropped 0

Local host: fe80::5054:ff:fe11:d4f5, Local port: 179

Foreign host: fe80::2, Foreign port: 44058

Nexthop: 10.10.10.10

Nexthop global: 3ffe:10::10

Nexthop local: fe80::5054:ff:fe11:d4f5

BGP connection: shared network

R2

R2#show bgp ipv6 summary

BGP router identifier 10.10.10.11, local AS number 200

BGP table version is 1

0 BGP AS-PATH entries

0 BGP community entries

Neighbor	V	AS	MsgRcv	MsgSen	TblVer	InQ	OutQ	Up/Down	State/
PfxRcd									
fe80::1	4	200	54	55	1	0	0	00:22:19	0

Total number of neighbors 1

Total number of Established sessions 1

R2#show bgp ipv6 neighbors

BGP neighbor is fe80::1, remote AS 200, local AS 200, internal link

BGP version 4, local router ID 10.10.10.11, remote router ID 10.10.10.10

BGP state = Established, up for 00:22:59

```

Last read 00:00:13, hold time is 90, keepalive interval is 30 seconds
Neighbor capabilities:
  Route refresh: advertised and received (old and new)
  Address family IPv6 Unicast: advertised and received
Received 55 messages, 0 notifications, 0 in queue
Sent 57 messages, 0 notifications, 0 in queue
Route refresh request: received 0, sent 0
Minimum time between advertisement runs is 5 seconds
For address family: IPv6 Unicast
  BGP table version 1, neighbor version 1
  Index 1, Offset 0, Mask 0x2
  Community attribute sent to this neighbor (both)
  0 accepted prefixes
  0 announced prefixes

Connections established 1; dropped 0
Local host: fe80::5054:ff:fe82:8dcc, Local port: 44058
Foreign host: fe80::1 , Foreign port: 179
Nexthop: 10.10.10.11
Nexthop global: 3ffe:10::11
Nexthop local: fe80::5054:ff:fe82:8dcc
BGP connection: shared network

```

Enable eBGP Peering Between Different Autonomous Systems

This example shows the minimum configuration required to enable eBGP on an interface, when the routers belong to different ASs. R1 and R2 are two routers in different ASs, AS200 and AS300 connecting to network 3ffe:10::/64.

Topology

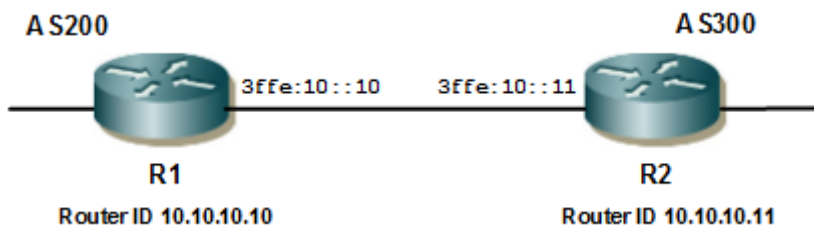

Figure 2-44: BGP Peering - Different AS

Configuration

R1

#configure terminal	Enter Configure mode.
(config)#router bgp 200	Define the routing process. The number 200 specifies the AS number of R1.
(config-router)#bgp router-id 10.10.10.10	Configure a fixed Router ID (10.10.10.10) for the BGP4+ routing process.
(config-router)#neighbor 3ffe:10::11 remote-as 300	Define the BGP neighbor (R2), and establish a TCP session by specifying the IPv6 address (3ffe:10::11) and the AS number (300) of neighbor R2.
(config-router)#address-family ipv6	Enter Address Family mode for configuring routing sessions that use IPv6 address prefixes.
(config-router-af)#neighbor 3ffe:10::11 activate	Activate the neighbor R2 (3ffe:10::11), and enable exchange of IPv6 address prefix types with this neighbor.
(config-router-af)#exit-address-family	Exit address family
(config-router)#commit	Commit the candidate configuration to the running configuration

R2

(config)#router bgp 300	Define the routing process. The number 300 specifies the AS number of R2.
(config-router)#bgp router-id 10.10.10.11	Configure a fixed Router ID (10.10.10.11) for the BGP4+ routing process.
(config-router)#neighbor 3ffe:10::10 remote-as 200	Define the BGP neighbor (R1), and establish a TCP session by specifying the IPv6 address (3ffe:10::10) and the AS number (200) of neighbor R1.
(config-router)#address-family ipv6	Enter Address Family mode for configuring routing sessions that use IPv6 address prefixes.
(config-router-af)#neighbor 3ffe:10::10 activate	Activate the neighbor R1 (3ffe:10::10) and enable exchange of IPv6 address prefix types with this neighbor.
(config-router-af)#exit-address-family	Exit address family
(config-router)#commit	Commit the candidate configuration to the running configuration

Validation

show bgp ipv6 summary, show bgp ipv6 neighbors.

R1

```
R1#show bgp ipv6 summary
BGP router identifier 10.10.10.10, local AS number 200
BGP table version is 1
```

0 BGP AS-PATH entries
0 BGP community entries

Neighbor PfxRcd	V	AS	MsgRcv	MsgSen	TblVer	InQ	OutQ	Up/Down	State/
3ffe:10::11 0	4	300	3	4	1	0	0	00:00:37	

Total number of neighbors 1
Total number of Established sessions 1

R1#show bgp ipv6 neighbors

BGP neighbor is 3ffe:10::11, remote AS 300, local AS 200, external link
BGP version 4, local router ID 10.10.10.10, remote router ID 10.10.10.11
BGP state = Established, up for 00:01:42
Last read 00:00:04, hold time is 90, keepalive interval is 30 seconds
Neighbor capabilities:
Route refresh: advertised and received (old and new)
Address family IPv6 Unicast: advertised and received
Received 6 messages, 0 notifications, 0 in queue
Sent 6 messages, 0 notifications, 0 in queue
Route refresh request: received 0, sent 0
Minimum time between advertisement runs is 30 seconds
For address family: IPv6 Unicast
BGP table version 1, neighbor version 1
Index 1, Offset 0, Mask 0x2
Community attribute sent to this neighbor (both)
0 accepted prefixes
0 announced prefixes

Connections established 1; dropped 0
Local host: 3ffe:10::10, Local port: 179
Foreign host: 3ffe:10::11, Foreign port: 46240
Nexthop: 10.10.10.10
Nexthop global: 3ffe:10::10
Nexthop local: fe80::5054:ff:fe11:d4f5
BGP connection: shared network

R2

R2#show bgp ipv6 summary

BGP router identifier 10.10.10.11, local AS number 300
BGP table version is 1
0 BGP AS-PATH entries
0 BGP community entries

Neighbor PfxRcd	V	AS	MsgRcv	MsgSen	TblVer	InQ	OutQ	Up/Down	State/
3ffe:10::10 0	4	200	2	2	1	0	0	00:00:24	

BGP4+

Total number of neighbors 1

Total number of Established sessions 1

R2#show bgp ipv6 neighbors

```
BGP neighbor is 3ffe:10::10, remote AS 200, local AS 300, external link
  BGP version 4, local router ID 10.10.10.11, remote router ID 10.10.10.10
  BGP state = Established, up for 00:01:32
  Last read 00:00:08, hold time is 90, keepalive interval is 30 seconds
  Neighbor capabilities:
    Route refresh: advertised and received (old and new)
    Address family IPv6 Unicast: advertised and received
  Received 5 messages, 0 notifications, 0 in queue
  Sent 5 messages, 0 notifications, 0 in queue
  Route refresh request: received 0, sent 0
  Minimum time between advertisement runs is 30 seconds
For address family: IPv6 Unicast
  BGP table version 1, neighbor version 1
  Index 1, Offset 0, Mask 0x2
  Community attribute sent to this neighbor (both)
  0 accepted prefixes
  0 announced prefixes

Connections established 1; dropped 0
Local host: 3ffe:10::11, Local port: 46240
Foreign host: 3ffe:10::10, Foreign port: 179
Nexthop: 10.10.10.11
Nexthop global: 3ffe:10::11
Nexthop local: fe80::5054:ff:fe82:8dcc
BGP connection: shared network
```

Route-Map

Use route-maps to filter incoming updates from a BGP peer. In this example, a prefix list named `myPrefixList` on R1 is configured to deny entry of any routes with the IP address `3ffe:12::/32`. To test the filter, R2 is configured to generate network prefixes `3ffe:11::/48` and `3ffe:12::/48`. To verify, use the `show bgp ipv6` command on R1; it displays R1 receiving only the `3ffe:11::/48` network prefix.

Topology

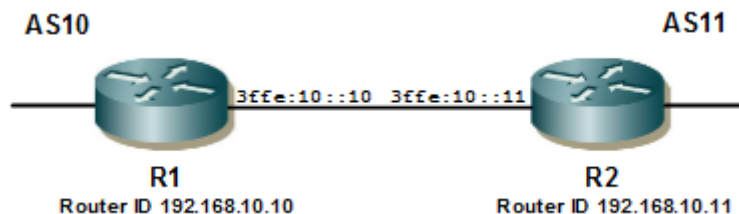

Figure 2-45: Route-Map

Configuration

R1

#configure terminal	Enter Configure mode.
(config)Interface eth1	Specify the interface (eth1) to configure
(config)Ipv6 address 3ffe:10::10/64	Specify the IPv6 global address
(config)Exit	Enter Configure mode
(config)#ipv6 prefix-list myPrefixList	Create an entry in the prefix-list. myPrefixList is the name of the map that is created
(config-ipv6-prefix-list)#seq 5 deny 3ffe:12::/32 ge 48 le 64	Here 5 and 10 specify the sequence number or position of this specific route map. deny specifies the packets are to be rejected. permit specifies the packets are to be allowed. 48 and 64 are the minimum and maximum prefix lengths, respectively, to be matched.
(config-ipv6-prefix-list)#seq 10 permit any	Create another entry in the myPrefixList map. 10 specifies the sequence number or position of this specific route map. permit any specifies accept all packets of any length.
(config-ipv6-prefix-list)#exit	Exit the prefix-list mode
(config)#route-map myPrefixList permit 1	Enter Route-map mode.
(config-route-map)#match ipv6 address prefix-list myPrefixList	Set the match criteria. In this case, if the route-map name matches myPrefixList, the packets from the first sequence will be denied.
(config-route-map)#exit	Exit Route-map mode, and return to Configure mode.
(config)#commit	Commit the candidate configuration to the running configuration
(config)#router bgp 10	Define the routing process. The number 10 specifies the AS number of R1.
(config-router)#bgp router-id 192.168.10.10	Configure a fixed Router ID (192.168.10.10) for the BGP4+ routing process.
(config-router)#neighbor 3ffe:10:11 remote- as 11	Define the BGP neighbor (R2), and establish a TCP session by specifying the IPv6 address (3ffe:10::11) and the AS number (11) of neighbor R2.
(config-router-af)#exit	Exit from router BGP mode.
(config)#commit	Commit the candidate configuration to the running configuration.
(config-router)#address-family ipv6	Enter Address Family mode for configuring routing sessions that use IPv6 address prefixes.
(config-router-af)#neighbor 3ffe:10::11 activate	Activate the neighbor R2 (3ffe:10::11), and enable exchange of IPv6 address prefix types with this neighbor.
(config-router-af)#neighbor 3ffe:10::11 route-map myPrefixList in	Apply the route-map myPrefixList to all incoming routes.
(config-router-af)#exit-address-family	Exit Address Family mode, and return to Router mode.
(config-router-af)#exit	Exit Router mode, and return to Configure mode.
(config)#commit	Commit the candidate configuration to the running configuration.

R2

#configure terminal	Enter Configure mode.
(config)Interface eth1	Specify the interface (eth1) to configure
(config)Ipv6 address 3ffe:10::11/64	Specify the IPv6 global address
(config)Exit	Enter Configure mode
(config)#router bgp 11	Define the routing process. The number 11 specifies the AS number of R2.
(config-router)#bgp router-id 192.168.10.11	Configure a fixed Router ID (192.168.10.11) for the BGP4+ routing process.
(config-router)#neighbor 3ffe:10::10 remote-as 10	Define the BGP neighbor (R1), and establish a TCP session by specifying the IPv6 address (3ffe:10::10) and the AS number (10) of neighbor R1.
(config-router)#address-family ipv6	Enter Address Family mode for configuring routing sessions that use IPv6 address prefixes.
(config-router-af)#network 3ffe:11::/48	Announce the IPv6 network prefix (3ffe:11::/48).
(config-router-af)#network 3ffe:12::/48	Announce the IPv6 network prefix (3ffe:12::/48).
(config-router-af)#neighbor 3ffe:10::10 activate	Activate the neighbor R1 (3ffe:10::10), and enable exchange of IPv6 address prefix types with this neighbor.
(config-router-af)#exit-address-family	Exit Address Family mode, and return to Router mode.
(config)#commit	Commit the candidate configuration to the running configuration.

Validation

show bgp ipv6 summary, show bgp ipv6 neighbors, show bgp ipv6, show bgp ipv6 prefix-list.

R1

R1#show ipv6 bgp summary

BGP router identifier 192.168.10.10, local AS number 10

BGP table version is 1

0 BGP AS-PATH entries

0 BGP community entries

Neighbor PfxRcd	V	AS	MsgRcv	MsgSen	TblVer	InQ	OutQ	Up/Down	State/
3ffe:10::11 0	4	11	140	306	1	0	0	00:10:44	

Total number of neighbors 1

Total number of Established sessions 1

R1#show bgp ipv6 neighbors

```
BGP neighbor is 3ffe:10::11, remote AS 11, local AS 10, external link
  BGP version 4, local router ID 192.168.10.10, remote router ID 192.168.10.11
  BGP state = Established, up for 00:11:02
  Last read 00:00:23, hold time is 90, keepalive interval is 30 seconds
  Neighbor capabilities:
    Route refresh: advertised and received (old and new)
    Address family IPv6 Unicast: advertised and received
  Received 140 messages, 0 notifications, 0 in queue
  Sent 194 messages, 113 notifications, 0 in queue
  Route refresh request: received 0, sent 0
  Minimum time between advertisement runs is 30 seconds
For address family: IPv6 Unicast
  BGP table version 1, neighbor version 1
  Index 1, Offset 0, Mask 0x2
  Community attribute sent to this neighbor (both)
  Inbound path policy configured
  Route map for incoming advertisements is *myPrefixList
  0 accepted prefixes
  0 announced prefixes

Connections established 1; dropped 0
Local host: 3ffe:10::10, Local port: 179
Foreign host: 3ffe:10::11, Foreign port: 46796
Nexthop: 192.168.10.10
Nexthop global: 3ffe:10::10
Nexthop local: fe80::5054:ff:fe11:d4f5
BGP connection: shared network
Last Reset: 00:11:06, due to OPEN Message Error (Notification sent)
Notification Error Message: (OPEN Message Error/Bad Peer AS.)
```

R2

```
R1#show bgp ipv6 neighbors
BGP neighbor is 3ffe:10::11, remote AS 11, local AS 10, external link
  BGP version 4, local router ID 192.168.10.10, remote router ID 192.168.10.11
  BGP state = Established, up for 00:11:02
  Last read 00:00:23, hold time is 90, keepalive interval is 30 seconds
  Neighbor capabilities:
    Route refresh: advertised and received (old and new)
    Address family IPv6 Unicast: advertised and received
  Received 140 messages, 0 notifications, 0 in queue
  Sent 194 messages, 113 notifications, 0 in queue
  Route refresh request: received 0, sent 0
  Minimum time between advertisement runs is 30 seconds
For address family: IPv6 Unicast
  BGP table version 1, neighbor version 1
  Index 1, Offset 0, Mask 0x2
  Community attribute sent to this neighbor (both)
  Inbound path policy configured
  Route map for incoming advertisements is *myPrefixList
  0 accepted prefixes
```

0 announced prefixes

```

Connections established 1; dropped 0
Local host: 3ffe:10::10, Local port: 179
Foreign host: 3ffe:10::11, Foreign port: 46796
Nexthop: 192.168.10.10
Nexthop global: 3ffe:10::10
Nexthop local: fe80::5054:ff:fe11:d4f5
BGP connection: shared network
Last Reset: 00:11:06, due to OPEN Message Error (Notification sent)
Notification Error Message: (OPEN Message Error/Bad Peer AS.)
    
```

Route Reflector

Use Route Reflectors to reduce the iBGP mesh inside an AS. In this example, R2, R5, and R4 would have to maintain a full mesh among themselves, but by making R5 the Route Reflector, R2 (Client1) has an iBGP session with RR only, and not with R4 (Client 2). The routes learned from R2 are advertised to the other clients, and to iBGP peers outside the cluster; the iBGP routes learned from iBGP peers outside the cluster are advertised to the R2. This reduces the iBGP peer connections in AS1.

Topology

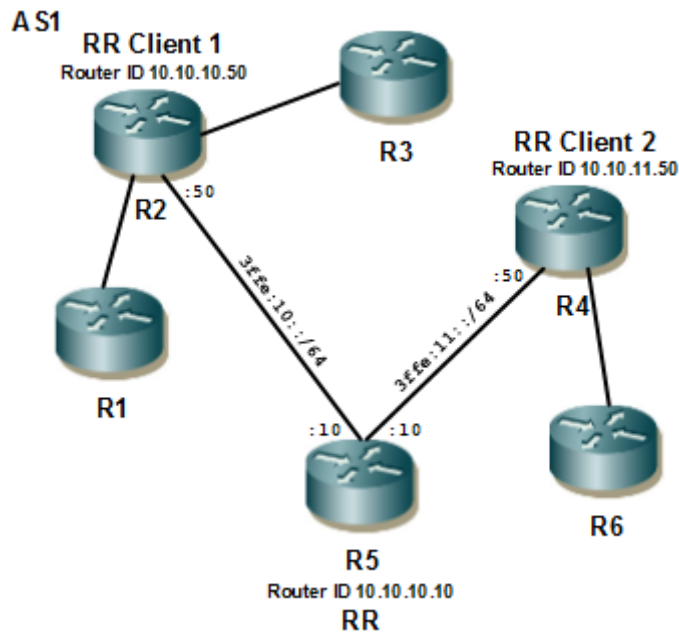

Figure 2-46: BGP4+ Route Reflector

Configuration

RR (R5)

#configure terminal	Enter Configure mode.
(config)#router bgp 1	Define the routing process. The number 1 specifies the AS number of R5 (RR).
(config-router)#bgp router-id 10.10.10.10	Configure a fixed Router ID (10.10.10.10) for the BGP4+ routing process.
(config-router)#neighbor 3ffe:10::50 remote-as 1	Define the BGP neighbor (R2), and establish a TCP session by specifying the IPv6 address (3ffe:10::50) and the AS number (1) of neighbor R2.
(config-router)#neighbor 3ffe:11::50 remote-as 1	Define the BGP neighbor (R4), and establish a TCP session by specifying the IPv6 address (3ffe:11::50) and the AS number (1) of neighbor R4.
(config-router)#address-family ipv6	Enter Address Family mode for configuring routing sessions that use IPv6 address prefixes.
(config-router-af)#neighbor 3ffe:10::50 activate	Activate the neighbor R2 (3ffe:10::50), and enable exchange of IPv6 address prefix types with this neighbor.
(config-router-af)#neighbor 3ffe:10::50 route-reflector-client	Configure R5 as the Route-Reflector (RR) and neighbor R2 as its client.
(config-router-af)#neighbor 3ffe:11::50 activate	Activate the neighbor R4 (3ffe:11::50), and enable exchange of IPv6 address prefix types with this neighbor.
(config-router-af)#neighbor 3ffe:11::50 route-reflector-client	Configure R5 as the Route-Reflector (RR) and neighbor R4 as its client.
(config-router-af)#exit-address-family	Exit address family
(config-router)#commit	Commit the candidate configuration to the running configuration.

RR Client 1 (R2)

(config)#router bgp 1	Define the routing process. The number 1 specifies the AS number of R2 (RR Client 1).
(config-router)#bgp router-id 10.10.10.50	Configure a fixed Router ID (10.10.10.50) for the BGP4+ routing process.
(config-router)#neighbor 3ffe:10::10 remote-as 1	Define the BGP neighbor (R5), and establish a TCP session by specifying the IPv6 address (3ffe:10::10) and the AS number (1) of neighbor R5.
(config-router)#address-family ipv6	Enter Address Family mode for configuring routing sessions that use IPv6 address prefixes.
(config-router-af)#neighbor 3ffe:10::10 activate	Activate the neighbor (3ffe:10::10), and enable exchange of IPv6 address prefix types with this neighbor.

BGP4+

<code>(config-router-af) #exit-address-family</code>	Exit address family
<code>(config-router) #commit</code>	Commit the candidate configuration to the running configuration.

RR Client 2 (R4)

<code>(config) #router bgp 1</code>	Define the routing process. The number 1 specifies the AS number of R4 (RR Client 2).
<code>(config-router) #bgp router-id 10.10.11.50</code>	Configure a fixed Router ID (10.10.11.50) for the BGP4+ routing process.
<code>(config-router) #neighbor 3ffe:11::10 remote-as 1</code>	Define the BGP neighbor (R5), and establish a TCP session by specifying the IPv6 address (3ffe:11::10) and the AS number (1) of the neighbor.
<code>(config-router) #address-family ipv6</code>	Enter Address Family mode for configuring routing sessions that use IPv6 address prefixes.
<code>(config-router-af) #neighbor 3ffe:11::10 activate</code>	Activate the neighbor (3ffe:11::10), and enable exchange of IPv6 address prefix types with this neighbor.
<code>(config-router-af) #exit-address-family</code>	Exit address family
<code>(config-router) #commit</code>	Commit the candidate configuration to the running configuration.

Validation

show bgp ipv6 summary, show bgp ipv6 neighbors

Confederations

In this example, AS1 contains three Confederated Autonomous Systems--AS 1000, AS 1001 and AS 1002. To any outside AS, the overall Confederation is a single AS, AS1. Confederation eBGP is run between R2 and R5, and between R5 and R7. R2 is configured so that its local AS is 1000. Its peer connection to R5 is set up like any other eBGP session. The `bgp confederation identifier` command informs the router that it is a member of a Confederation and passes the Confederation ID. The `bgp confederation peers` command lists the member AS to which R2 is connected. The same command tells the BGP process that the eBGP connection is a Confederation eBGP, rather than a normal eBGP.

Topology

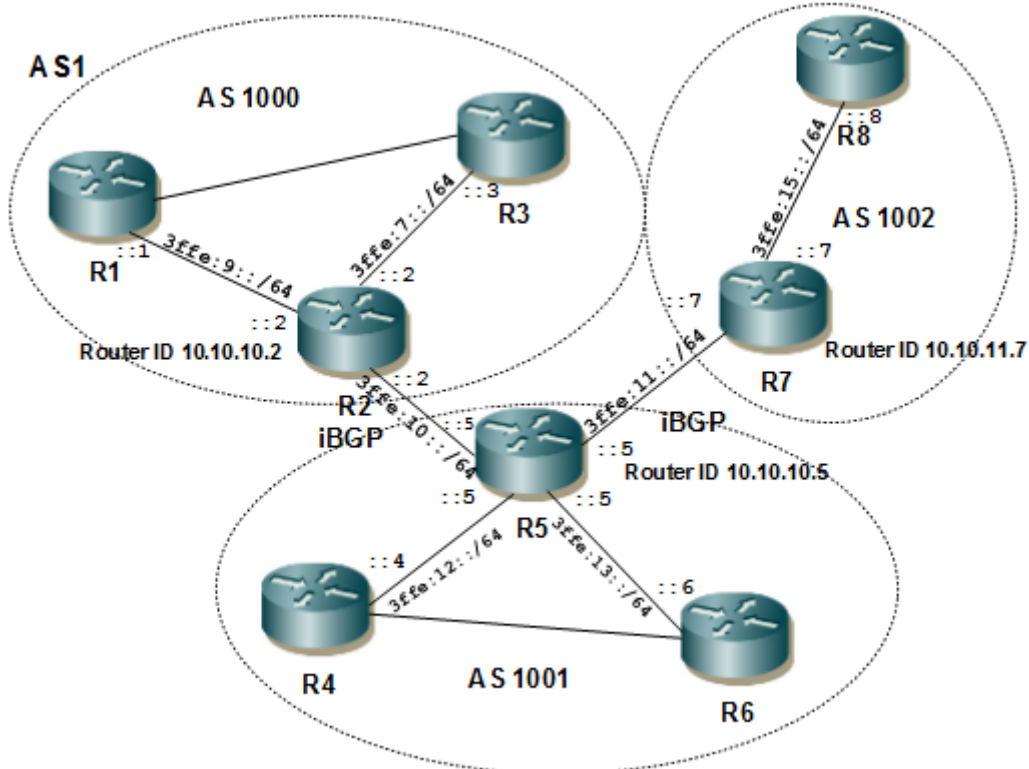

Figure 2-47: BGP4+ Confederations

Configuration

R2

#configure terminal	Enter Configure mode.
(config)#router bgp 1000	Define the routing process. The number 1000 specifies the AS number of R2.
(config-router)#bgp router-id 10.10.10.2	Configure a fixed Router ID (10.10.10.2) for the BGP4+ routing process.
(config-router)#bgp confederation identifier 1	Specify the BGP Confederation Identifier (1). To others, the group will appear as a single AS, and the identifier as its AS number.
(config-router)#bgp confederation peers 1001	Specify AS 1001 as a confederation peer, making it a member of the Confederation.
(config-router)#bgp confederation peers 1002	Specify AS 1002 as a confederation peer, making it a member of the Confederation.
(config-router)#neighbor 3ffe:10::5 remote-as 1001	Define the BGP neighbor (R5), and establish a TCP session by specifying the IPv6 address (3ffe:10::5) and the AS number (1001) of neighbor R5.

BGP4+

<pre>(config-router)#neighbor 3ffe:9::1 remote-as 1000</pre>	Define the BGP neighbor (R1), and establish a TCP session by specifying the IPv6 address (3ffe:9::1) and the AS number (1000) of neighbor R1.
<pre>(config-router)#neighbor 3ffe:7::3 remote-as 1000</pre>	Define the BGP neighbor (R3), and establish a TCP session by specifying the IPv6 address (3ffe:7::3) and the AS number (1000) of neighbor R3.
<pre>(config-router)#address-family ipv6</pre>	Enter Address Family mode for configuring routing sessions that use IPv6 address prefixes.
<pre>(config-router-af)#neighbor 3ffe:10::5 activate</pre>	Activate neighbor R5 (3ffe:10::5), and enable exchange of IPv6 address prefix types with this neighbor.
<pre>(config-router-af)#neighbor 3ffe:9::1 activate</pre>	Activate neighbor R1 (3ffe:9::1), and enable exchange of IPv6 address prefix types with this neighbor.
<pre>(config-router-af)#neighbor 3ffe:7::3 activate</pre>	Activate neighbor R3 (3ffe:7::3), and enable exchange of IPv6 address prefix types with this neighbor.
<pre>(config-router-af)#exit-address-family</pre>	Exit address family
<pre>(config-router)#commit</pre>	Commit the candidate configuration to the running configuration.

R5

<pre>(config)#router bgp 1001</pre>	Define the routing process. The number 1001 specifies the AS number of R5.
<pre>(config-router)#bgp router-id 10.10.10.5</pre>	Configure a fixed Router ID (10.10.10.5) for the BGP4+ routing process.
<pre>(config-router)#bgp confederation identifier 1</pre>	Specify the BGP Confederation Identifier (1). To others, the group will appear as a single AS, and the identifier as its AS number.
<pre>(config-router)#bgp confederation peers 1000</pre>	Specify AS 1000 as s confederation peer, making it a member of the Confederation.
<pre>(config-router)#bgp confederation peers 1002</pre>	Specify AS 1002 as s confederation peer, making it a member of the Confederation.
<pre>(config-router)#neighbor 3ffe:10::2 remote-as 1000</pre>	Define the BGP neighbor (R2), and establish a TCP session by specifying the IPv6 address (3ffe:10::2) and the AS number (1000) of neighbor R2.
<pre>(config-router)#neighbor 3ffe:11::7 remote-as 1002</pre>	Define the BGP neighbor (R7), and establish a TCP session by specifying the IPv6 address (3ffe:11::7) and the AS number (1002) of neighbor R7.
<pre>(config-router)#neighbor 3ffe:12::4 remote-as 1001</pre>	Define the BGP neighbor (R4), and establish a TCP session by specifying the IPv6 address (3ffe:12::4) and the AS number (1001) of neighbor R4.
<pre>(config-router)#neighbor 3ffe:13::6 remote-as 1001</pre>	Define the BGP neighbor (R6), and establish a TCP session by specifying the IPv6 address (3ffe:13::6) and the AS number (1001) of neighbor R6.
<pre>(config-router)#address-family ipv6</pre>	Enter Address Family mode for configuring routing sessions that use IPv6 address prefixes.
<pre>(config-router-af)#neighbor 3ffe:10::2 activate</pre>	Activate the neighbor R2 (3ffe:10::2), and enable exchange of IPv6 address prefix types with this neighbor.
<pre>(config-router-af)#neighbor 3ffe:11::7 activate</pre>	Activate the neighbor R7 (3ffe:11::7), and enable exchange of IPv6 address prefix types with this neighbor.

<code>(config-router-af)#neighbor 3ffe:12::4 activate</code>	Activate the neighbor R4 (3ffe:12::4), and enable exchange of IPv6 address prefix types with this neighbor.
<code>(config-router-af)#neighbor 3ffe:13::6 activate</code>	Activate the neighbor R6 (3ffe:13::6), and enable exchange of IPv6 address prefix types with this neighbor.
<code>(config-router-af)#exit-address-family</code>	Exit address family
<code>(config-router)#commit</code>	Commit the candidate configuration to the running configuration.

R7

<code>(config)#router bgp 1002</code>	Define the routing process. The number 1002 specifies the AS number of R7.
<code>(config-router)#bgp router-id 10.10.11.7</code>	Configure a fixed Router ID (10.10.11.7) for the BGP4+ routing process.
<code>(config-router)#bgp confederation identifier 1</code>	Specify BGP Confederation Identifier (1). To others, the group will appear as a single AS, and the identifier as its AS number.
<code>(config-router)#bgp confederation peers 1000</code>	Specify AS 1000 as s confederation peer, making it a member of the Confederation.
<code>(config-router)#bgp confederation peers 1001</code>	Specify AS 1001 as s confederation peer, making it a member of the Confederation.
<code>(config-router)#neighbor 3ffe:11::5 remote-as 1001</code>	Define the BGP neighbor (R5), and establish a TCP session by specifying the IPv6 address (3ffe:11::5) and the AS number (1001) of neighbor R5.
<code>(config-router)#neighbor 3ffe:15::8 remote-as 1002</code>	Define the BGP neighbor (R8), and establish a TCP session by specifying the IPv6 address (3ffe:15::8) and the AS number (1002) of neighbor R8.
<code>(config-router)#address-family ipv6</code>	Enter Address Family mode for configuring routing sessions that use IPv6 address prefixes.
<code>(config-router-af)#neighbor 3ffe:11::5 activate</code>	Activate the neighbor R5 (3ffe:11::5), and enable exchange of IPv6 address prefix types with this neighbor.
<code>(config-router-af)#neighbor 3ffe:15::8 activate</code>	Activate the neighbor R8 (3ffe:15::8), and enable exchange of IPv6 address prefix types with this neighbor.
<code>(config-router-af)#exit-address-family</code>	Exit address family
<code>(config-router)#commit</code>	Commit the candidate configuration to the running configuration.

Validation

show bgp ipv6 summary, show bgp ipv6 neighbors

BGP4+ Graceful Restart

Using BGP+ graceful restart, the data-forwarding plane of a router can continue to process and forward packets, even if the control plane (which is responsible for determining best paths) fails.

Topology

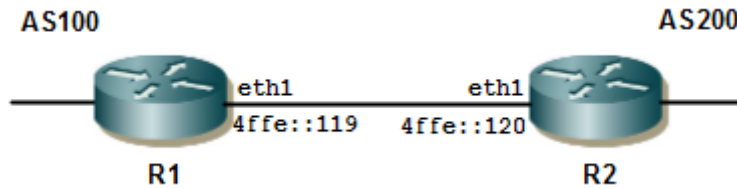

Figure 2-48: BGP4+ Graceful Restart

Configuration

R1

#configure terminal	Enter Configure mode.
(config)#interface lo	Enter to the interface mode.
(config-if)#ipv6 address 4000::1/64	Assign ipv6 address to loopback interface.
(config-if)#exit	Exit from interface mode.
(config)#interface xe9	Enter to the interface mode.
(config-if)#ipv6 address 4ffe::119/64	Configure ipv6 address.
(config-if)#exit	Exit from interface mode.
(config)#router bgp 100	Assign the ASN value (100) to the router.
(config-router)# bgp router-id 1.1.1.1	Configuring bgp router id.
(config-router)#bgp graceful-restart	Enable BGP graceful restart support.
(config-router)#neighbor 4ffe::120 remote-as 200	Specify the neighbor's IP address (4ffe::120) and the ASN value of the neighbor (200).
(config-router)#address-family ipv6 unicast	Exchange the IPv6 capabilities, and switch the mode to the IPv6 address family.
(config-router-af)#network 4000::/64	Advertising ipv6 address.
(config-router-af)#neighbor 4ffe::120 activate	Specify the neighbor's IPv6 address (4ffe::120), and activate the neighbor.
(config-router-af)#neighbor 4ffe::120 capability graceful-restart	Specify the neighbor's IPv6 address (4ffe::120) for which the graceful restart capability is supported.
(config-router-af)#exit-address-family	Exit address family
(config-router)#commit	Commit the candidate configuration to the running configuration.

R2

#configure terminal	Enter Configure mode
(config)#interface xe9	Enter to the interface mode
(config-if)#ipv6 address 4ffe::119/64	Configure ipv6 address.
(config-if)#exit	Exit from interface mode.
(config)#router bgp 200	Assign the ASN value (200) to the router.

(config-router)# bgp router-id 2.2.2.2	Configuring bgp router id.
(config-router)#bgp graceful-restart	Enable BGP graceful restart support.
(config-router)#bgp graceful-restart restart-time 120	Configure the maximum time (120) required for neighbor(s) to restart.
(config-router)#bgp graceful-restart stalepath-time 120	Configure the maximum time (120) to retain stale paths from the restarting neighbor(s).
(config-router)#neighbor 4ffe::119 remote-as 100	Specify the neighbor's IP address (4ffe::119) and the ASN value of the neighbor (100).
(config-router)#address-family ipv6 unicast	Exchange the IPv6 capabilities, and switch the mode to the IPv6 address family.
(config-router-af)#neighbor 4ffe::119 activate	Specify the neighbor's IPv6 address (4ffe::119), and activate the neighbor.
(config-router-af)#neighbor 4ffe::119 capability graceful-restart	Specify the neighbor's IPv6 address (4ffe::119) for which the graceful restart capability is supported.
(config-router-af)#exit-address-family	Exit address family
(config-router)#commit	Commit the candidate configuration to the running configuration.

Validation

R1

```
#show bgp ipv6 summary
BGP router identifier 1.1.1.1, local AS number 100
BGP table version is 1
1 BGP AS-PATH entries
0 BGP community entries
```

Neighbor PfxRcd	V	AS	MsgRcv	MsgSen	TblVer	InQ	OutQ	Up/Down	State/
4ffe::120 0	4	200	8	11	1	0	0	00:01:02	

Total number of neighbors 1

Total number of Established sessions 1

```
#show ip bgp neighbors
BGP neighbor is 4ffe::120, remote AS 200, local AS 100, external link
  BGP version 4, local router ID 1.1.1.1, remote router ID 2.2.2.2
  BGP state = Established, up for 00:01:31
  Last read 00:00:17, hold time is 90, keepalive interval is 30 seconds
  Neighbor capabilities:
    Route refresh: advertised and received (old and new)
    Address family IPv6 Unicast: advertised and received
  Received 9 messages, 0 notifications, 0 in queue
  Sent 12 messages, 0 notifications, 0 in queue
  Route refresh request: received 0, sent 0
  Minimum time between advertisement runs is 30 seconds
```

For address family: IPv6 Unicast
BGP table version 1, neighbor version 1
Index 1, Offset 0, Mask 0x2
AF-dependant capabilities:
Graceful restart: advertised, received
Forwarding states are being preserved
Community attribute sent to this neighbor (both)
0 accepted prefixes
1 announced prefixes

Connections established 2; dropped 1
Graceful-restart Status:
Remote restart-time is 90 sec

Local host: 4ffe::119, Local port: 179
Foreign host: 4ffe::120, Foreign port: 58264
Nexthop: 1.1.1.1
Nexthop global: 4ffe::119
Nexthop local: fe80::eac5:7aff:fe8b:a827
BGP connection: shared network

#show bgp ipv6
BGP table version is 1, local router ID is 1.1.1.1
Status codes: s suppressed, d damped, h history, a add-path, * valid, > best, i - internal,
l - labeled, S Stale
Origin codes: i - IGP, e - EGP, ? - incomplete

	Network	Next Hop	Metric	LocPrf	Weight	Path
*>	4000::/64	::	0	100	32768	i

Total number of prefixes 1

#show ipv6 route database bgp
IP Route Table for VRF "default"

#show ipv6 route database
IPv6 Routing Table
Codes: K - kernel route, C - connected, S - static, D- DHCP, R - RIP,
O - OSPF, IA - OSPF inter area, E1 - OSPF external type 1,
E2 - OSPF external type 2, E - EVPN N1 - OSPF NSSA external type 1,
N2 - OSPF NSSA external type 2, i - IS-IS, B - BGP,
v - vrf leaked
> - selected route, * - FIB route,p - stale info

Timers: Uptime

IP Route Table for VRF "default"
C *> ::1/128 via ::, lo, 10:38:02
C *> 4000::/64 via ::, lo, 00:25:40
C *> 4ffe::/64 via ::, xe9, 00:49:30
C *> fe80::/64 via ::, xe9, 02:06:22

```

C      fe80::/64 via ::, xe5, 05:16:16
C      fe80::/64 via ::, xe12, 05:33:37
C      fe80::/64 via ::, xe11, 05:33:37
C      fe80::/64 via ::, ce1, 10:38:02

```

```
#show ipv6 route
```

```
IPv6 Routing Table
```

```

Codes: K - kernel route, C - connected, S - static, D- DHCP, R - RIP,
       O - OSPF, IA - OSPF inter area, E1 - OSPF external type 1,
       E2 - OSPF external type 2, E - EVPN  N1 - OSPF NSSA external type 1,
       N2 - OSPF NSSA external type 2, i - IS-IS, B - BGP,
       v - vrf leaked

```

```
Timers: Uptime
```

```
IP Route Table for VRF "default"
```

```

C      ::1/128 via ::, lo, 10:38:34
C      4000::/64 via ::, lo, 00:26:12
C      4ffe::/64 via ::, xe9, 00:50:02
C      fe80::/64 via ::, xe9, 02:06:54

```

R2

```
#show bgp ipv6 summary
```

```
BGP router identifier 2.2.2.2, local AS number 200
```

```
BGP table version is 2
```

```
1 BGP AS-PATH entries
```

```
0 BGP community entries
```

Neighbor PfxRcd	V	AS	MsgRcv	MsgSen	TblVer	InQ	OutQ	Up/Down	State/
4ffe::119	4	100	14	14	2	0	0	00:05:08	
1									

```
Total number of neighbors 1
```

```
Total number of Established sessions 1
```

```
#show ip bgp neighbors
```

```
BGP neighbor is 4ffe::119, remote AS 100, local AS 200, external link
```

```
BGP version 4, local router ID 2.2.2.2, remote router ID 1.1.1.1
```

```
BGP state = Established, up for 00:06:16
```

```
Last read 00:00:10, hold time is 90, keepalive interval is 30 seconds
```

```
Neighbor capabilities:
```

```
Route refresh: advertised and received (old and new)
```

```
Address family IPv6 Unicast: advertised and received
```

```
Received 17 messages, 0 notifications, 0 in queue
```

```
Sent 17 messages, 0 notifications, 0 in queue
```

```
Route refresh request: received 0, sent 0
```

```
Minimum time between advertisement runs is 30 seconds
```

```
For address family: IPv6 Unicast
```

```
BGP table version 2, neighbor version 2
```

```
Index 1, Offset 0, Mask 0x2
```

BGP4+

AF-dependant capabilities:

Graceful restart: advertised, received

Community attribute sent to this neighbor (both)

1 accepted prefixes

0 announced prefixes

Connections established 1; dropped 0

Graceful-restart Status:

Remote restart-time is 90 sec

Local host: 4ffe::120, Local port: 58264

Foreign host: 4ffe::119, Foreign port: 179

Nexthop: 2.2.2.2

Nexthop global: 4ffe::120

Nexthop local: fe80::82a2:35ff:fe7e:8833

BGP connection: shared network

#show bgp ipv6

BGP table version is 2, local router ID is 2.2.2.2

Status codes: s suppressed, d damped, h history, a add-path, * valid, > best, i - internal,

l - labeled, S Stale

Origin codes: i - IGP, e - EGP, ? - incomplete

	Network	Next Hop	Metric	LocPrf	Weight	Path
*>	4000::/64	4ffe::119(fe80::eac5:7aff:fe8b:a827)	0	100	0	100 i

Total number of prefixes 1

#show ipv6 route database bgp

IP Route Table for VRF "default"

B *> 4000::/64 [20/0] via fe80::eac5:7aff:fe8b:a827, xe9, 00:06:53

#show ipv6 route database

IPv6 Routing Table

Codes: K - kernel route, C - connected, S - static, D- DHCP, R - RIP,

O - OSPF, IA - OSPF inter area, E1 - OSPF external type 1,

E2 - OSPF external type 2, E - EVPN N1 - OSPF NSSA external type 1,

N2 - OSPF NSSA external type 2, i - IS-IS, B - BGP,

v - vrf leaked

> - selected route, * - FIB route, p - stale info

Timers: Uptime

IP Route Table for VRF "default"

C *> ::1/128 via ::, lo, 02:11:57

B *> 4000::/64 [20/0] via fe80::eac5:7aff:fe8b:a827, xe9, 00:08:19

C *> 4ffe::/64 via ::, xe9, 00:50:24

C *> fe80::/64 via ::, xe13, 00:05:07

```

C      fe80::/64 via ::, ce1, 02:11:57
C      fe80::/64 via ::, ce0, 02:11:57
C      fe80::/64 via ::, xe23, 02:11:57
C      fe80::/64 via ::, xe22, 02:11:57
C      fe80::/64 via ::, xe21, 02:11:57
C      fe80::/64 via ::, xe20, 02:11:57
C      fe80::/64 via ::, xe15, 02:11:57
C      fe80::/64 via ::, xe9, 02:11:57
C      fe80::/64 via ::, xe6, 02:11:57

```

```
#show ipv6 route
```

```
IPv6 Routing Table
```

```

Codes: K - kernel route, C - connected, S - static, D- DHCP, R - RIP,
       O - OSPF, IA - OSPF inter area, E1 - OSPF external type 1,
       E2 - OSPF external type 2, E - EVPN  N1 - OSPF NSSA external type 1,
       N2 - OSPF NSSA external type 2, i - IS-IS, B - BGP,
       v - vrf leaked

```

```
Timers: Uptime
```

```
IP Route Table for VRF "default"
```

```

C      ::1/128 via ::, lo, 02:14:13
B      4000::/64 [20/0] via fe80::eac5:7aff:fe8b:a827, xe9, 00:10:35
C      4ffe::/64 via ::, xe9, 00:52:40
C      fe80::/64 via ::, xe13, 00:07:23

```

Performing BGP Graceful Restart

```
#write memory
```

```
Building configuration...
```

```
[OK]
```

```
#restart bgp graceful
```

```
%Warning : BGP process will stop and needs to restart manually,
```

```
You may lose bgp configuration,if not saved
```

```
Proceed for graceful restart? (y/n):y
```

```
2019 Feb 22 16:08:20.149 : OcNOS : BGP : CRITI : [BGP_OPR_NEIGH_STATE_DOWN_2]: Neighbour
[4ffe::119] Session down as GR configured/unconfigured
```

```
2019 Feb 22 16:08:20.149 : OcNOS : BGP : CRITI : [BGP_OPR_NEIGH_STATE_DOWN_2]: Neighbour
[4ffe::119] Session down due to config deletion
```

```
2019 Feb 22 16:08:20.153 : OcNOS : CML : CRITI : Module bgpd disconnected with CML
```

```
%% Managed module is down or crashed
```

```
2019 Feb 22 16:08:20.153 : OcNOS : CML : CRITI : Module bgpd disconnected with CML
```

```
#show ipv6 route
```

```
IPv6 Routing Table
```

```

Codes: K - kernel route, C - connected, S - static, D- DHCP, R - RIP,
       O - OSPF, IA - OSPF inter area, E1 - OSPF external type 1,
       E2 - OSPF external type 2, E - EVPN  N1 - OSPF NSSA external type 1,
       N2 - OSPF NSSA external type 2, i - IS-IS, B - BGP,
       v - vrf leaked

```

```
Timers: Uptime
```

IP Route Table for VRF "default"

```
C      ::1/128 via ::, lo, 02:18:54
B      4000::/64 [20/0] via fe80::eac5:7aff:fe8b:a827, xe9, 00:15:16
C      4ffe::/64 via ::, xe9, 00:57:21
C      fe80::/64 via ::, xe13, 00:12:04
```

#show ipv6 route database

IPv6 Routing Table

```
Codes: K - kernel route, C - connected, S - static, D- DHCP, R - RIP,
       O - OSPF, IA - OSPF inter area, E1 - OSPF external type 1,
       E2 - OSPF external type 2, E - EVPN N1 - OSPF NSSA external type 1,
       N2 - OSPF NSSA external type 2, i - IS-IS, B - BGP,
       v - vrf leaked
       > - selected route, * - FIB route,p - stale info
```

Timers: Uptime

IP Route Table for VRF "default"

```
C  *>  ::1/128 via ::, lo, 02:19:23
B  *>p 4000::/64 [20/0] via fe80::eac5:7aff:fe8b:a827, xe9, 00:15:45
C  *>  4ffe::/64 via ::, xe9, 00:57:50
C  *>  fe80::/64 via ::, xe13, 00:12:33
C      fe80::/64 via ::, ce1, 02:19:23
C      fe80::/64 via ::, ce0, 02:19:23
C      fe80::/64 via ::, xe23, 02:19:23
C      fe80::/64 via ::, xe22, 02:19:23
C      fe80::/64 via ::, xe21, 02:19:23
C      fe80::/64 via ::, xe20, 02:19:23
C      fe80::/64 via ::, xe15, 02:19:23
C      fe80::/64 via ::, xe9, 02:19:23
C      fe80::/64 via ::, xe6, 02:19:23
```

Restarting the BGP Daemon

```
#start-shell
bash-5.0$ su
Password:
root@OcnOS:/home/ocnos# cd /usr/local/sbin/
root@OcnOS:/usr/local/sbin# ./bgpd -d
```

Configure BGP4+ Distance

Administrative distance in BGP+ can be configured for a specific address family.

This example shows configuring the BGP administrative distance for the IPv6 address family.

Topology

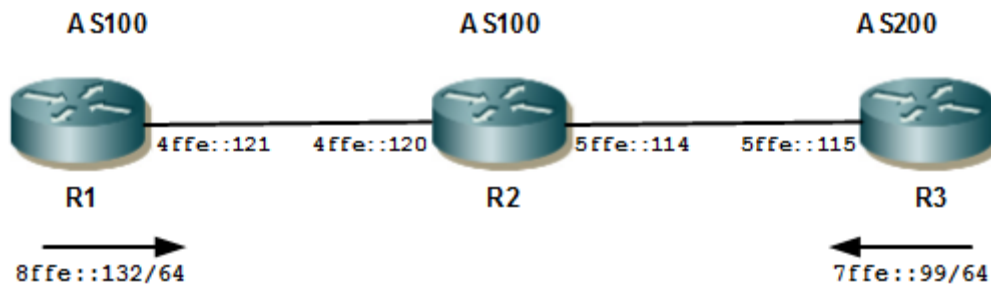

Figure 2-49: BGP4+ Distance

Configuration

R1

#configure terminal	Enter Configure mode.
(config)#router bgp 100	Assign the ASN value (100) to the router.
(config-router)#neighbor 4ffe::120 remote-as 100	Specify the neighbor's IP address and ASN value.
(config-router)#address-family ipv6 unicast	Enter IPv6 Address-Family mode.
(config-router-af)#neighbor 4ffe::120 activate	Activate the IPv6 neighbor.
(config-router-af)#network 8ffe::132/64	Specify the network to be advertised by the BGP routing process.
(config-router-af)#exit-address-family	Exit Address Family mode, and return to Router mode.
(config-router)#commit	Commit the candidate configuration to the running configuration.

R2

#configure terminal	Enter Configure mode.
(config)#router bgp 100	Assign the ASN value (100) to the router.
(config-router)#neighbor 4ffe::121 remote-as 100	Specify the neighbor's IP address and ASN value.
(config-router)#neighbor 5ffe::115 remote-as 200	Specify the neighbor's IP address and the ASN value of another neighbor.
(config-router)#address-family ipv6 unicast	Enter IPv6 Address-Family mode.
(config-router-af)#aggregate-address 2ffe::102/32 summary-only	Configure an IPv6 non-AS-set aggregate route on R2. The local distance will be applied to this route.
(config-router-af)#neighbor 4ffe::121 activate	Activate the IPv6 neighbor.
(config-router-af)#neighbor 5ffe::115 activate	Activate the IPv6 neighbor.

BGP4+

<code>(config-router-af)#distance bgp 12 13 11</code>	Configure the administrative distance for external, internal, and local routes received in IPv6 Address-Family mode.
<code>(config-router-af)#exit-address-family</code>	Exit Address Family mode, and return to Router mode.
<code>(config-router)#commit</code>	Commit the candidate configuration to the running configuration.

R3

<code>#configure terminal</code>	Enter Configure mode.
<code>(config)#router bgp 100</code>	Assign the ASN value (100) to the router.
<code>(config-router)#neighbor 5ffe::114 remote-as 100</code>	Specify the neighbor's IP address and ASN value.
<code>(config-router)#address-family ipv6 unicast</code>	Enter IPv6 Address-Family mode.
<code>(config-router)#network 7ffe::99/64</code>	Specify the network to be advertised by the BGP routing process.
<code>(config-router-af)#neighbor 5ffe::114 activate</code>	Activate the IPv6 neighbor.
<code>(config-router-af)#exit-address-family</code>	Exit Address Family mode, and return to Router mode.
<code>(config-router)#commit</code>	Commit the candidate configuration to the running configuration.

Validation

show bgp ipv6 summary, show ip bgp neighbors, show ipv6 route database bgp, show ipv6 route database, show ipv6 route, show bgp ipv6

BGP4+ Graceful Reset

The graceful restart mechanism for BGP+ session reset (the BGP+ daemon is not restarted) is used so that any changes in network configuration do not affect packet forwarding. The `bgp graceful-restart graceful-reset` CLI invokes graceful restart when a configuration change forces a peer reset. Graceful restart is invoked only when these CLI configuration changes force a peer reset.

Topology

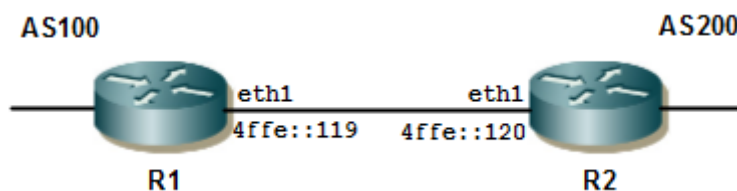

Figure 2-50: BGP4+ Graceful Reset

Configuration

R1

#configure terminal	Enter Configure mode.
(config)#router bgp 100	Assign the ASN value (100) to the router.
(config-router)#bgp graceful-restart	Enable BGP graceful restart support.
(config-router)#bgp graceful-restart graceful-reset	Configure to invoke graceful restart when a configuration change forces a peer reset.
(config-router)#neighbor 4ffe::120 remote-as 200	Specify the neighbor's IP address (4ffe::120) and the ASN value of the neighbor (200).
(config-router)#address-family ipv6 unicast	Exchange the IPv6 capabilities, and switch the mode to the IPv6 address family.
(config-router-af)#neighbor 4ffe::120 activate	Specify the neighbor's IPv6 address (4ffe::120), and activate the neighbor.
(config-router-af)#neighbor 4ffe::120 capability graceful-restart	Specify the neighbor's IPv6 address (4ffe::120) for which the graceful restart capability is supported.
(config-router-af)#exit-address-family	Exit Address Family mode, and return to Router mode.
(config-router)#commit	Commit the candidate configuration to the running configuration.

R2

#configure terminal	Enter Configure mode.
(config)#router bgp 200	Assign the ASN value (200) to the router.
(config-router)#bgp graceful-restart	Enable BGP graceful restart support.
(config-router)#bgp graceful-restart graceful-reset	Configure to invoke graceful restart when a configuration change forces a peer reset.
(config-router)#neighbor 4ffe::119 remote-as 100	Specify the neighbor's IP address (4ffe::119) and the ASN value of the neighbor (100).
(config-router)#address-family ipv6 unicast	Exchange the IPv6 capabilities, and switch the mode to the IPv6 address family.
(config-router-af)#neighbor 4ffe::119 activate	Specify the neighbor's IPv6 address (4ffe::119), and activate the neighbor.
(config-router-af)#neighbor 4ffe::119 capability graceful-restart	Specify the neighbor's IPv6 address (4ffe::119) for which the graceful restart capability is supported.
(config-router-af)#exit-address-family	Exit Address Family mode, and return to Router mode.
(config-router)#commit	Commit the candidate configuration to the running configuration.

Validation

show bgp ipv6 summary, show ip bgp neighbors, show bgp ipv6, show ipv6 route database bgp, show ipv6 route database, show ipv6 route

VPNv4 NLRI with IPv6 Nexthop

Multi-protocol BGP (MP-BGP) specifies that the set of usable next-hop address families is determined by the Address Family Identifier (AFI) and the Subsequent Address Family Identifier (SAFI). Historically the AFI/SAFI definitions for the IPv4 address family only have provisions for advertising a Next Hop address that belongs to the IPv4 protocol when advertising IPv4 or VPN-IPv4 Network Layer Reachability Information (NLRI).

The extensions necessary to allow advertising IPv4 NLRI or VPN-IPv4 NLRI with a Next Hop address that belongs to the IPv6 protocol. This comprises an extension of the AFI/SAFI definitions to allow the address of the Next Hop for IPv4 NLRI or VPN-IPv4 NLRI to also belong to the IPv6 Protocol. The encoding of the Next Hop to determine which of the protocols the address actually belongs to, and a new BGP Capability allowing MP-BGP Peers to dynamically discover whether they can exchange IPv4 NLRI and VPN-IPv4 NLRI with an IPv6 Next Hop.

Topology

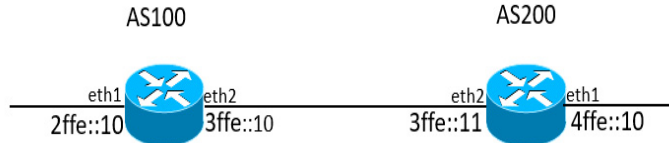

Figure 2-51: VPNv4 NLRI with IPv6 Nexthop

Configuration

R1

#configure terminal	Enter Configure mode.
(config)# ip vrf VRF1	Create a VRF, vrf1.
(config-vrf)#rd 100:10	Configure a route distinguisher value.
(config-vrf)#route-target both 100:10	Configure a route target both value to VRF.
(config-vrf)#exit	Exit from VRF configuration mode.
(config)#interface eth1	Enter Interface configuration mode.
(config-if)#ip vrf forwarding VRF1	Configure the interface to a VRF.
(config-if)#ip address 30.30.30.30/24	Assign an IP address to the interface.
(config-if)#ipv6 address 2ffe::10/64	Assign an IPV6 address to the interface.
(config-if)#exit	Exit from interface configuration mode.
(config)#ip route vrf VRF1 50.50.50.0/24 eth1	Create a VRF static route.
(config)#interface eth2	Enter Interface configuration mode.
(config-if)#ipv6 address 3ffe::10/64	Assign an IPV6 address to the interface.
(config-if)#exit	Exit from interface configuration mode.

(config)#router bgp 100 Define the routing process.	The number 100 specifies the AS number of R1.
(config-router)#bgp router-id 1.1.1.1	Configure a fixed Router ID (1.1.1.1) for the BGP4+ routing process.
(config-router)#neighbor 2.2.2.2 remote-as 200	Define BGP neighbors, and establish a TCP session. 2.2.2.2 is the IP address of the neighbor (R1), and 200 is the neighbor's AS number.
(config-router)#neighbor 3ffe::11 remote-as 200	Define the BGP neighbor (R2), and establish a TCP session by specifying the IPv6 address (3ffe::11) and the AS number (200) of neighbor R2.
(config-router)#address-family vpnv4 unicast	Enter Address Family mode for configuring routing sessions that use IPv6 address prefixes.
(config-router-af)#neighbor 2.2.2.2 activate	Activate the neighbor R2(2.2.2.2), and enable exchange of IP address prefix types with this neighbor.
(config-router-af)#neighbor 3ffe::11 allow- ebgp-vpn	Apply allow-ebgp-vpn to allow an eBGP neighbor to be a VPN peer.
(config-router-af)#neighbor 3ffe::11 activate	Activate the neighbor R2(3ffe::11), and enable exchange of IPv6 address prefix types with this neighbor.
(config-router-af)#neighbor 3ffe::11 capability extended-nexthop-encode	Enable capability to encode IPv6 nexthop in VPNv4 NLRI.
(config-router-af)#exit-address-family	Exit Address Family mode, and return to Router mode.
(config-router)#address-family ipv4 vrf VRF1	Enter IPv4 VRF address family.
(config-router-af)#redistribute static	Redistribute static into the IPv4 VRF address family.
(config-router-af)#exit-address-family	Exit Address Family mode, and return to Router mode.
(config-router)#exit	Exit Router mode, and return to Configure mode.
(config)#commit	Apply commit.
(config)#exit	Exit the config mode.

R2

#configure terminal	Enter Configure mode.
(config)# ip vrf VRF1	Create a VRF, vrf1.
(config-vrf)#rd 100:10	Configure a route distinguisher value.
(config-vrf)#route-target both 100:10	Configure a route target both value to VRF.
(config-vrf)#exit	Exit from VRF configuration mode.
(config)#interface eth1	Enter Interface configuration mode.
(config-if)#ip vrf forwarding VRF1	Configure the interface to a VRF.
(config-if)#ip address 40.40.40.40/24	Assign an IP address to the interface.
(config-if)#ipv6 address 4ffe::10/64	Assign an IPV6 address to the interface.
(config-if)#exit	Exit from interface configuration mode.
(config)#ip route vrf VRF1 66.66.66.0/24 eth1	Create a VRF static route.
(config)#interface eth2	Enter Interface configuration mode.
(config-if)#ipv6 address 3ffe::11/64	Assign an IPV6 address to the interface.
(config-if)#exit	Exit from interface configuration mode.

BGP4+

<code>(config)#router bgp 200</code>	Define the routing process.	The number 200 specifies the AS number of R1.
<code>(config-router)#bgp router-id 2.2.2.2</code>		Configure a fixed Router ID (2.2.2.2) for the BGP4+ routing process.
<code>(config-router)#neighbor 1.1.1.1 remote-as 100</code>		Define BGP neighbors, and establish a TCP session. 1.1.1.1 is the IP address of the neighbor (R1), and 100 is the neighbor's AS number.
<code>(config-router)#neighbor 3ffe::10 remote-as 100</code>		Define the BGP neighbor (R2), and establish a TCP session by specifying the IPv6 address (3ffe::10) and the AS number (100) of neighbor R2.
<code>(config-router)#address-family vpv4 unicast</code>		Enter Address Family mode for configuring routing sessions that use IPv6 address prefixes.
<code>(config-router-af)#neighbor 1.1.1.1 activate</code>		Activate the neighbor R2(1.1.1.1), and enable exchange of IP address prefix types with this neighbor.
<code>(config-router-af)#neighbor 3ffe::10 allow-ebgp-vpn</code>		Apply allow-ebgp-vpn to allow an eBGP neighbor to be a VPN peer.
<code>(config-router-af)#neighbor 3ffe::10 activate</code>		Activate the neighbor R2(3ffe::10), and enable exchange of IPv6 address prefix types with this neighbor.
<code>(config-router-af)#neighbor 3ffe::10 capability extended-nextthop-encode</code>		Enable capability to encode IPv6 nexthop in VPNv4 NLRI.
<code>(config-router-af)#exit-address-family</code>		Exit Address Family mode, and return to Router mode.
<code>(config-router)#address-family ipv4 vrf VRF1</code>		Enter IPv4 VRF address family.
<code>(config-router-af)#redistribute static</code>		Redistribute static into the IPv4 VRF address family.
<code>(config-router-af)#exit-address-family</code>		Exit Address Family mode, and return to Router mode.
<code>(config-router)#exit</code>		Exit Router mode, and return to Configure mode.
<code>(config)#commit</code>		Apply commit.
<code>(config)#exit</code>		Exit the config mode.

Validation

R1

```
#show running-config router bgp
router bgp 100
  bgp router-id 1.1.1.1
  neighbor 2.2.2.2 remote-as 200
  neighbor 3ffe::11 remote-as 200
!
  address-family vpv4 unicast
  neighbor 2.2.2.2 activate
  neighbor 3ffe::11 allow-ebgp-vpn
  neighbor 3ffe::11 activate
  neighbor 3ffe::11 capability extended-nextthop-encode
  exit-address-family
!
  address-family ipv4 vrf vrf1
  redistribute static
```

```

exit-address-family
#sh ip bgp neighbors
BGP neighbor is 3ffe::11, remote AS 200, local AS 100, external link
  BGP version 4, local router ID 1.1.1.1, remote router ID 2.2.2.2
  BGP state = Established, up for 00:04:59
  Last read 00:00:16, hold time is 90, keepalive interval is 30 seconds
  Neighbor capabilities:
    Route refresh: advertised and received (old and new)
    Address family VPNv4 Unicast: advertised and received
    Address family IPv4 Unicast: advertised and received
  Received 167 messages, 1 notifications, 0 in queue
  Sent 166 messages, 1 notifications, 0 in queue
  Route refresh request: received 0, sent 0
  Minimum time between advertisement runs is 30 seconds
For address family: VPNv4 Unicast
  BGP table version 1, neighbor version 1
  Index 3, Offset 0, Mask 0x8
  Extended Nexthop Encoding: advertised and received
  NEXT_HOP is always this router
  Community attribute sent to this neighbor (both)
  0 accepted prefixes
  0 announced prefixes
Connections established 1; dropped 0
Local host: 3ffe::10, Local port: 60148
Foreign host: 3ffe::11, Foreign port: 179
Nexthop: 2.2.2.2
Nexthop global: 3ffe::10
Nexthop local: fe80::ba6a:97ff:fee0:61be
BGP connection: shared network
Last Reset: 00:05:04, due to Configuration Change (Cease Notification sent)
Notification Error Message: (Cease/Other Configuration Change.)

#sh ip bgp vpnv4 all
Status codes: s suppressed, d damped, h history, a add-path, * valid, > best, i
- internal, l - labeled
          S Stale
Origin codes: i - IGP, e - EGP, ? - incomplete

      Network          Next Hop          Metric    LocPrf    Weight Path
Route Distinguisher: 100:10 (Default for VRF vrf1)
*>  55.55.55.0/24    0.0.0.0           0         100       32768  ?
*>  66.66.66.0/24    0.0.0.0           0         100        0       ?
Announced routes count = 2
Accepted routes count = 0
Route Distinguisher: 100:10
* i  55.55.55.0/24    3ffe::11          0         100        0       ?
* i  66.66.66.0/24    3ffe::11          0         100        0       ?
Announced routes count = 0
Accepted routes count = 2

```

BGP4+

```
#sh ip bgp vpnv4 all summary
BGP router identifier 2.2.2.2, local AS number 100
BGP table version is 1
1 BGP AS-PATH entries
0 BGP community entries
```

Neighbor	V	AS	MsgRcv	MsgSen	TblVer	InQ	OutQ	Up/Dow
n State/PfxRcd								
2.2.2.2	4	400	0	0	0	0	0	never
Idle								

3ffe::11	4	400	163	163	1	0	0	00:00:04
2								

Total number of neighbors 2

Total number of Established sessions 1

R2

```
#show running-config router bgp
router bgp 200
  bgp router-id 2.2.2.2
  neighbor 1.1.1.1 remote-as 100
  neighbor 3ffe::10 remote-as 100
!
  address-family vpnv4 unicast
  neighbor 1.1.1.1 activate
  neighbor 3ffe::10 allow-ebgp-vpn
  neighbor 3ffe::10 activate
  neighbor 3ffe::10 capability extended-nexthop-encode
  exit-address-family
!
  address-family ipv4 vrf vrf1
  redistribute static
  exit-address-family
#sh ip bgp neighbors
BGP neighbor is 3ffe::10, remote AS100, local AS 200, external link
  BGP version 4, local router ID 2.2.2.2, remote router ID 1.1.1.1
  BGP state = Established, up for 00:04:59
  Last read 00:00:16, hold time is 90, keepalive interval is 30 seconds
  Neighbor capabilities:
    Route refresh: advertised and received (old and new)
    Address family VPNv4 Unicast: advertised and received
    Address family IPv4 Unicast: advertised and received
  Received 167 messages, 1 notifications, 0 in queue
  Sent 166 messages, 1 notifications, 0 in queue
  Route refresh request: received 0, sent 0
  Minimum time between advertisement runs is 30 seconds
For address family: VPNv4 Unicast
  BGP table version 1, neighbor version 1
  Index 3, Offset 0, Mask 0x8
```

```

Extended Nexthop Encoding: advertised and received
NEXT_HOP is always this router
Community attribute sent to this neighbor (both)
0 accepted prefixes
0 announced prefixes
Connections established 1; dropped 0
Local host: 3ffe::11, Local port: 60148
Foreign host: 3ffe::10, Foreign port: 179
Nexthop: 1.1.1.1
Nexthop global: 3ffe::11
Nexthop local: fe80::ba6a:97ff:fee0:61ab
BGP connection: shared network
Last Reset: 00:05:04, due to Configuration Change (Cease Notification sent)
Notification Error Message: (Cease/Other Configuration Change.)
#sh ip bgp vpnv4 all
Status codes: s suppressed, d damped, h history, a add-path, * valid, > best, i
- internal, l - labeled
                S Stale
Origin codes: i - IGP, e - EGP, ? - incomplete

```

```

      Network          Next Hop           Metric    LocPrf      Weight Path
Route Distinguisher: 100:10 (Default for VRF vrf1)
*>  55.55.55.0/24     0.0.0.0             0         100        32768  ?
*>  66.66.66.0/24     0.0.0.0             0         100         0      ?
Announced routes count = 2
Accepted routes count = 0
Route Distinguisher: 100:10
* i  55.55.55.0/24     3ffe::10            0         100         0      ?
* i  66.66.66.0/24     3ffe::10            0         100         0      ?
Announced routes count = 0
Accepted routes count = 2

```

```

#sh ip bgp vpnv4 all summary
BGP router identifier 1.1.1.1, local AS number 200
BGP table version is 1
1 BGP AS-PATH entries
0 BGP community entries

```

Neighbor	V	AS	MsgRcv	MsgSen	TblVer	InQ	OutQ	Up/Dow
1.1.1.1	4	400	0	0	0	0	0	never
3ffe::10	4	400	163	163	1	0	0	00:00:04

n State/PfxRcd
 Idle
 2
 Total number of neighbors 2
 Total number of Established sessions 1

CHAPTER 3 BGP Graceful Restart Configuration

During a BGP restart, all BGP peers detect that a session had gone down and come back up. OcNOS invalidates the associated portion of the IP forwarding cache, does a BGP route re-computation, and generates BGP routing updates. The forwarding tables become corrupted and unstable.

Graceful restart helps minimize these negative effects on routing caused by a BGP restart by allowing the restarting BGP router to temporarily retain routing information and continue forwarding packets while BGP restarts. In this way, even while a router rebuilds routing and forwarding tables, the router continues to operate across the TCP connection.

Graceful restart allows a restarting router, and its neighbors, to continue forwarding packets, without disrupting network performance. Because neighboring routers assist in the restart, the restarting router can quickly resume full operation.

The graceful restart capability extends to the case when a configuration change forces a peer reset.

Graceful reset is a refinement of graceful restart to help ensure smooth restarts when a configuration change forces BGP peer reset.

Topology

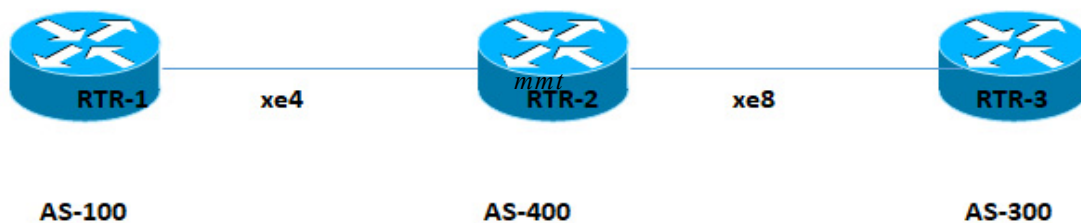

Figure 3-52: Device topology for BGP in VR/VRF

RTR1

#configure terminal	Enter Configuration mode.
(config)#interface lo	Enter interface mode for loopback.
(config-if)#ip address 1.1.1.1/32 secondary	Configure ip address on loopback.
(config-if)#exit	Exit interface mode.
(config)#interface xe4	Enter interface mode for eth2.
(config-if)#ip address 10.10.10.1/24	Configure ip address on eth2.
(config-if)#exit	Exit interface mode for eth2.
(config)# router bgp 100	Enter router bgp mode.
(config-router)# bgp router-id 1.1.1.1	Configure bgp router-id same as loopback ip address.
(config-router)# bgp graceful-restart	Configure Graceful Restart for BGP.
(config-router)# neighbor 10.10.10.2 remote-as 400	Configure Neighbor for AS-400.

BGP Graceful Restart Configuration

(config-router)# address-family ipv4 unicast	Enter address-family ipv4 unicast mode
(config-router-af)# neighbor 10.10.10.2 activate	Activate neighborship
(config-router-af)# redistribute connected	Redistributing connected Routes inside BGP.
(config-router-af)# neighbor 10.10.10.2 capability graceful-restart	Configure GR capability inside router bgp.
(config-router-af)# exit-address-family	Exit address-family mode.
(config-router)# commit	Commit the candidate configuration to the running configuration.

RTR2

#configure terminal	Enter Configuration mode.
(config)#interface lo	Enter interface mode for loopback.
(config-if)# ip address 2.2.2.2/32 secondary	Configure ip address on loopback.
(config-if)#exit	Exit interface mode.
(config)#interface xe4	Enter interface mode for eth1.
(config-if)#ip address 10.10.10.2/24	Configure ip address on eth1.
(config-if)#exit	Exit interface mode for eth1.
(config)#interface xe8	Enter interface mode for eth2.
(config-if)#ip address 20.20.20.1/24	Configure ip address on eth2.
(config-if)#exit	Exit interface mode for eth2.
(config)#commit	Commit the candidate configuration to the running configuration.
(config)#router bgp 400	Enter router BGP mode.
(config-router)# bgp router-id 2.2.2.2	Configure bgp router-id same as loopback ip address.
(config-router)# bgp graceful-restart	Configure Graceful Restart for BGP.
(config-router)# neighbor 10.10.10.1 remote-as 100	Configure Neighbor for AS-100.
(config-router)# neighbor 20.20.20.2 remote-as 300	Configure Neighbor for AS-300.
(config-router)#address-family ipv4 unicast	Enter address-family ipv4 unicast mode
(config-router-af)#redistribute connected	Redistributing connected Routes inside BGP.
(config-router-af)# neighbor 10.10.10.1 activate	Activate neighbor
(config-router-af)# neighbor 20.20.20.2 activate	Activate neighbor
(config-router-af)# neighbor 10.10.10.1 capability graceful-restart	Configure GR capability inside router bgp.
(config-router-af)# exit-address-family	Exit address-family mode.
(config-router)#commit	Commit the candidate configuration to the running configuration.

RTR3

#configure terminal	Enter Configuration mode.
(config)#interface lo	Enter interface mode for loopback.
(config-if)#ip address 3.3.3.3/32 secondary	Configure ip address on loopback.
(config-if)#exit	Exit interface mode.
(config)#interface xe8	Enter interface mode for eth2.
(config-if)#ip address 20.20.20.2/24	Configure ip address on eth2.
(config-if)#exit	Exit interface mode for eth2.
(config)# router bgp 300	Enter router BGP mode.
(config-router)# bgp router-id 3.3.3.3	Configure bgp router-id same as loopback ip address.
(config-router)# bgp graceful-restart	Configure Graceful Restart for BGP.
(config-router)# neighbor 20.20.20.1 remote-as 400	Configure Neighbor for AS-400.
(config-router)# address-family ipv4 unicast	Enter address-family ipv4 unicast mode
(config-router-af)# redistribute connected	Redistributing connected Routes inside BGP.
(config-router-af)# neighbor 20.20.20.1 activate	Activate the neighbor.
(config-router-af)# neighbor 20.20.20.1 capability graceful-restart	Configure GR capability inside router bgp.
(config-router-af)# exit-address-family	Exit address-family mode.
(config-router)#commit	Commit the candidate configuration to the running configuration.

Validation**RTR1**

```
RTR1#show bgp neighbors
BGP neighbor is 10.10.10.2, remote AS 400, local AS 100, external link
  BGP version 4, local router ID 1.1.1.1, remote router ID 2.2.2.2
  BGP state = Established, up for 00:03:31
  Last read 00:00:15, hold time is 90, keepalive interval is 30 seconds
  Neighbor capabilities:
    Route refresh: advertised and received (old and new)
    Address family IPv4 Unicast: advertised and received
  Received 13 messages, 1 notifications, 0 in queue
  Sent 13 messages, 0 notifications, 0 in queue
  Route refresh request: received 0, sent 0
  Minimum time between advertisement runs is 30 seconds
For address family: IPv4 Unicast
  BGP table version 2, neighbor version 2
  Index 1, Offset 0, Mask 0x2
  AF-dependant capabilities:
    Graceful restart: advertised, received
    Forwarding states are being preserved
  Community attribute sent to this neighbor (both)
  3 accepted prefixes
  2 announced prefixes
```

BGP Graceful Restart Configuration

```
Connections established 2; dropped 1
Graceful-restart Status:
  Remote restart-time is 90 sec

Local host: 10.10.10.1, Local port: 179
Foreign host: 10.10.10.2, Foreign port: 60024
Nexthop: 10.10.10.1
Nexthop global: ::
Nexthop local: ::
BGP connection: non shared network
Last Reset: 00:03:36, due to BGP Notification received
Notification Error Message: (Cease/Other Configuration Change.)

#show ip route databaseCodes: K - kernel, C - connected, S - static, R - RIP,
B - BGP O - OSPF, IA - OSPF inter area
N1 - OSPF NSSA external type 1, N2 - OSPF NSSA external type 2 E1 - OSPF
external type 1, E2 - OSPF external type 2
i - IS-IS, L1 - IS-IS level-1, L2 - IS-IS level-2,
ia - IS-IS inter area, E - EVPN, v - vrf leaked
> - selected route, * - FIB route, p - stale info

IP Route Table for VRF "default"
C*>1.1.1.1/32 is directly connected, lo, 00:10:23
B*>2.2.2.2/32 [20/0] via 10.10.10.2, xe4, 00:03:56
B*>3.3.3.3/32 [20/0] via 10.10.10.2, xe4, 00:00:56
C*>10.10.10.0/24 is directly connected, xe4, 00:09:37
B*>20.20.20.0/24 [20/0] via 10.10.10.2, xe4, 00:03:56
C*>127.0.0.0/8 is directly connected, lo, 00:28:58

Gateway of last resort is not set
```

RTR2

```
#show ip route database
Codes: K - kernel, C - connected, S - static, R - RIP, B - BGP O - OSPF, IA -
OSPF inter area
N1 - OSPF NSSA external type 1, N2 - OSPF NSSA external type 2 E1 - OSPF
external type 1, E2 - OSPF external type 2
i - IS-IS, L1 - IS-IS level-1, L2 - IS-IS level-2,
ia - IS-IS inter area, E - EVPN, v - vrf leaked
> - selected route, * - FIB route, p - stale info

IP Route Table for VRF "default"
B*>1.1.1.1/32 [20/0] via 10.10.10.1, xe4, 00:03:52
C*>2.2.2.2/32 is directly connected, lo, 00:07:36
B*>3.3.3.3/32 [20/0] via 20.20.20.2, xe8, 00:00:57

C*>10.10.10.0/24 is directly connected, xe4, 00:07:12 C*>20.20.20.0/24 is
directly connected, xe8, 00:06:31
C*>127.0.0.0/8 is directly connected, lo, 00:25:32

Gateway of last resort is not set
```

```
RTR2#show bgp neighbors
BGP neighbor is 10.10.10.1, remote AS 100, local AS 400, external link
  BGP version 4, local router ID 2.2.2.2, remote router ID 1.1.1.1
```

```
BGP state = Established, up for 00:04:28
Last read 00:00:10, hold time is 90, keepalive interval is 30 seconds
Neighbor capabilities:
  Route refresh: advertised and received (old and new)
  Address family IPv4 Unicast: advertised and received
  Received 43 messages, 1 notifications, 0 in queue
  Sent 41 messages, 2 notifications, 0 in queue
  Route refresh request: received 0, sent 0
  Minimum time between advertisement runs is 30 seconds
For address family: IPv4 Unicast
  BGP table version 2, neighbor version 2
  Index 1, Offset 0, Mask 0x2
  AF-dependant capabilities:
    Graceful restart: advertised, received
    Forwarding states are being preserved
  Community attribute sent to this neighbor (both)
  2 accepted prefixes
  3 announced prefixes

Connections established 4; dropped 3
Graceful-restart Status:
  Remote restart-time is 90 sec

Local host: 10.10.10.2, Local port: 60050
Foreign host: 10.10.10.1, Foreign port: 179
Nextthop: 10.10.10.2
Nextthop global: ::
Nextthop local: ::
BGP connection: non shared network
Last Reset: 00:04:33, due to Administratively Reset (Cease Notification sent)
Notification Error Message: (Cease/Administratively Reset.)

BGP neighbor is 20.20.20.2, remote AS 300, local AS 400, external link
  BGP version 4, local router ID 2.2.2.2, remote router ID 3.3.3.3
  BGP state = Established, up for 00:04:22
  Last read 00:00:03, hold time is 90, keepalive interval is 30 seconds
  Neighbor capabilities:
    Route refresh: advertised and received (old and new)
    Address family IPv4 Unicast: advertised and received
    Received 31 messages, 2 notifications, 0 in queue
    Sent 40 messages, 3 notifications, 0 in queue
    Route refresh request: received 0, sent 0
    Minimum time between advertisement runs is 30 seconds
  For address family: IPv4 Unicast
    BGP table version 2, neighbor version 2
    Index 2, Offset 0, Mask 0x4
    AF-dependant capabilities:
      Graceful restart: advertised, received
      Forwarding states are being preserved
    Community attribute sent to this neighbor (both)
    0 accepted prefixes
    4 announced prefixes

Connections established 4; dropped 3
Graceful-restart Status:
  Remote restart-time is 90 sec
```

BGP Graceful Restart Configuration

```
Local host: 20.20.20.1, Local port: 179
Foreign host: 20.20.20.2, Foreign port: 56342
Nexthop: 20.20.20.1
Nexthop global: ::
Nexthop local: ::
BGP connection: non shared network
Last Reset: 00:04:22, due to Administratively Reset (Cease Notification sent)
Notification Error Message: (Cease/Administratively Reset.)
```

RTR2#

RTR3

```
#show ip route database
Codes: K - kernel, C - connected, S - static, R - RIP, B - BGP O - OSPF, IA -
OSPF inter area
N1 - OSPF NSSA external type 1, N2 - OSPF NSSA external type 2 E1 - OSPF
external type 1, E2 - OSPF external type 2
i - IS-IS, L1 - IS-IS level-1, L2 - IS-IS level-2, ia - IS-IS inter area
> - selected route, * - FIB route, p - stale info
```

```
IP Route Table for VRF "default"
B*> 1.1.1.1/32 [20/0] via 20.20.20.1, xe8, 00:01:15
B*> 2.2.2.2/32 [20/0] via 20.20.20.1, xe8, 00:01:15
C*> 3.3.3.3/32 is directly connected, lo
B*> 10.10.10.0/24 [20/0] via 20.20.20.1, xe8, 00:01:15
C*> 20.20.20.0/24 is directly connected, xe8
C*> 127.0.0.0/8 is directly connected, lo
```

Gateway of last resort is not set

```
RTR3#show bgp neighbors
BGP neighbor is 20.20.20.1, remote AS 400, local AS 300, external link
  BGP version 4, local router ID 3.3.3.3, remote router ID 2.2.2.2
  BGP state = Established, up for 00:06:47
  Last read 00:00:13, hold time is 90, keepalive interval is 30 seconds
  Neighbor capabilities:
    Route refresh: advertised and received (old and new)
    Address family IPv4 Unicast: advertised and received
  Received 45 messages, 1 notifications, 0 in queue
  Sent 38 messages, 2 notifications, 0 in queue
  Route refresh request: received 0, sent 0
  Minimum time between advertisement runs is 30 seconds
For address family: IPv4 Unicast
  BGP table version 2, neighbor version 2
  Index 1, Offset 0, Mask 0x2
  AF-dependant capabilities:
    Graceful restart: advertised, received
    Forwarding states are being preserved
  Community attribute sent to this neighbor (both)
  4 accepted prefixes
  0 announced prefixes
```

```
Connections established 4; dropped 3
Graceful-restart Status:
  Remote restart-time is 90 sec
```

```
Local host: 20.20.20.2, Local port: 56342
```

```

Foreign host: 20.20.20.1, Foreign port: 179
Nextthop: 20.20.20.2
Nextthop global: ::
Nextthop local: ::
BGP connection: non shared network
Last Reset: 00:06:52, due to Administratively Reset (Cease Notification sent)
Notification Error Message: (Cease/Administratively Reset.)

```

```
RTR3#
```

Validation After BGP Graceful Restart

RTR2

```

#write
Building configuration... [OK]

#restart bgp graceful
2003 Sep 19 07:20:00.947 : NOS : BGP : CRITI : [BGP_OPR_NEIGH_STATE_DOWN_2]:
Neighbour
[10.10.10.1] Session down as GR configured/unconfigured
2003 Sep 19 07:20:00.947 : NOS : BGP : CRITI : [BGP_OPR_NEIGH_STATE_DOWN_2]:
Neighbour
[10.10.10.1] Session down due to config deletion
2003 Sep 19 07:20:00.947 : NOS : BGP : CRITI : [BGP_OPR_NEIGH_STATE_DOWN_2]:
Neighbour
[20.20.20.2] Session down as GR configured/unconfigured
2003 Sep 19 07:20:00.947 : NOS : BGP : CRITI : [BGP_OPR_NEIGH_STATE_DOWN_2]:
Neighbour
[20.20.20.2] Session down due to config deletion

#show ip route database
Codes: K - kernel, C - connected, S - static, R - RIP, B - BGP O - OSPF, IA -
OSPF inter area
N1 - OSPF NSSA external type 1, N2 - OSPF NSSA external type 2 E1 - OSPF
external type 1, E2 - OSPF external type 2
i - IS-IS, L1 - IS-IS level-1, L2 - IS-IS level-2,
ia - IS-IS inter area, E - EVPN, v - vrf leaked

> - selected route, * - FIB route, p - stale info

IP Route Table for VRF "default"
B*>p 1.1.1.1/32 [20/0] via 10.10.10.1, xe4, 00:19:31
C*>2.2.2.2/32 is directly connected, lo, 00:50:45
B*>p 3.3.3.3/32 [20/0] via 20.20.20.2, xe8, 00:19:32
C*>10.10.10.0/24 is directly connected, xe4, 00:50:21 C*>20.20.20.0/24 is
directly connected, xe8, 00:49:40
C*>127.0.0.0/8 is directly connected, lo, 01:08:41 Gateway of last resort is
not set
#show rib forwarding-timer
Protocol-Name GR-State Time Remaining (sec)Disconnected-time BGPACTIVE572001/
06/07 19:50:38

```

RTR1

```

#show ip bgp
BGP table version is 8, local router ID is 1.1.1.1

```

BGP Graceful Restart Configuration

```
Status codes: s suppressed, d damped, h history, * valid, > best, i -
internal, l - Labeled, S Stale
Origin codes: i - IGP, e - EGP, ? - incomplete
```

```
NetworkNext HopMetricLocPrfWeightPath
*>1.1.1.1/32
0.0.0.0010032768?
S>2.2.2.2/32
10.10.10.201000400?
S>3.3.3.3/32
10.10.10.201000400300?
*>10.10.10.0/240.0.0.0010032768?
S10.10.10.201000400?
S>20.20.20.0/2410.10.10.201000400?
```

Total number of prefixes 5

RTR3

```
#sh ip bgp
BGP table version is 14, local router ID is 3.3.3.3
Status codes: s suppressed, d damped, h history, * valid, > best, i -
internal, l - labeled, S Stale
Origin codes: i - IGP, e - EGP, ? - incomplete
```

```
NetworkNext HopMetricLocPrfWeightPath
S>1.1.1.1/32
20.20.20.101000400 100?
S>2.2.2.2/32
20.20.20.101000400 ?
*>3.3.3.3/32
0.0.0.0010032768?
S>10.10.10.0/2420.20.20.101000400 ?
*>20.20.20.0/240.0.0.0010032768?
S20.20.20.101000400 ?
```

Total number of prefixes 5

CHAPTER 4 BGP Labeled Unicast

As well as distributing routes, BGP with Multiprotocol Extensions (MP-BGP) can advertise MPLS label mappings that are mapped to routes. BGP Labeled Unicast (BGP-LU) attaches an MPLS label to an advertised IGP prefix and distributes the MPLS label mapped to the prefix to its peers.

With BGP-LU, a network can be divided into multiple regions to limit the total number of LSPs and enable failures to be contained and restored in a single region. These regions operate separate instances of the IGP and use BGP-LU to advertise route information between inter-region routers.

A configuration for BGP-LU uses these type of nodes:

- Provider Edge (PE) nodes advertise label bindings to remote PEs in other regions. These advertisements only affect the PE routers and the ABRs and not provider routers (“P”) in the core network.
- Area Border Router (ABR) nodes advertise the label bindings to remote PEs in other regions.

BGP Labeled Unicast as Transport

Topology

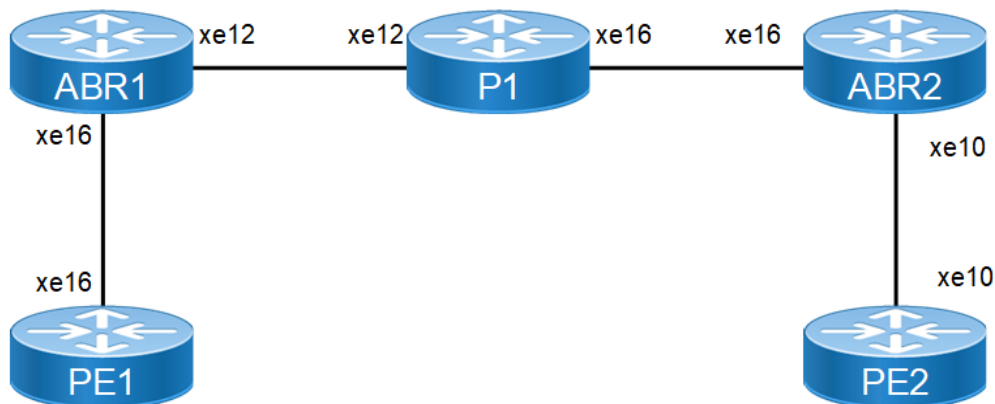

Figure 4-53: BGP labeled unicast

Configuration

PE1

#configure terminal	Enter the Configure mode.
(config)#interface lo	Enter interface mode
(config-if)#ip address 11.11.11.55/32 secondary	Configure the IP address of the interface loopback
(config-if)#exit	Exit interface mode
(config)#interface xe16	Enter interface mode

BGP Labeled Unicast

<code>(config-if)#ip address 172.4.5.55/24</code>	Configure the IP address of the interface eth1
<code>(config-if)#label-switching</code>	Enable label-switching on interface eth1
<code>(config-if)#exit</code>	Exit interface mode.
<code>(config)#commit</code>	Commit the candidate configuration to the running configuration.
<code>(config)#router ospf 1</code>	Configure the routing process OSPF with process Id 1
<code>(config-router)#network 172.4.5.0/24 area 0</code>	Define the interface (172.4.5.0/24) on which OSPF runs, and associate the area ID (0) with the interface (area ID 0 specifies the backbone area).
<code>(config-router)#network 11.11.11.55/32 area 0</code>	Define the interface (11.11.11.55/32) on which OSPF runs, and associate the area ID (0) with the interface (area ID 0 specifies the backbone area).
<code>(config-router)#exit</code>	Exit from router ospf mode
<code>(config)#commit</code>	Commit the candidate configuration to the running configuration.
<code>(config)#router bgp 100</code>	Enter Router BGP mode
<code>(config-router)# neighbor 21.21.21.56 update-source lo</code>	Add loopback ip of PE2 as neighbor with neighbor AS
<code>(config-router)#neighbor 21.21.21.56 update-source lo</code>	Update the source for that particular neighbor as loopback interface
<code>(config-router)#neighbor 172.4.5.52 remote-as 100</code>	Add neighbor with neighbor AS
<code>(config-router)#allocate-label all</code>	Allocate labels
<code>(config-router)#address-family ipv4 labeled-unicast</code>	Enter into labeled-unicast address family
<code>(config-router-af)#neighbor 172.4.5.52 activate</code>	Activate the neighbor inside labeled-unicast address family
<code>(config-router-af)#exit-address-family</code>	Exit from address family IPv4 labeled unicast
<code>(config-router)#address-family vpnv4 unicast</code>	Enter into vpnv4 unicast address family
<code>(config-router-af)#neighbor 21.21.21.56 activate</code>	Activate the neighbor inside vpnv4 address family
<code>(config-router-af)#exit-address-family</code>	Exit from address family vpnv4.
<code>(config-router)#address-family ipv4 unicast</code>	Enter into ipv4 unicast address family
<code>(config-router-af)#network 11.11.11.55/32</code>	Advertise the loopback of RTR1 in BGP
<code>(config-router-af)#exit-address-family</code>	Exit from address family vpnv4
<code>(config-router)#exit</code>	Exit from router BGP mode
<code>(config)#commit</code>	Commit the candidate configuration to the running configuration.
<code>(config)# ip vrf vrf1</code>	Specify the name of the VRF (vrf1) to be created.
<code>(config-vrf)#rd 10:100</code>	Assign a route distinguisher (RD) for the VRF, which is a unique value on the router. The RD value can be in ASN:NN or A.B.C.D:NN format.
<code>(config-vrf)#route-target both 100:300</code>	Specify the 2-Octet AS specific or IPv4 specific Transitive Route-Target extended community attribute.
<code>(config-vrf)#exit</code>	Exit VRF mode, and return to Configure mode.

(config)#interface xe10	Enter interface mode
(config-if)# ip vrf forwarding vrf1	Bind the interface (eth2) to the VRF vrf1
(config-if)# ip address 172.10.20.55/24	Configure the IP address of the interface eth2
(config-if)#exit	Exit interface mode.
(config)#router bgp 100	Enter Router BGP mode
(config-router)# address-family ipv4 vrf vrf1	Enter address family ipv4 vrf mode
(config-router-af)# redistribute connected	Redistribute connected routes
(config-router-af)# exit-address-family	Exit address-family mode.
(config-router)#commit	Commit the candidate configuration to the running configuration.

ABR1

#configure terminal	Enter the Configure mode.
(config)#interface lo	Enter interface mode
(config-if)#ip address 22.22.22.52/32 secondary	Configure the IP address of the interface loopback
(config-if)#exit	Exit interface mode
(config)#interface xe16	Enter interface mode
(config-if)#ip address 172.4.5.52/24	Configure the IP address of the interface eth1
(config-if)#label-switching	Enable label-switching on interface eth1
(config-if)#exit	Exit interface mode.
(config)#commit	Commit the candidate configuration to the running configuration.
(config)#interface xe12	Enter interface mode
(config-if)#ip address 172.6.7.52/24	Configure the IP address of the interface eth1
(config-if)#label-switching	Enable label-switching on interface eth1
(config-if)#exit	Exit interface mode.
(config)#commit	Commit the candidate configuration to the running configuration.
(config)#router ospf 1	Configure the routing process OSPF with process Id 1
(config-router)#network 172.4.5.0/24 area 0	Define the interface (172.4.5.0/24) on which OSPF runs, and associate the area ID (0) with the interface (area ID 0 specifies the backbone area).
(config-router)#network 172.6.7.0/24 area 0	Define the interface (172.6.7.0/24) on which OSPF runs, and associate the area ID (0) with the interface (area ID 0 specifies the backbone area).
(config-router)#exit	Exit from router ospf mode
(config)#router bgp 100	Enter Router BGP mode
(config-router)# neighbor 172.4.5.55 remote-as 100	Add neighbor with neighbor AS
(config-router)# neighbor 172.6.7.54 remote-as 100	Add neighbor with neighbor AS
(config-router)#allocate-label all	Allocate labels

BGP Labeled Unicast

(config-router)# address-family ipv4 labeled-unicast	Enter into labeled-unicast address family
(config-router-af)#neighbor 172.6.7.54 activate	Activate the neighbor inside labeled-unicast address family
(config-router-af)#neighbor 172.4.5.55 activate	Activate the neighbor inside labeled-unicast address family
(config-router-af)# neighbor 172.4.5.55 route-reflector-client	Enable Route reflector client for the neighbor inside address family IPv4 labeled unicast
(config-router-af)# neighbor 172.6.7.54 route-reflector-client	Enable Route reflector client for the neighbor inside address family IPv4 labeled unicast
(config-router-af)# neighbor 172.4.5.55 next-hop-self	Enable next hop self for the particular neighbor inside address family IPv4 labeled unicast
(config-router-af)# neighbor 172.6.7.54 next-hop-self	Enable next hop self for the particular neighbor inside address family IPv4 labeled unicast
(config-router-af)#exit-address-family	Exit address-family mode
(config-router)#exit	Exit from router BGP mode
(config)#commit	Commit the candidate configuration to the running configuration.

P1

#configure terminal	Enter the Configure mode.
(config)#interface lo	Enter interface mode
(config-if)# ip address 200.200.200.54/32 secondary	Configure the IP address of the interface loopbak
(config-if)#exit	Exit interface mode
(config)#interface xel6	Enter interface mode
(config-if)#ip address 172.1.2.54/24	Configure the IP address of the interface eth1
(config-if)#label-switching	Enable label-switching on interface eth1
(config-if)#exit	Exit interface mode.
(config)#interface xel2	Enter interface mode
(config-if)#ip address 172.6.7.54/24	Configure the IP address of the interface eth1
(config-if)#label-switching	Enable label-switching on interface eth1
(config-if)#exit	Exit interface mode.
(config)#router ospf 1	Configure the routing process OSPF with process Id 1
(config-router)#network 172.1.2.0/24 area 0	Define the interface (172.1.2.0/24) on which OSPF runs, and associate the area ID (0) with the interface (area ID 0 specifies the backbone area).
(config-router)#network 172.6.7.0/24 area 0	Define the interface (172.6.7.0/24) on which OSPF runs, and associate the area ID (0) with the interface (area ID 0 specifies the backbone area).
(config-router)#exit	Exit from router ospf mode
(config)#commit	Commit the candidate configuration to the running configuration.
(config)#router bgp 100	Enter Router BGP mode
(config-router)# neighbor 172.1.2.53 remote-as 100	Add neighbor with neighbor AS

(config-router)# neighbor 172.6.7.52 remote-as 100	Add neighbor with neighbor AS
(config-router)#allocate-label all	Allocate labels
(config-router)# address-family ipv4 labeled-unicast	Enter into labeled-unicast address family
(config-router-af)#neighbor 172.6.7.52 activate	Activate the neighbor inside labeled-unicast address family
(config-router-af)#neighbor 172.1.2.53 activate	Activate the neighbor inside labeled-unicast address family
(config-router-af)# neighbor 172.1.2.53 route-reflector-client	Enable Route reflector client for the neighbor inside address family IPv4 labeled unicast
(config-router-af)# neighbor 172.6.7.52 route-reflector-client	Enable Route reflector client for the neighbor inside address family IPv4 labeled unicast
(config-router-af)# neighbor 172.1.2.53 next-hop-self	Enable next hop self for the particular neighbor inside address family IPv4 labeled unicast
(config-router-af)# neighbor 172.6.7.52 next-hop-self	Enable next hop self for the particular neighbor inside address family IPv4 labeled unicast
(config-router)# exit-address-family	Exit from address family.
(config-router)#exit	Exit from router BGP mode
(config)#commit	Commit the candidate configuration to the running configuration.

ABR2

#configure terminal	Enter the Configure mode.
(config)#interface lo	Enter interface mode
(config-if)# ip address 44.44.44.53/32 secondary	Configure the IP address of the interface loopback
(config-if)#exit	Exit interface mode
(config)#interface xe16	Enter interface mode
(config-if)#ip address 172.1.2.53/24	Configure the IP address of the interface eth1
(config-if)#label-switching	Enable label-switching on interface eth1
(config-if)#exit	Exit interface mode.
(config)#interface xe10	Enter interface mode
(config-if)#ip address 172.3.4.53/24	Configure the IP address of the interface eth1
(config-if)#label-switching	Enable label-switching on interface eth1
(config-if)#exit	Exit interface mode.
(config)#commit	Commit the candidate configuration to the running configuration.
(config)#router ospf 1	Configure the routing process OSPF with process Id 1
(config-router)#network 172.1.2.0/24 area 0	Define the interface (172.1.2.0/24) on which OSPF runs, and associate the area ID (0) with the interface (area ID 0 specifies the backbone area).
(config-router)#network 172.3.4.0/24 area 0	Define the interface (172.3.4.0/24) on which OSPF runs, and associate the area ID (0) with the interface (area ID 0 specifies the backbone area).
(config-router)#exit	Exit from router ospf mode

BGP Labeled Unicast

(config)#commit	Commit the candidate configuration to the running configuration.
(config)#router bgp 100	Enter Router BGP mode
(config-router)# neighbor 172.1.2.54 remote-as 100	Add neighbor with neighbor AS
(config-router)# neighbor 172.3.4.56 remote-as 100	Add neighbor with neighbor AS
(config-router)#allocate-label all	Allocate labels
(config-router)# address-family ipv4 labeled-unicast	Enter into labeled-unicast address family
(config-router-af)#neighbor 172.3.4.56 activate	Activate the neighbor inside labeled-unicast address family
(config-router-af)#neighbor 172.1.2.54 activate	Activate the neighbor inside labeled-unicast address family
(config-router-af)# neighbor 172.3.4.56 route-reflector-client	Enable Route reflector client for the neighbor inside address family IPv4 labeled unicast
(config-router-af)# neighbor 172.1.2.54 route-reflector-client	Enable Route reflector client for the neighbor inside address family IPv4 labeled unicast
(config-router-af)# neighbor 172.3.4.56 next-hop-self	Enable next hop self for the particular neighbor inside address family IPv4 labeled unicast
(config-router-af)# neighbor 172.1.2.54 next-hop-self	Enable next hop self for the particular neighbor inside address family IPv4 labeled unicast
(config-router-af)#exit-address-family	Exit from address family vpvv4
(config-router)#exit	Exit from router BGP mode
(config)#end	Exit from config mode
(config)#commit	Commit the candidate configuration to the running configuration.

PE2

#configure terminal	Enter the Configure mode.
(config)#interface lo	Enter interface mode
(config-if)#ip address 21.21.21.56/32 secondary	Configure the IP address of the interface loopback
(config-if)#exit	Exit interface mode
(config)#interface xe10	Enter interface mode
(config-if)#ip address 172.3.4.56/24	Configure the IP address of the interface eth1
(config-if)#label-switching	Enable label-switching on interface eth1
(config-if)#exit	Exit interface mode.
(config)#router ospf 1	Configure the routing process OSPF with process Id 1
(config-router)#network 172.3.4.0/24 area 0	Define the interface (172.3.4.0/24) on which OSPF runs, and associate the area ID (0) with the interface (area ID 0 specifies the backbone area).
(config-router)#network 21.21.21.56/32 area 0	Define the interface (21.21.21.56/32) on which OSPF runs, and associate the area ID (0) with the interface (area ID 0 specifies the backbone area).
(config-router)#exit	Exit from router ospf mode

(config)#commit	Commit the candidate configuration to the running configuration.
(config)#router bgp 100	Enter Router BGP mode
(config-router)#neighbor 11.11.11.55 remote-as 100	Add loopback ip of PE1 as neighbor with neighbor AS
(config-router)#neighbor 11.11.11.55 update-source lo	Update the source for that particular neighbor as loopback interface
(config-router)# neighbor 172.3.4.53 remote-as 100	Add neighbor with neighbor AS
(config-router)#allocate-label all	Allocate labels
(config-router)# address-family ipv4 labeled-unicast	Enter into labeled-unicast address family
(config-router-af)#neighbor 172.3.4.53 activate	Activate the neighbor inside labeled-unicast address family
(config-router-af)#exit-address-family	Exit from address family IPv4 labeled unicast
(config-router)#address-family vpnv4 unicast	Enter into vpnv4 unicast address family
(config-router-af)#neighbor 11.11.11.55 activate	Activate the neighbor inside vpnv4 address family
(config-router-af)#exit-address-family	Exit from address family vpnv4
(config-router-af)#network 21.21.21.56/32	Advertise the loopback in BGP
(config-router-af)#exit-address-family	Exit from address family ipv4 unicast
(config-router)#exit	Exit from router BGP mode
(config)#commit	Commit the candidate configuration to the running configuration.
(config)# ip vrf vrf1	Specify the name of the VRF (vrf1) to be created.
(config-vrf)#rd 10:100	Assign a route distinguisher (RD) for the VRF, which is a unique value on the router. The RD value can be in ASN:NN or A.B.C.D:NN format.
(config-vrf)#route-target both 100:300	Specify the 2-Octet AS specific or IPv4 specific Transitive Route-Target extended community attribute.
(config-vrf)#exit	Exit VRF mode, and return to Configure mode.
(config)#interface xe0	Enter interface mode
(config-if)# ip vrf forwarding vrf1	Bind the interface (eth2) to the VRF vrf1
(config-if)# ip address 172.23.4.56/24	Configure the IP address of the interface eth2
(config-if)#exit	Exit interface mode.
(config)#router bgp 100	Enter Router BGP mode
(config-router)# address-family ipv4 vrf vrf1	Enter address family ipv4 vrf mode
(config-router)# redistribute connected	Redistribute connected routes
(config-router)#exit	Exit from router mode into privilege mode
(config)#commit	Commit the candidate configuration to the running configuration.

Validation

PE1

```
PE1#show ip bgp neighbors 21.21.21.56
BGP neighbor is 21.21.21.56, remote AS 100, local AS 100, internal link
  BGP version 4, local router ID 11.11.11.55, remote router ID 21.21.21.56
  BGP state = Established, up for 00:01:32
  Last read 00:00:21, hold time is 90, keepalive interval is 30 seconds
  Neighbor capabilities:
    Route refresh: advertised and received (old and new)
    Address family VPNv4 Unicast: advertised and received
  Received 7 messages, 0 notifications, 0 in queue
  Sent 9 messages, 0 notifications, 0 in queue
  Route refresh request: received 1, sent 0
  Minimum time between advertisement runs is 5 seconds
  Update source is lo
For address family: VPNv4 Unicast
  BGP table version 2, neighbor version 2
  Index 1, Offset 0, Mask 0x2
  Community attribute sent to this neighbor (both)
  1 accepted prefixes
  1 announced prefixes

Connections established 1; dropped 0
Local host: 11.11.11.55, Local port: 179
Foreign host: 21.21.21.56, Foreign port: 38231
Nexthop: 11.11.11.55
Nexthop global: ::
Nexthop local: ::
BGP connection: non shared network
```

```
PE1#show ip bgp neighbors 172.4.5.52
BGP neighbor is 172.4.5.52, remote AS 100, local AS 100, internal link
  BGP version 4, local router ID 11.11.11.55, remote router ID 22.22.22.52
  BGP state = Established, up for 00:26:00
  Last read 00:00:07, hold time is 90, keepalive interval is 30 seconds
  Neighbor capabilities:
    Route refresh: advertised and received (old and new)
    Address family IPv4 Unicast: received
    Address family IPv4 Labeled-Unicast: advertised and received
  Received 67 messages, 2 notifications, 0 in queue
  Sent 70 messages, 2 notifications, 0 in queue
  Route refresh request: received 0, sent 0
  Minimum time between advertisement runs is 5 seconds
For address family: IPv4 Labeled-Unicast
  BGP table version 2, neighbor version 2
  Index 1, Offset 0, Mask 0x2
  Community attribute sent to this neighbor (both)
  1 accepted prefixes
  1 announced prefixes

Connections established 3; dropped 2
Local host: 172.4.5.55, Local port: 179
```



```

Foreign host: 172.4.5.52, Foreign port: 34324
Nextthop: 172.4.5.55
Nextthop global: ::
Nextthop local: ::
BGP connection: non shared network
Last Reset: 00:26:00, due to Administratively Reset (Cease Notification sent)
Notification Error Message: (Cease/Administratively Reset.)

```

```
PE1#show ip bgp labeled-unicast
```

```

Status codes: s suppressed, d damped, h history, * valid, > best, i -
internal,
S - stale

```

Network	Next Hop	In Label	Out Label
*> 11.11.11.55/32	0.0.0.0	24320	-
*>i 21.21.21.56/32	172.4.5.52	24322	24321

```
PE1#show mpls forwarding-table
```

```

Codes: > - installed FTN, * - selected FTN, p - stale FTN,
B - BGP FTN, K - CLI FTN, t - tunnel, P - SR Policy FTN,
L - LDP FTN, R - RSVP-TE FTN, S - SNMP FTN, I - IGP-Shortcut,
U - unknown FTN, O - SR-OSPF FTN, i - SR-ISIS FTN, k - SR-CLI FTN

```

Code	FEC	FTN-ID	Nhlfe-ID	Tunnel-id	Pri	LSP-Type
0						
ut-Label	Out-Intf	ELC	Nextthop			
B>	21.21.21.56/32	1	2	-	-	LSP_DEFAULT
2						
	xe16	No	172.4.5.52			

```
PE1#
```

```
PE1#show mpls ilm-table
```

```

Codes: > - installed ILM, * - selected ILM, p - stale ILM
K - CLI ILM, T - MPLS-TP, s - Stitched ILM
S - SNMP, L - LDP, R - RSVP, C - CRLDP
B - BGP, K - CLI, V - LDP_VC, I - IGP_SHORTCUT
O - OSPF/OSPF6 SR, i - ISIS SR, k - SR CLI
P - SR Policy, U - unknown

```

Code	FEC/VRF/L2CKT	ILM-ID	In-Label	Out-Label	In-Intf	Out-
Intf						
/VRF	Nextthop		LSP-Type			
B>	vrf1	2	24321	Nolabel	N/A	vrf1
	N/A		LSP_DEFAULT			
B>	11.11.11.55/32	1	24320	Nolabel	N/A	N/A
	127.0.0.1		LSP_DEFAULT			
B>	21.21.21.56/32	3	24322	24321	N/A	N/A
	172.4.5.52		LSP_DEFAULT			

```
PE1#
```

ABR1

```
ABR1#show ip ospf neighbor
```

```

Total number of full neighbors: 2
OSPF process 1 VRF(default):

```

```

Neighbor ID      Pri   State           Dead Time   Address      Interface
Instance ID
11.11.11.55      1    Full/DR         00:00:35   172.4.5.55   xe16
0
200.200.200.54  1    Full/Backup     00:00:32   172.6.7.54   xe12
0

```

```
ABR1#show ip bgp labeled-unicast
```

```
Status codes: s suppressed, d damped, h history, * valid, > best, i -
internal, S - stale
```

Network	Next Hop	In Label	Out Label
*>i 11.11.11.55/32	172.4.5.55	24320	24320
*>i 21.21.21.56/32	172.6.7.54	24321	24321

```
ABR1#show ip bgp labeled-unicast
```

```
Status codes: s suppressed, d damped, h history, * valid, > best, i -
internal, S - stale
```

Network	Next Hop	In Label	Out Label
*>i 11.11.11.55/32	172.4.5.55	24320	24320
*>i 21.21.21.56/32	172.6.7.54	24321	24321

```
ABR1#show mpls forwarding-table | include 11.11.11.55
```

B>	11.11.11.55/32	1	0	Yes	LSP_DEFAULT	24320
xe16	No	172.4.5.55				

P1

```
P1#show ip bgp neighbors 172.6.7.52
```

```
BGP neighbor is 172.6.7.52, remote AS 100, local AS 100, internal link
BGP version 4, local router ID 200.200.200.54, remote router ID 22.22.22.52
BGP state = Established, up for 01:33:27
```

```
Last read 00:00:12, hold time is 90, keepalive interval is 30 seconds
```

```
Neighbor capabilities:
```

```
Route refresh: advertised and received (old and new)
```

```
Address family IPv4 Unicast: received
```

```
Address family IPv4 Labeled-Unicast: advertised and received
```

```
Received 229 messages, 0 notifications, 0 in queue
```

```
Sent 227 messages, 2 notifications, 0 in queue
```

```
Route refresh request: received 0, sent 0
```

```
Minimum time between advertisement runs is 5 seconds
```

```
For address family: IPv4 Labeled-Unicast
```

```
BGP table version 7, neighbor version 7
```

```
Index 1, Offset 0, Mask 0x2
```

```
Route-Reflector Client
```

```
NEXT_HOP is always this router
```

```
Community attribute sent to this neighbor (both)
```

```
1 accepted prefixes
```

```
1 announced prefixes
```

```
Connections established 3; dropped 2
```

```
Local host: 172.6.7.54, Local port: 47560
```

```
Foreign host: 172.6.7.52, Foreign port: 179
```

```
Nexthop: 172.6.7.54
```

```
Nexthop global: ::
```

```
Nexthop local: ::
```

```
BGP connection: non shared network
```

Last Reset: 01:33:32, due to Configuration Change (Cease Notification sent)
 Notification Error Message: (Cease/Other Configuration Change.)

```
P1#show ip bgp neighbors 172.1.2.53
BGP neighbor is 172.1.2.53, remote AS 100, local AS 100, internal link
  BGP version 4, local router ID 200.200.200.54, remote router ID 44.44.44.53
  BGP state = Established, up for 01:35:08
  Last read 00:00:19, hold time is 90, keepalive interval is 30 seconds
  Neighbor capabilities:
    Route refresh: advertised and received (old and new)
    Address family IPv4 Labeled-Unicast: advertised and received
  Received 230 messages, 2 notifications, 0 in queue
  Sent 233 messages, 0 notifications, 0 in queue
  Route refresh request: received 0, sent 0
  Minimum time between advertisement runs is 5 seconds
For address family: IPv4 Labeled-Unicast
  BGP table version 7, neighbor version 7
  Index 2, Offset 0, Mask 0x4
  Route-Reflector Client
  NEXT_HOP is always this router
  Community attribute sent to this neighbor (both)
  1 accepted prefixes
  1 announced prefixes
```

```
Connections established 3; dropped 2
Local host: 172.1.2.54, Local port: 179
Foreign host: 172.1.2.53, Foreign port: 58824
Nexthop: 172.1.2.54
Nexthop global: ::
Nexthop local: ::
BGP connection: non shared network
Last Reset: 01:35:13, due to BGP Notification received
Notification Error Message: (Cease/Other Configuration Change.)
```

```
P1#show ip bgp labeled-unicast
```

Status codes: s suppressed, d damped, h history, * valid, > best, i -
 internal, S - stale

Network	Next Hop	In Label	Out Label
*>i 11.11.11.55/32	172.6.7.52	24320	24320
*>i 21.21.21.56/32	172.1.2.53	24321	24321

```
P1#show mpls forwarding-table | include 11.11.11.55
```

B>	11.11.11.55/32	1	1	-	-	LSP_DEFAULT
24320	xel2	No	172.6.7.52			

ABR2

```
ABR2#show ip bgp labeled-unicast
```

Status codes: s suppressed, d damped, h history, * valid, > best, i -
 internal,

S - stale

Network	Next Hop	In Label	Out Label
*>i 11.11.11.55/32	172.1.2.54	24320	24320
*>i 21.21.21.56/32	172.3.4.56	24321	24321

```
ABR2#show mpls forwarding-table | include 11.11.11.55
  B> 11.11.11.55/32      1      1      -      -      LSP_DEFAULT
24320      xe16      No      172.1.2.54
```

```
PE2#show ip bgp labeled-unicast
```

Status codes: s suppressed, d damped, h history, * valid, > best, i - internal, S - stale

Network	Next Hop	In Label	Out Label
*>i 11.11.11.55/32	172.3.4.53	24320	24320
*> 21.21.21.56/32	0.0.0.0	24321	-

```
PE2#show mpls forwarding-table | include 11.11.11.55
  B> 11.11.11.55/32      1      1      -      -      LSP_DEFAULT
24320      xe10      No      172.3.4.53
```

```
PE2#show mpls ftn-table
```

Primary FTN entry with FEC: 11.11.11.55/32, id: 1, row status: Active, Tunnel-Policy: N/A

Owner: BGP, distance: 0, Action-type: Redirect to LSP, Exp-bits: 0x0, Incoming DSCP: none

Tunnel id: 0, Protected LSP id: 0, Description: N/A, Color: 0

Cross connect ix: 1, in intf: - in label: 0 out-segment ix: 1

Owner: BGP, Persistent: No, Admin Status: Up, Oper Status: Up

Out-segment with ix: 1, owner: BGP, Stale: NO, out intf: xe10, out label: 24320

Nexthop addr: 172.3.4.53 cross connect ix: 1, op code: Push

```
PE2#show mpls vrf-table
```

Output for IPv4 VRF table with id: 2

Primary FTN entry with FEC: 172.10.20.0/24, id: 1, row status: Active, Tunnel-Policy: N/A

Owner: BGP, distance: 0, Action-type: Redirect to LSP, Exp-bits: 0x0, Incoming DSCP: none

Transport Tunnel id: 0, Protected LSP id: 0, Description: N/A, Color: 0

Cross connect ix: 3, in intf: - in label: 0 out-segment ix: 2

Owner: BGP, Persistent: No, Admin Status: Up, Oper Status: Up

Out-segment with ix: 2, owner: BGP, Stale: NO, BGP out intf: xe10, transport out intf: xe10, out label: 24321

Nexthop addr: 11.11.11.55 cross connect ix: 3, op code: Push and Lookup

```
PE2#show mpls ilm-table
```

Codes: > - installed ILM, * - selected ILM, p - stale ILM

K - CLI ILM, T - MPLS-TP, s - Stitched ILM

S - SNMP, L - LDP, R - RSVP, C - CRLDP

B - BGP, K - CLI, V - LDP_VC, I - IGP_SHORTCUT

O - OSPF/OSPF6 SR, i - ISIS SR, k - SR CLI

P - SR Policy, U - unknown

Code	FEC/VRF/L2CKT	ILM-ID	In-Label	Out-Label	In-Intf	Out-
Intf/VRF	Nexthop		LSP-Type			
B> 21.21.21.56/32		2	24321	NoLabel	N/A	N/A
127.0.0.1			LSP_DEFAULT			
B> 11.11.11.55/32		1	24320	24320	N/A	N/A
172.3.4.53			LSP_DEFAULT			

```

B> vrf1          3          24322      Nolabel   N/A      vrf1
N/A            LSP_DEFAULT

```

BGP Labeled Unicast with Seamless MPLS

Topology

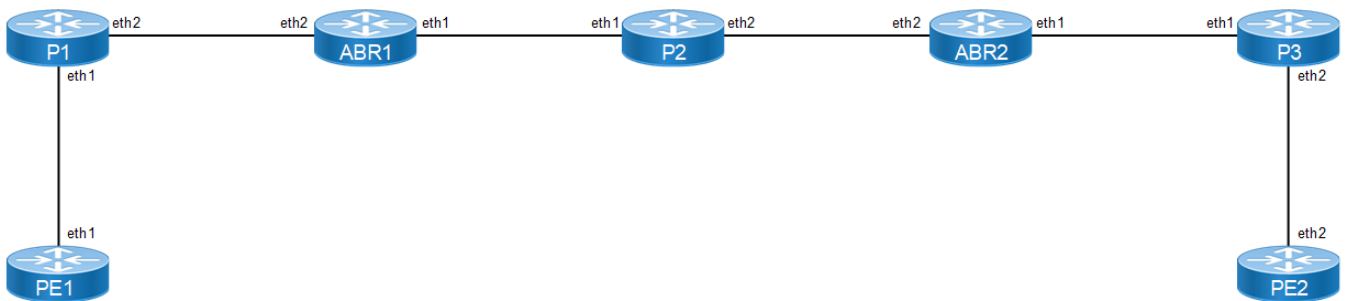

Figure 4-54: BGP_LU with MPLS

Configuration

PE1

#configure terminal	Enter the Configure mode.
(config)#interface lo	Enter interface mode
(config-if)#ip address 1.1.1.54/32 secondary	Configure the IP address of the interface loopback
(config-if)#exit	Exit interface mode
(config)#interface eth1	Enter interface mode
(config-if)#ip address 10.1.1.54/24	Configure the IP address of the interface eth1
(config-if)#label-switching	Enable label-switching on interface eth1
(config-if)# enable-ldp ipv4	Enable LDP process on eth1 interface
(config-if)#exit	Exit interface mode.
(config)#router ospf 10	Configure the routing process OSPF with process id 10
(config-router)#network 1.1.1.54/32 area 0	Define the interface (1.1.1.54/32) on which OSPF runs, and associate the area ID (0) with the interface (area ID 0 specifies the backbone area).
(config-router)#network 10.1.1.0/24 area 0	Define the interface (10.1.1.0/24) on which OSPF runs, and associate the area ID (0) with the interface (area ID 0 specifies the backbone area).
(config-router)#exit	Exit from router ospf mode
(config)#commit	Commit the candidate configuration to the running configuration.
(config)#router bgp 100	Enter Router BGP mode
(config-router)#neighbor 7.7.7.55 remote-as 100	Add loopback ip of PE2 as neighbor with neighbor AS

BGP Labeled Unicast

(config-router)#neighbor 7.7.7.55 update-source lo	Update the source for that particular neighbor as loopback interface
(config-router)#neighbor 3.3.3.52 remote-as 100	Add loopback ip of ABR1 as neighbor with neighbor AS
(config-router)#neighbor 3.3.3.52 update-source lo	Update the source for that particular neighbor as loopback interface
(config-router)#allocate-label all	Allocate labels
(config-router)#address-family ipv4 labeled-unicast	Enter into labeled-unicast address family
(config-router-af)#neighbor 3.3.3.52 activate	Activate the neighbor inside labeled-unicast address family
(config-router-af)#exit-address-family	Exit from address family IPv4 labeled unicast
(config-router)#address-family vpv4 unicast	Enter into vpv4 unicast address family
(config-router-af)#neighbor 7.7.7.55 activate	Activate the neighbor inside vpv4 address family
(config-router)#address-family ipv4 labeled-unicast	Enter into labeled-unicast address family
(config-router)#address-family ipv4 unicast	Enter into ipv4 unicast address family
(config-router-af)#network 1.1.1.54/32	Advertise the loopback of RTR1 in BGP
(config-router-af)#exit-address-family	Exit from address family
(config-router)#exit	Exit from router BGP mode
(config)# router ldp	Configure Router LDP instance
(config-router)# transport-address ipv4 1.1.1.54 0	Configure Transport address for LDP with label space value 0
(config-router)#exit	Exit from router mode
(config)#commit	Commit the candidate configuration to the running configuration.
(config)# ip vrf vrf1	Specify the name of the VRF (vrf1) to be created.
(config-vrf)#rd 10:100	Assign a route distinguisher (RD) for the VRF, which is a unique value on the router. The RD value can be in ASN:NN or A.B.C.D:NN format.
(config-vrf)#route-target both 100:300	Specify the 2-Octet AS specific or IPv4 specific Transitive Route-Target extended community attribute.
(config-vrf)#exit	Exit VRF mode, and return to Configure mode.
(config)#interface eth2	Enter interface mode
(config-if)# ip vrf forwarding vrf1	Bind the interface (eth2) to the VRF vrf1
(config-if)# ip address 61.1.1.54/24	Configure the IP address of the interface eth2
(config-if)#exit	Exit interface mode.
(config)#router bgp 100	Enter Router BGP mode
(config-router)# address-family ipv4 vrf vrf1	Enter address family ipv4 vrf mode
(config-router-af)# redistribute connected	Redistribute connected routes
(config-router-af)# exit-address-family	Exit address-family mode.
(config-router)#commit	Commit the candidate configuration to the running configuration.

P1

#configure terminal	Enter the Configure mode.
(config)#interface lo	Enter interface mode
(config-if)#ip address 2.2.2.23/32	Configure the IP address of the interface loopback
(config-if)#exit	Exit interface mode
(config)#interface eth1	Enter interface mode
(config-if)#ip address 10.1.1.23/24	Configure the IP address of the interface eth1
(config-if)#label-switching	Enable label-switching on interface eth1
(config-if)# enable-ldp ipv4	Enable LDP process on eth1 interface
(config-if)#exit	Exit interface mode.
(config)#interface eth2	Enter interface mode
(config-if)#ip address 20.1.1.23/24	Configure the IP address of the interface eth2
(config-if)#label-switching	Enable label-switching on interface eth2
(config-if)# enable-ldp ipv4	Enable LDP process on eth2 interface
(config-if)#exit	Exit interface mode.
(config)#router ospf 10	Configure the routing process OSPF with process id 10
(config-router)#network 20.1.1.0/24 area 0	Define the interface (20.1.1.0/24) on which OSPF runs, and associate the area ID (0) with the interface (area ID 0 specifies the backbone area).
(config-router)#network 10.1.1.0/24 area 0	Define the interface (10.1.1.0/24) on which OSPF runs, and associate the area ID (0) with the interface (area ID 0 specifies the backbone area).
(config-router)#network 2.2.2.23/32 area 0	Define the interface (2.2.2.23/32) on which OSPF runs, and associate the area ID (0) with the interface (area ID 0 specifies the backbone area).
(config-router)#exit	Exit from router ospf mode
(config)# router ldp	Configure Router LDP instance
(config-router)# transport-address ipv4 2.2.2.23 0	Configure Transport address for LDP with label space value 0
(config-router)#exit	Exit from router mode
(config)# ip route 7.7.7.55/32 20.1.1.52	Specify the destination prefix and mask for the network and a gateway.
(config)#commit	Commit the candidate configuration to the running configuration.

ABR1

#configure terminal	Enter the Configure mode.
(config)#interface lo	Enter interface mode
(config-if)#ip address 3.3.3.52/32	Configure the IP address of the interface loopback
(config-if)#exit	Exit interface mode
(config)#interface eth1	Enter interface mode
(config-if)#ip address 30.1.1.52/24	Configure the IP address of the interface eth1

BGP Labeled Unicast

(config-if)#label-switching	Enable label-switching on interface eth1
(config-if)# enable-ldp ipv4	Enable LDP process on eth1 interface
(config-if)#exit	Exit interface mode.
(config)#interface eth2	Enter interface mode
(config-if)#ip address 20.1.1.52/24	Configure the IP address of the interface eth2
(config-if)#label-switching	Enable label-switching on interface eth2
(config-if)# enable-ldp ipv4	Enable LDP process on eth2 interface
(config-if)#exit	Exit interface mode.
(config)#commit	Commit the candidate configuration to the running configuration.
(config)#router ospf 20	Configure the routing process OSPF with process id 20
(config-router)#network 3.3.3.52/32 area 0	Define the interface (3.3.3.52/32) on which OSPF runs, and associate the area ID (0) with the interface (area ID 0 specifies the backbone area).
(config-router)#network 20.1.1.0/24 area 0	Define the interface (20.1.1.0/24) on which OSPF runs, and associate the area ID (0) with the interface (area ID 0 specifies the backbone area).
(config-router)#exit	Exit from router ospf mode
(config)# router ldp	Configure Router LDP instance
(config-router)# transport-address ipv4 3.3.3.52 0	Configure Transport address for LDP with label space value 0
(config-router)#exit	Exit from router mode
(config)#commit	Commit the candidate configuration to the running configuration.
(config)#router bgp 100	Enter Router BGP mode
(config-router)#neighbor 1.1.1.54 remote-as 100	Add loopback ip of PE2 as neighbor with neighbor AS
(config-router)#neighbor 1.1.1.54 update-source lo	Update the source for that particular neighbor as loopback interface
(config-router)#neighbor 5.5.5.56 remote-as 100	Add loopback ip of ABR1 as neighbor with neighbor AS
(config-router)#neighbor 5.5.5.56 update-source lo	Update the source for that particular neighbor as loopback interface
(config-router)#allocate-label all	Allocate labels
(config-router)#address-family ipv4 labeled-unicast	Enter into labeled-unicast address family
(config-router-af)#neighbor 1.1.1.54 activate	Activate the neighbor inside labeled-unicast address family
(config-router-af)#neighbor 5.5.5.56 activate	Activate the neighbor inside labeled-unicast address family
(config-router-af)# neighbor 1.1.1.54 route-reflector-client	Enable Route reflector client for the neighbor inside address family IPv4 labeled unicast
(config-router-af)# neighbor 5.5.5.56 route-reflector-client	Enable Route reflector client for the neighbor inside address family IPv4 labeled unicast
(config-router-af)# neighbor 1.1.1.54 next-hop-self	Enable next hop self for the particular neighbor inside address family IPv4 labeled unicast

(config-router-af)# neighbor 5.5.5.56 next-hop-self	Enable next hop self for the particular neighbor inside address family IPv4 labeled unicast
(config-router-af)#exit-address-family	Exit from address family labeled-unicast
(config)#commit	Commit the candidate configuration to the running configuration.

P2

#configure terminal	Enter the Configure mode.
(config)#interface lo	Enter interface mode
(config-if)#ip address 4.4.4.53/32	Configure the IP address of the interface loopback
(config-if)#exit	Exit interface mode
(config)#interface eth1	Enter interface mode
(config-if)#ip address 30.1.1.53/24	Configure the IP address of the interface eth1
(config-if)#label-switching	Enable label-switching on interface eth1
(config-if)# enable-ldp ipv4	Enable LDP process on eth1 interface
(config-if)#exit	Exit interface mode.
(config)#interface eth2	Enter interface mode
(config-if)#ip address 40.1.1.53/24	Configure the IP address of the interface eth2
(config-if)#label-switching	Enable label-switching on interface eth2
(config-if)# enable-ldp ipv4	Enable LDP process on eth2 interface
(config-if)#exit	Exit interface mode
(config)#commit	Commit the candidate configuration to the running configuration.
(config)#router ospf 20	Configure the routing process OSPF with process id 20
(config-router)#network 30.1.1.0/24 area 0	Define the interface (30.1.1.0/24) on which OSPF runs, and associate the area ID (0) with the interface (area ID 0 specifies the backbone area).
(config-router)#network 40.1.1.0/24 area 0	Define the interface (40.1.1.0/24) on which OSPF runs, and associate the area ID (0) with the interface (area ID 0 specifies the backbone area).
(config-router)#network 4.4.4.53/32 area 0	Define the interface (4.4.4.53/32) on which OSPF runs, and associate the area ID (0) with the interface (area ID 0 specifies the backbone area).
(config-router)#exit	Exit from router ospf mode
(config)# router ldp	Configure Router LDP instance
(config-router)# transport-address ipv4 4.4.4.53 0	Configure Transport address for LDP with label space value 0
(config-router)#exit	Exit from router mode
(config)#commit	Commit the candidate configuration to the running configuration.

ABR2

#configure terminal	Enter the Configure mode.
(config)#interface lo	Enter interface mode
(config-if)#ip address 5.5.5.56/32	Configure the IP address of the interface loopback
(config-if)#exit	Exit interface mode
(config)#interface eth1	Enter interface mode
(config-if)#ip address 50.1.1.56/24	Configure the IP address of the interface eth1
(config-if)#label-switching	Enable label-switching on interface eth1
(config-if)# enable-ldp ipv4	Enable LDP process on eth1 interface
(config-if)#exit	Exit interface mode.
(config)#interface eth2	Enter interface mode
(config-if)#ip address 40.1.1.56/24	Configure the IP address of the interface eth2
(config-if)#label-switching	Enable label-switching on interface eth2
(config-if)# enable-ldp ipv4	Enable LDP process on eth2 interface
(config-if)#exit	Exit interface mode.
(config)#commit	Commit the candidate configuration to the running configuration.
(config)#router ospf 30	Configure the routing process OSPF with process id 20
(config-router)#network 5.5.5.56/32 area 0	Define the interface 5.5.5.56/32 on which OSPF runs, and associate the area ID (0) with the interface (area ID 0 specifies the backbone area).
(config-router)#network 50.1.1.0/24 area 0	Define the interface (50.1.1.0/24) on which OSPF runs, and associate the area ID (0) with the interface (area ID 0 specifies the backbone area).
(config-router)#exit	Exit from router ospf mode
(config)#commit	Commit the candidate configuration to the running configuration.
(config)#router ospf 20	Configure the routing process OSPF with process id 20
(config-router)#network 5.5.5.56/32 area 0	Define the interface 5.5.5.56/32 on which OSPF runs, and associate the area ID (0) with the interface (area ID 0 specifies the backbone area).
(config-router)#network 40.1.1.0/24 area 0	Define the interface (40.1.1.0/24) on which OSPF runs, and associate the area ID (0) with the interface (area ID 0 specifies the backbone area).
(config-router)#exit	Exit from router ospf mode
(config)# router ldp	Configure Router LDP instance
(config-router)# transport-address ipv4 3.3.3.52 0	Configure Transport address for LDP with label space value 0
(config-router)#exit	Exit from router mode
(config)#commit	Commit the candidate configuration to the running configuration.
(config)#router bgp 100	Enter Router BGP mode
(config-router)#neighbor 3.3.3.52 remote-as 100	Add loopback ip of PE2 as neighbor with neighbor AS

(config-router)#neighbor 3.3.3.52 update-source lo	Update the source for that particular neighbor as loopback interface
(config-router)#neighbor 7.7.7.55 remote-as 100	Add loopback ip of ABR1 as neighbor with neighbor AS
(config-router)#neighbor 7.7.7.55 update-source lo	Update the source for that particular neighbor as loopback interface
(config-router)#address-family ipv4 labeled-unicast	Enter into labeled-unicast address family
(config-router-af)#neighbor 3.3.3.52 activate	Activate the neighbor inside labeled-unicast address family
(config-router-af)#neighbor 7.7.7.55 activate	Activate the neighbor inside labeled-unicast address family
(config-router-af)# neighbor 3.3.3.52 route-reflector-client	Enable Route reflector client for the neighbor inside address family IPv4 labeled unicast
(config-router-af)# neighbor 7.7.7.55 route-reflector-client	Enable Route reflector client for the neighbor inside address family IPv4 labeled unicast
(config-router-af)# neighbor 3.3.3.52 next-hop-self	Enable next hop self for the particular neighbor inside address family IPv4 labeled unicast
(config-router-af)# neighbor 7.7.7.55 next-hop-self	Enable next hop self for the particular neighbor inside address family IPv4 labeled unicast
(config-router-af)#exit-address-family	Exit from address family labeled-unicast
(config-router)#exit	Exit from router BGP mode
(config)#commit	Commit the candidate configuration to the running configuration.

P3

#configure terminal	Enter the Configure mode.
(config)#interface lo	Enter interface mode
(config-if)#ip address 6.6.6.22/32	Configure the IP address of the interface loopback
(config-if)#exit	Exit interface mode
(config)#interface eth1	Enter interface mode
(config-if)#ip address 50.1.1.22/24	Configure the IP address of the interface eth1
(config-if)#label-switching	Enable label-switching on interface eth1
(config-if)# enable-ldp ipv4	Enable LDP process on eth1 interface
(config-if)#exit	Exit interface mode.
(config)#interface eth2	Enter interface mode
(config-if)#ip address 60.1.1.22/24	Configure the IP address of the interface eth2
(config-if)#label-switching	Enable label-switching on interface eth2
(config-if)# enable-ldp ipv4	Enable LDP process on eth2 interface
(config-if)#exit	Exit interface mode
(config)#commit	Commit the candidate configuration to the running configuration.
(config)#router ospf 30	Configure the routing process OSPF with process id 20
(config-router)#network 50.1.1.0/24 area 0	Define the interface (30.1.1.0/24) on which OSPF runs, and associate the area ID (0) with the interface (area ID 0 specifies the backbone area).

BGP Labeled Unicast

(config-router)#network 60.1.1.0/24 area 0	Define the interface (40.1.1.0/24) on which OSPF runs, and associate the area ID (0) with the interface (area ID 0 specifies the backbone area).
(config-router)#network 6.6.6.22/32 area 0	Define the interface (4.4.4.53/32) on which OSPF runs, and associate the area ID (0) with the interface (area ID 0 specifies the backbone area).
(config-router)#exit	Exit from router ospf mode
(config)#commit	Commit the candidate configuration to the running configuration.
(config)# router ldp	Configure Router LDP instance
(config-router)# transport-address ipv4 6.6.6.22 0	Configure Transport address for LDP with label space value 0
(config-router)#exit	Exit from router mode
(config)# ip route 1.1.1.54/32 50.1.1.56	Specify the destination prefix and mask for the network and a gateway.
(config)#exit	Exit from config mode
(config)#commit	Commit the candidate configuration to the running configuration.

PE2

#configure terminal	Enter the Configure mode.
(config)#interface lo	Enter interface mode
(config-if)#ip address 7.7.7.55/32 secondary	Configure the IP address of the interface loopback
(config-if)#exit	Exit interface mode
(config)#interface eth2	Enter interface mode
(config-if)#ip address 60.1.1.55/24	Configure the IP address of the interface eth1
(config-if)#label-switching	Enable label-switching on interface eth1
(config-if)# enable-ldp ipv4	Enable LDP process on eth1 interface
(config-if)#exit	Exit interface mode.
(config)#commit	Commit the candidate configuration to the running configuration.
(config)#router ospf 30	Configure the routing process OSPF with process id 10
(config-router)#network 7.7.7.55/32 area 0	Define the interface (7.7.7.55/32) on which OSPF runs, and associate the area ID (0) with the interface (area ID 0 specifies the backbone area).
(config-router)#network 60.1.1.0/24 area 0	Define the interface (60.1.1.0/24) on which OSPF runs, and associate the area ID (0) with the interface (area ID 0 specifies the backbone area).
(config-router)#exit	Exit from router ospf mode
(config)#commit	Commit the candidate configuration to the running configuration.
(config)#router bgp 100	Enter Router BGP mode
(config-router)#neighbor 1.1.1.54 remote-as 100	Add loopback ip of PE2 as neighbor with neighbor AS

(config-router)#neighbor 1.1.1.54 update-source lo	Update the source for that particular neighbor as loopback interface
(config-router)#neighbor 5.5.5.56 remote-as 100	Add loopback ip of ABR1 as neighbor with neighbor AS
(config-router)#neighbor 5.5.5.56 update-source lo	Update the source for that particular neighbor as loopback interface
(config-router)#allocate-label all	Allocate labels
(config-router)#address-family ipv4 labeled-unicast	Enter into labeled-unicast address family
(config-router-af)#neighbor 5.5.5.56 activate	Activate the neighbor inside labeled-unicast address family
(config-router-af)#exit-address-family	Exit from address family IPv4 labeled unicast
(config-router)#address-family vpv4 unicast	Enter into vpv4 unicast address family
(config-router-af)#neighbor 1.1.1.54 activate	Activate the neighbor inside vpv4 address family
(config-router-af)#exit-address-family	Exit from address family vpv4
(config-router)#address-family ipv4 unicast	Enter into ipv4 unicast address family
(config-router-af)#network 7.7.7.55/32	Advertise the loopback of RTR1 in BGP
(config-router-af)#exit-address-family	Exit from address family
(config-router)#exit	Exit from router BGP mode
(config)#commit	Commit the candidate configuration to the running configuration.
(config)# router ldp	Configure Router LDP instance
(config-router)# transport-address ipv4 7.7.7.55 0	Configure Transport address for LDP with label space value 0
(config-router)#exit	Exit from router mode
(config)# ip vrf vrf1	Specify the name of the VRF (vrf1) to be created.
(config-vrf)#rd 10:100	Assign a route distinguisher (RD) for the VRF, which is a unique value on the router. The RD value can be in ASN:NN or A.B.C.D:NN format.
(config-vrf)#route-target both 100:300	Specify the 2-Octet AS specific or IPv4 specific Transitive Route-Target extended community attribute.
(config-vrf)#exit	Exit VRF mode, and return to Configure mode.
(config)#interface eth2	Enter interface mode
(config-if)# ip vrf forwarding vrf1	Bind the interface (eth2) to the VRF vrf1
(config-if)# ip address 62.1.1.55/24	Configure the IP address of the interface eth2
(config-if)#exit	Exit interface mode.
(config)#commit	Commit the candidate configuration to the running configuration.
(config)#router bgp 100	Enter Router BGP mode
(config-router)# address-family ipv4 vrf vrf1	Enter address family ipv4 vrf mode
(config-router-af)# redistribute connected	Redistribute connected routes
(config-router-af)# exit-address-family	Exit address-family mode.
(config-router)#commit	Commit the candidate configuration to the running configuration.

Validation

PE1

```
#show ip bgp neighbors 3.3.3.52
BGP neighbor is 3.3.3.52, remote AS 100, local AS 100, internal link
  BGP version 4, local router ID 1.1.1.54, remote router ID 3.3.3.52
  BGP state = Established, up for 00:00:06
  Last read 00:00:07, hold time is 90, keepalive interval is 30 seconds
Neighbor capabilities:
  Route refresh: advertised and received (old and new)
  Received 4 messages, 1 notifications, 0 in queue
  Sent 6 messages, 0 notifications, 0 in queue Route refresh request: received
0, sent 0
  Minimum time between advertisement runs is 5 seconds Update source is lo
  For address family: IPv4 Unicast
  BGP table version 1, neighbor version 1 Index 0, Offset 0, Mask 0x1
  Community attribute sent to this neighbor (both)
  0accepted prefixes
  1announced prefixes

For address family: IPv4 Labeled-Unicast
BGP table version 1, neighbor version 1
Index 1, Offset 0, Mask 0x2
Community attribute sent to this neighbor (both)
0accepted prefixes
1announced prefixes

Connections established 2; dropped 1
Local host: 1.1.1.54, Local port: 179
Foreign host: 3.3.3.52, Foreign port: 46745
Nexthop: 1.1.1.54
Nexthop global: 54::54 Nexthop local: ::
BGP connection: non shared network
Last Reset: 00:00:11, due to BGP Notification received Notification Error
Message: (Cease/Other Configuration Change.)

#show ip bgp neighbors 7.7.7.55
BGP neighbor is 7.7.7.55, remote AS 100, local AS 100, internal link
BGP version 4, local router ID 1.1.1.54, remote router ID 7.7.7.55
BGP state = Established, up for 00:01:10
Last read 00:00:11, hold time is 90, keepalive interval is 30 seconds Neighbor
capabilities:
Route refresh: advertised and received (old and new)
Received 8 messages, 1 notifications, 0 in queue
Sent 9 messages, 2 notifications, 0 in queue Route refresh request: received
0, sent 0
Minimum time between advertisement runs is 5 seconds Update source is lo
For address family: VPNv4 Unicast
BGP table version 3, neighbor version 3 Index 0, Offset 0, Mask 0x1
Community attribute sent to this neighbor (both)
1 accepted prefixes
1 announced prefixes

Connections established 3; dropped 2
Local host: 1.1.1.54, Local port: 179
```

```
Foreign host: 7.7.7.55, Foreign port: 58871
Nexthop: 1.1.1.54
Nexthop global: 54::54 Nexthop local: ::
BGP connection: non shared network
Last Reset: 00:01:10, due to BGP Notification sent Notification Error Message:
(Cease/Administratively Reset.)
```

```
#show mpls vrf-table
Output for IPv4 VRF table with id: 2
Primary FTN entry with FEC: 62.1.1.0/24, id: 1, row status: Active
Owner: BGP, Action-type: Redirect to LSP, Exp-bits: 0x0, Incoming DSCP: none
Tunnel id: 0, Protected LSP id: 0, Description: N/A
Cross connect ix: 12, in intf: - in label: 0 out-segment ix: 11 Owner: BGP,
Persistent: No, Admin Status: Up, Oper Status: Up
Out-segment with ix: 11, owner: BGP, out intf: eth1, out label: 24961 Nexthop
addr: 7.7.7.55cross connect ix: 12, op code: Push and
Lookup
```

```
#show ip bgp labeled-unicast
```

```
Status codes: s suppressed, d damped, h history, * valid, > best, i -
internal, S - stale
```

```
NetworkNext HopIn LabelOut Label
```

```
*>1.1.1.54/320.0.0.024961-
```

```
*>i 7.7.7.55/323.3.3.52-24961
```

```
#show mpls forwarding-table | include 7.7.7.55
```

```
B>7.7.7.55/3240YesLSP_DEFAULT24961
```

```
eth13.3.3.52
```

```
#show mpls ilm-table
```

```
Codes: > - installed ILM, * - selected ILM, p - stale ILM K - CLI ILM, T -
MPLS-TP, S - Stitched ILM
```

```
CodeFECILM-IDIn-LabelOut-LabelIn-IntfOut- IntfNexthopLSP-Type
```

```
>1.1.1.54/321124961N/AN/AN/A
```

```
127.0.0.1LSP_DEFAULT
```

```
>61.1.1.0/241324963N/AN/Aeth2
```

```
0.0.0.0LSP_DEFAULT
```

```
#show mpls ftn-table
```

```
Primary FTN entry with FEC: 2.2.2.23/32, id: 1, row status: Active
```

```
Owner: LDP, Action-type: Redirect to LSP, Exp-bits: 0x0, Incoming DSCP: none
```

```
Tunnel id: 0, Protected LSP id: 0, Description: N/A
```

```
Cross connect ix: 1, in intf: - in label: 0 out-segment ix: 1 Owner: LDP,
```

```
Persistent: No, Admin Status: Up, Oper Status: Up
```

```
Out-segment with ix: 1, owner: LDP, out intf: eth1, out label: 3 Nexthop addr:
```

```
10.1.1.23cross connect ix: 1, op code: Push
```

```
Primary FTN entry with FEC: 3.3.3.52/32, id: 2, row status: Active
```

```
Owner: LDP, Action-type: Redirect to LSP, Exp-bits: 0x0, Incoming DSCP: none
```

```
Tunnel id: 0, Protected LSP id: 0, Description: N/A
```

```
Cross connect ix: 2, in intf: - in label: 0 out-segment ix: 2 Owner: LDP,
```

```
Persistent: No, Admin Status: Up, Oper Status: Up
```

```
Out-segment with ix: 2, owner: LDP, out intf: eth1, out label: 24320
```

```
Nexthop addr: 10.1.1.23cross connect ix: 2, op code: Push
```

Primary FTN entry with FEC: 7.7.7.55/32, id: 4, row status: Active
Owner: BGP, Action-type: Redirect to LSP, Exp-bits: 0x0, Incoming DSCP: none
Tunnel id: 0, Protected LSP id: 0, Description: N/A
Cross connect ix: 4, in intf: - in label: 0 out-segment ix: 3 Owner: BGP,
Persistent: No, Admin Status: Up, Oper Status: Up
Out-segment with ix: 3, owner: BGP, out intf: eth1, out label: 24961 Nexthop
addr: 3.3.3.52 cross connect ix: 4, op code: Push and
Lookup

Primary FTN entry with FEC: 20.1.1.0/24, id: 3, row status: Active
Owner: LDP, Action-type: Redirect to LSP, Exp-bits: 0x0, Incoming DSCP: none
Tunnel id: 0, Protected LSP id: 0, Description: N/A
Cross connect ix: 1, in intf: - in label: 0 out-segment ix: 1 Owner: LDP,
Persistent: No, Admin Status: Up, Oper Status: Up
Out-segment with ix: 1, owner: LDP, out intf: eth1, out label: 3 Nexthop addr:
10.1.1.23 cross connect ix: 1, op code: Push

P1

#show ip ospf neighbor

Total number of full neighbors: 2

OSPF process 10 VRF(default):

Neighbor ID Instance ID	Pri	State	Dead Time	Address	Interface
1.1.1.54 0	1	Full/Backup	00:00:38	10.1.1.54	eth1
3.3.3.52 0	1	Full/DR	00:00:39	20.1.1.52	eth2

#show ldp session

Peer IP Address	IF Name	My Role	State	KeepAlive	UpTime
1.1.1.54	eth1	Active	OPERATIONAL	30	00:00:21
3.3.3.52	eth2	Passive	OPERATIONAL	30	00:00:15

ABR1

#show ip bgp neighbors 1.1.1.54

BGP neighbor is 1.1.1.54, remote AS 100, local AS 100, internal link BGP
version 4, local router ID 3.3.3.52, remote router ID 1.1.1.54 BGP state =
Established, up for 00:00:09

Last read 00:00:05, hold time is 90, keepalive interval is 30 seconds Neighbor
capabilities:

Route refresh: advertised and received (old and new) Address family IPv4

Unicast: advertised and received Address family IPv4 Labeled-Unicast:
advertised and received

Received 5 messages, 0 notifications, 0 in queue

Sent 4 messages, 1 notifications, 0 in queue Route refresh request: received
0, sent 0

Minimum time between advertisement runs is 5 seconds Update source is lo

For address family: IPv4 Unicast

BGP table version 1, neighbor version 1 Index 0, Offset 0, Mask 0x1

Community attribute sent to this neighbor (both)

1 accepted prefixes

0 announced prefixes

```

For address family: IPv4 Labeled-UnicastBGP table version 2, neighbor version
2 Index 0, Offset 0, Mask 0x1
Route-Reflector Client NEXT_HOP is always this router
Community attribute sent to this neighbor (both)
1accepted prefixes
0announced prefixes

Connections established 2; dropped 1
Local host: 3.3.3.52, Local port: 46745
Foreign host: 1.1.1.54, Foreign port: 179
Nexthop: 3.3.3.52
Nexthop global: 52::52 Nexthop local: ::
BGP connection: non shared network
Last Reset: 00:00:14, due to BGP Notification sent Notification Error Message:
(Cease/Other Configuration Change.)

```

```

#show ip bgp neighbors 5.5.5.56
BGP neighbor is 5.5.5.56, remote AS 100, local AS 100, internal link BGP
version 4, local router ID 3.3.3.52, remote router ID 5.5.5.56 BGP state =
Established, up for 00:00:11
Last read 00:00:02, hold time is 90, keepalive interval is 30 seconds Neighbor
capabilities:
Route refresh: advertised and received (old and new) Address family IPv4
Unicast: advertised and received Address family IPv4 Labeled-Unicast:
advertised and received
Received 4 messages, 0 notifications, 0 in queue
Sent 6 messages, 2 notifications, 0 in queue Route refresh request: received
0, sent 0
Minimum time between advertisement runs is 5 seconds Update source is lo
For address family: IPv4 Unicast
BGP table version 1, neighbor version 1 Index 1, Offset 0, Mask 0x2
Community attribute sent to this neighbor (both)
1 accepted prefixes
1 announced prefixes

```

```

For address family: IPv4 Labeled-UnicastBGP table version 3, neighbor version
2 Index 1, Offset 0, Mask 0x2
Route-Reflector Client NEXT_HOP is always this router
Community attribute sent to this neighbor (both)
1 accepted prefixes
1 announced prefixes

```

```

Connections established 2; dropped 1
Local host: 3.3.3.52, Local port: 179
Foreign host: 5.5.5.56, Foreign port: 40440
Nexthop: 3.3.3.52
Nexthop global: 52::52 Nexthop local: ::

```

```

BGP connection: non shared network
Last Reset: 00:00:11, due to BGP Notification sent Notification Error Message:
(Cease/Administratively Reset.)

```

```

#show ip bgp labeled-unicast

```

```

Status codes: s suppressed, d damped, h history, * valid, > best, i -
internal, S - stale

```

Network	Next Hop	In Label	Out Label
*>i 1.1.1.54/32	1.1.1.54	24960	24961

```
*>i 7.7.7.55/32      5.5.5.56      24961      24961

#show mpls forwarding-table | include 1.1.1.54
  L> 1.1.1.54/32      1      0      Yes  LSP_DEFAULT      24321
eth2      20.1.1.23
  B 1.1.1.54/32      7      0      Yes  LSP_DEFAULT      24961
eth2      1.1.1.54

#show mpls forwarding-table | include 7.7.7.55
  B> 7.7.7.55/32      8      0      Yes  LSP_DEFAULT      24961
eth1      5.5.5.56

#show mpls ftn-table
Primary FTN entry with FEC: 1.1.1.54/32, id: 1, row status: Active
Owner: LDP, Action-type: Redirect to LSP, Exp-bits: 0x0, Incoming DSCP: none
Tunnel id: 0, Protected LSP id: 0, Description: N/A
Cross connect ix: 2, in intf: - in label: 0 out-segment ix: 2
Owner: LDP, Persistent: No, Admin Status: Up, Oper Status: Up
Out-segment with ix: 2, owner: LDP, out intf: eth2, out label: 24321
Nexthop addr: 20.1.1.23      cross connect ix: 2, op code: Push

Primary FTN entry with FEC: 1.1.1.54/32, id: 7, row status: Active
Owner: BGP, Action-type: Redirect to LSP, Exp-bits: 0x0, Incoming DSCP: none
Tunnel id: 0, Protected LSP id: 0, Description: N/A
Cross connect ix: 11, in intf: - in label: 0 out-segment ix: 10
Owner: BGP, Persistent: No, Admin Status: Down, Oper Status: Down
Out-segment with ix: 10, owner: BGP, out intf: eth2, out label: 24961
Nexthop addr: 1.1.1.54      cross connect ix: 11, op code: Push and
Lookup

Primary FTN entry with FEC: 2.2.2.23/32, id: 2, row status: Active
Owner: LDP, Action-type: Redirect to LSP, Exp-bits: 0x0, Incoming DSCP: none
Tunnel id: 0, Protected LSP id: 0, Description: N/A
Cross connect ix: 5, in intf: - in label: 0 out-segment ix: 4
Owner: LDP, Persistent: No, Admin Status: Up, Oper Status: Up
Out-segment with ix: 4, owner: LDP, out intf: eth2, out label: 3
Nexthop addr: 20.1.1.23      cross connect ix: 5, op code: Push

Primary FTN entry with FEC: 4.4.4.53/32, id: 4, row status: Active
Owner: LDP, Action-type: Redirect to LSP, Exp-bits: 0x0, Incoming DSCP: none
Tunnel id: 0, Protected LSP id: 0, Description: N/A
Cross connect ix: 7, in intf: - in label: 0 out-segment ix: 6
Owner: LDP, Persistent: No, Admin Status: Up, Oper Status: Up
Out-segment with ix: 6, owner: LDP, out intf: eth1, out label: 3
Nexthop addr: 30.1.1.53      cross connect ix: 7, op code: Push

Primary FTN entry with FEC: 5.5.5.56/32, id: 5, row status: Active
Owner: LDP, Action-type: Redirect to LSP, Exp-bits: 0x0, Incoming DSCP: none
Tunnel id: 0, Protected LSP id: 0, Description: N/A
Cross connect ix: 10, in intf: - in label: 0 out-segment ix: 9
Owner: LDP, Persistent: No, Admin Status: Up, Oper Status: Up
Out-segment with ix: 9, owner: LDP, out intf: eth1, out label: 24320
Nexthop addr: 30.1.1.53      cross connect ix: 10, op code: Push
```

```

Primary FTN entry with FEC: 7.7.7.55/32, id: 8, row status: Active
Owner: BGP, Action-type: Redirect to LSP, Exp-bits: 0x0, Incoming DSCP: none
Tunnel id: 0, Protected LSP id: 0, Description: N/A
Cross connect ix: 12, in intf: - in label: 0 out-segment ix: 11
Owner: BGP, Persistent: No, Admin Status: Up, Oper Status: Up
Out-segment with ix: 11, owner: BGP, out intf: eth1, out label: 24961
Nexthop addr: 5.5.5.56 cross connect ix: 12, op code: Push and
Lookup

```

```

Primary FTN entry with FEC: 10.1.1.0/24, id: 3, row status: Active
Owner: LDP, Action-type: Redirect to LSP, Exp-bits: 0x0, Incoming DSCP: none
Tunnel id: 0, Protected LSP id: 0, Description: N/A
Cross connect ix: 5, in intf: - in label: 0 out-segment ix: 4
Owner: LDP, Persistent: No, Admin Status: Up, Oper Status: Up
Out-segment with ix: 4, owner: LDP, out intf: eth2, out label: 3
Nexthop addr: 20.1.1.23 cross connect ix: 5, op code: Push

```

```

Primary FTN entry with FEC: 40.1.1.0/24, id: 6, row status: Active
Owner: LDP, Action-type: Redirect to LSP, Exp-bits: 0x0, Incoming DSCP: none
Tunnel id: 0, Protected LSP id: 0, Description: N/A
Cross connect ix: 7, in intf: - in label: 0 out-segment ix: 6
Owner: LDP, Persistent: No, Admin Status: Up, Oper Status: Up
Out-segment with ix: 6, owner: LDP, out intf: eth1, out label: 3
Nexthop addr: 30.1.1.53 cross connect ix: 7, op code: Push

```

P2

```
#show ip ospf neighbor
```

```

Total number of full neighbors: 2 OSPF process 20 VRF(default):
Neighbor IDPriStateDead TimeAddressInterface Instance ID
3.3.3.521Full/Backup00:00:3930.1.1.52eth1
0
5.5.5.561Full/DR00:00:4040.1.1.56eth2
0

```

```
#show ldp session
```

```

Peer IP AddressIF NameMy RoleStateKeepAliveUpTime
3.3.3.52eth1ActiveOPERATIONAL3000:00:21
5.5.5.56eth2PassiveOPERATIONAL3000:00:19

```

ABR2

```
#show ip bgp neighbors 3.3.3.52
```

```

BGP neighbor is 3.3.3.52, remote AS 100, local AS 100, internal link BGP
version 4, local router ID 5.5.5.56, remote router ID 3.3.3.52 BGP state =
Established, up for 00:00:12
Last read 00:00:07, hold time is 90, keepalive interval is 30 seconds Neighbor
capabilities:
Route refresh: advertised and received (old and new) Address family IPv4
Unicast: advertised and received Address family IPv4 Labeled-Unicast:
advertised and received

```

```
Received 5 messages, 1 notifications, 0 in queue
Sent 5 messages, 0 notifications, 0 in queue Route refresh request: received
0, sent 0
Minimum time between advertisement runs is 5 seconds Update source is lo
For address family: IPv4 Unicast
BGP table version 1, neighbor version 1 Index 0, Offset 0, Mask 0x1
Community attribute sent to this neighbor (both)
1 accepted prefixes
1 announced prefixes

For address family: IPv4 Labeled-UnicastBGP table version 2, neighbor version
2 Index 0, Offset 0, Mask 0x1
Route-Reflector Client NEXT_HOP is always this router
Community attribute sent to this neighbor (both)
1 accepted prefixes
1 announced prefixes

Connections established 2; dropped 1
Local host: 5.5.5.56, Local port: 40440
Foreign host: 3.3.3.52, Foreign port: 179
Nexthop: 5.5.5.56
Nexthop global: 56::56 Nexthop local: ::
BGP connection: non shared network
Last Reset: 00:00:17, due to BGP Notification received Notification Error
Message: (Cease/Other Configuration Change.)

#show ip bgp neighbors 7.7.7.55
BGP neighbor is 7.7.7.55, remote AS 100, local AS 100, internal link BGP
version 4, local router ID 5.5.5.56, remote router ID 7.7.7.55 BGP state =
Established, up for 00:00:13
Last read 00:00:08, hold time is 90, keepalive interval is 30 seconds Neighbor
capabilities:
Route refresh: advertised and received (old and new) Address family IPv4
Unicast: advertised and received Address family IPv4 Labeled-Unicast:
advertised and received
Received 3 messages, 0 notifications, 0 in queue
Sent 4 messages, 0 notifications, 0 in queue Route refresh request: received
0, sent 0
Minimum time between advertisement runs is 5 seconds Update source is lo
For address family: IPv4 Unicast
BGP table version 1, neighbor version 1 Index 1, Offset 0, Mask 0x2
Community attribute sent to this neighbor (both)

1 accepted prefixes
1 announced prefixes

For address family: IPv4 Labeled-UnicastBGP table version 2, neighbor version
2 Index 1, Offset 0, Mask 0x2
Route-Reflector Client NEXT_HOP is always this router
Community attribute sent to this neighbor (both)
1 accepted prefixes
1 announced prefixes

Connections established 1; dropped 0
Local host: 5.5.5.56, Local port: 35004
Foreign host: 7.7.7.55, Foreign port: 179
Nexthop: 5.5.5.56
```

NextHop global: 56::56 NextHop local: ::
 BGP connection: non shared network

#show ip bgp labeled-unicast

Status codes: s suppressed, d damped, h history, * valid, > best, i -
 internal, S - stale

Network	Next Hop	In Label	Out Label
*>i 1.1.1.54/32	3.3.3.52	24960	24960
*>i 7.7.7.55/32	7.7.7.55	24961	24960

#show mpls forwarding-table | include 1.1.1.54

B>	1.1.1.54/32	7	0	Yes	LSP_DEFAULT	24960
eth2	3.3.3.52					

#show mpls forwarding-table | include 7.7.7.55

L>	7.7.7.55/32	5	0	Yes	LSP_DEFAULT	24320
eth1	50.1.1.22					
B	7.7.7.55/32	8	0	Yes	LSP_DEFAULT	24960
eth1	7.7.7.55					

#show mpls ftn-table

Primary FTN entry with FEC: 1.1.1.54/32, id: 7, row status: Active
 Owner: BGP, Action-type: Redirect to LSP, Exp-bits: 0x0, Incoming DSCP: none
 Tunnel id: 0, Protected LSP id: 0, Description: N/A
 Cross connect ix: 11, in intf: - in label: 0 out-segment ix: 10
 Owner: BGP, Persistent: No, Admin Status: Up, Oper Status: Up
 Out-segment with ix: 10, owner: BGP, out intf: eth2, out label: 24960
 NextHop addr: 3.3.3.52 cross connect ix: 11, op code: Push and
 Lookup

Primary FTN entry with FEC: 3.3.3.52/32, id: 1, row status: Active
 Owner: LDP, Action-type: Redirect to LSP, Exp-bits: 0x0, Incoming DSCP: none
 Tunnel id: 0, Protected LSP id: 0, Description: N/A
 Cross connect ix: 4, in intf: - in label: 0 out-segment ix: 3
 Owner: LDP, Persistent: No, Admin Status: Up, Oper Status: Up
 Out-segment with ix: 3, owner: LDP, out intf: eth2, out label: 24321
 NextHop addr: 40.1.1.53 cross connect ix: 4, op code: Push

Primary FTN entry with FEC: 4.4.4.53/32, id: 2, row status: Active
 Owner: LDP, Action-type: Redirect to LSP, Exp-bits: 0x0, Incoming DSCP: none
 Tunnel id: 0, Protected LSP id: 0, Description: N/A
 Cross connect ix: 5, in intf: - in label: 0 out-segment ix: 4
 Owner: LDP, Persistent: No, Admin Status: Up, Oper Status: Up
 Out-segment with ix: 4, owner: LDP, out intf: eth2, out label: 3
 NextHop addr: 40.1.1.53 cross connect ix: 5, op code: Push

Primary FTN entry with FEC: 6.6.6.22/32, id: 4, row status: Active
 Owner: LDP, Action-type: Redirect to LSP, Exp-bits: 0x0, Incoming DSCP: none
 Tunnel id: 0, Protected LSP id: 0, Description: N/A
 Cross connect ix: 7, in intf: - in label: 0 out-segment ix: 6
 Owner: LDP, Persistent: No, Admin Status: Up, Oper Status: Up
 Out-segment with ix: 6, owner: LDP, out intf: eth1, out label: 3
 NextHop addr: 50.1.1.22 cross connect ix: 7, op code: Push

Primary FTN entry with FEC: 7.7.7.55/32, id: 5, row status: Active
 Owner: LDP, Action-type: Redirect to LSP, Exp-bits: 0x0, Incoming DSCP: none
 Tunnel id: 0, Protected LSP id: 0, Description: N/A
 Cross connect ix: 10, in intf: - in label: 0 out-segment ix: 9
 Owner: LDP, Persistent: No, Admin Status: Up, Oper Status: Up
 Out-segment with ix: 9, owner: LDP, out intf: eth1, out label: 24320
 Nexthop addr: 50.1.1.22 cross connect ix: 10, op code: Push

Primary FTN entry with FEC: 7.7.7.55/32, id: 8, row status: Active
 Owner: BGP, Action-type: Redirect to LSP, Exp-bits: 0x0, Incoming DSCP: none
 Tunnel id: 0, Protected LSP id: 0, Description: N/A
 Cross connect ix: 12, in intf: - in label: 0 out-segment ix: 11
 Owner: BGP, Persistent: No, Admin Status: Down, Oper Status: Down
 Out-segment with ix: 11, owner: BGP, out intf: eth1, out label: 24960
 Nexthop addr: 7.7.7.55 cross connect ix: 12, op code: Push and
 Lookup

Primary FTN entry with FEC: 30.1.1.0/24, id: 3, row status: Active
 Owner: LDP, Action-type: Redirect to LSP, Exp-bits: 0x0, Incoming DSCP: none
 Tunnel id: 0, Protected LSP id: 0, Description: N/A
 Cross connect ix: 5, in intf: - in label: 0 out-segment ix: 4
 Owner: LDP, Persistent: No, Admin Status: Up, Oper Status: Up
 Out-segment with ix: 4, owner: LDP, out intf: eth2, out label: 3
 Nexthop addr: 40.1.1.53 cross connect ix: 5, op code: Push

Primary FTN entry with FEC: 60.1.1.0/24, id: 6, row status: Active
 Owner: LDP, Action-type: Redirect to LSP, Exp-bits: 0x0, Incoming DSCP: none
 Tunnel id: 0, Protected LSP id: 0, Description: N/A
 Cross connect ix: 7, in intf: - in label: 0 out-segment ix: 6
 Owner: LDP, Persistent: No, Admin Status: Up, Oper Status: Up
 Out-segment with ix: 6, owner: LDP, out intf: eth1, out label: 3
 Nexthop addr: 50.1.1.22 cross connect ix: 7, op code: Push

P3

#show ip ospf neighbor

Total number of full neighbors: 2

OSPF process 30 VRF(default):

Neighbor ID Instance ID	Pri	State	Dead Time	Address	Interface
5.5.5.56 0	1	Full/Backup	00:00:39	50.1.1.56	eth1
7.7.7.55 0	1	Full/DR	00:00:39	60.1.1.55	eth2

#show ldp session

Peer IP Address	IF Name	My Role	State	KeepAlive	UpTime
5.5.5.56	eth1	Active	OPERATIONAL	30	00:00:30
7.7.7.55	eth2	Passive	OPERATIONAL	30	00:00:28

PE2

#show ip bgp neighbors 5.5.5.56

```

BGP neighbor is 5.5.5.56, remote AS 100, local AS 100, internal link BGP
version 4, local router ID 7.7.7.55, remote router ID 5.5.5.56 BGP state =
Established, up for 00:00:16
Last read 00:00:11, hold time is 90, keepalive interval is 30 seconds Neighbor
capabilities:
Route refresh: advertised and received (old and new) Address family IPv4
Unicast: advertised and received Address family IPv4 Labeled-Unicast:
advertised and received
Received 3 messages, 0 notifications, 0 in queue
Sent 4 messages, 0 notifications, 0 in queue Route refresh request: received
0, sent 0
Minimum time between advertisement runs is 5 seconds Update source is lo
For address family: IPv4 Unicast
BGP table version 1, neighbor version 1 Index 1, Offset 0, Mask 0x2
Community attribute sent to this neighbor (both)
1 accepted prefixes
1 announced prefixes

For address family: IPv4 Labeled-UnicastBGP table version 2, neighbor version
2 Index 1, Offset 0, Mask 0x2
Community attribute sent to this neighbor (both)
1 accepted prefixes
1 announced prefixes

Connections established 1; dropped 0
Local host: 7.7.7.55, Local port: 179
Foreign host: 5.5.5.56, Foreign port: 35004
Nexthop: 7.7.7.55
Nexthop global: 55::55 Nexthop local: ::
BGP connection: non shared network

#show mpls vrf-table
Output for IPv4 VRF table with id: 2
Primary FTN entry with FEC: 61.1.1.0/24, id: 1, row status: Active
Owner: BGP, Action-type: Redirect to LSP, Exp-bits: 0x0, Incoming DSCP: none
Tunnel id: 0, Protected LSP id: 0, Description: N/A
Cross connect ix: 11, in intf: - in label: 0 out-segment ix: 10

Owner: BGP, Persistent: No, Admin Status: Up, Oper Status: Up
Out-segment with ix: 10, owner: BGP, out intf: eth2, out label: 24963 Nexthop
addr: 1.1.1.54cross connect ix: 11, op code: Push and
Lookup

#show ip bgp labeled-unicast

Status codes: s suppressed, d damped, h history, * valid, > best, i -
internal, S - stale
NetworkNext HopIn LabelOut Label
*>i 1.1.1.54/325.5.5.56-24960
*>7.7.7.55/320.0.0.024960-
#show mpls forwarding-table | include 1.1.1.54
B>1.1.1.54/3240YesLSP_DEFAULT24960
eth25.5.5.56

#show mpls ilm-table
Codes: > - installed ILM, * - selected ILM, p - stale ILM K - CLI ILM, T -
MPLS-TP, S - Stitched ILM

```

```
CodeFECILM-IDIn-LabelOut-LabelIn-IntfOut- IntfNexthopLSP-Type
>7.7.7.55/32924960N/AN/AN/A
127.0.0.1LSP_DEFAULT
>62.1.1.0/241024961N/AN/Aeth1
0.0.0.0LSP_DEFAULT

#show mpls ftn-table
Primary FTN entry with FEC: 1.1.1.54/32, id: 4, row status: Active
Owner: BGP, Action-type: Redirect to LSP, Exp-bits: 0x0, Incoming DSCP: none
Tunnel id: 0,Protected LSP id: 0, Description: N/A
Cross connect ix: 4, in intf: - in label: 0 out-segment ix: 3 Owner: BGP,
Persistent: No, Admin Status: Up, Oper Status: Up
Out-segment with ix: 3, owner: BGP, out intf: eth2, out label: 24960 Nexthop
addr: 5.5.5.56cross connect ix: 4, op code: Push and
Lookup

Primary FTN entry with FEC: 5.5.5.56/32, id: 1, row status: Active
Owner: LDP, Action-type: Redirect to LSP, Exp-bits: 0x0, Incoming DSCP: none
Tunnel id: 0,Protected LSP id: 0, Description: N/A
Cross connect ix: 1, in intf: - in label: 0 out-segment ix: 1 Owner: LDP,
Persistent: No, Admin Status: Up, Oper Status: Up
Out-segment with ix: 1, owner: LDP, out intf: eth2, out label: 24321 Nexthop
addr: 60.1.1.22cross connect ix: 1, op code: Push

Primary FTN entry with FEC: 6.6.6.22/32, id: 2, row status: Active
Owner: LDP, Action-type: Redirect to LSP, Exp-bits: 0x0, Incoming DSCP: none
Tunnel id: 0,Protected LSP id: 0, Description: N/A
Cross connect ix: 2, in intf: - in label: 0 out-segment ix: 2 Owner: LDP,
Persistent: No, Admin Status: Up, Oper Status: Up
Out-segment with ix: 2, owner: LDP, out intf: eth2, out label: 3 Nexthop addr:
60.1.1.22cross connect ix: 2, op code: Push

Primary FTN entry with FEC: 50.1.1.0/24, id: 3, row status: Active

Owner: LDP, Action-type: Redirect to LSP, Exp-bits: 0x0, Incoming DSCP: none
Tunnel id: 0,Protected LSP id: 0, Description: N/A
Cross connect ix: 2, in intf: - in label: 0 out-segment ix: 2 Owner: LDP,
Persistent: No, Admin Status: Up, Oper Status: Up
Out-segment with ix: 2, owner: LDP, out intf: eth2, out label: 3 Nexthop addr:
60.1.1.22cross connect ix: 2, op code: Push
```

BGP Labeled Unicast with Inter-AS

Topology

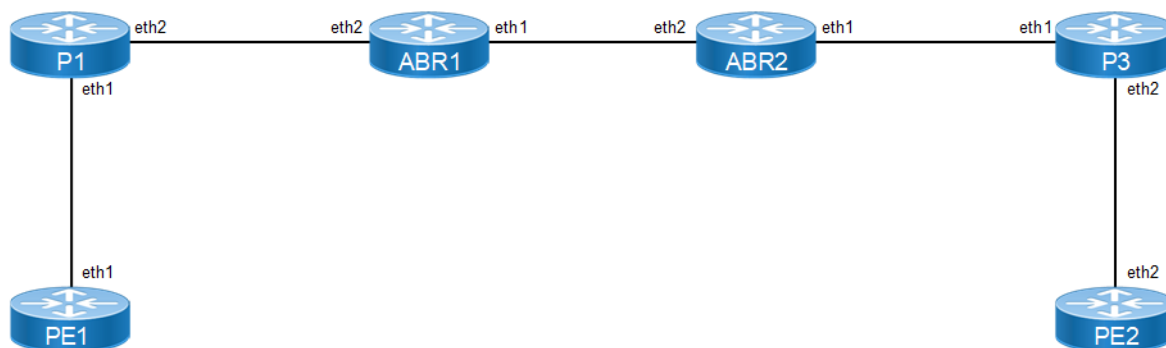

Figure 4-55: BGP Labeled unicast with Inter-AS

Configurations

PE1

#configure terminal	Enter the Configure mode.
(config)#interface lo	Enter interface mode
(config-if)#ip address 1.1.1.54/32 secondary	Configure the IP address of the interface loopback
(config-if)#exit	Exit interface mode
(config)#interface eth1	Enter interface mode
(config-if)#ip address 10.1.1.54/24	Configure the IP address of the interface eth1
(config-if)#label-switching	Enable label-switching on interface eth1
(config-if)# enable-ldp ipv4	Enable LDP process on eth1 interface
(config-if)#exit	Exit interface mode.
(config)#router ospf 10	Configure the routing process OSPF with process id 10
(config-router)#network 1.1.1.54/32 area 0	Define the interface (1.1.1.54/32) on which OSPF runs, and associate the area ID (0) with the interface (area ID 0 specifies the backbone area).
(config-router)#network 10.1.1.0/24 area 0	Define the interface (10.1.1.0/24) on which OSPF runs, and associate the area ID (0) with the interface (area ID 0 specifies the backbone area).
(config-router)#exit	Exit from router ospf mode
(config)#commit	Commit the candidate configuration to the running configuration.
(config)#router bgp 100	Enter Router BGP mode
(config-router)#neighbor 7.7.7.55 remote-as 100	Add loopback ip of PE2 as neighbor with neighbor AS
(config-router)#neighbor 7.7.7.55 update-source lo	Update the source for that particular neighbor as loopback interface

BGP Labeled Unicast

<code>(config-router)#neighbor 3.3.3.52 remote-as 100</code>	Add loopback ip of ABR1 as neighbor with neighbor AS
<code>(config-router)#neighbor 3.3.3.52 update-source lo</code>	Update the source for that particular neighbor as loopback interface
<code>(config-router)#allocate-label all</code>	Allocate labels
<code>(config-router)#address-family ipv4 labeled-unicast</code>	Enter into labeled-unicast address family
<code>(config-router-af)#neighbor 3.3.3.52 activate</code>	Activate the neighbor inside labeled-unicast address family
<code>(config-router-af)#exit-address-family</code>	Exit from address family IPv4 labeled unicast
<code>(config-router)#address-family vpv4 unicast</code>	Enter into vpv4 unicast address family
<code>(config-router-af)#neighbor 7.7.7.55 activate</code>	Activate the neighbor inside vpv4 address family
<code>(config-router-af)#network 1.1.1.54/32</code>	Advertise the loopback of RTR1 in BGP
<code>(config-router-af)#exit-address-family</code>	Exit from address family vpv4
<code>(config-router)#exit</code>	Exit from router BGP mode
<code>(config)#commit</code>	Commit the candidate configuration to the running configuration.
<code>(config)# router ldp</code>	Configure Router LDP instance
<code>(config-router)# transport-address ipv4 1.1.1.54 0</code>	Configure Transport address for LDP with label space value 0
<code>(config-router)#exit</code>	Exit from router mode
<code>(config)# ip vrf vrf1</code>	Specify the name of the VRF (vrf1) to be created.
<code>(config-vrf)#rd 10:100</code>	Assign a route distinguisher (RD) for the VRF, which is a unique value on the router. The RD value can be in ASN:NN or A.B.C.D:NN format.
<code>(config-vrf)#route-target both 100:300</code>	Specify the 2-Octet AS specific or IPv4 specific Transitive Route-Target extended community attribute.
<code>(config-vrf)#exit</code>	Exit VRF mode, and return to Configure mode.
<code>(config)#interface eth2</code>	Enter interface mode
<code>(config-if)# ip vrf forwarding vrf1</code>	Bind the interface (eth2) to the VRF vrf1
<code>(config-if)# ip address 61.1.1.54/24</code>	Configure the IP address of the interface eth2
<code>(config-if)#exit</code>	Exit interface mode.
<code>(config)#commit</code>	Commit the candidate configuration to the running configuration.
<code>(config)#router bgp 100</code>	Enter Router BGP mode
<code>(config-router)# address-family ipv4 vrf vrf1</code>	Enter address family ipv4 vrf mode
<code>(config-router-af)# redistribute connected</code>	Redistribute connected routes
<code>(config-router-af)# exit-address-family</code>	Exit address-family mode.
<code>(config-router)#commit</code>	Commit the candidate configuration to the running configuration.

P1

#configure terminal	Enter the Configure mode.
(config)#interface lo	Enter interface mode
(config-if)#ip address 2.2.2.23/32	Configure the IP address of the interface loopback
(config-if)#exit	Exit interface mode
(config)#interface eth1	Enter interface mode
(config-if)#ip address 10.1.1.23/24	Configure the IP address of the interface eth1
(config-if)#label-switching	Enable label-switching on interface eth1
(config-if)# enable-ldp ipv4	Enable LDP process on eth1 interface
(config-if)#exit	Exit interface mode.
(config)#interface eth2	Enter interface mode
(config-if)#ip address 20.1.1.23/24	Configure the IP address of the interface eth2
(config-if)#label-switching	Enable label-switching on interface eth2
(config-if)# enable-ldp ipv4	Enable LDP process on eth2 interface
(config-if)#exit	Exit interface mode.
(config)#commit	Commit the candidate configuration to the running configuration.
(config)#router ospf 10	Configure the routing process OSPF with process id 10
(config-router)#network 20.1.1.0/24 area 0	Define the interface (20.1.1.0/24) on which OSPF runs, and associate the area ID (0) with the interface (area ID 0 specifies the backbone area).
(config-router)#network 10.1.1.0/24 area 0	Define the interface (10.1.1.0/24) on which OSPF runs, and associate the area ID (0) with the interface (area ID 0 specifies the backbone area).
(config-router)#network 2.2.2.23/32 area 0	Define the interface (2.2.2.23/32) on which OSPF runs, and associate the area ID (0) with the interface (area ID 0 specifies the backbone area).
(config-router)#exit	Exit from router ospf mode
(config)# router ldp	Configure Router LDP instance
(config-router)# transport-address ipv4 2.2.2.23 0	Configure Transport address for LDP with label space value 0
(config-router)#exit	Exit from router mode
(config)# ip route 7.7.7.55/32 20.1.1.52	Specify the destination prefix and mask for the network and a gateway.
(config)#commit	Commit the candidate configuration to the running configuration.

ABR1

#configure terminal	Enter the Configure mode.
(config)#interface lo	Enter interface mode
(config-if)#ip address 3.3.3.52/32	Configure the IP address of the interface loopback
(config-if)#exit	Exit interface mode
(config)#interface eth1	Enter interface mode

BGP Labeled Unicast

<code>(config-if)#ip address 52.56.1.52/24</code>	Configure the IP address of the interface eth1
<code>(config-if)#label-switching</code>	Enable label-switching on interface eth1
<code>(config-if)# enable-ldp ipv4</code>	Enable LDP process on eth1 interface
<code>(config-if)#exit</code>	Exit interface mode.
<code>(config)#interface eth2</code>	Enter interface mode
<code>(config-if)#ip address 20.1.1.52/24</code>	Configure the IP address of the interface eth2
<code>(config-if)#label-switching</code>	Enable label-switching on interface eth2
<code>(config-if)# enable-ldp ipv4</code>	Enable LDP process on eth2 interface
<code>(config-if)#exit</code>	Exit interface mode.
<code>(config)#router ospf 10</code>	Configure the routing process OSPF with process id 20
<code>(config-router)#network 3.3.3.52/32 area 0</code>	Define the interface (3.3.3.52/32) on which OSPF runs, and associate the area ID (0) with the interface (area ID 0 specifies the backbone area).
<code>(config-router)#network 20.1.1.0/24 area 0</code>	Define the interface (20.1.1.0/24) on which OSPF runs, and associate the area ID (0) with the interface (area ID 0 specifies the backbone area).
<code>(config-router)#exit</code>	Exit from router ospf mode
<code>(config)# router ldp</code>	Configure Router LDP instance
<code>(config-router)# transport-address ipv4 3.3.3.52 0</code>	Configure Transport address for LDP with label space value 0
<code>(config-router)#exit</code>	Exit from router mode
<code>(config)#commit</code>	Commit the candidate configuration to the running configuration.
<code>(config)#router bgp 100</code>	Enter Router BGP mode
<code>(config-router)#neighbor 1.1.1.54 remote-as 100</code>	Add loopback ip of PE2 as neighbor with neighbor AS
<code>(config-router)#neighbor 1.1.1.54 update-source lo</code>	Update the source for that particular neighbor as loopback interface
<code>(config-router)#neighbor 52.56.1.56 remote-as 100</code>	Add loopback ip of ABR1 as neighbor with neighbor AS
<code>(config-router)#allocate-label all</code>	Allocate labels
<code>(config-router)#address-family ipv4 labeled-unicast</code>	Enter into labeled-unicast address family
<code>(config-router-af)#neighbor 1.1.1.54 activate</code>	Activate the neighbor inside labeled-unicast address family
<code>(config-router-af)#neighbor 52.56.1.56 activate</code>	Activate the neighbor inside labeled-unicast address family
<code>(config-router-af)# neighbor 1.1.1.54 route-reflector-client</code>	Enable Route reflector client for the neighbor inside address family IPv4 labeled unicast
<code>(config-router-af)# neighbor 1.1.1.54 next-hop-self</code>	Enable next hop self for the particular neighbor inside address family IPv4 labeled unicast
<code>(config-router-af)# neighbor 52.56.1.56 next-hop-self</code>	Enable next hop self for the particular neighbor inside address family IPv4 labeled unicast
<code>(config-router-af)#exit-address-family</code>	Exit from address family labeled-unicast

<code>(config-router)#exit</code>	Exit from router BGP mode
<code>(config)#commit</code>	Commit the candidate configuration to the running configuration.

ABR2

<code>#configure terminal</code>	Enter the Configure mode.
<code>(config)#interface lo</code>	Enter interface mode
<code>(config-if)#ip address 5.5.5.56/32</code>	Configure the IP address of the interface loopback
<code>(config-if)#exit</code>	Exit interface mode
<code>(config)#interface eth1</code>	Enter interface mode
<code>(config-if)#ip address 50.1.1.56/24</code>	Configure the IP address of the interface eth1
<code>(config-if)#label-switching</code>	Enable label-switching on interface eth1
<code>(config-if)#exit</code>	Exit interface mode.
<code>(config)#interface eth2</code>	Enter interface mode
<code>(config-if)#ip address 52.56.1.56/24</code>	Configure the IP address of the interface eth2
<code>(config-if)#label-switching</code>	Enable label-switching on interface eth2
<code>(config-if)#exit</code>	Exit interface mode.
<code>(config)#commit</code>	Commit the candidate configuration to the running configuration.
<code>(config)#router ospf 30</code>	Configure the routing process OSPF with process Id 1
<code>(config-router)#network 5.5.5.56/32 area 0</code>	Define the interface (5.5.5.56/32) on which OSPF runs, and associate the area ID (0) with the interface (area ID 0 specifies the backbone area).
<code>(config-router)#network 50.1.1.0/24 area 0</code>	Define the interface (50.1.1.0/24) on which OSPF runs, and associate the area ID (0) with the interface (area ID 0 specifies the backbone area).
<code>(config-router)#exit</code>	Exit from router ospf mode
<code>(config)#commit</code>	Commit the candidate configuration to the running configuration.
<code>(config)# router ldp</code>	Configure Router LDP instance
<code>(config-router)# transport-address ipv4 5.5.5.56 0</code>	Configure Transport address for LDP with label space value 0
<code>(config-router)#exit</code>	Exit from router mode
<code>(config)#commit</code>	Commit the candidate configuration to the running configuration.
<code>(config)#router bgp 200</code>	Enter Router BGP mode
<code>(config-router)#neighbor 52.56.1.52 remote-as 100</code>	Add neighbor peer ip and neighbor AS
<code>(config-router)#neighbor 7.7.7.55 remote-as 100</code>	Add loopback ip of PE2 as neighbor with neighbor AS
<code>(config-router)#neighbor 7.7.7.55 update-source lo</code>	Update the source for that particular neighbor as loopback interface
<code>(config-router)#allocate-label all</code>	Allocate labels

BGP Labeled Unicast

(config-router)#address-family ipv4 labeled-unicast	Enter into labeled-unicast address family
(config-router-af)#neighbor 52.56.1.52 activate	Activate the neighbor inside labeled-unicast address family
(config-router-af)#neighbor 7.7.7.55 activate	Activate the neighbor inside labeled-unicast address family
(config-router-af)# neighbor 7.7.7.55 route-reflector-client	Enable Route reflector client for the neighbor inside address family IPv4 labeled unicast
(config-router-af)# neighbor 52.56.1.52 next-hop-self	Enable next hop self for the particular neighbor inside address family IPv4 labeled unicast
(config-router-af)# neighbor 7.7.7.55 next-hop-self	Enable next hop self for the particular neighbor inside address family IPv4 labeled unicast
(config-router-af)#exit-address-family	Exit from address family vpv4
(config-router)#exit	Exit from router BGP mode
(config)#commit	Commit the candidate configuration to the running configuration.

P2

#configure terminal	Enter the Configure mode.
(config)#interface lo	Enter interface mode
(config-if)#ip address 6.6.6.22/32	Configure the IP address of the interface loopback
(config-if)#exit	Exit interface mode
(config)#interface eth1	Enter interface mode
(config-if)#ip address 50.1.1.22/24	Configure the IP address of the interface eth1
(config-if)#label-switching	Enable label-switching on interface eth1
(config-if)# enable-ldp ipv4	Enable LDP process on eth1 interface
(config-if)#exit	Exit interface mode.
(config)#interface eth2	Enter interface mode
(config-if)#ip address 60.1.1.22/24	Configure the IP address of the interface eth2
(config-if)#label-switching	Enable label-switching on interface eth2
(config-if)# enable-ldp ipv4	Enable LDP process on eth2 interface
(config-if)#exit	Exit interface mode
(config)#commit	Commit the candidate configuration to the running configuration.
(config)#router ospf 30	Configure the routing process OSPF with process id 20
(config-router)#network 50.1.1.0/24 area 0	Define the interface (30.1.1.0/24) on which OSPF runs, and associate the area ID (0) with the interface (area ID 0 specifies the backbone area).
(config-router)#network 60.1.1.0/24 area 0	Define the interface (40.1.1.0/24) on which OSPF runs, and associate the area ID (0) with the interface (area ID 0 specifies the backbone area).
(config-router)#network 6.6.6.22/32 area 0	Define the interface (4.4.4.53/32) on which OSPF runs, and associate the area ID (0) with the interface (area ID 0 specifies the backbone area).
(config-router)#exit	Exit from router ospf mode

(config)#commit	Commit the candidate configuration to the running configuration.
(config)# router ldp	Configure Router LDP instance
(config-router)# transport-address ipv4 6.6.6.22 0	Configure Transport address for LDP with label space value 0
(config-router)#exit	Exit from router mode
(config)# ip route 1.1.1.54/32 50.1.1.56	Specify the destination prefix and mask for the network and a gateway.
(config)#exit	Exit from Cofig mode
(config)#commit	Commit the candidate configuration to the running configuration.

PE2

#configure terminal	Enter the Configure mode.
(config)#interface lo	Enter interface mode
(config-if)#ip address 7.7.7.55/32 secondary	Configure the IP address of the interface loopback
(config-if)#exit	Exit interface mode
(config)#interface eth2	Enter interface mode
(config-if)#ip address 60.1.1.55/24	Configure the IP address of the interface eth1
(config-if)#label-switching	Enable label-switching on interface eth1
(config-if)# enable-ldp ipv4	Enable LDP process on eth1 interface
(config-if)#exit	Exit interface mode.
(config)#commit	Commit the candidate configuration to the running configuration.
(config)#router ospf 30	Configure the routing process OSPF with process id 10
(config-router)#network 7.7.7.55/32 area 0	Define the interface (7.7.7.55/32) on which OSPF runs, and associate the area ID (0) with the interface (area ID 0 specifies the backbone area).
(config-router)#network 60.1.1.0/24 area 0	Define the interface (60.1.1.0/24) on which OSPF runs, and associate the area ID (0) with the interface (area ID 0 specifies the backbone area).
(config-router)#exit	Exit from router ospf mode
(config)#commit	Commit the candidate configuration to the running configuration.
(config)#router bgp 200	Enter Router BGP mode
(config-router)#neighbor 1.1.1.54 remote-as 100	Add loopback ip of PE2 as neighbor with neighbor AS
(config-router)#neighbor 1.1.1.54 update-source lo	Update the source for that particular neighbor as loopback interface
(config-router)#neighbor 1.1.1.54 ebgp-multihop	Enable neighbor connection between two eBGP
(config-router)#neighbor 5.5.5.56 remote-as 200	Add loopback ip of ABR1 as neighbor with neighbor AS
(config-router)#neighbor 5.5.5.56 update-source lo	Update the source for that particular neighbor as loopback interface

BGP Labeled Unicast

(config-router)#allocate-label all	Allocate labels
(config-router)#address-family ipv4 labeled-unicast	Enter into labeled-unicast address family
(config-router-af)#neighbor 5.5.5.56 activate	Activate the neighbor inside vpnv4 address family
(config-router-af)#exit-address-family	Exit from address family IPv4 labeled unicast
(config-router)#address-family vpnv4 unicast	Enter into vpnv4 unicast address family
(config-router-af)#neighbor 1.1.1.54 allow-ebgp-vpn	Allow eBGP neighbor to be a vpn peer.
(config-router-af)#neighbor 1.1.1.54 activate	Activate the neighbor inside labeled-unicast address family
(config-router-af)#exit-address-family	Exit from address family vpnv4
(config-router)#address-family ipv4 unicast	Enter into ipv4 unicast address family
(config-router-af)#network 7.7.7.55/32	Advertise the loopback of RTR1 in BGP
(config-router-af)#exit-address-family	Exit from address family vpnv4
(config-router)#exit	Exit from router BGP mode
(config)# router ldp	Configure Router LDP instance
(config-router)# transport-address ipv4 7.7.7.55 0	Configure Transport address for LDP with label space value 0
(config-router)#exit	Exit from router mode
(config)# ip vrf vrf1	Specify the name of the VRF (vrf1) to be created.
(config-vrf)#rd 10:100	Assign a route distinguisher (RD) for the VRF, which is a unique value on the router. The RD value can be in ASN:NN or A.B.C.D:NN format.
(config-vrf)#route-target both 100:300	Specify the 2-Octet AS specific or IPv4 specific Transitive Route-Target extended community attribute.
(config-vrf)#exit	Exit VRF mode, and return to Configure mode.
(config)#interface eth2	Enter interface mode
(config-if)# ip vrf forwarding vrf1	Bind the interface (eth2) to the VRF vrf1
(config-if)# ip address 62.1.1.55/24	Configure the IP address of the interface eth2
(config-if)#exit	Exit interface mode.
(config)#commit	Commit the candidate configuration to the running configuration.
(config)#router bgp 100	Enter Router BGP mode
(config-router)# address-family ipv4 vrf vrf1	Enter address family ipv4 vrf mode
(config-router-af)# redistribute connected	Redistribute connected routes
(config-router-af)# exit-address-family	Exit address-family mode.
(config-router)#commit	Commit the candidate configuration to the running configuration.

Validation

PE1

```
#sh ip bgp labeled-unicast
```

Status codes: s suppressed, d damped, h history, * valid, > best, i - internal, S - stale

Network Next HopIn LabelOut Label

```
*> 1.1.1.54/32 0.0.0.0 24969 -
*>i 7.7.7.55/32 3.3.3.52 - 24322
```

#sh mpls forwarding-table

Codes: > - installed FTN, * - selected FTN, p - stale FTN, B - BGP FTN, K - CLI FTN, t - tunnel

L - LDP FTN, R - RSVP-TE FTN, S - SNMP FTN, I - IGP-Shortcut,
U - unknown FTN, O - SR-OSPF FTN, i - SR-ISIS FTN, k - SR-CLI FTN

10.1.1.23

10.1.1.23

3.3.3.52

10.1.1.23

#sh mpls ftn-table

Nexthop

Primary FTN entry with FEC: 2.2.2.23/32, id: 1, row status: Active

Owner: LDP, Action-type: Redirect to LSP, Exp-bits: 0x0, Incoming DSCP: none Tunnel id: 0, Protected LSP id: 0, Description: N/A

Cross connect ix: 1, in intf: - in label: 0 out-segment ix: 1 Owner: LDP, Persistent: No, Admin Status: Up, Oper Status: Up

Out-segment with ix: 1, owner: LDP, out intf: eth1, out label: 3 Nexthop addr: 10.1.1.23 cross connect ix: 1, op code: Push

Primary FTN entry with FEC: 3.3.3.52/32, id: 3, row status: Active

Owner: LDP, Action-type: Redirect to LSP, Exp-bits: 0x0, Incoming DSCP: none Tunnel id: 0, Protected LSP id: 0, Description: N/A

Cross connect ix: 2, in intf: - in label: 0 out-segment ix: 2 Owner: LDP, Persistent: No, Admin Status: Up, Oper Status: Up

Out-segment with ix: 2, owner: LDP, out intf: eth1, out label: 24321 Nexthop addr: 10.1.1.23 cross connect ix: 2, op code: Push

Primary FTN entry with FEC: 7.7.7.55/32, id: 4, row status: Active

Owner: BGP, Action-type: Redirect to LSP, Exp-bits: 0x0, Incoming DSCP: none Tunnel id: 0, Protected LSP id: 0, Description: N/A

Cross connect ix: 4, in intf: - in label: 0 out-segment ix: 3 Owner: BGP, Persistent: No, Admin Status: Up, Oper Status: Up

Out-segment with ix: 3, owner: BGP, out intf: eth1, out label: 24322 Nexthop addr: 3.3.3.52 cross connect ix: 4, op code: Push and

Lookup

Primary FTN entry with FEC: 20.1.1.0/24, id: 2, row status: Active

Owner: LDP, Action-type: Redirect to LSP, Exp-bits: 0x0, Incoming DSCP: none Tunnel id: 0, Protected LSP id: 0, Description: N/A

Cross connect ix: 1, in intf: - in label: 0 out-segment ix: 1 Owner: LDP, Persistent: No, Admin Status: Up, Oper Status: Up

Out-segment with ix: 1, owner: LDP, out intf: eth1, out label: 3 Nexthop addr: 10.1.1.23 cross connect ix: 1, op code: Push

ABR1

```
#sh ip bgp labeled-unicast
```

```
Status codes: s suppressed, d damped, h history, * valid, > best, i -
internal, S - stale
```

Network	Next Hop	In Label	Out Label
*>i 1.1.1.54/32	1.1.1.54	24323	24969
*> 7.7.7.55/32	52.56.1.56	24322	24325

```
#sh mpls forwarding-table
```

```
Codes: > - installed FTN, * - selected FTN, p - stale FTN,
B - BGP FTN, K - CLI FTN, t - tunnel
L - LDP FTN, R - RSVP-TE FTN, S - SNMP FTN, I - IGP-Shortcut,
U - unknown FTN, O - SR-OSPF FTN, i - SR-ISIS FTN, k - SR-CLI FTN
```

Code Label	FEC Out-Intf	FTN-ID Nexthop	Tunnel-id	Pri	LSP-Type	Out-
L> eth2	1.1.1.54/32 20.1.1.23	2	0	Yes	LSP_DEFAULT	24322
B eth2	1.1.1.54/32 1.1.1.54	5	0	Yes	LSP_DEFAULT	24969
L> eth2	2.2.2.23/32 20.1.1.23	3	0	Yes	LSP_DEFAULT	3
B> eth1	7.7.7.55/32 52.56.1.56	1	0	Yes	LSP_DEFAULT	24325
L> eth2	10.1.1.0/24 20.1.1.23	4	0	Yes	LSP_DEFAULT	3

```
#sh mpls ftn-table
```

```
Primary FTN entry with FEC: 1.1.1.54/32, id: 2, row status: Active
Owner: LDP, Action-type: Redirect to LSP, Exp-bits: 0x0, Incoming DSCP: none
Tunnel id: 0, Protected LSP id: 0, Description: N/A
Cross connect ix: 2, in intf: - in label: 0 out-segment ix: 2
Owner: LDP, Persistent: No, Admin Status: Up, Oper Status: Up
Out-segment with ix: 2, owner: LDP, out intf: eth2, out label: 24322
Nexthop addr: 20.1.1.23 cross connect ix: 2, op code: Push
```

```
Primary FTN entry with FEC: 1.1.1.54/32, id: 5, row status: Active
Owner: BGP, Action-type: Redirect to LSP, Exp-bits: 0x0, Incoming DSCP: none
Tunnel id: 0, Protected LSP id: 0, Description: N/A
Cross connect ix: 8, in intf: - in label: 0 out-segment ix: 8
Owner: BGP, Persistent: No, Admin Status: Down, Oper Status: Down
Out-segment with ix: 8, owner: BGP, out intf: eth2, out label: 24969
Nexthop addr: 1.1.1.54 cross connect ix: 8, op code: Push and
Lookup
```

```
Primary FTN entry with FEC: 2.2.2.23/32, id: 3, row status: Active
Owner: LDP, Action-type: Redirect to LSP, Exp-bits: 0x0, Incoming DSCP: none
Tunnel id: 0, Protected LSP id: 0, Description: N/A
Cross connect ix: 3, in intf: - in label: 0 out-segment ix: 3
Owner: LDP, Persistent: No, Admin Status: Up, Oper Status: Up
Out-segment with ix: 3, owner: LDP, out intf: eth2, out label: 3
Nexthop addr: 20.1.1.23 cross connect ix: 3, op code: Push
```

```
Primary FTN entry with FEC: 7.7.7.55/32, id: 1, row status: Active
```

Owner: BGP, Action-type: Redirect to LSP, Exp-bits: 0x0, Incoming DSCP: none
 Tunnel id: 0, Protected LSP id: 0, Description: N/A
 Cross connect ix: 7, in intf: - in label: 0 out-segment ix: 7
 Owner: BGP, Persistent: No, Admin Status: Up, Oper Status: Up
 Out-segment with ix: 7, owner: BGP, out intf: eth1, out label: 24325
 Nexthop addr: 52.56.1.56 cross connect ix: 7, op code: Push

Primary FTN entry with FEC: 10.1.1.0/24, id: 4, row status: Active
 Owner: LDP, Action-type: Redirect to LSP, Exp-bits: 0x0, Incoming DSCP: none
 Tunnel id: 0, Protected LSP id: 0, Description: N/A
 Cross connect ix: 3, in intf: - in label: 0 out-segment ix: 3
 Owner: LDP, Persistent: No, Admin Status: Up, Oper Status: Up
 Out-segment with ix: 3, owner: LDP, out intf: eth2, out label: 3
 Nexthop addr: 20.1.1.23 cross connect ix: 3, op code: Push

ABR2

```
#sh ip bgp labeled-unicast
```

Status codes: s suppressed, d damped, h history, * valid, > best, i - internal, S - stale

Network	Next Hop	In Label	Out Label
*> 1.1.1.54/32	52.56.1.52	24322	24323
*>i 7.7.7.55/32	7.7.7.55	24325	24967

```
#sh mpls forwarding-table
```

Codes: > - installed FTN, * - selected FTN, p - stale FTN,
 B - BGP FTN, K - CLI FTN, t - tunnel
 L - LDP FTN, R - RSVP-TE FTN, S - SNMP FTN, I - IGP-Shortcut,
 U - unknown FTN, O - SR-OSPF FTN, i - SR-ISIS FTN, k - SR-CLI FTN

Code Label	FEC Out-Intf	FTN-ID Nexthop	Tunnel-id	Pri	LSP-Type	Out-
B> eth2	1.1.1.54/32 52.56.1.52	1	0	Yes	LSP_DEFAULT	24323
L> eth1	6.6.6.22/32 50.1.1.22	2	0	Yes	LSP_DEFAULT	3
L> eth1	7.7.7.55/32 50.1.1.22	3	0	Yes	LSP_DEFAULT	24322
B eth1	7.7.7.55/32 7.7.7.55	5	0	Yes	LSP_DEFAULT	24967
L> eth1	60.1.1.0/24 50.1.1.22	4	0	Yes	LSP_DEFAULT	3

```
#sh mpls ftn-table
```

Primary FTN entry with FEC: 1.1.1.54/32, id: 1, row status: Active
 Owner: BGP, Action-type: Redirect to LSP, Exp-bits: 0x0, Incoming DSCP: none
 Tunnel id: 0, Protected LSP id: 0, Description: N/A
 Cross connect ix: 8, in intf: - in label: 0 out-segment ix: 8
 Owner: BGP, Persistent: No, Admin Status: Up, Oper Status: Up
 Out-segment with ix: 8, owner: BGP, out intf: eth2, out label: 24323
 Nexthop addr: 52.56.1.52 cross connect ix: 8, op code: Push

Primary FTN entry with FEC: 6.6.6.22/32, id: 2, row status: Active
 Owner: LDP, Action-type: Redirect to LSP, Exp-bits: 0x0, Incoming DSCP: none
 Tunnel id: 0, Protected LSP id: 0, Description: N/A
 Cross connect ix: 2, in intf: - in label: 0 out-segment ix: 2

BGP Labeled Unicast

Owner: LDP, Persistent: No, Admin Status: Up, Oper Status: Up
Out-segment with ix: 2, owner: LDP, out intf: eth1, out label: 3
Nexthop addr: 50.1.1.22 cross connect ix: 2, op code: Push

Primary FTN entry with FEC: 7.7.7.55/32, id: 3, row status: Active
Owner: LDP, Action-type: Redirect to LSP, Exp-bits: 0x0, Incoming DSCP: none
Tunnel id: 0, Protected LSP id: 0, Description: N/A
Cross connect ix: 3, in intf: - in label: 0 out-segment ix: 3
Owner: LDP, Persistent: No, Admin Status: Up, Oper Status: Up
Out-segment with ix: 3, owner: LDP, out intf: eth1, out label: 24322
Nexthop addr: 50.1.1.22 cross connect ix: 3, op code: Push

Primary FTN entry with FEC: 7.7.7.55/32, id: 5, row status: Active
Owner: BGP, Action-type: Redirect to LSP, Exp-bits: 0x0, Incoming DSCP: none
Tunnel id: 0, Protected LSP id: 0, Description: N/A
Cross connect ix: 7, in intf: - in label: 0 out-segment ix: 7
Owner: BGP, Persistent: No, Admin Status: Down, Oper Status: Down
Out-segment with ix: 7, owner: BGP, out intf: eth1, out label: 24967
Nexthop addr: 7.7.7.55 cross connect ix: 7, op code: Push and
Lookup

Primary FTN entry with FEC: 60.1.1.0/24, id: 4, row status: Active
Owner: LDP, Action-type: Redirect to LSP, Exp-bits: 0x0, Incoming DSCP: none
Tunnel id: 0, Protected LSP id: 0, Description: N/A
Cross connect ix: 2, in intf: - in label: 0 out-segment ix: 2
Owner: LDP, Persistent: No, Admin Status: Up, Oper Status: Up
Out-segment with ix: 2, owner: LDP, out intf: eth1, out label: 3
Nexthop addr: 50.1.1.22 cross connect ix: 2, op code: Push

PE2

```
#show ip bgp labeled-unicast
```

Status codes: s suppressed, d damped, h history, * valid, > best, i -
internal, S - stale

Network	Next Hop	In Label	Out Label
*>i 1.1.1.54/32	5.5.5.56	-	24322
*> 7.7.7.55/32	0.0.0.0	24967	-

```
#show mpls forwarding-table
```

Codes: > - installed FTN, * - selected FTN, p - stale FTN,
B - BGP FTN, K - CLI FTN, t - tunnel
L - LDP FTN, R - RSVP-TE FTN, S - SNMP FTN, I - IGP-Shortcut,
U - unknown FTN, O - SR-OSPF FTN, i - SR-ISIS FTN, k - SR-CLI FTN

Code Label	FEC Out-Intf	FTN-ID Nexthop	Tunnel-id	Pri	LSP-Type	Out-
B>	1.1.1.54/32	4	0	Yes	LSP_DEFAULT	24322
eth2	5.5.5.56					
L>	5.5.5.56/32	3	0	Yes	LSP_DEFAULT	24321
eth2	60.1.1.22					
L>	6.6.6.22/32	2	0	Yes	LSP_DEFAULT	3
eth2	60.1.1.22					
L>	50.1.1.0/24	1	0	Yes	LSP_DEFAULT	3
eth2	60.1.1.22					

```
#sh mpls ftn-table
Primary FTN entry with FEC: 1.1.1.54/32, id: 4, row status: Active
  Owner: BGP, Action-type: Redirect to LSP, Exp-bits: 0x0, Incoming DSCP: none
  Tunnel id: 0, Protected LSP id: 0, Description: N/A
  Cross connect ix: 36, in intf: - in label: 0 out-segment ix: 37
  Owner: BGP, Persistent: No, Admin Status: Up, Oper Status: Up
  Out-segment with ix: 37, owner: BGP, out intf: eth2, out label: 24322
  Nexthop addr: 5.5.5.56 cross connect ix: 36, op code: Push and
Lookup
```

```
Primary FTN entry with FEC: 5.5.5.56/32, id: 3, row status: Active
  Owner: LDP, Action-type: Redirect to LSP, Exp-bits: 0x0, Incoming DSCP: none
  Tunnel id: 0, Protected LSP id: 0, Description: N/A
  Cross connect ix: 7, in intf: - in label: 0 out-segment ix: 6
  Owner: LDP, Persistent: No, Admin Status: Up, Oper Status: Up
  Out-segment with ix: 6, owner: LDP, out intf: eth2, out label: 24321
  Nexthop addr: 60.1.1.22 cross connect ix: 7, op code: Push
```

```
Primary FTN entry with FEC: 6.6.6.22/32, id: 2, row status: Active
  Owner: LDP, Action-type: Redirect to LSP, Exp-bits: 0x0, Incoming DSCP: none
  Tunnel id: 0, Protected LSP id: 0, Description: N/A
  Cross connect ix: 9, in intf: - in label: 0 out-segment ix: 8
  Owner: LDP, Persistent: No, Admin Status: Up, Oper Status: Up
  Out-segment with ix: 8, owner: LDP, out intf: eth2, out label: 3
  Nexthop addr: 60.1.1.22 cross connect ix: 9, op code: Push
```

```
Primary FTN entry with FEC: 50.1.1.0/24, id: 1, row status: Active
  Owner: LDP, Action-type: Redirect to LSP, Exp-bits: 0x0, Incoming DSCP: none
  Tunnel id: 0, Protected LSP id: 0, Description: N/A
  Cross connect ix: 9, in intf: - in label: 0 out-segment ix: 8
  Owner: LDP, Persistent: No, Admin Status: Up, Oper Status: Up
  Out-segment with ix: 8, owner: LDP, out intf: eth2, out label: 3
  Nexthop addr: 60.1.1.22 cross connect ix: 9, op code: Push
```

BGP Peer Groups for Address-Family IPv4 Labeled Unicast

Topology

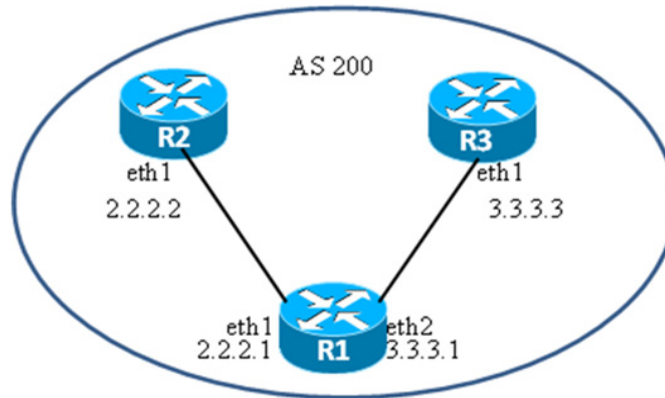

Figure 4-56: BGP Peer-Groups with IPv4 Labeled-Unicast Members

R1

(config)# interface lo	Enter interface mode for Loopback
(config-if)#ip address 1.1.1.1/32 secondary	Configure ip address for Loopback interface
(config-if)#ip address 11.11.11.11/32 secondary	Configure ip address for Loopback interface
(config-if)#exit	Exit interface mode
(config)#router bgp 200	Define the routing process. The number 200 specifies the AS number of R1.
(config-router)#neighbor ABC peer-group	Create a peer group named ABC.
(config-router)#neighbor ABC remote-as 200	Assign options to the peer group named ABC.
(config-router)#neighbor 2.2.2.2 peer-group ABC	Define neighbor 2.2.2.2 (R2) as a peer group member.
(config-router)#neighbor 3.3.3.3 peer-group ABC	Define neighbor 3.3.3.3 (R3) as a peer group member.
(config-router)#address-family ipv4 labeled-unicast	Enter address-family ipv4 labeled-unicast mode
(config-router-af)#neighbor ABC activate	Activate the peer-group ABC for address-family ipv4 labeled-unicast
(config-router-af)#neighbor ABC route-reflector-client	Configure the peer-group ABC to be route-reflector-client
(config-router-af)# exit-address-family	Exit address-family ipv4 labeled-unicast mode
(config-router)#address-family ipv4 unicast	Enter address-family ipv4 unicast mode
(config-router-af)#network 1.1.1.1/32	Advertise the network 1.1.1.1/32
(config-router-af)#network 11.11.11.11/32	Advertise the network 11.11.11.11/32
(config-router-af)# exit-address-family	Exit address-family ipv4 unicast mode
(config-router)#allocate-label all	Allocate labels for all IPv4 prefixes advertised

(config-router)#exit	Exit router bgp mode
(config)#commit	Commit the candidate configuration to the running configuration.

R2

#configure terminal	Enter configure mode.
(config)#router bgp 200	Define the routing process. The number 200 specifies the AS number of R2.
(config-router)#neighbor 2.2.2.1 remote-as 200	Create a TCP connection with neighbor 2.2.2.1 of AS 200.
config-router)#allocate-label all	Allocate labels for all IPv4 prefixes advertised
(config-router)#address-family ipv4 labeled-unicast	Enter address-family ipv4 labeled-unicast mode
(config-router-af)#neighbor 2.2.2.1 activate	Activate the neighbor R1 for address-family ipv4 labeled-unicast
(config-router-af)# exit-address-family	Exit address-family ipv4 labeled-unicast mode
(config-router)# exit	Exit router bgp mode
(config)#commit	Commit the candidate configuration to the running configuration.

R3

#configure terminal	Enter configure mode.
(config)#router bgp 200	Define the routing process. The number 200 specifies the AS number of R3.
(config-router)#neighbor 3.3.3.1 remote-as 200	Create a TCP connection with neighbor 3.3.3.1 of AS 200.
config-router)#allocate-label all	Allocate labels for all IPv4 prefixes advertised
(config-router)#address-family ipv4 labeled-unicast	Enter address-family ipv4 labeled-unicast mode
(config-router-af)#neighbor 3.3.3.1 activate	Activate the neighbor R1 for address-family ipv4 labeled-unicast
(config-router-af)# exit-address-family	Exit address-family ipv4 labeled-unicast mode
(config-router)# exit	Exit router bgp mode
(config)#commit	Commit the candidate configuration to the running configuration.

Validation**R1**

```
R1#show ip bgp labeled-unicast summary
BGP router identifier 10.12.65.126, local AS number 200
BGP table version is 1
1 BGP AS-PATH entries
0 BGP community entries
```

```
Neighbor      V   AS   MsgRcv   MsgSen  TblVer   InQ   OutQ   Up/
Down   State/PfxRcd
```

BGP Labeled Unicast

2.2.2.2	4	200	18	22	1	0	0
00:00:57	0						
3.3.3.3	4	200	18	20	1	0	0
00:00:01	0						

Total number of neighbors 2

Total number of Established sessions 2
R1#

R1#show bgp neighbors

BGP neighbor is 2.2.2.2, remote AS 200, local AS 200, internal link

Member of peer-group ABC for session parameters

BGP version 4, local router ID 10.12.65.126, remote router ID 10.12.65.123

BGP state = Established, up for 00:01:05

Last read 00:00:14, hold time is 90, keepalive interval is 30 seconds

Neighbor capabilities:

Route refresh: advertised and received (old and new)

Address family IPv4 Unicast: advertised and received

Address family IPv4 Labeled-Unicast: advertised and received

Received 16 messages, 2 notifications, 0 in queue

Sent 20 messages, 2 notifications, 0 in queue

Route refresh request: received 0, sent 0

Minimum time between advertisement runs is 5 seconds

For address family: IPv4 Unicast

BGP table version 11, neighbor version 11

Index 0, Offset 0, Mask 0x1

ABC peer-group member

Community attribute sent to this neighbor (both)

0 accepted prefixes

2 announced prefixes

For address family: IPv4 Labeled-Unicast

BGP table version 1, neighbor version 1

Index 2, Offset 0, Mask 0x4

ABC peer-group member

Route-Reflector Client

Community attribute sent to this neighbor (both)

0 accepted prefixes

2 announced prefixes

Connections established 5; dropped 4

Local host: 2.2.2.1, Local port: 51667

Foreign host: 2.2.2.2, Foreign port: 179

Nexthop: 2.2.2.1

Nexthop global: ::

Nexthop local: ::

BGP connection: non shared network

Last Reset: 00:01:10, due to BGP Notification received

Notification Error Message: (Cease/Other Configuration Change.)

BGP neighbor is 3.3.3.3, remote AS 200, local AS 200, internal link

Member of peer-group ABC for session parameters

BGP version 4, local router ID 10.12.65.126, remote router ID 10.12.65.121

BGP state = Established, up for 00:00:09

Last read 00:00:10, hold time is 90, keepalive interval is 30 seconds

```

Neighbor capabilities:
  Route refresh: advertised and received (old and new)
  Address family IPv4 Unicast: advertised and received
  Address family IPv4 Labeled-Unicast: advertised and received
Received 16 messages, 2 notifications, 0 in queue
Sent 20 messages, 2 notifications, 0 in queue
Route refresh request: received 0, sent 0
Minimum time between advertisement runs is 5 seconds
For address family: IPv4 Unicast
  BGP table version 11, neighbor version 11
  Index 1, Offset 0, Mask 0x2
  ABC peer-group member
  Community attribute sent to this neighbor (both)
  0 accepted prefixes
  2 announced prefixes

For address family: IPv4 Labeled-Unicast
  BGP table version 1, neighbor version 1
  Index 3, Offset 0, Mask 0x8
  ABC peer-group member
  Route-Reflector Client
  Community attribute sent to this neighbor (both)
  0 accepted prefixes
  2 announced prefixes

Connections established 5; dropped 4
Local host: 3.3.3.1, Local port: 41732
Foreign host: 3.3.3.3, Foreign port: 179
Nexthop: 3.3.3.1
Nexthop global: ::
Nexthop local: ::
BGP connection: non shared network
Last Reset: 00:00:19, due to BGP Notification received
Notification Error Message: (Cease/Other Configuration Change.)

```

R1#

R2

```

R2#show ip bgp
BGP table version is 3, local router ID is 10.12.65.123
Status codes: s suppressed, d damped, h history, * valid, > best, i -
internal,
                l - labeled, S Stale
Origin codes: i - IGP, e - EGP, ? - incomplete

   Network          Next Hop        Metric      LocPrf      Weight Path
*>i 1.1.1.1/32      2.2.2.1         0           100         0         i
* i                 2.2.2.1         0           100         0         i
*>i 11.11.11.11/32 2.2.2.1         0           100         0         i
* i                 2.2.2.1         0           100         0         i

Total number of prefixes 2
R2#

```

```
R2#show ip bgp 1.1.1.1/32
BGP routing table entry for 1.1.1.1/32
Paths: (2 available, best #1, table Default-IP-Routing-Table)
  Not advertised to any peer
  Local
    2.2.2.1 from 2.2.2.1 (10.12.65.126)
      Origin IGP, metric 0, localpref 100      valid, internal, best, source
safi: 4
      Last update: Tue Aug 25 10:01:05 2020

  Local
    2.2.2.1 from 2.2.2.1 (10.12.65.126)
      Origin IGP, metric 0, localpref 100      valid, internal, source safi: 1
      Last update: Tue Aug 25 10:01:05 2020
```

```
R2#
R2#show ip bgp 11.11.11.11/32
BGP routing table entry for 11.11.11.11/32
Paths: (2 available, best #1, table Default-IP-Routing-Table)
  Not advertised to any peer
  Local
    2.2.2.1 from 2.2.2.1 (10.12.65.126)
      Origin IGP, metric 0, localpref 100      valid, internal, best, source
safi: 4
      Last update: Tue Aug 25 10:01:05 2020

  Local
    2.2.2.1 from 2.2.2.1 (10.12.65.126)
      Origin IGP, metric 0, localpref 100      valid, internal, source safi: 1
      Last update: Tue Aug 25 10:01:05 2020
```

R2#

```
R2#show ip bgp labeled-unicast
```

```
Status codes: s suppressed, d damped, h history, * valid, > best, i -
internal, S - stale
```

Network	Next Hop	In Label	Out Label
*>i 1.1.1.1/32	2.2.2.1	-	24320
*>i 11.11.11.11/32	2.2.2.1	-	24321

R2#

R3

```
R3#show ip bgp labeled-unicast
```

```
Status codes: s suppressed, d damped, h history, * valid, > best, i -
internal, S - stale
```

Network	Next Hop	In Label	Out Label
*>i 1.1.1.1/32	3.3.3.1	-	24320
*>i 11.11.11.11/32	3.3.3.1	-	24321

R3#

Peer group members inherit the properties of Outbound Policies configured for Peer-group under Address-family ipv4 Labeled-Unicast

R1

#configure terminal	Enter configure mode.
(config)# ip access-list permit-1	Configure access-list to permit 1.1.1.1/32
(config-ip-acl)# permit any 1.1.1.1/32 any	Configure a permit statement in the acl to permit 1.1.1.1/32
(config-ip-acl)#exit	Exit ip access-list mode
(config)# route-map permit-only-1	Configure route-map
(config-route-map)# match ip address permit-1	Configure a match statement in the route-map to match the access-list permit-1
(config-route-map)#exit	Exit route-map mode
(config)#commit	Commit the candidate configuration to the running configuration.
(config)#router bgp 200	Define the routing process. The number 200 specifies the AS number of R1.
(config-router)#no allocate-label all	Unconfiguring allocate label all
(config-router)# allocate-label route-map permit-only-1	Allocate labels to the route map
(config-router)#address-family ipv4 labeled-unicast	Enter address-family ipv4 labeled-unicast mode
(config-router-af)# neighbor ABC route-map permit-only-1 out	Configure the peer-group ABC with route-map in the outbound direction
(config-router-af)#exit	Exit address-family mode
(config-router)#exit	Exit router bgp mode
(config)# exit	Exit configure terminal mode
(config)#commit	Commit the candidate configuration to the running configuration.
#clear ip bgp peer-group ABC ipv4 labeled-unicast soft out	Do outbound soft reset for the peer-group ABC for the policy to take affect for the labelled-unicast peer-group members

Validation

R1

```
R1#show bgp neighbors
BGP neighbor is 2.2.2.2, remote AS 200, local AS 200, internal link
Member of peer-group ABC for session parameters
  BGP version 4, local router ID 10.12.65.126, remote router ID 10.12.65.123
  BGP state = Established, up for 00:14:24
  Last read 00:00:22, hold time is 90, keepalive interval is 30 seconds
  Neighbor capabilities:
    Route refresh: advertised and received (old and new)
    Address family IPv4 Unicast: advertised and received
    Address family IPv4 Labeled-Unicast: advertised and received
  Received 46 messages, 2 notifications, 0 in queue
  Sent 53 messages, 2 notifications, 0 in queue
  Route refresh request: received 0, sent 0
```

Minimum time between advertisement runs is 5 seconds
For address family: IPv4 Unicast
BGP table version 11, neighbor version 11
Index 0, Offset 0, Mask 0x1
ABC peer-group member
Community attribute sent to this neighbor (both)
0 accepted prefixes
2 announced prefixes

For address family: IPv4 Labeled-Unicast
BGP table version 1, neighbor version 1
Index 2, Offset 0, Mask 0x4
ABC peer-group member
Route-Reflector Client
Community attribute sent to this neighbor (both)
Outbound path policy configured
Route map for outgoing advertisements is *permit-only-1
0 accepted prefixes
1 announced prefixes

Connections established 5; dropped 4
Local host: 2.2.2.1, Local port: 51667
Foreign host: 2.2.2.2, Foreign port: 179
Nexthop: 2.2.2.1
Nexthop global: ::
Nexthop local: ::
BGP connection: non shared network
Last Reset: 00:14:29, due to BGP Notification received
Notification Error Message: (Cease/Other Configuration Change.)

BGP neighbor is 3.3.3.3, remote AS 200, local AS 200, internal link
Member of peer-group ABC for session parameters
BGP version 4, local router ID 10.12.65.126, remote router ID 10.12.65.121
BGP state = Established, up for 00:13:28
Last read 00:00:21, hold time is 90, keepalive interval is 30 seconds
Neighbor capabilities:
Route refresh: advertised and received (old and new)
Address family IPv4 Unicast: advertised and received
Address family IPv4 Labeled-Unicast: advertised and received
Received 47 messages, 2 notifications, 0 in queue
Sent 53 messages, 2 notifications, 0 in queue
Route refresh request: received 0, sent 0
Minimum time between advertisement runs is 5 seconds
For address family: IPv4 Unicast
BGP table version 11, neighbor version 11
Index 1, Offset 0, Mask 0x2
ABC peer-group member
Community attribute sent to this neighbor (both)
0 accepted prefixes
2 announced prefixes

For address family: IPv4 Labeled-Unicast
BGP table version 1, neighbor version 1
Index 3, Offset 0, Mask 0x8
ABC peer-group member
Route-Reflector Client
Community attribute sent to this neighbor (both)

```

Outbound path policy configured
Route map for outgoing advertisements is *permit-only-1
0 accepted prefixes
1 announced prefixes

```

```

Connections established 5; dropped 4
Local host: 3.3.3.1, Local port: 41732
Foreign host: 3.3.3.3, Foreign port: 179
Nexthop: 3.3.3.1
Nexthop global: ::
Nexthop local: ::
BGP connection: non shared network
Last Reset: 00:13:38, due to BGP Notification received
Notification Error Message: (Cease/Other Configuration Change.)

```

R1#

R2

```
R2#show ip bgp labeled-unicast
```

```

Status codes: s suppressed, d damped, h history, * valid, > best, i -
internal, S - stale
      Network          Next Hop          In Label      Out Label
*>i 1.1.1.1/32        2.2.2.1           -             24320
R2#

```

R3

```
R3#show ip bgp labeled-unicast
```

```

Status codes: s suppressed, d damped, h history, * valid, > best, i -
internal, S - stale
      Network          Next Hop          In Label      Out Label
*>i 1.1.1.1/32        3.3.3.1           -             24320
R3#

```

Peer-group-members inherit the properties of Inbound Policies configured for Peer-group under Address-family ipv4 Labeled-Unicast

Follow the configuration of R1,R2,R3 in the previous section with the following configuration

R2

#configure terminal	Enter configure mode.
(config)# interface lo	Enter interface mode for Loopback interface
(config-if)#ip address 100.1.1.1/24 secondary	Configure IP address for Loopback interface
(config-if)#interface eth3	Enter interface mode for interface eth3
(config-if)#ip address 22.1.1.1/24	Configure IP address for interface eth3
(config-if)#exit	Exit interface mode
(config)#router bgp 200	Enter router bgp mode
(config-router)#address-family ipv4 unicast	Enter address-family ipv4 unicast mode

BGP Labeled Unicast

(config-router-af)#network 22.1.1.0/24	Advertise the network of eth3 in BGP
(config-router-af)#network 100.1.1.0/24	Advertise the network of Loopback in BGP
(config-router-af)#exit-address-family	Exit address-family mode
(config-router)#allocate-label all	Allocate labels for all IPv4 prefixes advertised
(config-router)#exit	Exit router bgp mode
(config)#commit	Commit the candidate configuration to the running configuration.

R3

#configure terminal	Enter configure mode.
(config)# interface lo	Enter interface mode for Loopback interface
(config-if)#ip address 100.1.1.2/24 secondary	Configure IP address for Loopback interface
(config-if)#interface eth3	Enter interface mode for interface eth3
(config-if)#ip address 22.1.1.2/24	Configure IP address for interface eth3
(config-if)#exit	Exit interface mode
(config)#router bgp 200	Enter router bgp mode
(config-router)#address-family ipv4 unicast	Enter address-family ipv4 unicast mode
(config-router-af)#network 22.1.1.0/24	Advertise the network of eth3 in BGP
(config-router-af)#network 100.1.1.0/24	Advertise the network of Loopback in BGP
(config-router-af)#exit-address-family	Exit address-family mode
(config-router)#allocate-label all	Allocate labels for all IPv4 prefixes advertised
(config-router)#exit	Exit router bgp mode
(config)#commit	Commit the candidate configuration to the running configuration.

R1

#configure terminal	Enter configure mode.
(config)#ip access-list permit-22	Configure access-list to permit 22.1.1.0/24
(config-ip-acl)# permit any 22.1.1.0/24 any	Configure a permit statement to permit 22.1.1.0/24
(config-ip-acl)#exit	Exit ip access-list mode
(config)#route-map permit-only-22	Configure route-map
(config-route-map)#match ip address permit-22	Configure match statement in route-map to match the access-list permit-22
(config-route-map)#exit	Exit route-map mode
(config)#commit	Commit the candidate configuration to the running configuration.
(config)#router bgp 200	Enter BGP router mode
(config-router)#address-family ipv4 labeled-unicast	Enter the address-family ipv4 labeled-unicast mode
(config-router-af)#neighbor ABC route-map permit-only-22 in	Configure the peer-group ABC with route-map in the inbound direction under address-family ipv4 labeled-unicast

(config-router-af)# neighbor ABC activate	Activate PEER-GROUP in the address family
(config-router-af)#exit-address-family	Exit address-family ipv4 labeled-unicast mode
(config-router)#exit	Exit router bgp mode
(config)# exit	Exit configure terminal mode
(config)#commit	Commit the candidate configuration to the running configuration.
#clear ip bgp peer-group ABC ipv4 labeled-unicast soft in	Do inbound soft reset for the peer-group ABC for the policy to take affect for the labelled-unicast peer-group members

Validation

R1

```
R1#show ip bgp labeled-unicast
```

```
Status codes: s suppressed, d damped, h history, * valid, > best, i -
internal, S - stale
```

Network	Next Hop	In Label	Out Label
*> 1.1.1.1/32	0.0.0.0	24320	-
*> 11.11.11.11/32	0.0.0.0	24321	-
*>i 22.1.1.0/24	3.3.3.3	24322	24320
* i	2.2.2.2	-	24320
*>i 100.1.1.0/24	3.3.3.3	24323	-

```
R1#
```

```
R1#show bgp neighbors
```

```
BGP neighbor is 2.2.2.2, remote AS 200, local AS 200, internal link
Member of peer-group ABC for session parameters
  BGP version 4, local router ID 10.12.65.126, remote router ID 10.12.65.123
  BGP state = Established, up for 00:45:38
  Last read 00:00:03, hold time is 90, keepalive interval is 30 seconds
Neighbor capabilities:
  Route refresh: advertised and received (old and new)
  Address family IPv4 Unicast: advertised and received
  Address family IPv4 Labeled-Unicast: advertised and received
Received 123 messages, 2 notifications, 0 in queue
Sent 126 messages, 2 notifications, 0 in queue
Route refresh request: received 0, sent 0
Minimum time between advertisement runs is 5 seconds
For address family: IPv4 Unicast
  BGP table version 14, neighbor version 14
  Index 0, Offset 0, Mask 0x1
  ABC peer-group member
  Community attribute sent to this neighbor (both)
  2 accepted prefixes
  2 announced prefixes

For address family: IPv4 Labeled-Unicast
  BGP table version 3, neighbor version 3
  Index 2, Offset 0, Mask 0x4
  ABC peer-group member
  Route-Reflector Client
  Community attribute sent to this neighbor (both)
```

```
Inbound path policy configured
Outbound path policy configured
Route map for incoming advertisements is *permit-only-22
Route map for outgoing advertisements is *permit-only-1
1 accepted prefixes
1 announced prefixes
```

```
Connections established 5; dropped 4
Local host: 2.2.2.1, Local port: 51667
Foreign host: 2.2.2.2, Foreign port: 179
Nexthop: 2.2.2.1
Nexthop global: ::
Nexthop local: ::
BGP connection: non shared network
Last Reset: 00:45:43, due to BGP Notification received
Notification Error Message: (Cease/Other Configuration Change.)
```

```
BGP neighbor is 3.3.3.3, remote AS 200, local AS 200, internal link
Member of peer-group ABC for session parameters
BGP version 4, local router ID 10.12.65.126, remote router ID 10.12.65.121
BGP state = Established, up for 00:44:42
Last read 00:00:22, hold time is 90, keepalive interval is 30 seconds
Neighbor capabilities:
  Route refresh: advertised and received (old and new)
  Address family IPv4 Unicast: advertised and received
  Address family IPv4 Labeled-Unicast: advertised and received
Received 124 messages, 2 notifications, 0 in queue
Sent 127 messages, 2 notifications, 0 in queue
Route refresh request: received 0, sent 0
Minimum time between advertisement runs is 5 seconds
For address family: IPv4 Unicast
BGP table version 14, neighbor version 14
Index 1, Offset 0, Mask 0x2
ABC peer-group member
Community attribute sent to this neighbor (both)
2 accepted prefixes
2 announced prefixes
```

```
For address family: IPv4 Labeled-Unicast
BGP table version 3, neighbor version 3
Index 3, Offset 0, Mask 0x8
ABC peer-group member
Route-Reflector Client
Community attribute sent to this neighbor (both)
Inbound path policy configured
Outbound path policy configured
Route map for incoming advertisements is *permit-only-22
Route map for outgoing advertisements is *permit-only-1
1 accepted prefixes
1 announced prefixes
```

```
Connections established 5; dropped 4
Local host: 3.3.3.1, Local port: 41732
Foreign host: 3.3.3.3, Foreign port: 179
Nexthop: 3.3.3.1
Nexthop global: ::
Nexthop local: ::
```

BGP connection: non shared network
Last Reset: 00:44:52, due to BGP Notification received
Notification Error Message: (Cease/Other Configuration Change.)

R1#

CHAPTER 5 BGP MPLS Next Hop Tracking Configuration

MPLS nexthop tracking is used to track the registered next-hop in the NSM. It helps to notify the client when the LSP operational status changes, so that clients can take action accordingly.

BGP shall do lookup with NSM for LSP reachability, if lookup is successful, BGP marks the nexthop as reachable and register with NSM for the LSP tracking. Further proceeds for FTN/ILM installation and route advertisement. If it is down or does not exist, BGP will mark it as in-valid, route advertisement will not happen until LSP is reachable, BGP query NSM for every rib scan.

Note: QOS should be enabled in all devices for this feature.

Topology

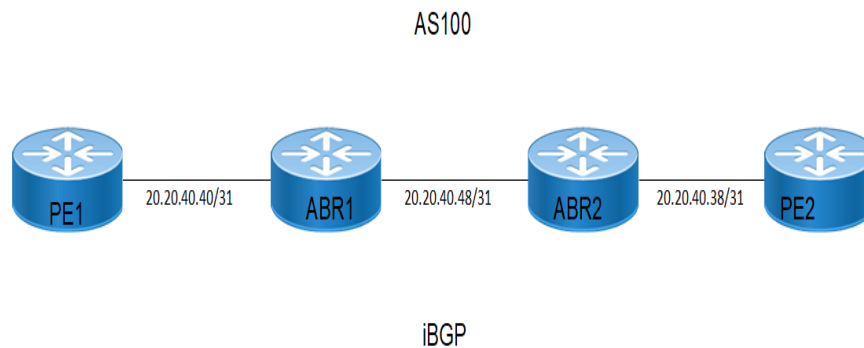

Figure 5-57: BGP MPLS Next Hop Tracking

Configuration

PE1

#configure terminal	Enter the Configure mode.
(config)#interface lo	Enter interface mode
(config-if)#ip address 1.1.1.1/32 secondary	Configure the IP address of the interface loopback
(config-if)#exit	Exit interface mode
(config)# commit	Committing the configuration to apply in running configuration
(config)# router ldp	Configure Router LDP instance
(config)# commit	Committing the configuration to apply in running configuration
(config)# bfd interval 3 minrx 3 multiplier 3	Configure BFD single-hop sessions timer and reception interval in millisecond and the Hello multiplier.
(config)# commit	Committing the configuration to apply in running configuration
(config)#interface xe4	Enter interface mode
(config-if)#ip address 20.20.40.40/31	Configure the IP address on the interface
(config-if)#label-switching	Enable label-switching on interface

BGP MPLS Next Hop Tracking Configuration

(config-if)# enable-ldp ipv4	Enable LDP process on interface
(config-if)#exit	Exit interface mode.
(config)# commit	Committing the configuration to apply in running configuration
(config)#router ospf 1	Configure the routing process OSPF with process id
(config-router)# bfd all-interfaces	Enable BFD for all neighbors.
(config-router)#network 1.1.1.1/32 area 0	Define the interface on which OSPF runs, and associate the area ID (0) with the interface (area ID 0 specifies the backbone area).
(config-router)#network 20.20.40.40/31 area 0	Define the interface on which OSPF runs, and associate the area ID (0) with the interface (area ID 0 specifies the backbone area).
(config-router)#exit	Exit from router ospf mode
(config)# commit	Committing the configuration to apply in running configuration
(config)#bgp nexthop-trigger enable	Enable Nexthop tracking.
(config)# commit	Committing the configuration to apply in running configuration
(config)#router bgp 100	Enter Router BGP mode
(config-router)# mpls-nexthop-tracking	Enable MPLS Next Hop tracking
(config-router)#allocate-label all	Allocate labels for all IPv4 prefixes advertised
(config-router)#neighbor 4.4.4.4 remote-as 100	Add loopback ip of PE2 as neighbor with neighbor AS
(config-router)#neighbor 4.4.4.4 update-source lo	Update the source for that particular neighbor as loopback interface
(config-router)#neighbor 2.2.2.2 remote-as 100	Add loopback ip of ABR1 as neighbor with neighbor AS
(config-router)#neighbor 2.2.2.2 update-source lo	Update the source for that particular neighbor as loopback interface
(config-router)# neighbor 2.2.2.2 fall-over bfd multihop	Enabling BFD at BGP level for particular neighbor.
(config-router)# address-family ipv4 unicast	Enter address-family ipv4 unicast mode
(config-router-af)# network 1.1.1.1/32	Advertise a route via iBGP connection.
(config-router-af)#exit-address-family	Exit from address family IPv4 unicast
(config-router)#address-family ipv4 labeled-unicast	Enter into labeled-unicast address family
(config-router-af)#neighbor 2.2.2.2 activate	Activate the neighbor inside labeled-unicast address family
(config-router-af)#exit-address-family	Exit from address family IPv4 labeled unicast
(config-router)#address-family vpnv4 unicast	Enter into vpnv4 unicast address family
(config-router-af)#neighbor 4.4.4.4 activate	Activate the neighbor inside vpnv4 address family
(config-router-af)#exit-address-family	Exit from address family vpnv4
(config-router)#exit	Exit from router BGP mode
(config)# commit	Committing the configuration to apply in running configuration
(config)#end	Exit from config mode into privilege mode

ABR1

#configure terminal	Enter the Configure mode.
(config)#interface lo	Enter interface mode
(config-if)#ip address 2.2.2.2/32 Secondary	Configure the IP address of the interface loopback
(config-if)#exit	Exit interface mode
(config)# commit	Committing the configuration to apply in running configuration
(config)# router ldp	Configure Router LDP instance
(config)# commit	Committing the configuration to apply in running configuration
(config)# bfd interval 3 minrx 3 multiplier 3	Configure BFD single-hop sessions timer and reception interval in millisecond and the Hello multiplier.
(config)# commit	Committing the configuration to apply in running configuration
(config)#interface xe4	Enter interface mode
(config-if)#ip address 20.20.40.41/31	Configure the IP address on the interface
(config-if)#label-switching	Enable label-switching on interface
(config-if)# enable-ldp ipv4	Enable LDP process on interface
(config-if)#exit	Exit interface mode.
(config)#interface xe10	Enter interface mode
(config-if)#ip address 20.20.40.48/31	Configure the IP address on the interface
(config-if)#label-switching	Enable label-switching on interface
(config-if)# enable-ldp ipv4	Enable LDP process on interface
(config-if)#exit	Exit interface mode.
(config)# commit	Committing the configuration to apply in running configuration
(config)# enable ext-ospf-multi-inst	Enable multiple-instance capability.
(config)# commit	Committing the configuration to apply in running configuration
(config)#router ospf 1	Configure the routing process OSPF with process id
(config)# bfd all-interfaces	Enable BFD for all neighbors.
(config-router)#network 2.2.2.2/32 area 0	Define the interface on which OSPF runs, and associate the area ID (0) with the interface (area ID 0 specifies the backbone area).
(config-router)#network 20.20.40.40/31 area 0	Define the interface on which OSPF runs, and associate the area ID (0) with the interface (area ID 0 specifies the backbone area).
(config-router)#exit	Exit from router ospf mode
(config)#router ospf 2	Configure the routing process OSPF with process id
(config)# bfd all-interfaces	Enable BFD for all neighbors.
(config)# redistribute connected	Redistribute connected routes.
(config-router)#network 2.2.2.2/32 area 0 instance-id 2	Advertise the network in Area 0 with an instance ID of 2.
(config-router)#network 20.20.40.48/31 area 0	Define the interface on which OSPF runs, and associate the area ID (0) with the interface (area ID 0 specifies the backbone area).
(config-router)#exit	Exit from router ospf mode
(config)# commit	Committing the configuration to apply in running configuration

BGP MPLS Next Hop Tracking Configuration

(config)#bgp nexthop-trigger enable	Enable Nexthop tracking.
(config)# commit	Committing the configuration to apply in running configuration
(config)#router bgp 100	Enter Router BGP mode
(config-router)# mpls-nexthop-tracking	Enable MPLS Next Hop tracking
(config-router)#allocate-label all	Allocate labels for all IPv4 prefixes advertised
(config-router)#neighbor 1.1.1.1 remote-as 100	Add loopback ip of PE1 as neighbor with neighbor AS
(config-router)#neighbor 1.1.1.1 update-source lo	Update the source for that particular neighbor as loopback interface
(config-router)# neighbor 1.1.1.1 fall-over bfd multihop	Enabling BFD at BGP level for particular neighbor.
(config-router)#neighbor 3.3.3.3 remote-as 100	Add loopback ip of ABR2 as neighbor with neighbor AS
(config-router)#neighbor 3.3.3.3 update-source lo	Update the source for that particular neighbor as loopback interface
(config-router)# neighbor 3.3.3.3 fall-over bfd multihop	Enabling BFD at BGP level for particular neighbor.
(config-router)# address-family ipv4 unicast	Enter address-family ipv4 unicast mode
(config-router-af)# network 2.2.2.2/32	Advertise a route via iBGP connection.
(config-router-af)#exit-address-family	Exit from address family IPv4 unicast
(config-router)#address-family ipv4 labeled-unicast	Enter into labeled-unicast address family
(config-router-af)#neighbor 1.1.1.1 activate	Activate the neighbor inside labeled-unicast address family
(config-router-af)# neighbor 1.1.1.1 route-reflector-client	Configure the router as Route-reflector (RR) and Neighbor router as its client.
(config-router-af)# neighbor 1.1.1.1 next-hop-self	Enable next hop self for the particular neighbor inside address family IPv4 labeled unicast.
(config-router-af)#neighbor 3.3.3.3 activate	Activate the neighbor inside labeled-unicast address family
(config-router-af)# neighbor 3.3.3.3 route-reflector-client	Configure the router as Route-reflector (RR) and Neighbor router as its client.
(config-router-af)# neighbor 3.3.3.3 next-hop-self	Enable next hop self for the particular neighbor inside address family IPv4 labeled unicast.
(config-router-af)#exit-address-family	Exit from address family IPv4 labeled unicast
(config-router)#exit	Exit from router BGP mode
(config)# commit	Committing the configuration to apply in running configuration
(config)#end	Exit from config mode into privilege mode

ABR2

#configure terminal	Enter the Configure mode.
(config)#interface lo	Enter interface mode
(config-if)#ip address 3.3.3.3/32	Configure the IP address of the interface loopback
(config-if)#exit	Exit interface mode
(config)# commit	Committing the configuration to apply in running configuration
(config)# router ldp	Configure Router LDP instance

(config)# commit	Committing the configuration to apply in running configuration
(config)# bfd interval 3 minrx 3 multiplier 3	Configure BFD single-hop sessions timer and reception interval in millisecond and the Hello multiplier.
(config)# commit	Committing the configuration to apply in running configuration
(config)#interface xe5	Enter interface mode
(config-if)#ip address 20.20.40.38/31	Configure the IP address on the interface
(config-if)#label-switching	Enable label-switching on interface
(config-if)# enable-ldp ipv4	Enable LDP process on interface
(config-if)#exit	Exit interface mode.
(config)#interface xe10	Enter interface mode
(config-if)#ip address 20.20.40.49/31	Configure the IP address on the interface
(config-if)#label-switching	Enable label-switching on interface
(config-if)# enable-ldp ipv4	Enable LDP process on interface
(config-if)#exit	Exit interface mode.
(config)# commit	Committing the configuration to apply in running configuration
(config)# enable ext-ospf-multi-inst	Enable multiple-instance capability.
(config)# commit	Committing the configuration to apply in running configuration
(config)#router ospf 2	Configure the routing process OSPF with process id
(config)# bfd all-interfaces	Enable BFD for all neighbors.
(config)# redistribute connected	Redistribute connected routes.
(config-router)#network 3.3.3.3/32 area 0	Define the interface on which OSPF runs, and associate the area ID (0) with the interface (area ID 0 specifies the backbone area).
(config-router)#network 20.20.40.48/31 area 0	Define the interface on which OSPF runs, and associate the area ID (0) with the interface (area ID 0 specifies the backbone area).
(config-router)#exit	Exit from router ospf mode
(config)#router ospf 3	Configure the routing process OSPF with process id
(config)# bfd all-interfaces	Enable BFD for all neighbors.
(config-router)#network 2.2.2.2/32 area 0 instance-id 3	Advertise the network in Area 0 with an instance ID of 2.
(config-router)#network 20.20.40.38/31 area 0	Define the interface on which OSPF runs, and associate the area ID (0) with the interface (area ID 0 specifies the backbone area).
(config-router)#exit	Exit from router ospf mode
(config)# commit	Committing the configuration to apply in running configuration
(config)#bgp nexthop-trigger enable	Enable Nexthop tracking.
(config)# commit	Committing the configuration to apply in running configuration
(config)#router bgp 100	Enter Router BGP mode
(config-router)# mpls-nexthop-tracking	Enable MPLS Next Hop tracking
(config-router)#allocate-label all	Allocate labels for all IPv4 prefixes advertised
(config-router)#neighbor 4.4.4.4 remote-as 100	Add loopback ip of PE2 as neighbor with neighbor AS

BGP MPLS Next Hop Tracking Configuration

(config-router)#neighbor 4.4.4.4 update-source lo	Update the source for that particular neighbor as loopback interface
(config-router)# neighbor 4.4.4.4 fall-over bfd multihop	Enabling BFD at BGP level for particular neighbor.
(config-router)#neighbor 2.2.2.2 remote-as 100	Add loopback ip of ABR1 as neighbor with neighbor AS
(config-router)#neighbor 2.2.2.2 update-source lo	Update the source for that particular neighbor as loopback interface
(config-router)# neighbor 2.2.2.2 fall-over bfd multihop	Enabling BFD at BGP level for particular neighbor.
(config-router)# address-family ipv4 unicast	Enter address-family ipv4 unicast mode
(config-router-af)# network 2.2.2.2/32	Advertise a route via iBGP connection.
(config-router-af)#exit-address-family	Exit from address family IPv4 unicast
(config-router)#address-family ipv4 labeled-unicast	Enter into labeled-unicast address family
(config-router-af)#neighbor 2.2.2.2 activate	Activate the neighbor inside labeled-unicast address family
(config-router-af)# neighbor 2.2.2.2 route-reflector-client	Configure the router as Route-reflector (RR) and Neighbor router as its client.
(config-router-af)# neighbor 2.2.2.2 next-hop-self	Enable next hop self for the particular neighbor inside address family IPv4 labeled unicast.
(config-router-af)#neighbor 4.4.4.4 activate	Activate the neighbor inside labeled-unicast address family
(config-router-af)# neighbor 4.4.4.4 route-reflector-client	Configure the router as Route-reflector (RR) and Neighbor router as its client.
(config-router-af)# neighbor 4.4.4.4 next-hop-self	Enable next hop self for the particular neighbor inside address family IPv4 labeled unicast.
(config-router-af)#exit-address-family	Exit from address family IPv4 labeled unicast
(config-router)#exit	Exit from router BGP mode
(config)# commit	Committing the configuration to apply in running configuration
(config)#end	Exit from config mode into privilege mode

PE2

#configure terminal	Enter the Configure mode.
(config)#interface lo	Enter interface mode
(config-if)#ip address 4.4.4.4/32 secondary	Configure the IP address of the interface loopback
(config-if)#exit	Exit interface mode
(config)# commit	Committing the configuration to apply in running configuration
(config)# router ldp	Configure Router LDP instance
(config)# commit	Committing the configuration to apply in running configuration
(config)# bfd interval 3 minrx 3 multiplier 3	Configure BFD single-hop sessions timer and reception interval in millisecond and the Hello multiplier.
(config)# commit	Committing the configuration to apply in running configuration
(config)#interface xe5	Enter interface mode
(config-if)#ip address 20.20.40.39/31	Configure the IP address on the interface
(config-if)#label-switching	Enable label-switching on interface

(config-if)# enable-ldp ipv4	Enable LDP process on interface
(config-if)#exit	Exit interface mode.
(config)# commit	Committing the configuration to apply in running configuration
(config)#router ospf 3	Configure the routing process OSPF with process id
(config)# bfd all-interfaces	Enable BFD for all neighbors.
(config-router)#network 3.3.3.3/32 area 0	Define the interface on which OSPF runs, and associate the area ID (0) with the interface (area ID 0 specifies the backbone area).
(config-router)#network 20.20.40.38/31 area 0	Define the interface on which OSPF runs, and associate the area ID (0) with the interface (area ID 0 specifies the backbone area).
(config-router)#exit	Exit from router ospf mode
(config)# commit	Committing the configuration to apply in running configuration
(config)#bgp nexthop-trigger enable	Enable Nexthop tracking.
(config)# commit	Committing the configuration to apply in running configuration
(config)#router bgp 100	Enter Router BGP mode
(config-router)# mpls-nexthop-tracking	Enable MPLS Next Hop tracking
(config-router)#allocate-label all	Allocate labels for all IPv4 prefixes advertised
(config-router)#neighbor 1.1.1.1 remote-as 100	Add loopback ip of PE1 as neighbor with neighbor AS
(config-router)#neighbor 1.1.1.1 update-source lo	Update the source for that particular neighbor as loopback interface
(config-router)# neighbor 1.1.1.1 fall-over bfd multihop	Enabling BFD at BGP level for particular neighbor.
(config-router)#neighbor 3.3.3.3 remote-as 100	Add loopback ip of ABR2 as neighbor with neighbor AS
(config-router)#neighbor 3.3.3.3 update-source lo	Update the source for that particular neighbor as loopback interface
(config-router)# neighbor 3.3.3.3 fall-over bfd multihop	Enabling BFD at BGP level for particular neighbor.
(config-router)# address-family ipv4 unicast	Enter address-family ipv4 unicast mode
(config-router-af)# network 4.4.4.4/32	Advertise a route via iBGP connection.
(config-router-af)#exit-address-family	Exit from address family IPv4 unicast
(config-router)#address-family ipv4 labeled-unicast	Enter into labeled-unicast address family
(config-router-af)#neighbor 3.3.3.3 activate	Activate the neighbor inside labeled-unicast address family
(config-router-af)#exit-address-family	Exit from address family IPv4 labeled unicast
(config-router)#address-family vpv4 unicast	Enter into vpv4 unicast address family
(config-router-af)#neighbor 1.1.1.1 activate	Activate the neighbor inside vpv4 address family
(config-router-af)#exit-address-family	Exit from address family vpv4
(config-router)#exit	Exit from router BGP mode
(config)# commit	Committing the configuration to apply in running configuration
(config)#end	Exit from config mode into privilege mode

Validation

PE1

```
PE1#show ip bgp labeled-unicast summary
BGP router identifier 1.1.1.1, local AS number 100
BGP table version is 3
1 BGP AS-PATH entries
0 BGP community entries
```

Neighbor	Down	State/PfxRcd	V	AS	MsgRcv	MsgSen	TblVer	InQ	OutQ	Up/
2.2.2.2			4	100	90	89	3	0	0	
00:36:22			3							

Total number of neighbors 1

Total number of Established sessions 1

```
PE1#show bgp nexthop-tracking
Configured NHT: ENABLED
NHT Delay time-interval : 5
Configured MPLS NHT: ENABLED
BGP VRF: (Default) VRF_ID 0
BGP Instance: (Default), AS: 100, router-id 1.1.1.1
NHT is Enabled
Recvd Msg count from RIB: 0
NHT delay-timer remaining seconds: 0
BGP nexthop(s):
 2.2.2.2      Registered (MPLS also Registered)
Total number of IPV4 nexthops : 1
Total number of IPV6 nexthops : 0
```

```
PE1#show ldp session
Peer IP Address      IF Name      My Role      State      KeepAlive      UpTime
2.2.2.2              xe4          Passive      OPERATIONAL 30             00:38:06
```

```
PE1#show ip bgp vpnv4 all summary
BGP router identifier 1.1.1.1, local AS number 100
BGP table version is 1
1 BGP AS-PATH entries
0 BGP community entries
```

Neighbor	Down	State/PfxRcd	V	AS	MsgRcv	MsgSen	TblVer	InQ	OutQ	Up/
4.4.4.4			4	100	92	93	1	0	0	
00:38:49			0							

Total number of neighbors 1

Total number of Established sessions 1

```
PE1#show ip ospf neighbor
```

```
Total number of full neighbors: 1
OSPF process 1 VRF(default):
```

Neighbor ID Instance ID	Pri	State	Dead Time	Address	Interface
2.2.2.2 0	1	Full/Backup	00:00:34	20.20.40.41	xe4

PE1#show ip route

Codes: K - kernel, C - connected, S - static, R - RIP, B - BGP
 O - OSPF, IA - OSPF inter area
 N1 - OSPF NSSA external type 1, N2 - OSPF NSSA external type 2
 E1 - OSPF external type 1, E2 - OSPF external type 2
 i - IS-IS, L1 - IS-IS level-1, L2 - IS-IS level-2,
 ia - IS-IS inter area, E - EVPN,
 v - vrf leaked
 * - candidate default

IP Route Table for VRF "default"

```

C       1.1.1.1/32 is directly connected, lo, 00:59:57
O       2.2.2.2/32 [110/2] via 20.20.40.41, xe4, 00:40:05
B       3.3.3.3/32 [200/0] via 2.2.2.2 (recursive via 20.20.40.41),
00:36:31
B       4.4.4.4/32 [200/0] via 2.2.2.2 (recursive via 20.20.40.41),
00:36:31
C       20.20.40.40/31 is directly connected, xe4, 00:58:24
C       127.0.0.0/8 is directly connected, lo, 01:06:14

```

Gateway of last resort is not set

PE2

```

PE2#show ip bgp labeled-unicast summary
BGP router identifier 4.4.4.4, local AS number 100
BGP table version is 3
1 BGP AS-PATH entries
0 BGP community entries

```

Neighbor Down n State/PfxRcd	V	AS	MsgRcv	MsgSen	TblVer	InQ	OutQ	Up/
3.3.3.3 00:41:58	4	100	103	102	3	0	0	
	3							

Total number of neighbors 1

Total number of Established sessions 1

```

PE2#show bgp nexthop-tracking
Configured NHT: ENABLED
NHT Delay time-interval : 5
Configured MPLS NHT: ENABLED
BGP VRF: (Default) VRF_ID 0
BGP Instance: (Default), AS: 100, router-id 4.4.4.4
NHT is Enabled
Rcvd Msg count from RIB: 0
NHT delay-timer remaining seconds: 0
BGP nexthop(s):
  3.3.3.3      Registered (MPLS also Registered)
Total number of IPV4 nexthops : 1

```

BGP MPLS Next Hop Tracking Configuration

Total number of IPV6 nexthops : 0

PE2#show ldp session

Peer IP Address	IF Name	My Role	State	KeepAlive	UpTime
3.3.3.3	xe5	Active	OPERATIONAL	30	00:42:33

PE2#show bgp vpn

PE2#show ip bgp vpnv4 all summary

BGP router identifier 4.4.4.4, local AS number 100

BGP table version is 1

1 BGP AS-PATH entries

0 BGP community entries

Neighbor	V	AS	MsgRcv	MsgSen	TblVer	InQ	OutQ	Up/Dow
1.1.1.1	4	100	99	99	1	0	0	00:41:48

0

Total number of neighbors 1

Total number of Established sessions 1

PE2#show ip ospf neighbor

Total number of full neighbors: 1

OSPF process 3 VRF(default):

Neighbor ID	Pri	State	Dead Time	Address	Interface
3.3.3.3	1	Full/Backup	00:00:35	20.20.40.38	xe5

0

PE2#show ip route

Codes: K - kernel, C - connected, S - static, R - RIP, B - BGP

O - OSPF, IA - OSPF inter area

N1 - OSPF NSSA external type 1, N2 - OSPF NSSA external type 2

E1 - OSPF external type 1, E2 - OSPF external type 2

i - IS-IS, L1 - IS-IS level-1, L2 - IS-IS level-2,

ia - IS-IS inter area, E - EVPN,

v - vrf leaked

* - candidate default

IP Route Table for VRF "default"

B 1.1.1.1/32 [200/0] via 3.3.3.3 (recursive via 20.20.40.38),
00:42:1
7

B 2.2.2.2/32 [200/0] via 3.3.3.3 (recursive via 20.20.40.38),
00:42:1
7

O 3.3.3.3/32 [110/2] via 20.20.40.38, xe5, 00:44:10

C 4.4.4.4/32 is directly connected, lo, 01:05:50

C 20.20.40.38/31 is directly connected, xe5, 01:01:12

C 127.0.0.0/8 is directly connected, lo, 01:11:16

Gateway of last resort is not set

ABR1

ABR1#show ip ospf neighbor

Total number of full neighbors: 1

OSPF process 1 VRF(default):

Neighbor ID Instance ID	Pri	State	Dead Time	Address	Interface
1.1.1.1 0	1	Full/DR	00:00:34	20.20.40.40	xe4

Total number of full neighbors: 1

OSPF process 2 VRF(default):

Neighbor ID Instance ID	Pri	State	Dead Time	Address	Interface
3.3.3.3 0	1	Full/Backup	00:00:37	20.20.40.49	xe10

ABR1#show ldp session

Peer IP Address	IF Name	My Role	State	KeepAlive	UpTime
1.1.1.1	xe4	Active	OPERATIONAL	30	00:46:10
3.3.3.3	xe10	Passive	OPERATIONAL	30	00:43:55

ABR1#sh ip bgp vpnv4 all summary

ABR1#sh ip bgp labeled-unicast summary

BGP router identifier 2.2.2.2, local AS number 100

BGP table version is 2

1 BGP AS-PATH entries

0 BGP community entries

Neighbor Down State/PfxRcd	V	AS	MsgRcv	MsgSen	TblVer	InQ	OutQ	Up/
1.1.1.1 00:46:44	1	4	100	113	113	2	0	0
3.3.3.3 00:45:10	2	4	100	109	111	2	0	0

Total number of neighbors 2

Total number of Established sessions 2

ABR1#show ip route

Codes: K - kernel, C - connected, S - static, R - RIP, B - BGP

O - OSPF, IA - OSPF inter area

N1 - OSPF NSSA external type 1, N2 - OSPF NSSA external type 2

E1 - OSPF external type 1, E2 - OSPF external type 2

i - IS-IS, L1 - IS-IS level-1, L2 - IS-IS level-2,

ia - IS-IS inter area, E - EVPN,

v - vrf leaked

* - candidate default

IP Route Table for VRF "default"

O	1.1.1.1/32 [110/2] via 20.20.40.40, xe4, 00:47:19
C	2.2.2.2/32 is directly connected, lo, 01:07:16
O	3.3.3.3/32 [110/2] via 20.20.40.49, xe10, 00:45:26
B	4.4.4.4/32 [200/0] via 3.3.3.3 (recursive via 20.20.40.49), 00:43:51
O E2	20.20.40.38/31 [110/20] via 20.20.40.49, xe10, 00:45:26
C	20.20.40.40/31 is directly connected, xe4, 00:58:36
C	20.20.40.48/31 is directly connected, xe10, 00:58:23
C	127.0.0.0/8 is directly connected, lo, 01:14:00

Gateway of last resort is not set

BGP MPLS Next Hop Tracking Configuration

```
ABR1#show bgp nexthop-tracking
Configured NHT: ENABLED
NHT Delay time-interval : 5
Configured MPLS NHT: ENABLED
BGP VRF: (Default) VRF_ID 0
BGP Instance: (Default), AS: 100, router-id 2.2.2.2
NHT is Enabled
Recvd Msg count from RIB: 0
NHT delay-timer remaining seconds: 0
BGP nexthop(s):
  1.1.1.1      Registered (MPLS also Registered)
  3.3.3.3      Registered (MPLS also Registered)
Total number of IPV4 nexthops : 2
Total number of IPV6 nexthops : 0
```

ABR2

```
ABR2#show ip ospf neighbor
```

```
Total number of full neighbors: 1
OSPF process 2 VRF(default):
Neighbor ID   Pri  State           Dead Time   Address      Interface
Instance ID
2.2.2.2      1   Full/DR         00:00:37   20.20.40.48 xe10
0
```

```
Total number of full neighbors: 1
OSPF process 3 VRF(default):
Neighbor ID   Pri  State           Dead Time   Address      Interface
Instance ID
4.4.4.4      1   Full/DR         00:00:36   20.20.40.39 xe5
0
```

```
ABR2#
```

```
ABR2#show ldp session
```

Peer IP Address	IF Name	My Role	State	KeepAlive	UpTime
2.2.2.2	xe10	Active	OPERATIONAL	30	00:46:31
4.4.4.4	xe5	Passive	OPERATIONAL	30	00:47:20

```
ABR2#show ip bgp labeled-unicast summary
```

```
BGP router identifier 3.3.3.3, local AS number 100
```

```
BGP table version is 2
```

```
1 BGP AS-PATH entries
```

```
0 BGP community entries
```

Neighbor	V	AS	MsgRcv	MsgSen	TblVer	InQ	OutQ	Up/
Down State/PfxRcd								
2.2.2.2	4	100	115	114	2	0	0	
00:47:21	2							
4.4.4.4	4	100	114	115	2	0	0	
00:47:21	1							

```
Total number of neighbors 2
```

```
Total number of Established sessions 2
```

```
ABR2#show ip route
```

```
Codes: K - kernel, C - connected, S - static, R - RIP, B - BGP
```

```
O - OSPF, IA - OSPF inter area
```

```
N1 - OSPF NSSA external type 1, N2 - OSPF NSSA external type 2
```

E1 - OSPF external type 1, E2 - OSPF external type 2
i - IS-IS, L1 - IS-IS level-1, L2 - IS-IS level-2,
ia - IS-IS inter area, E - EVPN,
v - vrf leaked
* - candidate default

IP Route Table for VRF "default"

```
B      1.1.1.1/32 [200/0] via 2.2.2.2 (recursive via 20.20.40.48),
00:46:06
O      2.2.2.2/32 [110/2] via 20.20.40.48, xe10, 00:47:51
C      3.3.3.3/32 is directly connected, lo, 01:09:37
O      4.4.4.4/32 [110/2] via 20.20.40.39, xe5, 00:47:51
C      20.20.40.38/31 is directly connected, xe5, 00:48:33
O E2   20.20.40.40/31 [110/20] via 20.20.40.48, xe10, 00:47:51
C      20.20.40.48/31 is directly connected, xe10, 00:48:44
C      127.0.0.0/8 is directly connected, lo, 01:15:15
```

Gateway of last resort is not set

ABR2#show bgp nexthop-tracking

Configured NHT: ENABLED

NHT Delay time-interval : 5

Configured MPLS NHT: ENABLED

BGP VRF: (Default) VRF_ID 0

BGP Instance: (Default), AS: 100, router-id 3.3.3.3

NHT is Enabled

Recvd Msg count from RIB: 0

NHT delay-timer remaining seconds: 0

BGP nexthop(s):

2.2.2.2 Registered (MPLS also Registered)

4.4.4.4 Registered (MPLS also Registered)

Total number of IPV4 nexthops : 2

Total number of IPV6 nexthops : 0

Overview

The Border Gateway Protocol (BGP) ADDPATH feature allows the advertisement of multiple paths through the same peering session for a given prefix without the new paths implicitly replacing any previous paths. This behavior promotes path diversity and reduces the severity of a network failure, thereby improving the control plane convergence in case of network failures.

Normal BGP Behavior

By default, all BGP routers and Route-Reflectors propagate only their best paths over their sessions. In case they advertise any route with the same NLRI as a previously advertised route, the latest one implicitly replaces the previous advertisement, which is known as an Implicit Withdraw. The Implicit Withdraw can achieve better scaling, but at the cost of path diversity.

The use of route-reflectors (or confederations), thus has significant effect on redundancy by hiding alternate paths. Using full-mesh is not an option, so a mechanism is needed to allow the propagation of multiple alternate paths in an RR/Confederation environment. Such mechanism is already available in BGP/MPLS VPN scenarios, where multiple point of attachments for CE sites could utilize different RD values to differentiate the same routes advertised from different connection points. However, a generic solution is required, allowing for advertising multiple alternate paths with IPv4 or any other address-family.

The “Advertisement of Multiple Paths in BGP” or “BGP Add-Path” as the feature is usually called is a BGP extension that allows the advertisement of multiple paths for the same address prefix without the new paths implicitly replacing any previously advertised ones.

BGP Behavior with ADDPATH

The advertisement of multiple paths in BGP is made possible by sending a BGP OPEN message to the neighbor with a BGP capability code of 69, which identifies the BGP ADD-PATH Capability.

Address Family Identifier(AFI)	2 octets
Subsequent Address Family Identifier(SAFI)	1 octet
Send/Receive	1 octet

The send/receive field in the BGP Capability TLV indicates whether for a given <AFI, SAFI>, the sender is able to:

- Receive multiple paths from its peer (value 1)
- Send multiple paths to its peer (value 2), or
- both (value 3)
- Each alternate path is identified by a Path Identifier in addition to the address prefix

Path Identifier	4 octets
-----------------	----------

Length	1 octet
Prefix	variable

In the event of a next-hop failure, the BGP Add-Path feature hence improves the BGP control plane convergence

Topology



Figure 6-58: BGPv4 Additional Path Topology

Initial Configuration

R1

#configure terminal	Enter the Configure mode.
(config)#interface eth3	Enter interface mode for interface eth3
(config-if)#ip address 11.1.1.2/24	Configure IP address for the interface eth3
(config-if)#exit	Exit the interface mode
(config)#interface eth4	Enter interface mode for interface eth4
(config-if)#ip address 12.1.1.2/24	Configure IP address for the interface eth4
(config-if)#exit	Exit the interface mode
(config)#interface eth6	Enter interface mode for interface eth6
(config-if)#ip address 13.1.1.2/24	Configure IP address for the interface eth6
(config-if)#exit	Exit the interface mode
(config)#interface eth7	Enter interface mode for interface eth7
(config-if)#ip address 14.1.1.2/24	Configure IP address for the interface eth7
(config-if)#exit	Exit the interface mode
(config)#interface lo	Enter interface mode for loopback lo
(config-if)#ip address 100.1.1.2/24	Configure IP address for Loopback interface lo
(config-if)#exit	Exit the interface mode
(config)#router bgp 200	Enter the router BGP mode
(config-router)#neighbor 11.1.1.1 remote-as 100	Configure the neighbor address and remote-as for the eBGP peer on R2
(config-router)#neighbor 12.1.1.1 remote-as 100	Configure the neighbor address and remote-as for the eBGP peer on R2
(config-router)#neighbor 13.1.1.1 remote-as 100	Configure the neighbor address and remote-as for the eBGP peer on R2

(config-router)#neighbor 14.1.1.1 remote-as 100	Configure the neighbor address and remote-as for the eBGP peer on R2
(config-router)#address-family ipv4 unicast	Configure the address family ipv4 under router BGP
(config-router)#network 100.1.1.0/24	Specify the network to announce via BGP
(config-router-af)#neighbor 11.1.1.1 activate	Activate the IPv4 iBGP neighbors on RR for the IPv4 address family
(config-router-af)#neighbor 12.1.1.1 activate	Activate the IPv4 iBGP neighbors on RR for the IPv4 address family
(config-router-af)#neighbor 13.1.1.1 activate	Activate the IPv4 iBGP neighbors on RR for the IPv4 address family
(config-router-af)#neighbor 14.1.1.1 activate	Activate the IPv4 iBGP neighbors on RR for the IPv4 address family
(config-router-af)#exit-address-family	Exit Address Family mode and return to Router mode.
(config-router)#exit	Exit the router BGP mode and enter the config mode
(config)#commit	Apply commit
(config)#exit	Exit the config mode

R2

#configure terminal	Enter the Configure mode.
(config)#interface eth2	Enter interface mode for interface eth2
(config-if)#ip address 10.1.1.1/24	Configure IP address for the interface eth2
(config-if)#exit	Exit the interface mode
(config)#interface eth3	Enter interface mode for interface eth3
(config-if)#ip address 11.1.1.1/24	Configure IP address for the interface eth3
(config-if)#exit	Exit the interface mode
(config)#interface eth4	Enter interface mode for interface eth4
(config-if)#ip address 12.1.1.1/24	Configure IP address for the interface eth4
(config-if)#exit	Exit the interface mode
(config)#interface eth6	Enter interface mode for interface eth6
(config-if)#ip address 13.1.1.1/24	Configure IP address for the interface eth6
(config-if)#exit	Exit the interface mode
(config)#interface eth7	Enter interface mode for interface eth7
(config-if)#ip address 14.1.1.1/24	Configure IP address for the interface eth7
(config-if)#exit	Exit the interface mode
(config)#interface lo	Enter interface mode for loopback lo
(config-if)#ip address 100.1.1.2/24	Configure IP address for Loopback interface lo
(config-if)#exit	Exit the interface mode
(config)#router bgp 100	Enter the router BGP mode
(config-router)#neighbor 10.1.1.2 remote-as 100	Configure the neighbor address and remote-as for the eBGP peer on R3
(config-router)#neighbor 11.1.1.2 remote-as 200	Configure the neighbor address and remote-as for the eBGP peer on R1

BGP IPv4 Additional Paths Configuration

(config-router)#neighbor 12.1.1.2 remote-as 200	Configure the neighbor address and remote-as for the eBGP peer on R1
(config-router)#neighbor 13.1.1.2 remote-as 200	Configure the neighbor address and remote-as for the eBGP peer on R1
(config-router)#neighbor 14.1.1.2 remote-as 200	Configure the neighbor address and remote-as for the eBGP peer on R1
(config-router)#address-family ipv4 unicast	Configure the address family ipv4 under router BGP
(config-router-af)#neighbor 11.1.1.2 activate	Activate the IPv4 iBGP neighbors on RR for the IPv4 address family
(config-router-af)#neighbor 12.1.1.2 activate	Activate the IPv4 iBGP neighbors on RR for the IPv4 address family
(config-router-af)#neighbor 13.1.1.2 activate	Activate the IPv4 iBGP neighbors on RR for the IPv4 address family
(config-router-af)#neighbor 14.1.1.2 activate	Activate the IPv4 iBGP neighbors on RR for the IPv4 address family
(config-router-af)#exit-address-family	Exit Address Family mode and return to Router mode.
(config-router)#exit	Exit the router BGP mode and enter the config mode
(config)#router ospf 100	Configure an OSPF instance 100
(config-router)#network 10.1.1.0/24 area 0	Configure OSPF network for area 0
(config-router)#redistribute connected	Configure Redistribution of Connected networks into OSPF
(config-router)#exit	Exit the router BGP mode and enter the config mode
(config)#commit	Apply commit
(config)#exit	Exit the config mode

R3

#configure terminal	Enter the Configure mode.
(config)#interface eth1	Enter interface mode for interface eth1
(config-if)#ip address 10.1.1.2/24	Configure IP address for the interface eth1
(config-if)#exit	Exit the interface mode
(config)#interface eth2	Enter interface mode for interface eth2
(config-if)#ip address 21.1.1.1/24	Configure IP address for the interface eth2
(config-if)#exit	Exit the interface mode
(config)#interface eth5	Enter interface mode for interface eth5
(config-if)#ip address 22.1.1.1/24	Configure IP address for the interface eth5
(config-if)#exit	Exit the interface mode
(config)#interface eth6	Enter interface mode for interface eth6
(config-if)#ip address 23.1.1.1/24	Configure IP address for the interface eth6
(config-if)#exit	Exit the interface mode
(config)#interface eth7	Enter interface mode for interface eth7
(config-if)#ip address 24.1.1.1/24	Configure IP address for the interface eth7
(config-if)#exit	Exit the interface mode
(config)#router bgp 100	Enter the router BGP mode

(config-router)#neighbor 21.1.1.2 remote-as 300	Configure the neighbor address and remote-as for the eBGP peer on R4
(config-router)#neighbor 22.1.1.2 remote-as 300	Configure the neighbor address and remote-as for the eBGP peer on R4
(config-router)#neighbor 23.1.1.2 remote-as 300	Configure the neighbor address and remote-as for the eBGP peer on R4
(config-router)#neighbor 24.1.1.2 remote-as 300	Configure the neighbor address and remote-as for the eBGP peer on R4
(config-router)#neighbor 10.1.1.1 remote-as 100	Configure the neighbor address and remote-as for the iBGP peer on R2
(config-router)#address-family ipv4 unicast	Configure the address family ipv4 under router BGP
(config-router-af)#neighbor 21.1.1.2 activate	Activate the IPv4 iBGP neighbors on RR for the IPv4 address family
(config-router-af)#neighbor 22.1.1.2 activate	Activate the IPv4 iBGP neighbors on RR for the IPv4 address family
(config-router-af)#neighbor 23.1.1.2 activate	Activate the IPv4 iBGP neighbors on RR for the IPv4 address family
(config-router-af)#neighbor 24.1.1.2 activate	Activate the IPv4 iBGP neighbors on RR for the IPv4 address family
(config-router-af)#neighbor 10.1.1.1 activate	Activate the IPv4 iBGP neighbors on RR for the IPv4 address family
(config-router-af)#exit-address-family	Exit Address Family mode and return to Router mode.
(config-router)#exit	Exit Router BGP mode
(config)#router ospf 100	Configure an OSPF instance 100
(config-router)#network 10.1.1.0/24 area 0	Configure OSPF network for area 0
(config-router)#redistribute connected	Configure Redistribution of Connected networks into OSPF
(config-router)#exit	Exit the router BGP mode and return to configure mode
(config)#commit	Apply commit
(config)#exit	Exit the configure mode

R4

#configure terminal	Enter the Configure mode.
(config)#interface eth2	Enter interface mode for interface eth2
(config-if)#ip address 21.1.1.2/24	Configure IP address for the interface eth2
(config-if)#exit	Exit the interface mode
(config)#interface eth3	Enter interface mode for interface eth3
(config-if)#ip address 22.1.1.2/24	Configure IP address for the interface eth3
(config-if)#exit	Exit the interface mode
(config)#interface eth4	Enter interface mode for interface eth4
(config-if)#ip address 23.1.1.2/24	Configure IP address for the interface eth4
(config-if)#exit	Exit the interface mode
(config)#interface eth5	Enter interface mode for interface eth5
(config-if)#ip address 24.1.1.2/24	Configure IP address for the interface eth5
(config-if)#exit	Exit the interface mode

BGP IPv4 Additional Paths Configuration

(config)#interface lo	Enter interface mode for loopback lo
(config-if)#ip address 200.1.1.2/24	Configure IP address for Loopback interface lo
(config-if)#exit	Exit the interface mode
(config)#router bgp 300	Enter the router BGP mode
(config-router)#neighbor 21.1.1.1 remote-as 100	Configure the neighbor address and remote-as for the eBGP peer on R3
(config-router)#neighbor 22.1.1.1 remote-as 100	Configure the neighbor address and remote-as for the eBGP peer on R3
(config-router)#neighbor 23.1.1.1 remote-as 100	Configure the neighbor address and remote-as for the eBGP peer on R3
(config-router)#neighbor 24.1.1.1 remote-as 100	Configure the neighbor address and remote-as for the eBGP peer on R3
(config-router)#address-family ipv4 unicast	Configure the address family ipv4 under router BGP
(config-router)#network 200.1.1.0/24	Specify the network to announce via BGP
(config-router-af)#neighbor 21.1.1.1 activate	Activate the IPv4 iBGP neighbors on RR for the IPv4 address family
(config-router-af)#neighbor 22.1.1.1 activate	Activate the IPv4 iBGP neighbors on RR for the IPv4 address family
(config-router-af)#neighbor 23.1.1.1 activate	Activate the IPv4 iBGP neighbors on RR for the IPv4 address family
(config-router-af)#neighbor 24.1.1.1 activate	Activate the IPv4 iBGP neighbors on RR for the IPv4 address family
(config-router-af)#exit-address-family	Exit Address Family mode and return to Router mode.
(config-router)#exit	Exit the router BGP mode and return to configure mode
(config)#commit	Apply commit
(config)#exit	Exit the configure mode

Additional Paths at the AF Level

Configure R2 to Send All Additional Paths and R3 to Receive all Additional Paths

R2

#configure terminal	Enter the Configure mode.
(config)#router bgp 100	Enter BGP router mode
(config-router)#address-family ipv4 unicast	Configure the address family ipv4 under router BGP
(config-router-af)#bgp additional-paths send	Configure R2 to send additional paths to all iBGP neighbors
(config-router-af)#bgp additional-paths select all	Configure R2 to select all available paths to send to all iBGP neighbors
(config-router-af)#exit-address-family	Exit Address Family mode and return to Router mode.
(config-router)#exit	Exit the router BGP mode and return to the configure mode
(config)#commit	Apply commit
(config)#exit	Exit the configure mode

R3

#configure terminal	Enter the Configure mode.
(config)#router bgp 100	Enter BGP router mode
(config-router)#address-family ipv4 unicast	Configure the address family ipv4 under router BGP
(config-router-af)#bgp additional-paths receive	Configure R3 to receive additional paths from all iBGP neighbors
(config-router-af)#exit-address-family	Exit Address Family mode and return to Router mode.
(config-router)#exit	Exit the router BGP mode and return to the configure mode
(config)#commit	Apply commit
(config)#exit	Exit the configure mode

Validation**R2**

```
#show ip bgp neighbors 10.1.1.2
BGP neighbor is 10.1.1.2, remote AS 100, local AS 100, internal link
  BGP version 4, remote router ID 3.3.3.3
  BGP state = Established, up for 00:00:26
  Last read 00:00:26, hold time is 90, keepalive interval is 30 seconds
  Neighbor capabilities:
    Route refresh: advertised and received (old and new)
    Address family IPv4 Unicast: advertised and received
  Received 26 messages, 1 notifications, 0 in queue
  Sent 27 messages, 1 notifications, 0 in queue
  Route refresh request: received 0, sent 0
  Minimum time between advertisement runs is 5 seconds
  For address family: IPv4 Unicast
  BGP table version 17, neighbor version 17
  Index 1, Offset 0, Mask 0x2
  AF-dependant capabilities:
    Add-Path Send Capability : advertised
    Add-Path Receive Capability : received
  Community attribute sent to this neighbor (both)
  1 accepted prefixes
  1 announced prefixes

  Connections established 3; dropped 2
  Local host: 10.1.1.1, Local port: 50428
  Foreign host: 10.1.1.2, Foreign port: 179
  Nexthop: 10.1.1.1
  Nexthop global: ::
  Nexthop local: ::
  BGP connection: non shared network
  Last Reset: 00:00:31, due to BGP Notification received
  Notification Error Message: (Cease/Other Configuration Change.)

#show ip bgp
BGP table version is 21, local router ID is 2.2.2.2
Status codes: s suppressed, d damped, h history, * valid, > best, i -
internal, l - labeled
```

BGP IPv4 Additional Paths Configuration

```

                S Stale
Origin codes: i - IGP, e - EGP, ? - incomplete

   Network          Next Hop           Metric      LocPrf Weight Path
*>  100.1.1.0/24    11.1.1.2             0           100      0      200 i
*   12.1.1.2       12.1.1.2             0           100      0      200 i
*   13.1.1.2       13.1.1.2             0           100      0      200 i
*   14.1.1.2       14.1.1.2             0           100      0      200 i
*>i 200.1.1.0      21.1.1.2             0           100      0      300 i

```

Total number of prefixes 2

```

#show ip bgp 100.1.1.0
BGP routing table entry for 100.1.1.0/24
Paths: (4 available, best #1, table Default-IP-Routing-Table)
  Advertised to non peer-group peers:
    12.1.1.2 13.1.1.2 14.1.1.2
  200
    11.1.1.2 from 11.1.1.2 (1.1.1.1)
      Origin IGP, metric 0, localpref 100, valid, external, best
      rx path_id: -1      tx path_id: 0
      Advertised to non peer-group peers:
        10.1.1.2
      Last update: Fri Jan  6 06:02:02 2017

  200
    12.1.1.2 from 12.1.1.2 (1.1.1.1)
      Origin IGP, metric 0, localpref 100, valid, external
      rx path_id: -1      tx path_id: 1
      Advertised to non peer-group peers:
        10.1.1.2
      Last update: Fri Jan  6 06:02:10 2017

  200
    13.1.1.2 from 13.1.1.2 (1.1.1.1)
      Origin IGP, metric 0, localpref 100, valid, external
      rx path_id: -1      tx path_id: 2
      Advertised to non peer-group peers:
        10.1.1.2
      Last update: Fri Jan  6 06:01:48 2017

  200
    14.1.1.2 from 14.1.1.2 (1.1.1.1)
      Origin IGP, metric 0, localpref 100, valid, external
      rx path_id: -1      tx path_id: 3
      Advertised to non peer-group peers:
        10.1.1.2
      Last update: Fri Jan  6 06:01:51 2017

```

R3

```

#show ip bgp neighbors 10.1.1.1
BGP neighbor is 10.1.1.1, remote AS 100, local AS 100, internal link
  BGP version 4, remote router ID 2.2.2.2
  BGP state = Established, up for 00:00:36
  Last read 00:00:36, hold time is 90, keepalive interval is 30 seconds
  Neighbor capabilities:

```



```

Route refresh: advertised and received (old and new)
Address family IPv4 Unicast: advertised and received
Received 167 messages, 12 notifications, 0 in queue
Sent 171 messages, 1 notifications, 0 in queue
Route refresh request: received 0, sent 0
Minimum time between advertisement runs is 5 seconds
For address family: IPv4 Unicast
BGP table version 91, neighbor version 91
Index 1, Offset 0, Mask 0x2
AF-dependant capabilities:
  Add-Path Send Capability : received
  Add-Path Receive Capability : advertised
Community attribute sent to this neighbor (both)
1 accepted prefixes
1 announced prefixes

Connections established 15; dropped 14
Local host: 10.1.1.2, Local port: 179
Foreign host: 10.1.1.1, Foreign port: 50428
Nexthop: 10.1.1.2
Nexthop global: ::
Nexthop local: ::
BGP connection: non shared network
Last Reset: 00:00:36, due to BGP Notification sent
Notification Error Message: (Cease/Other Configuration Change.)

```

```

#show ip bgp
BGP table version is 93, local router ID is 3.3.3.3
Status codes: s suppressed, d damped, h history, * valid, > best, i -
internal, l - labeled
              S Stale
Origin codes: i - IGP, e - EGP, ? - incomplete

```

	Network	Next Hop	Metric	LocPrf	Weight	Path
*>i	100.1.1.0/24	11.1.1.2	0	100	0	200 i
* i		14.1.1.2	0	100	0	200 i
* i		13.1.1.2	0	100	0	200 i
* i		12.1.1.2	0	100	0	200 i
*>	200.1.1.0	21.1.1.2	0	100	0	300 i
*		22.1.1.2	0	100	0	300 i
*		23.1.1.2	0	100	0	300 i
*		24.1.1.2	0	100	0	300 i

Total number of prefixes 2

```

#show ip bgp 100.1.1.0
BGP routing table entry for 100.1.1.0/24
Paths: (4 available, best #1, table Default-IP-Routing-Table)
  Advertised to non peer-group peers:
  21.1.1.2 22.1.1.2 23.1.1.2 24.1.1.2
  200
  11.1.1.2 (metric 20) from 10.1.1.1 (2.2.2.2)
    Origin IGP, metric 0, localpref 100, valid, internal, best
    rx path_id: 0      tx path_id: 0
    Not advertised to any peer
    Last update: Fri Jan  6 06:12:52 2017

```

```
200
 14.1.1.2 (metric 20) from 10.1.1.1 (2.2.2.2)
  Origin IGP, metric 0, localpref 100, valid, internal
  rx path_id: 3      tx path_id: -1
  Not advertised to any peer
  Last update: Fri Jan  6 06:13:03 2017
```

```
200
 13.1.1.2 (metric 20) from 10.1.1.1 (2.2.2.2)
  Origin IGP, metric 0, localpref 100, valid, internal
  rx path_id: 2      tx path_id: -1
  Not advertised to any peer
  Last update: Fri Jan  6 06:13:03 2017
```

```
200
 12.1.1.2 (metric 20) from 10.1.1.1 (2.2.2.2)
  Origin IGP, metric 0, localpref 100, valid, internal
  rx path_id: 1      tx path_id: -1
  Not advertised to any peer
  Last update: Fri Jan  6 06:13:03 2017
```

Configure R2 and R3 to Send and Receive All Additional Paths

R2

#configure terminal	Enter the Configure mode.
(config)#router bgp 100	Enter BGP router mode
(config-router)#address-family ipv4 unicast	Configure the address family ipv4 under router BGP
(config-router-af)#bgp additional-paths send-receive	Configure R2 to send additional paths to and receive additional paths from all iBGP neighbors
(config-router-af)#bgp additional-paths select all	Configure R2 to select all available paths to send to all iBGP neighbors
(config-router)#exit	Exit the router BGP mode and return to the configure mode
(config)#commit	Apply commit
(config)#exit	Exit the configure mode

R3

#configure terminal	Enter the Configure mode.
(config)#router bgp 100	Enter BGP router mode
(config-router)#address-family ipv4 unicast	Configure the address family ipv4 under router BGP
(config-router-af)#bgp additional-paths send-receive	Configure R3 to send additional paths to and receive additional paths from all iBGP neighbors
(config-router-af)#bgp additional-paths select all	Configure R3 to select all available paths to send to all iBGP neighbors
(config-router)#exit	Exit the router BGP mode and return to the configure mode
(config)#commit	Apply commit
(config)#exit	Exit the configure mode

Validation

- Verify that R2 sends all 4 paths to the route 100.1.1.0/24 to R3 and receives all 4 paths to the route 200.1.1.0/24 from R3
- Verify that rx path_ids of all 4 paths to 200.1.1.0/24 received from R3 match the tx path_ids of 200.1.1.0/24 on R3
- Verify that R3 sends all 4 paths to the route 200.1.1.0/24 to R2 and receives all 4 paths to the route 100.1.1.0/24 from R2
- Verify that rx path_ids of all 4 paths to 100.1.1.0/24 received from R3 match the tx path_ids of 100.1.1.0/24 on R3

R2

```
#show ip bgp neighbors 10.1.1.2
BGP neighbor is 10.1.1.2, remote AS 100, local AS 100, internal link
  BGP version 4, remote router ID 3.3.3.3
  BGP state = Established, up for 00:09:32
  Last read 00:09:32, hold time is 90, keepalive interval is 30 seconds
  Neighbor capabilities:
    Route refresh: advertised and received (old and new)
    Address family IPv4 Unicast: advertised and received
  Received 25 messages, 0 notifications, 0 in queue
  Sent 25 messages, 0 notifications, 0 in queue
  Route refresh request: received 0, sent 0
  Minimum time between advertisement runs is 5 seconds
For address family: IPv4 Unicast
  BGP table version 12, neighbor version 12
  Index 1, Offset 0, Mask 0x2
  AF-dependant capabilities:
    Add-Path Send Capability : advertised and received
    Add-Path Receive Capability : advertised and received
  Community attribute sent to this neighbor (both)
  4 accepted prefixes
  4 announced prefixes

  Connections established 1; dropped 0
  Local host: 10.1.1.1, Local port: 179
  Foreign host: 10.1.1.2, Foreign port: 51842
  Nexthop: 10.1.1.1
  Nexthop global: ::
  Nexthop local: ::
  BGP connection: non shared network
```

```
#show ip bgp
BGP table version is 41, local router ID is 2.2.2.2
Status codes: s suppressed, d damped, h history, * valid, > best, i -
internal, l - labeled
          S Stale
Origin codes: i - IGP, e - EGP, ? - incomplete
```

	Network	Next Hop	Metric	LocPrf	Weight	Path
*>	100.1.1.0/24	11.1.1.2	0	100	0	200 i
*		12.1.1.2	0	100	0	200 i
*		13.1.1.2	0	100	0	200 i
*		14.1.1.2	0	100	0	200 i
*>i	200.1.1.0	21.1.1.2	0	100	0	300 i
* i		22.1.1.2	0	100	0	300 i

BGP IPv4 Additional Paths Configuration

```
* i          23.1.1.2          0          100          0          300 i
* i          24.1.1.2          0          100          0          300 i
```

Total number of prefixes 2

```
#show ip bgp 100.1.1.0
```

BGP routing table entry for 100.1.1.0/24

Paths: (4 available, best #1, table Default-IP-Routing-Table)

Advertised to non peer-group peers:

12.1.1.2 13.1.1.2 14.1.1.2

200

11.1.1.2 from 11.1.1.2 (1.1.1.1)

Origin IGP, metric 0, localpref 100, valid, external, best

rx path_id: -1 tx path_id: 0

Advertised to non peer-group peers:

10.1.1.2

Last update: Fri Jan 6 05:36:35 2017

200

12.1.1.2 from 12.1.1.2 (1.1.1.1)

Origin IGP, metric 0, localpref 100, valid, external

rx path_id: -1 tx path_id: 1

Advertised to non peer-group peers:

10.1.1.2

Last update: Fri Jan 6 05:36:40 2017

200

13.1.1.2 from 13.1.1.2 (1.1.1.1)

Origin IGP, metric 0, localpref 100, valid, external

rx path_id: -1 tx path_id: 2

Advertised to non peer-group peers:

10.1.1.2

Last update: Fri Jan 6 05:36:43 2017

200

14.1.1.2 from 14.1.1.2 (1.1.1.1)

Origin IGP, metric 0, localpref 100, valid, external

rx path_id: -1 tx path_id: 3

Advertised to non peer-group peers:

10.1.1.2

Last update: Fri Jan 6 05:36:46 2017

```
#show ip bgp 200.1.1.0
```

BGP routing table entry for 200.1.1.0/24

Paths: (4 available, best #1, table Default-IP-Routing-Table)

Advertised to non peer-group peers:

11.1.1.2 12.1.1.2 13.1.1.2 14.1.1.2

300

21.1.1.2 (metric 20) from 10.1.1.2 (3.3.3.3)

Origin IGP, metric 0, localpref 100, valid, internal, best

rx path_id: 0 tx path_id: 0

Not advertised to any peer

Last update: Fri Jan 6 05:40:21 2017

300

22.1.1.2 (metric 20) from 10.1.1.2 (3.3.3.3)

Origin IGP, metric 0, localpref 100, valid, internal

rx path_id: 1 tx path_id: 1

```
Not advertised to any peer
Last update: Fri Jan 6 05:40:25 2017
```

```
300
```

```
23.1.1.2 (metric 20) from 10.1.1.2 (3.3.3.3)
Origin IGP, metric 0, localpref 100, valid, internal
rx path_id: 2      tx path_id: 2
Not advertised to any peer
Last update: Fri Jan 6 05:40:29 2017
```

```
300
```

```
24.1.1.2 (metric 20) from 10.1.1.2 (3.3.3.3)
Origin IGP, metric 0, localpref 100, valid, internal
rx path_id: 3      tx path_id: 3
Not advertised to any peer
Last update: Fri Jan 6 05:40:29 2017
```

R3

```
#show ip bgp neighbors 10.1.1.1
BGP neighbor is 10.1.1.1, remote AS 100, local AS 100, internal link
BGP version 4, remote router ID 2.2.2.2
BGP state = Established, up for 00:12:40
Last read 00:12:40, hold time is 90, keepalive interval is 30 seconds
Neighbor capabilities:
  Route refresh: advertised and received (old and new)
  Address family IPv4 Unicast: advertised and received
Received 31 messages, 0 notifications, 0 in queue
Sent 31 messages, 0 notifications, 0 in queue
Route refresh request: received 0, sent 0
Minimum time between advertisement runs is 5 seconds
For address family: IPv4 Unicast
BGP table version 17, neighbor version 17
Index 1, Offset 0, Mask 0x2
AF-dependant capabilities:
  Add-Path Send Capability : advertised and received
  Add-Path Receive Capability : advertised and received
Community attribute sent to this neighbor (both)
4 accepted prefixes
4 announced prefixes

Connections established 1; dropped 0
Local host: 10.1.1.2, Local port: 51842
Foreign host: 10.1.1.1, Foreign port: 179
Nexthop: 10.1.1.2
Nexthop global: ::
Nexthop local: ::
BGP connection: non shared network
```

```
#show ip bgp
BGP table version is 42, local router ID is 3.3.3.3
Status codes: s suppressed, d damped, h history, * valid, > best, i -
internal, l - labeled
              S Stale
Origin codes: i - IGP, e - EGP, ? - incomplete
```

Network	Next Hop	Metric	LocPrf	Weight	Path	
*>i 100.1.1.0/24	11.1.1.2	0	100	0	200	i

BGP IPv4 Additional Paths Configuration

```
* i          12.1.1.2          0          100          0          200 i
* i          13.1.1.2          0          100          0          200 i
* i          14.1.1.2          0          100          0          200 i
*> 200.1.1.0  21.1.1.2          0          100          0          300 i
*           22.1.1.2          0          100          0          300 i
*           23.1.1.2          0          100          0          300 i
*           24.1.1.2          0          100          0          300 i
```

Total number of prefixes 2

```
#show ip bgp 100.1.1.0
```

```
BGP routing table entry for 100.1.1.0/24
```

```
Paths: (4 available, best #1, table Default-IP-Routing-Table)
```

```
  Advertised to non peer-group peers:
```

```
  21.1.1.2 22.1.1.2 23.1.1.2 24.1.1.2
```

```
  200
```

```
    11.1.1.2 (metric 20) from 10.1.1.1 (2.2.2.2)
```

```
      Origin IGP, metric 0, localpref 100, valid, internal, best
```

```
      rx path_id: 0      tx path_id: 0
```

```
      Not advertised to any peer
```

```
      Last update: Fri Jan  6 05:36:49 2017
```

```
  200
```

```
    12.1.1.2 (metric 20) from 10.1.1.1 (2.2.2.2)
```

```
      Origin IGP, metric 0, localpref 100, valid, internal
```

```
      rx path_id: 1      tx path_id: 1
```

```
      Not advertised to any peer
```

```
      Last update: Fri Jan  6 05:36:53 2017
```

```
  200
```

```
    13.1.1.2 (metric 20) from 10.1.1.1 (2.2.2.2)
```

```
      Origin IGP, metric 0, localpref 100, valid, internal
```

```
      rx path_id: 2      tx path_id: 2
```

```
      Not advertised to any peer
```

```
      Last update: Fri Jan  6 05:36:57 2017
```

```
  200
```

```
    14.1.1.2 (metric 20) from 10.1.1.1 (2.2.2.2)
```

```
      Origin IGP, metric 0, localpref 100, valid, internal
```

```
      rx path_id: 3      tx path_id: 3
```

```
      Not advertised to any peer
```

```
      Last update: Fri Jan  6 05:37:00 2017
```

```
#show ip bgp 200.1.1.0
```

```
BGP routing table entry for 200.1.1.0/24
```

```
Paths: (4 available, best #1, table Default-IP-Routing-Table)
```

```
  Advertised to non peer-group peers:
```

```
  22.1.1.2 23.1.1.2 24.1.1.2
```

```
  300
```

```
    21.1.1.2 from 21.1.1.2 (4.4.4.4)
```

```
      Origin IGP, metric 0, localpref 100, valid, external, best
```

```
      rx path_id: -1     tx path_id: 0
```

```
      Advertised to non peer-group peers:
```

```
      10.1.1.1
```

```
      Last update: Fri Jan  6 05:40:30 2017
```

```
  300
```

```

22.1.1.2 from 22.1.1.2 (4.4.4.4)
  Origin IGP, metric 0, localpref 100, valid, external
  rx path_id: -1      tx path_id: 1
  Advertised to non peer-group peers:
    10.1.1.1
  Last update: Fri Jan  6 05:40:34 2017

300
23.1.1.2 from 23.1.1.2 (4.4.4.4)
  Origin IGP, metric 0, localpref 100, valid, external
  rx path_id: -1      tx path_id: 2
  Advertised to non peer-group peers:
    10.1.1.1
  Last update: Fri Jan  6 05:40:37 2017

300
24.1.1.2 from 24.1.1.2 (4.4.4.4)
  Origin IGP, metric 0, localpref 100, valid, external
  rx path_id: -1      tx path_id: 3
  Advertised to non peer-group peers:
    10.1.1.1
  Last update: Fri Jan  6 05:40:40 2017

```

Additional Paths at the Neighbor Level

Configure R2 to send all Additional Paths and R3 to receive all Additional Paths

R2

#configure terminal	Enter the Configure mode.
(config)#router bgp 100	Enter BGP router mode
(config-router)#address-family ipv4 unicast	Configure the address family ipv4 under router BGP
(config-router-af)#neighbor 10.1.1.2 additional-paths send	Configure R2 to send additional paths to the iBGP neighbor R3
(config-router-af)#neighbor 10.1.1.2 advertise additional-paths all	Configure R2 to advertise all available paths to the iBGP neighbor R3
(config-router-af)#exit-address-family	Exit Address Family mode and return to Router mode.
(config-router)#exit	Exit the router BGP mode and return to the configure mode
(config)#commit	Apply commit
(config)#exit	Exit the configure mode

R3

#configure terminal	Enter the Configure mode.
(config)#router bgp 100	Enter BGP router mode
(config-router)#address-family ipv4 unicast	Configure the address family ipv4 under router BGP
(config-router-af)#neighbor 10.1.1.1 additional-paths receive	Configure R3 to receive additional paths from the iBGP neighbor R2
(config-router-af)#exit-address-family	Exit Address Family mode and return to Router mode.

BGP IPv4 Additional Paths Configuration

(config-router)#exit	Exit the router BGP mode and return to the configure mode
(config)#commit	Apply commit
(config)#exit	Exit the configure mode

Validation

Verify that R2 sends all 4 paths to the route 100.1.1.0/24 to R3

R2

```
#show ip bgp neighbors 10.1.1.2
BGP neighbor is 10.1.1.2, remote AS 100, local AS 100, internal link
  BGP version 4, remote router ID 3.3.3.3
  BGP state = Established, up for 00:00:26
  Last read 00:00:26, hold time is 90, keepalive interval is 30 seconds
  Neighbor capabilities:
    Route refresh: advertised and received (old and new)
    Address family IPv4 Unicast: advertised and received
  Received 26 messages, 1 notifications, 0 in queue
  Sent 27 messages, 1 notifications, 0 in queue
  Route refresh request: received 0, sent 0
  Minimum time between advertisement runs is 5 seconds
  For address family: IPv4 Unicast
  BGP table version 17, neighbor version 17
  Index 1, Offset 0, Mask 0x2
  AF-dependant capabilities:
    Add-Path Send Capability : advertised
    Add-Path Receive Capability : received
  Community attribute sent to this neighbor (both)
  1 accepted prefixes
  1 announced prefixes

  Connections established 3; dropped 2
  Local host: 10.1.1.1, Local port: 50428
  Foreign host: 10.1.1.2, Foreign port: 179
  Nexthop: 10.1.1.1
  Nexthop global: ::
  Nexthop local: ::
  BGP connection: non shared network
  Last Reset: 00:00:31, due to BGP Notification received
  Notification Error Message: (Cease/Other Configuration Change.)
```

```
#show ip bgp
BGP table version is 21, local router ID is 2.2.2.2
Status codes: s suppressed, d damped, h history, * valid, > best, i -
internal, l - labeled
              S Stale
Origin codes: i - IGP, e - EGP, ? - incomplete
```

	Network	Next Hop	Metric	LocPrf	Weight	Path	
*>	100.1.1.0/24	11.1.1.2	0	100	0	200	i
*		12.1.1.2	0	100	0	200	i
*		13.1.1.2	0	100	0	200	i
*		14.1.1.2	0	100	0	200	i
*>i	200.1.1.0	21.1.1.2	0	100	0	300	i

Total number of prefixes 2

```
#show ip bgp 100.1.1.0
```

```
BGP routing table entry for 100.1.1.0/24
```

```
Paths: (4 available, best #1, table Default-IP-Routing-Table)
```

```
Advertised to non peer-group peers:
```

```
12.1.1.2 13.1.1.2 14.1.1.2
```

```
200
```

```
11.1.1.2 from 11.1.1.2 (1.1.1.1)
```

```
Origin IGP, metric 0, localpref 100, valid, external, best
```

```
rx path_id: -1      tx path_id: 0
```

```
Advertised to non peer-group peers:
```

```
10.1.1.2
```

```
Last update: Fri Jan  6 06:02:02 2017
```

```
200
```

```
12.1.1.2 from 12.1.1.2 (1.1.1.1)
```

```
Origin IGP, metric 0, localpref 100, valid, external
```

```
rx path_id: -1      tx path_id: 1
```

```
Advertised to non peer-group peers:
```

```
10.1.1.2
```

```
Last update: Fri Jan  6 06:02:10 2017
```

```
200
```

```
13.1.1.2 from 13.1.1.2 (1.1.1.1)
```

```
Origin IGP, metric 0, localpref 100, valid, external
```

```
rx path_id: -1      tx path_id: 2
```

```
Advertised to non peer-group peers:
```

```
10.1.1.2
```

```
Last update: Fri Jan  6 06:01:48 2017
```

```
200
```

```
14.1.1.2 from 14.1.1.2 (1.1.1.1)
```

```
Origin IGP, metric 0, localpref 100, valid, external
```

```
rx path_id: -1      tx path_id: 3
```

```
Advertised to non peer-group peers:
```

```
10.1.1.2
```

```
Last update: Fri Jan  6 06:01:51 2017
```

R3

```
#show ip bgp neighbors 10.1.1.1
```

```
BGP neighbor is 10.1.1.1, remote AS 100, local AS 100, internal link
```

```
BGP version 4, remote router ID 2.2.2.2
```

```
BGP state = Established, up for 00:00:36
```

```
Last read 00:00:36, hold time is 90, keepalive interval is 30 seconds
```

```
Neighbor capabilities:
```

```
Route refresh: advertised and received (old and new)
```

```
Address family IPv4 Unicast: advertised and received
```

```
Received 167 messages, 12 notifications, 0 in queue
```

```
Sent 171 messages, 1 notifications, 0 in queue
```

```
Route refresh request: received 0, sent 0
```

```
Minimum time between advertisement runs is 5 seconds
```

```
For address family: IPv4 Unicast
```

```
BGP table version 91, neighbor version 91
```

```
Index 1, Offset 0, Mask 0x2
```

BGP IPv4 Additional Paths Configuration

AF-dependant capabilities:

Add-Path Send Capability : received
Add-Path Receive Capability : advertised
Community attribute sent to this neighbor (both)
1 accepted prefixes
1 announced prefixes

Connections established 15; dropped 14
Local host: 10.1.1.2, Local port: 179
Foreign host: 10.1.1.1, Foreign port: 50428
Nexthop: 10.1.1.2
Nexthop global: ::
Nexthop local: ::
BGP connection: non shared network
Last Reset: 00:00:36, due to BGP Notification sent
Notification Error Message: (Cease/Other Configuration Change.)

#show ip bgp
BGP table version is 93, local router ID is 3.3.3.3
Status codes: s suppressed, d damped, h history, * valid, > best, i -
internal, l - labeled
 S Stale
Origin codes: i - IGP, e - EGP, ? - incomplete

	Network	Next Hop	Metric	LocPrf	Weight	Path	
*>i	100.1.1.0/24	11.1.1.2	0	100	0		200 i
* i		14.1.1.2	0	100	0		200 i
* i		13.1.1.2	0	100	0		200 i
* i		12.1.1.2	0	100	0		200 i
*>	200.1.1.0	21.1.1.2	0	100	0		300 i
*		22.1.1.2	0	100	0		300 i
*		23.1.1.2	0	100	0		300 i
*		24.1.1.2	0	100	0		300 i

Total number of prefixes 2

#show ip bgp 100.1.1.0
BGP routing table entry for 100.1.1.0/24
Paths: (4 available, best #1, table Default-IP-Routing-Table)
Advertised to non peer-group peers:
21.1.1.2 22.1.1.2 23.1.1.2 24.1.1.2
200
11.1.1.2 (metric 20) from 10.1.1.1 (2.2.2.2)
Origin IGP, metric 0, localpref 100, valid, internal, best
rx path_id: 0 tx path_id: 0
Not advertised to any peer
Last update: Fri Jan 6 06:12:52 2017

200
14.1.1.2 (metric 20) from 10.1.1.1 (2.2.2.2)
Origin IGP, metric 0, localpref 100, valid, internal
rx path_id: 3 tx path_id: -1
Not advertised to any peer
Last update: Fri Jan 6 06:13:03 2017

200
13.1.1.2 (metric 20) from 10.1.1.1 (2.2.2.2)

```
Origin IGP, metric 0, localpref 100, valid, internal
rx path_id: 2      tx path_id: -1
Not advertised to any peer
Last update: Fri Jan  6 06:13:03 2017
```

200

```
12.1.1.2 (metric 20) from 10.1.1.1 (2.2.2.2)
Origin IGP, metric 0, localpref 100, valid, internal
rx path_id: 1      tx path_id: -1
Not advertised to any peer
Last update: Fri Jan  6 06:13:03 2017
```

Configure R2 and R3 to Send and Receive all Additional Paths

R2

#configure terminal	Enter the Configure mode.
(config)#router bgp 100	Enter BGP router mode
(config-router)#address-family ipv4 unicast	Configure the address family ipv4 under router BGP
(config-router-af)#neighbor 10.1.1.2 additional-paths send-receive	Configure R2 to send additional paths to and receive additional paths from the iBGP neighbor R3
(config-router-af)#neighbor 10.1.1.2 advertise additional-paths all	Configure R2 to advertise all available paths to the iBGP neighbor R3
(config-router-af)#exit-address-family	Exit Address Family mode and return to Router mode.
(config-router)#exit	Exit the router BGP mode and return to the configure mode
(config)#commit	Apply commit
(config)#exit	Exit the configure mode

R3

#configure terminal	Enter the Configure mode.
(config)#router bgp 100	Enter BGP router mode
(config-router)#address-family ipv4 unicast	Configure the address family ipv4 under router BGP
(config-router-af)#neighbor 10.1.1.1 additional-paths send-receive	Configure R3 to send additional paths to and receive additional paths from the iBGP neighbor R2
(config-router-af)#neighbor 10.1.1.1 advertise additional-paths all	Configure R3 to advertise all available paths to the iBGP neighbor R2
(config-router-af)#exit-address-family	Exit Address Family mode and return to Router mode.
(config-router)#exit	Exit the router BGP mode and return to the configure mode
(config)#commit	Apply commit
(config)#exit	Exit the configure mode

Validation

- Verify that R2 sends all 4 paths to the route 100.1.1.0/24 to R3 and receives all 4 paths to the route 200.1.1.0/24 from R3
- Verify that rx path_ids of all 4 paths to 200.1.1.0/24 received from R3 match the tx path_ids of 200.1.1.0/24 on R3

BGP IPv4 Additional Paths Configuration

- Verify that R3 sends all 4 paths to the route 200.1.1.0/24 to R2 and receives all 4 paths to the route 100.1.1.0/24 from R2
- Verify that rx path_ids of all 4 paths to 100.1.1.0/24 received from R3 match the tx path_ids of 100.1.1.0/24 on R3

R2

```
#show ip bgp neighbors 10.1.1.2
BGP neighbor is 10.1.1.2, remote AS 100, local AS 100, internal link
  BGP version 4, remote router ID 3.3.3.3
  BGP state = Established, up for 00:09:32
  Last read 00:09:32, hold time is 90, keepalive interval is 30 seconds
  Neighbor capabilities:
    Route refresh: advertised and received (old and new)
    Address family IPv4 Unicast: advertised and received
  Received 25 messages, 0 notifications, 0 in queue
  Sent 25 messages, 0 notifications, 0 in queue
  Route refresh request: received 0, sent 0
  Minimum time between advertisement runs is 5 seconds
For address family: IPv4 Unicast
  BGP table version 12, neighbor version 12
  Index 1, Offset 0, Mask 0x2
  AF-dependant capabilities:
    Add-Path Send Capability : advertised and received
    Add-Path Receive Capability : advertised and received
  Community attribute sent to this neighbor (both)
  4 accepted prefixes
  4 announced prefixes
```

```
Connections established 1; dropped 0
Local host: 10.1.1.1, Local port: 179
Foreign host: 10.1.1.2, Foreign port: 51842
Nexthop: 10.1.1.1
Nexthop global: ::
Nexthop local: ::
BGP connection: non shared network
```

```
#show ip bgp
BGP table version is 41, local router ID is 2.2.2.2
Status codes: s suppressed, d damped, h history, * valid, > best, i -
internal, l - labeled
              S Stale
Origin codes: i - IGP, e - EGP, ? - incomplete
```

	Network	Next Hop	Metric	LocPrf	Weight	Path
*>	100.1.1.0/24	11.1.1.2	0	100	0	200 i
*		12.1.1.2	0	100	0	200 i
*		13.1.1.2	0	100	0	200 i
*		14.1.1.2	0	100	0	200 i
*>i	200.1.1.0	21.1.1.2	0	100	0	300 i
* i		22.1.1.2	0	100	0	300 i
* i		23.1.1.2	0	100	0	300 i
* i		24.1.1.2	0	100	0	300 i

```
Total number of prefixes 2
```

```
#show ip bgp 100.1.1.0
BGP routing table entry for 100.1.1.0/24
```

```
Paths: (4 available, best #1, table Default-IP-Routing-Table)
Advertised to non peer-group peers:
12.1.1.2 13.1.1.2 14.1.1.2
200
  11.1.1.2 from 11.1.1.2 (1.1.1.1)
    Origin IGP, metric 0, localpref 100, valid, external, best
    rx path_id: -1      tx path_id: 0
    Advertised to non peer-group peers:
      10.1.1.2
    Last update: Fri Jan  6 05:36:35 2017

200
  12.1.1.2 from 12.1.1.2 (1.1.1.1)
    Origin IGP, metric 0, localpref 100, valid, external
    rx path_id: -1      tx path_id: 1
    Advertised to non peer-group peers:
      10.1.1.2
    Last update: Fri Jan  6 05:36:40 2017

200
  13.1.1.2 from 13.1.1.2 (1.1.1.1)
    Origin IGP, metric 0, localpref 100, valid, external
    rx path_id: -1      tx path_id: 2
    Advertised to non peer-group peers:
      10.1.1.2
    Last update: Fri Jan  6 05:36:43 2017

200
  14.1.1.2 from 14.1.1.2 (1.1.1.1)
    Origin IGP, metric 0, localpref 100, valid, external
    rx path_id: -1      tx path_id: 3
    Advertised to non peer-group peers:
      10.1.1.2
    Last update: Fri Jan  6 05:36:46 2017

#show ip bgp 200.1.1.0
BGP routing table entry for 200.1.1.0/24
Paths: (4 available, best #1, table Default-IP-Routing-Table)
Advertised to non peer-group peers:
11.1.1.2 12.1.1.2 13.1.1.2 14.1.1.2
300
  21.1.1.2 (metric 20) from 10.1.1.2 (3.3.3.3)
    Origin IGP, metric 0, localpref 100, valid, internal, best
    rx path_id: 0      tx path_id: 0
    Not advertised to any peer
    Last update: Fri Jan  6 05:40:21 2017

300
  22.1.1.2 (metric 20) from 10.1.1.2 (3.3.3.3)
    Origin IGP, metric 0, localpref 100, valid, internal
    rx path_id: 1      tx path_id: 1
    Not advertised to any peer
    Last update: Fri Jan  6 05:40:25 2017

300
  23.1.1.2 (metric 20) from 10.1.1.2 (3.3.3.3)
    Origin IGP, metric 0, localpref 100, valid, internal
```

BGP IPv4 Additional Paths Configuration

```
rx path_id: 2      tx path_id: 2
Not advertised to any peer
Last update: Fri Jan 6 05:40:29 2017
```

300

```
24.1.1.2 (metric 20) from 10.1.1.2 (3.3.3.3)
Origin IGP, metric 0, localpref 100, valid, internal
rx path_id: 3      tx path_id: 3
Not advertised to any peer
Last update: Fri Jan 6 05:40:29 2017
```

R3

```
#show ip bgp neighbors 10.1.1.1
BGP neighbor is 10.1.1.1, remote AS 100, local AS 100, internal link
BGP version 4, remote router ID 2.2.2.2
BGP state = Established, up for 00:12:40
Last read 00:12:40, hold time is 90, keepalive interval is 30 seconds
Neighbor capabilities:
  Route refresh: advertised and received (old and new)
  Address family IPv4 Unicast: advertised and received
Received 31 messages, 0 notifications, 0 in queue
Sent 31 messages, 0 notifications, 0 in queue
Route refresh request: received 0, sent 0
Minimum time between advertisement runs is 5 seconds
For address family: IPv4 Unicast
BGP table version 17, neighbor version 17
Index 1, Offset 0, Mask 0x2
AF-dependant capabilities:
  Add-Path Send Capability : advertised and received
  Add-Path Receive Capability : advertised and received
Community attribute sent to this neighbor (both)
4 accepted prefixes
4 announced prefixes

Connections established 1; dropped 0
Local host: 10.1.1.2, Local port: 51842
Foreign host: 10.1.1.1, Foreign port: 179
Nexthop: 10.1.1.2
Nexthop global: ::
Nexthop local: ::
BGP connection: non shared network
#show ip bgp
BGP table version is 42, local router ID is 3.3.3.3
Status codes: s suppressed, d damped, h history, * valid, > best, i -
internal, l - labeled
                S Stale
Origin codes: i - IGP, e - EGP, ? - incomplete
```

	Network	Next Hop	Metric	LocPrf	Weight	Path	
*>i	100.1.1.0/24	11.1.1.2	0	100	0		200 i
* i		12.1.1.2	0	100	0		200 i
* i		13.1.1.2	0	100	0		200 i
* i		14.1.1.2	0	100	0		200 i
*>	200.1.1.0	21.1.1.2	0	100	0		300 i
*		22.1.1.2	0	100	0		300 i
*		23.1.1.2	0	100	0		300 i
*		24.1.1.2	0	100	0		300 i

Total number of prefixes 2

```
#show ip bgp 100.1.1.0
```

```
BGP routing table entry for 100.1.1.0/24
```

```
Paths: (4 available, best #1, table Default-IP-Routing-Table)
```

```
Advertised to non peer-group peers:
```

```
21.1.1.2 22.1.1.2 23.1.1.2 24.1.1.2
```

```
200
```

```
11.1.1.2 (metric 20) from 10.1.1.1 (2.2.2.2)
```

```
Origin IGP, metric 0, localpref 100, valid, internal, best
```

```
rx path_id: 0      tx path_id: 0
```

```
Not advertised to any peer
```

```
Last update: Fri Jan  6 05:36:49 2017
```

```
200
```

```
12.1.1.2 (metric 20) from 10.1.1.1 (2.2.2.2)
```

```
Origin IGP, metric 0, localpref 100, valid, internal
```

```
rx path_id: 1      tx path_id: 1
```

```
Not advertised to any peer
```

```
Last update: Fri Jan  6 05:36:53 2017
```

```
200
```

```
13.1.1.2 (metric 20) from 10.1.1.1 (2.2.2.2)
```

```
Origin IGP, metric 0, localpref 100, valid, internal
```

```
rx path_id: 2      tx path_id: 2
```

```
Not advertised to any peer
```

```
Last update: Fri Jan  6 05:36:57 2017
```

```
200
```

```
14.1.1.2 (metric 20) from 10.1.1.1 (2.2.2.2)
```

```
Origin IGP, metric 0, localpref 100, valid, internal
```

```
rx path_id: 3      tx path_id: 3
```

```
Not advertised to any peer
```

```
Last update: Fri Jan  6 05:37:00 2017
```

```
#show ip bgp 200.1.1.0
```

```
BGP routing table entry for 200.1.1.0/24
```

```
Paths: (4 available, best #1, table Default-IP-Routing-Table)
```

```
Advertised to non peer-group peers:
```

```
22.1.1.2 23.1.1.2 24.1.1.2
```

```
300
```

```
21.1.1.2 from 21.1.1.2 (4.4.4.4)
```

```
Origin IGP, metric 0, localpref 100, valid, external, best
```

```
rx path_id: -1     tx path_id: 0
```

```
Advertised to non peer-group peers:
```

```
10.1.1.1
```

```
Last update: Fri Jan  6 05:40:30 2017
```

```
300
```

```
22.1.1.2 from 22.1.1.2 (4.4.4.4)
```

```
Origin IGP, metric 0, localpref 100, valid, external
```

```
rx path_id: -1     tx path_id: 1
```

```
Advertised to non peer-group peers:
```

```
10.1.1.1
```

```
Last update: Fri Jan  6 05:40:34 2017
```

```

300
 23.1.1.2 from 23.1.1.2 (4.4.4.4)
  Origin IGP, metric 0, localpref 100, valid, external
  rx path_id: -1      tx path_id: 2
  Advertised to non peer-group peers:
  10.1.1.1
  Last update: Fri Jan  6 05:40:37 2017

300
 24.1.1.2 from 24.1.1.2 (4.4.4.4)
  Origin IGP, metric 0, localpref 100, valid, external
  rx path_id: -1      tx path_id: 3
  Advertised to non peer-group peers:
  10.1.1.1
  Last update: Fri Jan  6 05:40:40 2017

```

Additional Path Selection (Best2/Best3)

Selection of additional paths can be done at AF or at NEIGHBOR level. In case of selection configured at both levels, Neighbor level selection takes preference over Global Level selection.

Selection of Best 2 Additional Paths at Global Level

R2

#configure terminal	Enter the Configure mode.
(config)#router bgp 100	Enter BGP router mode
(config-router)#address-family ipv4 unicast	Configure the address family ipv4 under router BGP
(config-router-af)#bgp additional-paths send	Configure R2 to send additional paths to the iBGP neighbor R3
(config-router-af)#bgp additional-paths select best 2	Configure R2 to select best 2 out of all available paths to all iBGP neighbors
(config-router-af)#exit-address-family	Exit Address Family mode and return to Router mode.
(config-router)#exit	Exit the router BGP mode and return to the configure mode
(config)#commit	Apply commit
(config)#exit	Exit the configure mode

Selection of Best 2 Additional Paths at Neighbor Level

R3

#configure terminal	Enter the Configure mode.
(config)#router bgp 100	Enter BGP router mode
(config-router)#address-family ipv4 unicast	Configure the address family ipv4 under router BGP
(config-router-af)#neighbor 10.1.1.2 additional-paths send	Configure R2 to send additional paths to the iBGP neighbor R3
(config-router-af)#neighbor 10.1.1.2 advertise additional-paths best 2	Configure R2 to advertise best 2 out of all available paths to R3

(config-router-af)#exit-address-family	Exit Address Family mode and return to Router mode.
(config-router)#exit	Exit the router BGP mode and return to the configure mode
(config)#commit	Apply commit
(config)#exit	Exit the configure mode

Validation

- Verify that R2 sends only the best 2 paths out of 4 paths available for the route 100.1.1.0/24 to R3.
- Verify on R2 that Transmit path ids(tx path_id) are allocated only for the best 2 paths to 100.1.1.0/24.
- Verify on R2 that paths not selected have a tx path_id of '-1'
- Verify that Receive path ids(rx path_id) on R3 match the tx path_ids on R2

R2

```
#show ip bgp 100.1.1.0
BGP routing table entry for 100.1.1.0/24
Paths: (4 available, best #1, table Default-IP-Routing-Table)
  Advertised to non peer-group peers:
    12.1.1.2 13.1.1.2 14.1.1.2
  200
    11.1.1.2 from 11.1.1.2 (1.1.1.1)
      Origin IGP, metric 0, localpref 100, valid, external, best
      rx path_id: -1      tx path_id: 0
      Advertised to non peer-group peers:
        10.1.1.2
      Last update: Fri Jan  6 06:02:02 2017

  200
    12.1.1.2 from 12.1.1.2 (1.1.1.1)
      Origin IGP, metric 0, localpref 100, valid, external
      rx path_id: -1      tx path_id: 1
      Advertised to non peer-group peers:
        10.1.1.2
      Last update: Fri Jan  6 06:02:10 2017

  200
    13.1.1.2 from 13.1.1.2 (1.1.1.1)
      Origin IGP, metric 0, localpref 100, valid, external
      rx path_id: -1      tx path_id: -1
      Not advertised to any peer
      Last update: Fri Jan  6 06:01:48 2017

  200
    14.1.1.2 from 14.1.1.2 (1.1.1.1)
      Origin IGP, metric 0, localpref 100, valid, external
      rx path_id: -1      tx path_id: -1
      Not advertised to any peer
      Last update: Fri Jan  6 06:01:51 2017
```

R3

```
#show ip bgp
BGP table version is 168, local router ID is 3.3.3.3
```

BGP IPv4 Additional Paths Configuration

Status codes: s suppressed, d damped, h history, * valid, > best, i - internal, l - labeled

S Stale

Origin codes: i - IGP, e - EGP, ? - incomplete

	Network	Next Hop	Metric	LocPrf	Weight	Path	
*>i	100.1.1.0/24	11.1.1.2	0	100	0	0	200 i
* i		12.1.1.2	0	100	0	0	200 i
*>	200.1.1.0	21.1.1.2	0	100	0	0	300 i
*		22.1.1.2	0	100	0	0	300 i
*		23.1.1.2	0	100	0	0	300 i
*		24.1.1.2	0	100	0	0	300 i

Total number of prefixes 2

#show ip bgp 100.1.1.0

BGP routing table entry for 100.1.1.0/24

Paths: (2 available, best #1, table Default-IP-Routing-Table)

Advertised to non peer-group peers:

21.1.1.2 22.1.1.2 23.1.1.2 24.1.1.2

200

11.1.1.2 (metric 20) from 10.1.1.1 (2.2.2.2)

Origin IGP, metric 0, localpref 100, valid, internal, best

rx path_id: 0 tx path_id: 0

Not advertised to any peer

Last update: Fri Jan 6 07:26:06 2017

200

12.1.1.2 (metric 20) from 10.1.1.1 (2.2.2.2)

Origin IGP, metric 0, localpref 100, valid, internal

rx path_id: 1 tx path_id: -1

Not advertised to any peer

Last update: Fri Jan 6 07:27:02 2017

Selection of Best 3 Additional Paths at AF Level

R2

#configure terminal	Enter the Configure mode.
(config)#router bgp 100	Enter BGP router mode
(config-router)#address-family ipv4 unicast	Configure the address family ipv4 under router BGP
(config-router)#bgp additional-paths send	Configure R2 to send additional paths to the iBGP neighbor R3
(config-router)#bgp additional-paths select best 3	Configure R2 to select best 3 out of all available paths to all iBGP neighbors
(config-router-af)#exit-address-family	Exit Address Family mode and return to Router mode.
(config-router)#exit	Exit the router BGP mode and return to the configure mode
(config)#commit	Apply commit
(config)#exit	Exit the configure mode

Selection of Best 3 Additional Paths at Neighbor Level

R2

#configure terminal	Enter the Configure mode.
(config)#router bgp 100	Enter BGP router mode
(config-router)#address-family ipv4 unicast	Configure the address family ipv4 under router BGP
(config-router)#neighbor 10.1.1.2 additional-paths send	Configure R2 to send additional paths to the iBGP neighbor R3
(config-router)#neighbor 10.1.1.2 advertise additional-paths best 3	Configure R2 to advertise best 3 out of all available paths to R3
(config-router-af)#exit-address-family	Exit Address Family mode and return to Router mode.
(config-router)#exit	Exit the router BGP mode and return to the configure mode
(config)#commit	Apply commit
(config)#exit	Exit the configure mode

Validation

- Verify that R2 sends only the best 3 paths out of 4 paths available for the route 100.1.1.0/24 to R3.
- Verify on R2 that Transmit path ids(tx path_id) are allocated only for the best 3 paths to 100.1.1.0/24.
- Verify that paths not selected have a tx path_id of '-1'
- Verify that Receive path ids(rx path_id) on R3 match the tx path_ids on R2

R2

```
#show ip bgp 100.1.1.0
BGP routing table entry for 100.1.1.0/24
Paths: (4 available, best #1, table Default-IP-Routing-Table)
  Advertised to non peer-group peers:
    12.1.1.2 13.1.1.2 14.1.1.2
  200
    11.1.1.2 from 11.1.1.2 (1.1.1.1)
      Origin IGP, metric 0, localpref 100, valid, external, best
      rx path_id: -1      tx path_id: 0
      Advertised to non peer-group peers:
        10.1.1.2
      Last update: Fri Jan  6 06:02:02 2017

  200
    12.1.1.2 from 12.1.1.2 (1.1.1.1)
      Origin IGP, metric 0, localpref 100, valid, external
      rx path_id: -1      tx path_id: 1
      Advertised to non peer-group peers:
        10.1.1.2
      Last update: Fri Jan  6 06:02:10 2017

  200
    13.1.1.2 from 13.1.1.2 (1.1.1.1)
      Origin IGP, metric 0, localpref 100, valid, external
      rx path_id: -1      tx path_id: 2
      Advertised to non peer-group peers:
```

BGP IPv4 Additional Paths Configuration

```
10.1.1.2
Last update: Fri Jan 6 06:01:48 2017

200
14.1.1.2 from 14.1.1.2 (1.1.1.1)
Origin IGP, metric 0, localpref 100, valid, external
rx path_id: -1      tx path_id: -1
Not advertised to any peer
Last update: Fri Jan 6 06:01:51 2017
```

R3

```
#show ip bgp
BGP table version is 170, local router ID is 3.3.3.3
Status codes: s suppressed, d damped, h history, * valid, > best, i -
internal, l - labeled
              S Stale
Origin codes: i - IGP, e - EGP, ? - incomplete
```

	Network	Next Hop	Metric	LocPrf	Weight	Path
*>i	100.1.1.0/24	11.1.1.2	0	100	0	200 i
* i		13.1.1.2	0	100	0	200 i
* i		12.1.1.2	0	100	0	200 i
*>	200.1.1.0	21.1.1.2	0	100	0	300 i
*		22.1.1.2	0	100	0	300 i
*		23.1.1.2	0	100	0	300 i
*		24.1.1.2	0	100	0	300 i

Total number of prefixes 2

```
#show ip bgp 100.1.1.0
BGP routing table entry for 100.1.1.0/24
Paths: (3 available, best #1, table Default-IP-Routing-Table)
Advertised to non peer-group peers:
21.1.1.2 22.1.1.2 23.1.1.2 24.1.1.2
200
11.1.1.2 (metric 20) from 10.1.1.1 (2.2.2.2)
Origin IGP, metric 0, localpref 100, valid, internal, best
rx path_id: 0      tx path_id: 0
Not advertised to any peer
Last update: Fri Jan 6 07:29:38 2017
```

```
200
13.1.1.2 (metric 20) from 10.1.1.1 (2.2.2.2)
Origin IGP, metric 0, localpref 100, valid, internal
rx path_id: 2      tx path_id: -1
Not advertised to any peer
Last update: Fri Jan 6 07:30:05 2017
```

```
200
12.1.1.2 (metric 20) from 10.1.1.1 (2.2.2.2)
Origin IGP, metric 0, localpref 100, valid, internal
rx path_id: 1      tx path_id: -1
Not advertised to any peer
Last update: Fri Jan 6 07:30:05 2017
```

Verify that R2 sends all 4 paths to 100.1.1.0/24 to R3 with the BGP local preference path attribute set to 140

Verify that R2 sends only the best path to 100.1.1.0/24 to R3 with the BGP local preference path attribute set to 110

BGP Additional Paths for VPNv4

Overview

The Border Gateway Protocol (BGP) ADDPATH feature allows the advertisement of multiple paths through the same peering session for a given prefix without the new paths implicitly replacing any previous paths. This behavior promotes path diversity and reduces the severity of a network failure, thereby improving the control plane convergence in case of network failures.

Normal BGP Behavior

By default, all BGP routers and Route-Reflectors propagate only their best paths over their sessions. In case they advertise any route with the same NLRI as a previously advertised route, the latest one implicitly replaces the previous advertisement, which is known as an Implicit Withdraw. The Implicit Withdraw can achieve better scaling, but at the cost of path diversity.

The use of route-reflectors (or confederations), thus has significant effect on redundancy by hiding alternate paths. Using full-mesh is not an option, so a mechanism is needed to allow the propagation of multiple alternate paths in an RR/Confederation environment. Such mechanism is already available in BGP/MPLS VPN scenarios, where multiple point of attachments for CE sites could utilize different RD values to differentiate the same routes advertised from different connection points. However, a generic solution is required, allowing for advertising multiple alternate paths with IPv4 or any other address-family.

The “Advertisement of Multiple Paths in BGP” or “BGP Add-Path” as the feature is usually called is a BGP extension that allows the advertisement of multiple paths for the same address prefix without the new paths implicitly replacing any previously advertised ones.

BGP Behavior with ADDPATH

The advertisement of multiple paths in BGP is made possible by

- Sending a BGP OPEN message to the neighbor with a BGP capability code of 69, which identifies the BGP ADD-PATH Capability.

Address Family Identifier (AFI)	2 octets
Subsequent Address Family Identifier (SAFI)	1 octet
Send/Receive	1 octet

The send/receive field in the BGP Capability TLV indicates whether for a given <AFI, SAFI>, the sender is able to :

- Receive multiple paths from its peer (value 1)
- Send multiple paths to its peer (value 2), or
- both (value 3)
- Each alternate path is identified by a Path Identifier in addition to the address prefix

Path Identifier	4 octets
Length	1 octet
Prefix	variable

In the event of a next-hop failure, the BGP Add-Path feature hence improves the BGP control plane convergence

Topology

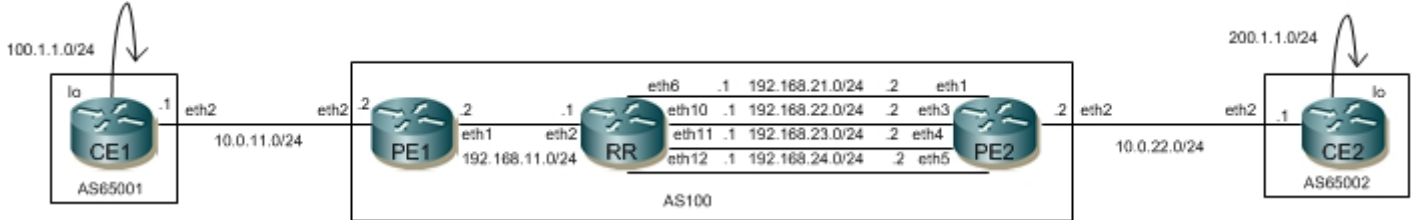

Figure 6-59: BGP Add-Path VPNv4 Topology

Initial Configuration

CE1

#configure terminal	Enter configure mode
(config)#interface eth2	Enter Interface mode for eth2.
(config-if)#ip address 10.0.11.1/24	Assign IP address.
(config-if)#exit	Exit interface mode.
(config)#interface lo	Enter Interface mode for lo.
(config-if)#ip address 100.1.1.2/24	Assign IP address.
(config-if)#exit	Exit interface mode.
(config)#router bgp 65001	Enter BGP router mode.
(config-router)#neighbor 10.0.11.2 remote-as 100	Configure an eBGP neighbor on PE1
(config-router)#network 100.1.1.0/24	Announce the network 100.1.1.0/24 into BGP
(config-router)#address-family ipv4 unicast	Configure the address family ipv4 under router BGP
(config-router-af)#neighbor 10.0.11.2 activate	Activate eBGP neighbor on PE1
(config-router-af)#exit-address-family	Exit Address Family mode and return to Router mode.
(config-router)#exit	Exit Router BGP.
(config)#commit	Apply commit
(config)#exit	Exit Router BGP and Configure mode.

PE1

#configure terminal	Enter configure mode
(config)#ip vrf vrf1	Configure a VRF vrf1
(config-vrf)#rd 100:1	Configure the Route-Distinguisher ie., RD for vrf1
(config-vrf)#route-target both 200:1	Configure the Route-Target ie., RT to import and export the VPNv4 routes
(config-vrf)#exit	Exit the configure VRF mode
(config)#interface eth2	Configure the interface eth2
(config-if)#ip vrf forwarding vrf1	Configure the interface eth2 for IP VRF forwarding for vrf1
(config-if)#ip address 10.0.11.2/24	Configure the IP address for interface eth2

(config-if)#exit	Exit the interface mode for interface eth2
(config)#interface eth1	Configure the interface eth1
(config-if)#ip address 192.168.11.2/24	Configure the IP address for interface eth1
(config-if)#exit	Exit the interface mode for eth1
(config)#router bgp 100	Configure the BGP routing instance 100
(config-router)#neighbor 192.168.11.1 remote-as 100	Configure the neighbor address and remote-as for the 4 iBGP neighbors on RR
(config-router)#address-family vpnv4 unicast	Configure the address family VPNv4 under router BGP
(config-router-af)#neighbor 192.168.11.1 activate	Activate the IPv4 iBGP neighbors on RR for the VPNv4 address family
(config-router-af)#exit-address-family	Exit Address Family mode and return to Router mode.
(config-router)#address-family ipv4 vrf vrf1	Configure the address family IPv4 VRF vrf1 under router BGP
(config-router-af)#neighbor 10.0.11.1 remote-as 65002	Configure the neighbor address and remote-as for the eBGP neighbor on CE1
(config-router-af)#neighbor 10.0.11.1 activate	Activate the eBGP neighbor on CE1 for the address family IPv4 VRF vrf1
(config-router-af)#exit	Exit the router BGP mode and return to the configure terminal mode
(config)#router ospf 100	Configure an OSPF routing instance
(config-router)#network 192.168.11.0/24 area 0	Define the interface eth1 to run OSPF and associate the area ID 0 with interface eth1
(config-router)#exit	Exit the router OSPF mode and return to the configure terminal mode
(config)#router ldp	Enter Router mode for LDP
(config-router)#exit	Exit the Router mode for LDP and return to the configure terminal mode
(config)#interface eth1	Enter interface mode for interface eth1
(config-if)#label-switching	Enable label-switching for interface eth1
(config-if)#enable-ldp ipv4	Enable LDP for IPv4 on interface eth1
(config)#commit	Apply commit
(config)#exit	Exit Router BGP and Configure mode.

RR

#configure terminal	Enter configure mode
(config)#interface eth2	Enter interface mode for interface eth2
(config-if)#ip address 192.168.11.1/24	Configure IP address for the interface eth2
(config-if)#exit	Exit the interface mode for eth2
(config)#interface eth6	Enter interface mode for interface eth6
(config-if)#ip address 192.168.21.1/24	Configure IP address for the interface eth6
(config-if)#exit	Exit the interface mode for eth6
(config)#interface eth10	Enter interface mode for interface eth10
(config-if)#ip address 192.168.22.1/24	Configure IP address for the interface eth10
(config-if)#exit	Exit the interface mode for eth10

BGP IPv4 Additional Paths Configuration

(config)#interface eth11	Enter interface mode for interface eth11
(config-if)#ip address 192.168.23.1/24	Configure IP address for the interface eth11
(config-if)#exit	Exit the interface mode for eth11
(config)#interface eth12	Enter interface mode for interface eth12
(config-if)#ip address 192.168.24.1/24	Configure IP address for the interface eth12
(config-if)#exit	Exit the interface mode for eth12
(config)#router bgp 100	Enter the router BGP mode
(config-router)#neighbor 192.168.11.2 remote-as 100	Configure the neighbor address and remote-as for the iBGP neighbor on PE1
(config-router)#neighbor 192.168.21.2 remote-as 100	Configure the neighbor address and remote-as for the iBGP neighbor on interface eth1 of PE2
(config-router)#neighbor 192.168.22.2 remote-as 100	Configure the neighbor address and remote-as for the iBGP neighbor on interface eth3 of PE2
(config-router)#neighbor 192.168.23.2 remote-as 100	Configure the neighbor address and remote-as for the iBGP neighbor on interface eth4 of PE2
(config-router)#neighbor 192.168.24.2 remote-as 100	Configure the neighbor address and remote-as for the iBGP neighbor on interface eth5 of PE2
(config-router)#address-family vpnv4 unicast	Configure the address family VPNv4 under router BGP
(config-router-af)#neighbor 192.168.11.2 activate	Activate the IPv4 iBGP neighbor on PE1 for the VPNv4 address family
(config-router-af)#neighbor 192.168.21.2 activate	Activate the IPv4 iBGP neighbor on interface eth1 of PE2 for the VPNv4 address family
(config-router-af)#neighbor 192.168.22.2 activate	Activate the IPv4 iBGP neighbor on interface eth3 of PE2 for the VPNv4 address family
(config-router-af)#neighbor 192.168.23.2 activate	Activate the IPv4 iBGP neighbor on interface eth4 of PE2 for the VPNv4 address family
(config-router-af)#neighbor 192.168.24.2 activate	Activate the IPv4 iBGP neighbor on interface eth5 of PE2 for the VPNv4 address family
(config-router-af)#neighbor 192.168.11.2 route-reflector-client	Configure the VPNv4 neighbor on PE1 as route-reflector-client
(config-router-af)#neighbor 192.168.21.2 route-reflector-client	Configure the VPNv4 neighbor on interface eth1 of PE2 as route-reflector-client
(config-router-af)#neighbor 192.168.22.2 route-reflector-client	
	Configure the VPNv4 neighbor on interface eth3 of PE2 as route-reflector-client
(config-router-af)#neighbor 192.168.23.2 route-reflector-client	Configure the VPNv4 neighbor on interface eth4 of PE2 as route-reflector-client
(config-router-af)#neighbor 192.168.24.2 route-reflector-client	Configure the VPNv4 neighbor on interface eth5 of PE2 as route-reflector-client
(config-router-af)#exit	Exit the router BGP mode
(config)#router ospf 100	Configure an OSPF instance 100
(config-router)#network 192.168.11.0/24 area 0	Define the interface eth2 connected to PE1 to run OSPF and associate it with the backbone area ID 0
(config-router)#network 192.168.21.0/24 area 0	Define the interface eth6 connected to PE2 to run OSPF and associate it with the backbone area ID 0
(config-router)#network 192.168.22.0/24 area 0	Define the interface eth10 connected to PE2 to run OSPF and associate it with the backbone area ID 0

(config-router)#network 192.168.23.0/24 area 0	Define the interface eth11 connected to PE2 to run OSPF and associate it with the backbone area ID 0
(config-router)#network 192.168.24.0/24 area 0	Define the interface eth12 connected to PE2 to run OSPF and associate it with the backbone area ID 0
(config-router)#exit	Exit the router OSPF mode
(config)#router ldp	Enter Router mode for LDP
(config-router)#exit	Exit the Router mode for LDP
(config)#interface eth1	Enter interface mode for interface eth2
(config-if)#label-switching	Enable label-switching for interface eth2
(config-if)#enable-ldp ipv4	Enable LDP for IPv4 on interface eth2
(config-if)#exit	Exit the interface mode for eth2
(config)#interface eth6	Enter interface mode for interface eth6
(config-if)#label-switching	Enable label-switching for interface eth6
(config-if)#enable-ldp ipv4	Enable LDP for IPv4 on interface eth6
(config-if)#exit	Exit the interface mode for eth6
(config)#interface eth10	Enter interface mode for interface eth10
(config-if)#label-switching	Enable label-switching for interface eth10
(config-if)#enable-ldp ipv4	Enable LDP for IPv4 on interface eth10
(config-if)#exit	Exit the interface mode for eth10
(config)#interface eth11	Enter interface mode for interface eth11
(config-if)#label-switching	Enable label-switching for interface eth11
(config-if)#enable-ldp ipv4	Enable LDP for IPv4 on interface eth11
(config-if)#exit	Exit the interface mode for eth11
(config)#interface eth12	Enter interface mode for interface eth12
(config-if)#label-switching	Enable label-switching for interface eth12
(config-if)#enable-ldp ipv4	Enable LDP for IPv4 on interface eth12
(config)#commit	Apply commit
(config)#exit	exit the global mode

PE2

#configure terminal	Enter configure mode
(config)#ip vrf vrf1	Configure a VRF vrf1
(config-vrf)#rd 100:1	Configure the Route-Distinguisher ie., RD for vrf1
(config-vrf)#route-target both 200:1	Configure the Route-Target ie., RT to import and export the VPNv4 routes
(config-vrf)#exit	Exit the configure VRF mode
(config)#interface eth2	Configure the interface eth2
(config-if)#ip vrf forwarding vrf1	Configure the interface eth2 for IP VRF forwarding for vrf1
(config-if)#ip address 10.0.22.2/24	Configure the IP address for interface eth2
(config-if)#exit	Exit the interface mode for eth2
(config)#interface eth1	Configure the interface eth1

BGP IPv4 Additional Paths Configuration

(config-if)#ip address 192.168.21.2/24	Configure the IP address for interface eth1
(config-if)#exit	Exit the interface mode for eth1
(config)#interface eth3	Configure the interface eth3
(config-if)#ip address 192.168.22.2/24	Configure the IP address for interface eth3
(config-if)#exit	Exit the interface mode for eth3
(config)#interface eth4	Configure the interface eth4
(config-if)#ip address 192.168.23.2/24	Configure the IP address for interface eth4
(config-if)#exit	Exit the interface mode for eth4
(config)#interface eth5	Configure the interface eth5
(config-if)#ip address 192.168.24.2/24	Configure the IP address for interface eth5
(config-if)#exit	Exit the interface mode for eth5
(config)#router bgp 100	Configure the BGP routing instance 100
(config-router)#neighbor 192.168.21.1 remote-as 100	Configure the neighbor address and remote-as for the iBGP neighbor on interface eth6 of PE2
(config-router)#neighbor 192.168.22.1 remote-as 100	Configure the neighbor address and remote-as for the iBGP neighbor on interface eth10 of PE2
(config-router)#neighbor 192.168.23.1 remote-as 100	Configure the neighbor address and remote-as for the iBGP neighbor on interface eth11 of PE2
(config-router)#neighbor 192.168.24.1 remote-as 100	Configure the neighbor address and remote-as for the iBGP neighbor on interface eth12 of PE2
(config-router)#address-family vpnv4 unicast	Configure the address family VPNv4 under router BGP
(config-router-af)#neighbor 192.168.21.1 activate	Activate the IPv4 iBGP neighbor on interface eth6 of PE2 for the VPNv4 address family
(config-router-af)#neighbor 192.168.22.1 activate	Activate the IPv4 iBGP neighbor on interface eth10 of PE2 for the VPNv4 address family
(config-router-af)#neighbor 192.168.23.1 activate	Activate the IPv4 iBGP neighbor on interface eth11 of PE2 for the VPNv4 address family
(config-router-af)#neighbor 192.168.24.1 activate	Activate the IPv4 iBGP neighbor on interface eth12 of PE2 for the VPNv4 address family
(config-router-af)#exit	Exit the router BGP address family VPNv4 mode
(config)#router bgp 100	Enter the router BGP mode
(config-router)#address-family ipv4 vrf vrf1	Configure the address family IPv4 VRF vrf1 under router BGP
(config-router-af)#neighbor 10.0.22.1 remote-as 65002	Configure the neighbor address and remote-as for the eBGP neighbor on CE2
(config-router-af)#neighbor 10.0.22.1 activate	Activate the 4 eBGP neighbor on CE2 for the address family IPv4 VRF vrf1
(config-router-af)#exit-address-family	Exit Address Family mode and return to Router mode.
(config)#router ospf 100	Configure an OSPF instance 100
(config-router)#network 192.168.21.0/24 area 0	Define the interface eth1 connected to PE2 to run OSPF and associate it with the backbone area ID 0
(config-router)#network 192.168.22.0/24 area 0	Define the interface eth3 connected to PE2 to run OSPF and associate it with the backbone area ID 0
(config-router)#network 192.168.23.0/24 area 0	Define the interface eth4 connected to PE2 to run OSPF and associate it with the backbone area ID 0
(config-router)#network 192.168.24.0/24 area 0	Define the interface eth5 connected to PE2 to run OSPF and associate it with the backbone area ID 0

(config-router)#exit	Exit the router OSPF mode
(config)#router ldp	Enter Router mode for LDP
(config-router)#exit	Exit the Router mode for LDP
(config)#interface eth1	Enter interface mode for interface eth1
(config-if)#label-switching	Enable label-switching for interface eth1
(config-if)#enable-ldp ipv4	Enable LDP for IPv4 on interface eth1
(config-if)#exit	Exit the interface mode for eth1
(config)#interface eth3	Enter interface mode for interface eth3
(config-if)#label-switching	Enable label-switching for interface eth3
(config-if)#enable-ldp ipv4	Enable LDP for IPv4 on interface eth3
(config-if)#exit	Exit the interface mode for eth3
(config)#interface eth4	Enter interface mode for interface eth4
(config-if)#label-switching	Enable label-switching for interface eth4
(config-if)#enable-ldp ipv4	Enable LDP for IPv4 on interface eth4
(config-if)#exit	Exit the interface mode for eth4
(config)#interface eth5	Enter interface mode for interface eth5
(config-if)#label-switching	Enable label-switching for interface eth5
(config-if)#enable-ldp ipv4	Enable LDP for IPv4 on interface eth5
(config-if)#exit	Return to the global mode
(config)#commit	Apply commit
(config)#exit	exit the global mode

CE2

#configure terminal	Enter configure mode
(config)#interface eth2	Enter Interface mode for eth2.
(config-if)#ip address 10.0.22.1/24	Assign IP address.
(config-if)#exit	Exit interface mode.
(config)#interface lo	Enter Interface mode for lo.
(config-if)#ip address 200.1.1.2/24	Assign IP address.
(config-if)#exit	Exit interface mode.
(config)#router bgp 65002	Enter BGP router mode.
(config-router)#neighbor 10.0.22.2 remote-as 100	Configure an eBGP neighbor on PE1
(config-router)#address-family ipv4 unicast	Configure the address family ipv4 under router BGP
(config-router-af)#neighbor 10.0.22.2 activate	Activate eBGP neighbor on PE1
(config-router-af)#network 200.1.1.0/24	Announce the network 200.1.1.0/24 into BGP
(config-router-af)#exit-address-family	Exit Address Family mode and return to Router mode.
(config-router)#exit	Exit the router BGP mode and return to the configure mode
(config)#commit	Apply commit
(config)#exit	Exit the configure mode

Additional Paths Capability Send/Receive/Send-Receive and Additional Paths Selection All/Best 2/Best 3

Configure RR to Send All And Pe1 To Receive All Additional Paths at Address Family Vpnv4 Level

RR

#configure terminal	Enter configure mode
(config)#router bgp 100	Enter BGP router mode
(config-router)#address-family vpnv4 unicast	Enter address family VPNv4 unicast mode
(config-router-af)#bgp additional-paths send	Configure RR to send additional paths to all the VPNv4 neighbors
(config-router-af)#bgp additional-paths select all	Configure RR to select all available paths to send to all VPNv4 neighbors
(config-router-af)#exit-address-family	Exit Address Family mode and return to Router mode.
(config-router)#exit	Exit Router BGP and Configure mode.
(config)#commit	Apply commit
(config)#exit	Exit Router BGP and Configure mode.

PE1

#configure terminal	Enter configure mode
(config)#router bgp 100	Enter BGP router mode
(config-router)#address-family vpnv4 unicast	Enter address family VPNv4 unicast mode
(config-router-af)#bgp additional-paths receive	Configure PE1 to receive additional paths from all the VPNv4 neighbors
(config-router-af)#exit-address-family	Exit Address Family mode and return to Router mode.
(config-router)#exit	Exit the router BGP mode and return to the configure mode
(config)#commit	Apply commit
(config)#exit	Exit the configure mode

Configure Rr To Send All and Pe1 To Receive All Additional Paths at Neighbor Level Address Family VPNv4

RR

#configure terminal	Enter configure mode
(config)#router bgp 100	Enter BGP router mode
(config-router)#address-family vpnv4 unicast	Enter address family VPNv4 unicast mode
(config-router-af)#neighbor 192.168.11.2 additional-paths send	Configure RR to send additional paths to the VPNv4 neighbor on PE1
(config-router-af)#neighbor 192.168.11.2 advertise additional-paths all	Configure RR to advertise all available paths to the VPNv4 neighbor on PE1
(config-router-af)#exit-address-family	Exit Address Family mode and return to Router mode.
(config-router)#exit	Exit Router BGP and Configure mode.

(config)#commit	Apply commit
(config)#exit	Exit Router BGP and Configure mode.

PE1

#configure terminal	Enter configure mode
(config)#router bgp 100	Enter BGP router mode
(config-router)#address-family vpnv4 unicast	Enter address family VPNv4 unicast mode
(config-router-af)#neighbor 192.168.11.1 additional-paths receive	Configure PE1 to receive additional paths from RR
(config-router-af)#exit-address-family	Exit Address Family mode and return to Router mode.
(config-router)#exit	Exit Router BGP and Configure mode.
(config)#commit	Apply commit
(config)#exit	Exit Router BGP and Configure mode.

Validation**RR**

```
#show ip bgp neighbors 192.168.11.2
BGP neighbor is 192.168.11.2, remote AS 100, local AS 100, internal link
  BGP version 4, remote router ID 192.168.11.2
  BGP state = Established, up for 00:03:21
  Last read 00:03:21, hold time is 90, keepalive interval is 30 seconds
  Neighbor capabilities:
    Route refresh: advertised and received (old and new)
    Address family IPv4 Unicast: advertised and received
    Address family VPNv4 Unicast: advertised and received
  Received 90 messages, 1 notifications, 0 in queue
  Sent 94 messages, 1 notifications, 0 in queue
  Route refresh request: received 0, sent 0
  Minimum time between advertisement runs is 5 seconds
For address family: IPv4 Unicast
  BGP table version 1, neighbor version 1
  Index 1, Offset 0, Mask 0x2
  Community attribute sent to this neighbor (both)
  0 accepted prefixes
  0 announced prefixes

For address family: VPNv4 Unicast
  BGP table version 49, neighbor version 49
  Index 1, Offset 0, Mask 0x2
  AF-dependant capabilities:
    Add-Path Send Capability : advertised
    Add-Path Receive Capability : received
  Route-Reflector Client
  Community attribute sent to this neighbor (both)
  1 accepted prefixes
  4 announced prefixes

Connections established 3; dropped 2
Local host: 192.168.11.1, Local port: 179
```

BGP IPv4 Additional Paths Configuration

```
Foreign host: 192.168.11.2, Foreign port: 53977
Nexthop: 192.168.11.1
Nexthop global: ::
Nexthop local: ::
BGP connection: non shared network
Last Reset: 00:03:26, due to BGP Notification received
Notification Error Message: (Cease/Other Configuration Change.)
```

```
#show ip bgp vpnv4 all
Status codes: s suppressed, d damped, h history, * valid, > best, i -
internal, l - labeled
              S Stale
Origin codes: i - IGP, e - EGP, ? - incomplete
```

Network	Next Hop	Metric	LocPrf	Weight	Path
Route Distinguisher: 100:1					
*>i 100.1.1.0/24	192.168.11.2	0	100	0	65001
i					
*>i 200.1.1.0	192.168.21.2	0	100	0	65002
i					
* i 200.1.1.0	192.168.22.2	0	100	0	65002
i					
* i 200.1.1.0	192.168.23.2	0	100	0	65002
i					
* i 200.1.1.0	192.168.24.2	0	100	0	65002
i					

Announced routes count = 0
Accepted routes count = 5

```
#show ip bgp vpnv4 all 200.1.1.0
Route Distinguisher: 100:1
  65002, (Received from a RR-client)
    192.168.21.2 from 192.168.21.2 (192.168.24.2)
      Origin IGP, metric 0, localpref 100, label 24320, valid, internal,
best
      Extended Community: RT:200:1
      rx path_id: -1      tx path_id: 0
      Advertised to non peer-group peers:
        192.168.11.2
      Last update: Mon Jan  9 05:27:09 2017
```

```
  65002, (Received from a RR-client)
    192.168.22.2 from 192.168.22.2 (192.168.24.2)
      Origin IGP, metric 0, localpref 100, label 24320, valid, internal
      Extended Community: RT:200:1
      rx path_id: -1      tx path_id: 1
      Advertised to non peer-group peers:
        192.168.11.2
      Last update: Mon Jan  9 05:27:09 2017
```

```
  65002, (Received from a RR-client)
    192.168.23.2 from 192.168.23.2 (192.168.24.2)
      Origin IGP, metric 0, localpref 100, label 24320, valid, internal
      Extended Community: RT:200:1
      rx path_id: -1      tx path_id: 2
      Advertised to non peer-group peers:
        192.168.11.2
      Last update: Mon Jan  9 05:27:09 2017
```

```
65002, (Received from a RR-client)
 192.168.24.2 from 192.168.24.2 (192.168.24.2)
  Origin IGP, metric 0, localpref 100, label      24320, valid, internal
  Extended Community: RT:200:1
  rx path_id: -1      tx path_id: 3
  Advertised to non peer-group peers:
    192.168.11.2
  Last update: Mon Jan  9 05:27:09 2017
```

PE1

```
#show ip bgp neighbors 192.168.11.1
BGP neighbor is 192.168.11.1, remote AS 100, local AS 100, internal link
  BGP version 4, remote router ID 10.12.48.36
  BGP state = Established, up for 00:46:03
  Last read 00:46:03, hold time is 90, keepalive interval is 30 seconds
  Neighbor capabilities:
    Route refresh: advertised and received (old and new)
    Address family IPv4 Unicast: advertised and received
    Address family VPNv4 Unicast: advertised and received
  Received 179 messages, 1 notifications, 0 in queue
  Sent 176 messages, 1 notifications, 0 in queue
  Route refresh request: received 0, sent 0
  Minimum time between advertisement runs is 5 seconds
  For address family: IPv4 Unicast
    BGP table version 83, neighbor version 82
    Index 1, Offset 0, Mask 0x2
    Community attribute sent to this neighbor (both)
    0 accepted prefixes
    0 announced prefixes

  For address family: VPNv4 Unicast
    BGP table version 9, neighbor version 9
    Index 1, Offset 0, Mask 0x2
    AF-dependant capabilities:
      Add-Path Send Capability : received
      Add-Path Receive Capability : advertised
    Community attribute sent to this neighbor (both)
    4 accepted prefixes
    0 announced prefixes

  Connections established 3; dropped 2
  Local host: 192.168.11.2, Local port: 53977
  Foreign host: 192.168.11.1, Foreign port: 179
  Nexthop: 192.168.11.2
  Nexthop global: ::
  Nexthop local: ::
  BGP connection: non shared network
  Last Reset: 00:46:08, due to BGP Notification sent
  Notification Error Message: (Cease/Other Configuration Change.)

#show ip bgp vpnv4 all
Status codes: s suppressed, d damped, h history, * valid, > best, i -
internal, l - labeled
              S Stale
Origin codes: i - IGP, e - EGP, ? - incomplete
```

BGP IPv4 Additional Paths Configuration

```

      Network          Next Hop          Metric    LocPrf    Weight Path
Route Distinguisher: 100:1 (Default for VRF vrf1)
*> 100.1.1.0/24      10.0.11.1          0         100       0         65001
i
*>i 200.1.1.0        192.168.24.2       0         100       0         65002
i
  Announced routes count = 1
  Accepted routes count = 1
Route Distinguisher: 100:1
*>i 200.1.1.0        192.168.24.2       0         100       0         65002
i
* i 200.1.1.0        192.168.23.2       0         100       0         65002
i
* i 200.1.1.0        192.168.22.2       0         100       0         65002
i
* i 200.1.1.0        192.168.21.2       0         100       0         65002
i
  Announced routes count = 0
  Accepted routes count = 4

#show ip bgp vpnv4 all 200.1.1.0
Route Distinguisher: 100:1 (Default for VRF vrf1)
  65002
    192.168.24.2 (metric 2) from 192.168.11.1 (192.168.24.2)
      Origin IGP, metric 0, localpref 100, label 24320, valid, internal,
best
      Extended Community: RT:200:1
      Originator: 192.168.24.2, Cluster list: 10.12.48.36
      rx path_id: 0      tx path_id: 0
      Not advertised to any peer
      Last update: Mon Jan 9 05:28:04 2017

Route Distinguisher: 100:1
  65002
    192.168.24.2 (metric 2) from 192.168.11.1 (192.168.24.2)
      Origin IGP, metric 0, localpref 100, label 24320, valid, internal,
best
      Extended Community: RT:200:1
      Originator: 192.168.24.2, Cluster list: 10.12.48.36
      rx path_id: 3      tx path_id: 1
      Not advertised to any peer
      Last update: Mon Jan 9 05:28:04 2017

  65002
    192.168.23.2 (metric 2) from 192.168.11.1 (192.168.24.2)
      Origin IGP, metric 0, localpref 100, label 24320, valid, internal
      Extended Community: RT:200:1
      Originator: 192.168.24.2, Cluster list: 10.12.48.36
      rx path_id: 2      tx path_id: -1
      Not advertised to any peer
      Last update: Mon Jan 9 05:28:04 2017

  65002
    192.168.22.2 (metric 2) from 192.168.11.1 (192.168.24.2)
      Origin IGP, metric 0, localpref 100, label 24320, valid, internal
      Extended Community: RT:200:1
      Originator: 192.168.24.2, Cluster list: 10.12.48.36
      rx path_id: 1      tx path_id: -1
```



```
Not advertised to any peer
Last update: Mon Jan 9 05:28:04 2017
```

```
65002
192.168.21.2 (metric 2) from 192.168.11.1 (192.168.24.2)
Origin IGP, metric 0, localpref 100, label 24320, valid, internal
Extended Community: RT:200:1
Originator: 192.168.24.2, Cluster list: 10.12.48.36
rx path_id: 0 tx path_id: -1
Not advertised to any peer
Last update: Mon Jan 9 05:27:30 2017
```

Configure RR to Send Best 2 and Pe1 To Receive All Additional Paths at Address Family VPNv4 Level

RR

#configure terminal	Enter configure mode
(config)#router bgp 100	Enter BGP router mode
(config-router)#address-family vpnv4 unicast	Enter address family VPNv4 unicast mode
(config-router-af)#bgp additional-paths send	Configure RR to send additional paths to all the VPNv4 neighbors
(config-router-af)#bgp additional-paths select best 2	Configure RR to select best 2 available paths to send to all VPNv4 neighbors
(config-router-af)#exit-address-family	Exit Address Family mode and return to Router mode.
(config-router)#exit	Exit Router BGP and Configure mode.
(config)#commit	Apply commit
(config)#exit	Exit Router BGP and Configure mode.

PE1

#configure terminal	Enter configure mode
(config)#router bgp 100	Enter BGP router mode
(config-router)#address-family vpnv4 unicast	Enter address family VPNv4 unicast mode
(config-router-af)#bgp additional-paths receive	Configure PE1 to receive additional paths from all the VPNv4 neighbors
(config-router-af)#exit-address-family	Exit Address Family mode and return to Router mode.
(config-router)#exit	Exit Router BGP and Configure mode.
(config)#commit	Apply commit
(config)#exit	Exit Router BGP and Configure mode.

Configure RR to Send Best 2 and Pe1 To Receive All Additional Paths at Neighbor Level Address Family VPNv4

RR

#configure terminal	Enter configure mode
(config)#router bgp 100	Enter BGP router mode

BGP IPv4 Additional Paths Configuration

(config-router)#address-family vpnv4 unicast	Enter address family VPNv4 unicast mode
(config-router-af)#neighbor 192.168.11.2 additional-paths send	Configure RR to send additional paths to the VPNv4 neighbor on PE1
(config-router-af)#neighbor 192.168.11.2 advertise additional-paths best 2	Configure RR to advertise best 2 out of all available paths to the VPNv4 neighbor on PE1
(config-router-af)#end	Return to the global mode
(config-router-af)#exit-address-family	Exit Address Family mode and return to Router mode.
(config-router)#exit	Exit Router BGP and Configure mode.
(config)#commit	Apply commit
(config)#exit	Exit Router BGP and Configure mode.

PE1

#configure terminal	Enter configure mode
(config)#router bgp 100	Enter BGP router mode
(config-router)#address-family vpnv4 unicast	Enter address family VPNv4 unicast mode
(config-router-af)#neighbor 192.168.11.1 additional-paths receive	Configure PE1 to receive additional paths from RR
(config-router-af)#exit-address-family	Exit Address Family mode and return to Router mode.
(config-router)#exit	Exit Router BGP and Configure mode.
(config)#commit	Apply commit
(config)#exit	Exit Router BGP and Configure mode.

Validation

RR

```
#show ip bgp vpnv4 all 200.1.1.0
Route Distinguisher: 100:1
 65002, (Received from a RR-client)
 192.168.21.2 from 192.168.21.2 (192.168.21.2)
  Origin IGP, metric 0, localpref 100, label 24320, valid, internal,
best
 Extended Community: RT:200:1
 rx path_id: -1 tx path_id: 2
 Advertised to non peer-group peers:
 192.168.11.2
 Last update: Wed Jan 11 06:03:50 2017

65002, (Received from a RR-client)
 192.168.22.2 from 192.168.22.2 (192.168.21.2)
  Origin IGP, metric 0, localpref 100, label 24320, valid, internal
 Extended Community: RT:200:1
 rx path_id: -1 tx path_id: 0
 Advertised to non peer-group peers:
 192.168.11.2
 Last update: Wed Jan 11 06:02:10 2017

65002, (Received from a RR-client)
 192.168.23.2 from 192.168.23.2 (192.168.21.2)
```

```

Origin IGP, metric 0, localpref 100, label      24320, valid, internal
Extended Community: RT:200:1
rx path_id: -1      tx path_id: 1
Not advertised to any peer
Last update: Wed Jan 11 06:02:10 2017

```

```

65002, (Received from a RR-client)
192.168.24.2 from 192.168.24.2 (192.168.21.2)
Origin IGP, metric 0, localpref 100, label      24320, valid, internal
Extended Community: RT:200:1
rx path_id: -1      tx path_id: -1
Not advertised to any peer
Last update: Wed Jan 11 06:02:10 2017

```

PE1

```

#show ip bgp vpnv4 all
Status codes: s suppressed, d damped, h history, * valid, > best, i -
internal, l - labeled
          S Stale
Origin codes: i - IGP, e - EGP, ? - incomplete

```

Network	Next Hop	Metric	LocPrf	Weight	Path
Route Distinguisher: 100:1 (Default for VRF vrf1)					
*> 100.1.1.0/24	10.0.11.1	0	100	0	65001
i					
*>i 200.1.1.0	192.168.21.2	0	100	0	65002
i					
Announced routes count = 1					
Accepted routes count = 1					
Route Distinguisher: 100:1					
*>i 200.1.1.0	192.168.21.2	0	100	0	65002
i					
* i 200.1.1.0	192.168.22.2	0	100	0	65002
i					
Announced routes count = 0					
Accepted routes count = 2					

```

#show ip bgp vpnv4 all 200.1.1.0
Route Distinguisher: 100:1 (Default for VRF vrf1)
65002
192.168.21.2 (metric 2) from 192.168.11.1 (192.168.21.2)
Origin IGP, metric 0, localpref 100, label      24320, valid, internal,
best
Extended Community: RT:200:1
Originator: 192.168.21.2, Cluster list: 10.12.48.36
rx path_id: 0      tx path_id: 0
Not advertised to any peer
Last update: Wed Jan 11 06:03:43 2017

```

```

Route Distinguisher: 100:1
65002
192.168.21.2 (metric 2) from 192.168.11.1 (192.168.21.2)
Origin IGP, metric 0, localpref 100, label      24320, valid, internal,
best
Extended Community: RT:200:1
Originator: 192.168.21.2, Cluster list: 10.12.48.36
rx path_id: 2      tx path_id: 1
Not advertised to any peer

```

BGP IPv4 Additional Paths Configuration

Last update: Wed Jan 11 06:03:43 2017

65002

192.168.22.2 (metric 2) from 192.168.11.1 (192.168.21.2)
Origin IGP, metric 0, localpref 100, label 24320, valid, internal
Extended Community: RT:200:1
Originator: 192.168.21.2, Cluster list: 10.12.48.36
rx path_id: 0 tx path_id: -1
Not advertised to any peer
Last update: Wed Jan 11 06:02:05 2017

Configure RR to Send Best 3 and Pe1 to Receive All Additional Paths at Address Family VPNv4 Level

RR

#configure terminal	Enter configure mode
(config)#router bgp 100	Enter BGP router mode
(config-router)#address-family vpnv4 unicast	Enter address family VPNv4 unicast mode
(config-router-af)#bgp additional-paths send	Configure RR to send additional paths to all the VPNv4 neighbors
(config-router-af)#bgp additional-paths select best 3	Configure RR to select best 3 available paths to send to all VPNv4 neighbors
(config-router-af)#exit-address-family	Exit Address Family mode and return to Router mode.
(config-router)#exit	Exit Router BGP and Configure mode.
(config)#commit	Apply commit
(config)#exit	Exit Router BGP and Configure mode.

PE1

#configure terminal	Enter configure mode
(config)#router bgp 100	Enter BGP router mode
(config-router)#address-family vpnv4 unicast	Enter address family VPNv4 unicast mode
(config-router-af)#bgp additional-paths receive	Configure PE1 to receive additional paths from all the VPNv4 neighbors
(config-router-af)#exit-address-family	Exit Address Family mode and return to Router mode.
(config-router)#exit	Exit Router BGP and Configure mode.
(config)#commit	Apply commit
(config)#exit	Exit Router BGP and Configure mode.

Configure RR to Send Best 3 and Pe1 to Receive All Additional Paths at Neighbor Level Address Family VPNv4

RR

#configure terminal	Enter configure mode
(config)#router bgp 100	Enter BGP router mode

(config-router)#address-family vpnv4 unicast	Enter address family VPNv4 unicast mode
(config-router-af)#neighbor 192.168.11.2 additional-paths send	Configure RR to send additional paths to the VPNv4 neighbor on PE1
(config-router-af)#neighbor 192.168.11.2 advertise additional-paths best 3	Configure RR to advertise best 3 out of all available paths to the VPNv4 neighbor on PE1
(config-router-af)#exit-address-family	Exit Address Family mode and return to Router mode.
(config-router)#exit	Exit Router BGP and Configure mode.
(config)#commit	Apply commit
(config)#exit	Exit Router BGP and Configure mode.

PE1

#configure terminal	Enter configure mode
(config)#router bgp 100	Enter BGP router mode
(config-router)#address-family vpnv4 unicast	Enter address family VPNv4 unicast mode
(config-router-af)#neighbor 192.168.11.1 additional-paths receive	Configure PE1 to receive additional paths from RR
(config-router-af)#exit-address-family	Exit Address Family mode and return to Router mode.
(config-router)#exit	Exit Router BGP and Configure mode.
(config)#commit	Apply commit
(config)#exit	Exit Router BGP and Configure mode.

Validation

RR

```
#show ip bgp vpnv4 all 200.1.1.0
Route Distinguisher: 100:1
  65002, (Received from a RR-client)
    192.168.21.2 from 192.168.21.2 (192.168.21.2)
      Origin IGP, metric 0, localpref 100, label      24320, valid, internal,
best
      Extended Community: RT:200:1
      rx path_id: -1      tx path_id: 2
      Advertised to non peer-group peers:
        192.168.11.2
      Last update: Wed Jan 11 06:03:50 2017

  65002, (Received from a RR-client)
    192.168.22.2 from 192.168.22.2 (192.168.21.2)
      Origin IGP, metric 0, localpref 100, label      24320, valid, internal
      Extended Community: RT:200:1
      rx path_id: -1      tx path_id: 0
      Advertised to non peer-group peers:
        192.168.11.2
      Last update: Wed Jan 11 06:02:10 2017

  65002, (Received from a RR-client)
    192.168.23.2 from 192.168.23.2 (192.168.21.2)
      Origin IGP, metric 0, localpref 100, label      24320, valid, internal
```

BGP IPv4 Additional Paths Configuration

```
Extended Community: RT:200:1
rx path_id: -1      tx path_id: 1
Advertised to non peer-group peers:
 192.168.11.2
Last update: Wed Jan 11 06:02:10 2017
```

```
65002, (Received from a RR-client)
192.168.24.2 from 192.168.24.2 (192.168.21.2)
Origin IGP, metric 0, localpref 100, label 24320, valid, internal
Extended Community: RT:200:1
rx path_id: -1      tx path_id: -1
Not advertised to any peer
Last update: Wed Jan 11 06:02:10 2017
```

PE1

```
#show ip bgp vpnv4 all
Status codes: s suppressed, d damped, h history, * valid, > best, i -
internal, l - labeled
          S Stale
Origin codes: i - IGP, e - EGP, ? - incomplete
```

Network	Next Hop	Metric	LocPrf	Weight	Path
Route Distinguisher: 100:1 (Default for VRF vrf1)					
*> 100.1.1.0/24	10.0.11.1	0	100	0	65001
i					
*>i 200.1.1.0	192.168.23.2	0	100	0	65002
i					
Announced routes count = 1					
Accepted routes count = 1					
Route Distinguisher: 100:1					
*>i 200.1.1.0	192.168.23.2	0	100	0	65002
i					
* i 200.1.1.0	192.168.22.2	0	100	0	65002
i					
* i 200.1.1.0	192.168.21.2	0	100	0	65002
i					
Announced routes count = 0					
Accepted routes count = 3					

```
#show ip bgp vpnv4 all 200.1.1.0
Route Distinguisher: 100:1 (Default for VRF vrf1)
65002
 192.168.23.2 (metric 2) from 192.168.11.1 (192.168.21.2)
Origin IGP, metric 0, localpref 100, label 24320, valid, internal,
best
Extended Community: RT:200:1
Originator: 192.168.21.2, Cluster list: 10.12.48.36
rx path_id: 0      tx path_id: 0
Not advertised to any peer
Last update: Wed Jan 11 06:24:47 2017
```

```
Route Distinguisher: 100:1
65002
 192.168.23.2 (metric 2) from 192.168.11.1 (192.168.21.2)
Origin IGP, metric 0, localpref 100, label 24320, valid, internal,
best
Extended Community: RT:200:1
Originator: 192.168.21.2, Cluster list: 10.12.48.36
```

```

rx path_id: 1      tx path_id: 1
Not advertised to any peer
Last update: Wed Jan 11 06:24:47 2017

65002
192.168.22.2 (metric 2) from 192.168.11.1 (192.168.21.2)
Origin IGP, metric 0, localpref 100, label 24320, valid, internal
Extended Community: RT:200:1
Originator: 192.168.21.2, Cluster list: 10.12.48.36
rx path_id: 0      tx path_id: -1
Not advertised to any peer
Last update: Wed Jan 11 06:24:47 2017

65002
192.168.21.2 (metric 2) from 192.168.11.1 (192.168.21.2)
Origin IGP, metric 0, localpref 100, label 24320, valid, internal
Extended Community: RT:200:1
Originator: 192.168.21.2, Cluster list: 10.12.48.36
rx path_id: 2      tx path_id: -1
Not advertised to any peer
Last update: Wed Jan 11 06:24:00 2017

```

Additional Paths for 6PE

This section contains the configuration of additional paths group best for 6PE.

Topology

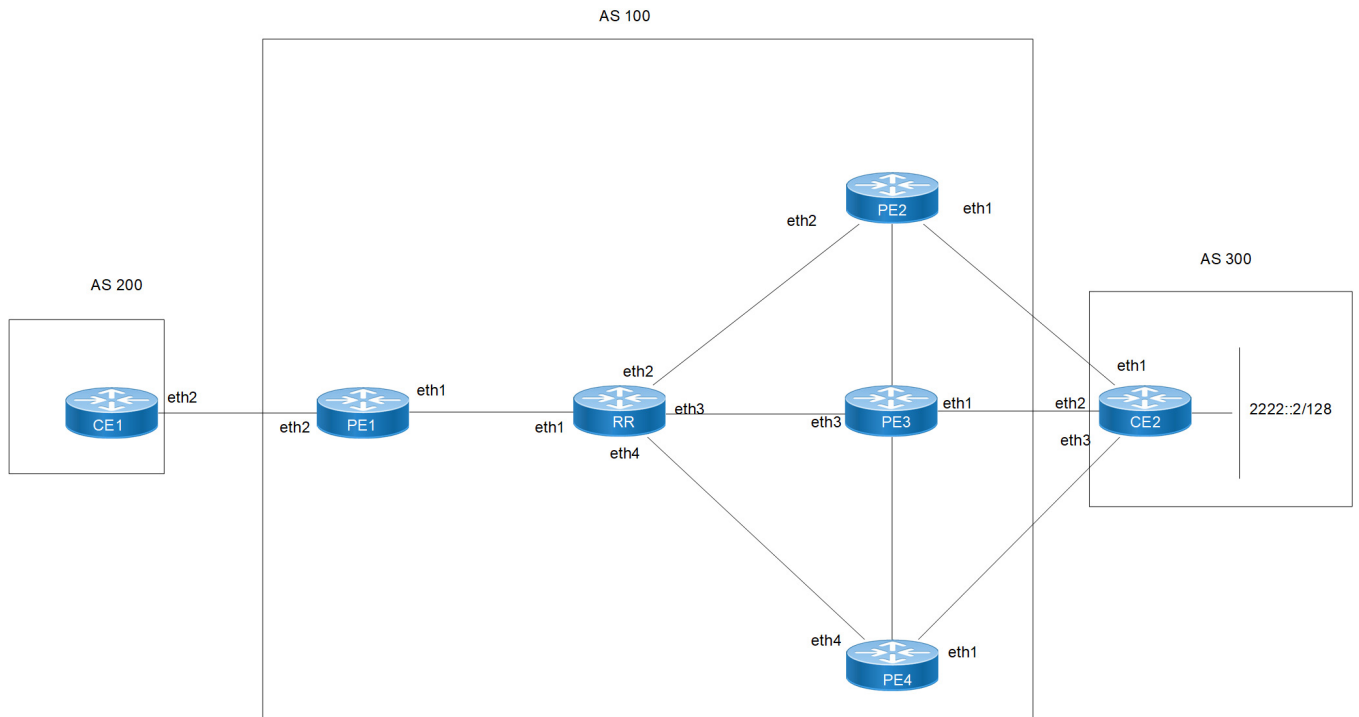

Figure 6-60: Additional paths group best for 6PE

CE1: Interface

CE1#configure terminal	Enter configure mode.
CE1(config)#hostname CE1	Configure the hostname to CE1
CE1(config)#interface eth2	Enter the Interface mode for interface eth2.
CE1(config-if)#ipv6 address 1001::1/64	Configure IPV6 address for interface eth2
(config)#commit	Apply commit
(config)#exit	Exit Router BGP and Configure mode.

CE1: BGP

CE1(config)#router bgp 200	Enter BGP router mode
CE1(config-router)#neighbor 1001::2 remote-as 100	Configure BGP ipv6 neighbor on PE1
CE1(config-router)#address-family ipv6 unicast	Enter the address family ipv6
CE1(config-router-af)#neighbor 1001::2 activate	Activate neighbor under address family ipv6
CE1(config-router-af)#exit-address-family	Exit address family ipv6 unicast mode
CE1(config-router)#exit	Exit BGP router mode
CE1(config)#commit	Apply commit
CE1#clear bgp 1001::2	Clear BGP peer PE1

PE1: Interface

PE1#configure terminal	Enter configure mode.
PE1(config)#hostname PE1	Configure the hostname to PE1
PE1(config)#interface eth2	Enter the Interface mode for interface eth2
PE1(config-if)#ipv6 address 1001::2/64	Configure the IPv6 address for interface eth2
PE1(config-if)#exit	Exit interface mode
PE1(config)#interface lo	Enter the Interface mode for the loopback interface.
PE1(config-if)#ip address 1.1.1.1/32	Configure IPV4 address for loopback interface.
PE1(config-if)#exit	Exit interface mode
PE1(config)#interface eth1	Enter the Interface mode for interface eth1
PE1(config-if)#ip address 10.1.1.1/24	Configure the IP address for interface eth1
(config-if)#exit	Exit the interface level
(config)#commit	Apply commit
(config)#exit	Exit.

PE1: OSPF

PE1(config)#router ospf 1	Configure an OSPF instance 1
PE1(config-router)#network 10.1.1.0/24 area 0	Advertise the network towards P in Area 0

PE1(config-router)#network 1.1.1.1/32 area 0	Advertise the Loopback network in Area 0
PE1(config-router)#exit	Exit OSPF router mode
PE1(config)#commit	Apply commit
PE1(config)#exit	Exit the global mode

PE1: MPLS

PE1(config)#router ldp	Enable LDP Process
PE1(config-router)#transport-address ipv4 1.1.1.1	Configure Transport address for LDP
PE1(config-router)#exit	Exit router ldp mode
PE1(config)#interface eth1	Enter the interface mode for interface eth1
PE1(config-if)#label-switching	Enable label-switching on interface eth1
PE1(config-if)#enable-ldp ipv4	Enable LDP for IPv4 on interface eth1
PE1(config-if)#exit	Exit the interface mode
PE1(config)#commit	Apply commit
PE1(config)#exit	Exit the global mode

PE1: BGP

PE1(config)#router bgp 100	Configure router bgp mode
PE1(config)#bgp router-id 1.1.1.1	Configure BGP router-id
PE1(config-router)#neighbor 2.2.2.2 remote-as 100	Configure BGP IPv4 neighbor on PE2
PE1(config-router)#neighbor 2.2.2.2 update-source 1.1.1.1	Configure the routing update source for RR as PE1's Loopback
PE1(config-router)#address-family ipv6 labeled-unicast	Enter BGP address-family ipv6 labeled unicast mode
PE1(config-router-af)#neighbor 2.2.2.2 activate	Activate the neighbor RR for address-family ipv6 labeled-unicast unicast
PE1(config-router-af)#exit-address-family	Exit address-family ipv6 labeled-unicast mode
PE1(config-router)#address-family ipv6 unicast	Enter BGP address-family ipv6 unicast mode
PE1(config-router)#neighbor 1001::1 remote-as 200	Configure BGP IPv6 neighbor on CE1
PE1(config-router-af)#exit-address-family	Exit address-family ipv6 unicast mode
PE1(config-router)#exit	Exit router bgp mode
PE1(config)#exit	Exit configure mode
PE1(config)#commit	Apply commit

RR: Interface

RR#configure terminal	Enter configure mode.
RR(config)#hostname RR	Configure hostname as RR
RR(config)#interface eth1	Enter interface mode for interface eth1

BGP IPv4 Additional Paths Configuration

RR(config-if)#ip address 10.1.1.2/24	Configure IPv4 address for interface eth1
RR(config-if)#exit	Exit interface mode
RR(config)#interface eth2	Enter interface mode for interface eth2
RR(config-if)#ip address 20.1.1.2/24	Configure IPv4 address for interface eth2
RR(config-if)#exit	Exit interface mode
RR(config)#interface eth3	Enter interface mode for interface eth3
RR(config-if)#ip address 30.1.1.2/24	Configure IPv4 address for interface eth3
RR(config-if)#exit	Exit interface mode
RR(config)#interface eth4	Enter interface mode for interface eth4
RR(config-if)#ip address 40.1.1.2/24	Configure IPv4 address for interface eth4
RR(config-if)#exit	Exit interface mode
RR(config)#interface lo	Enter Interface mode for the loopback interface.
RR(config-if)#ip address 2.2.2.2/32	Configure IPV4 address for loopback interface.
RR(config-if)#exit	Exit Interface mode.
PE1(config)#commit	Apply commit

RR: OSPF

RR(config)#router ospf 1	Configure router OSPF instance 1
RR(config-router)#network 10.1.1.0/24 area 0	Advertise the network towards PE1 in area 0
RR(config-router)#network 20.1.1.0/24 area 0	Advertise the network towards PE2 in area 0
RR(config-router)#network 30.1.1.0/24 area 0	Advertise the network towards PE3 in area 0
RR(config-router)#network 40.1.1.0/24 area 0	Advertise the network towards PE4 in area 0
RR(config-router)#network 2.2.2.2/32 area 0	Advertise the Loopback network in area 0
RR(config-router)#exit	Exit the router ospf mode
RR(config)#commit	Apply commit

RR: MPLS

RR(config)#router ldp	Enable LDP Process
RR(config-router)#transport-address ipv4 2.2.2.2	Configure Transport address for LDP
RR(config-router)#exit	Exit router ldp mode
RR(config)#interface eth1	Enter the interface mode for interface eth1
RR(config-if)#label-switching	Enable label-switching on interface eth1
RR(config-if)#enable-ldp ipv4	Enable LDP for IPv4 on interface eth1
RR(config-if)#exit	Exit interface mode
RR(config)#interface eth2	Enter the interface mode for interface eth2
RR(config-if)#label-switching	Enable label-switching on interface eth2
RR(config-if)#enable-ldp ipv4	Enable LDP for IPv4 on interface eth2
RR(config-if)#exit	Exit interface mode
RR(config)#interface eth3	Enter the interface mode for interface eth3

RR(config-if)#label-switching	Enable label-switching on interface eth3
RR(config-if)#enable-ldp ipv4	Enable LDP for IPv4 on interface eth3
RR(config-if)#exit	Exit interface mode
RR(config)#interface eth4	Enter the interface mode for interface eth4
RR(config-if)#label-switching	Enable label-switching on interface eth4
RR(config-if)#enable-ldp ipv4	Enable LDP for IPv4 on interface eth4
RR(config-if)#exit	Exit interface mode
RR(config)#commit	Apply commit
RR(config)#exit	Exit the configure terminal mode

RR: BGP

RR(config)#router bgp 100	Configure router bgp mode
RR(config)#bgp router-id 2.2.2.2	Configure BGP router-id
RR(config-router)#neighbor 1.1.1.1 remote-as 100	Configure BGP neighbor on PE1
RR(config-router)#neighbor 1.1.1.1 update-source 2.2.2.2	Configure the routing update source for PE1 as RR's Loopback
RR(config-router)#neighbor 3.3.3.3 remote-as 100	Configure BGP neighbor on PE2
RR(config-router)#neighbor 3.3.3.3 update-source 2.2.2.2	Configure the routing update source for PE2 as RR's Loopback
RR(config-router)#neighbor 4.4.4.4 remote-as 100	Configure BGP neighbor on PE3
RR(config-router)#neighbor 4.4.4.4 update-source 2.2.2.2	Configure the routing update source for PE3 as RR's Loopback
RR(config-router)#neighbor 5.5.5.5 remote-as 100	Configure BGP neighbor on PE4
RR(config-router)#neighbor 5.5.5.5 update-source 2.2.2.2	Configure the routing update source for PE4 as RR's Loopback
RR(config-router)#address-family ipv6 labeled-unicast	Enter BGP address-family ipv6 labeled unicast mode
RR(config-router-af)#neighbor 1.1.1.1 activate	Activate the neighbor PE1 for address-family ipv6 lu unicast
RR(config-router-af)#neighbor 1.1.1.1 route-reflector-client	Configure PE1 as route-reflector-client
RR(config-router-af)#neighbor 3.3.3.3 activate	Activate the neighbor PE2 for address-family ipv6 lu unicast
RR(config-router-af)#neighbor 3.3.3.3 route-reflector-client	Configure PE2 as route-reflector-client
RR(config-router-af)#neighbor 4.4.4.4 activate	Activate the neighbor PE3 for address-family ipv6 lu unicast
RR(config-router-af)#neighbor 4.4.4.4 route-reflector-client	Configure PE3 as route-reflector-client
RR(config-router-af)#neighbor 5.5.5.5 activate	Activate the neighbor PE4 for address-family ipv6 lu unicast
RR(config-router-af)#neighbor 5.5.5.5 route-reflector-client	Configure PE4 as route-reflector-client

BGP IPv4 Additional Paths Configuration

RR(config-router-af)#exit-address-family	Exit BGP address-family ipv6 lu unicast mode
RR(config-router)#exit	Exit router bgp mode
RR(config)#commit	Apply commit
RR(config)#exit	Exit configure mode

PE2: Interface

PE2#configure terminal	Enter configure mode.
PE2(config)#hostname PE2	Configure the hostname to PE2
PE2(config)#interface eth1	Enter the Interface mode for interface eth1
PE2(config-if)#ipv6 address 2001::1/64	Configure the IPv6 address for interface eth1
PE2(config-if)#exit	Exit interface mode
PE2(config)#interface lo	Enter the Interface mode for the loopback interface.
PE2(config-if)#ip address 3.3.3.3/32	Configure IPv4 address for loopback interface.
PE2(config-if)#exit	Exit interface mode
PE2(config)#interface eth2	Enter the Interface mode for interface eth2
PE2(config-if)#ip address 20.1.1.1/24	Configure the IP address for interface eth2
PE2(config-if)#exit	Exit configure mode
PE2(config)#commit	Apply commit

PE2: OSPF

PE2(config)#router ospf 1	Configure an OSPF instance 1
PE2(config-router)#network 20.1.1.0/24 area 0	Advertise the network towards RR in Area 0
PE2(config-router)#network 3.3.3.3/32 area 0	Advertise the Loopback network in Area 0
PE2(config-router)#exit	Exit OSPF router mode
PE2(config)#commit	Apply commit

PE2: MPLS

PE2(config)#router ldp	Enable LDP Process
PE2(config-router)#transport-address ipv4 3.3.3.3	Configure Transport address for LDP
PE2(config-router)#exit	Exit router ldp mode
PE2(config)#interface eth2	Enter the interface mode for interface eth2
PE2(config-if)#label-switching	Enable label-switching on interface eth2
PE2(config-if)#enable-ldp ipv4	Enable LDP for IPv4 on interface eth2
PE2(config-if)#exit	Exit interface mode
PE2(config)#commit	Apply commit

PE2: BGP

PE2(config)#router bgp 100	Configure router bgp mode
PE2(config)#bgp router-id 3.3.3.3	Configure BGP router-id
PE2(config-router)#neighbor 2.2.2.2 remote-as 100	Configure BGP IPv4 neighbor on RR
PE2(config-router)#neighbor 2.2.2.2 update-source 3.3.3.3	Configure the routing update source for RR as PE2's Loopback
PE2(config-router)#address-family ipv6 labeled-unicast	Enter BGP address-family ipv6 labeled-unicast mode
PE2(config-router-af)#neighbor 2.2.2.2 activate	Activate the neighbor RR for address-family ipv6 labeled-unicast
PE2(config-router-af)#exit-address-family	Exit address-family ipv6 labeled-unicast mode
PE2(config-router)#address-family ipv6 unicast	Enter BGP address-family ipv6 unicast mode
PE2(config-router)#neighbor 2001::2 remote-as 300	Configure BGP IPv6 neighbor on CE2
PE2(config-router-af)#exit-address-family	Exit address-family ipv6 unicast mode
PE2(config-router)#exit	Exit router bgp mode
PE2(config)#commit	Apply commit
PE2(config)#exit	Exit configure mode
PE2#clear bgp ipv6 unicast 2001::2 unicast	Clear BGP neighbor CE2

PE3: Interface

PE3#configure terminal	Enter configure mode.
PE3(config)#hostname PE3	Configure the hostname to PE3
PE3(config)#interface eth1	Enter the Interface mode for interface eth1
PE3(config-if)#ipv6 address 3001::1/64	Configure the IPv6 address for interface eth1
PE3(config-if)#exit	Exit interface mode
PE3(config)#interface lo	Enter the Interface mode for the loopback interface.
PE3(config-if)#ip address 4.4.4.4/32	Configure IPV4 address for loopback interface.
PE3(config-if)#exit	Exit interface mode
PE3(config)#interface eth3	Enter the Interface mode for interface eth3
PE3(config-if)#ip address 30.1.1.1/24	Configure the IP address for interface eth3
PE3(config-if)#exit	Exit interface mode
PE3(config)#commit	Apply commit

PE3: OSPF

PE3(config)#router ospf 1	Configure an OSPF instance 1
PE3(config-router)#network 30.1.1.0/24 area 0	Advertise the network towards RR in Area 0
PE3(config-router)#network 4.4.4.4/32 area 0	Advertise the Loopback network in Area 0

BGP IPv4 Additional Paths Configuration

PE3(config-router)#exit	Exit OSPF router mode
PE3(config)#commit	Apply commit

PE3: MPLS

PE3(config)#router ldp	Enable LDP Process
PE3(config-router)#transport-address ipv4 4.4.4.4	Configure Transport address for LDP
PE3(config-router)#exit	Exit router ldp mode
PE3(config)#interface eth3	Enter the interface mode for interface eth3
PE3(config-if)#label-switching	Enable label-switching on interface eth3
PE3(config-if)#enable-ldp ipv4	Enable LDP for IPv4 on interface eth3
PE3(config-if)#exit	Exit interface mode
PE3(config)#commit	Apply commit

PE3: BGP

PE3(config)#router bgp 100	Configure router bgp mode
PE3(config)#bgp router-id 4.4.4.4	Configure BGP router-id
PE3(config-router)#neighbor 2.2.2.2 remote-as 100	Configure BGP IPv4 neighbor on RR
PE3(config-router)#neighbor 2.2.2.2 update-source 4.4.4.4	Configure the routing update source for RR as PE3's Loopback
PE3(config-router)#address-family ipv6 labeled-unicast	Enter BGP address-family ipv6 labeled-unicast mode
PE3(config-router-af)#neighbor 2.2.2.2 activate	Activate the neighbor RR for address-family ipv6 labeled-unicast
PE3(config-router-af)#exit-address-family	Exit address-family ipv6 labeled-unicast mode
PE3(config-router)#address-family ipv6 unicast	Enter BGP address-family ipv6 unicast mode
PE3(config-router)#neighbor 3001::2 remote-as 300	Configure BGP IPv6 neighbor on CE2
PE3(config-router-af)#exit-address-family	Exit address-family ipv6 unicast mode
PE3(config-router)#exit	Exit router bgp mode
PE3(config)#commit	Apply commit
PE3(config)#exit	Exit configure mode

PE4: Interface

PE4#configure terminal	Enter configure mode.
PE4(config)#hostname PE4	Configure the hostname to PE4
PE4(config)#interface eth1	Enter the Interface mode for interface eth1
PE4(config-if)#ipv6 address 4001::1/64	Configure the IPv6 address for interface eth1
PE4(config-if)#exit	Exit interface mode
PE4(config)#interface lo	Enter the Interface mode for the loopback interface.

PE4(config-if)#ip address 5.5.5.5/32	Configure IPV4 address for loopback interface.
PE4(config-if)#exit	Exit interface mode
PE4(config)#interface eth4	Enter the Interface mode for interface eth4
PE4(config-if)#ip address 40.1.1.1/24	Configure the IP address for interface eth4
PE4(config-if)#exit	Exit interface mode
PE4(config)#commit	Apply commit

PE4: OSPF

PE4(config)#router ospf 1	Configure an OSPF instance 1
PE4(config-router)#network 40.1.1.0/24 area 0	Advertise the network towards RR in Area 0
PE4(config-router)#network 5.5.5.5/32 area 0	Advertise the Loopback network in Area 0
PE4(config-router)#exit	Exit OSPF router mode
PE4(config)#commit	Apply commit

PE4: MPLS

PE4(config)#router ldp	Enable LDP Process
PE4(config-router)#transport-address ipv4 5.5.5.5	Configure Transport address for LDP
PE4(config-router)#exit	Exit router ldp mode
PE4(config)#interface eth4	Enter the interface mode for interface eth4
PE4(config-if)#label-switching	Enable label-switching on interface eth4
PE4(config-if)#enable-ldp ipv4	Enable LDP for IPv4 on interface eth4
PE4(config-if)#exit	Exit interface mode
PE4(config)#commit	Apply commit

PE4: BGP

PE4(config)#router bgp 100	Configure router bgp mode
PE4(config)#bgp router-id 5.5.5.5	Configure BGP router-id
PE4(config-router)#neighbor 2.2.2.2 remote-as 100	Configure BGP IPv4 neighbor on RR
PE4(config-router)#neighbor 2.2.2.2 update-source 5.5.5.5	Configure the routing update source for RR as PE4's Loopback
PE4(config-router)#address-family ipv6 labeled-unicast	Enter BGP address-family ipv6 labeled-unicast mode
PE4(config-router-af)#neighbor 2.2.2.2 activate	Activate the neighbor RR for address-family ipv6 labeled-unicast
PE4(config-router-af)#exit-address-family	Exit address-family ipv6 labeled-unicast mode
PE4(config-router)#address-family ipv6 unicast	Enter BGP address-family ipv6 unicast mode

BGP IPv4 Additional Paths Configuration

PE4(config-router)#neighbor 4001::2 remote-as 300	Configure BGP IPv6 neighbor on CE2
PE4(config-router-af)#exit-address-family	Exit address-family ipv6 unicast mode
PE4(config-router)#exit	Exit router bgp mode
PE4(config)#commit	Apply commit
PE4(config)#exit	Exit configure mode

CE2: Interface

CE2#configure terminal	Enter configure mode.
CE2(config)#hostname CE2	Configure the hostname to CE2
CE2(config)#interface eth1	Enter the Interface mode for interface eth1
CE2(config-if)#ipv6 address 2001::2/64	Configure IPV6 address for interface eth1
CE2(config-if)#exit	Exit Interface mode.
CE2(config)#interface eth2	Enter the Interface mode for interface eth2
CE2(config-if)#ipv6 address 3001::2/64	Configure IPV6 address for interface eth2
CE2(config-if)#exit	Exit Interface mode.
CE2(config)#interface eth3	Enter the Interface mode for interface eth3
CE2(config-if)#ipv6 address 4001::2/64	Configure IPV6 address for interface eth3
CE2(config-if)#exit	Exit Interface mode.
CE2(config)#interface lo	Enter the Interface mode for interface Loopback
CE2(config-if)#ipv6 address 2222::2/128	Configure IPV6 address for interface Loopback
CE2(config-if)#exit	Exit Interface mode.
CE2(config)#commit	Apply commit

CE2: BGP

CE2(config)#router bgp 300	Enter BGP router mode
CE2(config-router)#neighbor 2001::1 remote-as 100	Configure BGP ipv6 neighbor on PE2
CE2(config-router)#neighbor 3001::1 remote-as 100	Configure BGP ipv6 neighbor on PE3
CE2(config-router)#neighbor 4001::1 remote-as 100	Configure BGP ipv6 neighbor on PE4
CE2(config-router)#address-family ipv6 unicast	Enter the address family ipv6
CE2(config-router-af)#neighbor 2001::1 activate	Activate neighbor under address family ipv6
CE2(config-router-af)#neighbor 3001::1 activate	Activate neighbor under address family ipv6
CE2(config-router-af)#neighbor 4001::1 activate	Activate neighbor under address family ipv6
CE2(config-router-af)#network 2222::2/128	Advertise the IPv6 prefix of Loopback into BGP
CE2(config-router-af)#exit-address-family	Exit address family ipv6 unicast mode
CE2(config-router)#exit	Exit BGP router mode

CE2 (config) #commit	Apply commit
CE2 (config) #exit	Exit configure mode

BGP Addpath Capability for ipv6 labeled-unicast Unicast Address-family

RR

RR (config) #router bgp 100	Configure router bgp mode
RR (config-router) #address-family ipv6 labeled-unicast	Enter BGP address-family ipv6 labeled-unicast mode
RR (config-router-af) #bgp additional-paths select all	Configure RR to select all addpaths
RR (config-router-af) #bgp additional-paths send	Configure BGP addpath send capability under address-family ipv6 labeled-unicast
(config-router-af) #exit-address-family	Exit bgp address-family mode.
(config-router) #exit	Exit Router BGP mode.
(config) #commit	Apply commit
(config) #exit	Exit Configure mode.

PE1

PE1 (config) #router bgp 100	Configure router bgp mode
PE1 (config-router) #address-family ipv6 labeled-unicast	Enter BGP address-family ipv6 labeled-unicast mode
PE1 (config-router-af) #neighbor 2.2.2.2 additional-paths receive	Configure BGP addpath receive capability for the 6pe-neighbor RR under address-family ipv6 labeled-unicast
PE1 (config-router-af) #neighbor 2.2.2.2 additional-paths receive	Configure BGP addpath receive capability for the 6pe-neighbor RR under address-family ipv6 labeled-unicast
PE1 (config-router-af) #exit-address-family	Exit bgp address-family mode.
PE1 (config-router) #exit	Exit Router BGP mode.
PE1 (config) #commit	Apply commit
PE1 (config) #exit	Exit Configure mode.

PE2

PE2 (config) #router bgp 100	Configure router bgp mode
PE2 (config-router) #address-family ipv6 labeled-unicast	Enter BGP address-family ipv6 labeled-unicast mode
PE2 (config-router-af) #bgp additional-paths receive	Configure BGP addpath receive capability under address-family ipv6 labeled-unicast
(config-router-af) #exit-address-family	Exit bgp address-family mode.
(config-router) #exit	Exit Router BGP mode.
(config) #commit	Apply commit
(config) #exit	Exit Configure mode.

BGP IPv4 Additional Paths Configuration

PE3

PE3(config)#router bgp 100	Configure router bgp mode
PE3(config-router)#address-family ipv6 labeled-unicast	Enter BGP address-family ipv6 labeled-unicast mode
PE3(config-router-af)#bgp additional-paths receive	Configure BGP addpath receive capability under address-family ipv6 labeled-unicast
PE3(config-router-af)#exit-address-family	Exit bgp address-family mode.
PE3(config-router)#exit	Exit Router BGP mode.
PE3(config)#commit	Apply commit
PE3(config)#exit	Exit Configure mode.

PE4

PE4(config)#router bgp 100	Configure router bgp mode
PE4(config-router)#address-family ipv6 labeled-unicast	Enter BGP address-family ipv6 labeled-unicast mode
PE4(config-router-af)#bgp additional-paths receive	Configure BGP addpath receive capability under address-family ipv6 labeled-unicast
PE4(config-router-af)#exit-address-family	Exit bgp address-family mode.
PE4(config-router)#exit	Exit Router BGP mode.
PE4(config)#commit	Apply commit
PE4(config)#exit	Exit Configure mode.

Validation

RR

Add-Path Send Capability Advertised to and Received From 6pe Peers:

```
RR#show bgp neighbors 1.1.1.1
BGP neighbor is 1.1.1.1, remote AS 100, local AS 100, internal link
  BGP version 4, remote router ID 1.1.1.1
  BGP state = Established, up for 00:03:03
  Last read 00:03:03, hold time is 90, keepalive interval is 30 seconds
  Neighbor capabilities:
    Route refresh: advertised and received (old and new)
    Address family IPv4 Unicast: advertised and received
    Address family IPv6 Labeled-Unicast Unicast: advertised and received
  Received 35 messages, 0 notifications, 0 in queue
  Sent 41 messages, 1 notifications, 0 in queue
  Route refresh request: received 0, sent 0
  Minimum time between advertisement runs is 5 seconds
  Update source is 2.2.2.2
For address family: IPv4 Unicast
  BGP table version 1, neighbor version 1
```

Index 1, Offset 0, Mask 0x2
AIGP is enabled
Community attribute sent to this neighbor (both)
0 accepted prefixes
0 announced prefixes

For address family: IPv6 Labeled-Unicast Unicast
BGP table version 6, neighbor version 6
Index 1, Offset 0, Mask 0x2
AF-dependant capabilities:
 Add-Path Send Capability : advertised
 Add-Path Receive Capability : received
Route-Reflector Client
Community attribute sent to this neighbor (both)
0 accepted prefixes
3 announced prefixes

Connections established 2; dropped 1
Local host: 2.2.2.2, Local port: 57154
Foreign host: 1.1.1.1, Foreign port: 179
Nexthop: 2.2.2.2
Nexthop global: ::
Nexthop local: ::
BGP connection: non shared network
Last Reset: 00:03:08, due to BGP Notification sent
Notification Error Message: (Cease/Other Configuration Change.)
RR#

RR#show bgp neighbors 3.3.3.3
BGP neighbor is 3.3.3.3, remote AS 100, local AS 100, internal link
 BGP version 4, remote router ID 3.3.3.3
 BGP state = Established, up for 00:05:20
 Last read 00:05:20, hold time is 90, keepalive interval is 30 seconds
 Neighbor capabilities:
 Route refresh: advertised and received (old and new)
 Address family IPv4 Unicast: advertised and received
 Address family IPv6 Labeled-Unicast Unicast: advertised and received
 Received 41 messages, 0 notifications, 0 in queue
 Sent 44 messages, 1 notifications, 0 in queue
 Route refresh request: received 0, sent 0
 Minimum time between advertisement runs is 5 seconds
 Update source is 2.2.2.2
For address family: IPv4 Unicast
 BGP table version 1, neighbor version 1
 Index 2, Offset 0, Mask 0x4
 AIGP is enabled
 Community attribute sent to this neighbor (both)
 0 accepted prefixes
 0 announced prefixes

BGP IPv4 Additional Paths Configuration

```
For address family: IPv6 Labeled-Unicast Unicast
BGP table version 6, neighbor version 6
Index 2, Offset 0, Mask 0x4
AF-dependant capabilities:
  Add-Path Send Capability : advertised
  Add-Path Receive Capability : received
Route-Reflector Client
Community attribute sent to this neighbor (both)
1 accepted prefixes
2 announced prefixes
```

```
Connections established 2; dropped 1
Local host: 2.2.2.2, Local port: 179
Foreign host: 3.3.3.3, Foreign port: 32841
Nexthop: 2.2.2.2
Nexthop global: ::
Nexthop local: ::
BGP connection: non shared network
Last Reset: 00:05:25, due to BGP Notification sent
Notification Error Message: (Cease/Other Configuration Change.)
RR#
```

```
RR#show bgp neighbors 4.4.4.4
BGP neighbor is 4.4.4.4, remote AS 100, local AS 100, internal link
  BGP version 4, remote router ID 4.4.4.4
  BGP state = Established, up for 00:05:47
  Last read 00:05:47, hold time is 90, keepalive interval is 30 seconds
  Neighbor capabilities:
    Route refresh: advertised and received (old and new)
    Address family IPv4 Unicast: advertised and received
    Address family IPv6 Labeled-Unicast Unicast: advertised and received
  Received 42 messages, 0 notifications, 0 in queue
  Sent 46 messages, 1 notifications, 0 in queue
  Route refresh request: received 0, sent 0
  Minimum time between advertisement runs is 5 seconds
  Update source is 2.2.2.2
For address family: IPv4 Unicast
  BGP table version 1, neighbor version 1
  Index 3, Offset 0, Mask 0x8
  AIGP is enabled
  Community attribute sent to this neighbor (both)
  0 accepted prefixes
  0 announced prefixes
```

```
For address family: IPv6 Labeled-Unicast Unicast
BGP table version 6, neighbor version 6
Index 3, Offset 0, Mask 0x8
AF-dependant capabilities:
```

```
Add-Path Send Capability : advertised
Add-Path Receive Capability : received
Route-Reflector Client
Community attribute sent to this neighbor (both)
1 accepted prefixes
2 announced prefixes

Connections established 2; dropped 1
Local host: 2.2.2.2, Local port: 179
Foreign host: 4.4.4.4, Foreign port: 42015
Nexthop: 2.2.2.2
Nexthop global: ::
Nexthop local: ::
BGP connection: non shared network
Last Reset: 00:05:47, due to BGP Notification received
Notification Error Message: (Cease/Administratively Reset.)
RR#
```

```
RR#show bgp neighbors 5.5.5.5
BGP neighbor is 5.5.5.5, remote AS 100, local AS 100, internal link
  BGP version 4, remote router ID 5.5.5.5
  BGP state = Established, up for 00:07:58
  Last read 00:07:58, hold time is 90, keepalive interval is 30 seconds
  Neighbor capabilities:
    Route refresh: advertised and received (old and new)
    Address family IPv4 Unicast: advertised and received
    Address family IPv6 Labeled-Unicast Unicast: advertised and received
  Received 47 messages, 0 notifications, 0 in queue
  Sent 49 messages, 1 notifications, 0 in queue
  Route refresh request: received 0, sent 0
  Minimum time between advertisement runs is 5 seconds
  Update source is 2.2.2.2
For address family: IPv4 Unicast
  BGP table version 1, neighbor version 1
  Index 4, Offset 0, Mask 0x10
  AIGP is enabled
  Community attribute sent to this neighbor (both)
  0 accepted prefixes
  0 announced prefixes

For address family: IPv6 Labeled-Unicast Unicast
  BGP table version 6, neighbor version 6
  Index 4, Offset 0, Mask 0x10
  AF-dependant capabilities:
    Add-Path Send Capability : advertised
    Add-Path Receive Capability : received
  Route-Reflector Client
  Community attribute sent to this neighbor (both)
  1 accepted prefixes
```

BGP IPv4 Additional Paths Configuration

2 announced prefixes

Connections established 2; dropped 1
Local host: 2.2.2.2, Local port: 52433
Foreign host: 5.5.5.5, Foreign port: 179
Nexthop: 2.2.2.2
Nexthop global: ::
Nexthop local: ::
BGP connection: non shared network
Last Reset: 00:08:03, due to BGP Notification sent
Notification Error Message: (Cease/Other Configuration Change.)

IPV6 LABELED-UNICAST Prefix Advertised to All 6pe Peers With All Addpaths:

```
RR#show bgp ipv6 labeled-unicast
Status codes: s suppressed, d damped, h history, a add-path, * valid, > best, i -
internal, l - labeled
              S Stale
Origin codes: i - IGP, e - EGP, ? - incomplete
```

Network	Next Hop	Metric	LocPrf	Weight	Path
*>i 2222::2/128	::ffff:3.3.3.3		0	100	0
300 i					
*a i	::ffff:4.4.4.4		0	100	0
300 i					
*a i	::ffff:5.5.5.5		0	100	0
300 i					

Announced routes count = 0
Accepted routes count = 3
RR#

```
RR#show bgp ipv6 labeled-unicast2222::2
```

```
300, (Received from a RR-client)
::ffff:3.3.3.3 (metric 11) from 3.3.3.3 (3.3.3.3)
Origin IGP, metric 0, localpref 100, label 24960, valid, internal, best
```

```
rx path_id: -1      tx path_id: 0
Advertised to non peer-group peers:
 1.1.1.1      4.4.4.4      5.5.5.5
Last update: Fri Mar 15 04:09:48 2019
```

```
300, (Received from a RR-client)
::ffff:4.4.4.4 (metric 11) from 4.4.4.4 (4.4.4.4)
Origin IGP, metric 0, localpref 100, label 24960, valid, internal, add-path
```

```
rx path_id: -1      tx path_id: 1
Advertised to non peer-group peers:
 1.1.1.1      3.3.3.3      5.5.5.5
Last update: Fri Mar 15 04:09:48 2019
```

```

300, (Received from a RR-client)
::ffff:5.5.5.5 (metric 11) from 5.5.5.5 (5.5.5.5)
  Origin IGP, metric 0, localpref 100, label 24960, valid, internal, add-path

  rx path_id: -1      tx path_id: 2
  Advertised to non peer-group peers:
    1.1.1.1      3.3.3.3      4.4.4.4
  Last update: Fri Mar 15 04:09:48 2019

```

PE1

```

PE1#show bgp ipv6 labeled-unicast
Status codes: s suppressed, d damped, h history, a add-path, * valid, > best, i -
internal, l - labeled
              S Stale
Origin codes: i - IGP, e - EGP, ? - incomplete

   Network          Next Hop           Metric   LocPrf   Weight Path
*>i 2222::2/128      ::ffff:3.3.3.3          0         100      0
300 i
* i  l              ::ffff:4.4.4.4          0         100      0
300 i
* i  l              ::ffff:5.5.5.5          0         100      0
300 i
  Announced routes count = 0
  Accepted routes count = 3
PE1#

```

PE2

```

PE2#show bgp ipv6 labeled-unicast
Status codes: s suppressed, d damped, h history, a add-path, * valid, > best, i -
internal, l - labeled
              S Stale
Origin codes: i - IGP, e - EGP, ? - incomplete

   Network          Next Hop           Metric   LocPrf   Weight Path
*>i 2222::2/128      ::ffff:4.4.4.4          0         100      0
300 i
* i  l              ::ffff:5.5.5.5          0         100      0
300 i
  Announced routes count = 0
  Accepted routes count = 2
PE2#
PE2#show bgp ipv6 labeled-unicast 2222::2
300
2001::2(fe80::5054:ff:fe18:619a) from 2001::2 (10.12.65.71)
(fe80::5054:ff:fe18:619a)
  Origin IGP, metric 0, localpref 100, valid, external, best

  Not advertised to any peer

```

BGP IPv4 Additional Paths Configuration

Last update: Fri Mar 15 03:57:09 2019

300

::ffff:4.4.4.4 (metric 12) from 2.2.2.2 (2.2.2.2)
Origin IGP, metric 0, localpref 100, label 24960, valid, internal

Originator: 4.4.4.4, Cluster list: 2.2.2.2
rx path_id: 1 tx path_id: -1
Not advertised to any peer
Last update: Fri Mar 15 04:10:00 2019

300

::ffff:4.4.4.4 (metric 12) from 2.2.2.2 (2.2.2.2)
Origin IGP, metric 0, localpref 100, label 24960, valid, internal, best

Originator: 4.4.4.4, Cluster list: 2.2.2.2
rx path_id: 1 tx path_id: -1
Not advertised to any peer
Last update: Fri Mar 15 04:10:00 2019

300

::ffff:5.5.5.5 (metric 12) from 2.2.2.2 (2.2.2.2)
Origin IGP, metric 0, localpref 100, label 24960, valid, internal

Originator: 5.5.5.5, Cluster list: 2.2.2.2
rx path_id: 2 tx path_id: -1
Not advertised to any peer
Last update: Fri Mar 15 04:10:00 2019

PE3

PE3#show bgp ipv6 labeled-unicast

Status codes: s suppressed, d damped, h history, a add-path, * valid, > best, i - internal, l - labeled

S Stale

Origin codes: i - IGP, e - EGP, ? -incomplete

Network	Next Hop	Metric	LocPrf	Weight	Path
*>i 2222::2/128	::ffff:3.3.3.3		0	100	0
300 i					
* i	::ffff:5.5.5.5		0	100	0
300 i					

Announced routes count = 0

Accepted routes count = 2

PE3#

PE3#show bgp ipv6 labeled-unicast 2222::2

BGP routing table entry for 2222::2

300

::ffff:3.3.3.3 (metric 12) from 2.2.2.2 (2.2.2.2)
Origin IGP, metric 0, localpref 100, label 24960, valid, internal, best

```

Originator: 3.3.3.3, Cluster list: 2.2.2.2
rx path_id: 0      tx path_id: -1
Not advertised to any peer
Last update: Fri Mar 15 04:09:56 2019

```

300

```

::ffff:5.5.5.5 (metric 12) from 2.2.2.2 (2.2.2.2)
Origin IGP, metric 0, localpref 100, label 24960, valid, internal

```

```

Originator: 5.5.5.5, Cluster list: 2.2.2.2
rx path_id: 2      tx path_id: -1
Not advertised to any peer
Last update: Fri Mar 15 04:10:00 2019

```

PE4

```
PE4#show bgp ipv6 labeled-unicast
```

```
Status codes: s suppressed, d damped, h history, a add-path, * valid, > best, i -
internal, l - labeled
```

```
S Stale
```

```
Origin codes: i - IGP, e - EGP, ? - incomplete
```

Network	Next Hop	Metric	LocPrf	Weight	Path
*>i:l 2222::2/128	::ffff:3.3.3.3		0	100	0

```
300 i
Announced routes count = 0
```

```
Accepted routes count = 1
```

```
PE4#
```

```
PE4#show bgp ipv6 labeled-unicast 2222::2
```

300

```

::ffff:3.3.3.3 (metric 12) from 2.2.2.2 (2.2.2.2)
Origin IGP, metric 0, localpref 100, label 24960, valid, internal, best

```

```

Originator: 3.3.3.3, Cluster list: 2.2.2.2
rx path_id: 0      tx path_id: -1
Not advertised to any peer
Last update: Fri Mar 15 04:09:57 2019

```

300

```

::ffff:4.4.4.4 (metric 12) from 2.2.2.2 (2.2.2.2)
Origin IGP, metric 0, localpref 100, label 24960, valid, internal

```

```

Originator: 4.4.4.4, Cluster list: 2.2.2.2
rx path_id: 1      tx path_id: -1
Not advertised to any peer
Last update: Fri Mar 15 04:09:57 2019

```

CE1

```
CE1#show bgp ipv6
```

BGP IPv4 Additional Paths Configuration

BGP table version is 2, local router ID is 10.12.65.70

Status codes: s suppressed, d damped, h history, a add-path, g group-best, * valid, > best, i - internal, l - labeled

S Stale

Origin codes: i - IGP, e - EGP, ? - incomplete

	Network	Next Hop	Metric	LocPrf	Weight	Path
*>	2222::2/128	1001::2(fe80::5054:ff:feaa:791f)	0	100	0	100 300 i

Total number of prefixes 1

BGP Addpath Selection Configuration Best 2 Under Address-family ipv6 labeled-unicast

RR

RR(config)#router bgp 100	Configure router bgp mode
RR(config-router)#address-family ipv6 labeled-unicast	Enter BGP address-family ipv6 labeled-unicast mode
RR(config-router-af)#no bgp additional-paths select all	Unconfigure RR to select All addpaths
RR(config-router-af)#bgp additional-paths select best 2	Configure RR to select best 2 addpaths
RR(config-router-af)#exit-address-family	Exit bgp address-family mode.
RR(config-router)#exit	Exit Router BGP mode.
RR(config)#commit	Apply commit
RR(config)#exit	Exit Configure mode.

Validation

RR

RR#show bgp ipv6 labeled-unicast

Status codes: s suppressed, d damped, h history, a add-path, * valid, > best, i - internal, l - labeled

S Stale

Origin codes: i - IGP, e - EGP, ? - incomplete

	Network	Next Hop	Metric	LocPrf	Weight	Path
*>il	2222::2/128	::ffff:3.3.3.3		0	100	0
300 i						
*ail		::ffff:4.4.4.4		0	100	0
300 i						
* il		::ffff:5.5.5.5		0	100	0
300 i						

Announced routes count = 0

Accepted routes count = 3

RR#

RR#

```
RR#show bgp ipv6 labeled-unicast2222::2
```

```
300, (Received from a RR-client)
```

```
::ffff:3.3.3.3 (metric 11) from 3.3.3.3 (3.3.3.3)
```

```
Origin IGP, metric 0, localpref 100, label 24960, valid, internal, best
```

```
rx path_id: -1 tx path_id: 0
```

```
Advertised to non peer-group peers:
```

```
1.1.1.1 4.4.4.4 5.5.5.5
```

```
Last update: Fri Mar 15 04:09:48 2019
```

```
300, (Received from a RR-client)
```

```
::ffff:4.4.4.4 (metric 11) from 4.4.4.4 (4.4.4.4)
```

```
Origin IGP, metric 0, localpref 100, label 24960, valid, internal, add-path
```

```
rx path_id: -1 tx path_id: 1
```

```
Advertised to non peer-group peers:
```

```
1.1.1.1 3.3.3.3 5.5.5.5
```

```
Last update: Fri Mar 15 04:09:48 2019
```

```
300, (Received from a RR-client)
```

```
::ffff:5.5.5.5 (metric 11) from 5.5.5.5 (5.5.5.5)
```

```
Origin IGP, metric 0, localpref 100, label 24960, valid, internal
```

```
Not advertised to any peer
```

```
Last update: Fri Mar 15 04:09:48 2019
```

PE1

```
PE1#show bgp ipv6 labeled-unicast
```

```
Status codes: s suppressed, d damped, h history, a add-path, * valid, > best, i - internal, l - labeled
```

```
S Stale
```

```
Origin codes: i - IGP, e - EGP, ? - incomplete
```

Network	Next Hop	Metric	LocPrf	Weight	Path
(Default for Unicast)					
*>i 2222::2/128	::ffff:3.3.3.3		0	100	0
300 i					
Announced routes count = 0					
Accepted routes count = 1					
*>i 2222::2/128	::ffff:3.3.3.3		0	100	0
300 i					
* i l	::ffff:4.4.4.4		0	100	0
300 i					
Announced routes count = 0					
Accepted routes count = 2					

```
PE1#
```

```
PE1#show bgp ipv6 labeled-unicast2222::2
```

```
(Default for Unicast)
```

BGP IPv4 Additional Paths Configuration

```
300
::ffff:3.3.3.3 (metric 12) from 2.2.2.2 (2.2.2.2)
  Origin IGP, metric 0, localpref 100, label 24960, valid, internal, best

  Originator: 3.3.3.3, Cluster list: 2.2.2.2
  rx path_id: 0      tx path_id: -1
  Not advertised to any peer
  Last update: Fri Mar 15 04:10:00 2019
```

```
300
::ffff:3.3.3.3 (metric 12) from 2.2.2.2 (2.2.2.2)
  Origin IGP, metric 0, localpref 100, label 24960, valid, internal, best

  Originator: 3.3.3.3, Cluster list: 2.2.2.2
  rx path_id: 0      tx path_id: -1
  Not advertised to any peer
  Last update: Fri Mar 15 05:36:25 2019
```

```
300
::ffff:4.4.4.4 (metric 12) from 2.2.2.2 (2.2.2.2)
  Origin IGP, metric 0, localpref 100, label 24960, valid, internal

  Originator: 4.4.4.4, Cluster list: 2.2.2.2
  rx path_id: 1      tx path_id: -1
  Not advertised to any peer
  Last update: Fri Mar 15 05:37:00 2019
```

PE2

```
PE2#show bgp ipv6 labeled-unicast
Status codes: s suppressed, d damped, h history, a add-path, * valid, > best, i -
internal, l - labeled
              S Stale
Origin codes: i - IGP, e - EGP, ? - incomplete
```

Network	Next Hop	Metric	LocPrf	Weight	Path
(Default for Unicast)					
*> 2222::2/128	2001::2 (fe80::5054:ff:fe18:619a)	0	100	0	300 i
* il	::ffff:4.4.4.4		0	100	0
300 i					
Announced routes count = 1					
Accepted routes count = 1					
*>il 2222::2/128	::ffff:4.4.4.4		0	100	0
300 i					
Announced routes count = 0					
Accepted routes count = 1					

```
PE2#
PE2#show bgp ipv6 labeled-unicast2222::2
```

300

2001::2(fe80::5054:ff:fe18:619a) from 2001::2 (10.12.65.71)
(fe80::5054:ff:fe18:619a)
Origin IGP, metric 0, localpref 100, valid, external, best

Not advertised to any peer
Last update: Fri Mar 15 03:57:09 2019

300

::ffff:4.4.4.4 (metric 12) from 2.2.2.2 (2.2.2.2)
Origin IGP, metric 0, localpref 100, label 24960, valid, internal

Originator: 4.4.4.4, Cluster list: 2.2.2.2
rx path_id: 1 tx path_id: -1
Not advertised to any peer
Last update: Fri Mar 15 05:37:00 2019

300

::ffff:4.4.4.4 (metric 12) from 2.2.2.2 (2.2.2.2)
Origin IGP, metric 0, localpref 100, label 24960, valid, internal, best

Originator: 4.4.4.4, Cluster list: 2.2.2.2
rx path_id: 1 tx path_id: -1
Not advertised to any peer
Last update: Fri Mar 15 05:37:00 2019

PE3

PE3#show bgp ipv6 labeled-unicast

Status codes: s suppressed, d damped, h history, a add-path, * valid, > best, i -
internal, l - labeled
S Stale

Origin codes: i - IGP, e - EGP, ? - incomplete

Network	Next Hop	Metric	LocPrf	Weight	Path
*>i1 2222::2/128	::ffff:3.3.3.3		0	100	0

300 i
Announced routes count = 0
Accepted routes count = 1

PE3#

PE3#show bgp ipv6 labeled-unicast2222::2

300

3001::2(fe80::5054:ff:feee:e4fc) from 3001::2 (10.12.65.71)
(fe80::5054:ff:feee:e4fc)
Origin IGP, metric 0, localpref 100, valid, external, best

Not advertised to any peer

BGP IPv4 Additional Paths Configuration

Last update: Fri Mar 15 03:56:59 2019

300

::ffff:3.3.3.3 (metric 12) from 2.2.2.2 (2.2.2.2)
Origin IGP, metric 0, localpref 100, label 24960, valid, internal

Originator: 3.3.3.3, Cluster list: 2.2.2.2
rx path_id: 0 tx path_id: -1
Not advertised to any peer
Last update: Fri Mar 15 04:09:56 2019

300

::ffff:3.3.3.3 (metric 12) from 2.2.2.2 (2.2.2.2)
Origin IGP, metric 0, localpref 100, label 24960, valid, internal, best

Originator: 3.3.3.3, Cluster list: 2.2.2.2
rx path_id: 0 tx path_id: -1
Not advertised to any peer
Last update: Fri Mar 15 05:36:22 2019

PE4

PE4#show bgp ipv6 labeled-unicast

Status codes: s suppressed, d damped, h history, a add-path, * valid, > best, i - internal, l - labeled

S Stale

Origin codes: i - IGP, e - EGP, ? - incomplete

Network	Next Hop	Metric	LocPrf	Weight	Path
*>i l 2222::2/128	::ffff:3.3.3.3		0	100	0
300 i					
* i l	::ffff:4.4.4.4		0	100	0
300 i					

Announced routes count = 0

Accepted routes count = 2

PE4#

PE4#show bgp ipv6 labeled-unicast2222::2

300

::ffff:3.3.3.3 (metric 12) from 2.2.2.2 (2.2.2.2)
Origin IGP, metric 0, localpref 100, label 24960, valid, internal, best

Originator: 3.3.3.3, Cluster list: 2.2.2.2
rx path_id: 0 tx path_id: -1
Not advertised to any peer
Last update: Fri Mar 15 05:36:26 2019

300

::ffff:4.4.4.4 (metric 12) from 2.2.2.2 (2.2.2.2)

Origin IGP, metric 0, localpref 100, label 24960, valid, internal

Originator: 4.4.4.4, Cluster list: 2.2.2.2
 rx path_id: 1 tx path_id: -1
 Not advertised to any peer
 Last update: Fri Mar 15 05:36:59 2019

BGP Addpath Selection Configuration Best 3 Under Address-family ipv6 labeled-unicast

RR

RR(config)#router bgp 100	Configure router bgp mode
RR(config-router)#address-family ipv6 labeled-unicast	Enter BGP address-family ipv6 labeled-unicast mode
RR(config-router-af)#no bgp additional-paths select best	Unconfigure RR to select Best 2 addpaths
RR(config-router-af)#bgp additional-paths select best 3	Configure RR to select best 3 addpaths
RR(config-router-af)#exit-address-family	Exit bgp address-family mode.
RR(config-router)#exit	Exit Router BGP mode.
RR(config)#commit	Apply commit
RR(config)#exit	Exit Configure mode.

Validation

RR

```
RR#show bgp ipv6 labeled-unicast
Status codes: s suppressed, d damped, h history, a add-path, * valid, > best, i -
internal, l - labeled
              S Stale
Origin codes: i - IGP, e - EGP, ? - incomplete
```

Network	Next Hop	Metric	LocPrf	Weight	Path
*>i1 2222::2/128	::ffff:3.3.3.3		0	100	0
300 i					
*ail	::ffff:4.4.4.4		0	100	0
300 i					
*ail	::ffff:5.5.5.5		0	100	0
300 i					

Announced routes count = 0

Accepted routes count = 3

RR#

```
RR#show bgp ipv6 labeled-unicast2222::2
```

300, (Received from a RR-client)

::ffff:3.3.3.3 (metric 11) from 3.3.3.3 (3.3.3.3)

Origin IGP, metric 0, localpref 100, label 24960, valid, internal, best

```
rx path_id: -1      tx path_id: 0
Advertised to non peer-group peers:
 1.1.1.1      4.4.4.4      5.5.5.5
Last update: Fri Mar 15 04:09:48 2019
```

300, (Received from a RR-client)

```
::ffff:4.4.4.4 (metric 11) from 4.4.4.4 (4.4.4.4)
Origin IGP, metric 0, localpref 100, label 24960, valid, internal, add-path
```

```
rx path_id: -1      tx path_id: 1
Advertised to non peer-group peers:
 1.1.1.1      3.3.3.3      5.5.5.5
Last update: Fri Mar 15 04:09:48 2019
```

300, (Received from a RR-client)

```
::ffff:5.5.5.5 (metric 11) from 5.5.5.5 (5.5.5.5)
Origin IGP, metric 0, localpref 100, label 24960, valid, internal, add-path
```

```
rx path_id: -1      tx path_id: 2
Advertised to non peer-group peers:
 1.1.1.1      3.3.3.3      4.4.4.4
Last update: Fri Mar 15 04:09:48 2019
```

PE1

PE1#show bgp ipv6 labeled-unicast

Status codes: s suppressed, d damped, h history, a add-path, * valid, > best, i - internal, l - labeled

S Stale

Origin codes: i - IGP, e - EGP, ? - incomplete

Network	Next Hop	Metric	LocPrf	Weight	Path
*>i1 2222::2/128	::ffff:3.3.3.3		0	100	0
300 i					
* i1	::ffff:4.4.4.4		0	100	0
300 i					
* i1	::ffff:5.5.5.5		0	100	0
300 i					

Announced routes count = 0

Accepted routes count = 3

PE1#

PE1#show bgp ipv6 labeled-unicast2222::2

300

```
::ffff:3.3.3.3 (metric 12) from 2.2.2.2 (2.2.2.2)
Origin IGP, metric 0, localpref 100, label 24960, valid, internal, best
```

Originator: 3.3.3.3, Cluster list: 2.2.2.2

```
rx path_id: 0      tx path_id: -1
```

Not advertised to any peer
Last update: Fri Mar 15 05:55:27 2019

300

::ffff:4.4.4.4 (metric 12) from 2.2.2.2 (2.2.2.2)
Origin IGP, metric 0, localpref 100, label 24960, valid, internal

Originator: 4.4.4.4, Cluster list: 2.2.2.2
rx path_id: 1 tx path_id: -1
Not advertised to any peer
Last update: Fri Mar 15 05:55:58 2019

300

::ffff:5.5.5.5 (metric 12) from 2.2.2.2 (2.2.2.2)
Origin IGP, metric 0, localpref 100, label 24960, valid, internal

Originator: 5.5.5.5, Cluster list: 2.2.2.2
rx path_id: 2 tx path_id: -1
Not advertised to any peer
Last update: Fri Mar 15 05:55:58 2019

PE2

PE2#show bgp ipv6 labeled-unicast

Status codes: s suppressed, d damped, h history, a add-path, * valid, > best, i - internal, l - labeled

S Stale

Origin codes: i - IGP, e - EGP, ? - incomplete

Network	Next Hop	Metric	LocPrf	Weight	Path
*>i 2222::2/128	::ffff:4.4.4.4		0	100	0
300 i					
* i l	::ffff:5.5.5.5		0	100	0
300 i					

Announced routes count = 0

Accepted routes count = 2

PE2#

PE2#show bgp ipv6 labeled-unicast2222::2

300

::ffff:4.4.4.4 (metric 12) from 2.2.2.2 (2.2.2.2)
Origin IGP, metric 0, localpref 100, label 24960, valid, internal, best

Originator: 4.4.4.4, Cluster list: 2.2.2.2
rx path_id: 1 tx path_id: -1
Not advertised to any peer
Last update: Fri Mar 15 05:55:59 2019

300

BGP IPv4 Additional Paths Configuration

```
::ffff:5.5.5.5 (metric 12) from 2.2.2.2 (2.2.2.2)
  Origin IGP, metric 0, localpref 100, label    24960, valid, internal

  Originator: 5.5.5.5, Cluster list: 2.2.2.2
  rx path_id: 2      tx path_id: -1
  Not advertised to any peer
  Last update: Fri Mar 15 05:55:59 2019
```

PE3

```
PE3#show bgp ipv6 labeled-unicast
Status codes: s suppressed, d damped, h history, a add-path, * valid, > best, i -
internal, l - labeled
              S Stale
Origin codes: i - IGP, e - EGP, ? - incomplete
```

Network	Next Hop	Metric	LocPrf	Weight	Path
*>i1 2222::2/128	::ffff:3.3.3.3		0	100	0
300 i					
* i1	::ffff:5.5.5.5		0	100	0
300 i					

Announced routes count = 0
Accepted routes count = 2

PE3#

```
PE3#show bgp ipv6 labeled-unicast2222::2
```

```
300
  ::ffff:3.3.3.3 (metric 12) from 2.2.2.2 (2.2.2.2)
  Origin IGP, metric 0, localpref 100, label    24960, valid, internal, best

  Originator: 3.3.3.3, Cluster list: 2.2.2.2
  rx path_id: 0      tx path_id: -1
  Not advertised to any peer
  Last update: Fri Mar 15 05:55:26 2019
```

```
300
  ::ffff:5.5.5.5 (metric 12) from 2.2.2.2 (2.2.2.2)
  Origin IGP, metric 0, localpref 100, label    24960, valid, internal

  Originator: 5.5.5.5, Cluster list: 2.2.2.2
  rx path_id: 2      tx path_id: -1
  Not advertised to any peer
  Last update: Fri Mar 15 05:55:57 2019
```

PE4

```
PE4#show bgp ipv6 labeled-unicast
Status codes: s suppressed, d damped, h history, a add-path, * valid, > best, i -
internal, l - labeled
              S Stale
Origin codes: i - IGP, e - EGP, ? - incomplete
```

```

Network          Next Hop          Metric  LocPrf  Weight Path
*>i1 2222::2/128  ::ffff:3.3.3.3    0        100     0
300 i
* i1             ::ffff:4.4.4.4    0        100     0
300 i
Announced routes count = 0
Accepted routes count = 2
PE4#show bgp ipv6 labeled-unicast2222::2

300
::ffff:3.3.3.3 (metric 12) from 2.2.2.2 (2.2.2.2)
  Origin IGP, metric 0, localpref 100, label    24960, valid, internal, best

  Originator: 3.3.3.3, Cluster list: 2.2.2.2
  rx path_id: 0      tx path_id: -1
  Not advertised to any peer
  Last update: Fri Mar 15 05:55:28 2019

300
::ffff:4.4.4.4 (metric 12) from 2.2.2.2 (2.2.2.2)
  Origin IGP, metric 0, localpref 100, label    24960, valid, internal

  Originator: 4.4.4.4, Cluster list: 2.2.2.2
  rx path_id: 1      tx path_id: -1
  Not advertised to any peer
  Last update: Fri Mar 15 05:55:59 2019

```

BGP Addpath Selection Configuration all At Neighbor-level under Address-family ipv6 labeled-unicast

RR

RR(config)#router bgp 100	Configure router bgp mode
RR(config-router)#address-family ipv6 labeled-unicast	Enter BGP address-family ipv6 labeled-unicast mode
RR(config-router-af)#neighbor 1.1.1.1 advertise additional-paths all	Configure RR to advertise All addpaths to PE1
RR(config-router-af)#exit-address-family	Exit bgp address-family mode.
RR(config-router)#exit	Exit Router BGP mode.
RR(config)#commit	Apply commit
RR(config)#exit	Exit Configure mode.

Validation

PE1

```
PE1#show bgp ipv6 labeled-unicast
```

BGP IPv4 Additional Paths Configuration

Status codes: s suppressed, d damped, h history, a add-path, * valid, > best, i - internal, l - labeled

S Stale

Origin codes: i - IGP, e - EGP, ? - incomplete

Network	Next Hop	Metric	LocPrf	Weight	Path
*>i l 2222::2/128	::ffff:3.3.3.3		0	100	0
300 i					
* i l	::ffff:4.4.4.4		0	100	0
300 i					
* i l	::ffff:5.5.5.5		0	100	0
300 i					

Announced routes count = 0

Accepted routes count = 3

PE1#show bgp ipv6 labeled-unicast2222::2

300

::ffff:3.3.3.3 (metric 12) from 2.2.2.2 (2.2.2.2)

Origin IGP, metric 0, localpref 100, label 24960, valid, internal, best

Originator: 3.3.3.3, Cluster list: 2.2.2.2

rx path_id: 0 tx path_id: -1

Not advertised to any peer

Last update: Fri Mar 15 06:12:37 2019

300

::ffff:4.4.4.4 (metric 12) from 2.2.2.2 (2.2.2.2)

Origin IGP, metric 0, localpref 100, label 24960, valid, internal

Originator: 4.4.4.4, Cluster list: 2.2.2.2

rx path_id: 1 tx path_id: -1

Not advertised to any peer

Last update: Fri Mar 15 06:12:57 2019

300

::ffff:5.5.5.5 (metric 12) from 2.2.2.2 (2.2.2.2)

Origin IGP, metric 0, localpref 100, label 24960, valid, internal

Originator: 5.5.5.5, Cluster list: 2.2.2.2

rx path_id: 2 tx path_id: -1

Not advertised to any peer

Last update: Fri Mar 15 06:12:57 2019

BGP Addpath Selection Configuration Best 2 at Neighbor-level under Address-family ipv6 labeled-unicast

RR

RR(config)#router bgp 100	Configure router bgp mode
RR(config-router)#address-family ipv6 labeled-unicast	Enter BGP address-family ipv6 labeled-unicast mode
RR(config-router-af)#no neighbor 1.1.1.1 advertise additional-paths all	Configure RR to advertise All addpaths to PE1
RR(config-router-af)#neighbor 1.1.1.1 advertise additional-paths best 2	Configure RR to advertise Best 2 addpaths to PE1
RR(config-router-af)#exit-address-family	Exit bgp address-family mode.
RR(config-router)#exit	Exit Router BGP mode.
RR(config)#commit	Apply commit
RR(config)#exit	Exit Configure mode.

Validation

PE1

```
PE1#show bgp ipv6 labeled-unicast
```

```
Status codes: s suppressed, d damped, h history, a add-path, * valid, > best, i - internal, l - labeled
```

```
          S Stale
```

```
Origin codes: i - IGP, e - EGP, ? - incomplete
```

Network	Next Hop	Metric	LocPrf	Weight	Path
*>i1 2222::2/128	::ffff:3.3.3.3		0	100	0
300 i					
* i1	::ffff:4.4.4.4		0	100	0
300 i					

```
Announced routes count = 0
```

```
Accepted routes count = 2
```

```
PE1#show bgp ipv6 labeled-unicast2222::2
```

```
300
```

```
::ffff:3.3.3.3 (metric 12) from 2.2.2.2 (2.2.2.2)
```

```
Origin IGP, metric 0, localpref 100, label 24960, valid, internal, best
```

```
Originator: 3.3.3.3, Cluster list: 2.2.2.2
```

```
rx path_id: 0 tx path_id: -1
```

```
Not advertised to any peer
```

```
Last update: Fri Mar 15 06:19:18 2019
```

```
300
```

```
::ffff:4.4.4.4 (metric 12) from 2.2.2.2 (2.2.2.2)
```

```
Origin IGP, metric 0, localpref 100, label 24960, valid, internal
```

BGP IPv4 Additional Paths Configuration

```
Originator: 4.4.4.4, Cluster list: 2.2.2.2
rx_path_id: 1      tx_path_id: -1
Not advertised to any peer
Last update: Fri Mar 15 06:19:58 2019
```

BGP Addpath Selection Configuration Best 3 At Neighbor-level under Address-family ipv6 labeled-unicast

RR

RR(config)#router bgp 100	Configure router bgp mode
RR(config-router)#address-family ipv6 labeled-unicast	Enter BGP address-family ipv6 labeled-unicast mode
RR(config-router-af)#no neighbor 1.1.1.1 advertise additional-paths best	Configure RR to advertise All addpaths to PE1
RR(config-router-af)#neighbor 1.1.1.1 advertise additional-paths best 3	Configure RR to advertise Best 3 addpaths to PE1
RR(config-router-af)#exit-address-family	Exit bgp address-family mode.
RR(config-router)#exit	Exit Router BGP mode.
RR(config)#commit	Apply commit
RR(config)#exit	Exit Configure mode.

Validation

PE1

```
PE1#show bgp ipv6 labeled-unicast
Status codes: s suppressed, d damped, h history, a add-path, * valid, > best, i -
internal, l - labeled
              S Stale
Origin codes: i - IGP, e - EGP, ? - incomplete
```

Network	Next Hop	Metric	LocPrf	Weight	Path
*>i1 2222::2/128	::ffff:3.3.3.3		0	100	0
300 i					
* i1	::ffff:4.4.4.4		0	100	0
300 i					
* i1	::ffff:5.5.5.5		0	100	0
300 i					

```
Announced routes count = 0
Accepted routes count = 3
PE1#
PE1#show bgp ipv6 labeled-unicast2222::2
```

```
300
::ffff:3.3.3.3 (metric 12) from 2.2.2.2 (2.2.2.2)
Origin IGP, metric 0, localpref 100, label 24960, valid, internal, best
```

```

Originator: 3.3.3.3, Cluster list: 2.2.2.2
rx path_id: 0      tx path_id: -1
Not advertised to any peer
Last update: Fri Mar 15 06:21:35 2019

```

300

```

::ffff:4.4.4.4 (metric 12) from 2.2.2.2 (2.2.2.2)
Origin IGP, metric 0, localpref 100, label 24960, valid, internal

```

```

Originator: 4.4.4.4, Cluster list: 2.2.2.2
rx path_id: 1      tx path_id: -1
Not advertised to any peer
Last update: Fri Mar 15 06:22:01 2019

```

300

```

::ffff:5.5.5.5 (metric 12) from 2.2.2.2 (2.2.2.2)
Origin IGP, metric 0, localpref 100, label 24960, valid, internal

```

```

Originator: 5.5.5.5, Cluster list: 2.2.2.2
rx path_id: 2      tx path_id: -1
Not advertised to any peer
Last update: Fri Mar 15 06:22:01 2019

```

Disable BGP Addpath for a Specific 6pe Neighbor

RR

RR(config)#router bgp 100	Configure router bgp mode
RR(config-router)#address-family ipv6 labeled-unicast	Enter BGP address-family ipv6 labeled-unicast mode
RR(config-router-af)#no neighbor 1.1.1.1 advertise additional-paths best	Configure RR to advertise All addpaths to PE1
RR(config-router-af)#neighbor 1.1.1.1 additional-paths disable	Configure RR to Disable Addpath for the 6pe neighbor PE1
RR(config-router-af)#exit-address-family	Exit bgp address-family mode.
RR(config-router)#exit	Exit Router BGP mode.
RR(config)#commit	Apply commit
RR(config)#exit	Exit Configure mode.

Validation

PE1

```

PE1#show bgp ipv6 labeled-unicast

```

```

Status codes: s suppressed, d damped, h history, a add-path, * valid, > best, i -
internal, l - labeled

```

```

S Stale

```

```

Origin codes: i - IGP, e - EGP, ? - incomplete

```

BGP IPv4 Additional Paths Configuration

Network	Next Hop	Metric	LocPrf	Weight	Path
*>il 2222::2/128	::ffff:3.3.3.3		0	100	0

300 i
Announced routes count = 0
Accepted routes count = 1
PE1#show bgp ipv6 labeled-unicast2222::2

300
::ffff:3.3.3.3 (metric 12) from 2.2.2.2 (2.2.2.2)
Origin IGP, metric 0, localpref 100, label 24960, valid, internal, best

Originator: 3.3.3.3, Cluster list: 2.2.2.2
Not advertised to any peer
Last update: Fri Mar 15 06:25:58 2019

Validation

CE1

```
CE1#show bgp ipv6 summary
BGP router identifier 10.12.65.66, local AS number 200
BGP table version is 1
1 BGP AS-PATH entries
0 BGP community entries
```

Neighbor	Down	State/PfxRcd	V	AS	MsgRcv	MsgSen	TblVer	InQ	OutQ	Up/
1001::2			4	100	5	6	1	0	0	
00:01:40		0								

```
Total number of neighbors 1
Total number of Established sessions 1
CE1#
```

```
CE1#show bgp ipv6
BGP table version is 1, local router ID is 10.12.65.66
Status codes: s suppressed, d damped, h history, a add-path, g group-best, *
valid, > best, i - internal, l - labeled
                S Stale
Origin codes: i - IGP, e - EGP, ? - incomplete
```

Network	Next Hop	Metric	LocPrf
Weight Path			
*> 1111::/64	::	0	100
32768 i			

```
Total number of prefixes 1
CE1#
```

CE2

```
CE2#show bgp ipv6 summary
BGP router identifier 10.12.65.67, local AS number 300
BGP table version is 1
1 BGP AS-PATH entries
```

BGP IPv4 Additional Paths Configuration

0 BGP community entries

Neighbor	Down	State/PfxRcd	V	AS	MsgRcv	MsgSen	TblVer	InQ	OutQ	Up/
2002::2			4	100	7	8	1	0	0	
00:02:44		0								

Total number of neighbors 1

Total number of Established sessions 1
CE2#

CE2#show bgp ipv6

BGP table version is 1, local router ID is 10.12.65.67

Status codes: s suppressed, d damped, h history, a add-path, g group-best, * valid, > best, i - internal, l - labeled

S Stale

Origin codes: i - IGP, e - EGP, ? - incomplete

Weight	Network	Path	Next Hop	Metric	LocPrf
*>	1111::/64		::	0	100
32768	i				

Total number of prefixes 1
CE2#

PE1

PE1#show bgp ipv6

BGP table version is 2, local router ID is 1.1.1.1

Status codes: s suppressed, d damped, h history, a add-path, g group-best, * valid, > best, i - internal, l - labeled

S Stale

Origin codes: i - IGP, e - EGP, ? - incomplete

Weight	Network	Path	Next Hop	Metric	LocPrf
*>	1111::/64		1001::1(fe80::5054:ff:fe88:95f3)	0	100
200	i				0

Total number of prefixes 1

PE1#

PE1#show mpls ilm-table

Codes: > - installed ILM, * - selected ILM, p - stale ILM

K - CLI ILM, T - MPLS-TP, F - FRR ILM, u - FRR ILM In Use

Code	FEC	ILM-ID	In-Label	Out-Label	In-Intf	Out-
Intf	Nexthop	LSP-Type				
>	1111::/64	1	24960	N/A	N/A	N/A
127.0.0.1		LSP_DEFAULT				

PE1#

PE2

PE2#show bgp ipv6

BGP table version is 2, local router ID is 2.2.2.2

Status codes: s suppressed, d damped, h history, a add-path, g group-best, * valid, > best, i - internal, l - labeled

S Stale

Origin codes: i - IGP, e - EGP, ? - incomplete

Network	Next Hop	Metric	LocPrf
Weight Path			
*> 1111::/64	2002::1 (fe80::5054:ff:fe92:a520)	0	100
300 i			0

Total number of prefixes 1

PE2#

PE2#show mpls ilm-table

Codes: > - installed ILM, * - selected ILM, p - stale ILM

K - CLI ILM, T - MPLS-TP, F - FRR ILM, u - FRR ILM In Use

Code	FEC	ILM-ID	In-Label	Out-Label	In-Intf	Out-
Intf	Nexthop	LSP-Type				
>	1111::/64	1	24960	N/A	N/A	N/A
127.0.0.1		LSP_DEFAULT				

PE2#

RR

RR#show bgp ipv6 labeled-unicast all summary

BGP router identifier 3.3.3.3, local AS number 100

BGP table version is 1

2 BGP AS-PATH entries

0 BGP community entries

Neighbor	Down	State/PfxRcd	V	AS	MsgRcv	MsgSen	TblVer	InQ	OutQ	Up/
1.1.1.1			4	100	10	9	1	0	0	
00:03:36		1								
2.2.2.2			4	100	9	8	1	0	0	
00:03:01		1								
4.4.4.4			4	100	9	11	1	0	0	
00:03:36		0								

Total number of neighbors 3

Total number of Established sessions 3

RR#

RR#show bgp ipv6 labeled-unicast all

Status codes: s suppressed, d damped, h history, a add-path, gb group-best, * valid, > best, i - internal, S - stale

Network	Next Hop	In Label	Out Label
*>gi 1111::/64	::ffff:1.1.1.1		24960
*agi	::ffff:2.2.2.2		24960

RR#

RR#show bgp ipv6 labeled-unicast 1111::1/64

BGP routing table entry for 1111::/64

Paths: (2 available, best #1, table Default-IP-Routing-Table)

Not advertised to any peer

200

BGP IPv4 Additional Paths Configuration

```
      ::ffff:1.1.1.1 (metric 11) from 1.1.1.1 (1.1.1.1)
      Origin IGP, metric 0, localpref 100, Out-label 24960, In-label NA ,
valid, internal, group-best, best
      rx path_id: -1      tx path_id: 0
      Advertised to non peer-group peers:
      4.4.4.4
      Last update: Tue Dec  3 01:50:54 2019
```

300

```
      ::ffff:2.2.2.2 (metric 11) from 2.2.2.2 (2.2.2.2)
      Origin IGP, metric 0, localpref 100, Out-label 24960, In-label NA ,
valid, internal, group-best, add-path
      rx path_id: -1      tx path_id: 1
      Advertised to non peer-group peers:
      4.4.4.4
      Last update: Tue Dec  3 01:51:29 2019
```

RR#

RR#show bgp neighbors 4.4.4.4

```
BGP neighbor is 4.4.4.4, remote AS 100, local AS 100, internal link
BGP version 4, remote router ID 4.4.4.4
BGP state = Established, up for 00:04:02
Last read 00:04:02, hold time is 90, keepalive interval is 30 seconds
Neighbor capabilities:
```

```
  Route refresh: advertised and received (old and new)
  Address family IPv4 Unicast: advertised and received
  Address family IPv6 Labeled Unicast: advertised and received
```

```
Received 10 messages, 0 notifications, 0 in queue
Sent 12 messages, 0 notifications, 0 in queue
Route refresh request: received 0, sent 0
Minimum time between advertisement runs is 5 seconds
Update source is 3.3.3.3
```

For address family: IPv4 Unicast

```
BGP table version 1, neighbor version 1
Index 3, Offset 0, Mask 0x8
AIGP is enabled
Community attribute sent to this neighbor (both)
0 accepted prefixes
0 announced prefixes
```

For address family: IPv6 Labeled-Unicast

```
BGP table version 1, neighbor version 1
Index 3, Offset 0, Mask 0x8
AF-dependant capabilities:
  Add-Path Send Capability : advertised
  Add-Path Receive Capability : received
Route-Reflector Client
Community attribute sent to this neighbor (both)
0 accepted prefixes
2 announced prefixes
```

```
Connections established 1; dropped 0
Local host: 3.3.3.3, Local port: 60367
Foreign host: 4.4.4.4, Foreign port: 179
Next hop: 3.3.3.3
Next hop global: ::
Next hop local: ::
```

BGP connection: non shared network

RR#

PE3

PE3#show bgp ipv6 labeled-unicast all

Status codes: s suppressed, d damped, h history, a add-path, gb group-best, * valid, > best, i - internal, S - stale

Network	Next Hop	In Label	Out Label	
*>i 1111::/64	::ffff:1.1.1.1		-	24960
* i	::ffff:2.2.2.2		-	24960

PE3#

PE3#show bgp ipv6

BGP table version is 1, local router ID is 4.4.4.4

Status codes: s suppressed, d damped, h history, a add-path, g group-best, * valid, > best, i - internal, l - labeled

S Stale

Origin codes: i - IGP, e - EGP, ? - incomplete

Network	Next Hop	Metric	LocPrf
*>il 1111::/64	::ffff:1.1.1.1	0	100
0 200 i			
* il	::ffff:2.2.2.2	0	100
0 300 i			

Total number of prefixes 1

PE3#

CE3

CE3#show bgp ipv6 summary

BGP router identifier 10.12.65.69, local AS number 400

BGP table version is 2

1 BGP AS-PATH entries

0 BGP community entries

Neighbor	V	AS	MsgRcv	MsgSen	TblVer	InQ	OutQ	Up/
Down State/PfxRcd								
3003::1	4	100	3	2	1	0	0	
00:00:15								1

Total number of neighbors 1

Total number of Established sessions 1

CE3#

CE3#show bgp ipv6

BGP table version is 2, local router ID is 10.12.65.69

Status codes: s suppressed, d damped, h history, a add-path, g group-best, * valid, > best, i - internal, l - labeled

S Stale

Origin codes: i - IGP, e - EGP, ? - incomplete

Network	Next Hop	Metric	LocPrf
Weight Path			

```
*> 1111::/64          3003::1 (fe80::5054:ff:fe2:c8dc)
                                0          100          0
100 200 i

Total number of prefixes 1
CE3#
```

Additional Paths for 6VPE

This section explains how to configure the 6VPE additional path feature to enable advertising additional paths for a 6VPE prefix, over a 6VPE session.

Topology

The topology below illustrates CE1 and CE2 as customer edge routers connected to the Provider Edge routers PE1 and PE2 respectively over a non-default VRF. CE2 is advertising the IPv6 prefix 2222::2/128 over non-default VRF to PE2, PE3, and PE4 which further advertises the prefix to RR over 6VPE sessions. RR has the 6VPE prefix 2222::2/128 with 3 next-hops PE2, PE3, and PE4. In a normal scenario, RR advertises the 6VPE prefix 2222::2/128 to PE1 with only one path (the next-hop which is marked the “best”). But with 6VPE adopath configured on RR and PE1, RR can be made to advertise the 6VPE prefix with additional-paths to PE1

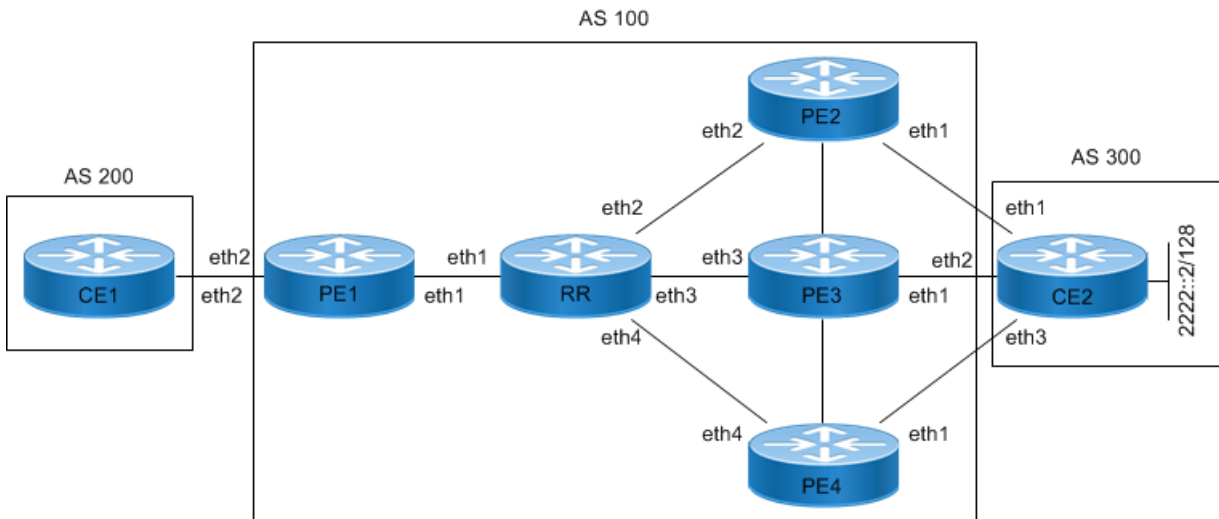

Figure 6-61: Additional Paths for 6VPE

Configuration

CE1: Interface

CE1#configure terminal	Enter configure mode.
CE1(config)#hostname CE1	Configure the hostname to CE1
CE1(config)#interface eth2	Enter the Interface mode for interface eth2.
CE1(config-if)#ipv6 address 1001::1/64	Configure IPV6 address for interface eth2
(config)#commit	Apply commit
(config)#exit	Exit Router BGP and Configure mode.

CE1: BGP

CE1(config)#router bgp 200	Enter BGP router mode
CE1(config-router)#neighbor 1001::2 remote-as 100	Configure BGP ipv6 neighbor on PE1
CE1(config-router)#address-family ipv6 unicast	Enter the address family ipv6
CE1(config-router-af)#neighbor 1001::2 activate	Activate neighbor under address family ipv6
CE1(config-router-af)#exit-address-family	Exit address family ipv6 unicast mode
CE1(config-router)#exit	Exit BGP router mode
CE1(config)#commit	Apply commit
CE1#clear bgp 1001::2	Clear BGP peer PE1

PE1: Interface

PE1#configure terminal	Enter configure mode.
PE1(config)#hostname PE1	Configure the hostname to PE1
PE1(config)#ip vrf vrf1	Configure VRF name
PE1(config-vrf)#rd 1:100	Configure Route Distinguisher value
PE1(config-vrf)#route-target both 1:200	Configure Route Target Value
PE1(config-vrf)#exit	Exit vrf mode
PE1(config)#interface eth2	Enter the Interface mode for interface eth2
PE1(config-if)#ip vrf forwarding vrf1	Configure ip vrf-forwarding on interface eth2
PE1(config-if)#ipv6 address 1001::2/64	Configure the IPv6 address for interface eth2
PE1(config-if)#exit	Exit interface mode
PE1(config)#interface lo	Enter the Interface mode for the loopback interface.
PE1(config-if)#ip address 1.1.1.1/32	Configure IPv4 address for loopback interface.
PE1(config-if)#exit	Exit interface mode
PE1(config)#interface eth1	Enter the Interface mode for interface eth1
PE1(config-if)#ip address 10.1.1.1/24	Configure the IP address for interface eth1
(config-if)#exit	Exit the interface level
(config)#commit	Apply commit
(config)#exit	Exit.

PE1: OSPF

PE1(config)#router ospf 1	Configure an OSPF instance 1
PE1(config-router)#network 10.1.1.0/24 area 0	Advertise the network towards P in Area 0
PE1(config-router)#network 1.1.1.1/32 area 0	Advertise the Loopback network in Area 0
PE1(config-router)#exit	Exit OSPF router mode

BGP IPv4 Additional Paths Configuration

PE1(config)#commit	Apply commit
PE1(config)#exit	Exit the global mode

PE1: MPLS

PE1(config)#router ldp	Enable LDP Process
PE1(config-router)#transport-address ipv4 1.1.1.1	Configure Transport address for LDP
PE1(config-router)#exit	Exit router ldp mode
PE1(config)#interface eth1	Enter the interface mode for interface eth1
PE1(config-if)#label-switching	Enable label-switching on interface eth1
PE1(config-if)#enable-ldp ipv4	Enable LDP for IPv4 on interface eth1
PE1(config-if)#exit	Exit the interface mode
PE1(config)#commit	Apply commit
PE1(config)#exit	Exit the global mode

PE1: BGP

PE1(config)#router bgp 100	Configure router bgp mode
PE1(config)#bgp router-id 1.1.1.1	Configure BGP router-id
PE1(config-router)#neighbor 2.2.2.2 remote-as 100	Configure BGP IPv4 neighbor on PE2
PE1(config-router)#neighbor 2.2.2.2 update-source 1.1.1.1	Configure the routing update source for RR as PE1's Loopback
PE1(config-router)#address-family vpnv6 unicast	Enter BGP address-family vpnv6 unicast mode
PE1(config-router-af)#neighbor 2.2.2.2 activate	Activate the neighbor RR for address-family vpnv6 unicast
PE1(config-router-af)#exit-address-family	Exit address-family ipv6 labeled-unicast mode
PE1(config-router)#address-family ipv6 vrf vrf1	Enter BGP address-family ipv6 vrf vrf1 mode
PE1(config-router)#neighbor 1001::1 remote-as 200	Configure BGP IPv6 neighbor on CE1
PE1(config-router-af)#exit-address-family	Exit address-family ipv6 vrf vrf1 mode
PE1(config-router)#exit	Exit router bgp mode
PE1(config)#exit	Exit configure mode
PE1(config)#commit	Apply commit
PE1#clear bgp ipv6 unicast 1001::1 vrf vrf1	Clear BGP neighbor CE1

RR: Interface

RR#configure terminal	Enter configure mode.
RR(config)#hostname RR	Configure hostname as RR
RR(config)#interface eth1	Enter interface mode for interface eth1
RR(config-if)#ip address 10.1.1.2/24	Configure IPv4 address for interface eth1

RR(config-if)#exit	Exit interface mode
RR(config)#interface eth2	Enter interface mode for interface eth2
RR(config-if)#ip address 20.1.1.2/24	Configure IPv4 address for interface eth2
RR(config-if)#exit	Exit interface mode
RR(config)#interface eth3	Enter interface mode for interface eth3
RR(config-if)#ip address 30.1.1.2/24	Configure IPv4 address for interface eth3
RR(config-if)#exit	Exit interface mode
RR(config)#interface eth4	Enter interface mode for interface eth4
RR(config-if)#ip address 40.1.1.2/24	Configure IPv4 address for interface eth4
RR(config-if)#exit	Exit interface mode
RR(config)#interface lo	Enter Interface mode for the loopback interface.
RR(config-if)#ip address 2.2.2.2/32	Configure IPV4 address for loopback interface.
RR(config-if)#exit	Exit Interface mode.
PE1(config)#commit	Apply commit

RR: OSPF

RR(config)#router ospf 1	Configure router OSPF instance 1
RR(config-router)#network 10.1.1.0/24 area 0	Advertise the network towards PE1 in area 0
RR(config-router)#network 20.1.1.0/24 area 0	Advertise the network towards PE2 in area 0
RR(config-router)#network 30.1.1.0/24 area 0	Advertise the network towards PE3 in area 0
RR(config-router)#network 40.1.1.0/24 area 0	Advertise the network towards PE4 in area 0
RR(config-router)#network 2.2.2.2/32 area 0	Advertise the Loopback network in area 0
RR(config-router)#exit	Exit the router ospf mode
RR(config)#commit	Apply commit

RR: MPLS

RR(config)#router ldp	Enable LDP Process
RR(config-router)#transport-address ipv4 2.2.2.2	Configure Transport address for LDP
RR(config-router)#exit	Exit router ldp mode
RR(config)#interface eth1	Enter the interface mode for interface eth1
RR(config-if)#label-switching	Enable label-switching on interface eth1
RR(config-if)#enable-ldp ipv4	Enable LDP for IPv4 on interface eth1
RR(config-if)#exit	Exit interface mode
RR(config)#interface eth2	Enter the interface mode for interface eth2
RR(config-if)#label-switching	Enable label-switching on interface eth2
RR(config-if)#enable-ldp ipv4	Enable LDP for IPv4 on interface eth2
RR(config-if)#exit	Exit interface mode
RR(config)#interface eth3	Enter the interface mode for interface eth3
RR(config-if)#label-switching	Enable label-switching on interface eth3

BGP IPv4 Additional Paths Configuration

RR(config-if)#enable-ldp ipv4	Enable LDP for IPv4 on interface eth3
RR(config-if)#exit	Exit interface mode
RR(config)#interface eth4	Enter the interface mode for interface eth4
RR(config-if)#label-switching	Enable label-switching on interface eth4
RR(config-if)#enable-ldp ipv4	Enable LDP for IPv4 on interface eth4
RR(config-if)#exit	Exit interface mode
RR(config)#commit	Apply commit
RR(config)#exit	Exit the configure terminal mode

RR: BGP

RR(config)#router bgp 100	Configure router bgp mode
RR(config)#bgp router-id 2.2.2.2	Configure BGP router-id
RR(config-router)#neighbor 1.1.1.1 remote-as 100	Configure BGP neighbor on PE1
RR(config-router)#neighbor 1.1.1.1 update-source 2.2.2.2	Configure the routing update source for PE1 as RR's Loopback
RR(config-router)#neighbor 3.3.3.3 remote-as 100	Configure BGP neighbor on PE2
RR(config-router)#neighbor 3.3.3.3 update-source 2.2.2.2	Configure the routing update source for PE2 as RR's Loopback
RR(config-router)#neighbor 4.4.4.4 remote-as 100	Configure BGP neighbor on PE3
RR(config-router)#neighbor 4.4.4.4 update-source 2.2.2.2	Configure the routing update source for PE3 as RR's Loopback
RR(config-router)#neighbor 5.5.5.5 remote-as 100	Configure BGP neighbor on PE4
RR(config-router)#neighbor 5.5.5.5 update-source 2.2.2.2	Configure the routing update source for PE4 as RR's Loopback
RR(config-router)#address-family vpnv6 unicast	Enter BGP address-family vpnv6 unicast mode
RR(config-router-af)#neighbor 1.1.1.1 activate	Activate the neighbor PE1 for address-family vpnv6 unicast
RR(config-router-af)#neighbor 1.1.1.1 route-reflector-client	Configure PE1 as route-reflector-client
RR(config-router-af)#neighbor 3.3.3.3 activate	Activate the neighbor PE2 for address-family vpnv6 unicast
RR(config-router-af)#neighbor 3.3.3.3 route-reflector-client	Configure PE2 as route-reflector-client
RR(config-router-af)#neighbor 4.4.4.4 activate	Activate the neighbor PE3 for address-family vpnv6 unicast
RR(config-router-af)#neighbor 4.4.4.4 route-reflector-client	Configure PE3 as route-reflector-client
RR(config-router-af)#neighbor 5.5.5.5 activate	Activate the neighbor PE4 for address-family vpnv6 unicast
RR(config-router-af)#neighbor 5.5.5.5 route-reflector-client	Configure PE4 as route-reflector-client
RR(config-router-af)#exit-address-family	Exit BGP address-family vpnv6 unicast mode

RR(config-router)#exit	Exit router bgp mode
RR(config)#commit	Apply commit
RR(config)#exit	Exit configure mode

PE2: Interface

PE2#configure terminal	Enter configure mode.
PE2(config)#hostname PE2	Configure the hostname to PE2
PE2(config)#ip vrf vrf1	Configure VRF name
PE2(config-vrf)#rd 1:100	Configure Route Distinguisher value
PE2(config-vrf)#route-target both 1:200	Configure Route Target Value
PE2(config-vrf)#exit	Exit vrf mode
PE2(config)#interface eth1	Enter the Interface mode for interface eth1
PE2(config-if)#ip vrf forwarding vrf1	Configure ip vrf-forwarding on interface eth1
PE2(config-if)#ipv6 address 2001::1/64	Configure the IPv6 address for interface eth1
PE2(config-if)#exit	Exit interface mode
PE2(config)#interface lo	Enter the Interface mode for the loopback interface.
PE2(config-if)#ip address 3.3.3.3/32	Configure IPV4 address for loopback interface.
PE2(config-if)#exit	Exit interface mode
PE2(config)#interface eth2	Enter the Interface mode for interface eth2
PE2(config-if)#ip address 20.1.1.1/24	Configure the IP address for interface eth2
PE2(config-if)#exit	Exit configure mode
PE2(config)#commit	Apply commit

PE2: OSPF

PE2(config)#router ospf 1	Configure an OSPF instance 1
PE2(config-router)#network 20.1.1.0/24 area 0	Advertise the network towards RR in Area 0
PE2(config-router)#network 3.3.3.3/32 area 0	Advertise the Loopback network in Area 0
PE2(config-router)#exit	Exit OSPF router mode
PE2(config)#commit	Apply commit

PE2: MPLS

PE2(config)#router ldp	Enable LDP Process
PE2(config-router)#transport-address ipv4 3.3.3.3	Configure Transport address for LDP
PE2(config-router)#exit	Exit router ldp mode
PE2(config)#interface eth2	Enter the interface mode for interface eth2
PE2(config-if)#label-switching	Enable label-switching on interface eth2
PE2(config-if)#enable-ldp ipv4	Enable LDP for IPv4 on interface eth2

BGP IPv4 Additional Paths Configuration

PE2(config-if)#exit	Exit interface mode
PE2(config)#commit	Apply commit

PE2: BGP

PE2(config)#router bgp 100	Configure router bgp mode
PE2(config)#bgp router-id 3.3.3.3	Configure BGP router-id
PE2(config-router)#neighbor 2.2.2.2 remote-as 100	Configure BGP IPv4 neighbor on RR
PE2(config-router)#neighbor 2.2.2.2 update-source 3.3.3.3	Configure the routing update source for RR as PE2's Loopback
PE2(config-router)#address-family vpnv6 unicast	Enter BGP address-family vpnv6 unicast mode
PE2(config-router-af)#neighbor 2.2.2.2 activate	Activate the neighbor RR for address-family vpnv6 unicast
PE2(config-router-af)#exit-address-family	Exit address-family ipv6 labeled-unicast mode
PE2(config-router)#address-family ipv6 vrf vrf1	Enter BGP address-family ipv6 vrf vrf1 mode
PE2(config-router)#neighbor 2001::2 remote-as 300	Configure BGP IPv6 neighbor on CE2
PE2(config-router-af)#exit-address-family	Exit address-family ipv6 vrf vrf1 mode
PE2(config-router)#exit	Exit router bgp mode
PE2(config)#commit	Apply commit
PE2(config)#exit	Exit configure mode
PE2#clear bgp ipv6 unicast 2001::2 vrf vrf1	Clear BGP neighbor CE2

PE3: Interface

PE3#configure terminal	Enter configure mode.
PE3(config)#hostname PE3	Configure the hostname to PE3
PE3(config)#ip vrf vrf1	Configure VRF name
PE3(config-vrf)#rd 1:100	Configure Route Distinguisher value
PE3(config-vrf)#route-target both 1:200	Configure Route Target Value
PE3(config-vrf)#exit	Exit vrf mode
PE3(config)#interface eth1	Enter the Interface mode for interface eth1
PE3(config-if)#ip vrf forwarding vrf1	Configure ip vrf-forwarding on interface eth1
PE3(config-if)#ipv6 address 3001::1/64	Configure the IPv6 address for interface eth1
PE3(config-if)#exit	Exit interface mode
PE3(config)#interface lo	Enter the Interface mode for the loopback interface.
PE3(config-if)#ip address 4.4.4.4/32	Configure IPV4 address for loopback interface.
PE3(config-if)#exit	Exit interface mode
PE3(config)#interface eth3	Enter the Interface mode for interface eth3
PE3(config-if)#ip address 30.1.1.1/24	Configure the IP address for interface eth3

PE3(config-if)#exit	Exit interface mode
PE3(config)#commit	Apply commit

PE3: OSPF

PE3(config)#router ospf 1	Configure an OSPF instance 1
PE3(config-router)#network 30.1.1.0/24 area 0	Advertise the network towards RR in Area 0
PE3(config-router)#network 4.4.4.4/32 area 0	Advertise the Loopback network in Area 0
PE3(config-router)#exit	Exit OSPF router mode
PE3(config)#commit	Apply commit

PE3: MPLS

PE3(config)#router ldp	Enable LDP Process
PE3(config-router)#transport-address ipv4 4.4.4.4	Configure Transport address for LDP
PE3(config-router)#exit	Exit router ldp mode
PE3(config)#interface eth3	Enter the interface mode for interface eth3
PE3(config-if)#label-switching	Enable label-switching on interface eth3
PE3(config-if)#enable-ldp ipv4	Enable LDP for IPv4 on interface eth3
PE3(config-if)#exit	Exit interface mode
PE3(config)#commit	Apply commit

PE3: BGP

PE3(config)#router bgp 100	Configure router bgp mode
PE3(config)#bgp router-id 4.4.4.4	Configure BGP router-id
PE3(config-router)#neighbor 2.2.2.2 remote-as 100	Configure BGP IPv4 neighbor on RR
PE3(config-router)#neighbor 2.2.2.2 update-source 4.4.4.4	Configure the routing update source for RR as PE3's Loopback
PE3(config-router)#address-family vpnv6 unicast	Enter BGP address-family vpnv6 unicast mode
PE3(config-router-af)#neighbor 2.2.2.2 activate	Activate the neighbor RR for address-family vpnv6 unicast
PE3(config-router-af)#exit-address-family	Exit address-family ipv6 labeled-unicast mode
PE3(config-router)#address-family ipv6 vrf vrf1	Enter BGP address-family ipv6 vrf vrf1 mode
PE3(config-router)#neighbor 3001::2 remote-as 300	Configure BGP IPv6 neighbor on CE2
PE3(config-router-af)#exit-address-family	Exit address-family ipv6 vrf vrf1 mode
PE3(config-router)#exit	Exit router bgp mode
PE3(config)#commit	Apply commit

BGP IPv4 Additional Paths Configuration

PE3(config)#exit	Exit configure mode
PE3#clear bgp ipv6 unicast * vrf vrf1	Reset IPv6 BGP connection for all VRF addresses.

PE4: Interface

PE4#configure terminal	Enter configure mode.
PE4(config)#hostname PE4	Configure the hostname to PE4
PE4(config)#ip vrf vrf1	Configure VRF name
PE4(config-vrf)#rd 1:100	Configure Route Distinguisher value
PE4(config-vrf)#route-target both 1:200	Configure Route Target Value
PE4(config-vrf)#exit	Exit vrf mode
PE4(config)#interface eth1	Enter the Interface mode for interface eth1
PE4(config-if)#ip vrf forwarding vrf1	Configure ip vrf-forwarding on interface eth1
PE4(config-if)#ipv6 address 4001::1/64	Configure the IPv6 address for interface eth1
PE4(config-if)#exit	Exit interface mode
PE4(config)#interface lo	Enter the Interface mode for the loopback interface.
PE4(config-if)#ip address 5.5.5.5/32	Configure IPv4 address for loopback interface.
PE4(config-if)#exit	Exit interface mode
PE4(config)#interface eth4	Enter the Interface mode for interface eth4
PE4(config-if)#ip address 40.1.1.1/24	Configure the IP address for interface eth4
PE4(config-if)#exit	Exit interface mode
PE4(config)#commit	Apply commit

PE4: OSPF

PE4(config)#router ospf 1	Configure an OSPF instance 1
PE4(config-router)#network 40.1.1.0/24 area 0	Advertise the network towards RR in Area 0
PE4(config-router)#network 5.5.5.5/32 area 0	Advertise the Loopback network in Area 0
PE4(config-router)#exit	Exit OSPF router mode
PE4(config)#commit	Apply commit

PE4: MPLS

PE4(config)#router ldp	Enable LDP Process
PE4(config-router)#transport-address ipv4 5.5.5.5	Configure Transport address for LDP
PE4(config-router)#exit	Exit router ldp mode
PE4(config)#interface eth4	Enter the interface mode for interface eth4
PE4(config-if)#label-switching	Enable label-switching on interface eth4
PE4(config-if)#enable-ldp ipv4	Enable LDP for IPv4 on interface eth4
PE4(config-if)#exit	Exit interface mode
PE4(config)#commit	Apply commit

PE4: BGP

PE4(config)#router bgp 100	Configure router bgp mode
PE4(config)#bgp router-id 5.5.5.5	Configure BGP router-id
PE4(config-router)#neighbor 2.2.2.2 remote-as 100	Configure BGP IPv4 neighbor on RR
PE4(config-router)#neighbor 2.2.2.2 update-source 5.5.5.5	Configure the routing update source for RR as PE4's Loopback
PE4(config-router)#address-family vpnv6 unicast	Enter BGP address-family vpnv6 unicast mode
PE4(config-router-af)#neighbor 2.2.2.2 activate	Activate the neighbor RR for address-family vpnv6 unicast
PE4(config-router-af)#exit-address-family	Exit address-family ipv6 labeled-unicast mode
PE4(config-router)#address-family ipv6 vrf vrf1	Enter BGP address-family ipv6 vrf vrf1 mode
PE4(config-router)#neighbor 4001::2 remote-as 300	Configure BGP IPv6 neighbor on CE2
PE4(config-router-af)#exit-address-family	Exit address-family ipv6 vrf vrf1 mode
PE4(config-router)#exit	Exit router bgp mode
PE4(config)#commit	Apply commit
PE4(config)#exit	Exit configure mode
PE4#clear bgp ipv6 unicast * vrf vrf1	Reset IPv6 BGP connection for all VRF addresses.

CE2: Interface

CE2#configure terminal	Enter configure mode.
CE2(config)#hostname CE2	Configure the hostname to CE2
CE2(config)#interface eth1	Enter the Interface mode for interface eth1
CE2(config-if)#ipv6 address 2001::2/64	Configure IPV6 address for interface eth1
CE2(config-if)#exit	Exit Interface mode.
CE2(config)#interface eth2	Enter the Interface mode for interface eth2
CE2(config-if)#ipv6 address 3001::2/64	Configure IPV6 address for interface eth2
CE2(config-if)#exit	Exit Interface mode.
CE2(config)#interface eth3	Enter the Interface mode for interface eth3
CE2(config-if)#ipv6 address 4001::2/64	Configure IPV6 address for interface eth3
CE2(config-if)#exit	Exit Interface mode.
CE2(config)#interface lo	Enter the Interface mode for interface Loopback
CE2(config-if)#ipv6 address 2222::2/128	Configure IPV6 address for interface Loopback
CE2(config-if)#exit	Exit Interface mode.
CE2(config)#commit	Apply commit

CE2: BGP

CE2(config)#router bgp 300	Enter BGP router mode
CE2(config-router)#neighbor 2001::1 remote-as 100	Configure BGP ipv6 neighbor on PE2
CE2(config-router)#neighbor 3001::1 remote-as 100	Configure BGP ipv6 neighbor on PE3
CE2(config-router)#neighbor 4001::1 remote-as 100	Configure BGP ipv6 neighbor on PE4
CE2(config-router)#address-family ipv6 unicast	Enter the address family ipv6
CE2(config-router-af)#neighbor 2001::1 activate	Activate neighbor under address family ipv6
CE2(config-router-af)#neighbor 3001::1 activate	Activate neighbor under address family ipv6
CE2(config-router-af)#neighbor 4001::1 activate	Activate neighbor under address family ipv6
CE2(config-router-af)#network 2222::2/128	Advertise the IPv6 prefix of Loopback into BGP
CE2(config-router-af)#exit-address-family	Exit address family ipv6 unicast mode
CE2(config-router)#exit	Exit BGP router mode
CE2(config)#commit	Apply commit
CE2(config)#exit	Exit configure mode

BGP Addpath Capability for VPNV6 Unicast Address-family**RR**

RR(config)#router bgp 100	Configure router bgp mode
RR(config-router)#address-family vpnv6 unicast	Enter BGP address-family vpnv6 unicast mode
RR(config-router-af)#bgp additional-paths select all	Configure RR to select all addpaths
RR(config-router-af)#bgp additional-paths send	Configure BGP addpath send capability under address-family vpnv6 unicast
(config-router-af)#exit-address-family	Exit bgp address-family mode.
(config-router)#exit	Exit Router BGP mode.
(config)#commit	Apply commit
(config)#exit	Exit Configure mode.

PE1

PE1(config)#router bgp 100	Configure router bgp mode
PE1(config-router)#address-family vpnv6 unicast	Enter BGP address-family vpnv6 unicast mode
PE1(config-router-af)#neighbor 2.2.2.2 additional-paths receive	Configure BGP addpath receive capability for the 6VPE-neighbor RR under address-family vpnv6 unicast
(config-router-af)#exit-address-family	Exit bgp address-family mode.

(config-router)#exit	Exit Router BGP mode.
(config)#commit	Apply commit
(config)#exit	Exit Configure mode.

PE2

PE2(config)#router bgp 100	Configure router bgp mode
PE2(config-router)#address-family vpnv6 unicast	Enter BGP address-family vpnv6 unicast mode
PE2(config-router-af)#bgp additional-paths receive	Configure BGP addpath receive capability under address-family vpnv6 unicast
(config-router-af)#exit-address-family	Exit bgp address-family mode.
(config-router)#exit	Exit Router BGP mode.
(config)#commit	Apply commit
(config)#exit	Exit Configure mode.

PE3

PE3(config)#router bgp 100	Configure router bgp mode
PE3(config-router)#address-family vpnv6 unicast	Enter BGP address-family vpnv6 unicast mode
PE3(config-router-af)#bgp additional-paths receive	Configure BGP addpath receive capability under address-family vpnv6 unicast
PE3(config-router-af)#exit-address-family	Exit bgp address-family mode.
PE3(config-router)#exit	Exit Router BGP mode.
PE3(config)#commit	Apply commit
PE3(config)#exit	Exit Configure mode.

PE4

PE4(config)#router bgp 100	Configure router bgp mode
PE4(config-router)#address-family vpnv6 unicast	Enter BGP address-family vpnv6 unicast mode
PE4(config-router-af)#bgp additional-paths receive	Configure BGP addpath receive capability under address-family vpnv6 unicast
PE4(config-router-af)#exit-address-family	Exit bgp address-family mode.
PE4(config-router)#exit	Exit Router BGP mode.
PE4(config)#commit	Apply commit
PE4(config)#exit	Exit Configure mode.

Validation at RR**Add-Path Send Capability Advertised to and Received From 6VPE Peers**

```
RR#show bgp neighbors 1.1.1.1
BGP neighbor is 1.1.1.1, remote AS 100, local AS 100, internal link
```

BGP IPv4 Additional Paths Configuration

```
BGP version 4, remote router ID 1.1.1.1
BGP state = Established, up for 00:03:03
Last read 00:03:03, hold time is 90, keepalive interval is 30 seconds
Neighbor capabilities:
  Route refresh: advertised and received (old and new)
  Address family IPv4 Unicast: advertised and received
  Address family VPNv6 Unicast: advertised and received
Received 35 messages, 0 notifications, 0 in queue
Sent 41 messages, 1 notifications, 0 in queue
Route refresh request: received 0, sent 0
Minimum time between advertisement runs is 5 seconds
Update source is 2.2.2.2
For address family: IPv4 Unicast
  BGP table version 1, neighbor version 1
  Index 1, Offset 0, Mask 0x2
  AIGP is enabled
  Community attribute sent to this neighbor (both)
  0 accepted prefixes
  0 announced prefixes

For address family: VPNv6 Unicast
  BGP table version 6, neighbor version 6
  Index 1, Offset 0, Mask 0x2
  AF-dependant capabilities:
    Add-Path Send Capability : advertised
    Add-Path Receive Capability : received
  Route-Reflector Client
  Community attribute sent to this neighbor (both)
  0 accepted prefixes
  3 announced prefixes

Connections established 2; dropped 1
Local host: 2.2.2.2, Local port: 57154
Foreign host: 1.1.1.1, Foreign port: 179
Nexthop: 2.2.2.2
Nexthop global: ::
Nexthop local: ::
BGP connection: non shared network
Last Reset: 00:03:08, due to BGP Notification sent
Notification Error Message: (Cease/Other Configuration Change.)
RR#
```

```
RR#show bgp neighbors 3.3.3.3
BGP neighbor is 3.3.3.3, remote AS 100, local AS 100, internal link
  BGP version 4, remote router ID 3.3.3.3
  BGP state = Established, up for 00:05:20
  Last read 00:05:20, hold time is 90, keepalive interval is 30 seconds
  Neighbor capabilities:
    Route refresh: advertised and received (old and new)
```

```
Address family IPv4 Unicast: advertised and received
Address family VPNv6 Unicast: advertised and received
Received 41 messages, 0 notifications, 0 in queue
Sent 44 messages, 1 notifications, 0 in queue
Route refresh request: received 0, sent 0
Minimum time between advertisement runs is 5 seconds
Update source is 2.2.2.2
For address family: IPv4 Unicast
BGP table version 1, neighbor version 1
Index 2, Offset 0, Mask 0x4
AIGP is enabled
Community attribute sent to this neighbor (both)
0 accepted prefixes
0 announced prefixes

For address family: VPNv6 Unicast
BGP table version 6, neighbor version 6
Index 2, Offset 0, Mask 0x4
AF-dependant capabilities:
  Add-Path Send Capability : advertised
  Add-Path Receive Capability : received
Route-Reflector Client
Community attribute sent to this neighbor (both)
1 accepted prefixes
2 announced prefixes

Connections established 2; dropped 1
Local host: 2.2.2.2, Local port: 179
Foreign host: 3.3.3.3, Foreign port: 32841
Nexthop: 2.2.2.2
Nexthop global: ::
Nexthop local: ::
BGP connection: non shared network
Last Reset: 00:05:25, due to BGP Notification sent
Notification Error Message: (Cease/Other Configuration Change.)
RR#

RR#show bgp neighbors 4.4.4.4
BGP neighbor is 4.4.4.4, remote AS 100, local AS 100, internal link
BGP version 4, remote router ID 4.4.4.4
BGP state = Established, up for 00:05:47
Last read 00:05:47, hold time is 90, keepalive interval is 30 seconds
Neighbor capabilities:
  Route refresh: advertised and received (old and new)
  Address family IPv4 Unicast: advertised and received
  Address family VPNv6 Unicast: advertised and received
Received 42 messages, 0 notifications, 0 in queue
Sent 46 messages, 1 notifications, 0 in queue
Route refresh request: received 0, sent 0
```

BGP IPv4 Additional Paths Configuration

```
Minimum time between advertisement runs is 5 seconds
Update source is 2.2.2.2
For address family: IPv4 Unicast
  BGP table version 1, neighbor version 1
  Index 3, Offset 0, Mask 0x8
  AIGP is enabled
  Community attribute sent to this neighbor (both)
  0 accepted prefixes
  0 announced prefixes

For address family: VPNv6 Unicast
  BGP table version 6, neighbor version 6
  Index 3, Offset 0, Mask 0x8
  AF-dependant capabilities:
    Add-Path Send Capability : advertised
    Add-Path Receive Capability : received
  Route-Reflector Client
  Community attribute sent to this neighbor (both)
  1 accepted prefixes
  2 announced prefixes

Connections established 2; dropped 1
Local host: 2.2.2.2, Local port: 179
Foreign host: 4.4.4.4, Foreign port: 42015
Nexthop: 2.2.2.2
Nexthop global: ::
Nexthop local: ::
BGP connection: non shared network
Last Reset: 00:05:47, due to BGP Notification received
Notification Error Message: (Cease/Administratively Reset.)
RR#

RR#show bgp neighbors 5.5.5.5
BGP neighbor is 5.5.5.5, remote AS 100, local AS 100, internal link
  BGP version 4, remote router ID 5.5.5.5
  BGP state = Established, up for 00:07:58
  Last read 00:07:58, hold time is 90, keepalive interval is 30 seconds
  Neighbor capabilities:
    Route refresh: advertised and received (old and new)
    Address family IPv4 Unicast: advertised and received
    Address family VPNv6 Unicast: advertised and received
  Received 47 messages, 0 notifications, 0 in queue
  Sent 49 messages, 1 notifications, 0 in queue
  Route refresh request: received 0, sent 0
  Minimum time between advertisement runs is 5 seconds
  Update source is 2.2.2.2
  For address family: IPv4 Unicast
    BGP table version 1, neighbor version 1
    Index 4, Offset 0, Mask 0x10
```

```
AIGP is enabled
Community attribute sent to this neighbor (both)
0 accepted prefixes
0 announced prefixes
```

```
For address family: VPNv6 Unicast
BGP table version 6, neighbor version 6
Index 4, Offset 0, Mask 0x10
AF-dependant capabilities:
  Add-Path Send Capability : advertised
  Add-Path Receive Capability : received
Route-Reflector Client
Community attribute sent to this neighbor (both)
1 accepted prefixes
2 announced prefixes
```

```
Connections established 2; dropped 1
Local host: 2.2.2.2, Local port: 52433
Foreign host: 5.5.5.5, Foreign port: 179
Nexthop: 2.2.2.2
Nexthop global: ::
Nexthop local: ::
BGP connection: non shared network
Last Reset: 00:08:03, due to BGP Notification sent
Notification Error Message: (Cease/Other Configuration Change.)
```

VPNv6 Prefix Advertised to All 6VPE Peers With All Addpaths

```
RR#show ip bgp vpnv6 all
Status codes: s suppressed, d damped, h history, a add-path, * valid, > best, i -
internal, l - labeled
              S Stale
Origin codes: i - IGP, e - EGP, ? - incomplete
```

Network	Next Hop	Metric	LocPrf	Weight	Path
Route Distinguisher: 1:100					
*>i1 2222::2/128	::ffff:3.3.3.3		0	100	0
300 i					
*ail	::ffff:4.4.4.4		0	100	0
300 i					
*ail	::ffff:5.5.5.5		0	100	0
300 i					

```
Announced routes count = 0
Accepted routes count = 3
```

```
RR#
```

```
RR#show ip bgp vpnv6 all 2222::2
Route Distinguisher: 1:100
 300, (Received from a RR-client)
  ::ffff:3.3.3.3 (metric 11) from 3.3.3.3 (3.3.3.3)
    Origin IGP, metric 0, localpref 100, label 24960, valid, internal, best
    Extended Community: RT:1:200
```

BGP IPv4 Additional Paths Configuration

```
rx path_id: -1      tx path_id: 0
Advertised to non peer-group peers:
 1.1.1.1      4.4.4.4      5.5.5.5
Last update: Fri Mar 15 04:09:48 2019
```

300, (Received from a RR-client)

```
::ffff:4.4.4.4 (metric 11) from 4.4.4.4 (4.4.4.4)
Origin IGP, metric 0, localpref 100, label 24960, valid, internal, add-path
Extended Community: RT:1:200
rx path_id: -1      tx path_id: 1
Advertised to non peer-group peers:
 1.1.1.1      3.3.3.3      5.5.5.5
Last update: Fri Mar 15 04:09:48 2019
```

300, (Received from a RR-client)

```
::ffff:5.5.5.5 (metric 11) from 5.5.5.5 (5.5.5.5)
Origin IGP, metric 0, localpref 100, label 24960, valid, internal, add-path
Extended Community: RT:1:200
rx path_id: -1      tx path_id: 2
Advertised to non peer-group peers:
 1.1.1.1      3.3.3.3      4.4.4.4
Last update: Fri Mar 15 04:09:48 2019
```

Validation at PE1

```
PE1#show ip bgp vpnv6 all
Status codes: s suppressed, d damped, h history, a add-path, * valid, > best, i -
internal, l - labeled
           S Stale
Origin codes: i - IGP, e - EGP, ? - incomplete
```

Network	Next Hop	Metric	LocPrf	Weight	Path
Route Distinguisher: 1:100 (Default for VRF vrf1)					
*>i1 2222::2/128	::ffff:3.3.3.3		0	100	0
300 i					
Announced routes count = 0					
Accepted routes count = 1					
Route Distinguisher: 1:100					
*>i1 2222::2/128	::ffff:3.3.3.3		0	100	0
300 i					
* i1	::ffff:4.4.4.4		0	100	0
300 i					
* i1	::ffff:5.5.5.5		0	100	0
300 i					
Announced routes count = 0					
Accepted routes count = 3					

```
PE1#
PE1#show ip bgp vpnv6 all 2222::2
Route Distinguisher: 1:100 (Default for VRF vrf1)
 300
   ::ffff:3.3.3.3 (metric 12) from 2.2.2.2 (2.2.2.2)
     Origin IGP, metric 0, localpref 100, label 24960, valid, internal, best
```

```

Extended Community: RT:1:200
Originator: 3.3.3.3, Cluster list: 2.2.2.2
rx path_id: 0      tx path_id: -1
Not advertised to any peer
Last update: Fri Mar 15 04:10:00 2019

```

```

Route Distinguisher: 1:100
300

```

```

::ffff:3.3.3.3 (metric 12) from 2.2.2.2 (2.2.2.2)
Origin IGP, metric 0, localpref 100, label 24960, valid, internal, best
Extended Community: RT:1:200
Originator: 3.3.3.3, Cluster list: 2.2.2.2
rx path_id: 0      tx path_id: -1
Not advertised to any peer
Last update: Fri Mar 15 04:10:00 2019

```

```

300

```

```

::ffff:4.4.4.4 (metric 12) from 2.2.2.2 (2.2.2.2)
Origin IGP, metric 0, localpref 100, label 24960, valid, internal
Extended Community: RT:1:200
Originator: 4.4.4.4, Cluster list: 2.2.2.2
rx path_id: 1      tx path_id: -1
Not advertised to any peer
Last update: Fri Mar 15 04:10:00 2019

```

```

300

```

```

::ffff:5.5.5.5 (metric 12) from 2.2.2.2 (2.2.2.2)
Origin IGP, metric 0, localpref 100, label 24960, valid, internal
Extended Community: RT:1:200
Originator: 5.5.5.5, Cluster list: 2.2.2.2
rx path_id: 2      tx path_id: -1
Not advertised to any peer
Last update: Fri Mar 15 04:10:00 2019

```

Validation at PE2

```

PE2#show ip bgp vpv6 all

```

```

Status codes: s suppressed, d damped, h history, a add-path, * valid, > best, i -
internal, l - labeled

```

```

S Stale

```

```

Origin codes: i - IGP, e - EGP, ? - incomplete

```

Network	Next Hop	Metric	LocPrf	Weight	Path
Route Distinguisher: 1:100 (Default for VRF vrf1)					
*> 2222::2/128	2001::2(fe80::5054:ff:fe18:619a)	0	100	0	300 i
* i l	::ffff:4.4.4.4		0	100	0

```

300 i
Announced routes count = 1
Accepted routes count = 1
Route Distinguisher: 1:100

```

BGP IPv4 Additional Paths Configuration

```
*>i1 2222::2/128      ::ffff:4.4.4.4      0      100      0
300 i
* i1      ::ffff:5.5.5.5      0      100      0
300 i
```

Announced routes count = 0

Accepted routes count = 2

PE2#

PE2#show ip bgp vpnv6 all 2222::2

Route Distinguisher: 1:100 (Default for VRF vrf1)

300

2001::2(fe80::5054:ff:fe18:619a) from 2001::2 (10.12.65.71)
(fe80::5054:ff:fe18:619a)

Origin IGP, metric 0, localpref 100, valid, external, best

Extended Community: RT:1:200

Not advertised to any peer

Last update: Fri Mar 15 03:57:09 2019

300

::ffff:4.4.4.4 (metric 12) from 2.2.2.2 (2.2.2.2)

Origin IGP, metric 0, localpref 100, label 24960, valid, internal

Extended Community: RT:1:200

Originator: 4.4.4.4, Cluster list: 2.2.2.2

rx path_id: 1 tx path_id: -1

Not advertised to any peer

Last update: Fri Mar 15 04:10:00 2019

Route Distinguisher: 1:100

300

::ffff:4.4.4.4 (metric 12) from 2.2.2.2 (2.2.2.2)

Origin IGP, metric 0, localpref 100, label 24960, valid, internal, best

Extended Community: RT:1:200

Originator: 4.4.4.4, Cluster list: 2.2.2.2

rx path_id: 1 tx path_id: -1

Not advertised to any peer

Last update: Fri Mar 15 04:10:00 2019

300

::ffff:5.5.5.5 (metric 12) from 2.2.2.2 (2.2.2.2)

Origin IGP, metric 0, localpref 100, label 24960, valid, internal

Extended Community: RT:1:200

Originator: 5.5.5.5, Cluster list: 2.2.2.2

rx path_id: 2 tx path_id: -1

Not advertised to any peer

Last update: Fri Mar 15 04:10:00 2019

Validation at PE3

PE3#show ip bgp vpnv6 all

Status codes: s suppressed, d damped, h history, a add-path, * valid, > best, i -
internal, l - labeled

S Stale

Origin codes: i - IGP, e - EGP, ? - incomplete

Network	Next Hop	Metric	LocPrf	Weight	Path
Route Distinguisher: 1:100 (Default for VRF vrf1)					
*> 2222::2/128	3001::2(fe80::5054:ff:feee:e4fc)	0	100	0	300 i
* il	::ffff:3.3.3.3		0	100	0
300 i					
Announced routes count = 1					
Accepted routes count = 1					
Route Distinguisher: 1:100					
*>il 2222::2/128	::ffff:3.3.3.3		0	100	0
300 i					
* il	::ffff:5.5.5.5		0	100	0
300 i					
Announced routes count = 0					
Accepted routes count = 2					
PE3#					
PE3#show ip bgp vpnv6 all 2222::2					
Route Distinguisher: 1:100 (Default for VRF vrf1)					
300					
3001::2(fe80::5054:ff:feee:e4fc) from 3001::2 (10.12.65.71)					
(fe80::5054:ff:feee:e4fc)					
Origin IGP, metric 0, localpref 100, valid, external, best					
Extended Community: RT:1:200					
Not advertised to any peer					
Last update: Fri Mar 15 03:56:59 2019					
300					
::ffff:3.3.3.3 (metric 12) from 2.2.2.2 (2.2.2.2)					
Origin IGP, metric 0, localpref 100, label 24960, valid, internal					
Extended Community: RT:1:200					
Originator: 3.3.3.3, Cluster list: 2.2.2.2					
rx path_id: 0 tx path_id: -1					
Not advertised to any peer					
Last update: Fri Mar 15 04:09:56 2019					
Route Distinguisher: 1:100					
300					
::ffff:3.3.3.3 (metric 12) from 2.2.2.2 (2.2.2.2)					
Origin IGP, metric 0, localpref 100, label 24960, valid, internal, best					
Extended Community: RT:1:200					
Originator: 3.3.3.3, Cluster list: 2.2.2.2					
rx path_id: 0 tx path_id: -1					
Not advertised to any peer					
Last update: Fri Mar 15 04:09:56 2019					
300					
::ffff:5.5.5.5 (metric 12) from 2.2.2.2 (2.2.2.2)					
Origin IGP, metric 0, localpref 100, label 24960, valid, internal					
Extended Community: RT:1:200					

BGP IPv4 Additional Paths Configuration

```
Originator: 5.5.5.5, Cluster list: 2.2.2.2
rx path_id: 2      tx path_id: -1
Not advertised to any peer
Last update: Fri Mar 15 04:10:00 2019
```

Validation at PE4

```
PE4#show ip bgp vpnv6 all
Status codes: s suppressed, d damped, h history, a add-path, * valid, > best, i -
internal, l - labeled
              S Stale
Origin codes: i - IGP, e - EGP, ? - incomplete

      Network          Next Hop          Metric   LocPrf   Weight Path
Route Distinguisher: 1:100 (Default for VRF vrf1)
*>  2222::2/128        4001::2(fe80::5054:ff:fe2e:4cb9)
                                     0         100       0        300 i
* il                   ::ffff:3.3.3.3    0         0         100       0
300 i
  Announced routes count = 1
  Accepted routes count = 1
Route Distinguisher: 1:100
*>il 2222::2/128      ::ffff:3.3.3.3    0         0         100       0
300 i
  Announced routes count = 0
  Accepted routes count = 1
PE4#
PE4#show ip bgp vpnv6 all 2222::2
Route Distinguisher: 1:100 (Default for VRF vrf1)
300
  4001::2(fe80::5054:ff:fe2e:4cb9) from 4001::2 (10.12.65.71)
  (fe80::5054:ff:fe2e:4cb9)
  Origin IGP, metric 0, localpref 100, valid, external, best
  Extended Community: RT:1:200
  Not advertised to any peer
  Last update: Fri Mar 15 03:56:38 2019

300
  ::ffff:3.3.3.3 (metric 12) from 2.2.2.2 (2.2.2.2)
  Origin IGP, metric 0, localpref 100, label 24960, valid, internal
  Extended Community: RT:1:200
  Originator: 3.3.3.3, Cluster list: 2.2.2.2
  rx path_id: 0      tx path_id: -1
  Not advertised to any peer
  Last update: Fri Mar 15 04:09:57 2019

Route Distinguisher: 1:100
300
  ::ffff:3.3.3.3 (metric 12) from 2.2.2.2 (2.2.2.2)
  Origin IGP, metric 0, localpref 100, label 24960, valid, internal, best
  Extended Community: RT:1:200
```

```

Originator: 3.3.3.3, Cluster list: 2.2.2.2
rx path_id: 0      tx path_id: -1
Not advertised to any peer
Last update: Fri Mar 15 04:09:57 2019

```

300

```

::ffff:4.4.4.4 (metric 12) from 2.2.2.2 (2.2.2.2)
Origin IGP, metric 0, localpref 100, label 24960, valid, internal
Extended Community: RT:1:200
Originator: 4.4.4.4, Cluster list: 2.2.2.2
rx path_id: 1      tx path_id: -1
Not advertised to any peer
Last update: Fri Mar 15 04:09:57 2019

```

Validation at CE1

```

CE1#show bgp ipv6
BGP table version is 2, local router ID is 10.12.65.70
Status codes: s suppressed, d damped, h history, a add-path, g group-best, * valid, >
best, i - internal, l - labeled
          S Stale
Origin codes: i - IGP, e - EGP, ? - incomplete

```

Network	Next Hop	Metric	LocPrf	Weight	Path
*> 2222::2/128	1001::2 (fe80::5054:ff:feaa:791f)	0	100	0	100 300 i

Total number of prefixes 1

BGP Addpath Selection Configuration Best 2 Under Address-family VPNV6 Unicast

RR

RR(config)#router bgp 100	Configure router bgp mode
RR(config-router)#address-family vpnv6 unicast	Enter BGP address-family vpnv6 unicast mode
RR(config-router-af)#no bgp additional-paths select all	Unconfigure RR to select All addpaths
RR(config-router-af)#bgp additional-paths select best 2	Configure RR to select best 2 addpaths
(config-router-af)#exit-address-family	Exit bgp address-family mode.
(config-router)#exit	Exit Router BGP mode.
(config)#commit	Apply commit
(config)#exit	Exit Configure mode.

Validation at RR

```

RR#show ip bgp vpnv6 all
Status codes: s suppressed, d damped, h history, a add-path, * valid, > best, i -
internal, l - labeled

```

BGP IPv4 Additional Paths Configuration

S Stale

Origin codes: i - IGP, e - EGP, ? - incomplete

Network	Next Hop	Metric	LocPrf	Weight	Path
Route Distinguisher: 1:100					
*>i1 2222::2/128	::ffff:3.3.3.3		0	100	0
300 i					
*ail	::ffff:4.4.4.4		0	100	0
300 i					
* il	::ffff:5.5.5.5		0	100	0
300 i					

Announced routes count = 0

Accepted routes count = 3

RR#

RR#

RR#show ip bgp vpnv6 all 2222::2

Route Distinguisher: 1:100

300, (Received from a RR-client)

::ffff:3.3.3.3 (metric 11) from 3.3.3.3 (3.3.3.3)

Origin IGP, metric 0, localpref 100, label 24960, valid, internal, best

Extended Community: RT:1:200

rx path_id: -1 tx path_id: 0

Advertised to non peer-group peers:

1.1.1.1 4.4.4.4 5.5.5.5

Last update: Fri Mar 15 04:09:48 2019

300, (Received from a RR-client)

::ffff:4.4.4.4 (metric 11) from 4.4.4.4 (4.4.4.4)

Origin IGP, metric 0, localpref 100, label 24960, valid, internal, add-path

Extended Community: RT:1:200

rx path_id: -1 tx path_id: 1

Advertised to non peer-group peers:

1.1.1.1 3.3.3.3 5.5.5.5

Last update: Fri Mar 15 04:09:48 2019

300, (Received from a RR-client)

::ffff:5.5.5.5 (metric 11) from 5.5.5.5 (5.5.5.5)

Origin IGP, metric 0, localpref 100, label 24960, valid, internal

Extended Community: RT:1:200

Not advertised to any peer

Last update: Fri Mar 15 04:09:48 2019

Validation at PE1

PE1#show ip bgp vpnv6 all

Status codes: s suppressed, d damped, h history, a add-path, * valid, > best, i - internal, l - labeled

S Stale

Origin codes: i - IGP, e - EGP, ? - incomplete

Network	Next Hop	Metric	LocPrf	Weight	Path
---------	----------	--------	--------	--------	------

```

Route Distinguisher: 1:100 (Default for VRF vrf1)
*>il 2222::2/128          ::ffff:3.3.3.3          0          100          0
300 i
  Announced routes count = 0
  Accepted routes count = 1
Route Distinguisher: 1:100
*>il 2222::2/128          ::ffff:3.3.3.3          0          100          0
300 i
* il                      ::ffff:4.4.4.4          0          100          0
300 i
  Announced routes count = 0
  Accepted routes count = 2
PE1#
PE1#show ip bgp vpnv6 all 2222::2
Route Distinguisher: 1:100 (Default for VRF vrf1)
 300
  ::ffff:3.3.3.3 (metric 12) from 2.2.2.2 (2.2.2.2)
  Origin IGP, metric 0, localpref 100, label 24960, valid, internal, best
  Extended Community: RT:1:200
  Originator: 3.3.3.3, Cluster list: 2.2.2.2
  rx path_id: 0      tx path_id: -1
  Not advertised to any peer
  Last update: Fri Mar 15 04:10:00 2019

Route Distinguisher: 1:100
 300
  ::ffff:3.3.3.3 (metric 12) from 2.2.2.2 (2.2.2.2)
  Origin IGP, metric 0, localpref 100, label 24960, valid, internal, best
  Extended Community: RT:1:200
  Originator: 3.3.3.3, Cluster list: 2.2.2.2
  rx path_id: 0      tx path_id: -1
  Not advertised to any peer
  Last update: Fri Mar 15 05:36:25 2019

 300
  ::ffff:4.4.4.4 (metric 12) from 2.2.2.2 (2.2.2.2)
  Origin IGP, metric 0, localpref 100, label 24960, valid, internal
  Extended Community: RT:1:200
  Originator: 4.4.4.4, Cluster list: 2.2.2.2
  rx path_id: 1      tx path_id: -1
  Not advertised to any peer
  Last update: Fri Mar 15 05:37:00 2019

```

Validation at PE2

```

PE2#show ip bgp vpnv6 all
Status codes: s suppressed, d damped, h history, a add-path, * valid, > best, i -
internal, l - labeled
              S Stale
Origin codes: i - IGP, e - EGP, ? - incomplete

```

BGP IPv4 Additional Paths Configuration

```

Network          Next Hop          Metric  LocPrf  Weight Path
Route Distinguisher: 1:100 (Default for VRF vrf1)
*> 2222::2/128    2001::2(fe80::5054:ff:fe18:619a)
                                0          100        0        300 i
* il              ::ffff:4.4.4.4    0          100        0
300 i
  Announced routes count = 1
  Accepted routes count = 1
Route Distinguisher: 1:100
*>il 2222::2/128    ::ffff:4.4.4.4    0          100        0
300 i
  Announced routes count = 0
  Accepted routes count = 1
PE2#
PE2#show ip bgp vpnv6 all 2222::2
Route Distinguisher: 1:100 (Default for VRF vrf1)
 300
  2001::2(fe80::5054:ff:fe18:619a) from 2001::2 (10.12.65.71)
  (fe80::5054:ff:fe18:619a)
  Origin IGP, metric 0, localpref 100, valid, external, best
  Extended Community: RT:1:200
  Not advertised to any peer
  Last update: Fri Mar 15 03:57:09 2019

 300
  ::ffff:4.4.4.4 (metric 12) from 2.2.2.2 (2.2.2.2)
  Origin IGP, metric 0, localpref 100, label 24960, valid, internal
  Extended Community: RT:1:200
  Originator: 4.4.4.4, Cluster list: 2.2.2.2
  rx path_id: 1      tx path_id: -1
  Not advertised to any peer
  Last update: Fri Mar 15 05:37:00 2019

Route Distinguisher: 1:100
 300
  ::ffff:4.4.4.4 (metric 12) from 2.2.2.2 (2.2.2.2)
  Origin IGP, metric 0, localpref 100, label 24960, valid, internal, best
  Extended Community: RT:1:200
  Originator: 4.4.4.4, Cluster list: 2.2.2.2
  rx path_id: 1      tx path_id: -1
  Not advertised to any peer
  Last update: Fri Mar 15 05:37:00 2019
```

Validation at PE3

```

PE3#show ip bgp vpnv6 all
Status codes: s suppressed, d damped, h history, a add-path, * valid, > best, i -
internal, l - labeled
              S Stale
Origin codes: i - IGP, e - EGP, ? - incomplete
```

Network	Next Hop	Metric	LocPrf	Weight	Path
Route Distinguisher: 1:100 (Default for VRF vrf1)					
*> 2222::2/128	3001::2 (fe80::5054:ff:feee:e4fc)	0	100	0	300 i
* i1	::ffff:3.3.3.3		0	100	0
300 i					
Announced routes count = 1					
Accepted routes count = 1					
Route Distinguisher: 1:100					
*>i1 2222::2/128	::ffff:3.3.3.3		0	100	0
300 i					
Announced routes count = 0					
Accepted routes count = 1					

```

PE3#
PE3#show ip bgp vpnv6 all 2222::2
Route Distinguisher: 1:100 (Default for VRF vrf1)
  300
    3001::2 (fe80::5054:ff:feee:e4fc) from 3001::2 (10.12.65.71)
    (fe80::5054:ff:feee:e4fc)
      Origin IGP, metric 0, localpref 100, valid, external, best
      Extended Community: RT:1:200
      Not advertised to any peer
      Last update: Fri Mar 15 03:56:59 2019

  300
    ::ffff:3.3.3.3 (metric 12) from 2.2.2.2 (2.2.2.2)
      Origin IGP, metric 0, localpref 100, label 24960, valid, internal
      Extended Community: RT:1:200
      Originator: 3.3.3.3, Cluster list: 2.2.2.2
      rx path_id: 0      tx path_id: -1
      Not advertised to any peer
      Last update: Fri Mar 15 04:09:56 2019

Route Distinguisher: 1:100
  300
    ::ffff:3.3.3.3 (metric 12) from 2.2.2.2 (2.2.2.2)
      Origin IGP, metric 0, localpref 100, label 24960, valid, internal, best
      Extended Community: RT:1:200
      Originator: 3.3.3.3, Cluster list: 2.2.2.2
      rx path_id: 0      tx path_id: -1
      Not advertised to any peer
      Last update: Fri Mar 15 05:36:22 2019

```

Validation at PE4

```

PE4#show ip bgp vpnv6 all
Status codes: s suppressed, d damped, h history, a add-path, * valid, > best, i -
internal, l - labeled
              S Stale
Origin codes: i - IGP, e - EGP, ? - incomplete

```

BGP IPv4 Additional Paths Configuration

```

Network          Next Hop          Metric  LocPrf  Weight Path
Route Distinguisher: 1:100 (Default for VRF vrf1)
*> 2222::2/128    4001::2(fe80::5054:ff:fe2e:4cb9)
                                0          100          0          300 i
* il              ::ffff:3.3.3.3    0          100          0
300 i
  Announced routes count = 1
  Accepted routes count = 1
Route Distinguisher: 1:100
*>il 2222::2/128    ::ffff:3.3.3.3    0          100          0
300 i
* il              ::ffff:4.4.4.4    0          100          0
300 i
  Announced routes count = 0
  Accepted routes count = 2
PE4#
PE4#show ip bgp vpnv6 all 2222::2
Route Distinguisher: 1:100 (Default for VRF vrf1)
 300
  4001::2(fe80::5054:ff:fe2e:4cb9) from 4001::2 (10.12.65.71)
  (fe80::5054:ff:fe2e:4cb9)
  Origin IGP, metric 0, localpref 100, valid, external, best
  Extended Community: RT:1:200
  Not advertised to any peer
  Last update: Fri Mar 15 03:56:38 2019

 300
  ::ffff:3.3.3.3 (metric 12) from 2.2.2.2 (2.2.2.2)
  Origin IGP, metric 0, localpref 100, label 24960, valid, internal
  Extended Community: RT:1:200
  Originator: 3.3.3.3, Cluster list: 2.2.2.2
  rx path_id: 0      tx path_id: -1
  Not advertised to any peer
  Last update: Fri Mar 15 04:09:57 2019

Route Distinguisher: 1:100
 300
  ::ffff:3.3.3.3 (metric 12) from 2.2.2.2 (2.2.2.2)
  Origin IGP, metric 0, localpref 100, label 24960, valid, internal, best
  Extended Community: RT:1:200
  Originator: 3.3.3.3, Cluster list: 2.2.2.2
  rx path_id: 0      tx path_id: -1
  Not advertised to any peer
  Last update: Fri Mar 15 05:36:26 2019

 300
  ::ffff:4.4.4.4 (metric 12) from 2.2.2.2 (2.2.2.2)
  Origin IGP, metric 0, localpref 100, label 24960, valid, internal
  Extended Community: RT:1:200
  Originator: 4.4.4.4, Cluster list: 2.2.2.2
  rx path_id: 1      tx path_id: -1
```

Not advertised to any peer
Last update: Fri Mar 15 05:36:59 2019

BGP Addpath Selection Configuration Best 3 Under Address-family VPNV6 Unicast

RR

RR(config)#router bgp 100	Configure router bgp mode
RR(config-router)#address-family vpnv6 unicast	Enter BGP address-family vpnv6 unicast mode
RR(config-router-af)#no bgp additional-paths select best	Unconfigure RR to select Best 2 addpaths
RR(config-router-af)#bgp additional-paths select best 3	Configure RR to select best 3 addpaths
RR(config-router-af)#exit-address-family	Exit bgp address-family mode.
RR(config-router)#exit	Exit Router BGP mode.
RR(config)#commit	Apply commit
RR(config)#exit	Exit Configure mode.

Validation at RR

```
RR#show ip bgp vpnv6 all
Status codes: s suppressed, d damped, h history, a add-path, * valid, > best, i -
internal, l - labeled
              S Stale
Origin codes: i - IGP, e - EGP, ? - incomplete
```

Network	Next Hop	Metric	LocPrf	Weight	Path
Route Distinguisher: 1:100					
*>i1 2222::2/128	::ffff:3.3.3.3		0	100	0
300 i					
*ail	::ffff:4.4.4.4		0	100	0
300 i					
*ail	::ffff:5.5.5.5		0	100	0
300 i					

```
Announced routes count = 0
Accepted routes count = 3
```

RR#

```
RR#show ip bgp vpnv6 all 2222::2
Route Distinguisher: 1:100
 300, (Received from a RR-client)
  ::ffff:3.3.3.3 (metric 11) from 3.3.3.3 (3.3.3.3)
  Origin IGP, metric 0, localpref 100, label 24960, valid, internal, best
  Extended Community: RT:1:200
  rx path_id: -1      tx path_id: 0
  Advertised to non-peer-group peers:
    1.1.1.1      4.4.4.4      5.5.5.5
  Last update: Fri Mar 15 04:09:48 2019
```

```
300, (Received from a RR-client)
```

BGP IPv4 Additional Paths Configuration

```
::ffff:4.4.4.4 (metric 11) from 4.4.4.4 (4.4.4.4)
  Origin IGP, metric 0, localpref 100, label 24960, valid, internal, add-path
  Extended Community: RT:1:200
  rx path_id: -1      tx path_id: 1
  Advertised to non peer-group peers:
    1.1.1.1      3.3.3.3      5.5.5.5
  Last update: Fri Mar 15 04:09:48 2019
```

300, (Received from a RR-client)

```
::ffff:5.5.5.5 (metric 11) from 5.5.5.5 (5.5.5.5)
  Origin IGP, metric 0, localpref 100, label 24960, valid, internal, add-path
  Extended Community: RT:1:200
  rx path_id: -1      tx path_id: 2
  Advertised to non peer-group peers:
    1.1.1.1      3.3.3.3      4.4.4.4
  Last update: Fri Mar 15 04:09:48 2019
```

Validation at PE1

```
PE1#show ip bgp vpnv6 all
Status codes: s suppressed, d damped, h history, a add-path, * valid, > best, i -
internal, l - labeled
              S Stale
Origin codes: i - IGP, e - EGP, ? - incomplete
```

Network	Next Hop	Metric	LocPrf	Weight	Path
Route Distinguisher: 1:100 (Default for VRF vrf1)					
*>i 2222::2/128	::ffff:3.3.3.3		0	100	0
300 i					
Announced routes count = 0					
Accepted routes count = 1					
Route Distinguisher: 1:100					
*>i 2222::2/128	::ffff:3.3.3.3		0	100	0
300 i					
* i	::ffff:4.4.4.4		0	100	0
300 i					
* i	::ffff:5.5.5.5		0	100	0
300 i					
Announced routes count = 0					
Accepted routes count = 3					

PE1#

```
PE1#show ip bgp vpnv6 all 2222::2
Route Distinguisher: 1:100 (Default for VRF vrf1)
 300
  ::ffff:3.3.3.3 (metric 12) from 2.2.2.2 (2.2.2.2)
  Origin IGP, metric 0, localpref 100, label 24960, valid, internal, best
  Extended Community: RT:1:200
  Originator: 3.3.3.3, Cluster list: 2.2.2.2
  rx path_id: 0      tx path_id: -1
  Not advertised to any peer
  Last update: Fri Mar 15 04:10:00 2019
```

Route Distinguisher: 1:100

300

```
::ffff:3.3.3.3 (metric 12) from 2.2.2.2 (2.2.2.2)
  Origin IGP, metric 0, localpref 100, label 24960, valid, internal, best
  Extended Community: RT:1:200
  Originator: 3.3.3.3, Cluster list: 2.2.2.2
  rx path_id: 0      tx path_id: -1
  Not advertised to any peer
  Last update: Fri Mar 15 05:55:27 2019
```

300

```
::ffff:4.4.4.4 (metric 12) from 2.2.2.2 (2.2.2.2)
  Origin IGP, metric 0, localpref 100, label 24960, valid, internal
  Extended Community: RT:1:200
  Originator: 4.4.4.4, Cluster list: 2.2.2.2
  rx path_id: 1      tx path_id: -1
  Not advertised to any peer
  Last update: Fri Mar 15 05:55:58 2019
```

300

```
::ffff:5.5.5.5 (metric 12) from 2.2.2.2 (2.2.2.2)
  Origin IGP, metric 0, localpref 100, label 24960, valid, internal
  Extended Community: RT:1:200
  Originator: 5.5.5.5, Cluster list: 2.2.2.2
  rx path_id: 2      tx path_id: -1
  Not advertised to any peer
  Last update: Fri Mar 15 05:55:58 2019
```

Validation at PE2

PE2#show ip bgp vpnv6 all

Status codes: s suppressed, d damped, h history, a add-path, * valid, > best, i - internal, l - labeled

S Stale

Origin codes: i - IGP, e - EGP, ? - incomplete

Network	Next Hop	Metric	LocPrf	Weight	Path
Route Distinguisher: 1:100 (Default for VRF vrf1)					
*> 2222::2/128	2001::2(fe80::5054:ff:fe18:619a)	0	100	0	300 i
* il	::ffff:4.4.4.4		0	100	0
300 i					
Announced routes count = 1					
Accepted routes count = 1					
Route Distinguisher: 1:100					
*>il 2222::2/128	::ffff:4.4.4.4		0	100	0
300 i					
* il	::ffff:5.5.5.5		0	100	0
300 i					
Announced routes count = 0					
Accepted routes count = 2					

BGP IPv4 Additional Paths Configuration

```
PE2#
PE2#show ip bgp vpnv6 all 2222::2
Route Distinguisher: 1:100 (Default for VRF vrf1)
 300
 2001::2(fe80::5054:ff:fe18:619a) from 2001::2 (10.12.65.71)
(fe80::5054:ff:fe18:619a)
  Origin IGP, metric 0, localpref 100, valid, external, best
  Extended Community: RT:1:200
  Not advertised to any peer
  Last update: Fri Mar 15 03:57:09 2019

 300
 ::ffff:4.4.4.4 (metric 12) from 2.2.2.2 (2.2.2.2)
  Origin IGP, metric 0, localpref 100, label 24960, valid, internal
  Extended Community: RT:1:200
  Originator: 4.4.4.4, Cluster list: 2.2.2.2
  rx path_id: 1 tx path_id: -1
  Not advertised to any peer
  Last update: Fri Mar 15 05:55:59 2019

Route Distinguisher: 1:100
 300
 ::ffff:4.4.4.4 (metric 12) from 2.2.2.2 (2.2.2.2)
  Origin IGP, metric 0, localpref 100, label 24960, valid, internal, best
  Extended Community: RT:1:200
  Originator: 4.4.4.4, Cluster list: 2.2.2.2
  rx path_id: 1 tx path_id: -1
  Not advertised to any peer
  Last update: Fri Mar 15 05:55:59 2019

 300
 ::ffff:5.5.5.5 (metric 12) from 2.2.2.2 (2.2.2.2)
  Origin IGP, metric 0, localpref 100, label 24960, valid, internal
  Extended Community: RT:1:200
  Originator: 5.5.5.5, Cluster list: 2.2.2.2
  rx path_id: 2 tx path_id: -1
  Not advertised to any peer
  Last update: Fri Mar 15 05:55:59 2019
```

Validation at PE3

```
PE3#show ip bgp vpnv6 all
Status codes: s suppressed, d damped, h history, a add-path, * valid, > best, i -
internal, l - labeled
              S Stale
Origin codes: i - IGP, e - EGP, ? - incomplete
```

Network	Next Hop	Metric	LocPrf	Weight	Path
Route Distinguisher: 1:100 (Default for VRF vrf1)					
*> 2222::2/128	3001::2(fe80::5054:ff:feee:e4fc)	0	100	0	300 i

```
* il          ::ffff:3.3.3.3          0          100          0
300 i
  Announced routes count = 1
  Accepted routes count = 1
Route Distinguisher: 1:100
*>il 2222::2/128      ::ffff:3.3.3.3          0          100          0
300 i
* il          ::ffff:5.5.5.5          0          100          0
300 i
  Announced routes count = 0
  Accepted routes count = 2
PE3#
PE3#show ip bgp vpv6 all 2222::2
Route Distinguisher: 1:100 (Default for VRF vrf1)
 300
  3001::2(fe80::5054:ff:feee:e4fc) from 3001::2 (10.12.65.71)
  (fe80::5054:ff:feee:e4fc)
  Origin IGP, metric 0, localpref 100, valid, external, best
  Extended Community: RT:1:200
  Not advertised to any peer
  Last update: Fri Mar 15 03:56:59 2019

 300
  ::ffff:3.3.3.3 (metric 12) from 2.2.2.2 (2.2.2.2)
  Origin IGP, metric 0, localpref 100, label 24960, valid, internal
  Extended Community: RT:1:200
  Originator: 3.3.3.3, Cluster list: 2.2.2.2
  rx path_id: 0      tx path_id: -1
  Not advertised to any peer
  Last update: Fri Mar 15 04:09:56 2019

Route Distinguisher: 1:100
 300
  ::ffff:3.3.3.3 (metric 12) from 2.2.2.2 (2.2.2.2)
  Origin IGP, metric 0, localpref 100, label 24960, valid, internal, best
  Extended Community: RT:1:200
  Originator: 3.3.3.3, Cluster list: 2.2.2.2
  rx path_id: 0      tx path_id: -1
  Not advertised to any peer
  Last update: Fri Mar 15 05:55:26 2019

 300
  ::ffff:5.5.5.5 (metric 12) from 2.2.2.2 (2.2.2.2)
  Origin IGP, metric 0, localpref 100, label 24960, valid, internal
  Extended Community: RT:1:200
  Originator: 5.5.5.5, Cluster list: 2.2.2.2
  rx path_id: 2      tx path_id: -1
  Not advertised to any peer
  Last update: Fri Mar 15 05:55:57 2019
```

Validation at PE4

```
PE4#show ip bgp vpnv6 all
Status codes: s suppressed, d damped, h history, a add-path, * valid, > best, i -
internal, l - labeled
              S Stale
Origin codes: i - IGP, e - EGP, ? - incomplete
```

Network	Next Hop	Metric	LocPrf	Weight	Path
Route Distinguisher: 1:100 (Default for VRF vrf1)					
*> 2222::2/128	4001::2 (fe80::5054:ff:fe2e:4cb9)	0	100	0	300 i
* il	::ffff:3.3.3.3		0	100	0
300 i					
Announced routes count = 1					
Accepted routes count = 1					
Route Distinguisher: 1:100					
*>il 2222::2/128	::ffff:3.3.3.3		0	100	0
300 i					
* il	::ffff:4.4.4.4		0	100	0
300 i					

```
Announced routes count = 0
Accepted routes count = 2
PE4#show ip bgp vpnv6 all 2222::2
Route Distinguisher: 1:100 (Default for VRF vrf1)
 300
 4001::2 (fe80::5054:ff:fe2e:4cb9) from 4001::2 (10.12.65.71)
 (fe80::5054:ff:fe2e:4cb9)
  Origin IGP, metric 0, localpref 100, valid, external, best
  Extended Community: RT:1:200
  Not advertised to any peer
  Last update: Fri Mar 15 03:56:38 2019
```

```
300
 ::ffff:3.3.3.3 (metric 12) from 2.2.2.2 (2.2.2.2)
  Origin IGP, metric 0, localpref 100, label 24960, valid, internal
  Extended Community: RT:1:200
  Originator: 3.3.3.3, Cluster list: 2.2.2.2
  rx path_id: 0 tx path_id: -1
  Not advertised to any peer
  Last update: Fri Mar 15 04:09:57 2019
```

```
Route Distinguisher: 1:100
 300
 ::ffff:3.3.3.3 (metric 12) from 2.2.2.2 (2.2.2.2)
  Origin IGP, metric 0, localpref 100, label 24960, valid, internal, best
  Extended Community: RT:1:200
  Originator: 3.3.3.3, Cluster list: 2.2.2.2
  rx path_id: 0 tx path_id: -1
  Not advertised to any peer
  Last update: Fri Mar 15 05:55:28 2019
```

```

300
::ffff:4.4.4.4 (metric 12) from 2.2.2.2 (2.2.2.2)
  Origin IGP, metric 0, localpref 100, label 24960, valid, internal
  Extended Community: RT:1:200
  Originator: 4.4.4.4, Cluster list: 2.2.2.2
  rx path_id: 1      tx path_id: -1
  Not advertised to any peer
  Last update: Fri Mar 15 05:55:59 2019

```

BGP Addpath Selection Configuration all At Neighbor-level under Address-family VPNV6 Unicast

RR

RR(config)#router bgp 100	Configure router bgp mode
RR(config-router)#address-family vpnv6 unicast	Enter BGP address-family vpnv6 unicast mode
RR(config-router-af)#neighbor 1.1.1.1 advertise additional-paths all	Configure RR to advertise All addpaths to PE1
RR(config-router-af)#exit-address-family	Exit bgp address-family mode.
RR(config-router)#exit	Exit Router BGP mode.
RR(config)#commit	Apply commit
RR(config)#exit	Exit Configure mode.

Validation at PE1

```

PE1#show ip bgp vpnv6 all
Status codes: s suppressed, d damped, h history, a add-path, * valid, > best, i -
internal, l - labeled
          S Stale
Origin codes: i - IGP, e - EGP, ? - incomplete

   Network          Next Hop          Metric    LocPrf    Weight Path
Route Distinguisher: 1:100 (Default for VRF vrf1)
*>i l 2222::2/128    ::ffff:3.3.3.3          0          100        0
300 i
  Announced routes count = 0
  Accepted routes count = 1
Route Distinguisher: 1:100
*>i l 2222::2/128    ::ffff:3.3.3.3          0          100        0
300 i
* i l                ::ffff:4.4.4.4          0          100        0
300 i
* i l                ::ffff:5.5.5.5          0          100        0
300 i
  Announced routes count = 0
  Accepted routes count = 3
PE1#show ip bgp vpnv6 all 2222::2
Route Distinguisher: 1:100 (Default for VRF vrf1)
300

```

BGP IPv4 Additional Paths Configuration

```
::ffff:3.3.3.3 (metric 12) from 2.2.2.2 (2.2.2.2)
  Origin IGP, metric 0, localpref 100, label    24960, valid, internal, best
  Extended Community: RT:1:200
  Originator: 3.3.3.3, Cluster list: 2.2.2.2
  rx path_id: 0      tx path_id: -1
  Not advertised to any peer
  Last update: Fri Mar 15 04:10:00 2019
```

Route Distinguisher: 1:100
300

```
::ffff:3.3.3.3 (metric 12) from 2.2.2.2 (2.2.2.2)
  Origin IGP, metric 0, localpref 100, label    24960, valid, internal, best
  Extended Community: RT:1:200
  Originator: 3.3.3.3, Cluster list: 2.2.2.2
  rx path_id: 0      tx path_id: -1
  Not advertised to any peer
  Last update: Fri Mar 15 06:12:37 2019
```

300

```
::ffff:4.4.4.4 (metric 12) from 2.2.2.2 (2.2.2.2)
  Origin IGP, metric 0, localpref 100, label    24960, valid, internal
  Extended Community: RT:1:200
  Originator: 4.4.4.4, Cluster list: 2.2.2.2
  rx path_id: 1      tx path_id: -1
  Not advertised to any peer
  Last update: Fri Mar 15 06:12:57 2019
```

300

```
::ffff:5.5.5.5 (metric 12) from 2.2.2.2 (2.2.2.2)
  Origin IGP, metric 0, localpref 100, label    24960, valid, internal
  Extended Community: RT:1:200
  Originator: 5.5.5.5, Cluster list: 2.2.2.2
  rx path_id: 2      tx path_id: -1
  Not advertised to any peer
  Last update: Fri Mar 15 06:12:57 2019
```

BGP Addpath Selection Configuration Best 2 at Neighbor-level under Address-family VPNV6 Unicast

RR

RR(config)#router bgp 100	Configure router bgp mode
RR(config-router)#address-family vpnv6 unicast	Enter BGP address-family vpnv6 unicast mode
RR(config-router-af)#no neighbor 1.1.1.1 advertise additional-paths all	Configure RR to advertise All addpaths to PE1
RR(config-router-af)#neighbor 1.1.1.1 advertise additional-paths best 2	Configure RR to advertise Best 2 addpaths to PE1
RR(config-router-af)#exit-address-family	Exit bgp address-family mode.
RR(config-router)#exit	Exit Router BGP mode.

RR(config)#commit	Apply commit
RR(config)#exit	Exit Configure mode.

Validation at PE1

```
PE1#show ip bgp vpnv6 all
```

```
Status codes: s suppressed, d damped, h history, a add-path, * valid, > best, i - internal, l - labeled
```

```
          S Stale
```

```
Origin codes: i - IGP, e - EGP, ? - incomplete
```

Network	Next Hop	Metric	LocPrf	Weight	Path
Route Distinguisher: 1:100 (Default for VRF vrf1)					
*>i1 2222::2/128	::ffff:3.3.3.3		0	100	0
300 i					

```
Announced routes count = 0
```

```
Accepted routes count = 1
```

```
Route Distinguisher: 1:100
```

*>i1 2222::2/128	::ffff:3.3.3.3		0	100	0
300 i					

* i1	::ffff:4.4.4.4		0	100	0
300 i					

```
Announced routes count = 0
```

```
Accepted routes count = 2
```

```
PE1#show ip bgp vpnv6 all 2222::2
```

```
Route Distinguisher: 1:100 (Default for VRF vrf1)
```

```
300
```

```
::ffff:3.3.3.3 (metric 12) from 2.2.2.2 (2.2.2.2)
```

```
Origin IGP, metric 0, localpref 100, label 24960, valid, internal, best
```

```
Extended Community: RT:1:200
```

```
Originator: 3.3.3.3, Cluster list: 2.2.2.2
```

```
rx path_id: 0 tx path_id: -1
```

```
Not advertised to any peer
```

```
Last update: Fri Mar 15 04:10:00 2019
```

```
Route Distinguisher: 1:100
```

```
300
```

```
::ffff:3.3.3.3 (metric 12) from 2.2.2.2 (2.2.2.2)
```

```
Origin IGP, metric 0, localpref 100, label 24960, valid, internal, best
```

```
Extended Community: RT:1:200
```

```
Originator: 3.3.3.3, Cluster list: 2.2.2.2
```

```
rx path_id: 0 tx path_id: -1
```

```
Not advertised to any peer
```

```
Last update: Fri Mar 15 06:19:18 2019
```

```
300
```

```
::ffff:4.4.4.4 (metric 12) from 2.2.2.2 (2.2.2.2)
```

```
Origin IGP, metric 0, localpref 100, label 24960, valid, internal
```

```
Extended Community: RT:1:200
```

```
Originator: 4.4.4.4, Cluster list: 2.2.2.2
```

```
rx path_id: 1 tx path_id: -1
```

Not advertised to any peer
 Last update: Fri Mar 15 06:19:58 2019

BGP Addpath Selection Configuration Best 3 At Neighbor-level under Address-family VPNV6 Unicast

RR

RR(config)#router bgp 100	Configure router bgp mode
RR(config-router)#address-family vpnv6 unicast	Enter BGP address-family vpnv6 unicast mode
RR(config-router-af)#no neighbor 1.1.1.1 advertise additional-paths best	Configure RR to advertise All addpaths to PE1
RR(config-router-af)#neighbor 1.1.1.1 advertise additional-paths best 3	Configure RR to advertise Best 3 addpaths to PE1
RR(config-router-af)#exit-address-family	Exit bgp address-family mode.
RR(config-router)#exit	Exit Router BGP mode.
RR(config)#commit	Apply commit
RR(config)#exit	Exit Configure mode.

Validation at PE1

```
PE1#show ip bgp vpnv6 all
Status codes: s suppressed, d damped, h history, a add-path, * valid, > best, i -
internal, l - labeled
                S Stale
Origin codes: i - IGP, e - EGP, ? - incomplete
```

Network	Next Hop	Metric	LocPrf	Weight	Path
Route Distinguisher: 1:100 (Default for VRF vrf1)					
*>i1 2222::2/128	::ffff:3.3.3.3		0	100	0
300 i					
Announced routes count = 0					
Accepted routes count = 1					
Route Distinguisher: 1:100					
*>i1 2222::2/128	::ffff:3.3.3.3		0	100	0
300 i					
* i1	::ffff:4.4.4.4		0	100	0
300 i					
* i1	::ffff:5.5.5.5		0	100	0
300 i					
Announced routes count = 0					
Accepted routes count = 3					

```
PE1#
PE1#show ip bgp vpnv6 all 2222::2
Route Distinguisher: 1:100 (Default for VRF vrf1)
 300
   ::ffff:3.3.3.3 (metric 12) from 2.2.2.2 (2.2.2.2)
     Origin IGP, metric 0, localpref 100, label    24960, valid, internal, best
     Extended Community: RT:1:200
```

```

Originator: 3.3.3.3, Cluster list: 2.2.2.2
rx path_id: 0      tx path_id: -1
Not advertised to any peer
Last update: Fri Mar 15 04:10:00 2019

```

Route Distinguisher: 1:100

300

```

::ffff:3.3.3.3 (metric 12) from 2.2.2.2 (2.2.2.2)
Origin IGP, metric 0, localpref 100, label 24960, valid, internal, best
Extended Community: RT:1:200
Originator: 3.3.3.3, Cluster list: 2.2.2.2
rx path_id: 0      tx path_id: -1
Not advertised to any peer
Last update: Fri Mar 15 06:21:35 2019

```

300

```

::ffff:4.4.4.4 (metric 12) from 2.2.2.2 (2.2.2.2)
Origin IGP, metric 0, localpref 100, label 24960, valid, internal
Extended Community: RT:1:200
Originator: 4.4.4.4, Cluster list: 2.2.2.2
rx path_id: 1      tx path_id: -1
Not advertised to any peer
Last update: Fri Mar 15 06:22:01 2019

```

300

```

::ffff:5.5.5.5 (metric 12) from 2.2.2.2 (2.2.2.2)
Origin IGP, metric 0, localpref 100, label 24960, valid, internal
Extended Community: RT:1:200
Originator: 5.5.5.5, Cluster list: 2.2.2.2
rx path_id: 2      tx path_id: -1
Not advertised to any peer
Last update: Fri Mar 15 06:22:01 2019

```

Disable BGP Addpath for a Specific 6VPE Neighbor

RR

RR(config)#router bgp 100	Configure router bgp mode
RR(config-router)#address-family vpnv6 unicast	Enter BGP address-family vpnv6 unicast mode
RR(config-router-af)#no neighbor 1.1.1.1 advertise additional-paths best	Configure RR to advertise All addpaths to PE1
RR(config-router-af)#neighbor 1.1.1.1 additional-paths disable	Configure RR to Disable Addpath for the 6VPE neighbor PE1
RR(config-router-af)#exit-address-family	Exit bgp address-family mode.
RR(config-router)#exit	Exit Router BGP mode.
RR(config)#commit	Apply commit
RR(config)#exit	Exit Configure mode.

Validation at PE1

```
PE1#show ip bgp vpv6 all
Status codes: s suppressed, d damped, h history, a add-path, * valid, > best, i -
internal, l - labeled
              S Stale
Origin codes: i - IGP, e - EGP, ? - incomplete

      Network          Next Hop          Metric    LocPrf      Weight Path
Route Distinguisher: 1:100 (Default for VRF vrf1)
*>i1 2222::2/128      ::ffff:3.3.3.3          0          100         0
300 i
  Announced routes count = 0
  Accepted routes count = 1
Route Distinguisher: 1:100
*>i1 2222::2/128      ::ffff:3.3.3.3          0          100         0
300 i
  Announced routes count = 0
  Accepted routes count = 1
PE1#show ip bgp vpv6 all 2222::2
Route Distinguisher: 1:100 (Default for VRF vrf1)
 300
   ::ffff:3.3.3.3 (metric 12) from 2.2.2.2 (2.2.2.2)
   Origin IGP, metric 0, localpref 100, label    24960, valid, internal, best
   Extended Community: RT:1:200
   Originator: 3.3.3.3, Cluster list: 2.2.2.2
   Not advertised to any peer
   Last update: Fri Mar 15 06:25:58 2019

Route Distinguisher: 1:100
 300
   ::ffff:3.3.3.3 (metric 12) from 2.2.2.2 (2.2.2.2)
   Origin IGP, metric 0, localpref 100, label    24960, valid, internal, best
   Extended Community: RT:1:200
   Originator: 3.3.3.3, Cluster list: 2.2.2.2
   Not advertised to any peer
   Last update: Fri Mar 15 06:25:58 2019
```

BGP Labeled Unicast IPv4 with Add Path

This section contains basic BGP labeled unicast with Add-Path configuration examples with OSPF as the IGP.

Overview

As MPLS deployments expand beyond the service provider core and edge to the access and metropolitan networks, the number of edge-to-edge label-switched paths (LSPs) in many networks is increasing substantially. This continued growth can present scaling challenges-with some networks already reaching their limit-and can also slow end-to end restoration. Dividing the network into multiple regions can alleviate these issues by limiting the total number of end-to-end LSPs, and enabling failures to be contained and restored in a single region. These regions operate separate instances of interior gateway protocol (IGP), and uses BGP Labeled Unicast (BGP-LU) to advertise route information

between inter region routers. By providing connectivity and communication between regions, BPG-LU enables service providers to massively scale the number of MPLS-enabled devices on their networks.

By default, all BGP routers and Route-Reflectors propagate only their best paths over their sessions. In case they advertise any route with the same NLRI as a previously advertised route, the latest one implicitly replaces the previous advertisement, which is known as an Implicit Withdraw. The Implicit Withdraw can achieve better scaling, but at the cost of path diversity.

The use of route-reflectors thus has significant effect on redundancy by hiding alternate paths. Using full-mesh is not an option, so a mechanism is needed to allow the propagation of multiple alternate paths in an RR environment.

Topology

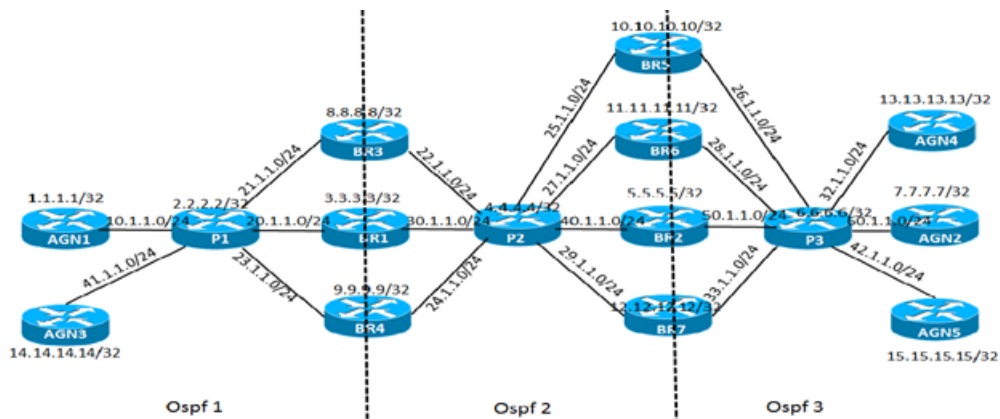

Figure 6-62: BGP Labeled unicast IPv4 with additional paths

Interface Connections

AGN1(eth1) — P1(eth1)
 AGN3(eth5) — P1(eth5)
 P1(eth4) — BR3
 P1(eth2) — BR1
 P1(eth3) — BR4
 BR3(eth3) — P2
 BR1(eth1) — P2
 BR4(eth4) — P2
 P2(eth5) — BR5(eth3) — P3(eth6) — AGN4
 P2(eth6) — BR6(eth4) — P3(eth2) — AGN2
 P2(eth2) — BR2(eth1) — P3(eth7) — AGN5
 P2(eth7) — BR7(eth5) — P3

Configurations

AGN3

AGN3(config)#interface lo	Enter interface lo mode
AGN3(config-if)#ip address 14.14.14.14/32	Configure ip address for loopback interface
AGN3(config-if)#exit	Exit interface loopback mode
AGN3(config)#router ldp	Configure router ldp
AGN3(config-router)#transport-address ipv4 14.14.14.14	Configure transport address as loopback
AGN3(config-router)#exit	Exit the router ldp mode
AGN3(config-if)#interface eth5	Enter interface mode
AGN3(config-if)#ip address 41.1.1.171/24	Configure ip address on the interface
AGN3(config-if)#enable-ldp ipv4	Enable ldp on the interface
AGN3(config-if)#label-switching	Enable label-switching on the interface
AGN3(config-if)#exit	Exit the interface mode
AGN3(config)#router ospf 1	Configure router ospf instance 1
AGN3(config-router)#network 14.14.14.14/32 area 0	Add the loopback network into ospf instance 1
AGN3(config-router)#network 41.1.1.171/24 area 0	Add the ip address into ospf instance 1
AGN3(config-router)#exit	Exit router ospf mode
AGN3(config)#router bgp 100	Enter router bgp mode
AGN3(config-router)#network 14.14.14.14/32	Advertise loopback through network command inside bgp
AGN3(config-router)#neighbor 3.3.3.3 remote-as 100	Configure iBGP neighbor
AGN3(config-router)#neighbor 8.8.8.8 remote-as 100	Configure iBGP neighbor
AGN3(config-router)#neighbor 9.9.9.9 remote-as 100	Configure iBGP neighbor
AGN3(config-router)#neighbor 3.3.3.3 update-source 14.14.14.14	Update the source for the neighbor as loopback ip
AGN3(config-router)#neighbor 8.8.8.8 update-source 14.14.14.14	Update the source for the neighbor as loopback ip
AGN3(config-router)#neighbor 9.9.9.9 update-source 14.14.14.14	Update the source for the neighbor as loopback ip
AGN3(config-router)#neighbor 3.3.3.3 fall-over bfd multihop	Configure bfd for all the neighbors
AGN3(config-router)#neighbor 8.8.8.8 fall-over bfd multihop	Configure bfd for all the neighbors
AGN3(config-router)#neighbor 9.9.9.9 fall-over bfd multihop	Configure bfd for all the neighbors
AGN3(config-router)#allocate-label all	Enable allocate label all command
AGN3(config-router)#address-family ipv4 labeled-unicast	Enter ipv4 labeled-unicast address family

AGN3 (config-router-af) #neighbor 3.3.3.3 activate	Activate the neighbor under ipv4 labeled-unicast address family
AGN3 (config-router-af) #neighbor 8.8.8.8 activate	Activate the neighbor under ipv4 labeled-unicast address family
AGN3 (config-router-af) #neighbor 9.9.9.9 activate	Activate the neighbor under ipv4 labeled-unicast address family
AGN3 (config-router-af) #neighbor 3.3.3.3 next-hop-self	Activate the neighbor under ipv4 labeled-unicast address family
AGN3 (config-router-af) #neighbor 8.8.8.8 next-hop-self	Activate next hop self for the neighbor
AGN3 (config-router-af) #neighbor 9.9.9.9 next-hop-self	Activate next hop self for the neighbor
AGN3 (config-router-af) #bgp additional-paths receive	Enable bgp additional paths receive at global level under ipv4 labeled-unicast address-family
AGN3 (config-router-af) #neighbor 9.9.9.9 additional-paths disable	Disable additional paths for neighbor 9.9.9.9
AGN3 (config-router-af) #exit-address-family	Exit bgp address-family mode.
AGN3 (config-router) #exit	Exit Router BGP mode.
AGN3 (config) #commit	Apply commit
AGN3 (config) #exit	Exit Configure mode.

AGN1

AGN1 (config) #interface lo	Enter interface lo mode
AGN1 (config-if) #ip address 1.1.1.1/32	Configure ip address for loopback interface
AGN1 (config-if) #exit	Exit interface loopback mode
AGN1 (config) #router ldp	Configure router ldp
AGN1 (config-router) #transport-address ipv4 1.1.1.1	Configure transport address as loopback
AGN1 (config-router) #exit	Exit the router ldp mode
AGN1 (config-if) #interface eth1	Enter interface mode
AGN1 (config-if) #ip address 10.1.1.156/24	Configure ip address on the interface
AGN1 (config-if) #enable-ldp ipv4	Enable ldp on the interface
AGN1 (config-if) #label-switching	Enable label-switching on the interface
AGN1 (config-if) #exit	Exit the interface mode
AGN1 (config) #router ospf 1	Configure router ospf instance 1
AGN1 (config-router) #network 1.1.1.1/32 area 0	Add the loopback network into ospf instance 1
AGN1 (config-router) #network 10.1.1.0/24 area 0	Add the ip address into ospf instance 1
AGN1 (config-router) #exit	Exit router ospf mode
AGN1 (config) #router bgp 100	Enter router bgp mode
AGN1 (config-router) #network 1.1.1.1/32	Advertise loopback through network command inside bgp
AGN1 (config-router) #neighbor 3.3.3.3 remote-as 100	Configure iBGP neighbor

BGP IPv4 Additional Paths Configuration

AGN1 (config-router) #neighbor 8.8.8.8 remote-as 100	Configure iBGP neighbor
AGN1 (config-router) #neighbor 9.9.9.9 remote-as 100	Configure iBGP neighbor
AGN1 (config-router) #neighbor 3.3.3.3 update-source 1.1.1.1	Update the source for the neighbor as loopback ip
AGN1 (config-router) #neighbor 8.8.8.8 update-source 1.1.1.1	Update the source for the neighbor as loopback ip
AGN1 (config-router) #neighbor 9.9.9.9 update-source 1.1.1.1	Update the source for the neighbor as loopback ip
AGN1 (config-router) #neighbor 3.3.3.3 fall- over bfd multihop	Configure bfd for all the neighbors
AGN1 (config-router) #neighbor 8.8.8.8 fall- over bfd multihop	Configure bfd for all the neighbors
AGN1 (config-router) #neighbor 9.9.9.9 fall- over bfd multihop	Configure bfd for all the neighbors
AGN1 (config-router) #allocate-label all	Enable allocate label all command
AGN1 (config-router) #address-family ipv4 labeled-unicast	Enter ipv4 labeled-unicast address family
AGN1 (config-router-af) #neighbor 3.3.3.3 activate	Activate the neighbor under ipv4 labeled-unicast address family
AGN1 (config-router-af) #neighbor 8.8.8.8 activate	Activate the neighbor under ipv4 labeled-unicast address family
AGN1 (config-router-af) #neighbor 9.9.9.9 activate	Activate the neighbor under ipv4 labeled-unicast address family
AGN1 (config-router-af) #neighbor 3.3.3.3 next-hop-self	Activate next hop self for the neighbor
AGN1 (config-router-af) #neighbor 8.8.8.8 next-hop-self	Activate next hop self for the neighbor
AGN1 (config-router-af) #neighbor 9.9.9.9 next-hop-self	Activate next hop self for the neighbor
AGN1 (config-router-af) #neighbor 3.3.3.3 additional-paths receive	Enable bgp additional paths receive at neighbor level under ipv4 labeled-unicast address-family
AGN1 (config-router-af) #neighbor 8.8.8.8 additional-paths receive	Enable bgp additional paths receive at neighbor level under ipv4 labeled-unicast address-family
AGN1 (config-router-af) #neighbor 9.9.9.9 additional-paths receive	Enable bgp additional paths receive at neighbor level under ipv4 labeled-unicast address-family
AGN1 (config-router-af) #exit-address-family	Exit bgp address-family mode.
AGN1 (config-router) #exit	Exit Router BGP mode.
AGN1 (config) #commit	Apply commit
AGN1 (config) #exit	Exit Configure mode.

P1

P1 (config) #interface lo	Enter interface lo mode
P1 (config-if) #ip address 2.2.2.2/32	Configure ip address for loopback interface
P1 (config-if) #exit	Exit interface loopback mode
P1 (config) #router ldp	Configure ldp on the router

P1(config-router)#transport-address ipv4 2.2.2.2	Enable loopback ip as transport address
P1(config-router)#exit	Exit the router ldp mode
P1(config)#interface eth1	Enter interface mode
P1(config-if)#ip address 10.1.1.157/24	Configure ip address on the interface
P1(config-if)#enable-ldp ipv4	Enable ldp on the interface
P1(config-if)#label-switching	Enable label switching on the interface
P1(config-if)#exit	Exit the interface mode
P1(config)#interface eth2	Enter interface mode
P1(config-if)#ip address 20.1.1.157/24	Configure ip address on the interface
P1(config-if)#enable-ldp ipv4	Enable ldp on the interface
P1(config-if)#label-switching	Enable label switching on the interface
P1(config-if)#exit	Exit the interface mode
P1(config)#interface eth3	Enter interface mode
P1(config-if)#ip address 23.1.1.157/24	Configure ip address on the interface
P1(config-if)#enable-ldp ipv4	Enable ldp on the interface
P1(config-if)#label-switching	Enable label switching on the interface
P1(config-if)#exit	Exit the interface mode
P1(config)#interface eth4	Enter interface mode
P1(config-if)#ip address 21.1.1.157/24	Configure ip address on the interface
P1(config-if)#enable-ldp ipv4	Enable ldp on the interface
P1(config-if)#label-switching	Enable label switching on the interface
P1(config-if)#exit	Exit the interface mode
P1(config)#interface eth5	Enter interface mode
P1(config-if)#ip address 41.1.1.157/24	Configure ip address on the interface
P1(config-if)#enable-ldp ipv4	Enable ldp on the interface
P1(config-if)#label-switching	Enable label switching on the interface
P1(config-if)#exit	Exit the interface mode
P1(config)#router ospf 1	Enter router ospf mode with instance as 1
P1(config-router)#network 10.1.1.0/24 area 0.0.0.0	Add interface into ospf instance 1 with area 0 using network command
P1(config-router)#network 20.1.1.0/24 area 0.0.0.0	Add interface into ospf instance 1 with area 0 using network command
P1(config-router)#network 21.1.1.0/24 area 0.0.0.0	Add interface into ospf instance 1 with area 0 using network command
P1(config-router)#network 41.1.1.0/24 area 0.0.0.0	Add interface into ospf instance 1 with area 0 using network command
P1(config-router)#network 23.1.1.0/24 area 0.0.0.0	Add interface into ospf instance 1 with area 0 using network command
P1(config-router)#network 2.2.2.2/32 area 0.0.0.0	Add interface loopback into ospf instance 1 with area 0 using network command
P1(config-router)#exit	Exit Router ospf mode.

BGP IPv4 Additional Paths Configuration

P1(config)#commit	Apply commit
P1(config)#exit	Exit Configure mode.

BR3

BR3(config)#enable ext-ospf-multi-inst	Enable ospf multi instance
BR3(config)#interface lo	Enter interface lo mode
BR3(config-if)#ip address 8.8.8.8/32	Configure ip address for loopback interface
BR3(config-if)#exit	Exit the interface mode
BR3(config)#router ldp	Configure ldp on the router
BR3(config-router)#transport-address ipv4 8.8.8.8 0	Enable loopback ip as transport address
BR3(config-router)#exit	Exit the router ldp mode
BR3(config)#interface eth3	Enter interface mode
BR3(config-if)#ip address 22.1.1.165/24	Configure ip address on the interface
BR3(config-if)#enable-ldp ipv4	Enable ldp on the interface
BR3(config-if)#label-switching	Enable label switching on the interface
BR3(config-if)#exit	Exit the interface mode
BR3(config)#interface eth4	Enter interface mode
BR3(config-if)#ip address 21.1.1.165/24	Configure ip address on the interface
BR3(config-if)#enable-ldp ipv4	Enable ldp on the interface
BR3(config-if)#label-switching	Enable label switching on the interface
BR3(config-if)#exit	Exit the interface mode
BR3(config)#router ospf 1	Configure router ospf on BR3 with instance id 1
BR3(config-router)#network 8.8.8.8/32 area 0	Add the loopback network into instance 1
BR3(config-router)#network 21.1.1.165/24 area 0	Add the network as part of ospf instance id 1
BR3(config-router)#exit	Exit the router ospf mode
BR3(config)#router ospf 2	Configure router ospf which will be part of core area with instance id as 2
BR3(config-router)#network 8.8.8.8/32 area 0.0.0.0 instance-id 2	Add interface loopback into ospf instance 2 with area 0 using network command
BR3(config-router)#network 22.1.1.165/24 area 0	Add the network as part of ospf instance id 2
BR3(config-router)#exit	Exit the router ospf mode
BR3(config)#router bgp 100	Configure router bgp
BR3(config-router)#neighbor 1.1.1.1 remote-as 100	Configure ibgp neighbor
BR3(config-router)#neighbor 14.14.14.14 remote-as 100	Configure ibgp neighbor
BR3(config-router)#neighbor 5.5.5.5 remote-as 100	Configure ibgp neighbor
BR3(config-router)#neighbor 10.10.10.10 remote-as 100	Configure ibgp neighbor

BR3(config-router)#neighbor 11.11.11.11 remote-as 100	Configure ibgp neighbor
BR3(config-router)#neighbor 12.12.12.12 remote-as 100	Configure ibgp neighbor
BR3(config-router)#neighbor 1.1.1.1 update- source 8.8.8.8	Configure update source for the neighbor with loopback address
BR3(config-router)#neighbor 14.14.14.14 update-source 8.8.8.8	Configure update source for the neighbor with loopback address
BR3(config-router)#neighbor 5.5.5.5 update- source 8.8.8.8	Configure update source for the neighbor with loopback address
BR3(config-router)#neighbor 10.10.10.10 update-source 8.8.8.8	Configure update source for the neighbor with loopback address
BR3(config-router)#neighbor 11.11.11.11 update-source 8.8.8.8	Configure update source for the neighbor with loopback address
BR3(config-router)#neighbor 12.12.12.12 update-source 8.8.8.8	Configure update source for the neighbor with loopback address
BR3(config-router)#neighbor 1.1.1.1 fall- over bfd multihop	Configure bfd for the neighbor
BR3(config-router)#neighbor 14.14.14.14 fall-over bfd multihop	Configure bfd for the neighbor
BR3(config-router)#neighbor 5.5.5.5 fall- over bfd multihop	Configure bfd for the neighbor
BR3(config-router)#neighbor 10.10.10.10 fall-over bfd multihop	Configure bfd for the neighbor
BR3(config-router)#neighbor 11.11.11.11 fall-over bfd multihop	Configure bfd for the neighbor
BR3(config-router)#neighbor 12.12.12.12 fall-over bfd multihop	Configure bfd for the neighbor
BR3(config-router)#allocate-label all	Configure allocate label all command
R3(config-router)#address-family ipv4 labeled-unicast	Configure address-family ipv4 labeled unicast
BR3(config-router-af)#neighbor 1.1.1.1 activate	Activate the neighbor under address family labeled unicast
BR3(config-router-af)#neighbor 5.5.5.5 activate	Activate the neighbor under address family labeled unicast
BR3(config-router-af)#neighbor 10.10.10.10 activate	Activate the neighbor under address family labeled unicast
BR3(config-router-af)#neighbor 11.11.11.11 activate	Activate the neighbor under address family labeled unicast
BR3(config-router-af)#neighbor 12.12.12.12 activate	Activate the neighbor under address family labeled unicast
BR3(config-router-af)#neighbor 14.14.14.14 activate	Activate the neighbor under address family labeled unicast
BR3(config-router-af)#neighbor 1.1.1.1 route-reflector-client	Configure neighbor as route reflector client
BR3(config-router-af)#neighbor 14.14.14.14 route-reflector-client	Configure neighbor as route reflector client
BR3(config-router-af)#neighbor 5.5.5.5 next- hop-self	Configure next-hop self for the neighbor

BGP IPv4 Additional Paths Configuration

BR3(config-router-af)#neighbor 10.10.10.10 next-hop-self	Configure next-hop self for the neighbor
BR3(config-router-af)#neighbor 11.11.11.11 next-hop-self	Configure next-hop self for the neighbor
BR3(config-router-af)#neighbor 12.12.12.12 next-hop-self	Configure next-hop self for the neighbor
BR3(config-router-af)#neighbor 1.1.1.1 additional-paths send	Enable neighbor level additional paths send for per neighbor
BR3(config-router-af)#neighbor 1.1.1.1 advertise additional-paths best 2	Enable selection of best 2 paths to be advertised to neighbor using neighbor level commands
BR3(config-router-af)#exit-address-family	Exit BGP address-family ipv4-labeled unicast mode
BR3(config-router)#end	Return to configure terminal mode

BR1

BR1(config)#enable ext-ospf-multi-inst	Enable ospf multi instance
BR1(config)#interface lo	Enter interface lo mode
BR1(config-if)#ip address 3.3.3.3/32	Configure ip address for loopback interface
BR1(config-if)#exit	Exit the interface mode
BR1(config)#router ldp	Configure ldp on the router
BR1(config-router)#transport-address ipv4 3.3.3.3 0	Enable loopback ip as transport address
BR1(config-router)#exit	Exit the router ldp mode
BR1(config)#interface eth1	Enter interface mode
BR1(config-if)#ip address 30.1.1.158/24	Configure ip address on the interface
BR1(config-if)#enable-ldp ipv4	Enable ldp on the interface
BR1(config-if)#label-switching	Enable label switching on the interface
BR1(config-if)#exit	Exit the interface mode
BR1(config)#interface eth2	Enter interface mode
BR1(config-if)#ip address 20.1.1.158/24	Configure ip address on the interface
BR1(config-if)#enable-ldp ipv4	Enable ldp on the interface
BR1(config-if)#label-switching	Enable label switching on the interface
BR1(config-if)#exit	Exit the interface mode
BR1(config)#router ospf 1	Configure router ospf with instance id 1
BR1(config-router)#network 3.3.3.3/32 area 0	Add the loopback network into instance 1
BR1(config-router)#network 20.1.1.0/24 area 0	Add the network as part of ospf instance id 1
BR1(config-router)#exit	Exit the router ospf mode
BR1(config)#router ospf 2	Configure router ospf which will be part of core area with instance id as 2
BR1(config-router)#network 3.3.3.3/32 area 0.0.0.0 instance-id 2	Add interface loopback into ospf instance 2 with area 0 using network command
BR1(config-router)#network 30.1.1.0/24 area 0	Add the network as part of ospf instance id 2
BR1(config-router)#exit	Exit the router ospf mode

BR1(config)#route-map BEST2	Create a route-map to select best 2 paths
BR1(config-route-map)#match additional-paths advertise-set select best 2	Select best 2 paths to advertise to the neighbor
BR1(config-route-map)#exit	Exit the route-map mode
BR1(config)#router bgp 100	Configure router bgp
BR1(config-router)#neighbor 1.1.1.1 remote-as 100	Configure ibgp neighbor
BR1(config-router)#neighbor 14.14.14.14 remote-as 100	Configure ibgp neighbor
BR1(config-router)#neighbor 5.5.5.5 remote-as 100	Configure ibgp neighbor
BR1(config-router)#neighbor 10.10.10.10 remote-as 100	Configure ibgp neighbor
BR1(config-router)#neighbor 11.11.11.11 remote-as 100	Configure ibgp neighbor
BR1(config-router)#neighbor 12.12.12.12 remote-as 100	Configure ibgp neighbor
BR1(config-router)#neighbor 1.1.1.1 update-source 3.3.3.3	Configure update source for the neighbor with loopback address
BR1(config-router)#neighbor 14.14.14.14 update-source 3.3.3.3	Configure update source for the neighbor with loopback address
BR1(config-router)#neighbor 5.5.5.5 update-source 3.3.3.3	Configure update source for the neighbor with loopback address
BR1(config-router)#neighbor 10.10.10.10 update-source 3.3.3.3	Configure update source for the neighbor with loopback address
BR1(config-router)#neighbor 11.11.11.11 update-source 3.3.3.3	Configure update source for the neighbor with loopback address
BR1(config-router)#neighbor 12.12.12.12 update-source 3.3.3.3	Configure update source for the neighbor with loopback address
BR1(config-router)#neighbor 1.1.1.1 fall-over bfd multihop	Configure bfd for the neighbor
BR1(config-router)#neighbor 14.14.14.14 fall-over bfd multihop	Configure bfd for the neighbor
BR1(config-router)#neighbor 5.5.5.5 fall-over bfd multihop	Configure bfd for the neighbor
BR1(config-router)#neighbor 10.10.10.10 fall-over bfd multihop	Configure bfd for the neighbor
BR1(config-router)#neighbor 11.11.11.11 fall-over bfd multihop	Configure bfd for the neighbor
BR1(config-router)#neighbor 12.12.12.12 fall-over bfd multihop	Configure bfd for the neighbor
BR1(config-router)#allocate-label all	Configure allocate label all command
BR1(config-router)#address-family ipv4 labeled-unicast	Configure address-family ipv4 labeled unicast
BR1(config-router-af)#neighbor 1.1.1.1 activate	Activate the neighbor under address family labeled unicast
BR1(config-router-af)#neighbor 5.5.5.5 activate	Activate the neighbor under address family labeled unicast

BGP IPv4 Additional Paths Configuration

BR1 (config-router-af) #neighbor 10.10.10.10 activate	Activate the neighbor under address family labeled unicast
BR1 (config-router-af) #neighbor 11.11.11.11 activate	Activate the neighbor under address family labeled unicast
BR1 (config-router-af) #neighbor 12.12.12.12 activate	Activate the neighbor under address family labeled unicast
BR1 (config-router-af) #neighbor 14.14.14.14 activate	Activate the neighbor under address family labeled unicast
BR1 (config-router-af) #neighbor 1.1.1.1 route-reflector-client	Configure neighbor as route reflector client
BR1 (config-router-af) #neighbor 14.14.14.14 route-reflector-client	Configure neighbor as route reflector client
BR1 (config-router-af) #neighbor 5.5.5.5 next-hop-self	Configure next-hop self for the neighbor
BR1 (config-router-af) #neighbor 10.10.10.10 next-hop-self	Configure next-hop self for the neighbor
BR1 (config-router-af) #neighbor 11.11.11.11 next-hop-self	Configure next-hop self for the neighbor
BR1 (config-router-af) #neighbor 12.12.12.12 next-hop-self	Configure next-hop self for the neighbor
BR1 (config-router-af) #neighbor 1.1.1.1 additional-paths send	Enable additional paths send capability on neighbor level under ipv4 labeled unicast address family
BR1 (config-router-af) #neighbor 14.14.14.14 additional-paths send	Enable additional paths send capability on neighbor level under ipv4 labeled unicast address family
BR1 (config-router-af) #neighbor 1.1.1.1 advertise additional-paths all	Enable selection of all paths to be advertised to neighbor using neighbor level commands
BR1 (config-router-af) #neighbor 14.14.14.14 route-map BEST2 out	Enable selection of all paths to be advertised to neighbor using neighbor level commands
BR1 (config-router-af) #exit-address-family	Exit BGP address-family ipv4-labeled unicast mode
BR1 (config-router) #end	Return to configure terminal mode

BR4

BR4 (config) #enable ext-ospf-multi-inst	Enable ospf multi instance
BR4 (config) #interface lo	Enter interface lo mode
BR4 (config-if) #ip address 9.9.9.9/32	Configure ip address for loopback interface
BR4 (config-if) #exit	Exit the interface mode
BR4 (config) #access-list 1 permit 10.10.10.10 0.0.0.0	Configure the access list to allow the BR5 loopback ip
BR4 (config) #access-list 2 permit 11.11.11.11 0.0.0.0	Configure the access list to allow the BR6 loopback ip
BR4 (config) #access-list 3 permit 5.5.5.5 0.0.0.0	Configure the access list to allow the BR2 loopback ip
BR4 (config) #access-list 4 permit 12.12.12.12 0.0.0.0	Configure the access list to allow the BR7 loopback ip
BR4 (config) #route-map A permit 10	Configure route-map A and permit
BR4 (config-route-map) #match ip address 1	Match ip address 1
BR4 (config-route-map) #exit	Exit the route-map

BR4(config)#route-map A permit 20	Configure route-map A and permit
BR4(config-route-map)#match ip address 2	Match ip address 2
BR4(config-route-map)#exit	Exit the route-map
BR4(config)#route-map A permit 30	Configure route-map A and permit
BR4(config-route-map)#match ip address 3	Match ip address 3
BR4(config-route-map)#exit	Exit the route-map
BR4(config)#route-map A permit 40	Configure route-map A and permit
BR4(config-route-map)#match ip address 4	Match ip address 4
BR4(config-route-map)#exit	Exit the route-map
BR4(config)#router ldp	Configure ldp on the router
BR4(config-router)#transport-address ipv4 9.9.9.9 0	Enable loopback ip as transport address
BR4(config-router)#exit	Exit the router ldp mode
BR4(config)#interface eth3	Enter interface mode
BR4(config-if)#ip address 23.1.1.166/24	Configure ip address on the interface
BR4(config-if)#enable-ldp ipv4	Enable ldp on the interface
BR4(config-if)#label-switching	Enable label switching on the interface
BR4(config-if)#exit	Exit the interface mode
BR4(config)#interface eth4	Enter interface mode
BR4(config-if)#ip address 24.1.1.166/24	Configure ip address on the interface
BR4(config-if)#enable-ldp ipv4	Enable ldp on the interface
BR4(config-if)#label-switching	Enable label switching on the interface
BR4(config-if)#exit	Exit the interface mode
BR4(config)#router ospf 1	Configure router ospf with instance id 1
BR4(config-router)#network 9.9.9.9/32 area 0	Add the loopback network into instance 1
BR4(config-router)#network 23.1.1.0/24 area 0	Add the network as part of ospf instance id 1
BR4(config-router)#redistribute ospf 2 route-map A	Redistribute the selected routes from ospf instance 2 into instance 1
BR4(config-router)#exit	Exit the router ospf mode
BR4(config)#router ospf 2	Configure router ospf which will be part of core area with instance id as 2
BR4(config-router)#network 9.9.9.9/32 area 0.0.0.0 instance-id 2	Add interface loopback into ospf instance 2 with area 0 using network command
BR4(config-router)#network 24.1.1.0/24 area 0	Add the network as part of ospf instance id 2
BR4(config-router)#exit	Exit the router ospf mode
BR4(config)#router bgp 100	Configure router bgp
BR4(config-router)#neighbor 1.1.1.1 remote-as 100	Configure ibgp neighbor
BR4(config-router)#neighbor 14.14.14.14 remote-as 100	Configure ibgp neighbor
BR4(config-router)#neighbor 5.5.5.5 remote-as 100	Configure ibgp neighbor

BGP IPv4 Additional Paths Configuration

BR4 (config-router) #neighbor 10.10.10.10 remote-as 100	Configure ibgp neighbor
BR4 (config-router) #neighbor 11.11.11.11 remote-as 100	Configure ibgp neighbor
BR4 (config-router) #neighbor 12.12.12.12 remote-as 100	Configure ibgp neighbor
BR4 (config-router) #neighbor 1.1.1.1 update- source 9.9.9.9	Configure update source for the neighbor with loopback address
BR4 (config-router) #neighbor 14.14.14.14 update-source 9.9.9.9	Configure update source for the neighbor with loopback address
BR4 (config-router) #neighbor 5.5.5.5 update- source 9.9.9.9	Configure update source for the neighbor with loopback address
BR4 (config-router) #neighbor 10.10.10.10 update-source 3.3.3.3	Configure update source for the neighbor with loopback address
BR4 (config-router) #neighbor 11.11.11.11 update-source 9.9.9.9	Configure update source for the neighbor with loopback address
BR4 (config-router) #neighbor 12.12.12.12 update-source 9.9.9.9	Configure update source for the neighbor with loopback address
BR4 (config-router) #neighbor 1.1.1.1 fall- over bfd multihop	Configure bfd for the neighbor
BR4 (config-router) #neighbor 14.14.14.14 fall-over bfd multihop	Configure bfd for the neighbor
BR4 (config-router) #neighbor 5.5.5.5 fall- over bfd multihop	Configure bfd for the neighbor
BR4 (config-router) #neighbor 10.10.10.10 fall-over bfd multihop	Configure bfd for the neighbor
BR4 (config-router) #neighbor 11.11.11.11 fall-over bfd multihop	Configure bfd for the neighbor
BR4 (config-router) #neighbor 12.12.12.12 fall-over bfd multihop	Configure bfd for the neighbor
BR4 (config-router) #allocate-label all	Configure allocate label all command
BR4 (config-router) #address-family ipv4 labeled-unicast	Configure address-family ipv4 labeled unicast
BR4 (config-router-af) #neighbor 1.1.1.1 activate	Activate the neighbor under address family labeled unicast
BR4 (config-router-af) #neighbor 5.5.5.5 activate	Activate the neighbor under address family labeled unicast
BR4 (config-router-af) #neighbor 10.10.10.10 activate	Activate the neighbor under address family labeled unicast
BR4 (config-router-af) #neighbor 11.11.11.11 activate	Activate the neighbor under address family labeled unicast
BR4 (config-router-af) #neighbor 12.12.12.12 activate	Activate the neighbor under address family labeled unicast
BR4 (config-router-af) #neighbor 14.14.14.14 activate	Activate the neighbor under address family labeled unicast
BR4 (config-router-af) #neighbor 1.1.1.1 route-reflector-client	Configure neighbor as route reflector client
BR4 (config-router-af) #neighbor 14.14.14.14 route-reflector-client	Configure neighbor as route reflector client

BR4 (config-router-af) #neighbor 5.5.5.5 next-hop-self	Configure next-hop self for the neighbor
BR4 (config-router-af) #neighbor 10.10.10.10 next-hop-self	Configure next-hop self for the neighbor
BR4 (config-router-af) #neighbor 11.11.11.11 next-hop-self	Configure next-hop self for the neighbor
BR4 (config-router-af) #neighbor 12.12.12.12 next-hop-self	Configure next-hop self for the neighbor
BR4 (config-router-af) #bgp additional-paths send	Enable additional paths send capability at global level under address-family labeled-unicast
BR4 (config-router-af) #neighbor 1.1.1.1 advertise additional-paths best 3	Enable selection of best 3 paths per neighbor using neighbor level commands
BR4 (config-router-af) #neighbor 14.14.14.14 advertise additional-paths all	Enable selection of all paths to be advertised to neighbor using neighbor level commands
BR4 (config-router-af) #exit-address-family	Exit BGP address-family ipv4-labeled unicast mode
BR4 (config-router) #end	Return to configure terminal mode

P2

P2 (config) #interface lo	Enter interface lo mode
P2 (config-if) #ip address 4.4.4.4/32	Configure ip address for loopback interface
P2 (config-if) #exit	Exit interface loopback mode
P2 (config) #router ldp	Configure ldp on the router
P2 (config-router) #transport-address ipv4 4.4.4.4 0	Enable loopback ip as transport address
P2 (config-router) #exit	Exit the router ldp mode
P2 (config) #interface eth1	Enter interface mode
P2 (config-if) #ip address 30.1.1.159/24	Configure ip address on the interface
P2 (config-if) #enable-ldp ipv4	Enable ldp on the interface
P2 (config-if) #label-switching	Enable label switching on the interface
P2 (config-if) #exit	Exit the interface mode
P2 (config) #interface eth2	Enter interface mode
P2 (config-if) #ip address 40.1.1.159/24	Configure ip address on the interface
P2 (config-if) #enable-ldp ipv4	Enable ldp on the interface
P2 (config-if) #label-switching	Enable label switching on the interface
P2 (config-if) #exit	Exit the interface mode
P2 (config) #interface eth3	Enter interface mode
P2 (config-if) #ip address 22.1.1.159/24	Configure ip address on the interface
P2 (config-if) #enable-ldp ipv4	Enable rsvp on the interface
P2 (config-if) #label-switching	Enable label switching on the interface
P2 (config-if) #exit	Exit the interface mode
P2 (config) #interface eth4	Enter interface mode
P2 (config-if) #ip address 24.1.1.159/24	Configure ip address on the interface
P2 (config-if) #enable-ldp ipv4	Enable ldp on the interface

BGP IPv4 Additional Paths Configuration

P2(config-if)#label-switching	Enable label switching on the interface
P2(config-if)#exit	Exit the interface mode
P2(config)#interface eth5	Enter interface mode
P2(config-if)#ip address 25.1.1.159/24	Configure ip address on the interface
P2(config-if)#enable-ldp ipv4	Enable ldp on the interface
P2(config-if)#label-switching	Enable label switching on the interface
P2(config-if)#exit	Exit the interface mode
P2(config)#interface eth6	Enter interface mode
P2(config-if)#ip address 27.1.1.159/24	Configure ip address on the interface
P2(config-if)#enable-ldp ipv4	Enable ldp on the interface
P2(config-if)#label-switching	Enable label switching on the interface
P2(config-if)#exit	Exit the interface mode
P2(config)#interface eth7	Enter interface mode
P2(config-if)#ip address 29.1.1.159/24	Configure ip address on the interface
P2(config-if)#enable-ldp ipv4	Enable ldp on the interface
P2(config-if)#label-switching	Enable label switching on the interface
P2(config-if)#exit	Exit the interface mode
P2(config)#router ospf 2	Configure Router ospf with instance id 2
P2(config-router)#network 30.1.1.0/24 area 0.0.0.0	Add interface into ospf instance 2 with area 0 using network command
P2(config-router)#network 40.1.1.0/24 area 0.0.0.0	Add interface into ospf instance 2 with area 0 using network command
P2(config-router)#network 22.1.1.0/24 area 0.0.0.0	Add interface into ospf instance 2 with area 0 using network command
P2(config-router)#network 24.1.1.0/24 area 0.0.0.0	Add interface into ospf instance 2 with area 0 using network command
P2(config-router)#network 25.1.1.0/24 area 0.0.0.0	Add interface into ospf instance 2 with area 0 using network command
P2(config-router)#network 27.1.1.0/24 area 0.0.0.0	Add interface into ospf instance 2 with area 0 using network command
P2(config-router)#network 29.1.1.0/24 area 0.0.0.0	Add interface into ospf instance 2 with area 0 using network command
P2(config-router)#network 4.4.4.4/32 area 0.0.0.0	Add interface loopback into ospf instance 2 with area 0 using network command
P2(config-router)#exit	Exit router ospf mode

BR5

BR5(config)#enable ext-ospf-multi-inst	Enable ospf multi instance
BR5(config)#interface lo	Enter interface lo mode
BR5(config-if)#ip address 10.10.10.10/32	Configure ip address for loopback interface
BR5(config-if)#exit	Exit the interface mode
BR5(config)#router ldp	Configure ldp on the router

BR5(config-router)#transport-address ipv4 10.10.10.10 0	Enable loopback ip as transport address
BR5(config-router)#exit	Exit router ldp mode
BR5(config)#interface eth3	Enter interface mode
BR5(config-if)#ip address 26.1.1.167/24	Configure ip address on the interface
BR5(config-if)#enable-ldp ipv4	Enable ldp on the interface
BR5(config-if)#label-switching	Enable label switching on the interface
BR5(config-if)#exit	Exit the interface mode
BR5(config)#interface eth5	Enter interface mode
BR5(config-if)#ip address 25.1.1.167/24	Configure ip address on the interface
BR5(config-if)#enable-ldp ipv4	Enable ldp on the interface
BR5(config-if)#label-switching	Enable label switching on the interface
BR5(config-if)#exit	Exit the interface mode
BR5(config)#router ospf 2	Configure router ospf with instance id 2
BR5(config-router)#network 10.10.10.10/32 area 0	Add the loopback network into instance 2
BR5(config-router)#network 25.1.1.0/24 area 0	Add the network as part of ospf instance id 2
BR5(config-router)#exit	Exit the router ospf mode
BR5(config)#router ospf 3	Configure router ospf which will be part of aggregation area 2 with instance id as 3
BR5(config-router)#network 10.10.10.10/32 area 0.0.0.0 instance-id 3	Add interface loopback into ospf instance 3 with area 0 using network command
BR5(config-router)#network 26.1.1.0/24 area 0	Add the network as part of ospf instance id 3
BR5(config-router)#exit	Exit the router ospf mode
BR5(config)#router bgp 100	Configure router bgp
BR5(config-router)#neighbor 3.3.3.3 remote-as 100	Configure ibgp neighbor
BR5(config-router)#neighbor 7.7.7.7 remote-as 100	Configure ibgp neighbor
BR5(config-router)#neighbor 8.8.8.8 remote-as 100	Configure ibgp neighbor
BR5(config-router)#neighbor 9.9.9.9 remote-as 100	Configure ibgp neighbor
BR5(config-router)#neighbor 13.13.13.13 remote-as 100	Configure ibgp neighbor
BR5(config-router)#neighbor 15.15.15.15 remote-as 100	Configure ibgp neighbor
BR5(config-router)#neighbor 3.3.3.3 update-source 10.10.10.10	Configure update source for the neighbor with loopback address
BR5(config-router)#neighbor 7.7.7.7 update-source 10.10.10.10	Configure update source for the neighbor with loopback address
BR5(config-router)#neighbor 8.8.8.8 update-source 10.10.10.10	Configure update source for the neighbor with loopback address
BR5(config-router)#neighbor 9.9.9.9 update-source 10.10.10.10	Configure update source for the neighbor with loopback address

BGP IPv4 Additional Paths Configuration

BR5(config-router)#neighbor 13.13.13.13 update-source 10.10.10.10	Configure update source for the neighbor with loopback address
BR5(config-router)#neighbor 15.15.15.15 update-source 10.10.10.10	Configure update source for the neighbor with loopback address
BR5(config-router)#neighbor 3.3.3.3 fall-over bfd multihop	Configure bfd for the neighbor
BR5(config-router)#neighbor 7.7.7.7 fall-over bfd multihop	Configure bfd for the neighbor
BR5(config-router)#neighbor 8.8.8.8 fall-over bfd multihop	Configure bfd for the neighbor
BR5(config-router)#neighbor 9.9.9.9 fall-over bfd multihop	Configure bfd for the neighbor
BR5(config-router)#neighbor 13.13.13.13 fall-over bfd multihop	Configure bfd for the neighbor
BR5(config-router)#neighbor 15.15.15.15 fall-over bfd multihop	Configure bfd for the neighbor
BR5(config-router)#allocate-label all	Configure allocate label all command
BR5(config-router)#address-family ipv4 labeled-unicast	Configure address-family ipv4 labeled unicast
BR5(config-router-af)#neighbor 3.3.3.3 activate	Activate the neighbor under address family labeled unicast
BR5(config-router-af)#neighbor 7.7.7.7 activate	Activate the neighbor under address family labeled unicast
BR5(config-router-af)#neighbor 8.8.8.8 activate	Activate the neighbor under address family labeled unicast
BR5(config-router-af)#neighbor 9.9.9.9 activate	Activate the neighbor under address family labeled unicast
BR5(config-router-af)#neighbor 13.13.13.13 activate	Activate the neighbor under address family labeled unicast
BR5(config-router-af)#neighbor 15.15.15.15 activate	Activate the neighbor under address family labeled unicast
BR5(config-router-af)#neighbor 13.13.13.13 route-reflector-client	Configure neighbor as route reflector client
BR5(config-router-af)#neighbor 7.7.7.7 route-reflector-client	Configure neighbor as route reflector client
BR5(config-router-af)#neighbor 15.15.15.15 next-hop-self	Configure next-hop self for the neighbor
BR5(config-router-af)#neighbor 3.3.3.3 next-hop-self	Configure next-hop self for the neighbor
BR5(config-router-af)#neighbor 8.8.8.8 next-hop-self	Configure next-hop self for the neighbor
BR5(config-router-af)#neighbor 9.9.9.9 next-hop-self	Configure next-hop self for the neighbor
BR5(config-router-af)#bgp additional-paths send	Enable additional paths send capability on neighbor level under ipv4 labeled unicast address family
BR5(config-router-af)#bgp additional-paths select all	Select all the available paths to advertise to the next router
BR5(config-router)#exit	Exit BGP router mode

BR6

BR6(config)#enable ext-ospf-multi-inst	Enable ospf multi instance
BR6(config)#interface lo	Enter interface lo mode
BR6(config-if)#ip address 11.11.11.11/32	Configure ip address for loopback interface
BR6(config-if)#exit	Exit the interface mode
BR6(config)#router ldp	Configure ldp on the router
BR6(config-router)#transport-address ipv4 11.11.11.11	Enable loopback ip as transport address
BR5(config-router)#exit	Exit router ldp mode
BR6(config)#interface eth4	Enter interface mode
BR6(config-if)#ip address 28.1.1.168/24	Configure ip address on the interface
BR6(config-if)#enable-ldp ipv4	Enable ldp on the interface
BR6(config-if)#label-switching	Enable label switching on the interface
BR6(config-if)#exit	Exit the interface mode
BR6(config)#interface eth6	Enter interface mode
BR6(config-if)#ip address 27.1.1.168/24	Configure ip address on the interface
BR6(config-if)#enable-ldp ipv4	Enable ldp on the interface
BR6(config-if)#label-switching	Enable label switching on the interface
BR6(config-if)#exit	Exit the interface mode
BR6(config)#router ospf 2	Configure router ospf with instance id 2
BR6(config-router)#network 11.11.11.11/32 area 0	Add the loopback network into instance 2
BR6(config-router)#network 27.1.1.0/24 area 0	Add the network as part of ospf instance id 2
BR6(config-router)#exit	Exit the router ospf mode
BR6(config)#router ospf 3	Configure router ospf which will be part of aggregation 2 with instance id as 3
BR6(config-router)#network 11.11.11.11/32 area 0.0.0.0 instance-id 3	Add interface loopback into ospf instance 3 with area 0 using network command
BR6(config-router)#network 28.1.1.0/24 area 0	Add the network as part of ospf instance id 3
BR6(config-router)#exit	Exit the router ospf mode
BR6(config)#router bgp 100	Configure router bgp
BR6(config-router)#neighbor 3.3.3.3 remote-as 100	Configure ibgp neighbor
BR6(config-router)#neighbor 7.7.7.7 remote-as 100	Configure ibgp neighbor
BR6(config-router)#neighbor 8.8.8.8 remote-as 100	Configure ibgp neighbor
BR6(config-router)#neighbor 9.9.9.9 remote-as 100	Configure ibgp neighbor
BR6(config-router)#neighbor 13.13.13.13 remote-as 100	Configure ibgp neighbor

BGP IPv4 Additional Paths Configuration

BR6(config-router)#neighbor 15.15.15.15 remote-as 100	Configure ibgp neighbor
BR6(config-router)#neighbor 3.3.3.3 update-source 11.11.11.11	Configure update source for the neighbor with loopback address
BR6(config-router)#neighbor 7.7.7.7 update-source 11.11.11.11	Configure update source for the neighbor with loopback address
BR6(config-router)#neighbor 8.8.8.8 update-source 11.11.11.11	Configure update source for the neighbor with loopback address
BR6(config-router)#neighbor 9.9.9.9 update-source 11.11.11.11	Configure update source for the neighbor with loopback address
BR6(config-router)#neighbor 13.13.13.13 update-source 11.11.11.11	Configure update source for the neighbor with loopback address
BR6(config-router)#neighbor 15.15.15.15 update-source 11.11.11.11	Configure update source for the neighbor with loopback address
BR6(config-router)#neighbor 3.3.3.3 fall-over bfd multihop	Configure bfd for the neighbor
BR6(config-router)#neighbor 7.7.7.7 fall-over bfd multihop	Configure bfd for the neighbor
BR6(config-router)#neighbor 8.8.8.8 fall-over bfd multihop	Configure bfd for the neighbor
BR6(config-router)#neighbor 9.9.9.9 fall-over bfd multihop	Configure bfd for the neighbor
BR6(config-router)#neighbor 13.13.13.13 fall-over bfd multihop	Configure bfd for the neighbor
BR6(config-router)#neighbor 15.15.15.15 fall-over bfd multihop	Configure bfd for the neighbor
BR6(config-router)#allocate-label all	Configure allocate label all command
BR6(config-router)#address-family ipv4 labeled-unicast	Configure address-family ipv4 labeled unicast
BR6(config-router-af)#neighbor 3.3.3.3 activate	Activate the neighbor under address family labeled unicast
BR6(config-router-af)#neighbor 7.7.7.7 activate	Activate the neighbor under address family labeled unicast
BR6(config-router-af)#neighbor 8.8.8.8 activate	Activate the neighbor under address family labeled unicast
BR6(config-router-af)#neighbor 9.9.9.9 activate	Activate the neighbor under address family labeled unicast
BR6(config-router-af)#neighbor 13.13.13.13 activate	Activate the neighbor under address family labeled unicast
BR6(config-router-af)#neighbor 15.15.15.15 activate	Activate the neighbor under address family labeled unicast
BR6(config-router-af)#neighbor 13.13.13.13 route-reflector-client	Configure neighbor as route reflector client
BR6(config-router-af)#neighbor 7.7.7.7 route-reflector-client	Configure neighbor as route reflector client
BR6(config-router-af)#neighbor 15.15.15.15 route-reflector-client	Configure neighbor as route reflector client
BR6(config-router-af)#neighbor 15.15.15.15 next-hop-self	Configure next-hop self for the neighbor

BR6(config-router-af)#neighbor 3.3.3.3 next-hop-self	Configure next-hop self for the neighbor
BR6(config-router-af)#neighbor 8.8.8.8 next-hop-self	Configure next-hop self for the neighbor
BR6(config-router-af)#neighbor 9.9.9.9 next-hop-self	Configure next-hop self for the neighbor
BR6(config-router-af)#bgp additional-paths send	Enable additional paths send capability on neighbor level under ipv4 labeled unicast address family
BR6(config-router-af)#bgp additional-paths select best 2	Select best 2 paths from the available additional paths to advertise to the next router
BR6(config-router)#exit	Exit BGP router mode

BR2

BR2(config)#enable ext-ospf-multi-inst	Enable ospf multi instance
BR2(config)#interface lo	Enter interface lo mode
BR2(config-if)#ip address 5.5.5.5/32	Configure ip address for loopback interface
BR2(config-if)#exit	Exit the interface mode
BR2(config)#router ldp	Configure ldp on the router
BR2(config-router)#transport-address ipv4 5.5.5.5	Enable loopback ip as transport address
BR2(config-router)#exit	Exit router ldp mode
BR2(config)#interface eth1	Enter interface mode
BR2(config-if)#ip address 50.1.1.160/24	Configure ip address on the interface
BR2(config-if)#enable-ldp ipv4	Enable ldp on the interface
BR2(config-if)#label-switching	Enable label switching on the interface
BR2(config-if)#exit	Exit the interface mode
BR2(config)#interface eth2	Enter interface mode
BR2(config-if)#ip address 40.1.1.160/24	Configure ip address on the interface
BR2(config-if)#enable-ldp ipv4	Enable ldp on the interface
BR2(config-if)#label-switching	Enable label switching on the interface
BR2(config-if)#exit	Exit the interface mode
BR2(config)#router ospf 2	Configure router ospf with instance id 2
BR2(config-router)#network 5.5.5.5/32 area 0	Add the loopback network into instance 2
BR2(config-router)#network 40.1.1.0/24 area 0	Add the network as part of ospf instance id 2
BR2(config-router)#exit	Exit the router ospf mode
BR2(config)#router ospf 3	Configure router ospf which will be part of aggregation 2 with instance id as 3
BR2(config-router)#network 5.5.5.5/32 area 0.0.0.0 instance-id 3	Add interface loopback into ospf instance 3 with area 0 using network command
BR2(config-router)#network 50.1.1.0/24 area 0	Add the network as part of ospf instance id 3
BR2(config-router)#exit	Exit the router ospf mode
BR2(config)#router bgp 100	Configure router bgp

BGP IPv4 Additional Paths Configuration

BR2(config-router)#neighbor 3.3.3.3 remote-as 100	Configure ibgp neighbor
BR2(config-router)#neighbor 7.7.7.7 remote-as 100	Configure ibgp neighbor
BR2(config-router)#neighbor 8.8.8.8 remote-as 100	Configure ibgp neighbor
BR2(config-router)#neighbor 9.9.9.9 remote-as 100	Configure ibgp neighbor
BR2(config-router)#neighbor 13.13.13.13 remote-as 100	Configure ibgp neighbor
BR2(config-router)#neighbor 15.15.15.15 remote-as 100	Configure ibgp neighbor
BR2(config-router)#neighbor 3.3.3.3 update-source 5.5.5.5	Configure update source for the neighbor with loopback address
BR2(config-router)#neighbor 7.7.7.7 update-source 5.5.5.5	Configure update source for the neighbor with loopback address
BR2(config-router)#neighbor 8.8.8.8 update-source 5.5.5.5	Configure update source for the neighbor with loopback address
BR2(config-router)#neighbor 9.9.9.9 update-source 5.5.5.5	Configure update source for the neighbor with loopback address
BR2(config-router)#neighbor 13.13.13.13 update-source 5.5.5.5	Configure update source for the neighbor with loopback address
BR2(config-router)#neighbor 15.15.15.15 update-source 5.5.5.5	Configure update source for the neighbor with loopback address
BR2(config-router)#neighbor 3.3.3.3 fall-over bfd multihop	Configure bfd for the neighbor
BR2(config-router)#neighbor 7.7.7.7 fall-over bfd multihop	Configure bfd for the neighbor
BR2(config-router)#neighbor 8.8.8.8 fall-over bfd multihop	Configure bfd for the neighbor
BR2(config-router)#neighbor 9.9.9.9 fall-over bfd multihop	Configure bfd for the neighbor
BR2(config-router)#neighbor 13.13.13.13 fall-over bfd multihop	Configure bfd for the neighbor
BR2(config-router)#neighbor 15.15.15.15 fall-over bfd multihop	Configure bfd for the neighbor
BR2(config-router)#allocate-label all	Configure allocate label all command
BR2(config-router)#address-family ipv4 labeled-unicast	Configure address-family ipv4 labeled unicast
BR2(config-router-af)#neighbor 3.3.3.3 activate	Activate the neighbor under address family labeled unicast
BR2(config-router-af)#neighbor 7.7.7.7 activate	Activate the neighbor under address family labeled unicast
BR2(config-router-af)#neighbor 8.8.8.8 activate	Activate the neighbor under address family labeled unicast
BR2(config-router-af)#neighbor 9.9.9.9 activate	Activate the neighbor under address family labeled unicast
BR2(config-router-af)#neighbor 13.13.13.13 activate	Activate the neighbor under address family labeled unicast

BR2 (config-router-af) #neighbor 15.15.15.15 activate	Activate the neighbor under address family labeled unicast
BR2 (config-router-af) #neighbor 13.13.13.13 route-reflector-client	Configure neighbor as route reflector client
BR2 (config-router-af) #neighbor 7.7.7.7 route-reflector-client	Configure neighbor as route reflector client
BR2 (config-router-af) #neighbor 15.15.15.15 route-reflector-client	Configure neighbor as route reflector client
BR2 (config-router-af) #neighbor 15.15.15.15 next-hop-self	Configure next-hop self for the neighbor
BR2 (config-router-af) #neighbor 3.3.3.3 next-hop-self	Configure next-hop self for the neighbor
BR2 (config-router-af) #neighbor 8.8.8.8 next-hop-self	Configure next-hop self for the neighbor
BR2 (config-router-af) #neighbor 9.9.9.9 next-hop-self	Configure next-hop self for the neighbor
BR2 (config-router-af) #bgp additional-paths send	Enable additional paths send capability on neighbor level under ipv4 labeled unicast address family
BR2 (config-router-af) #bgp additional-paths select best 3	Select best 3 paths from the available additional paths to advertise to the next router
BR2 (config-router) #exit	Exit BGP router mode

BR7

BR7 (config) #enable ext-ospf-multi-inst	Enable ospf multi instance
BR7 (config) #interface lo	Enter interface lo mode
BR7 (config-if) #ip address 12.12.12.12/32	Configure ip address for loopback interface
BR7 (config-if) #exit	Exit the interface mode
BR7 (config) #access-list 1 permit 3.3.3.3 0.0.0.0	Configure the access list to allow the BR5 loopback ip
BR7 (config) #access-list 2 permit 8.8.8.8 0.0.0.0	Configure the access list to allow the BR6 loopback ip
BR7 (config) #access-list 3 permit 9.9.9.9 0.0.0.0	Configure the access list to allow the BR7 loopback ip
BR7 (config) #route-map A permit 10	Configure route-map A and permit
BR7 (config-route-map) #match ip address 1	Match ip address 1
BR7 (config-route-map) #exit	Exit the route-map
BR7 (config) #route-map A permit 20	Configure route-map A and permit
BR7 (config-route-map) #match ip address 2	Match ip address 2
BR7 (config-route-map) #exit	Exit the route-map
BR7 (config) #route-map A permit 30	Configure route-map A and permit
BR7 (config-route-map) #match ip address 3	Match ip address 3
BR7 (config-route-map) #exit	Exit the route-map
BR7 (config) #router ldp	Configure ldp on the router
BR7 (config-router) #transport-address ipv4 12.12.12.12 0	Enable loopback ip as transport address

BGP IPv4 Additional Paths Configuration

BR7(config-router)#exit	Exit router ldp mode
BR7(config)#interface eth5	Enter interface mode
BR7(config-if)#ip address 33.1.1.169/24	Configure ip address on the interface
BR7(config-if)#enable-ldp ipv4	Enable ldp on the interface
BR7(config-if)#label-switching	Enable label switching on the interface
BR7(config-if)#exit	Exit the interface mode
BR7(config)#interface eth7	Enter interface mode
BR7(config-if)#ip address 29.1.1.169/24	Configure ip address on the interface
BR7(config-if)#enable-ldp ipv4	Enable ldp on the interface
BR7(config-if)#label-switching	Enable label switching on the interface
BR7(config-if)#exit	Exit the interface mode
BR7(config)#router ospf 2	Configure router ospf with instance id 2
BR7(config-router)#network 12.12.12.12/32 area 0	Add the loopback network into instance 2
BR7(config-router)#network 29.1.1.0/24 area 0	Add the network as part of ospf instance id 2
BR7(config-router)#exit	Exit the router ospf mode
BR7(config)#router ospf 3	Configure router ospf which will be part of aggregation 2 with instance id as 3
BR7(config-router)#redistribute ospf 2 route-map A	Redistribute selected loopbacks into ospf instance 3
BR7(config-router)#network 12.12.12.12/32 area 0.0.0.0 instance-id 3	Add interface loopback into ospf instance 3 with area 0 using network command
BR7(config-router)#network 33.1.1.0/24 area 0	Add the network as part of ospf instance id 3
BR7(config-router)#exit	Exit the router ospf mode
BR7(config)#router bgp 100	Configure router bgp
BR7(config-router)#neighbor 3.3.3.3 remote-as 100	Configure ibgp neighbor
BR7(config-router)#neighbor 7.7.7.7 remote-as 100	Configure ibgp neighbor
BR7(config-router)#neighbor 8.8.8.8 remote-as 100	Configure ibgp neighbor
BR7(config-router)#neighbor 9.9.9.9 remote-as 100	Configure ibgp neighbor
BR7(config-router)#neighbor 13.13.13.13 remote-as 100	Configure ibgp neighbor
BR7(config-router)#neighbor 15.15.15.15 remote-as 100	Configure ibgp neighbor
BR7(config-router)#neighbor 3.3.3.3 update-source 12.12.12.12	Configure update source for the neighbor with loopback address
BR7(config-router)#neighbor 7.7.7.7 update-source 12.12.12.12	Configure update source for the neighbor with loopback address
BR7(config-router)#neighbor 8.8.8.8 update-source 12.12.12.12	Configure update source for the neighbor with loopback address
BR7(config-router)#neighbor 9.9.9.9 update-source 12.12.12.12	Configure update source for the neighbor with loopback address

BR7(config-router)#neighbor 13.13.13.13 update-source 12.12.12.12	Configure update source for the neighbor with loopback address
BR7(config-router)#neighbor 15.15.15.15 update-source 12.12.12.12	Configure update source for the neighbor with loopback address
BR7(config-router)#neighbor 3.3.3.3 fall-over bfd multihop	Configure bfd for the neighbor
BR7(config-router)#neighbor 7.7.7.7 fall-over bfd multihop	Configure bfd for the neighbor
BR7(config-router)#neighbor 8.8.8.8 fall-over bfd multihop	Configure bfd for the neighbor
BR7(config-router)#neighbor 9.9.9.9 fall-over bfd multihop	Configure bfd for the neighbor
BR7(config-router)#neighbor 13.13.13.13 fall-over bfd multihop	Configure bfd for the neighbor
BR7(config-router)#neighbor 15.15.15.15 fall-over bfd multihop	Configure bfd for the neighbor
BR7(config-router)#allocate-label all	Configure allocate label all command
BR7(config-router)#address-family ipv4 labeled-unicast	Configure address-family ipv4 labeled unicast
BR7(config-router-af)#neighbor 3.3.3.3 activate	Activate the neighbor under address family labeled unicast
BR7(config-router-af)#neighbor 7.7.7.7 activate	Activate the neighbor under address family labeled unicast
BR7(config-router-af)#neighbor 8.8.8.8 activate	Activate the neighbor under address family labeled unicast
BR7(config-router-af)#neighbor 9.9.9.9 activate	Activate the neighbor under address family labeled unicast
BR7(config-router-af)#neighbor 13.13.13.13 activate	Activate the neighbor under address family labeled unicast
BR7(config-router-af)#neighbor 15.15.15.15 activate	Activate the neighbor under address family labeled unicast
BR7(config-router-af)#neighbor 13.13.13.13 route-reflector-client	Configure neighbor as route reflector client
BR7(config-router-af)#neighbor 7.7.7.7 route-reflector-client	Configure neighbor as route reflector client
BR7(config-router-af)#neighbor 15.15.15.15 route-reflector-client	Configure neighbor as route reflector client
BR7(config-router-af)#neighbor 15.15.15.15 next-hop-self	Configure next-hop self for the neighbor
BR7(config-router-af)#neighbor 3.3.3.3 next-hop-self	Configure next-hop self for the neighbor
BR7(config-router-af)#neighbor 8.8.8.8 next-hop-self	Configure next-hop self for the neighbor
BR7(config-router-af)#neighbor 9.9.9.9 next-hop-self	Configure next-hop self for the neighbor
BR7(config-router-af)#bgp additional-paths send-receive	Enable additional paths send-receive capability on neighbor level under ipv4 labeled unicast address family
BR7(config-router-af)#bgp additional-paths select all	Select all additional paths to advertise to the next router

BGP IPv4 Additional Paths Configuration

BR7(config-router-af)#exit-address-family	Exit bgp address-family ipv6 labeled-unicast mode
BR7(config-router)#exit	Exit BGP router mode

P3

P3(config)#interface lo	Enter interface lo mode
P3(config-if)#ip address 6.6.6.6/32	Configure ip address for loopback interface
P3(config-if)#exit	Exit interface loopback mode
P3(config)#router ldp	Configure ldp on the router
P3(config-router)#transport-address ipv4 6.6.6.6 0	Enable loopback ip as transport address
P3(config-router)#exit	Exit the router ldp mode
P3(config)#interface eth1	Enter interface mode
P3(config-if)#ip address 50.1.1.161/24	Configure ip address on the interface
P3(config-if)#enable-ldp ipv4	Enable ldp on the interface
P3(config-if)#label-switching	Enable label switching on the interface
P3(config-if)#exit	Exit the interface mode
P3(config)#interface eth2	Enter interface mode
P3(config-if)#ip address 60.1.1.161/24	Configure ip address on the interface
P3(config-if)#enable-ldp ipv4	Enable ldp on the interface
P3(config-if)#label-switching	Enable label switching on the interface
P3(config-if)#exit	Exit the interface mode
P3(config)#interface eth3	Enter interface mode
P3(config-if)#ip address 26.1.1.161/24	Configure ip address on the interface
P3(config-if)#enable-ldp ipv4	Enable rsvp on the interface
P3(config-if)#label-switching	Enable label switching on the interface
P3(config-if)#exit	Exit the interface mode
P3(config)#interface eth4	Enter interface mode
P3(config-if)#ip address 28.1.1.161/24	Configure ip address on the interface
P3(config-if)#enable-ldp ipv4	Enable ldp on the interface
P3(config-if)#label-switching	Enable label switching on the interface
P3(config-if)#exit	Exit the interface mode
P3(config)#interface eth5	Enter interface mode
P3(config-if)#ip address 33.1.1.161/24	Configure ip address on the interface
P3(config-if)#enable-ldp ipv4	Enable ldp on the interface
P3(config-if)#label-switching	Enable label switching on the interface
P3(config-if)#exit	Exit the interface mode
P3(config)#interface eth6	Enter interface mode
P3(config-if)#ip address 32.1.1.161/24	Configure ip address on the interface
P3(config-if)#enable-ldp ipv4	Enable ldp on the interface
P3(config-if)#label-switching	Enable label switching on the interface
P3(config-if)#exit	Exit the interface mode

P3(config)#interface eth7	Enter interface mode
P3(config-if)#ip address 42.1.1.161/24	Configure ip address on the interface
P3(config-if)#enable-ldp ipv4	Enable ldp on the interface
P3(config-if)#label-switching	Enable label switching on the interface
P3(config-if)#exit	Exit the interface mode
P3(config)#router ospf 3	Configure Router ospf with instance id 3
P3(config-router)#network 26.1.1.0/24 area 0.0.0.0	Add interface into ospf instance 3 with area 0 using network command
P3(config-router)#network 28.1.1.0/24 area 0.0.0.0	Add interface into ospf instance 3 with area 0 using network command
P3(config-router)#network 32.1.1.0/24 area 0.0.0.0	Add interface into ospf instance 3 with area 0 using network command
P3(config-router)#network 33.1.1.0/24 area 0.0.0.0	Add interface into ospf instance 3 with area 0 using network command
P3(config-router)#network 42.1.1.0/24 area 0.0.0.0	Add interface into ospf instance 3 with area 0 using network command
P3(config-router)#network 50.1.1.0/24 area 0.0.0.0	Add interface into ospf instance 3 with area 0 using network command
P3(config-router)#network 60.1.1.0/24 area 0.0.0.0	Add interface into ospf instance 3 with area 0 using network command
P3(config-router)#network 6.6.6.6/32 area 0.0.0.0	Add interface loopback into ospf instance 2 with area 0 using network command
P3(config-router)#exit	Exit router ospf mode

AGN4

AGN4(config)#interface lo	Enter interface lo mode
AGN4(config-if)#ip address 13.13.13.13/32	Configure ip address for loopback interface
AGN4(config-if)#exit	Exit interface loopback mode
AGN4(config)#router ldp	Configure router ldp
AGN4(config-router)#transport-address ipv4 13.13.13.13	Configure transport address as loopback
AGN4(config)#exit	Exit the router ldp mode
AGN4(config)#interface eth6	Enter interface mode
AGN4(config-if)#ip address 32.1.1.170/24	Configure ip address on the interface
AGN4(config-if)#enable-ldp ipv4	Enable ldp on the interface
AGN4(config-if)#label-switching	Enable label-switching on the interface
AGN4(config-if)#exit	Exit the interface mode
AGN4(config)#router ospf 3	Configure router ospf instance 3
AGN4(config-router)#network 13.13.13.13/32 area 0	Add the loopback network into ospf instance 3
AGN4(config-router)#network 32.1.1.0/24 area 0	Add the ip address into ospf instance 3
AGN4(config-router)#exit	Exit router ospf mode
AGN4(config)#router bgp 100	Enter router bgp mode

BGP IPv4 Additional Paths Configuration

AGN4 (config-router) #network 13.13.13.13/32	Advertise loopback through network command inside bgp
AGN4 (config-router) #neighbor 5.5.5.5 remote-as 100	Configure iBGP neighbor
AGN4 (config-router) #neighbor 10.10.10.10 remote-as 100	Configure iBGP neighbor
AGN4 (config-router) #neighbor 11.11.11.11 remote-as 100	Configure iBGP neighbor
AGN4 (config-router) #neighbor 12.12.12.12 remote-as 100	Configure iBGP neighbor
AGN4 (config-router) #neighbor 5.5.5.5 update-source 13.13.13.13	Update the source for the neighbor as loopback ip
AGN4 (config-router) #neighbor 10.10.10.10 update-source 13.13.13.13	Update the source for the neighbor as loopback ip
AGN4 (config-router) #neighbor 11.11.11.11 update-source 13.13.13.13	Update the source for the neighbor as loopback ip
AGN4 (config-router) #neighbor 12.12.12.12 update-source 13.13.13.13	Update the source for the neighbor as loopback ip
AGN4 (config-router) #neighbor 5.5.5.5 fall- over bfd multihop	Configure bfd for all the neighbors
AGN4 (config-router) #neighbor 10.10.10.10 fall-over bfd multihop	Configure bfd for all the neighbors
AGN4 (config-router) #neighbor 11.11.11.11 fall-over bfd multihop	Configure bfd for all the neighbors
AGN4 (config-router) #neighbor 12.12.12.12 fall-over bfd multihop	Configure bfd for all the neighbors
AGN4 (config-router) #allocate-label all	Enable allocate label all command
AGN4 (config-router) #address-family ipv4 labeled-unicast	Enter ipv4 labeled-unicast address family
AGN4 (config-router-af) #neighbor 5.5.5.5 activate	Activate the neighbor under ipv4 labeled-unicast address family
AGN4 (config-router-af) #neighbor 10.10.10.10 activate	Activate the neighbor under ipv4 labeled-unicast address family
AGN4 (config-router-af) #neighbor 11.11.11.11 activate	Activate the neighbor under ipv4 labeled-unicast address family
AGN4 (config-router-af) #neighbor 12.12.12.12 activate	Activate the neighbor under ipv4 labeled-unicast address family
AGN4 (config-router-af) #bgp additional-paths receive	Enable bgp additional paths receive at global level under ipv4 labeled unicast address family
AGN4 (config-router-af) #exit	End from router bgp mode

AGN2

AGN2 (config) #interface lo	Enter interface lo mode
AGN2 (config-if) #ip address 7.7.7.7/32	Configure ip address for loopback interface
AGN2 (config-if) #exit	Exit interface loopback mode
AGN2 (config) #router ldp	Configure router ldp
AGN2 (config-router) #transport-address ipv4 7.7.7.7	Configure transport address as loopback

AGN2 (config-router) #exit	Exit router ldp mode
AGN2 (config) #interface eth2	Enter interface mode
AGN2 (config-if) #ip address 60.1.1.162/24	Configure ip address on the interface
AGN2 (config-if) #enable-ldp ipv4	Enable ldp on the interface
AGN2 (config-if) #label-switching	Enable label-switching on the interface
AGN2 (config-if) #exit	Exit the interface mode
AGN2 (config) #router ospf 3	Configure router ospf instance 3
AGN2 (config-router) #network 7.7.7.7/32 area 0	Add the loopback network into ospf instance 3
AGN2 (config-router) #network 60.1.1.0/24 area 0	Add the ip address into ospf instance 3
AGN2 (config-router) #exit	Exit router ospf mode
AGN2 (config) #router bgp 100	Enter router bgp mode
AGN2 (config-router) #network 7.7.7.7/32	Advertise loopback through network command inside bgp
AGN2 (config-router) #neighbor 5.5.5.5 remote-as 100	Configure iBGP neighbor
AGN2 (config-router) #neighbor 10.10.10.10 remote-as 100	Configure iBGP neighbor
AGN2 (config-router) #neighbor 11.11.11.11 remote-as 100	Configure iBGP neighbor
AGN2 (config-router) #neighbor 12.12.12.12 remote-as 100	Configure iBGP neighbor
AGN2 (config-router) #neighbor 5.5.5.5 update-source 7.7.7.7	Update the source for the neighbor as loopback ip
AGN2 (config-router) #neighbor 10.10.10.10 update-source 7.7.7.7	Update the source for the neighbor as loopback ip
AGN2 (config-router) #neighbor 11.11.11.11 update-source 7.7.7.7	Update the source for the neighbor as loopback ip
AGN2 (config-router) #neighbor 12.12.12.12 update-source 7.7.7.7	Update the source for the neighbor as loopback ip
AGN2 (config-router) #neighbor 5.5.5.5 fall-over bfd multihop	Configure bfd for all the neighbors
AGN2 (config-router) #neighbor 10.10.10.10 fall-over bfd multihop	Configure bfd for all the neighbors
AGN2 (config-router) #neighbor 11.11.11.11 fall-over bfd multihop	Configure bfd for all the neighbors
AGN2 (config-router) #neighbor 12.12.12.12 fall-over bfd multihop	Configure bfd for all the neighbors
AGN2 (config-router) #allocate-label all	Enable allocate label all command
AGN2 (config-router) #address-family ipv4 labeled-unicast	Enter ipv4 labeled-unicast address family
AGN2 (config-router-af) #neighbor 5.5.5.5 activate	Activate the neighbor under ipv4 labeled-unicast address family
AGN2 (config-router-af) #neighbor 10.10.10.10 activate	Activate the neighbor under ipv4 labeled-unicast address family
AGN2 (config-router-af) #neighbor 11.11.11.11 activate	Activate the neighbor under ipv4 labeled-unicast address family

BGP IPv4 Additional Paths Configuration

AGN2 (config-router-af) #neighbor 12.12.12.12 activate	Activate the neighbor under ipv4 labeled-unicast address family
AGN2 (config-router-af) #neighbor 5.5.5.5 additional-paths receive	Enable bgp additional paths receive at neighbor level under ipv4 labeled unicast address family
AGN2 (config-router-af) #neighbor 10.10.10.10 additional-paths receive	Enable bgp additional paths receive at neighbor level under ipv4 labeled unicast address family
AGN2 (config-router-af) #neighbor 11.11.11.11 additional-paths receive	Enable bgp additional paths receive at neighbor level under ipv4 labeled unicast address family
AGN2 (config-router-af) #exit-address-family	Exit BGP address-family ipv4-labeled unicast mode
AGN2 (config-router) #end	Return to configure terminal mode

AGN5

AGN5 (config) #interface lo	Enter interface lo mode
AGN5 (config-if) #ip address 15.15.15.15/32	Configure ip address for loopback interface
AGN5 (config-if) #exit	Exit interface loopback mode
AGN5 (config) #router ldp	Configure router ldp
AGN5 (config-router) #transport-address ipv4 15.15.15.15	Configure transport address as loopback
AGN5 (config-router) #exit	Exit router ldp mode
AGN5 (config) #interface eth7	Enter interface mode
AGN5 (config-if) #ip address 42.1.1.172/24	Configure ip address on the interface
AGN5 (config-if) #enable-ldp ipv4	Enable ldp on the interface
AGN5 (config-if) #label-switching	Enable label-switching on the interface
AGN5 (config-if) #exit	Exit the interface mode
AGN5 (config) #router ospf 3	Configure router ospf instance 3
AGN5 (config-router) #network 15.15.15.15/32 area 0	Add the loopback network into ospf instance 3
AGN5 (config-router) #network 42.1.1.0/24 area 0	Add the ip address into ospf instance 3
AGN5 (config-router) #exit	Exit router ospf mode
AGN5 (config) #router bgp 100	Enter router bgp mode
AGN5 (config-router) #network 15.15.15.15/32	Advertise loopback through network command inside bgp
AGN5 (config-router) #neighbor 5.5.5.5 remote-as 100	Configure iBGP neighbor
AGN5 (config-router) #neighbor 10.10.10.10 remote-as 100	Configure iBGP neighbor
AGN5 (config-router) #neighbor 11.11.11.11 remote-as 100	Configure iBGP neighbor
AGN5 (config-router) #neighbor 12.12.12.12 remote-as 100	Configure iBGP neighbor
AGN5 (config-router) #neighbor 5.5.5.5 update-source 15.15.15.15	Update the source for the neighbor as loopback ip
AGN5 (config-router) #neighbor 10.10.10.10 update-source 15.15.15.15	Update the source for the neighbor as loopback ip

AGN5 (config-router)#neighbor 11.11.11.11 update-source 15.15.15.15	Update the source for the neighbor as loopback ip
AGN5 (config-router)#neighbor 12.12.12.12 update-source 15.15.15.15	Update the source for the neighbor as loopback ip
AGN5 (config-router)#neighbor 5.5.5.5 fall- over bfd multihop	Configure bfd for all the neighbors
AGN5 (config-router)#neighbor 10.10.10.10 fall-over bfd multihop	Configure bfd for all the neighbors
AGN5 (config-router)#neighbor 11.11.11.11 fall-over bfd multihop	Configure bfd for all the neighbors
AGN5 (config-router)#neighbor 12.12.12.12 fall-over bfd multihop	Configure bfd for all the neighbors
AGN5 (config-router)#allocate-label all	Enable allocate label all command
AGN5 (config-router)#address-family ipv4 labeled-unicast	Enter ipv4 labeled-unicast address family
AGN5 (config-router-af)#neighbor 5.5.5.5 activate	Activate the neighbor under ipv4 labeled-unicast address family
AGN5 (config-router-af)#neighbor 10.10.10.10 activate	Activate the neighbor under ipv4 labeled-unicast address family
AGN5 (config-router-af)#neighbor 11.11.11.11 activate	Activate the neighbor under ipv4 labeled-unicast address family
AGN5 (config-router-af)#neighbor 12.12.12.12 activate	Activate the neighbor under ipv4 labeled-unicast address family
AGN5 (config-router-af)#exit-address-family	Exit BGP address-family ipv4-labeled unicast mode
AGN5 (config-router)#end	Return to configure terminal mode
AGN5 (config-router-af)#exit	End from router bgp mode

Validation for BGP Labeled Unicast with Additional Paths

Verify OSPF neighborhood is up with `show ip ospf neighbor`.

Verify LDP sessions are up with `show ldp session`.

Check BGPLU with Additional Paths

```
AGN3#show ip bgp labeled-unicast all
```

Status codes: s suppressed, d damped, h history, a add-path, * valid, > best, i - internal, S - stale

Network	Next Hop	In Label	Out Label
*>i 1.1.1.1/32	1.1.1.1	-	24960
* i	1.1.1.1	-	24960
* i	1.1.1.1	-	24960
*>i 7.7.7.7/32	5.5.5.5	-	24960
* i	5.5.5.5	-	24960
* i	5.5.5.5	-	24960
*>i 13.13.13.13/32	5.5.5.5	-	24962
* i	10.10.10.10	-	24961
* i	10.10.10.10	-	24961
*> 14.14.14.14/32	0.0.0.0	24960 (eth5)	-
*>i 15.15.15.15/32	5.5.5.5	-	24961

BGP IPv4 Additional Paths Configuration

```
* i          5.5.5.5          -          24961
* i          5.5.5.5          -          24961
```

AGN3#

AGN3#sh ip bgp labeled-unicast all summary

BGP router identifier 10.12.28.171, local AS number 100

BGP table version is 11

1 BGP AS-PATH entries

0 BGP community entries

Neighbor PfxRcd	V	AS	MsgRcv	MsgSen	TblVer	InQ	OutQ	Up/Down	State/
3.3.3.3 4	4	100	578	564	11	0	0	04:40:43	
8.8.8.8 4	4	100	567	564	11	0	0	04:40:43	
9.9.9.9 4	4	100	569	564	11	0	0	04:40:58	

Total number of neighbors 3

Total number of Established sessions 3

AGN3#

AGN3#sh ip bgp labeled-unicast 13.13.13.13/32

BGP routing table entry for 13.13.13.13/32

Paths: (3 available, best #1, table Default-IP-Routing-Table)

Not advertised to any peer

Local

5.5.5.5 (metric 20) from 3.3.3.3 (10.12.28.158)

Origin IGP, metric 0, localpref 100, label 24962, Out-label 24962, In-label
NA , valid, internal, best

Originator: 10.12.28.160, Cluster list: 10.12.28.158 10.12.28.160

rx path_id: 2 tx path_id: -1

Not advertised to any peer

Last update: Mon Aug 6 00:18:09 2018

Local

10.10.10.10 (metric 20) from 8.8.8.8 (10.12.28.165)

Origin IGP, metric 0, localpref 100, label 24961, Out-label 24961, In-label
NA , valid, internal

Originator: 10.12.28.167, Cluster list: 10.12.28.165 10.12.28.167

Not advertised to any peer

Last update: Mon Aug 6 00:10:39 2018

Local

10.10.10.10 (metric 20) from 9.9.9.9 (10.12.28.166)

Origin IGP, metric 0, localpref 100, label 24961, Out-label 24961, In-label
NA , valid, internal

Originator: 10.12.28.167, Cluster list: 10.12.28.166 10.12.28.167

Not advertised to any peer

Last update: Mon Aug 6 00:10:52 2018

AGN3#

```
AGN3#sh mpls ftn-table
Primary FTN entry with FEC: 1.1.1.1/32, id: 1, row status: Active
  Owner: LDP, Stale: NO, Action-type: Redirect to LSP, Exp-bits: 0x0, Incoming DSCP:
none
  Tunnel id: 0, Protected LSP id: 0, Description: N/A
  Matched bytes:0, pkts:0, TX bytes:0, Pushed pkts:0
  Primary: Cross connect ix: 9, in intf: - in label: 0 out-segment ix: 8
    Owner: LDP, Persistent: No, Admin Status: Up, Oper Status: Up
    Out-segment with ix: 8, owner: LDP, Stale: NO, out intf: eth5, out label: 24343
  Nexthop addr: 41.1.1.157 cross connect ix: 9, op code: Push

Primary FTN entry with FEC: 1.1.1.1/32, id: 15, row status: Active
  Owner: BGP, Stale: NO, Action-type: Redirect to LSP, Exp-bits: 0x0, Incoming DSCP:
none
  Tunnel id: 0, Protected LSP id: 0, Description: N/A
  Matched bytes:0, pkts:0, TX bytes:0, Pushed pkts:0
  Primary: Cross connect ix: 12, in intf: - in label: 0 out-segment ix: 11
    Owner: BGP, Persistent: No, Admin Status: Down, Oper Status: Down
    Out-segment with ix: 11, owner: BGP, Stale: NO, out intf: eth5, out label: 24960
  Nexthop addr: 1.1.1.1 cross connect ix: 12, op code: Push

Primary FTN entry with FEC: 2.2.2.2/32, id: 2, row status: Active
  Owner: LDP, Stale: NO, Action-type: Redirect to LSP, Exp-bits: 0x0, Incoming DSCP:
none
  Tunnel id: 0, Protected LSP id: 0, Description: N/A
  Matched bytes:0, pkts:0, TX bytes:0, Pushed pkts:0
  Primary: Cross connect ix: 2, in intf: - in label: 0 out-segment ix: 1
    Owner: LDP, Persistent: No, Admin Status: Up, Oper Status: Up
    Out-segment with ix: 1, owner: LDP, Stale: NO, out intf: eth5, out label: 3
  Nexthop addr: 41.1.1.157 cross connect ix: 2, op code: Push

Primary FTN entry with FEC: 3.3.3.3/32, id: 8, row status: Active
  Owner: LDP, Stale: NO, Action-type: Redirect to LSP, Exp-bits: 0x0, Incoming DSCP:
none
  Tunnel id: 0, Protected LSP id: 0, Description: N/A
  Matched bytes:0, pkts:0, TX bytes:0, Pushed pkts:0
  Primary: Cross connect ix: 4, in intf: - in label: 0 out-segment ix: 3
    Owner: LDP, Persistent: No, Admin Status: Up, Oper Status: Up
    Out-segment with ix: 3, owner: LDP, Stale: NO, out intf: eth5, out label: 24320
  Nexthop addr: 41.1.1.157 cross connect ix: 4, op code: Push

Primary FTN entry with FEC: 5.5.5.5/32, id: 9, row status: Active
  Owner: LDP, Stale: NO, Action-type: Redirect to LSP, Exp-bits: 0x0, Incoming DSCP:
none
  Tunnel id: 0, Protected LSP id: 0, Description: N/A
  Matched bytes:0, pkts:0, TX bytes:0, Pushed pkts:0
```

BGP IPv4 Additional Paths Configuration

Primary: Cross connect ix: 5, in intf: - in label: 0 out-segment ix: 4
Owner: LDP, Persistent: No, Admin Status: Up, Oper Status: Up
Out-segment with ix: 4, owner: LDP, Stale: NO, out intf: eth5, out label: 24330
Nexthop addr: 41.1.1.157 cross connect ix: 5, op code: Push

Primary FTN entry with FEC: 7.7.7.7/32, id: 16, row status: Active
Owner: BGP, Stale: NO, Action-type: Redirect to LSP, Exp-bits: 0x0, Incoming DSCP:
none
Tunnel id: 0, Protected LSP id: 0, Description: N/A
Matched bytes:0, pkts:0, TX bytes:0, Pushed pkts:0
Primary: Cross connect ix: 13, in intf: - in label: 0 out-segment ix: 12
Owner: BGP, Persistent: No, Admin Status: Up, Oper Status: Up
Out-segment with ix: 12, owner: BGP, Stale: NO, out intf: eth5, out label: 24960
Nexthop addr: 5.5.5.5 cross connect ix: 13, op code: Push and Lookup

Primary FTN entry with FEC: 9.9.9.9/32, id: 3, row status: Active
Owner: LDP, Stale: NO, Action-type: Redirect to LSP, Exp-bits: 0x0, Incoming DSCP:
none
Tunnel id: 0, Protected LSP id: 0, Description: N/A
Matched bytes:0, pkts:0, TX bytes:0, Pushed pkts:0
Primary: Cross connect ix: 3, in intf: - in label: 0 out-segment ix: 2
Owner: LDP, Persistent: No, Admin Status: Up, Oper Status: Up
Out-segment with ix: 2, owner: LDP, Stale: NO, out intf: eth5, out label: 24321
Nexthop addr: 41.1.1.157 cross connect ix: 3, op code: Push

Primary FTN entry with FEC: 10.1.1.0/24, id: 4, row status: Active
Owner: LDP, Stale: NO, Action-type: Redirect to LSP, Exp-bits: 0x0, Incoming DSCP:
none
Tunnel id: 0, Protected LSP id: 0, Description: N/A
Matched bytes:0, pkts:0, TX bytes:0, Pushed pkts:0
Primary: Cross connect ix: 2, in intf: - in label: 0 out-segment ix: 1
Owner: LDP, Persistent: No, Admin Status: Up, Oper Status: Up
Out-segment with ix: 1, owner: LDP, Stale: NO, out intf: eth5, out label: 3
Nexthop addr: 41.1.1.157 cross connect ix: 2, op code: Push

Primary FTN entry with FEC: 10.10.10.10/32, id: 10, row status: Active
Owner: LDP, Stale: NO, Action-type: Redirect to LSP, Exp-bits: 0x0, Incoming DSCP:
none
Tunnel id: 0, Protected LSP id: 0, Description: N/A
Matched bytes:0, pkts:0, TX bytes:0, Pushed pkts:0
Primary: Cross connect ix: 6, in intf: - in label: 0 out-segment ix: 5
Owner: LDP, Persistent: No, Admin Status: Up, Oper Status: Up
Out-segment with ix: 5, owner: LDP, Stale: NO, out intf: eth5, out label: 24333
Nexthop addr: 41.1.1.157 cross connect ix: 6, op code: Push

Primary FTN entry with FEC: 11.11.11.11/32, id: 11, row status: Active

Owner: LDP, Stale: NO, Action-type: Redirect to LSP, Exp-bits: 0x0, Incoming DSCP: none
Tunnel id: 0, Protected LSP id: 0, Description: N/A
Matched bytes:0, pkts:0, TX bytes:0, Pushed pkts:0
Primary: Cross connect ix: 7, in intf: - in label: 0 out-segment ix: 6
Owner: LDP, Persistent: No, Admin Status: Up, Oper Status: Up
Out-segment with ix: 6, owner: LDP, Stale: NO, out intf: eth5, out label: 24336
Nexthop addr: 41.1.1.157 cross connect ix: 7, op code: Push

Primary FTN entry with FEC: 12.12.12.12/32, id: 12, row status: Active
Owner: LDP, Stale: NO, Action-type: Redirect to LSP, Exp-bits: 0x0, Incoming DSCP: none
Tunnel id: 0, Protected LSP id: 0, Description: N/A
Matched bytes:0, pkts:0, TX bytes:0, Pushed pkts:0
Primary: Cross connect ix: 8, in intf: - in label: 0 out-segment ix: 7
Owner: LDP, Persistent: No, Admin Status: Up, Oper Status: Up
Out-segment with ix: 7, owner: LDP, Stale: NO, out intf: eth5, out label: 24339
Nexthop addr: 41.1.1.157 cross connect ix: 8, op code: Push

Primary FTN entry with FEC: 13.13.13.13/32, id: 13, row status: Active
Owner: BGP, Stale: NO, Action-type: Redirect to LSP, Exp-bits: 0x0, Incoming DSCP: none
Tunnel id: 0, Protected LSP id: 0, Description: N/A
Matched bytes:0, pkts:0, TX bytes:0, Pushed pkts:0
Primary: Cross connect ix: 10, in intf: - in label: 0 out-segment ix: 9
Owner: BGP, Persistent: No, Admin Status: Up, Oper Status: Up
Out-segment with ix: 9, owner: BGP, Stale: NO, out intf: eth5, out label: 24962
Nexthop addr: 5.5.5.5 cross connect ix: 10, op code: Push and Lookup

Primary FTN entry with FEC: 15.15.15.15/32, id: 17, row status: Active
Owner: BGP, Stale: NO, Action-type: Redirect to LSP, Exp-bits: 0x0, Incoming DSCP: none
Tunnel id: 0, Protected LSP id: 0, Description: N/A
Matched bytes:0, pkts:0, TX bytes:0, Pushed pkts:0
Primary: Cross connect ix: 14, in intf: - in label: 0 out-segment ix: 13
Owner: BGP, Persistent: No, Admin Status: Up, Oper Status: Up
Out-segment with ix: 13, owner: BGP, Stale: NO, out intf: eth5, out label: 24961
Nexthop addr: 5.5.5.5 cross connect ix: 14, op code: Push and Lookup

Primary FTN entry with FEC: 20.1.1.0/24, id: 5, row status: Active
Owner: LDP, Stale: NO, Action-type: Redirect to LSP, Exp-bits: 0x0, Incoming DSCP: none
Tunnel id: 0, Protected LSP id: 0, Description: N/A
Matched bytes:0, pkts:0, TX bytes:0, Pushed pkts:0
Primary: Cross connect ix: 2, in intf: - in label: 0 out-segment ix: 1
Owner: LDP, Persistent: No, Admin Status: Up, Oper Status: Up
Out-segment with ix: 1, owner: LDP, Stale: NO, out intf: eth5, out label: 3

BGP IPv4 Additional Paths Configuration

Nexthop addr: 41.1.1.157 cross connect ix: 2, op code: Push

Primary FTN entry with FEC: 21.1.1.0/24, id: 6, row status: Active

Owner: LDP, Stale: NO, Action-type: Redirect to LSP, Exp-bits: 0x0, Incoming DSCP: none

Tunnel id: 0, Protected LSP id: 0, Description: N/A

Matched bytes:0, pkts:0, TX bytes:0, Pushed pkts:0

Primary: Cross connect ix: 2, in intf: - in label: 0 out-segment ix: 1

Owner: LDP, Persistent: No, Admin Status: Up, Oper Status: Up

Out-segment with ix: 1, owner: LDP, Stale: NO, out intf: eth5, out label: 3

Nexthop addr: 41.1.1.157 cross connect ix: 2, op code: Push

Primary FTN entry with FEC: 23.1.1.0/24, id: 7, row status: Active

Owner: LDP, Stale: NO, Action-type: Redirect to LSP, Exp-bits: 0x0, Incoming DSCP: none

Tunnel id: 0, Protected LSP id: 0, Description: N/A

Matched bytes:0, pkts:0, TX bytes:0, Pushed pkts:0

Primary: Cross connect ix: 2, in intf: - in label: 0 out-segment ix: 1

Owner: LDP, Persistent: No, Admin Status: Up, Oper Status: Up

Out-segment with ix: 1, owner: LDP, Stale: NO, out intf: eth5, out label: 3

Nexthop addr: 41.1.1.157 cross connect ix: 2, op code: Push

AGN1#sh ip bgp labeled-unicast all

Status codes: s suppressed, d damped, h history, a add-path, * valid, > best, i - internal, S - stale

Network	Next Hop	In Label	Out Label
*> 1.1.1.1/32	0.0.0.0	24960(eth1)	-
*>i 7.7.7.7/32	5.5.5.5	-	24960
* i	5.5.5.5	-	24960
* i	5.5.5.5	-	24960
* i	10.10.10.10	-	24962
* i	10.10.10.10	-	24962
* i	10.10.10.10	-	24962
* i	11.11.11.11	-	24961
* i	11.11.11.11	-	24961
* i	12.12.12.12	-	24962
*>i 13.13.13.13/32	5.5.5.5	-	24962
* i	5.5.5.5	-	24962
* i	5.5.5.5	-	24962
* i	10.10.10.10	-	24961
* i	10.10.10.10	-	24961
* i	10.10.10.10	-	24961
* i	11.11.11.11	-	24962
* i	11.11.11.11	-	24962
* i	12.12.12.12	-	24960
*>i 14.14.14.14/32	14.14.14.14	-	24960
* i	14.14.14.14	-	24960
* i	14.14.14.14	-	24960

```
*>i 15.15.15.15/32    5.5.5.5      -      24961
* i                  5.5.5.5      -      24961
* i                  5.5.5.5      -      24961
* i                  10.10.10.10  -      24960
* i                  10.10.10.10  -      24960
* i                  10.10.10.10  -      24960
* i                  11.11.11.11  -      24960
* i                  11.11.11.11  -      24960
* i                  12.12.12.12  -      24961
```

AGN1#

```
AGN1#sh ip bgp labeled-unicast all summary
BGP router identifier 10.12.28.156, local AS number 100
BGP table version is 6
1 BGP AS-PATH entries
0 BGP community entries
```

Neighbor PfxRcd	V	AS	MsgRcv	MsgSen	TblVer	InQ	OutQ	Up/Down	State/
3.3.3.3 13	4	100	577	568	6	0	0	04:42:43	
8.8.8.8 7	4	100	573	568	6	0	0	04:42:47	
9.9.9.9 10	4	100	575	568	6	0	0	04:42:36	

Total number of neighbors 3

Total number of Established sessions 3

AGN1#

```
AGN1#sh ip bgp labeled-unicast 13.13.13.13/32
BGP routing table entry for 13.13.13.13/32
Paths: (9 available, best #1, table Default-IP-Routing-Table)
```

Not advertised to any peer

Local

5.5.5.5 (metric 20) from 3.3.3.3 (10.12.28.158)

Origin IGP, metric 0, localpref 100, label 24962, Out-label 24962, In-label NA, valid, internal, best

Originator: 10.12.28.160, Cluster list: 10.12.28.158 10.12.28.160

rx path_id: 2 tx path_id: -1

Not advertised to any peer

Last update: Mon Aug 6 00:10:44 2018

Local

5.5.5.5 (metric 20) from 8.8.8.8 (10.12.28.165)

Origin IGP, metric 0, localpref 100, label 24962, Out-label 24962, In-label NA, valid, internal

Originator: 10.12.28.160, Cluster list: 10.12.28.165 10.12.28.160

rx path_id: 2 tx path_id: -1

Not advertised to any peer

Last update: Mon Aug 6 00:10:45 2018

Local

BGP IPv4 Additional Paths Configuration

5.5.5.5 (metric 20) from 9.9.9.9 (10.12.28.166)
Origin IGP, metric 0, localpref 100, label 24962, Out-label 24962, In-label
NA , valid, internal
Originator: 10.12.28.160, Cluster list: 10.12.28.166 10.12.28.160
rx path_id: 1 tx path_id: -1
Not advertised to any peer
Last update: Mon Aug 6 00:10:44 2018

Local

10.10.10.10 (metric 20) from 3.3.3.3 (10.12.28.158)
Origin IGP, metric 0, localpref 100, label 24961, Out-label 24961, In-label
NA , valid, internal
Originator: 10.12.28.167, Cluster list: 10.12.28.158 10.12.28.167
rx path_id: 1 tx path_id: -1
Not advertised to any peer
Last update: Mon Aug 6 00:10:37 2018

Local

10.10.10.10 (metric 20) from 8.8.8.8 (10.12.28.165)
Origin IGP, metric 0, localpref 100, label 24961, Out-label 24961, In-label
NA , valid, internal
Originator: 10.12.28.167, Cluster list: 10.12.28.165 10.12.28.167
rx path_id: 1 tx path_id: -1
Not advertised to any peer
Last update: Mon Aug 6 00:10:37 2018

Local

10.10.10.10 (metric 20) from 9.9.9.9 (10.12.28.166)
Origin IGP, metric 0, localpref 100, label 24961, Out-label 24961, In-label
NA , valid, internal
Originator: 10.12.28.167, Cluster list: 10.12.28.166 10.12.28.167
rx path_id: 2 tx path_id: -1
Not advertised to any peer
Last update: Mon Aug 6 00:10:51 2018

Local

11.11.11.11 (metric 20) from 3.3.3.3 (10.12.28.158)
Origin IGP, metric 0, localpref 100, label 24962, Out-label 24962, In-label
NA , valid, internal
Originator: 10.12.28.168, Cluster list: 10.12.28.158 10.12.28.168
rx path_id: 3 tx path_id: -1
Not advertised to any peer
Last update: Mon Aug 6 00:11:03 2018

Local

11.11.11.11 (metric 20) from 9.9.9.9 (10.12.28.166)
Origin IGP, metric 0, localpref 100, label 24962, Out-label 24962, In-label
NA , valid, internal
Originator: 10.12.28.168, Cluster list: 10.12.28.166 10.12.28.168
rx path_id: 3 tx path_id: -1
Not advertised to any peer
Last update: Mon Aug 6 00:11:03 2018

```
Local
 12.12.12.12 (metric 20) from 3.3.3.3 (10.12.28.158)
  Origin IGP, metric 0, localpref 100, label 24960, Out-label 24960, In-label
NA , valid, internal
  Originator: 10.12.28.169, Cluster list: 10.12.28.158 10.12.28.169
  rx path_id: 0 tx path_id: -1
  Not advertised to any peer
  Last update: Mon Aug 6 00:10:33 2018

AGN1#sh mpls ftn-table
 Primary FTN entry with FEC: 2.2.2.2/32, id: 1, row status: Active
  Owner: LDP, Stale: NO, Action-type: Redirect to LSP, Exp-bits: 0x0, Incoming DSCP:
none
  Tunnel id: 0, Protected LSP id: 0, Description: N/A
  Matched bytes:0, pkts:0, TX bytes:0, Pushed pkts:0
  Primary: Cross connect ix: 2, in intf: - in label: 0 out-segment ix: 1
  Owner: LDP, Persistent: No, Admin Status: Up, Oper Status: Up
  Out-segment with ix: 1, owner: LDP, Stale: NO, out intf: eth1, out label: 3
  Nexthop addr: 10.1.1.157 cross connect ix: 2, op code: Push

 Primary FTN entry with FEC: 3.3.3.3/32, id: 2, row status: Active
  Owner: LDP, Stale: NO, Action-type: Redirect to LSP, Exp-bits: 0x0, Incoming DSCP:
none
  Tunnel id: 0, Protected LSP id: 0, Description: N/A
  Matched bytes:0, pkts:0, TX bytes:0, Pushed pkts:0
  Primary: Cross connect ix: 3, in intf: - in label: 0 out-segment ix: 2
  Owner: LDP, Persistent: No, Admin Status: Up, Oper Status: Up
  Out-segment with ix: 2, owner: LDP, Stale: NO, out intf: eth1, out label: 24320
  Nexthop addr: 10.1.1.157 cross connect ix: 3, op code: Push

 Primary FTN entry with FEC: 5.5.5.5/32, id: 3, row status: Active
  Owner: LDP, Stale: NO, Action-type: Redirect to LSP, Exp-bits: 0x0, Incoming DSCP:
none
  Tunnel id: 0, Protected LSP id: 0, Description: N/A
  Matched bytes:0, pkts:0, TX bytes:0, Pushed pkts:0
  Primary: Cross connect ix: 4, in intf: - in label: 0 out-segment ix: 3
  Owner: LDP, Persistent: No, Admin Status: Up, Oper Status: Up
  Out-segment with ix: 3, owner: LDP, Stale: NO, out intf: eth1, out label: 24328
  Nexthop addr: 10.1.1.157 cross connect ix: 4, op code: Push

 Primary FTN entry with FEC: 7.7.7.7/32, id: 17, row status: Active
  Owner: BGP, Stale: NO, Action-type: Redirect to LSP, Exp-bits: 0x0, Incoming DSCP:
none
  Tunnel id: 0, Protected LSP id: 0, Description: N/A
  Matched bytes:0, pkts:0, TX bytes:0, Pushed pkts:0
  Primary: Cross connect ix: 12, in intf: - in label: 0 out-segment ix: 11
  Owner: BGP, Persistent: No, Admin Status: Up, Oper Status: Up
```

BGP IPv4 Additional Paths Configuration

Out-segment with ix: 11, owner: BGP, Stale: NO, out intf: eth1, out label: 24960
Nexthop addr: 5.5.5.5 cross connect ix: 12, op code: Push and Lookup

Primary FTN entry with FEC: 8.8.8.8/32, id: 4, row status: Active
Owner: LDP, Stale: NO, Action-type: Redirect to LSP, Exp-bits: 0x0, Incoming DSCP:
none
Tunnel id: 0, Protected LSP id: 0, Description: N/A
 Matched bytes:0, pkts:0, TX bytes:0, Pushed pkts:0
Primary: Cross connect ix: 5, in intf: - in label: 0 out-segment ix: 4
 Owner: LDP, Persistent: No, Admin Status: Up, Oper Status: Up
 Out-segment with ix: 4, owner: LDP, Stale: NO, out intf: eth1, out label: 24325
 Nexthop addr: 10.1.1.157 cross connect ix: 5, op code: Push

Primary FTN entry with FEC: 9.9.9.9/32, id: 5, row status: Active
Owner: LDP, Stale: NO, Action-type: Redirect to LSP, Exp-bits: 0x0, Incoming DSCP:
none
Tunnel id: 0, Protected LSP id: 0, Description: N/A
 Matched bytes:0, pkts:0, TX bytes:0, Pushed pkts:0
Primary: Cross connect ix: 6, in intf: - in label: 0 out-segment ix: 5
 Owner: LDP, Persistent: No, Admin Status: Up, Oper Status: Up
 Out-segment with ix: 5, owner: LDP, Stale: NO, out intf: eth1, out label: 24321
 Nexthop addr: 10.1.1.157 cross connect ix: 6, op code: Push

Primary FTN entry with FEC: 10.10.10.10/32, id: 6, row status: Active
Owner: LDP, Stale: NO, Action-type: Redirect to LSP, Exp-bits: 0x0, Incoming DSCP:
none
Tunnel id: 0, Protected LSP id: 0, Description: N/A
 Matched bytes:0, pkts:0, TX bytes:0, Pushed pkts:0
Primary: Cross connect ix: 7, in intf: - in label: 0 out-segment ix: 6
 Owner: LDP, Persistent: No, Admin Status: Up, Oper Status: Up
 Out-segment with ix: 6, owner: LDP, Stale: NO, out intf: eth1, out label: 24331
 Nexthop addr: 10.1.1.157 cross connect ix: 7, op code: Push

Primary FTN entry with FEC: 11.11.11.11/32, id: 7, row status: Active
Owner: LDP, Stale: NO, Action-type: Redirect to LSP, Exp-bits: 0x0, Incoming DSCP:
none
Tunnel id: 0, Protected LSP id: 0, Description: N/A
 Matched bytes:0, pkts:0, TX bytes:0, Pushed pkts:0
Primary: Cross connect ix: 8, in intf: - in label: 0 out-segment ix: 7
 Owner: LDP, Persistent: No, Admin Status: Up, Oper Status: Up
 Out-segment with ix: 7, owner: LDP, Stale: NO, out intf: eth1, out label: 24334
 Nexthop addr: 10.1.1.157 cross connect ix: 8, op code: Push

Primary FTN entry with FEC: 12.12.12.12/32, id: 8, row status: Active
Owner: LDP, Stale: NO, Action-type: Redirect to LSP, Exp-bits: 0x0, Incoming DSCP:
none

Tunnel id: 0, Protected LSP id: 0, Description: N/A
Matched bytes:0, pkts:0, TX bytes:0, Pushed pkts:0
Primary: Cross connect ix: 9, in intf: - in label: 0 out-segment ix: 8
Owner: LDP, Persistent: No, Admin Status: Up, Oper Status: Up
Out-segment with ix: 8, owner: LDP, Stale: NO, out intf: eth1, out label: 24337
Nexthop addr: 10.1.1.157 cross connect ix: 9, op code: Push

Primary FTN entry with FEC: 13.13.13.13/32, id: 21, row status: Active
Owner: BGP, Stale: NO, Action-type: Redirect to LSP, Exp-bits: 0x0, Incoming DSCP:
none

Tunnel id: 0, Protected LSP id: 0, Description: N/A
Matched bytes:0, pkts:0, TX bytes:0, Pushed pkts:0
Primary: Cross connect ix: 15, in intf: - in label: 0 out-segment ix: 14
Owner: BGP, Persistent: No, Admin Status: Up, Oper Status: Up
Out-segment with ix: 14, owner: BGP, Stale: NO, out intf: eth1, out label: 24962
Nexthop addr: 5.5.5.5 cross connect ix: 15, op code: Push and Lookup

Primary FTN entry with FEC: 14.14.14.14/32, id: 9, row status: Active
Owner: LDP, Stale: NO, Action-type: Redirect to LSP, Exp-bits: 0x0, Incoming DSCP:
none

Tunnel id: 0, Protected LSP id: 0, Description: N/A
Matched bytes:0, pkts:0, TX bytes:0, Pushed pkts:0
Primary: Cross connect ix: 10, in intf: - in label: 0 out-segment ix: 9
Owner: LDP, Persistent: No, Admin Status: Up, Oper Status: Up
Out-segment with ix: 9, owner: LDP, Stale: NO, out intf: eth1, out label: 24322
Nexthop addr: 10.1.1.157 cross connect ix: 10, op code: Push

Primary FTN entry with FEC: 14.14.14.14/32, id: 20, row status: Active
Owner: BGP, Stale: NO, Action-type: Redirect to LSP, Exp-bits: 0x0, Incoming DSCP:
none

Tunnel id: 0, Protected LSP id: 0, Description: N/A
Matched bytes:0, pkts:0, TX bytes:0, Pushed pkts:0
Primary: Cross connect ix: 14, in intf: - in label: 0 out-segment ix: 13
Owner: BGP, Persistent: No, Admin Status: Down, Oper Status: Down
Out-segment with ix: 13, owner: BGP, Stale: NO, out intf: eth1, out label: 24960
Nexthop addr: 14.14.14.14 cross connect ix: 14, op code: Push

Primary FTN entry with FEC: 15.15.15.15/32, id: 18, row status: Active
Owner: BGP, Stale: NO, Action-type: Redirect to LSP, Exp-bits: 0x0, Incoming DSCP:
none

Tunnel id: 0, Protected LSP id: 0, Description: N/A
Matched bytes:0, pkts:0, TX bytes:0, Pushed pkts:0
Primary: Cross connect ix: 13, in intf: - in label: 0 out-segment ix: 12
Owner: BGP, Persistent: No, Admin Status: Up, Oper Status: Up
Out-segment with ix: 12, owner: BGP, Stale: NO, out intf: eth1, out label: 24961
Nexthop addr: 5.5.5.5 cross connect ix: 13, op code: Push and Lookup

BGP IPv4 Additional Paths Configuration

Primary FTN entry with FEC: 20.1.1.0/24, id: 10, row status: Active
Owner: LDP, Stale: NO, Action-type: Redirect to LSP, Exp-bits: 0x0, Incoming DSCP:
none

Tunnel id: 0, Protected LSP id: 0, Description: N/A

Matched bytes:0, pkts:0, TX bytes:0, Pushed pkts:0

Primary: Cross connect ix: 2, in intf: - in label: 0 out-segment ix: 1

Owner: LDP, Persistent: No, Admin Status: Up, Oper Status: Up

Out-segment with ix: 1, owner: LDP, Stale: NO, out intf: eth1, out label: 3

Nexthop addr: 10.1.1.157 cross connect ix: 2, op code: Push

Primary FTN entry with FEC: 21.1.1.0/24, id: 11, row status: Active
Owner: LDP, Stale: NO, Action-type: Redirect to LSP, Exp-bits: 0x0, Incoming DSCP:
none

Tunnel id: 0, Protected LSP id: 0, Description: N/A

Matched bytes:0, pkts:0, TX bytes:0, Pushed pkts:0

Primary: Cross connect ix: 2, in intf: - in label: 0 out-segment ix: 1

Owner: LDP, Persistent: No, Admin Status: Up, Oper Status: Up

Out-segment with ix: 1, owner: LDP, Stale: NO, out intf: eth1, out label: 3

Nexthop addr: 10.1.1.157 cross connect ix: 2, op code: Push

Primary FTN entry with FEC: 23.1.1.0/24, id: 12, row status: Active
Owner: LDP, Stale: NO, Action-type: Redirect to LSP, Exp-bits: 0x0, Incoming DSCP:
none

Tunnel id: 0, Protected LSP id: 0, Description: N/A

Matched bytes:0, pkts:0, TX bytes:0, Pushed pkts:0

Primary: Cross connect ix: 2, in intf: - in label: 0 out-segment ix: 1

Owner: LDP, Persistent: No, Admin Status: Up, Oper Status: Up

Out-segment with ix: 1, owner: LDP, Stale: NO, out intf: eth1, out label: 3

Nexthop addr: 10.1.1.157 cross connect ix: 2, op code: Push

Primary FTN entry with FEC: 41.1.1.0/24, id: 13, row status: Active
Owner: LDP, Stale: NO, Action-type: Redirect to LSP, Exp-bits: 0x0, Incoming DSCP:
none

Tunnel id: 0, Protected LSP id: 0, Description: N/A

Matched bytes:0, pkts:0, TX bytes:0, Pushed pkts:0

Primary: Cross connect ix: 2, in intf: - in label: 0 out-segment ix: 1

Owner: LDP, Persistent: No, Admin Status: Up, Oper Status: Up

Out-segment with ix: 1, owner: LDP, Stale: NO, out intf: eth1, out label: 3

Nexthop addr: 10.1.1.157 cross connect ix: 2, op code: Push

AGN1#

BR3#show ip bgp labeled-unicast all

Status codes: s suppressed, d damped, h history, a add-path, * valid, > best, i -
internal, S - stale

Network	Next Hop	In Label	Out Label
*>i 1.1.1.1/32	1.1.1.1	24960 (eth3)	24960
*>i 7.7.7.7/32	5.5.5.5	-	24960
*ai	10.10.10.10	-	24962
* i	11.11.11.11	-	24961
* i	12.12.12.12	-	24962
*>i 13.13.13.13/32	10.10.10.10	-	24961
*ai	5.5.5.5	-	24962
* i	11.11.11.11	-	24962
* i	12.12.12.12	-	24960
*>i 14.14.14.14/32	14.14.14.14	24961 (eth3)	24960
*>i 15.15.15.15/32	5.5.5.5	-	24961
*ai	10.10.10.10	-	24960
* i	11.11.11.11	-	24960
* i	12.12.12.12	-	24961

BR3#

BR3#show ip bgp labeled-unicast 13.13.13.13/32

BGP routing table entry for 13.13.13.13/32

Paths: (4 available, best #1, table Default-IP-Routing-Table)

Advertised to non peer-group peers:

14.14.14.14

Local

10.10.10.10 (metric 12) from 10.10.10.10 (10.12.28.167)

Origin IGP, metric 0, localpref 100, label 24961, Out-label 24961, In-label

NA , valid, internal, best

Originator: 10.12.28.162, Cluster list: 10.12.28.167

rx path_id: -1 tx path_id: 1

Advertised to non peer-group peers:

1.1.1.1

Last update: Mon Aug 6 00:10:36 2018

Local

5.5.5.5 (metric 12) from 5.5.5.5 (10.12.28.160)

Origin IGP, metric 0, localpref 100, label 24962, Out-label 24962, In-label

NA , valid, internal, backup, add-path

Originator: 10.12.28.170, Cluster list: 10.12.28.160

rx path_id: -1 tx path_id: 2

Advertised to non peer-group peers:

1.1.1.1

Last update: Mon Aug 6 00:10:42 2018

Local

11.11.11.11 (metric 12) from 11.11.11.11 (10.12.28.168)

Origin IGP, metric 0, localpref 100, label 24962, Out-label 24962, In-label

NA , valid, internal

Originator: 10.12.28.170, Cluster list: 10.12.28.168

Not advertised to any peer

Last update: Mon Aug 6 00:11:00 2018

Local

12.12.12.12 (metric 12) from 12.12.12.12 (10.12.28.169)

BGP IPv4 Additional Paths Configuration

Origin IGP, metric 0, localpref 100, label 24960, Out-label 24960, In-label
NA , valid, internal
Originator: 10.12.28.170, Cluster list: 10.12.28.169
Not advertised to any peer
Last update: Mon Aug 6 00:10:29 2018

BGP PIC Enabled

BR3#show mpls ftn-table

Primary FTN entry with FEC: 1.1.1.1/32, id: 2, row status: Active
Owner: LDP, Stale: NO, Action-type: Redirect to LSP, Exp-bits: 0x0, Incoming DSCP:
none
Tunnel id: 0, Protected LSP id: 0, Description: N/A
Matched bytes:0, pkts:0, TX bytes:0, Pushed pkts:0
Primary: Cross connect ix: 14, in intf: - in label: 0 out-segment ix: 12
Owner: LDP, Persistent: No, Admin Status: Up, Oper Status: Up
Out-segment with ix: 12, owner: LDP, Stale: NO, out intf: eth4, out label: 24342
Nexthop addr: 21.1.1.157 cross connect ix: 14, op code: Push

Primary FTN entry with FEC: 1.1.1.1/32, id: 10, row status: Active
Owner: BGP, Stale: NO, Action-type: Redirect to LSP, Exp-bits: 0x0, Incoming DSCP:
none
Tunnel id: 0, Protected LSP id: 0, Description: N/A
Matched bytes:0, pkts:0, TX bytes:0, Pushed pkts:0
Primary: Cross connect ix: 5, in intf: - in label: 0 out-segment ix: 5
Owner: BGP, Persistent: No, Admin Status: Down, Oper Status: Down
Out-segment with ix: 5, owner: BGP, Stale: NO, out intf: eth4, out label: 24960
Nexthop addr: 1.1.1.1 cross connect ix: 5, op code: Push

Primary FTN entry with FEC: 2.2.2.2/32, id: 3, row status: Active
Owner: LDP, Stale: NO, Action-type: Redirect to LSP, Exp-bits: 0x0, Incoming DSCP:
none
Tunnel id: 0, Protected LSP id: 0, Description: N/A
Matched bytes:0, pkts:0, TX bytes:0, Pushed pkts:0
Primary: Cross connect ix: 2, in intf: - in label: 0 out-segment ix: 2
Owner: LDP, Persistent: No, Admin Status: Up, Oper Status: Up
Out-segment with ix: 2, owner: LDP, Stale: NO, out intf: eth4, out label: 3
Nexthop addr: 21.1.1.157 cross connect ix: 2, op code: Push

Primary FTN entry with FEC: 3.3.3.3/32, id: 4, row status: Active
Owner: LDP, Stale: NO, Action-type: Redirect to LSP, Exp-bits: 0x0, Incoming DSCP:
none
Tunnel id: 0, Protected LSP id: 0, Description: N/A
Matched bytes:0, pkts:0, TX bytes:0, Pushed pkts:0
Primary: Cross connect ix: 3, in intf: - in label: 0 out-segment ix: 3
Owner: LDP, Persistent: No, Admin Status: Up, Oper Status: Up
Out-segment with ix: 3, owner: LDP, Stale: NO, out intf: eth4, out label: 24320
Nexthop addr: 21.1.1.157 cross connect ix: 3, op code: Push

Primary FTN entry with FEC: 4.4.4.4/32, id: 12, row status: Active
Owner: LDP, Stale: NO, Action-type: Redirect to LSP, Exp-bits: 0x0, Incoming DSCP:
none
Tunnel id: 0, Protected LSP id: 0, Description: N/A
Matched bytes:0, pkts:0, TX bytes:0, Pushed pkts:0
Primary: Cross connect ix: 7, in intf: - in label: 0 out-segment ix: 7
Owner: LDP, Persistent: No, Admin Status: Up, Oper Status: Up
Out-segment with ix: 7, owner: LDP, Stale: NO, out intf: eth3, out label: 3
Nexthop addr: 22.1.1.159 cross connect ix: 7, op code: Push

Primary FTN entry with FEC: 5.5.5.5/32, id: 13, row status: Active
Owner: LDP, Stale: NO, Action-type: Redirect to LSP, Exp-bits: 0x0, Incoming DSCP:
none
Tunnel id: 0, Protected LSP id: 0, Description: N/A
Matched bytes:0, pkts:0, TX bytes:0, Pushed pkts:0
Primary: Cross connect ix: 8, in intf: - in label: 0 out-segment ix: 8
Owner: LDP, Persistent: No, Admin Status: Up, Oper Status: Up
Out-segment with ix: 8, owner: LDP, Stale: NO, out intf: eth3, out label: 24324
Nexthop addr: 22.1.1.159 cross connect ix: 8, op code: Push

Primary FTN entry with FEC: 7.7.7.7/32, id: 24, row status: Active
Owner: BGP, Stale: NO, Action-type: Redirect to LSP, Exp-bits: 0x0, Incoming DSCP:
none
Tunnel id: 0, Protected LSP id: 0, Description: N/A
Matched bytes:0, pkts:0, TX bytes:0, Pushed pkts:0
Primary: Cross connect ix: 16, in intf: - in label: 0 out-segment ix: 14
Owner: BGP, Persistent: No, Admin Status: Up, Oper Status: Up
Out-segment with ix: 14, owner: BGP, Stale: NO, out intf: eth3, out label: 24960
Nexthop addr: 5.5.5.5 cross connect ix: 16, op code: Push and Lookup

Non-primary FTN entry with FEC: 7.7.7.7/32, id: 26, row status: Active
Owner: BGP, Stale: NO, Action-type: Redirect to LSP, Exp-bits: 0x0, Incoming DSCP:
none
Tunnel id: 0, Protected LSP id: 0, Description: N/A
Matched bytes:0, pkts:0, TX bytes:0, Pushed pkts:0
Primary: Cross connect ix: 18, in intf: - in label: 0 out-segment ix: 16
Owner: BGP, Persistent: No, Admin Status: Up, Oper Status: Up
Out-segment with ix: 16, owner: BGP, Stale: NO, out intf: eth3, out label: 24962
Nexthop addr: 10.10.10.10 cross connect ix: 18, op code: Push and Lookup

Primary FTN entry with FEC: 9.9.9.9/32, id: 5, row status: Active
Owner: LDP, Stale: NO, Action-type: Redirect to LSP, Exp-bits: 0x0, Incoming DSCP:
none
Tunnel id: 0, Protected LSP id: 0, Description: N/A
Matched bytes:0, pkts:0, TX bytes:0, Pushed pkts:0

BGP IPv4 Additional Paths Configuration

Primary: Cross connect ix: 4, in intf: - in label: 0 out-segment ix: 4
Owner: LDP, Persistent: No, Admin Status: Up, Oper Status: Up
Out-segment with ix: 4, owner: LDP, Stale: NO, out intf: eth4, out label: 24321
Nexthop addr: 21.1.1.157 cross connect ix: 4, op code: Push

Primary FTN entry with FEC: 10.1.1.0/24, id: 6, row status: Active
Owner: LDP, Stale: NO, Action-type: Redirect to LSP, Exp-bits: 0x0, Incoming DSCP:
none

Tunnel id: 0, Protected LSP id: 0, Description: N/A
Matched bytes:0, pkts:0, TX bytes:0, Pushed pkts:0
Primary: Cross connect ix: 2, in intf: - in label: 0 out-segment ix: 2
Owner: LDP, Persistent: No, Admin Status: Up, Oper Status: Up
Out-segment with ix: 2, owner: LDP, Stale: NO, out intf: eth4, out label: 3
Nexthop addr: 21.1.1.157 cross connect ix: 2, op code: Push

Primary FTN entry with FEC: 10.10.10.10/32, id: 11, row status: Active
Owner: LDP, Stale: NO, Action-type: Redirect to LSP, Exp-bits: 0x0, Incoming DSCP:
none

Tunnel id: 0, Protected LSP id: 0, Description: N/A
Matched bytes:0, pkts:0, TX bytes:0, Pushed pkts:0
Primary: Cross connect ix: 6, in intf: - in label: 0 out-segment ix: 6
Owner: LDP, Persistent: No, Admin Status: Up, Oper Status: Up
Out-segment with ix: 6, owner: LDP, Stale: NO, out intf: eth3, out label: 24329
Nexthop addr: 22.1.1.159 cross connect ix: 6, op code: Push

Primary FTN entry with FEC: 11.11.11.11/32, id: 14, row status: Active
Owner: LDP, Stale: NO, Action-type: Redirect to LSP, Exp-bits: 0x0, Incoming DSCP:
none

Tunnel id: 0, Protected LSP id: 0, Description: N/A
Matched bytes:0, pkts:0, TX bytes:0, Pushed pkts:0
Primary: Cross connect ix: 11, in intf: - in label: 0 out-segment ix: 10
Owner: LDP, Persistent: No, Admin Status: Up, Oper Status: Up
Out-segment with ix: 10, owner: LDP, Stale: NO, out intf: eth3, out label: 24339
Nexthop addr: 22.1.1.159 cross connect ix: 11, op code: Push

Primary FTN entry with FEC: 12.12.12.12/32, id: 15, row status: Active
Owner: LDP, Stale: NO, Action-type: Redirect to LSP, Exp-bits: 0x0, Incoming DSCP:
none

Tunnel id: 0, Protected LSP id: 0, Description: N/A
Matched bytes:0, pkts:0, TX bytes:0, Pushed pkts:0
Primary: Cross connect ix: 9, in intf: - in label: 0 out-segment ix: 9
Owner: LDP, Persistent: No, Admin Status: Up, Oper Status: Up
Out-segment with ix: 9, owner: LDP, Stale: NO, out intf: eth3, out label: 24321
Nexthop addr: 22.1.1.159 cross connect ix: 9, op code: Push

Primary FTN entry with FEC: 13.13.13.13/32, id: 22, row status: Active

Owner: BGP, Stale: NO, Action-type: Redirect to LSP, Exp-bits: 0x0, Incoming DSCP: none
Tunnel id: 0, Protected LSP id: 0, Description: N/A
Matched bytes:0, pkts:0, TX bytes:0, Pushed pkts:0
Primary: Cross connect ix: 12, in intf: - in label: 0 out-segment ix: 11
Owner: BGP, Persistent: No, Admin Status: Up, Oper Status: Up
Out-segment with ix: 11, owner: BGP, Stale: NO, out intf: eth3, out label: 24961
Nexthop addr: 10.10.10.10 cross connect ix: 12, op code: Push and Lookup

Non-primary FTN entry with FEC: 13.13.13.13/32, id: 28, row status: Active
Owner: BGP, Stale: NO, Action-type: Redirect to LSP, Exp-bits: 0x0, Incoming DSCP: none
Tunnel id: 0, Protected LSP id: 0, Description: N/A
Matched bytes:0, pkts:0, TX bytes:0, Pushed pkts:0
Primary: Cross connect ix: 20, in intf: - in label: 0 out-segment ix: 18
Owner: BGP, Persistent: No, Admin Status: Up, Oper Status: Up
Out-segment with ix: 18, owner: BGP, Stale: NO, out intf: eth3, out label: 24962
Nexthop addr: 5.5.5.5 cross connect ix: 20, op code: Push and Lookup

Primary FTN entry with FEC: 14.14.14.14/32, id: 1, row status: Active
Owner: LDP, Stale: NO, Action-type: Redirect to LSP, Exp-bits: 0x0, Incoming DSCP: none
Tunnel id: 0, Protected LSP id: 0, Description: N/A
Matched bytes:0, pkts:0, TX bytes:0, Pushed pkts:0
Primary: Cross connect ix: 1, in intf: - in label: 0 out-segment ix: 1
Owner: LDP, Persistent: No, Admin Status: Up, Oper Status: Up
Out-segment with ix: 1, owner: LDP, Stale: NO, out intf: eth4, out label: 24324
Nexthop addr: 21.1.1.157 cross connect ix: 1, op code: Push

Primary FTN entry with FEC: 14.14.14.14/32, id: 27, row status: Active
Owner: BGP, Stale: NO, Action-type: Redirect to LSP, Exp-bits: 0x0, Incoming DSCP: none
Tunnel id: 0, Protected LSP id: 0, Description: N/A
Matched bytes:0, pkts:0, TX bytes:0, Pushed pkts:0
Primary: Cross connect ix: 19, in intf: - in label: 0 out-segment ix: 17
Owner: BGP, Persistent: No, Admin Status: Down, Oper Status: Down
Out-segment with ix: 17, owner: BGP, Stale: NO, out intf: eth4, out label: 24960
Nexthop addr: 14.14.14.14 cross connect ix: 19, op code: Push

Primary FTN entry with FEC: 15.15.15.15/32, id: 23, row status: Active
Owner: BGP, Stale: NO, Action-type: Redirect to LSP, Exp-bits: 0x0, Incoming DSCP: none
Tunnel id: 0, Protected LSP id: 0, Description: N/A
Matched bytes:0, pkts:0, TX bytes:0, Pushed pkts:0
Primary: Cross connect ix: 15, in intf: - in label: 0 out-segment ix: 13
Owner: BGP, Persistent: No, Admin Status: Up, Oper Status: Up
Out-segment with ix: 13, owner: BGP, Stale: NO, out intf: eth3, out label: 24961

BGP IPv4 Additional Paths Configuration

Next hop addr: 5.5.5.5 cross connect ix: 15, op code: Push and Lookup

Non-primary FTN entry with FEC: 15.15.15.15/32, id: 25, row status: Active
Owner: BGP, Stale: NO, Action-type: Redirect to LSP, Exp-bits: 0x0, Incoming DSCP:
none
Tunnel id: 0, Protected LSP id: 0, Description: N/A
 Matched bytes:0, pkts:0, TX bytes:0, Pushed pkts:0
Primary: Cross connect ix: 17, in intf: - in label: 0 out-segment ix: 15
 Owner: BGP, Persistent: No, Admin Status: Up, Oper Status: Up
 Out-segment with ix: 15, owner: BGP, Stale: NO, out intf: eth3, out label: 24960
 Next hop addr: 10.10.10.10 cross connect ix: 17, op code: Push and Lookup

Primary FTN entry with FEC: 20.1.1.0/24, id: 7, row status: Active
Owner: LDP, Stale: NO, Action-type: Redirect to LSP, Exp-bits: 0x0, Incoming DSCP:
none
Tunnel id: 0, Protected LSP id: 0, Description: N/A
 Matched bytes:0, pkts:0, TX bytes:0, Pushed pkts:0
Primary: Cross connect ix: 2, in intf: - in label: 0 out-segment ix: 2
 Owner: LDP, Persistent: No, Admin Status: Up, Oper Status: Up
 Out-segment with ix: 2, owner: LDP, Stale: NO, out intf: eth4, out label: 3
 Next hop addr: 21.1.1.157 cross connect ix: 2, op code: Push

Primary FTN entry with FEC: 23.1.1.0/24, id: 8, row status: Active
Owner: LDP, Stale: NO, Action-type: Redirect to LSP, Exp-bits: 0x0, Incoming DSCP:
none
Tunnel id: 0, Protected LSP id: 0, Description: N/A
 Matched bytes:0, pkts:0, TX bytes:0, Pushed pkts:0
Primary: Cross connect ix: 2, in intf: - in label: 0 out-segment ix: 2
 Owner: LDP, Persistent: No, Admin Status: Up, Oper Status: Up
 Out-segment with ix: 2, owner: LDP, Stale: NO, out intf: eth4, out label: 3
 Next hop addr: 21.1.1.157 cross connect ix: 2, op code: Push

Primary FTN entry with FEC: 24.1.1.0/24, id: 16, row status: Active
Owner: LDP, Stale: NO, Action-type: Redirect to LSP, Exp-bits: 0x0, Incoming DSCP:
none
Tunnel id: 0, Protected LSP id: 0, Description: N/A
 Matched bytes:0, pkts:0, TX bytes:0, Pushed pkts:0
Primary: Cross connect ix: 7, in intf: - in label: 0 out-segment ix: 7
 Owner: LDP, Persistent: No, Admin Status: Up, Oper Status: Up
 Out-segment with ix: 7, owner: LDP, Stale: NO, out intf: eth3, out label: 3
 Next hop addr: 22.1.1.159 cross connect ix: 7, op code: Push

Primary FTN entry with FEC: 25.1.1.0/24, id: 17, row status: Active
Owner: LDP, Stale: NO, Action-type: Redirect to LSP, Exp-bits: 0x0, Incoming DSCP:
none
Tunnel id: 0, Protected LSP id: 0, Description: N/A

Matched bytes:0, pkts:0, TX bytes:0, Pushed pkts:0
Primary: Cross connect ix: 7, in intf: - in label: 0 out-segment ix: 7
Owner: LDP, Persistent: No, Admin Status: Up, Oper Status: Up
Out-segment with ix: 7, owner: LDP, Stale: NO, out intf: eth3, out label: 3
Nexthop addr: 22.1.1.159 cross connect ix: 7, op code: Push

Primary FTN entry with FEC: 27.1.1.0/24, id: 18, row status: Active
Owner: LDP, Stale: NO, Action-type: Redirect to LSP, Exp-bits: 0x0, Incoming DSCP:
none
Tunnel id: 0, Protected LSP id: 0, Description: N/A
Matched bytes:0, pkts:0, TX bytes:0, Pushed pkts:0
Primary: Cross connect ix: 7, in intf: - in label: 0 out-segment ix: 7
Owner: LDP, Persistent: No, Admin Status: Up, Oper Status: Up
Out-segment with ix: 7, owner: LDP, Stale: NO, out intf: eth3, out label: 3
Nexthop addr: 22.1.1.159 cross connect ix: 7, op code: Push

Primary FTN entry with FEC: 29.1.1.0/24, id: 19, row status: Active
Owner: LDP, Stale: NO, Action-type: Redirect to LSP, Exp-bits: 0x0, Incoming DSCP:
none
Tunnel id: 0, Protected LSP id: 0, Description: N/A
Matched bytes:0, pkts:0, TX bytes:0, Pushed pkts:0
Primary: Cross connect ix: 7, in intf: - in label: 0 out-segment ix: 7
Owner: LDP, Persistent: No, Admin Status: Up, Oper Status: Up
Out-segment with ix: 7, owner: LDP, Stale: NO, out intf: eth3, out label: 3
Nexthop addr: 22.1.1.159 cross connect ix: 7, op code: Push

Primary FTN entry with FEC: 30.1.1.0/24, id: 20, row status: Active
Owner: LDP, Stale: NO, Action-type: Redirect to LSP, Exp-bits: 0x0, Incoming DSCP:
none
Tunnel id: 0, Protected LSP id: 0, Description: N/A
Matched bytes:0, pkts:0, TX bytes:0, Pushed pkts:0
Primary: Cross connect ix: 7, in intf: - in label: 0 out-segment ix: 7
Owner: LDP, Persistent: No, Admin Status: Up, Oper Status: Up
Out-segment with ix: 7, owner: LDP, Stale: NO, out intf: eth3, out label: 3
Nexthop addr: 22.1.1.159 cross connect ix: 7, op code: Push

Primary FTN entry with FEC: 40.1.1.0/24, id: 21, row status: Active
Owner: LDP, Stale: NO, Action-type: Redirect to LSP, Exp-bits: 0x0, Incoming DSCP:
none
Tunnel id: 0, Protected LSP id: 0, Description: N/A
Matched bytes:0, pkts:0, TX bytes:0, Pushed pkts:0
Primary: Cross connect ix: 7, in intf: - in label: 0 out-segment ix: 7
Owner: LDP, Persistent: No, Admin Status: Up, Oper Status: Up
Out-segment with ix: 7, owner: LDP, Stale: NO, out intf: eth3, out label: 3
Nexthop addr: 22.1.1.159 cross connect ix: 7, op code: Push

BGP IPv4 Additional Paths Configuration

Primary FTN entry with FEC: 41.1.1.0/24, id: 9, row status: Active
Owner: LDP, Stale: NO, Action-type: Redirect to LSP, Exp-bits: 0x0, Incoming DSCP: none
Tunnel id: 0, Protected LSP id: 0, Description: N/A
Matched bytes:0, pkts:0, TX bytes:0, Pushed pkts:0
Primary: Cross connect ix: 2, in intf: - in label: 0 out-segment ix: 2
Owner: LDP, Persistent: No, Admin Status: Up, Oper Status: Up
Out-segment with ix: 2, owner: LDP, Stale: NO, out intf: eth4, out label: 3
Nexthop addr: 21.1.1.157 cross connect ix: 2, op code: Push

BR3#

BR4#show ip bgp labeled-unicast all

Status codes: s suppressed, d damped, h history, a add-path, * valid, > best, i - internal, S - stale

Network	Next Hop	In Label	Out Label
*>i 1.1.1.1/32	1.1.1.1	24961(eth4)	24960
*>i 7.7.7.7/32	5.5.5.5	-	24960
*ai	10.10.10.10	-	24962
*ai	11.11.11.11	-	24961
*ai	12.12.12.12	-	24962
*>i 13.13.13.13/32	10.10.10.10	-	24961
*ai	5.5.5.5	-	24962
*ai	11.11.11.11	-	24962
*ai	12.12.12.12	-	24960
*>i 14.14.14.14/32	14.14.14.14	24960(eth4)	24960
*>i 15.15.15.15/32	5.5.5.5	-	24961
*ai	10.10.10.10	-	24960
*ai	11.11.11.11	-	24960
*ai	12.12.12.12	-	24961

BR4#

BR4#show ip bgp labeled-unicast all summary

BGP router identifier 10.12.28.166, local AS number 100

BGP table version is 8

1 BGP AS-PATH entries

0 BGP community entries

Neighbor PfxRcd	V	AS	MsgRcv	MsgSen	TblVer	InQ	OutQ	Up/Down	State/
1.1.1.1 1	4	100	576	583	8	0	0	04:46:35	
5.5.5.5 3	4	100	577	576	8	0	0	04:46:34	
10.10.10.10 3	4	100	575	575	8	0	0	04:46:21	
11.11.11.11 3	4	100	577	576	8	0	0	04:46:31	
12.12.12.12 3	4	100	578	577	8	0	0	04:46:50	

```
14.14.14.14      4   100  576      581      8      0      0  04:46:52
1
```

Total number of neighbors 6

Total number of Established sessions 6

BR4#

BR4#show ip bgp labeled-unicast 13.13.13.13/32

BGP routing table entry for 13.13.13.13/32

Paths: (4 available, best #1, table Default-IP-Routing-Table)

Advertised to non peer-group peers:

14.14.14.14

Local

10.10.10.10 (metric 12) from 10.10.10.10 (10.12.28.167)

Origin IGP, metric 0, localpref 100, label 24961, Out-label 24961, In-label
NA , valid, internal, best

Originator: 10.12.28.162, Cluster list: 10.12.28.167

rx path_id: -1 tx path_id: 2

Advertised to non peer-group peers:

1.1.1.1

Last update: Mon Aug 6 00:10:50 2018

Local

5.5.5.5 (metric 12) from 5.5.5.5 (10.12.28.160)

Origin IGP, metric 0, localpref 100, label 24962, Out-label 24962, In-label
NA , valid, internal, backup, add-path

Originator: 10.12.28.170, Cluster list: 10.12.28.160

rx path_id: -1 tx path_id: 1

Advertised to non peer-group peers:

1.1.1.1

Last update: Mon Aug 6 00:10:40 2018

Local

11.11.11.11 (metric 12) from 11.11.11.11 (10.12.28.168)

Origin IGP, metric 0, localpref 100, label 24962, Out-label 24962, In-label
NA , valid, internal, add-path

Originator: 10.12.28.170, Cluster list: 10.12.28.168

rx path_id: -1 tx path_id: 3

Advertised to non peer-group peers:

1.1.1.1

Last update: Mon Aug 6 00:11:02 2018

Local

12.12.12.12 (metric 12) from 12.12.12.12 (10.12.28.169)

Origin IGP, metric 0, localpref 100, label 24960, Out-label 24960, In-label
NA , valid, internal, add-path

Originator: 10.12.28.170, Cluster list: 10.12.28.169

rx path_id: -1 tx path_id: 0

Not advertised to any peer

Last update: Mon Aug 6 00:10:28 2018

BGP IPv4 Additional Paths Configuration

BGP PIC Enabled
BR4#

BR1#show ip bgp labeled-unicast all

Status codes: s suppressed, d damped, h history, a add-path, * valid, > best, i - internal, S - stale

Network	Next Hop	In Label	Out Label
*>i 1.1.1.1/32	1.1.1.1	24960(eth1)	24960
*>i 7.7.7.7/32	5.5.5.5	-	24960
*ai	11.11.11.11	-	24961
*ai	12.12.12.12	-	24962
*ai	10.10.10.10	-	24962
*>i 13.13.13.13/32	5.5.5.5	-	24962
*ai	10.10.10.10	-	24961
*ai	11.11.11.11	-	24962
*ai	12.12.12.12	-	24960
*>i 14.14.14.14/32	14.14.14.14	24961(eth1)	24960
*>i 15.15.15.15/32	5.5.5.5	-	24961
*ai	12.12.12.12	-	24961
*ai	10.10.10.10	-	24960
*ai	11.11.11.11	-	24960

BR1#

BR1#show ip bgp labeled-unicast all summary

BGP router identifier 10.12.28.158, local AS number 100

BGP table version is 7

1 BGP AS-PATH entries

0 BGP community entries

Neighbor PfxRcd	V	AS	MsgRcv	MsgSen	TblVer	InQ	OutQ	Up/Down	State/
1.1.1.1 1	4	100	578	587	7	0	0	04:47:48	
5.5.5.5 3	4	100	579	579	7	0	0	04:47:46	
10.10.10.10 3	4	100	579	579	7	0	0	04:47:50	
11.11.11.11 3	4	100	580	579	7	0	0	04:47:56	
12.12.12.12 3	4	100	579	579	7	0	0	04:47:55	
14.14.14.14 1	4	100	578	592	7	0	0	04:47:43	

Total number of neighbors 6

Total number of Established sessions 6

BR1#

BR1#show ip bgp labeled-unicast 13.13.13.13/32

BGP routing table entry for 13.13.13.13/32

Paths: (4 available, best #1, table Default-IP-Routing-Table)

```
Not advertised to any peer
Local
  5.5.5.5 (metric 12) from 5.5.5.5 (10.12.28.160)
  Origin IGP, metric 0, localpref 100, label    24962, Out-label    24962, In-label
NA , valid, internal, best
  Originator: 10.12.28.170, Cluster list: 10.12.28.160
  rx path_id: -1      tx path_id: 2
  Advertised to non peer-group peers:
  1.1.1.1      14.14.14.14
  Last update: Mon Aug  6 00:10:43 2018

Local
  10.10.10.10 (metric 12) from 10.10.10.10 (10.12.28.167)
  Origin IGP, metric 0, localpref 100, label    24961, Out-label    24961, In-label
NA , valid, internal, backup, add-path
  Originator: 10.12.28.170, Cluster list: 10.12.28.167
  rx path_id: -1      tx path_id: 1
  Advertised to non peer-group peers:
  1.1.1.1
  Last update: Mon Aug  6 00:10:34 2018

Local
  11.11.11.11 (metric 12) from 11.11.11.11 (10.12.28.168)
  Origin IGP, metric 0, localpref 100, label    24962, Out-label    24962, In-label
NA , valid, internal, add-path
  Originator: 10.12.28.170, Cluster list: 10.12.28.168
  rx path_id: -1      tx path_id: 3
  Advertised to non peer-group peers:
  1.1.1.1
  Last update: Mon Aug  6 00:11:00 2018

Local
  12.12.12.12 (metric 12) from 12.12.12.12 (10.12.28.169)
  Origin IGP, metric 0, localpref 100, label    24960, Out-label    24960, In-label
NA , valid, internal, add-path
  Originator: 10.12.28.170, Cluster list: 10.12.28.169
  rx path_id: -1      tx path_id: 0
  Advertised to non peer-group peers:
  1.1.1.1
  Last update: Mon Aug  6 00:10:30 2018

BGP PIC Enabled
BR1#
BR1#show mpls ftn-table
  Primary FTN entry with FEC: 1.1.1.1/32, id: 1, row status: Active
  Owner: LDP, Stale: NO, Action-type: Redirect to LSP, Exp-bits: 0x0, Incoming DSCP:
none
  Tunnel id: 0,   Protected LSP id: 0, Description: N/A
  Matched bytes:0, pkts:0, TX bytes:0, Pushed pkts:0
  Primary:  Cross connect ix: 18, in intf: - in label: 0 out-segment ix: 13
```

BGP IPv4 Additional Paths Configuration

Owner: LDP, Persistent: No, Admin Status: Up, Oper Status: Up
Out-segment with ix: 13, owner: LDP, Stale: NO, out intf: eth2, out label: 24340
Nexthop addr: 20.1.1.157 cross connect ix: 18, op code: Push

Primary FTN entry with FEC: 1.1.1.1/32, id: 22, row status: Active
Owner: BGP, Stale: NO, Action-type: Redirect to LSP, Exp-bits: 0x0, Incoming DSCP:
none
Tunnel id: 0, Protected LSP id: 0, Description: N/A
 Matched bytes:0, pkts:0, TX bytes:0, Pushed pkts:0
Primary: Cross connect ix: 15, in intf: - in label: 0 out-segment ix: 11
 Owner: BGP, Persistent: No, Admin Status: Down, Oper Status: Down
 Out-segment with ix: 11, owner: BGP, Stale: NO, out intf: eth2, out label: 24960
 Nexthop addr: 1.1.1.1 cross connect ix: 15, op code: Push

Primary FTN entry with FEC: 2.2.2.2/32, id: 2, row status: Active
Owner: LDP, Stale: NO, Action-type: Redirect to LSP, Exp-bits: 0x0, Incoming DSCP:
none
Tunnel id: 0, Protected LSP id: 0, Description: N/A
 Matched bytes:0, pkts:0, TX bytes:0, Pushed pkts:0
Primary: Cross connect ix: 1, in intf: - in label: 0 out-segment ix: 1
 Owner: LDP, Persistent: No, Admin Status: Up, Oper Status: Up
 Out-segment with ix: 1, owner: LDP, Stale: NO, out intf: eth2, out label: 3
 Nexthop addr: 20.1.1.157 cross connect ix: 1, op code: Push

Primary FTN entry with FEC: 4.4.4.4/32, id: 10, row status: Active
Owner: LDP, Stale: NO, Action-type: Redirect to LSP, Exp-bits: 0x0, Incoming DSCP:
none
Tunnel id: 0, Protected LSP id: 0, Description: N/A
 Matched bytes:0, pkts:0, TX bytes:0, Pushed pkts:0
Primary: Cross connect ix: 5, in intf: - in label: 0 out-segment ix: 5
 Owner: LDP, Persistent: No, Admin Status: Up, Oper Status: Up
 Out-segment with ix: 5, owner: LDP, Stale: NO, out intf: eth1, out label: 3
 Nexthop addr: 30.1.1.159 cross connect ix: 5, op code: Push

Primary FTN entry with FEC: 5.5.5.5/32, id: 11, row status: Active
Owner: LDP, Stale: NO, Action-type: Redirect to LSP, Exp-bits: 0x0, Incoming DSCP:
none
Tunnel id: 0, Protected LSP id: 0, Description: N/A
 Matched bytes:0, pkts:0, TX bytes:0, Pushed pkts:0
Primary: Cross connect ix: 9, in intf: - in label: 0 out-segment ix: 7
 Owner: LDP, Persistent: No, Admin Status: Up, Oper Status: Up
 Out-segment with ix: 7, owner: LDP, Stale: NO, out intf: eth1, out label: 24324
 Nexthop addr: 30.1.1.159 cross connect ix: 9, op code: Push

Primary FTN entry with FEC: 7.7.7.7/32, id: 25, row status: Active

Owner: BGP, Stale: NO, Action-type: Redirect to LSP, Exp-bits: 0x0, Incoming DSCP: none
Tunnel id: 0, Protected LSP id: 0, Description: N/A
Matched bytes:0, pkts:0, TX bytes:0, Pushed pkts:0
Primary: Cross connect ix: 20, in intf: - in label: 0 out-segment ix: 15
Owner: BGP, Persistent: No, Admin Status: Up, Oper Status: Up
Out-segment with ix: 15, owner: BGP, Stale: NO, out intf: eth1, out label: 24960
Nexthop addr: 5.5.5.5 cross connect ix: 20, op code: Push and Lookup

Non-primary FTN entry with FEC: 7.7.7.7/32, id: 26, row status: Active
Owner: BGP, Stale: NO, Action-type: Redirect to LSP, Exp-bits: 0x0, Incoming DSCP: none
Tunnel id: 0, Protected LSP id: 0, Description: N/A
Matched bytes:0, pkts:0, TX bytes:0, Pushed pkts:0
Primary: Cross connect ix: 21, in intf: - in label: 0 out-segment ix: 16
Owner: BGP, Persistent: No, Admin Status: Up, Oper Status: Up
Out-segment with ix: 16, owner: BGP, Stale: NO, out intf: eth1, out label: 24961
Nexthop addr: 11.11.11.11 cross connect ix: 21, op code: Push and Lookup

Primary FTN entry with FEC: 8.8.8.8/32, id: 3, row status: Active
Owner: LDP, Stale: NO, Action-type: Redirect to LSP, Exp-bits: 0x0, Incoming DSCP: none
Tunnel id: 0, Protected LSP id: 0, Description: N/A
Matched bytes:0, pkts:0, TX bytes:0, Pushed pkts:0
Primary: Cross connect ix: 4, in intf: - in label: 0 out-segment ix: 4
Owner: LDP, Persistent: No, Admin Status: Up, Oper Status: Up
Out-segment with ix: 4, owner: LDP, Stale: NO, out intf: eth2, out label: 24325
Nexthop addr: 20.1.1.157 cross connect ix: 4, op code: Push

Primary FTN entry with FEC: 9.9.9.9/32, id: 4, row status: Active
Owner: LDP, Stale: NO, Action-type: Redirect to LSP, Exp-bits: 0x0, Incoming DSCP: none
Tunnel id: 0, Protected LSP id: 0, Description: N/A
Matched bytes:0, pkts:0, TX bytes:0, Pushed pkts:0
Primary: Cross connect ix: 2, in intf: - in label: 0 out-segment ix: 2
Owner: LDP, Persistent: No, Admin Status: Up, Oper Status: Up
Out-segment with ix: 2, owner: LDP, Stale: NO, out intf: eth2, out label: 24321
Nexthop addr: 20.1.1.157 cross connect ix: 2, op code: Push

Primary FTN entry with FEC: 10.1.1.0/24, id: 5, row status: Active
Owner: LDP, Stale: NO, Action-type: Redirect to LSP, Exp-bits: 0x0, Incoming DSCP: none
Tunnel id: 0, Protected LSP id: 0, Description: N/A
Matched bytes:0, pkts:0, TX bytes:0, Pushed pkts:0
Primary: Cross connect ix: 1, in intf: - in label: 0 out-segment ix: 1
Owner: LDP, Persistent: No, Admin Status: Up, Oper Status: Up
Out-segment with ix: 1, owner: LDP, Stale: NO, out intf: eth2, out label: 3

BGP IPv4 Additional Paths Configuration

Next hop addr: 20.1.1.157 cross connect ix: 1, op code: Push

Primary FTN entry with FEC: 10.10.10.10/32, id: 12, row status: Active
Owner: LDP, Stale: NO, Action-type: Redirect to LSP, Exp-bits: 0x0, Incoming DSCP:
none
Tunnel id: 0, Protected LSP id: 0, Description: N/A
 Matched bytes:0, pkts:0, TX bytes:0, Pushed pkts:0
Primary: Cross connect ix: 11, in intf: - in label: 0 out-segment ix: 8
 Owner: LDP, Persistent: No, Admin Status: Up, Oper Status: Up
 Out-segment with ix: 8, owner: LDP, Stale: NO, out intf: eth1, out label: 24327
 Next hop addr: 30.1.1.159 cross connect ix: 11, op code: Push

Primary FTN entry with FEC: 11.11.11.11/32, id: 13, row status: Active
Owner: LDP, Stale: NO, Action-type: Redirect to LSP, Exp-bits: 0x0, Incoming DSCP:
none
Tunnel id: 0, Protected LSP id: 0, Description: N/A
 Matched bytes:0, pkts:0, TX bytes:0, Pushed pkts:0
Primary: Cross connect ix: 13, in intf: - in label: 0 out-segment ix: 9
 Owner: LDP, Persistent: No, Admin Status: Up, Oper Status: Up
 Out-segment with ix: 9, owner: LDP, Stale: NO, out intf: eth1, out label: 24337
 Next hop addr: 30.1.1.159 cross connect ix: 13, op code: Push

Primary FTN entry with FEC: 12.12.12.12/32, id: 14, row status: Active
Owner: LDP, Stale: NO, Action-type: Redirect to LSP, Exp-bits: 0x0, Incoming DSCP:
none
Tunnel id: 0, Protected LSP id: 0, Description: N/A
 Matched bytes:0, pkts:0, TX bytes:0, Pushed pkts:0
Primary: Cross connect ix: 7, in intf: - in label: 0 out-segment ix: 6
 Owner: LDP, Persistent: No, Admin Status: Up, Oper Status: Up
 Out-segment with ix: 6, owner: LDP, Stale: NO, out intf: eth1, out label: 24321
 Next hop addr: 30.1.1.159 cross connect ix: 7, op code: Push

Primary FTN entry with FEC: 13.13.13.13/32, id: 24, row status: Active
Owner: BGP, Stale: NO, Action-type: Redirect to LSP, Exp-bits: 0x0, Incoming DSCP:
none
Tunnel id: 0, Protected LSP id: 0, Description: N/A
 Matched bytes:0, pkts:0, TX bytes:0, Pushed pkts:0
Primary: Cross connect ix: 19, in intf: - in label: 0 out-segment ix: 14
 Owner: BGP, Persistent: No, Admin Status: Up, Oper Status: Up
 Out-segment with ix: 14, owner: BGP, Stale: NO, out intf: eth1, out label: 24962
 Next hop addr: 5.5.5.5 cross connect ix: 19, op code: Push and Lookup

Non-primary FTN entry with FEC: 13.13.13.13/32, id: 27, row status: Active
Owner: BGP, Stale: NO, Action-type: Redirect to LSP, Exp-bits: 0x0, Incoming DSCP:
none
Tunnel id: 0, Protected LSP id: 0, Description: N/A

Matched bytes:0, pkts:0, TX bytes:0, Pushed pkts:0
Primary: Cross connect ix: 22, in intf: - in label: 0 out-segment ix: 17
Owner: BGP, Persistent: No, Admin Status: Up, Oper Status: Up
Out-segment with ix: 17, owner: BGP, Stale: NO, out intf: eth1, out label: 24961
Nexthop addr: 10.10.10.10 cross connect ix: 22, op code: Push and Lookupup

Primary FTN entry with FEC: 14.14.14.14/32, id: 6, row status: Active
Owner: LDP, Stale: NO, Action-type: Redirect to LSP, Exp-bits: 0x0, Incoming DSCP:
none
Tunnel id: 0, Protected LSP id: 0, Description: N/A
Matched bytes:0, pkts:0, TX bytes:0, Pushed pkts:0
Primary: Cross connect ix: 3, in intf: - in label: 0 out-segment ix: 3
Owner: LDP, Persistent: No, Admin Status: Up, Oper Status: Up
Out-segment with ix: 3, owner: LDP, Stale: NO, out intf: eth2, out label: 24322
Nexthop addr: 20.1.1.157 cross connect ix: 3, op code: Push

Primary FTN entry with FEC: 14.14.14.14/32, id: 28, row status: Active
Owner: BGP, Stale: NO, Action-type: Redirect to LSP, Exp-bits: 0x0, Incoming DSCP:
none
Tunnel id: 0, Protected LSP id: 0, Description: N/A
Matched bytes:0, pkts:0, TX bytes:0, Pushed pkts:0
Primary: Cross connect ix: 23, in intf: - in label: 0 out-segment ix: 18
Owner: BGP, Persistent: No, Admin Status: Down, Oper Status: Down
Out-segment with ix: 18, owner: BGP, Stale: NO, out intf: eth2, out label: 24960
Nexthop addr: 14.14.14.14 cross connect ix: 23, op code: Push

Primary FTN entry with FEC: 15.15.15.15/32, id: 21, row status: Active
Owner: BGP, Stale: NO, Action-type: Redirect to LSP, Exp-bits: 0x0, Incoming DSCP:
none
Tunnel id: 0, Protected LSP id: 0, Description: N/A
Matched bytes:0, pkts:0, TX bytes:0, Pushed pkts:0
Primary: Cross connect ix: 14, in intf: - in label: 0 out-segment ix: 10
Owner: BGP, Persistent: No, Admin Status: Up, Oper Status: Up
Out-segment with ix: 10, owner: BGP, Stale: NO, out intf: eth1, out label: 24961
Nexthop addr: 5.5.5.5 cross connect ix: 14, op code: Push and Lookupup

Non-primary FTN entry with FEC: 15.15.15.15/32, id: 23, row status: Active
Owner: BGP, Stale: NO, Action-type: Redirect to LSP, Exp-bits: 0x0, Incoming DSCP:
none
Tunnel id: 0, Protected LSP id: 0, Description: N/A
Matched bytes:0, pkts:0, TX bytes:0, Pushed pkts:0
Primary: Cross connect ix: 16, in intf: - in label: 0 out-segment ix: 12
Owner: BGP, Persistent: No, Admin Status: Up, Oper Status: Up
Out-segment with ix: 12, owner: BGP, Stale: NO, out intf: eth1, out label: 24961
Nexthop addr: 12.12.12.12 cross connect ix: 16, op code: Push and Lookupup

BGP IPv4 Additional Paths Configuration

Primary FTN entry with FEC: 21.1.1.0/24, id: 7, row status: Active
Owner: LDP, Stale: NO, Action-type: Redirect to LSP, Exp-bits: 0x0, Incoming DSCP:
none

Tunnel id: 0, Protected LSP id: 0, Description: N/A
Matched bytes:0, pkts:0, TX bytes:0, Pushed pkts:0
Primary: Cross connect ix: 1, in intf: - in label: 0 out-segment ix: 1
Owner: LDP, Persistent: No, Admin Status: Up, Oper Status: Up
Out-segment with ix: 1, owner: LDP, Stale: NO, out intf: eth2, out label: 3
Nexthop addr: 20.1.1.157 cross connect ix: 1, op code: Push

Primary FTN entry with FEC: 22.1.1.0/24, id: 15, row status: Active
Owner: LDP, Stale: NO, Action-type: Redirect to LSP, Exp-bits: 0x0, Incoming DSCP:
none

Tunnel id: 0, Protected LSP id: 0, Description: N/A
Matched bytes:0, pkts:0, TX bytes:0, Pushed pkts:0
Primary: Cross connect ix: 5, in intf: - in label: 0 out-segment ix: 5
Owner: LDP, Persistent: No, Admin Status: Up, Oper Status: Up
Out-segment with ix: 5, owner: LDP, Stale: NO, out intf: eth1, out label: 3
Nexthop addr: 30.1.1.159 cross connect ix: 5, op code: Push

Primary FTN entry with FEC: 23.1.1.0/24, id: 8, row status: Active
Owner: LDP, Stale: NO, Action-type: Redirect to LSP, Exp-bits: 0x0, Incoming DSCP:
none

Tunnel id: 0, Protected LSP id: 0, Description: N/A
Matched bytes:0, pkts:0, TX bytes:0, Pushed pkts:0
Primary: Cross connect ix: 1, in intf: - in label: 0 out-segment ix: 1
Owner: LDP, Persistent: No, Admin Status: Up, Oper Status: Up
Out-segment with ix: 1, owner: LDP, Stale: NO, out intf: eth2, out label: 3
Nexthop addr: 20.1.1.157 cross connect ix: 1, op code: Push

Primary FTN entry with FEC: 24.1.1.0/24, id: 16, row status: Active
Owner: LDP, Stale: NO, Action-type: Redirect to LSP, Exp-bits: 0x0, Incoming DSCP:
none

Tunnel id: 0, Protected LSP id: 0, Description: N/A
Matched bytes:0, pkts:0, TX bytes:0, Pushed pkts:0
Primary: Cross connect ix: 5, in intf: - in label: 0 out-segment ix: 5
Owner: LDP, Persistent: No, Admin Status: Up, Oper Status: Up
Out-segment with ix: 5, owner: LDP, Stale: NO, out intf: eth1, out label: 3
Nexthop addr: 30.1.1.159 cross connect ix: 5, op code: Push

Primary FTN entry with FEC: 25.1.1.0/24, id: 17, row status: Active
Owner: LDP, Stale: NO, Action-type: Redirect to LSP, Exp-bits: 0x0, Incoming DSCP:
none

Tunnel id: 0, Protected LSP id: 0, Description: N/A
Matched bytes:0, pkts:0, TX bytes:0, Pushed pkts:0
Primary: Cross connect ix: 5, in intf: - in label: 0 out-segment ix: 5
Owner: LDP, Persistent: No, Admin Status: Up, Oper Status: Up

Out-segment with ix: 5, owner: LDP, Stale: NO, out intf: eth1, out label: 3
Nexthop addr: 30.1.1.159 cross connect ix: 5, op code: Push

Primary FTN entry with FEC: 27.1.1.0/24, id: 18, row status: Active
Owner: LDP, Stale: NO, Action-type: Redirect to LSP, Exp-bits: 0x0, Incoming DSCP:
none
Tunnel id: 0, Protected LSP id: 0, Description: N/A
Matched bytes:0, pkts:0, TX bytes:0, Pushed pkts:0
Primary: Cross connect ix: 5, in intf: - in label: 0 out-segment ix: 5
Owner: LDP, Persistent: No, Admin Status: Up, Oper Status: Up
Out-segment with ix: 5, owner: LDP, Stale: NO, out intf: eth1, out label: 3
Nexthop addr: 30.1.1.159 cross connect ix: 5, op code: Push

Primary FTN entry with FEC: 29.1.1.0/24, id: 19, row status: Active
Owner: LDP, Stale: NO, Action-type: Redirect to LSP, Exp-bits: 0x0, Incoming DSCP:
none
Tunnel id: 0, Protected LSP id: 0, Description: N/A
Matched bytes:0, pkts:0, TX bytes:0, Pushed pkts:0
Primary: Cross connect ix: 5, in intf: - in label: 0 out-segment ix: 5
Owner: LDP, Persistent: No, Admin Status: Up, Oper Status: Up
Out-segment with ix: 5, owner: LDP, Stale: NO, out intf: eth1, out label: 3
Nexthop addr: 30.1.1.159 cross connect ix: 5, op code: Push

Primary FTN entry with FEC: 40.1.1.0/24, id: 20, row status: Active
Owner: LDP, Stale: NO, Action-type: Redirect to LSP, Exp-bits: 0x0, Incoming DSCP:
none
Tunnel id: 0, Protected LSP id: 0, Description: N/A
Matched bytes:0, pkts:0, TX bytes:0, Pushed pkts:0
Primary: Cross connect ix: 5, in intf: - in label: 0 out-segment ix: 5
Owner: LDP, Persistent: No, Admin Status: Up, Oper Status: Up
Out-segment with ix: 5, owner: LDP, Stale: NO, out intf: eth1, out label: 3
Nexthop addr: 30.1.1.159 cross connect ix: 5, op code: Push

Primary FTN entry with FEC: 41.1.1.0/24, id: 9, row status: Active
Owner: LDP, Stale: NO, Action-type: Redirect to LSP, Exp-bits: 0x0, Incoming DSCP:
none
Tunnel id: 0, Protected LSP id: 0, Description: N/A
Matched bytes:0, pkts:0, TX bytes:0, Pushed pkts:0
Primary: Cross connect ix: 1, in intf: - in label: 0 out-segment ix: 1
Owner: LDP, Persistent: No, Admin Status: Up, Oper Status: Up
Out-segment with ix: 1, owner: LDP, Stale: NO, out intf: eth2, out label: 3
Nexthop addr: 20.1.1.157 cross connect ix: 1, op code: Push

BR1#

BGP IPv4 Additional Paths Configuration

BR4#show ip bgp labeled-unicast all

Status codes: s suppressed, d damped, h history, a add-path, * valid, > best, i - internal, S - stale

Network	Next Hop	In Label	Out Label
*>i 1.1.1.1/32	1.1.1.1	24961(eth4)	24960
*>i 7.7.7.7/32	5.5.5.5	-	24960
*ai	10.10.10.10	-	24962
*ai	11.11.11.11	-	24961
*ai	12.12.12.12	-	24962
*>i 13.13.13.13/32	10.10.10.10	-	24961
*ai	5.5.5.5	-	24962
*ai	11.11.11.11	-	24962
*ai	12.12.12.12	-	24960
*>i 14.14.14.14/32	14.14.14.14	24960(eth4)	24960
*>i 15.15.15.15/32	5.5.5.5	-	24961
*ai	10.10.10.10	-	24960
*ai	11.11.11.11	-	24960
*ai	12.12.12.12	-	24961

BR4#

BR4#show ip bgp labeled-unicast all summary

BGP router identifier 10.12.28.166, local AS number 100

BGP table version is 8

1 BGP AS-PATH entries

0 BGP community entries

Neighbor PfxRcd	V	AS	MsgRcv	MsgSen	TblVer	InQ	OutQ	Up/Down	State/
1.1.1.1 1	4	100	576	583	8	0	0	04:46:35	
5.5.5.5 3	4	100	577	576	8	0	0	04:46:34	
10.10.10.10 3	4	100	575	575	8	0	0	04:46:21	
11.11.11.11 3	4	100	577	576	8	0	0	04:46:31	
12.12.12.12 3	4	100	578	577	8	0	0	04:46:50	
14.14.14.14 1	4	100	576	581	8	0	0	04:46:52	

Total number of neighbors 6

Total number of Established sessions 6

BR4#

BR4#show ip bgp labeled-unicast 13.13.13.13/32

BGP routing table entry for 13.13.13.13/32

Paths: (4 available, best #1, table Default-IP-Routing-Table)

Advertised to non peer-group peers:

14.14.14.14

Local

10.10.10.10 (metric 12) from 10.10.10.10 (10.12.28.167)

```

Origin IGP, metric 0, localpref 100, label    24961, Out-label    24961, In-label
NA , valid, internal, best
Originator: 10.12.28.162, Cluster list: 10.12.28.167
rx path_id: -1      tx path_id: 2
Advertised to non peer-group peers:
  1.1.1.1
Last update: Mon Aug  6 00:10:50 2018

```

Local

```

5.5.5.5 (metric 12) from 5.5.5.5 (10.12.28.160)
Origin IGP, metric 0, localpref 100, label    24962, Out-label    24962, In-label
NA , valid, internal, backup, add-path
Originator: 10.12.28.170, Cluster list: 10.12.28.160
rx path_id: -1      tx path_id: 1
Advertised to non peer-group peers:
  1.1.1.1
Last update: Mon Aug  6 00:10:40 2018

```

Local

```

11.11.11.11 (metric 12) from 11.11.11.11 (10.12.28.168)
Origin IGP, metric 0, localpref 100, label    24962, Out-label    24962, In-label
NA , valid, internal, add-path
Originator: 10.12.28.170, Cluster list: 10.12.28.168
rx path_id: -1      tx path_id: 3
Advertised to non peer-group peers:
  1.1.1.1
Last update: Mon Aug  6 00:11:02 2018

```

Local

```

12.12.12.12 (metric 12) from 12.12.12.12 (10.12.28.169)
Origin IGP, metric 0, localpref 100, label    24960, Out-label    24960, In-label
NA , valid, internal, add-path
Originator: 10.12.28.170, Cluster list: 10.12.28.169
rx path_id: -1      tx path_id: 0
Not advertised to any peer
Last update: Mon Aug  6 00:10:28 2018

```

BGP PIC Enabled

```
BR4#show mpls ftn-table
```

```
Primary FTN entry with FEC: 1.1.1.1/32, id: 6, row status: Active
```

```
Owner: LDP, Stale: NO, Action-type: Redirect to LSP, Exp-bits: 0x0, Incoming DSCP:
none
```

```
Tunnel id: 0, Protected LSP id: 0, Description: N/A
```

```
Matched bytes:0, pkts:0, TX bytes:0, Pushed pkts:0
```

```
Primary: Cross connect ix: 16, in intf: - in label: 0 out-segment ix: 12
```

```
Owner: LDP, Persistent: No, Admin Status: Up, Oper Status: Up
```

```
Out-segment with ix: 12, owner: LDP, Stale: NO, out intf: eth3, out label: 24341
```

```
Next hop addr: 23.1.1.157      cross connect ix: 16, op code: Push
```

BGP IPv4 Additional Paths Configuration

Primary FTN entry with FEC: 1.1.1.1/32, id: 24, row status: Active
Owner: BGP, Stale: NO, Action-type: Redirect to LSP, Exp-bits: 0x0, Incoming DSCP:
none
Tunnel id: 0, Protected LSP id: 0, Description: N/A
Matched bytes:0, pkts:0, TX bytes:0, Pushed pkts:0
Primary: Cross connect ix: 18, in intf: - in label: 0 out-segment ix: 14
Owner: BGP, Persistent: No, Admin Status: Down, Oper Status: Down
Out-segment with ix: 14, owner: BGP, Stale: NO, out intf: eth3, out label: 24960
Nexthop addr: 1.1.1.1 cross connect ix: 18, op code: Push

Primary FTN entry with FEC: 2.2.2.2/32, id: 1, row status: Active
Owner: LDP, Stale: NO, Action-type: Redirect to LSP, Exp-bits: 0x0, Incoming DSCP:
none
Tunnel id: 0, Protected LSP id: 0, Description: N/A
Matched bytes:0, pkts:0, TX bytes:0, Pushed pkts:0
Primary: Cross connect ix: 1, in intf: - in label: 0 out-segment ix: 1
Owner: LDP, Persistent: No, Admin Status: Up, Oper Status: Up
Out-segment with ix: 1, owner: LDP, Stale: NO, out intf: eth3, out label: 3
Nexthop addr: 23.1.1.157 cross connect ix: 1, op code: Push

Primary FTN entry with FEC: 3.3.3.3/32, id: 7, row status: Active
Owner: LDP, Stale: NO, Action-type: Redirect to LSP, Exp-bits: 0x0, Incoming DSCP:
none
Tunnel id: 0, Protected LSP id: 0, Description: N/A
Matched bytes:0, pkts:0, TX bytes:0, Pushed pkts:0
Primary: Cross connect ix: 2, in intf: - in label: 0 out-segment ix: 2
Owner: LDP, Persistent: No, Admin Status: Up, Oper Status: Up
Out-segment with ix: 2, owner: LDP, Stale: NO, out intf: eth3, out label: 24320
Nexthop addr: 23.1.1.157 cross connect ix: 2, op code: Push

Primary FTN entry with FEC: 4.4.4.4/32, id: 11, row status: Active
Owner: LDP, Stale: NO, Action-type: Redirect to LSP, Exp-bits: 0x0, Incoming DSCP:
none
Tunnel id: 0, Protected LSP id: 0, Description: N/A
Matched bytes:0, pkts:0, TX bytes:0, Pushed pkts:0
Primary: Cross connect ix: 6, in intf: - in label: 0 out-segment ix: 6
Owner: LDP, Persistent: No, Admin Status: Up, Oper Status: Up
Out-segment with ix: 6, owner: LDP, Stale: NO, out intf: eth4, out label: 3
Nexthop addr: 24.1.1.159 cross connect ix: 6, op code: Push

Primary FTN entry with FEC: 5.5.5.5/32, id: 12, row status: Active
Owner: LDP, Stale: NO, Action-type: Redirect to LSP, Exp-bits: 0x0, Incoming DSCP:
none
Tunnel id: 0, Protected LSP id: 0, Description: N/A
Matched bytes:0, pkts:0, TX bytes:0, Pushed pkts:0
Primary: Cross connect ix: 9, in intf: - in label: 0 out-segment ix: 8
Owner: LDP, Persistent: No, Admin Status: Up, Oper Status: Up

Out-segment with ix: 8, owner: LDP, Stale: NO, out intf: eth4, out label: 24325
Nexthop addr: 24.1.1.159 cross connect ix: 9, op code: Push

Primary FTN entry with FEC: 7.7.7.7/32, id: 25, row status: Active

Owner: BGP, Stale: NO, Action-type: Redirect to LSP, Exp-bits: 0x0, Incoming DSCP:
none

Tunnel id: 0, Protected LSP id: 0, Description: N/A

Matched bytes:0, pkts:0, TX bytes:0, Pushed pkts:0

Primary: Cross connect ix: 19, in intf: - in label: 0 out-segment ix: 15

Owner: BGP, Persistent: No, Admin Status: Up, Oper Status: Up

Out-segment with ix: 15, owner: BGP, Stale: NO, out intf: eth4, out label: 24960

Nexthop addr: 5.5.5.5 cross connect ix: 19, op code: Push and Lookup

Non-primary FTN entry with FEC: 7.7.7.7/32, id: 27, row status: Active

Owner: BGP, Stale: NO, Action-type: Redirect to LSP, Exp-bits: 0x0, Incoming DSCP:
none

Tunnel id: 0, Protected LSP id: 0, Description: N/A

Matched bytes:0, pkts:0, TX bytes:0, Pushed pkts:0

Primary: Cross connect ix: 21, in intf: - in label: 0 out-segment ix: 17

Owner: BGP, Persistent: No, Admin Status: Up, Oper Status: Up

Out-segment with ix: 17, owner: BGP, Stale: NO, out intf: eth4, out label: 24962

Nexthop addr: 10.10.10.10 cross connect ix: 21, op code: Push and Lookup

Primary FTN entry with FEC: 8.8.8.8/32, id: 8, row status: Active

Owner: LDP, Stale: NO, Action-type: Redirect to LSP, Exp-bits: 0x0, Incoming DSCP:
none

Tunnel id: 0, Protected LSP id: 0, Description: N/A

Matched bytes:0, pkts:0, TX bytes:0, Pushed pkts:0

Primary: Cross connect ix: 4, in intf: - in label: 0 out-segment ix: 4

Owner: LDP, Persistent: No, Admin Status: Up, Oper Status: Up

Out-segment with ix: 4, owner: LDP, Stale: NO, out intf: eth3, out label: 24326

Nexthop addr: 23.1.1.157 cross connect ix: 4, op code: Push

Primary FTN entry with FEC: 10.1.1.0/24, id: 2, row status: Active

Owner: LDP, Stale: NO, Action-type: Redirect to LSP, Exp-bits: 0x0, Incoming DSCP:
none

Tunnel id: 0, Protected LSP id: 0, Description: N/A

Matched bytes:0, pkts:0, TX bytes:0, Pushed pkts:0

Primary: Cross connect ix: 1, in intf: - in label: 0 out-segment ix: 1

Owner: LDP, Persistent: No, Admin Status: Up, Oper Status: Up

Out-segment with ix: 1, owner: LDP, Stale: NO, out intf: eth3, out label: 3

Nexthop addr: 23.1.1.157 cross connect ix: 1, op code: Push

Primary FTN entry with FEC: 10.10.10.10/32, id: 13, row status: Active

Owner: LDP, Stale: NO, Action-type: Redirect to LSP, Exp-bits: 0x0, Incoming DSCP:
none

BGP IPv4 Additional Paths Configuration

Tunnel id: 0, Protected LSP id: 0, Description: N/A
Matched bytes:0, pkts:0, TX bytes:0, Pushed pkts:0
Primary: Cross connect ix: 11, in intf: - in label: 0 out-segment ix: 9
Owner: LDP, Persistent: No, Admin Status: Up, Oper Status: Up
Out-segment with ix: 9, owner: LDP, Stale: NO, out intf: eth4, out label: 24330
Nexthop addr: 24.1.1.159 cross connect ix: 11, op code: Push

Primary FTN entry with FEC: 11.11.11.11/32, id: 14, row status: Active
Owner: LDP, Stale: NO, Action-type: Redirect to LSP, Exp-bits: 0x0, Incoming DSCP:
none

Tunnel id: 0, Protected LSP id: 0, Description: N/A
Matched bytes:0, pkts:0, TX bytes:0, Pushed pkts:0
Primary: Cross connect ix: 13, in intf: - in label: 0 out-segment ix: 10
Owner: LDP, Persistent: No, Admin Status: Up, Oper Status: Up
Out-segment with ix: 10, owner: LDP, Stale: NO, out intf: eth4, out label: 24340
Nexthop addr: 24.1.1.159 cross connect ix: 13, op code: Push

Primary FTN entry with FEC: 12.12.12.12/32, id: 15, row status: Active
Owner: LDP, Stale: NO, Action-type: Redirect to LSP, Exp-bits: 0x0, Incoming DSCP:
none

Tunnel id: 0, Protected LSP id: 0, Description: N/A
Matched bytes:0, pkts:0, TX bytes:0, Pushed pkts:0
Primary: Cross connect ix: 7, in intf: - in label: 0 out-segment ix: 7
Owner: LDP, Persistent: No, Admin Status: Up, Oper Status: Up
Out-segment with ix: 7, owner: LDP, Stale: NO, out intf: eth4, out label: 24321
Nexthop addr: 24.1.1.159 cross connect ix: 7, op code: Push

Primary FTN entry with FEC: 13.13.13.13/32, id: 22, row status: Active
Owner: BGP, Stale: NO, Action-type: Redirect to LSP, Exp-bits: 0x0, Incoming DSCP:
none

Tunnel id: 0, Protected LSP id: 0, Description: N/A
Matched bytes:0, pkts:0, TX bytes:0, Pushed pkts:0
Primary: Cross connect ix: 14, in intf: - in label: 0 out-segment ix: 11
Owner: BGP, Persistent: No, Admin Status: Up, Oper Status: Up
Out-segment with ix: 11, owner: BGP, Stale: NO, out intf: eth4, out label: 24961
Nexthop addr: 10.10.10.10 cross connect ix: 14, op code: Push and Lookup

Non-primary FTN entry with FEC: 13.13.13.13/32, id: 28, row status: Active
Owner: BGP, Stale: NO, Action-type: Redirect to LSP, Exp-bits: 0x0, Incoming DSCP:
none

Tunnel id: 0, Protected LSP id: 0, Description: N/A
Matched bytes:0, pkts:0, TX bytes:0, Pushed pkts:0
Primary: Cross connect ix: 22, in intf: - in label: 0 out-segment ix: 18
Owner: BGP, Persistent: No, Admin Status: Up, Oper Status: Up
Out-segment with ix: 18, owner: BGP, Stale: NO, out intf: eth4, out label: 24962
Nexthop addr: 5.5.5.5 cross connect ix: 22, op code: Push and Lookup

Primary FTN entry with FEC: 14.14.14.14/32, id: 9, row status: Active
Owner: LDP, Stale: NO, Action-type: Redirect to LSP, Exp-bits: 0x0, Incoming DSCP:
none
Tunnel id: 0, Protected LSP id: 0, Description: N/A
Matched bytes:0, pkts:0, TX bytes:0, Pushed pkts:0
Primary: Cross connect ix: 3, in intf: - in label: 0 out-segment ix: 3
Owner: LDP, Persistent: No, Admin Status: Up, Oper Status: Up
Out-segment with ix: 3, owner: LDP, Stale: NO, out intf: eth3, out label: 24323
Nexthop addr: 23.1.1.157 cross connect ix: 3, op code: Push

Primary FTN entry with FEC: 14.14.14.14/32, id: 10, row status: Active
Owner: BGP, Stale: NO, Action-type: Redirect to LSP, Exp-bits: 0x0, Incoming DSCP:
none
Tunnel id: 0, Protected LSP id: 0, Description: N/A
Matched bytes:0, pkts:0, TX bytes:0, Pushed pkts:0
Primary: Cross connect ix: 5, in intf: - in label: 0 out-segment ix: 5
Owner: BGP, Persistent: No, Admin Status: Down, Oper Status: Down
Out-segment with ix: 5, owner: BGP, Stale: NO, out intf: eth3, out label: 24960
Nexthop addr: 14.14.14.14 cross connect ix: 5, op code: Push

Primary FTN entry with FEC: 15.15.15.15/32, id: 23, row status: Active
Owner: BGP, Stale: NO, Action-type: Redirect to LSP, Exp-bits: 0x0, Incoming DSCP:
none
Tunnel id: 0, Protected LSP id: 0, Description: N/A
Matched bytes:0, pkts:0, TX bytes:0, Pushed pkts:0
Primary: Cross connect ix: 17, in intf: - in label: 0 out-segment ix: 13
Owner: BGP, Persistent: No, Admin Status: Up, Oper Status: Up
Out-segment with ix: 13, owner: BGP, Stale: NO, out intf: eth4, out label: 24961
Nexthop addr: 5.5.5.5 cross connect ix: 17, op code: Push and Lookup

Non-primary FTN entry with FEC: 15.15.15.15/32, id: 26, row status: Active
Owner: BGP, Stale: NO, Action-type: Redirect to LSP, Exp-bits: 0x0, Incoming DSCP:
none
Tunnel id: 0, Protected LSP id: 0, Description: N/A
Matched bytes:0, pkts:0, TX bytes:0, Pushed pkts:0
Primary: Cross connect ix: 20, in intf: - in label: 0 out-segment ix: 16
Owner: BGP, Persistent: No, Admin Status: Up, Oper Status: Up
Out-segment with ix: 16, owner: BGP, Stale: NO, out intf: eth4, out label: 24960
Nexthop addr: 10.10.10.10 cross connect ix: 20, op code: Push and Lookup

Primary FTN entry with FEC: 20.1.1.0/24, id: 3, row status: Active
Owner: LDP, Stale: NO, Action-type: Redirect to LSP, Exp-bits: 0x0, Incoming DSCP:
none
Tunnel id: 0, Protected LSP id: 0, Description: N/A
Matched bytes:0, pkts:0, TX bytes:0, Pushed pkts:0
Primary: Cross connect ix: 1, in intf: - in label: 0 out-segment ix: 1

BGP IPv4 Additional Paths Configuration

Owner: LDP, Persistent: No, Admin Status: Up, Oper Status: Up
Out-segment with ix: 1, owner: LDP, Stale: NO, out intf: eth3, out label: 3
Nexthop addr: 23.1.1.157 cross connect ix: 1, op code: Push

Primary FTN entry with FEC: 21.1.1.0/24, id: 4, row status: Active
Owner: LDP, Stale: NO, Action-type: Redirect to LSP, Exp-bits: 0x0, Incoming DSCP:
none

Tunnel id: 0, Protected LSP id: 0, Description: N/A
Matched bytes:0, pkts:0, TX bytes:0, Pushed pkts:0
Primary: Cross connect ix: 1, in intf: - in label: 0 out-segment ix: 1
Owner: LDP, Persistent: No, Admin Status: Up, Oper Status: Up
Out-segment with ix: 1, owner: LDP, Stale: NO, out intf: eth3, out label: 3
Nexthop addr: 23.1.1.157 cross connect ix: 1, op code: Push

Primary FTN entry with FEC: 22.1.1.0/24, id: 16, row status: Active
Owner: LDP, Stale: NO, Action-type: Redirect to LSP, Exp-bits: 0x0, Incoming DSCP:
none

Tunnel id: 0, Protected LSP id: 0, Description: N/A
Matched bytes:0, pkts:0, TX bytes:0, Pushed pkts:0
Primary: Cross connect ix: 6, in intf: - in label: 0 out-segment ix: 6
Owner: LDP, Persistent: No, Admin Status: Up, Oper Status: Up
Out-segment with ix: 6, owner: LDP, Stale: NO, out intf: eth4, out label: 3
Nexthop addr: 24.1.1.159 cross connect ix: 6, op code: Push

Primary FTN entry with FEC: 25.1.1.0/24, id: 17, row status: Active
Owner: LDP, Stale: NO, Action-type: Redirect to LSP, Exp-bits: 0x0, Incoming DSCP:
none

Tunnel id: 0, Protected LSP id: 0, Description: N/A
Matched bytes:0, pkts:0, TX bytes:0, Pushed pkts:0
Primary: Cross connect ix: 6, in intf: - in label: 0 out-segment ix: 6
Owner: LDP, Persistent: No, Admin Status: Up, Oper Status: Up
Out-segment with ix: 6, owner: LDP, Stale: NO, out intf: eth4, out label: 3
Nexthop addr: 24.1.1.159 cross connect ix: 6, op code: Push

Primary FTN entry with FEC: 27.1.1.0/24, id: 18, row status: Active
Owner: LDP, Stale: NO, Action-type: Redirect to LSP, Exp-bits: 0x0, Incoming DSCP:
none

Tunnel id: 0, Protected LSP id: 0, Description: N/A
Matched bytes:0, pkts:0, TX bytes:0, Pushed pkts:0
Primary: Cross connect ix: 6, in intf: - in label: 0 out-segment ix: 6
Owner: LDP, Persistent: No, Admin Status: Up, Oper Status: Up
Out-segment with ix: 6, owner: LDP, Stale: NO, out intf: eth4, out label: 3
Nexthop addr: 24.1.1.159 cross connect ix: 6, op code: Push

Primary FTN entry with FEC: 29.1.1.0/24, id: 19, row status: Active

Owner: LDP, Stale: NO, Action-type: Redirect to LSP, Exp-bits: 0x0, Incoming DSCP: none

Tunnel id: 0, Protected LSP id: 0, Description: N/A

Matched bytes:0, pkts:0, TX bytes:0, Pushed pkts:0

Primary: Cross connect ix: 6, in intf: - in label: 0 out-segment ix: 6

Owner: LDP, Persistent: No, Admin Status: Up, Oper Status: Up

Out-segment with ix: 6, owner: LDP, Stale: NO, out intf: eth4, out label: 3

Nexthop addr: 24.1.1.159 cross connect ix: 6, op code: Push

Primary FTN entry with FEC: 30.1.1.0/24, id: 20, row status: Active

Owner: LDP, Stale: NO, Action-type: Redirect to LSP, Exp-bits: 0x0, Incoming DSCP: none

Tunnel id: 0, Protected LSP id: 0, Description: N/A

Matched bytes:0, pkts:0, TX bytes:0, Pushed pkts:0

Primary: Cross connect ix: 6, in intf: - in label: 0 out-segment ix: 6

Owner: LDP, Persistent: No, Admin Status: Up, Oper Status: Up

Out-segment with ix: 6, owner: LDP, Stale: NO, out intf: eth4, out label: 3

Nexthop addr: 24.1.1.159 cross connect ix: 6, op code: Push

Primary FTN entry with FEC: 40.1.1.0/24, id: 21, row status: Active

Owner: LDP, Stale: NO, Action-type: Redirect to LSP, Exp-bits: 0x0, Incoming DSCP: none

Tunnel id: 0, Protected LSP id: 0, Description: N/A

Matched bytes:0, pkts:0, TX bytes:0, Pushed pkts:0

Primary: Cross connect ix: 6, in intf: - in label: 0 out-segment ix: 6

Owner: LDP, Persistent: No, Admin Status: Up, Oper Status: Up

Out-segment with ix: 6, owner: LDP, Stale: NO, out intf: eth4, out label: 3

Nexthop addr: 24.1.1.159 cross connect ix: 6, op code: Push

Primary FTN entry with FEC: 41.1.1.0/24, id: 5, row status: Active

Owner: LDP, Stale: NO, Action-type: Redirect to LSP, Exp-bits: 0x0, Incoming DSCP: none

Tunnel id: 0, Protected LSP id: 0, Description: N/A

Matched bytes:0, pkts:0, TX bytes:0, Pushed pkts:0

Primary: Cross connect ix: 1, in intf: - in label: 0 out-segment ix: 1

Owner: LDP, Persistent: No, Admin Status: Up, Oper Status: Up

Out-segment with ix: 1, owner: LDP, Stale: NO, out intf: eth3, out label: 3

Nexthop addr: 23.1.1.157 cross connect ix: 1, op code: Push

BR4#

BR5#show ip bgp labeled-unicast all

Status codes: s suppressed, d damped, h history, a add-path, * valid, > best, i - internal, S - stale

Network	Next Hop	In Label	Out Label
---------	----------	----------	-----------

BGP IPv4 Additional Paths Configuration

```
*>i 1.1.1.1/32      3.3.3.3      -      24960
*ai                8.8.8.8      -      24960
*ai                9.9.9.9      -      24961
*>i 7.7.7.7/32     7.7.7.7      24962(eth5)  24960
*>i 13.13.13.13/32 13.13.13.13  24961(eth5)  24960
*>i 14.14.14.14/32 8.8.8.8      -      24961
*ai                9.9.9.9      -      24960
*ai                3.3.3.3      -      24961
*>i 15.15.15.15/32 15.15.15.15  24960(eth5)  24960
```

BR5#

BR5#show ip bgp labeled-unicast all summary

BGP router identifier 10.12.28.167, local AS number 100

BGP table version is 5

1 BGP AS-PATH entries

0 BGP community entries

Neighbor PfxRcd	V	AS	MsgRcv	MsgSen	TblVer	InQ	OutQ	Up/Down	State/
3.3.3.3 2	4	100	587	587	5	0	0	04:51:40	
7.7.7.7 1	4	100	586	591	5	0	0	04:51:41	
8.8.8.8 2	4	100	585	585	5	0	0	04:51:30	
9.9.9.9 2	4	100	585	585	5	0	0	04:51:16	
13.13.13.13 1	4	100	586	591	5	0	0	04:51:34	
15.15.15.15 1	4	100	586	589	5	0	0	04:51:53	

Total number of neighbors 6

Total number of Established sessions 6

BR5#

BR5#show ip bgp labeled-unicast 1.1.1.1/32

BGP routing table entry for 1.1.1.1/32

Paths: (3 available, best #1, table Default-IP-Routing-Table)

Advertised to non peer-group peers:

15.15.15.15

Local

3.3.3.3 (metric 12) from 3.3.3.3 (10.12.28.158)

Origin IGP, metric 0, localpref 100, label 24960, Out-label 24960, In-label
NA , valid, internal, best

Originator: 10.12.28.156, Cluster list: 10.12.28.158

rx path_id: -1 tx path_id: 0

Advertised to non peer-group peers:

7.7.7.7 13.13.13.13

Last update: Mon Aug 6 00:10:30 2018

Local

```
8.8.8.8 (metric 12) from 8.8.8.8 (10.12.28.165)
  Origin IGP, metric 0, localpref 100, label    24960, Out-label    24960, In-label
NA , valid, internal, add-path
  Originator: 10.12.28.156, Cluster list: 10.12.28.165
  rx path_id: -1      tx path_id: 1
  Advertised to non peer-group peers:
    7.7.7.7      13.13.13.13
  Last update: Mon Aug  6 00:10:37 2018

Local
9.9.9.9 (metric 12) from 9.9.9.9 (10.12.28.166)
  Origin IGP, metric 0, localpref 100, label    24961, Out-label    24961, In-label
NA , valid, internal, add-path
  Originator: 10.12.28.156, Cluster list: 10.12.28.166
  rx path_id: -1      tx path_id: 2
  Advertised to non peer-group peers:
    7.7.7.7      13.13.13.13
  Last update: Mon Aug  6 00:10:51 2018

BR5#sh mpls ftn-table
Primary FTN entry with FEC: 1.1.1.1/32, id: 25, row status: Active
  Owner: BGP, Stale: NO, Action-type: Redirect to LSP, Exp-bits: 0x0, Incoming DSCP:
none
  Tunnel id: 0,   Protected LSP id: 0, Description: N/A
  Matched bytes:0, pkts:0, TX bytes:0, Pushed pkts:0
  Primary:  Cross connect ix: 18, in intf: - in label: 0 out-segment ix: 13
  Owner: BGP, Persistent: No, Admin Status: Up, Oper Status: Up
  Out-segment with ix: 13, owner: BGP, Stale: NO, out intf: eth5, out label: 24960
  Nexthop addr: 3.3.3.3      cross connect ix: 18, op code: Push and Lookup

Primary FTN entry with FEC: 3.3.3.3/32, id: 13, row status: Active
  Owner: LDP, Stale: NO, Action-type: Redirect to LSP, Exp-bits: 0x0, Incoming DSCP:
none
  Tunnel id: 0,   Protected LSP id: 0, Description: N/A
  Matched bytes:0, pkts:0, TX bytes:0, Pushed pkts:0
  Primary:  Cross connect ix: 4, in intf: - in label: 0 out-segment ix: 4
  Owner: LDP, Persistent: No, Admin Status: Up, Oper Status: Up
  Out-segment with ix: 4, owner: LDP, Stale: NO, out intf: eth5, out label: 24320
  Nexthop addr: 25.1.1.159   cross connect ix: 4, op code: Push

Primary FTN entry with FEC: 4.4.4.4/32, id: 15, row status: Active
  Owner: LDP, Stale: NO, Action-type: Redirect to LSP, Exp-bits: 0x0, Incoming DSCP:
none
  Tunnel id: 0,   Protected LSP id: 0, Description: N/A
  Matched bytes:0, pkts:0, TX bytes:0, Pushed pkts:0
  Primary:  Cross connect ix: 5, in intf: - in label: 0 out-segment ix: 5
  Owner: LDP, Persistent: No, Admin Status: Up, Oper Status: Up
  Out-segment with ix: 5, owner: LDP, Stale: NO, out intf: eth5, out label: 3
  Nexthop addr: 25.1.1.159   cross connect ix: 5, op code: Push
```

Primary FTN entry with FEC: 5.5.5.5/32, id: 10, row status: Active
Owner: LDP, Stale: NO, Action-type: Redirect to LSP, Exp-bits: 0x0, Incoming DSCP: none
Tunnel id: 0, Protected LSP id: 0, Description: N/A
Matched bytes:0, pkts:0, TX bytes:0, Pushed pkts:0
Primary: Cross connect ix: 13, in intf: - in label: 0 out-segment ix: 10
Owner: LDP, Persistent: No, Admin Status: Up, Oper Status: Up
Out-segment with ix: 10, owner: LDP, Stale: NO, out intf: eth3, out label: 24331
Nexthop addr: 26.1.1.161 cross connect ix: 13, op code: Push

Primary FTN entry with FEC: 6.6.6.6/32, id: 1, row status: Active
Owner: LDP, Stale: NO, Action-type: Redirect to LSP, Exp-bits: 0x0, Incoming DSCP: none
Tunnel id: 0, Protected LSP id: 0, Description: N/A
Matched bytes:0, pkts:0, TX bytes:0, Pushed pkts:0
Primary: Cross connect ix: 1, in intf: - in label: 0 out-segment ix: 1
Owner: LDP, Persistent: No, Admin Status: Up, Oper Status: Up
Out-segment with ix: 1, owner: LDP, Stale: NO, out intf: eth3, out label: 3
Nexthop addr: 26.1.1.161 cross connect ix: 1, op code: Push

Primary FTN entry with FEC: 7.7.7.7/32, id: 11, row status: Active
Owner: LDP, Stale: NO, Action-type: Redirect to LSP, Exp-bits: 0x0, Incoming DSCP: none
Tunnel id: 0, Protected LSP id: 0, Description: N/A
Matched bytes:0, pkts:0, TX bytes:0, Pushed pkts:0
Primary: Cross connect ix: 15, in intf: - in label: 0 out-segment ix: 11
Owner: LDP, Persistent: No, Admin Status: Up, Oper Status: Up
Out-segment with ix: 11, owner: LDP, Stale: NO, out intf: eth3, out label: 24335
Nexthop addr: 26.1.1.161 cross connect ix: 15, op code: Push

Primary FTN entry with FEC: 7.7.7.7/32, id: 27, row status: Active
Owner: BGP, Stale: NO, Action-type: Redirect to LSP, Exp-bits: 0x0, Incoming DSCP: none
Tunnel id: 0, Protected LSP id: 0, Description: N/A
Matched bytes:0, pkts:0, TX bytes:0, Pushed pkts:0
Primary: Cross connect ix: 20, in intf: - in label: 0 out-segment ix: 15
Owner: BGP, Persistent: No, Admin Status: Down, Oper Status: Down
Out-segment with ix: 15, owner: BGP, Stale: NO, out intf: eth3, out label: 24960
Nexthop addr: 7.7.7.7 cross connect ix: 20, op code: Push

Primary FTN entry with FEC: 8.8.8.8/32, id: 16, row status: Active
Owner: LDP, Stale: NO, Action-type: Redirect to LSP, Exp-bits: 0x0, Incoming DSCP: none
Tunnel id: 0, Protected LSP id: 0, Description: N/A
Matched bytes:0, pkts:0, TX bytes:0, Pushed pkts:0

Primary: Cross connect ix: 9, in intf: - in label: 0 out-segment ix: 8
Owner: LDP, Persistent: No, Admin Status: Up, Oper Status: Up
Out-segment with ix: 8, owner: LDP, Stale: NO, out intf: eth5, out label: 24335
Nexthop addr: 25.1.1.159 cross connect ix: 9, op code: Push

Primary FTN entry with FEC: 9.9.9.9/32, id: 17, row status: Active
Owner: LDP, Stale: NO, Action-type: Redirect to LSP, Exp-bits: 0x0, Incoming DSCP:
none
Tunnel id: 0, Protected LSP id: 0, Description: N/A
Matched bytes:0, pkts:0, TX bytes:0, Pushed pkts:0
Primary: Cross connect ix: 6, in intf: - in label: 0 out-segment ix: 6
Owner: LDP, Persistent: No, Admin Status: Up, Oper Status: Up
Out-segment with ix: 6, owner: LDP, Stale: NO, out intf: eth5, out label: 24322
Nexthop addr: 25.1.1.159 cross connect ix: 6, op code: Push

Primary FTN entry with FEC: 11.11.11.11/32, id: 18, row status: Active
Owner: LDP, Stale: NO, Action-type: Redirect to LSP, Exp-bits: 0x0, Incoming DSCP:
none
Tunnel id: 0, Protected LSP id: 0, Description: N/A
Matched bytes:0, pkts:0, TX bytes:0, Pushed pkts:0
Primary: Cross connect ix: 11, in intf: - in label: 0 out-segment ix: 9
Owner: LDP, Persistent: No, Admin Status: Up, Oper Status: Up
Out-segment with ix: 9, owner: LDP, Stale: NO, out intf: eth5, out label: 24341
Nexthop addr: 25.1.1.159 cross connect ix: 11, op code: Push

Primary FTN entry with FEC: 12.12.12.12/32, id: 2, row status: Active
Owner: LDP, Stale: NO, Action-type: Redirect to LSP, Exp-bits: 0x0, Incoming DSCP:
none
Tunnel id: 0, Protected LSP id: 0, Description: N/A
Matched bytes:0, pkts:0, TX bytes:0, Pushed pkts:0
Primary: Cross connect ix: 2, in intf: - in label: 0 out-segment ix: 2
Owner: LDP, Persistent: No, Admin Status: Up, Oper Status: Up
Out-segment with ix: 2, owner: LDP, Stale: NO, out intf: eth3, out label: 24320
Nexthop addr: 26.1.1.161 cross connect ix: 2, op code: Push

Primary FTN entry with FEC: 13.13.13.13/32, id: 12, row status: Active
Owner: LDP, Stale: NO, Action-type: Redirect to LSP, Exp-bits: 0x0, Incoming DSCP:
none
Tunnel id: 0, Protected LSP id: 0, Description: N/A
Matched bytes:0, pkts:0, TX bytes:0, Pushed pkts:0
Primary: Cross connect ix: 17, in intf: - in label: 0 out-segment ix: 12
Owner: LDP, Persistent: No, Admin Status: Up, Oper Status: Up
Out-segment with ix: 12, owner: LDP, Stale: NO, out intf: eth3, out label: 24340
Nexthop addr: 26.1.1.161 cross connect ix: 17, op code: Push

Primary FTN entry with FEC: 13.13.13.13/32, id: 26, row status: Active

BGP IPv4 Additional Paths Configuration

Owner: BGP, Stale: NO, Action-type: Redirect to LSP, Exp-bits: 0x0, Incoming DSCP: none
Tunnel id: 0, Protected LSP id: 0, Description: N/A
Matched bytes:0, pkts:0, TX bytes:0, Pushed pkts:0
Primary: Cross connect ix: 19, in intf: - in label: 0 out-segment ix: 14
Owner: BGP, Persistent: No, Admin Status: Down, Oper Status: Down
Out-segment with ix: 14, owner: BGP, Stale: NO, out intf: eth3, out label: 24960
Nexthop addr: 13.13.13.13 cross connect ix: 19, op code: Push

Primary FTN entry with FEC: 14.14.14.14/32, id: 28, row status: Active
Owner: BGP, Stale: NO, Action-type: Redirect to LSP, Exp-bits: 0x0, Incoming DSCP: none
Tunnel id: 0, Protected LSP id: 0, Description: N/A
Matched bytes:0, pkts:0, TX bytes:0, Pushed pkts:0
Primary: Cross connect ix: 21, in intf: - in label: 0 out-segment ix: 16
Owner: BGP, Persistent: No, Admin Status: Up, Oper Status: Up
Out-segment with ix: 16, owner: BGP, Stale: NO, out intf: eth5, out label: 24961
Nexthop addr: 8.8.8.8 cross connect ix: 21, op code: Push and Lookup

Primary FTN entry with FEC: 15.15.15.15/32, id: 3, row status: Active
Owner: LDP, Stale: NO, Action-type: Redirect to LSP, Exp-bits: 0x0, Incoming DSCP: none
Tunnel id: 0, Protected LSP id: 0, Description: N/A
Matched bytes:0, pkts:0, TX bytes:0, Pushed pkts:0
Primary: Cross connect ix: 3, in intf: - in label: 0 out-segment ix: 3
Owner: LDP, Persistent: No, Admin Status: Up, Oper Status: Up
Out-segment with ix: 3, owner: LDP, Stale: NO, out intf: eth3, out label: 24321
Nexthop addr: 26.1.1.161 cross connect ix: 3, op code: Push

Primary FTN entry with FEC: 15.15.15.15/32, id: 14, row status: Active
Owner: BGP, Stale: NO, Action-type: Redirect to LSP, Exp-bits: 0x0, Incoming DSCP: none
Tunnel id: 0, Protected LSP id: 0, Description: N/A
Matched bytes:0, pkts:0, TX bytes:0, Pushed pkts:0
Primary: Cross connect ix: 7, in intf: - in label: 0 out-segment ix: 7
Owner: BGP, Persistent: No, Admin Status: Down, Oper Status: Down
Out-segment with ix: 7, owner: BGP, Stale: NO, out intf: eth3, out label: 24960
Nexthop addr: 15.15.15.15 cross connect ix: 7, op code: Push

Primary FTN entry with FEC: 22.1.1.0/24, id: 19, row status: Active
Owner: LDP, Stale: NO, Action-type: Redirect to LSP, Exp-bits: 0x0, Incoming DSCP: none
Tunnel id: 0, Protected LSP id: 0, Description: N/A
Matched bytes:0, pkts:0, TX bytes:0, Pushed pkts:0
Primary: Cross connect ix: 5, in intf: - in label: 0 out-segment ix: 5
Owner: LDP, Persistent: No, Admin Status: Up, Oper Status: Up
Out-segment with ix: 5, owner: LDP, Stale: NO, out intf: eth5, out label: 3

NextHop addr: 25.1.1.159 cross connect ix: 5, op code: Push

Primary FTN entry with FEC: 24.1.1.0/24, id: 20, row status: Active

Owner: LDP, Stale: NO, Action-type: Redirect to LSP, Exp-bits: 0x0, Incoming DSCP:
none

Tunnel id: 0, Protected LSP id: 0, Description: N/A

Matched bytes:0, pkts:0, TX bytes:0, Pushed pkts:0

Primary: Cross connect ix: 5, in intf: - in label: 0 out-segment ix: 5

Owner: LDP, Persistent: No, Admin Status: Up, Oper Status: Up

Out-segment with ix: 5, owner: LDP, Stale: NO, out intf: eth5, out label: 3

NextHop addr: 25.1.1.159 cross connect ix: 5, op code: Push

Primary FTN entry with FEC: 27.1.1.0/24, id: 21, row status: Active

Owner: LDP, Stale: NO, Action-type: Redirect to LSP, Exp-bits: 0x0, Incoming DSCP:
none

Tunnel id: 0, Protected LSP id: 0, Description: N/A

Matched bytes:0, pkts:0, TX bytes:0, Pushed pkts:0

Primary: Cross connect ix: 5, in intf: - in label: 0 out-segment ix: 5

Owner: LDP, Persistent: No, Admin Status: Up, Oper Status: Up

Out-segment with ix: 5, owner: LDP, Stale: NO, out intf: eth5, out label: 3

NextHop addr: 25.1.1.159 cross connect ix: 5, op code: Push

Primary FTN entry with FEC: 28.1.1.0/24, id: 4, row status: Active

Owner: LDP, Stale: NO, Action-type: Redirect to LSP, Exp-bits: 0x0, Incoming DSCP:
none

Tunnel id: 0, Protected LSP id: 0, Description: N/A

Matched bytes:0, pkts:0, TX bytes:0, Pushed pkts:0

Primary: Cross connect ix: 1, in intf: - in label: 0 out-segment ix: 1

Owner: LDP, Persistent: No, Admin Status: Up, Oper Status: Up

Out-segment with ix: 1, owner: LDP, Stale: NO, out intf: eth3, out label: 3

NextHop addr: 26.1.1.161 cross connect ix: 1, op code: Push

Primary FTN entry with FEC: 29.1.1.0/24, id: 22, row status: Active

Owner: LDP, Stale: NO, Action-type: Redirect to LSP, Exp-bits: 0x0, Incoming DSCP:
none

Tunnel id: 0, Protected LSP id: 0, Description: N/A

Matched bytes:0, pkts:0, TX bytes:0, Pushed pkts:0

Primary: Cross connect ix: 5, in intf: - in label: 0 out-segment ix: 5

Owner: LDP, Persistent: No, Admin Status: Up, Oper Status: Up

Out-segment with ix: 5, owner: LDP, Stale: NO, out intf: eth5, out label: 3

NextHop addr: 25.1.1.159 cross connect ix: 5, op code: Push

Primary FTN entry with FEC: 30.1.1.0/24, id: 23, row status: Active

Owner: LDP, Stale: NO, Action-type: Redirect to LSP, Exp-bits: 0x0, Incoming DSCP:
none

Tunnel id: 0, Protected LSP id: 0, Description: N/A

BGP IPv4 Additional Paths Configuration

Matched bytes:0, pkts:0, TX bytes:0, Pushed pkts:0
Primary: Cross connect ix: 5, in intf: - in label: 0 out-segment ix: 5
Owner: LDP, Persistent: No, Admin Status: Up, Oper Status: Up
Out-segment with ix: 5, owner: LDP, Stale: NO, out intf: eth5, out label: 3
Nexthop addr: 25.1.1.159 cross connect ix: 5, op code: Push

Primary FTN entry with FEC: 32.1.1.0/24, id: 5, row status: Active
Owner: LDP, Stale: NO, Action-type: Redirect to LSP, Exp-bits: 0x0, Incoming DSCP:
none
Tunnel id: 0, Protected LSP id: 0, Description: N/A
Matched bytes:0, pkts:0, TX bytes:0, Pushed pkts:0
Primary: Cross connect ix: 1, in intf: - in label: 0 out-segment ix: 1
Owner: LDP, Persistent: No, Admin Status: Up, Oper Status: Up
Out-segment with ix: 1, owner: LDP, Stale: NO, out intf: eth3, out label: 3
Nexthop addr: 26.1.1.161 cross connect ix: 1, op code: Push

Primary FTN entry with FEC: 33.1.1.0/24, id: 6, row status: Active
Owner: LDP, Stale: NO, Action-type: Redirect to LSP, Exp-bits: 0x0, Incoming DSCP:
none
Tunnel id: 0, Protected LSP id: 0, Description: N/A
Matched bytes:0, pkts:0, TX bytes:0, Pushed pkts:0
Primary: Cross connect ix: 1, in intf: - in label: 0 out-segment ix: 1
Owner: LDP, Persistent: No, Admin Status: Up, Oper Status: Up
Out-segment with ix: 1, owner: LDP, Stale: NO, out intf: eth3, out label: 3
Nexthop addr: 26.1.1.161 cross connect ix: 1, op code: Push

Primary FTN entry with FEC: 40.1.1.0/24, id: 24, row status: Active
Owner: LDP, Stale: NO, Action-type: Redirect to LSP, Exp-bits: 0x0, Incoming DSCP:
none
Tunnel id: 0, Protected LSP id: 0, Description: N/A
Matched bytes:0, pkts:0, TX bytes:0, Pushed pkts:0
Primary: Cross connect ix: 5, in intf: - in label: 0 out-segment ix: 5
Owner: LDP, Persistent: No, Admin Status: Up, Oper Status: Up
Out-segment with ix: 5, owner: LDP, Stale: NO, out intf: eth5, out label: 3
Nexthop addr: 25.1.1.159 cross connect ix: 5, op code: Push

Primary FTN entry with FEC: 42.1.1.0/24, id: 7, row status: Active
Owner: LDP, Stale: NO, Action-type: Redirect to LSP, Exp-bits: 0x0, Incoming DSCP:
none
Tunnel id: 0, Protected LSP id: 0, Description: N/A
Matched bytes:0, pkts:0, TX bytes:0, Pushed pkts:0
Primary: Cross connect ix: 1, in intf: - in label: 0 out-segment ix: 1
Owner: LDP, Persistent: No, Admin Status: Up, Oper Status: Up
Out-segment with ix: 1, owner: LDP, Stale: NO, out intf: eth3, out label: 3
Nexthop addr: 26.1.1.161 cross connect ix: 1, op code: Push

Primary FTN entry with FEC: 50.1.1.0/24, id: 8, row status: Active
 Owner: LDP, Stale: NO, Action-type: Redirect to LSP, Exp-bits: 0x0, Incoming DSCP: none
 Tunnel id: 0, Protected LSP id: 0, Description: N/A
 Matched bytes:0, pkts:0, TX bytes:0, Pushed pkts:0
 Primary: Cross connect ix: 1, in intf: - in label: 0 out-segment ix: 1
 Owner: LDP, Persistent: No, Admin Status: Up, Oper Status: Up
 Out-segment with ix: 1, owner: LDP, Stale: NO, out intf: eth3, out label: 3
 Nexthop addr: 26.1.1.161 cross connect ix: 1, op code: Push

Primary FTN entry with FEC: 60.1.1.0/24, id: 9, row status: Active
 Owner: LDP, Stale: NO, Action-type: Redirect to LSP, Exp-bits: 0x0, Incoming DSCP: none
 Tunnel id: 0, Protected LSP id: 0, Description: N/A
 Matched bytes:0, pkts:0, TX bytes:0, Pushed pkts:0
 Primary: Cross connect ix: 1, in intf: - in label: 0 out-segment ix: 1
 Owner: LDP, Persistent: No, Admin Status: Up, Oper Status: Up
 Out-segment with ix: 1, owner: LDP, Stale: NO, out intf: eth3, out label: 3
 Nexthop addr: 26.1.1.161 cross connect ix:1, op code: Push

BR5#

BR6#show ip bgp labeled-unicast all

Status codes: s suppressed, d damped, h history, a add-path, * valid, > best, i - internal, S - stale

Network	Next Hop	In Label	Out Label
*>i 1.1.1.1/32	3.3.3.3	-	24960
*ai	8.8.8.8	-	24960
* i	9.9.9.9	-	24961
*>i 7.7.7.7/32	7.7.7.7	24961(eth6)	24960
*>i 13.13.13.13/32	13.13.13.13	24962(eth6)	24960
*>i 14.14.14.14/32	9.9.9.9	-	24960
*ai	3.3.3.3	-	24961
* i	8.8.8.8	-	24961
*>i 15.15.15.15/32	15.15.15.15	24960(eth6)	24960

BR6#

BR6#

BR6#show ip bgp labeled-unicast all summary

BGP router identifier 10.12.28.168, local AS number 100

BGP table version is 6

1 BGP AS-PATH entries

0 BGP community entries

Neighbor PfxRcd	V	AS	MsgRcv	MsgSen	TblVer	InQ	OutQ	Up/Down	State/
3.3.3.3 2	4	100	600	601	6	0	0	04:58:04	
7.7.7.7 1	4	100	598	603	6	0	0	04:57:57	

BGP IPv4 Additional Paths Configuration

8.8.8.8 2	4	100	599	600	6	0	0	04:57:59
9.9.9.9 2	4	100	598	599	6	0	0	04:57:45
13.13.13.13 1	4	100	597	602	6	0	0	04:57:29
15.15.15.15 1	4	100	598	601	6	0	0	04:57:57

Total number of neighbors 6

Total number of Established sessions 6

BR6#show ip bgp labeled-unicast 1.1.1.1/32

BGP routing table entry for 1.1.1.1/32

Paths: (3 available, best #1, table Default-IP-Routing-Table)

Advertised to non peer-group peers:

15.15.15.15

Local

3.3.3.3 (metric 12) from 3.3.3.3 (10.12.28.158)

Origin IGP, metric 0, localpref 100, label 24960, Out-label 24960, In-label NA, valid, internal, best

Originator: 10.12.28.156, Cluster list: 10.12.28.158

rx path_id: -1 tx path_id: 0

Advertised to non peer-group peers:

7.7.7.7 13.13.13.13

Last update: Mon Aug 6 00:10:29 2018

Local

8.8.8.8 (metric 12) from 8.8.8.8 (10.12.28.165)

Origin IGP, metric 0, localpref 100, label 24960, Out-label 24960, In-label NA, valid, internal, add-path

Originator: 10.12.28.156, Cluster list: 10.12.28.165

rx path_id: -1 tx path_id: 2

Advertised to non peer-group peers:

7.7.7.7 13.13.13.13

Last update: Mon Aug 6 00:10:26 2018

Local

9.9.9.9 (metric 12) from 9.9.9.9 (10.12.28.166)

Origin IGP, metric 0, localpref 100, label 24961, Out-label 24961, In-label NA, valid, internal

Originator: 10.12.28.156, Cluster list: 10.12.28.166

Not advertised to any peer

Last update: Mon Aug 6 00:10:40 2018

BR6#sh mpls ftn-table

Primary FTN entry with FEC: 1.1.1.1/32, id: 25, row status: Active

Owner: BGP, Stale: NO, Action-type: Redirect to LSP, Exp-bits: 0x0, Incoming DSCP: none

Tunnel id: 0, Protected LSP id: 0, Description: N/A

Matched bytes:0, pkts:0, TX bytes:0, Pushed pkts:0

Primary: Cross connect ix: 14, in intf: - in label: 0 out-segment ix: 13

Owner: BGP, Persistent: No, Admin Status: Up, Oper Status: Up
Out-segment with ix: 13, owner: BGP, Stale: NO, out intf: eth6, out label: 24960
Nexthop addr: 3.3.3.3 cross connect ix: 14, op code: Push and Lookup

Primary FTN entry with FEC: 3.3.3.3/32, id: 1, row status: Active

Owner: LDP, Stale: NO, Action-type: Redirect to LSP, Exp-bits: 0x0, Incoming DSCP:
none

Tunnel id: 0, Protected LSP id: 0, Description: N/A

Matched bytes:0, pkts:0, TX bytes:0, Pushed pkts:0

Primary: Cross connect ix: 1, in intf: - in label: 0 out-segment ix: 1

Owner: LDP, Persistent: No, Admin Status: Up, Oper Status: Up

Out-segment with ix: 1, owner: LDP, Stale: NO, out intf: eth6, out label: 24320

Nexthop addr: 27.1.1.159 cross connect ix: 1, op code: Push

Primary FTN entry with FEC: 4.4.4.4/32, id: 2, row status: Active

Owner: LDP, Stale: NO, Action-type: Redirect to LSP, Exp-bits: 0x0, Incoming DSCP:
none

Tunnel id: 0, Protected LSP id: 0, Description: N/A

Matched bytes:0, pkts:0, TX bytes:0, Pushed pkts:0

Primary: Cross connect ix: 2, in intf: - in label: 0 out-segment ix: 2

Owner: LDP, Persistent: No, Admin Status: Up, Oper Status: Up

Out-segment with ix: 2, owner: LDP, Stale: NO, out intf: eth6, out label: 3

Nexthop addr: 27.1.1.159 cross connect ix: 2, op code: Push

Primary FTN entry with FEC: 5.5.5.5/32, id: 12, row status: Active

Owner: LDP, Stale: NO, Action-type: Redirect to LSP, Exp-bits: 0x0, Incoming DSCP:
none

Tunnel id: 0, Protected LSP id: 0, Description: N/A

Matched bytes:0, pkts:0, TX bytes:0, Pushed pkts:0

Primary: Cross connect ix: 7, in intf: - in label: 0 out-segment ix: 6

Owner: LDP, Persistent: No, Admin Status: Up, Oper Status: Up

Out-segment with ix: 6, owner: LDP, Stale: NO, out intf: eth4, out label: 24331

Nexthop addr: 28.1.1.161 cross connect ix: 7, op code: Push

Primary FTN entry with FEC: 6.6.6.6/32, id: 13, row status: Active

Owner: LDP, Stale: NO, Action-type: Redirect to LSP, Exp-bits: 0x0, Incoming DSCP:
none

Tunnel id: 0, Protected LSP id: 0, Description: N/A

Matched bytes:0, pkts:0, TX bytes:0, Pushed pkts:0

Primary: Cross connect ix: 8, in intf: - in label: 0 out-segment ix: 7

Owner: LDP, Persistent: No, Admin Status: Up, Oper Status: Up

Out-segment with ix: 7, owner: LDP, Stale: NO, out intf: eth4, out label: 3

Nexthop addr: 28.1.1.161 cross connect ix: 8, op code: Push

Primary FTN entry with FEC: 7.7.7.7/32, id: 14, row status: Active

BGP IPv4 Additional Paths Configuration

Owner: LDP, Stale: NO, Action-type: Redirect to LSP, Exp-bits: 0x0, Incoming DSCP: none
Tunnel id: 0, Protected LSP id: 0, Description: N/A
Matched bytes:0, pkts:0, TX bytes:0, Pushed pkts:0
Primary: Cross connect ix: 9, in intf: - in label: 0 out-segment ix: 8
Owner: LDP, Persistent: No, Admin Status: Up, Oper Status: Up
Out-segment with ix: 8, owner: LDP, Stale: NO, out intf: eth4, out label: 24334
Nexthop addr: 28.1.1.161 cross connect ix: 9, op code: Push

Primary FTN entry with FEC: 7.7.7.7/32, id: 26, row status: Active
Owner: BGP, Stale: NO, Action-type: Redirect to LSP, Exp-bits: 0x0, Incoming DSCP: none
Tunnel id: 0, Protected LSP id: 0, Description: N/A
Matched bytes:0, pkts:0, TX bytes:0, Pushed pkts:0
Primary: Cross connect ix: 15, in intf: - in label: 0 out-segment ix: 14
Owner: BGP, Persistent: No, Admin Status: Down, Oper Status: Down
Out-segment with ix: 14, owner: BGP, Stale: NO, out intf: eth4, out label: 24960
Nexthop addr: 7.7.7.7 cross connect ix: 15, op code: Push

Primary FTN entry with FEC: 8.8.8.8/32, id: 3, row status: Active
Owner: LDP, Stale: NO, Action-type: Redirect to LSP, Exp-bits: 0x0, Incoming DSCP: none
Tunnel id: 0, Protected LSP id: 0, Description: N/A
Matched bytes:0, pkts:0, TX bytes:0, Pushed pkts:0
Primary: Cross connect ix: 3, in intf: - in label: 0 out-segment ix: 3
Owner: LDP, Persistent: No, Admin Status: Up, Oper Status: Up
Out-segment with ix: 3, owner: LDP, Stale: NO, out intf: eth6, out label: 24332
Nexthop addr: 27.1.1.159 cross connect ix: 3, op code: Push

Primary FTN entry with FEC: 9.9.9.9/32, id: 4, row status: Active
Owner: LDP, Stale: NO, Action-type: Redirect to LSP, Exp-bits: 0x0, Incoming DSCP: none
Tunnel id: 0, Protected LSP id: 0, Description: N/A
Matched bytes:0, pkts:0, TX bytes:0, Pushed pkts:0
Primary: Cross connect ix: 4, in intf: - in label: 0 out-segment ix: 4
Owner: LDP, Persistent: No, Admin Status: Up, Oper Status: Up
Out-segment with ix: 4, owner: LDP, Stale: NO, out intf: eth6, out label: 24322
Nexthop addr: 27.1.1.159 cross connect ix: 4, op code: Push

Primary FTN entry with FEC: 10.10.10.10/32, id: 15, row status: Active
Owner: LDP, Stale: NO, Action-type: Redirect to LSP, Exp-bits: 0x0, Incoming DSCP: none
Tunnel id: 0, Protected LSP id: 0, Description: N/A
Matched bytes:0, pkts:0, TX bytes:0, Pushed pkts:0
Primary: Cross connect ix: 10, in intf: - in label: 0 out-segment ix: 9
Owner: LDP, Persistent: No, Admin Status: Up, Oper Status: Up
Out-segment with ix: 9, owner: LDP, Stale: NO, out intf: eth4, out label: 24323

Next hop addr: 28.1.1.161 cross connect ix: 10, op code: Push

Primary FTN entry with FEC: 12.12.12.12/32, id: 16, row status: Active

Owner: LDP, Stale: NO, Action-type: Redirect to LSP, Exp-bits: 0x0, Incoming DSCP:
none

Tunnel id: 0, Protected LSP id: 0, Description: N/A

Matched bytes:0, pkts:0, TX bytes:0, Pushed pkts:0

Primary: Cross connect ix: 11, in intf: - in label: 0 out-segment ix: 10

Owner: LDP, Persistent: No, Admin Status: Up, Oper Status: Up

Out-segment with ix: 10, owner: LDP, Stale: NO, out intf: eth4, out label: 24320

Next hop addr: 28.1.1.161 cross connect ix: 11, op code: Push

Primary FTN entry with FEC: 13.13.13.13/32, id: 11, row status: Active

Owner: LDP, Stale: NO, Action-type: Redirect to LSP, Exp-bits: 0x0, Incoming DSCP:
none

Tunnel id: 0, Protected LSP id: 0, Description: N/A

Matched bytes:0, pkts:0, TX bytes:0, Pushed pkts:0

Primary: Cross connect ix: 6, in intf: - in label: 0 out-segment ix: 5

Owner: LDP, Persistent: No, Admin Status: Up, Oper Status: Up

Out-segment with ix: 5, owner: LDP, Stale: NO, out intf: eth4, out label: 24341

Next hop addr: 28.1.1.161 cross connect ix: 6, op code: Push

Primary FTN entry with FEC: 13.13.13.13/32, id: 28, row status: Active

Owner: BGP, Stale: NO, Action-type: Redirect to LSP, Exp-bits: 0x0, Incoming DSCP:
none

Tunnel id: 0, Protected LSP id: 0, Description: N/A

Matched bytes:0, pkts:0, TX bytes:0, Pushed pkts:0

Primary: Cross connect ix: 17, in intf: - in label: 0 out-segment ix: 16

Owner: BGP, Persistent: No, Admin Status: Down, Oper Status: Down

Out-segment with ix: 16, owner: BGP, Stale: NO, out intf: eth4, out label: 24960

Next hop addr: 13.13.13.13 cross connect ix: 17, op code: Push

Primary FTN entry with FEC: 14.14.14.14/32, id: 27, row status: Active

Owner: BGP, Stale: NO, Action-type: Redirect to LSP, Exp-bits: 0x0, Incoming DSCP:
none

Tunnel id: 0, Protected LSP id: 0, Description: N/A

Matched bytes:0, pkts:0, TX bytes:0, Pushed pkts:0

Primary: Cross connect ix: 16, in intf: - in label: 0 out-segment ix: 15

Owner: BGP, Persistent: No, Admin Status: Up, Oper Status: Up

Out-segment with ix: 15, owner: BGP, Stale: NO, out intf: eth6, out label: 24960

Next hop addr: 9.9.9.9 cross connect ix: 16, op code: Push and Lookup

Primary FTN entry with FEC: 15.15.15.15/32, id: 17, row status: Active

Owner: LDP, Stale: NO, Action-type: Redirect to LSP, Exp-bits: 0x0, Incoming DSCP:
none

Tunnel id: 0, Protected LSP id: 0, Description: N/A

BGP IPv4 Additional Paths Configuration

Matched bytes:0, pkts:0, TX bytes:0, Pushed pkts:0
Primary: Cross connect ix: 12, in intf: - in label: 0 out-segment ix: 11
Owner: LDP, Persistent: No, Admin Status: Up, Oper Status: Up
Out-segment with ix: 11, owner: LDP, Stale: NO, out intf: eth4, out label: 24321
Nexthop addr: 28.1.1.161 cross connect ix: 12, op code: Push

Primary FTN entry with FEC: 15.15.15.15/32, id: 24, row status: Active
Owner: BGP, Stale: NO, Action-type: Redirect to LSP, Exp-bits: 0x0, Incoming DSCP:
none
Tunnel id: 0, Protected LSP id: 0, Description: N/A
Matched bytes:0, pkts:0, TX bytes:0, Pushed pkts:0
Primary: Cross connect ix: 13, in intf: - in label: 0 out-segment ix: 12
Owner: BGP, Persistent: No, Admin Status: Down, Oper Status: Down
Out-segment with ix: 12, owner: BGP, Stale: NO, out intf: eth4, out label: 24960
Nexthop addr: 15.15.15.15 cross connect ix: 13, op code: Push

Primary FTN entry with FEC: 22.1.1.0/24, id: 5, row status: Active
Owner: LDP, Stale: NO, Action-type: Redirect to LSP, Exp-bits: 0x0, Incoming DSCP:
none
Tunnel id: 0, Protected LSP id: 0, Description: N/A
Matched bytes:0, pkts:0, TX bytes:0, Pushed pkts:0
Primary: Cross connect ix: 2, in intf: - in label: 0 out-segment ix: 2
Owner: LDP, Persistent: No, Admin Status: Up, Oper Status: Up
Out-segment with ix: 2, owner: LDP, Stale: NO, out intf: eth6, out label: 3
Nexthop addr: 27.1.1.159 cross connect ix: 2, op code: Push

Primary FTN entry with FEC: 24.1.1.0/24, id: 6, row status: Active
Owner: LDP, Stale: NO, Action-type: Redirect to LSP, Exp-bits: 0x0, Incoming DSCP:
none
Tunnel id: 0, Protected LSP id: 0, Description: N/A
Matched bytes:0, pkts:0, TX bytes:0, Pushed pkts:0
Primary: Cross connect ix: 2, in intf: - in label: 0 out-segment ix: 2
Owner: LDP, Persistent: No, Admin Status: Up, Oper Status: Up
Out-segment with ix: 2, owner: LDP, Stale: NO, out intf: eth6, out label: 3
Nexthop addr: 27.1.1.159 cross connect ix: 2, op code: Push

Primary FTN entry with FEC: 25.1.1.0/24, id: 7, row status: Active
Owner: LDP, Stale: NO, Action-type: Redirect to LSP, Exp-bits: 0x0, Incoming DSCP:
none
Tunnel id: 0, Protected LSP id: 0, Description: N/A
Matched bytes:0, pkts:0, TX bytes:0, Pushed pkts:0
Primary: Cross connect ix: 2, in intf: - in label: 0 out-segment ix: 2
Owner: LDP, Persistent: No, Admin Status: Up, Oper Status: Up
Out-segment with ix: 2, owner: LDP, Stale: NO, out intf: eth6, out label: 3
Nexthop addr: 27.1.1.159 cross connect ix: 2, op code: Push

Primary FTN entry with FEC: 26.1.1.0/24, id: 18, row status: Active
Owner: LDP, Stale: NO, Action-type: Redirect to LSP, Exp-bits: 0x0, Incoming DSCP:
none
Tunnel id: 0, Protected LSP id: 0, Description: N/A
Matched bytes:0, pkts:0, TX bytes:0, Pushed pkts:0
Primary: Cross connect ix: 8, in intf: - in label: 0 out-segment ix: 7
Owner: LDP, Persistent: No, Admin Status: Up, Oper Status: Up
Out-segment with ix: 7, owner: LDP, Stale: NO, out intf: eth4, out label: 3
Nexthop addr: 28.1.1.161 cross connect ix: 8, op code: Push

Primary FTN entry with FEC: 29.1.1.0/24, id: 8, row status: Active
Owner: LDP, Stale: NO, Action-type: Redirect to LSP, Exp-bits: 0x0, Incoming DSCP:
none
Tunnel id: 0, Protected LSP id: 0, Description: N/A
Matched bytes:0, pkts:0, TX bytes:0, Pushed pkts:0
Primary: Cross connect ix: 2, in intf: - in label: 0 out-segment ix: 2
Owner: LDP, Persistent: No, Admin Status: Up, Oper Status: Up
Out-segment with ix: 2, owner: LDP, Stale: NO, out intf: eth6, out label: 3
Nexthop addr: 27.1.1.159 cross connect ix: 2, op code: Push

Primary FTN entry with FEC: 30.1.1.0/24, id: 9, row status: Active
Owner: LDP, Stale: NO, Action-type: Redirect to LSP, Exp-bits: 0x0, Incoming DSCP:
none
Tunnel id: 0, Protected LSP id: 0, Description: N/A
Matched bytes:0, pkts:0, TX bytes:0, Pushed pkts:0
Primary: Cross connect ix: 2, in intf: - in label: 0 out-segment ix: 2
Owner: LDP, Persistent: No, Admin Status: Up, Oper Status: Up
Out-segment with ix: 2, owner: LDP, Stale: NO, out intf: eth6, out label: 3
Nexthop addr: 27.1.1.159 cross connect ix: 2, op code: Push

Primary FTN entry with FEC: 32.1.1.0/24, id: 19, row status: Active
Owner: LDP, Stale: NO, Action-type: Redirect to LSP, Exp-bits: 0x0, Incoming DSCP:
none
Tunnel id: 0, Protected LSP id: 0, Description: N/A
Matched bytes:0, pkts:0, TX bytes:0, Pushed pkts:0
Primary: Cross connect ix: 8, in intf: - in label: 0 out-segment ix: 7
Owner: LDP, Persistent: No, Admin Status: Up, Oper Status: Up
Out-segment with ix: 7, owner: LDP, Stale: NO, out intf: eth4, out label: 3
Nexthop addr: 28.1.1.161 cross connect ix: 8, op code: Push

Primary FTN entry with FEC: 33.1.1.0/24, id: 20, row status: Active
Owner: LDP, Stale: NO, Action-type: Redirect to LSP, Exp-bits: 0x0, Incoming DSCP:
none
Tunnel id: 0, Protected LSP id: 0, Description: N/A
Matched bytes:0, pkts:0, TX bytes:0, Pushed pkts:0
Primary: Cross connect ix: 8, in intf: - in label: 0 out-segment ix: 7
Owner: LDP, Persistent: No, Admin Status: Up, Oper Status: Up

BGP IPv4 Additional Paths Configuration

Out-segment with ix: 7, owner: LDP, Stale: NO, out intf: eth4, out label: 3
Nexthop addr: 28.1.1.161 cross connect ix: 8, op code: Push

Primary FTN entry with FEC: 40.1.1.0/24, id: 10, row status: Active
Owner: LDP, Stale: NO, Action-type: Redirect to LSP, Exp-bits: 0x0, Incoming DSCP:
none

Tunnel id: 0, Protected LSP id: 0, Description: N/A

Matched bytes:0, pkts:0, TX bytes:0, Pushed pkts:0

Primary: Cross connect ix: 2, in intf: - in label: 0 out-segment ix: 2

Owner: LDP, Persistent: No, Admin Status: Up, Oper Status: Up

Out-segment with ix: 2, owner: LDP, Stale: NO, out intf: eth6, out label: 3

Nexthop addr: 27.1.1.159 cross connect ix: 2, op code: Push

Primary FTN entry with FEC: 42.1.1.0/24, id: 21, row status: Active
Owner: LDP, Stale: NO, Action-type: Redirect to LSP, Exp-bits: 0x0, Incoming DSCP:
none

Tunnel id: 0, Protected LSP id: 0, Description: N/A

Matched bytes:0, pkts:0, TX bytes:0, Pushed pkts:0

Primary: Cross connect ix: 8, in intf: - in label: 0 out-segment ix: 7

Owner: LDP, Persistent: No, Admin Status: Up, Oper Status: Up

Out-segment with ix: 7, owner: LDP, Stale: NO, out intf: eth4, out label: 3

Nexthop addr: 28.1.1.161 cross connect ix: 8, op code: Push

Primary FTN entry with FEC: 50.1.1.0/24, id: 22, row status: Active
Owner: LDP, Stale: NO, Action-type: Redirect to LSP, Exp-bits: 0x0, Incoming DSCP:
none

Tunnel id: 0, Protected LSP id: 0, Description: N/A

Matched bytes:0, pkts:0, TX bytes:0, Pushed pkts:0

Primary: Cross connect ix: 8, in intf: - in label: 0 out-segment ix: 7

Owner: LDP, Persistent: No, Admin Status: Up, Oper Status: Up

Out-segment with ix: 7, owner: LDP, Stale: NO, out intf: eth4, out label: 3

Nexthop addr: 28.1.1.161 cross connect ix: 8, op code: Push

Primary FTN entry with FEC: 60.1.1.0/24, id: 23, row status: Active
Owner: LDP, Stale: NO, Action-type: Redirect to LSP, Exp-bits: 0x0, Incoming DSCP:
none

Tunnel id: 0, Protected LSP id: 0, Description: N/A

Matched bytes:0, pkts:0, TX bytes:0, Pushed pkts:0

Primary: Cross connect ix: 8, in intf: - in label: 0 out-segment ix: 7

Owner: LDP, Persistent: No, Admin Status: Up, Oper Status: Up

Out-segment with ix: 7, owner: LDP, Stale: NO, out intf: eth4, out label: 3

Nexthop addr: 28.1.1.161 cross connect ix: 8, op code: Push

BR6#

BR2#show ip bgp labeled-unicast all

Status codes: s suppressed, d damped, h history, a add-path, * valid, > best, i - internal, S - stale

Network	Next Hop	In Label	Out Label
*>i 1.1.1.1/32	3.3.3.3	-	24960
*ai	8.8.8.8	-	24960
*ai	9.9.9.9	-	24961
*>i 7.7.7.7/32	7.7.7.7	24960(eth2)	24960
*>i 13.13.13.13/32	13.13.13.13	24962(eth2)	24960
*>i 14.14.14.14/32	9.9.9.9	-	24960
*ai	3.3.3.3	-	24961
*ai	8.8.8.8	-	24961
*>i 15.15.15.15/32	15.15.15.15	24961(eth2)	24960

BR2#

BR2#show ip bgp labeled-unicast all summary

BGP router identifier 10.12.28.160, local AS number 100

BGP table version is 6

1 BGP AS-PATH entries

0 BGP community entries

Neighbor PfxRcd	V	AS	MsgRcv	MsgSen	TblVer	InQ	OutQ	Up/Down	State/
3.3.3.3 2	4	100	601	601	6	0	0	04:58:39	
7.7.7.7 1	4	100	600	606	6	0	0	04:58:44	
8.8.8.8 2	4	100	601	601	6	0	0	04:58:43	
9.9.9.9 2	4	100	600	601	6	0	0	04:58:33	
13.13.13.13 1	4	100	600	606	6	0	0	04:58:34	
15.15.15.15 1	4	100	600	604	6	0	0	04:58:43	

Total number of neighbors 6

Total number of Established sessions 6

BR2#

BR2#show ip bgp labeled-unicast 1.1.1.1/32

BGP routing table entry for 1.1.1.1/32

Paths: (3 available, best #1, table Default-IP-Routing-Table)

Advertised to non peer-group peers:

15.15.15.15

Local

3.3.3.3 (metric 12) from 3.3.3.3 (10.12.28.158)

Origin IGP, metric 0, localpref 100, label 24960, Out-label 24960, In-label NA, valid, internal, best

Originator: 10.12.28.156, Cluster list: 10.12.28.158

rx path_id: -1 tx path_id: 1

Advertised to non peer-group peers:

7.7.7.7 13.13.13.13

BGP IPv4 Additional Paths Configuration

Last update: Mon Aug 6 00:10:31 2018

Local

8.8.8.8 (metric 12) from 8.8.8.8 (10.12.28.165)
Origin IGP, metric 0, localpref 100, label 24960, Out-label 24960, In-label
NA , valid, internal, add-path
Originator: 10.12.28.156, Cluster list: 10.12.28.165
rx path_id: -1 tx path_id: 0
Advertised to non peer-group peers:
7.7.7.7 13.13.13.13
Last update: Mon Aug 6 00:10:27 2018

Local

9.9.9.9 (metric 12) from 9.9.9.9 (10.12.28.166)
Origin IGP, metric 0, localpref 100, label 24961, Out-label 24961, In-label
NA , valid, internal, add-path
Originator: 10.12.28.156, Cluster list: 10.12.28.166
rx path_id: -1 tx path_id: 2
Advertised to non peer-group peers:
7.7.7.7 13.13.13.13
Last update: Mon Aug 6 00:10:37 2018

BR2#show mpls ftn-table

Primary FTN entry with FEC: 1.1.1.1/32, id: 24, row status: Active
Owner: BGP, Stale: NO, Action-type: Redirect to LSP, Exp-bits: 0x0, Incoming DSCP:
none
Tunnel id: 0, Protected LSP id: 0, Description: N/A
Matched bytes:0, pkts:0, TX bytes:0, Pushed pkts:0
Primary: Cross connect ix: 14, in intf: - in label: 0 out-segment ix: 12
Owner: BGP, Persistent: No, Admin Status: Up, Oper Status: Up
Out-segment with ix: 12, owner: BGP, Stale: NO, out intf: eth2, out label: 24960
Nexthop addr: 3.3.3.3 cross connect ix: 14, op code: Push and Lookup

Primary FTN entry with FEC: 3.3.3.3/32, id: 1, row status: Active
Owner: LDP, Stale: NO, Action-type: Redirect to LSP, Exp-bits: 0x0, Incoming DSCP:
none
Tunnel id: 0, Protected LSP id: 0, Description: N/A
Matched bytes:0, pkts:0, TX bytes:0, Pushed pkts:0
Primary: Cross connect ix: 1, in intf: - in label: 0 out-segment ix: 1
Owner: LDP, Persistent: No, Admin Status: Up, Oper Status: Up
Out-segment with ix: 1, owner: LDP, Stale: NO, out intf: eth2, out label: 24320
Nexthop addr: 40.1.1.159 cross connect ix: 1, op code: Push

Primary FTN entry with FEC: 4.4.4.4/32, id: 2, row status: Active
Owner: LDP, Stale: NO, Action-type: Redirect to LSP, Exp-bits: 0x0, Incoming DSCP:
none
Tunnel id: 0, Protected LSP id: 0, Description: N/A
Matched bytes:0, pkts:0, TX bytes:0, Pushed pkts:0
Primary: Cross connect ix: 2, in intf: - in label: 0 out-segment ix: 2

Owner: LDP, Persistent: No, Admin Status: Up, Oper Status: Up
Out-segment with ix: 2, owner: LDP, Stale: NO, out intf: eth2, out label: 3
Nexthop addr: 40.1.1.159 cross connect ix: 2, op code: Push

Primary FTN entry with FEC: 6.6.6.6/32, id: 12, row status: Active
Owner: LDP, Stale: NO, Action-type: Redirect to LSP, Exp-bits: 0x0, Incoming DSCP:
none
Tunnel id: 0, Protected LSP id: 0, Description: N/A
Matched bytes:0, pkts:0, TX bytes:0, Pushed pkts:0
Primary: Cross connect ix: 6, in intf: - in label: 0 out-segment ix: 6
Owner: LDP, Persistent: No, Admin Status: Up, Oper Status: Up
Out-segment with ix: 6, owner: LDP, Stale: NO, out intf: eth1, out label: 3
Nexthop addr: 50.1.1.161 cross connect ix: 6, op code: Push

Primary FTN entry with FEC: 7.7.7.7/32, id: 13, row status: Active
Owner: LDP, Stale: NO, Action-type: Redirect to LSP, Exp-bits: 0x0, Incoming DSCP:
none
Tunnel id: 0, Protected LSP id: 0, Description: N/A
Matched bytes:0, pkts:0, TX bytes:0, Pushed pkts:0
Primary: Cross connect ix: 11, in intf: - in label: 0 out-segment ix: 10
Owner: LDP, Persistent: No, Admin Status: Up, Oper Status: Up
Out-segment with ix: 10, owner: LDP, Stale: NO, out intf: eth1, out label: 24334
Nexthop addr: 50.1.1.161 cross connect ix: 11, op code: Push

Primary FTN entry with FEC: 7.7.7.7/32, id: 25, row status: Active
Owner: BGP, Stale: NO, Action-type: Redirect to LSP, Exp-bits: 0x0, Incoming DSCP:
none
Tunnel id: 0, Protected LSP id: 0, Description: N/A
Matched bytes:0, pkts:0, TX bytes:0, Pushed pkts:0
Primary: Cross connect ix: 15, in intf: - in label: 0 out-segment ix: 13
Owner: BGP, Persistent: No, Admin Status: Down, Oper Status: Down
Out-segment with ix: 13, owner: BGP, Stale: NO, out intf: eth1, out label: 24960
Nexthop addr: 7.7.7.7 cross connect ix: 15, op code: Push

Primary FTN entry with FEC: 8.8.8.8/32, id: 3, row status: Active
Owner: LDP, Stale: NO, Action-type: Redirect to LSP, Exp-bits: 0x0, Incoming DSCP:
none
Tunnel id: 0, Protected LSP id: 0, Description: N/A
Matched bytes:0, pkts:0, TX bytes:0, Pushed pkts:0
Primary: Cross connect ix: 4, in intf: - in label: 0 out-segment ix: 4
Owner: LDP, Persistent: No, Admin Status: Up, Oper Status: Up
Out-segment with ix: 4, owner: LDP, Stale: NO, out intf: eth2, out label: 24333
Nexthop addr: 40.1.1.159 cross connect ix: 4, op code: Push

Primary FTN entry with FEC: 9.9.9.9/32, id: 4, row status: Active

BGP IPv4 Additional Paths Configuration

Owner: LDP, Stale: NO, Action-type: Redirect to LSP, Exp-bits: 0x0, Incoming DSCP: none
Tunnel id: 0, Protected LSP id: 0, Description: N/A
Matched bytes:0, pkts:0, TX bytes:0, Pushed pkts:0
Primary: Cross connect ix: 3, in intf: - in label: 0 out-segment ix: 3
Owner: LDP, Persistent: No, Admin Status: Up, Oper Status: Up
Out-segment with ix: 3, owner: LDP, Stale: NO, out intf: eth2, out label: 24322
Nexthop addr: 40.1.1.159 cross connect ix: 3, op code: Push

Primary FTN entry with FEC: 10.10.10.10/32, id: 14, row status: Active
Owner: LDP, Stale: NO, Action-type: Redirect to LSP, Exp-bits: 0x0, Incoming DSCP: none
Tunnel id: 0, Protected LSP id: 0, Description: N/A
Matched bytes:0, pkts:0, TX bytes:0, Pushed pkts:0
Primary: Cross connect ix: 7, in intf: - in label: 0 out-segment ix: 7
Owner: LDP, Persistent: No, Admin Status: Up, Oper Status: Up
Out-segment with ix: 7, owner: LDP, Stale: NO, out intf: eth1, out label: 24323
Nexthop addr: 50.1.1.161 cross connect ix: 7, op code: Push

Primary FTN entry with FEC: 11.11.11.11/32, id: 5, row status: Active
Owner: LDP, Stale: NO, Action-type: Redirect to LSP, Exp-bits: 0x0, Incoming DSCP: none
Tunnel id: 0, Protected LSP id: 0, Description: N/A
Matched bytes:0, pkts:0, TX bytes:0, Pushed pkts:0
Primary: Cross connect ix: 5, in intf: - in label: 0 out-segment ix: 5
Owner: LDP, Persistent: No, Admin Status: Up, Oper Status: Up
Out-segment with ix: 5, owner: LDP, Stale: NO, out intf: eth2, out label: 24338
Nexthop addr: 40.1.1.159 cross connect ix: 5, op code: Push

Primary FTN entry with FEC: 12.12.12.12/32, id: 15, row status: Active
Owner: LDP, Stale: NO, Action-type: Redirect to LSP, Exp-bits: 0x0, Incoming DSCP: none
Tunnel id: 0, Protected LSP id: 0, Description: N/A
Matched bytes:0, pkts:0, TX bytes:0, Pushed pkts:0
Primary: Cross connect ix: 8, in intf: - in label: 0 out-segment ix: 8
Owner: LDP, Persistent: No, Admin Status: Up, Oper Status: Up
Out-segment with ix: 8, owner: LDP, Stale: NO, out intf: eth1, out label: 24320
Nexthop addr: 50.1.1.161 cross connect ix: 8, op code: Push

Primary FTN entry with FEC: 13.13.13.13/32, id: 16, row status: Active
Owner: LDP, Stale: NO, Action-type: Redirect to LSP, Exp-bits: 0x0, Incoming DSCP: none
Tunnel id: 0, Protected LSP id: 0, Description: N/A
Matched bytes:0, pkts:0, TX bytes:0, Pushed pkts:0
Primary: Cross connect ix: 13, in intf: - in label: 0 out-segment ix: 11
Owner: LDP, Persistent: No, Admin Status: Up, Oper Status: Up
Out-segment with ix: 11, owner: LDP, Stale: NO, out intf: eth1, out label: 24338

Nexthop addr: 50.1.1.161 cross connect ix: 13, op code: Push

Primary FTN entry with FEC: 13.13.13.13/32, id: 28, row status: Active

Owner: BGP, Stale: NO, Action-type: Redirect to LSP, Exp-bits: 0x0, Incoming DSCP:
none

Tunnel id: 0, Protected LSP id: 0, Description: N/A

Matched bytes:0, pkts:0, TX bytes:0, Pushed pkts:0

Primary: Cross connect ix: 18, in intf: - in label: 0 out-segment ix: 16

Owner: BGP, Persistent: No, Admin Status: Down, Oper Status: Down

Out-segment with ix: 16, owner: BGP, Stale: NO, out intf: eth1, out label: 24960

Nexthop addr: 13.13.13.13 cross connect ix: 18, op code: Push

Primary FTN entry with FEC: 14.14.14.14/32, id: 27, row status: Active

Owner: BGP, Stale: NO, Action-type: Redirect to LSP, Exp-bits: 0x0, Incoming DSCP:
none

Tunnel id: 0, Protected LSP id: 0, Description: N/A

Matched bytes:0, pkts:0, TX bytes:0, Pushed pkts:0

Primary: Cross connect ix: 17, in intf: - in label: 0 out-segment ix: 15

Owner: BGP, Persistent: No, Admin Status: Up, Oper Status: Up

Out-segment with ix: 15, owner: BGP, Stale: NO, out intf: eth2, out label: 24960

Nexthop addr: 9.9.9.9 cross connect ix: 17, op code: Push and Lookup

Primary FTN entry with FEC: 15.15.15.15/32, id: 17, row status: Active

Owner: LDP, Stale: NO, Action-type: Redirect to LSP, Exp-bits: 0x0, Incoming DSCP:
none

Tunnel id: 0, Protected LSP id: 0, Description: N/A

Matched bytes:0, pkts:0, TX bytes:0, Pushed pkts:0

Primary: Cross connect ix: 9, in intf: - in label: 0 out-segment ix: 9

Owner: LDP, Persistent: No, Admin Status: Up, Oper Status: Up

Out-segment with ix: 9, owner: LDP, Stale: NO, out intf: eth1, out label: 24321

Nexthop addr: 50.1.1.161 cross connect ix: 9, op code: Push

Primary FTN entry with FEC: 15.15.15.15/32, id: 26, row status: Active

Owner: BGP, Stale: NO, Action-type: Redirect to LSP, Exp-bits: 0x0, Incoming DSCP:
none

Tunnel id: 0, Protected LSP id: 0, Description: N/A

Matched bytes:0, pkts:0, TX bytes:0, Pushed pkts:0

Primary: Cross connect ix: 16, in intf: - in label: 0 out-segment ix: 14

Owner: BGP, Persistent: No, Admin Status: Down, Oper Status: Down

Out-segment with ix: 14, owner: BGP, Stale: NO, out intf: eth1, out label: 24960

Nexthop addr: 15.15.15.15 cross connect ix: 16, op code: Push

Primary FTN entry with FEC: 22.1.1.0/24, id: 6, row status: Active

Owner: LDP, Stale: NO, Action-type: Redirect to LSP, Exp-bits: 0x0, Incoming DSCP:
none

Tunnel id: 0, Protected LSP id: 0, Description: N/A

BGP IPv4 Additional Paths Configuration

Matched bytes:0, pkts:0, TX bytes:0, Pushed pkts:0
Primary: Cross connect ix: 2, in intf: - in label: 0 out-segment ix: 2
Owner: LDP, Persistent: No, Admin Status: Up, Oper Status: Up
Out-segment with ix: 2, owner: LDP, Stale: NO, out intf: eth2, out label: 3
Nexthop addr: 40.1.1.159 cross connect ix: 2, op code: Push

Primary FTN entry with FEC: 24.1.1.0/24, id: 7, row status: Active
Owner: LDP, Stale: NO, Action-type: Redirect to LSP, Exp-bits: 0x0, Incoming DSCP:
none
Tunnel id: 0, Protected LSP id: 0, Description: N/A
Matched bytes:0, pkts:0, TX bytes:0, Pushed pkts:0
Primary: Cross connect ix: 2, in intf: - in label: 0 out-segment ix: 2
Owner: LDP, Persistent: No, Admin Status: Up, Oper Status: Up
Out-segment with ix: 2, owner: LDP, Stale: NO, out intf: eth2, out label: 3
Nexthop addr: 40.1.1.159 cross connect ix: 2, op code: Push

Primary FTN entry with FEC: 25.1.1.0/24, id: 8, row status: Active
Owner: LDP, Stale: NO, Action-type: Redirect to LSP, Exp-bits: 0x0, Incoming DSCP:
none
Tunnel id: 0, Protected LSP id: 0, Description: N/A
Matched bytes:0, pkts:0, TX bytes:0, Pushed pkts:0
Primary: Cross connect ix: 2, in intf: - in label: 0 out-segment ix: 2
Owner: LDP, Persistent: No, Admin Status: Up, Oper Status: Up
Out-segment with ix: 2, owner: LDP, Stale: NO, out intf: eth2, out label: 3
Nexthop addr: 40.1.1.159 cross connect ix: 2, op code: Push

Primary FTN entry with FEC: 26.1.1.0/24, id: 18, row status: Active
Owner: LDP, Stale: NO, Action-type: Redirect to LSP, Exp-bits: 0x0, Incoming DSCP:
none
Tunnel id: 0, Protected LSP id: 0, Description: N/A
Matched bytes:0, pkts:0, TX bytes:0, Pushed pkts:0
Primary: Cross connect ix: 6, in intf: - in label: 0 out-segment ix: 6
Owner: LDP, Persistent: No, Admin Status: Up, Oper Status: Up
Out-segment with ix: 6, owner: LDP, Stale: NO, out intf: eth1, out label: 3
Nexthop addr: 50.1.1.161 cross connect ix: 6, op code: Push

Primary FTN entry with FEC: 27.1.1.0/24, id: 9, row status: Active
Owner: LDP, Stale: NO, Action-type: Redirect to LSP, Exp-bits: 0x0, Incoming DSCP:
none
Tunnel id: 0, Protected LSP id: 0, Description: N/A
Matched bytes:0, pkts:0, TX bytes:0, Pushed pkts:0
Primary: Cross connect ix: 2, in intf: - in label: 0 out-segment ix: 2
Owner: LDP, Persistent: No, Admin Status: Up, Oper Status: Up
Out-segment with ix: 2, owner: LDP, Stale: NO, out intf: eth2, out label: 3
Nexthop addr: 40.1.1.159 cross connect ix: 2, op code: Push

Primary FTN entry with FEC: 28.1.1.0/24, id: 19, row status: Active
Owner: LDP, Stale: NO, Action-type: Redirect to LSP, Exp-bits: 0x0, Incoming DSCP:
none
Tunnel id: 0, Protected LSP id: 0, Description: N/A
Matched bytes:0, pkts:0, TX bytes:0, Pushed pkts:0
Primary: Cross connect ix: 6, in intf: - in label: 0 out-segment ix: 6
Owner: LDP, Persistent: No, Admin Status: Up, Oper Status: Up
Out-segment with ix: 6, owner: LDP, Stale: NO, out intf: eth1, out label: 3
Nexthop addr: 50.1.1.161 cross connect ix: 6, op code: Push

Primary FTN entry with FEC: 29.1.1.0/24, id: 10, row status: Active
Owner: LDP, Stale: NO, Action-type: Redirect to LSP, Exp-bits: 0x0, Incoming DSCP:
none
Tunnel id: 0, Protected LSP id: 0, Description: N/A
Matched bytes:0, pkts:0, TX bytes:0, Pushed pkts:0
Primary: Cross connect ix: 2, in intf: - in label: 0 out-segment ix: 2
Owner: LDP, Persistent: No, Admin Status: Up, Oper Status: Up
Out-segment with ix: 2, owner: LDP, Stale: NO, out intf: eth2, out label: 3
Nexthop addr: 40.1.1.159 cross connect ix: 2, op code: Push

Primary FTN entry with FEC: 30.1.1.0/24, id: 11, row status: Active
Owner: LDP, Stale: NO, Action-type: Redirect to LSP, Exp-bits: 0x0, Incoming DSCP:
none
Tunnel id: 0, Protected LSP id: 0, Description: N/A
Matched bytes:0, pkts:0, TX bytes:0, Pushed pkts:0
Primary: Cross connect ix: 2, in intf: - in label: 0 out-segment ix: 2
Owner: LDP, Persistent: No, Admin Status: Up, Oper Status: Up
Out-segment with ix: 2, owner: LDP, Stale: NO, out intf: eth2, out label: 3
Nexthop addr: 40.1.1.159 cross connect ix: 2, op code: Push

Primary FTN entry with FEC: 32.1.1.0/24, id: 20, row status: Active
Owner: LDP, Stale: NO, Action-type: Redirect to LSP, Exp-bits: 0x0, Incoming DSCP:
none
Tunnel id: 0, Protected LSP id: 0, Description: N/A
Matched bytes:0, pkts:0, TX bytes:0, Pushed pkts:0
Primary: Cross connect ix: 6, in intf: - in label: 0 out-segment ix: 6
Owner: LDP, Persistent: No, Admin Status: Up, Oper Status: Up
Out-segment with ix: 6, owner: LDP, Stale: NO, out intf: eth1, out label: 3
Nexthop addr: 50.1.1.161 cross connect ix: 6, op code: Push

Primary FTN entry with FEC: 33.1.1.0/24, id: 21, row status: Active
Owner: LDP, Stale: NO, Action-type: Redirect to LSP, Exp-bits: 0x0, Incoming DSCP:
none
Tunnel id: 0, Protected LSP id: 0, Description: N/A
Matched bytes:0, pkts:0, TX bytes:0, Pushed pkts:0
Primary: Cross connect ix: 6, in intf: - in label: 0 out-segment ix: 6
Owner: LDP, Persistent: No, Admin Status: Up, Oper Status: Up

BGP IPv4 Additional Paths Configuration

Out-segment with ix: 6, owner: LDP, Stale: NO, out intf: eth1, out label: 3
Nexthop addr: 50.1.1.161 cross connect ix: 6, op code: Push

Primary FTN entry with FEC: 42.1.1.0/24, id: 22, row status: Active
Owner: LDP, Stale: NO, Action-type: Redirect to LSP, Exp-bits: 0x0, Incoming DSCP:
none
Tunnel id: 0, Protected LSP id: 0, Description: N/A
Matched bytes:0, pkts:0, TX bytes:0, Pushed pkts:0
Primary: Cross connect ix: 6, in intf: - in label: 0 out-segment ix: 6
Owner: LDP, Persistent: No, Admin Status: Up, Oper Status: Up
Out-segment with ix: 6, owner: LDP, Stale: NO, out intf: eth1, out label: 3
Nexthop addr: 50.1.1.161 cross connect ix: 6, op code: Push

Primary FTN entry with FEC: 60.1.1.0/24, id: 23, row status: Active
Owner: LDP, Stale: NO, Action-type: Redirect to LSP, Exp-bits: 0x0, Incoming DSCP:
none
Tunnel id: 0, Protected LSP id: 0, Description: N/A
Matched bytes:0, pkts:0, TX bytes:0, Pushed pkts:0
Primary: Cross connect ix: 6, in intf: - in label: 0 out-segment ix: 6
Owner: LDP, Persistent: No, Admin Status: Up, Oper Status: Up
Out-segment with ix: 6, owner: LDP, Stale: NO, out intf: eth1, out label: 3
Nexthop addr: 50.1.1.161 cross connect ix: 6, op code: Push

BR2#

BR7#show ip bgp labeled-unicast all

Status codes: s suppressed, d damped, h history, a add-path, * valid, > best, i -
internal, S - stale

Network	Next Hop	In Label	Out Label
*>i 1.1.1.1/32	3.3.3.3	-	24960
*ai	8.8.8.8	-	24960
*ai	9.9.9.9	-	24961
*>i 7.7.7.7/32	7.7.7.7	24962(eth7)	24960
*>i 13.13.13.13/32	13.13.13.13	24960(eth7)	24960
*>i 14.14.14.14/32	3.3.3.3	-	24961
*ai	8.8.8.8	-	24961
*ai	9.9.9.9	-	24960
*>i 15.15.15.15/32	15.15.15.15	24961(eth7)	24960

BR7#

BR7#show ip bgp labeled-unicast all summary

BGP router identifier 10.12.28.169, local AS number 100

BGP table version is 7

1 BGP AS-PATH entries

0 BGP community entries

Neighbor	V	AS	MsgRcv	MsgSen	TblVer	InQ	OutQ	Up/Down	State/
PfxRcd									

3.3.3.3 2	4	100	603	603	7	0	0	04:59:46
7.7.7.7 1	4	100	602	607	7	0	0	04:59:43
8.8.8.8 2	4	100	603	604	7	0	0	04:59:40
9.9.9.9 2	4	100	603	604	7	0	0	04:59:47
13.13.13.13 1	4	100	602	608	7	0	0	04:59:42
15.15.15.15 1	4	100	602	606	7	0	0	04:59:40

Total number of neighbors 6

Total number of Established sessions 6

BR7#

BR7#show mpls ftn-table

Primary FTN entry with FEC: 1.1.1.1/32, id: 25, row status: Active

Owner: BGP, Stale: NO, Action-type: Redirect to LSP, Exp-bits: 0x0, Incoming DSCP: none

Tunnel id: 0, Protected LSP id: 0, Description: N/A

Matched bytes:0, pkts:0, TX bytes:0, Pushed pkts:0

Primary: Cross connect ix: 20, in intf: - in label: 0 out-segment ix: 13

Owner: BGP, Persistent: No, Admin Status: Up, Oper Status: Up

Out-segment with ix: 13, owner: BGP, Stale: NO, out intf: eth7, out label: 24960

Nexthop addr: 3.3.3.3 cross connect ix: 20, op code: Push and Lookup

Primary FTN entry with FEC: 3.3.3.3/32, id: 12, row status: Active

Owner: LDP, Stale: NO, Action-type: Redirect to LSP, Exp-bits: 0x0, Incoming DSCP: none

Tunnel id: 0, Protected LSP id: 0, Description: N/A

Matched bytes:0, pkts:0, TX bytes:0, Pushed pkts:0

Primary: Cross connect ix: 3, in intf: - in label: 0 out-segment ix: 3

Owner: LDP, Persistent: No, Admin Status: Up, Oper Status: Up

Out-segment with ix: 3, owner: LDP, Stale: NO, out intf: eth7, out label: 24320

Nexthop addr: 29.1.1.159 cross connect ix: 3, op code: Push

Primary FTN entry with FEC: 4.4.4.4/32, id: 13, row status: Active

Owner: LDP, Stale: NO, Action-type: Redirect to LSP, Exp-bits: 0x0, Incoming DSCP: none

Tunnel id: 0, Protected LSP id: 0, Description: N/A

Matched bytes:0, pkts:0, TX bytes:0, Pushed pkts:0

Primary: Cross connect ix: 4, in intf: - in label: 0 out-segment ix: 4

Owner: LDP, Persistent: No, Admin Status: Up, Oper Status: Up

Out-segment with ix: 4, owner: LDP, Stale: NO, out intf: eth7, out label: 3

Nexthop addr: 29.1.1.159 cross connect ix: 4, op code: Push

Primary FTN entry with FEC: 5.5.5.5/32, id: 9, row status: Active

BGP IPv4 Additional Paths Configuration

Owner: LDP, Stale: NO, Action-type: Redirect to LSP, Exp-bits: 0x0, Incoming DSCP: none
Tunnel id: 0, Protected LSP id: 0, Description: N/A
Matched bytes:0, pkts:0, TX bytes:0, Pushed pkts:0
Primary: Cross connect ix: 15, in intf: - in label: 0 out-segment ix: 10
Owner: LDP, Persistent: No, Admin Status: Up, Oper Status: Up
Out-segment with ix: 10, owner: LDP, Stale: NO, out intf: eth5, out label: 24332
Nexthop addr: 33.1.1.161 cross connect ix: 15, op code: Push

Primary FTN entry with FEC: 6.6.6.6/32, id: 1, row status: Active
Owner: LDP, Stale: NO, Action-type: Redirect to LSP, Exp-bits: 0x0, Incoming DSCP: none
Tunnel id: 0, Protected LSP id: 0, Description: N/A
Matched bytes:0, pkts:0, TX bytes:0, Pushed pkts:0
Primary: Cross connect ix: 1, in intf: - in label: 0 out-segment ix: 1
Owner: LDP, Persistent: No, Admin Status: Up, Oper Status: Up
Out-segment with ix: 1, owner: LDP, Stale: NO, out intf: eth5, out label: 3
Nexthop addr: 33.1.1.161 cross connect ix: 1, op code: Push

Primary FTN entry with FEC: 7.7.7.7/32, id: 10, row status: Active
Owner: LDP, Stale: NO, Action-type: Redirect to LSP, Exp-bits: 0x0, Incoming DSCP: none
Tunnel id: 0, Protected LSP id: 0, Description: N/A
Matched bytes:0, pkts:0, TX bytes:0, Pushed pkts:0
Primary: Cross connect ix: 17, in intf: - in label: 0 out-segment ix: 11
Owner: LDP, Persistent: No, Admin Status: Up, Oper Status: Up
Out-segment with ix: 11, owner: LDP, Stale: NO, out intf: eth5, out label: 24336
Nexthop addr: 33.1.1.161 cross connect ix: 17, op code: Push

Primary FTN entry with FEC: 7.7.7.7/32, id: 28, row status: Active
Owner: BGP, Stale: NO, Action-type: Redirect to LSP, Exp-bits: 0x0, Incoming DSCP: none
Tunnel id: 0, Protected LSP id: 0, Description: N/A
Matched bytes:0, pkts:0, TX bytes:0, Pushed pkts:0
Primary: Cross connect ix: 23, in intf: - in label: 0 out-segment ix: 16
Owner: BGP, Persistent: No, Admin Status: Down, Oper Status: Down
Out-segment with ix: 16, owner: BGP, Stale: NO, out intf: eth5, out label: 24960
Nexthop addr: 7.7.7.7 cross connect ix: 23, op code: Push

Primary FTN entry with FEC: 8.8.8.8/32, id: 14, row status: Active
Owner: LDP, Stale: NO, Action-type: Redirect to LSP, Exp-bits: 0x0, Incoming DSCP: none
Tunnel id: 0, Protected LSP id: 0, Description: N/A
Matched bytes:0, pkts:0, TX bytes:0, Pushed pkts:0
Primary: Cross connect ix: 11, in intf: - in label: 0 out-segment ix: 8
Owner: LDP, Persistent: No, Admin Status: Up, Oper Status: Up
Out-segment with ix: 8, owner: LDP, Stale: NO, out intf: eth7, out label: 24336

Nexthop addr: 29.1.1.159 cross connect ix: 11, op code: Push

Primary FTN entry with FEC: 9.9.9.9/32, id: 24, row status: Active

Owner: LDP, Stale: NO, Action-type: Redirect to LSP, Exp-bits: 0x0, Incoming DSCP:
none

Tunnel id: 0, Protected LSP id: 0, Description: N/A

Matched bytes:0, pkts:0, TX bytes:0, Pushed pkts:0

Primary: Cross connect ix: 7, in intf: - in label: 0 out-segment ix: 6

Owner: LDP, Persistent: No, Admin Status: Up, Oper Status: Up

Out-segment with ix: 6, owner: LDP, Stale: NO, out intf: eth7, out label: 24323

Nexthop addr: 29.1.1.159 cross connect ix: 7, op code: Push

Primary FTN entry with FEC: 10.10.10.10/32, id: 16, row status: Active

Owner: LDP, Stale: NO, Action-type: Redirect to LSP, Exp-bits: 0x0, Incoming DSCP:
none

Tunnel id: 0, Protected LSP id: 0, Description: N/A

Matched bytes:0, pkts:0, TX bytes:0, Pushed pkts:0

Primary: Cross connect ix: 9, in intf: - in label: 0 out-segment ix: 7

Owner: LDP, Persistent: No, Admin Status: Up, Oper Status: Up

Out-segment with ix: 7, owner: LDP, Stale: NO, out intf: eth7, out label: 24331

Nexthop addr: 29.1.1.159 cross connect ix: 9, op code: Push

Primary FTN entry with FEC: 11.11.11.11/32, id: 17, row status: Active

Owner: LDP, Stale: NO, Action-type: Redirect to LSP, Exp-bits: 0x0, Incoming DSCP:
none

Tunnel id: 0, Protected LSP id: 0, Description: N/A

Matched bytes:0, pkts:0, TX bytes:0, Pushed pkts:0

Primary: Cross connect ix: 13, in intf: - in label: 0 out-segment ix: 9

Owner: LDP, Persistent: No, Admin Status: Up, Oper Status: Up

Out-segment with ix: 9, owner: LDP, Stale: NO, out intf: eth7, out label: 24342

Nexthop addr: 29.1.1.159 cross connect ix: 13, op code: Push

Primary FTN entry with FEC: 13.13.13.13/32, id: 11, row status: Active

Owner: LDP, Stale: NO, Action-type: Redirect to LSP, Exp-bits: 0x0, Incoming DSCP:
none

Tunnel id: 0, Protected LSP id: 0, Description: N/A

Matched bytes:0, pkts:0, TX bytes:0, Pushed pkts:0

Primary: Cross connect ix: 19, in intf: - in label: 0 out-segment ix: 12

Owner: LDP, Persistent: No, Admin Status: Up, Oper Status: Up

Out-segment with ix: 12, owner: LDP, Stale: NO, out intf: eth5, out label: 24342

Nexthop addr: 33.1.1.161 cross connect ix: 19, op code: Push

Primary FTN entry with FEC: 13.13.13.13/32, id: 15, row status: Active

Owner: BGP, Stale: NO, Action-type: Redirect to LSP, Exp-bits: 0x0, Incoming DSCP:
none

Tunnel id: 0, Protected LSP id: 0, Description: N/A

BGP IPv4 Additional Paths Configuration

Matched bytes:0, pkts:0, TX bytes:0, Pushed pkts:0
Primary: Cross connect ix: 5, in intf: - in label: 0 out-segment ix: 5
Owner: BGP, Persistent: No, Admin Status: Down, Oper Status: Down
Out-segment with ix: 5, owner: BGP, Stale: NO, out intf: eth5, out label: 24960
Nexthop addr: 13.13.13.13 cross connect ix: 5, op code: Push

Primary FTN entry with FEC: 14.14.14.14/32, id: 27, row status: Active
Owner: BGP, Stale: NO, Action-type: Redirect to LSP, Exp-bits: 0x0, Incoming DSCP:
none
Tunnel id: 0, Protected LSP id: 0, Description: N/A
Matched bytes:0, pkts:0, TX bytes:0, Pushed pkts:0
Primary: Cross connect ix: 22, in intf: - in label: 0 out-segment ix: 15
Owner: BGP, Persistent: No, Admin Status: Up, Oper Status: Up
Out-segment with ix: 15, owner: BGP, Stale: NO, out intf: eth7, out label: 24961
Nexthop addr: 3.3.3.3 cross connect ix: 22, op code: Push and Lookup

Primary FTN entry with FEC: 15.15.15.15/32, id: 8, row status: Active
Owner: LDP, Stale: NO, Action-type: Redirect to LSP, Exp-bits: 0x0, Incoming DSCP:
none
Tunnel id: 0, Protected LSP id: 0, Description: N/A
Matched bytes:0, pkts:0, TX bytes:0, Pushed pkts:0
Primary: Cross connect ix: 2, in intf: - in label: 0 out-segment ix: 2
Owner: LDP, Persistent: No, Admin Status: Up, Oper Status: Up
Out-segment with ix: 2, owner: LDP, Stale: NO, out intf: eth5, out label: 24322
Nexthop addr: 33.1.1.161 cross connect ix: 2, op code: Push

Primary FTN entry with FEC: 15.15.15.15/32, id: 26, row status: Active
Owner: BGP, Stale: NO, Action-type: Redirect to LSP, Exp-bits: 0x0, Incoming DSCP:
none
Tunnel id: 0, Protected LSP id: 0, Description: N/A
Matched bytes:0, pkts:0, TX bytes:0, Pushed pkts:0
Primary: Cross connect ix: 21, in intf: - in label: 0 out-segment ix: 14
Owner: BGP, Persistent: No, Admin Status: Down, Oper Status: Down
Out-segment with ix: 14, owner: BGP, Stale: NO, out intf: eth5, out label: 24960
Nexthop addr: 15.15.15.15 cross connect ix: 21, op code: Push

Primary FTN entry with FEC: 22.1.1.0/24, id: 18, row status: Active
Owner: LDP, Stale: NO, Action-type: Redirect to LSP, Exp-bits: 0x0, Incoming DSCP:
none
Tunnel id: 0, Protected LSP id: 0, Description: N/A
Matched bytes:0, pkts:0, TX bytes:0, Pushed pkts:0
Primary: Cross connect ix: 4, in intf: - in label: 0 out-segment ix: 4
Owner: LDP, Persistent: No, Admin Status: Up, Oper Status: Up
Out-segment with ix: 4, owner: LDP, Stale: NO, out intf: eth7, out label: 3
Nexthop addr: 29.1.1.159 cross connect ix: 4, op code: Push

Primary FTN entry with FEC: 24.1.1.0/24, id: 19, row status: Active
Owner: LDP, Stale: NO, Action-type: Redirect to LSP, Exp-bits: 0x0, Incoming DSCP:
none
Tunnel id: 0, Protected LSP id: 0, Description: N/A
Matched bytes:0, pkts:0, TX bytes:0, Pushed pkts:0
Primary: Cross connect ix: 4, in intf: - in label: 0 out-segment ix: 4
Owner: LDP, Persistent: No, Admin Status: Up, Oper Status: Up
Out-segment with ix: 4, owner: LDP, Stale: NO, out intf: eth7, out label: 3
Nexthop addr: 29.1.1.159 cross connect ix: 4, op code: Push

Primary FTN entry with FEC: 25.1.1.0/24, id: 20, row status: Active
Owner: LDP, Stale: NO, Action-type: Redirect to LSP, Exp-bits: 0x0, Incoming DSCP:
none
Tunnel id: 0, Protected LSP id: 0, Description: N/A
Matched bytes:0, pkts:0, TX bytes:0, Pushed pkts:0
Primary: Cross connect ix: 4, in intf: - in label: 0 out-segment ix: 4
Owner: LDP, Persistent: No, Admin Status: Up, Oper Status: Up
Out-segment with ix: 4, owner: LDP, Stale: NO, out intf: eth7, out label: 3
Nexthop addr: 29.1.1.159 cross connect ix: 4, op code: Push

Primary FTN entry with FEC: 26.1.1.0/24, id: 2, row status: Active
Owner: LDP, Stale: NO, Action-type: Redirect to LSP, Exp-bits: 0x0, Incoming DSCP:
none
Tunnel id: 0, Protected LSP id: 0, Description: N/A
Matched bytes:0, pkts:0, TX bytes:0, Pushed pkts:0
Primary: Cross connect ix: 1, in intf: - in label: 0 out-segment ix: 1
Owner: LDP, Persistent: No, Admin Status: Up, Oper Status: Up
Out-segment with ix: 1, owner: LDP, Stale: NO, out intf: eth5, out label: 3
Nexthop addr: 33.1.1.161 cross connect ix: 1, op code: Push

Primary FTN entry with FEC: 27.1.1.0/24, id: 21, row status: Active
Owner: LDP, Stale: NO, Action-type: Redirect to LSP, Exp-bits: 0x0, Incoming DSCP:
none
Tunnel id: 0, Protected LSP id: 0, Description: N/A
Matched bytes:0, pkts:0, TX bytes:0, Pushed pkts:0
Primary: Cross connect ix: 4, in intf: - in label: 0 out-segment ix: 4
Owner: LDP, Persistent: No, Admin Status: Up, Oper Status: Up
Out-segment with ix: 4, owner: LDP, Stale: NO, out intf: eth7, out label: 3
Nexthop addr: 29.1.1.159 cross connect ix: 4, op code: Push

Primary FTN entry with FEC: 28.1.1.0/24, id: 3, row status: Active
Owner: LDP, Stale: NO, Action-type: Redirect to LSP, Exp-bits: 0x0, Incoming DSCP:
none
Tunnel id: 0, Protected LSP id: 0, Description: N/A
Matched bytes:0, pkts:0, TX bytes:0, Pushed pkts:0
Primary: Cross connect ix: 1, in intf: - in label: 0 out-segment ix: 1
Owner: LDP, Persistent: No, Admin Status: Up, Oper Status: Up

BGP IPv4 Additional Paths Configuration

Out-segment with ix: 1, owner: LDP, Stale: NO, out intf: eth5, out label: 3
Nexthop addr: 33.1.1.161 cross connect ix: 1, op code: Push

Primary FTN entry with FEC: 30.1.1.0/24, id: 22, row status: Active
Owner: LDP, Stale: NO, Action-type: Redirect to LSP, Exp-bits: 0x0, Incoming DSCP:
none

Tunnel id: 0, Protected LSP id: 0, Description: N/A

Matched bytes:0, pkts:0, TX bytes:0, Pushed pkts:0

Primary: Cross connect ix: 4, in intf: - in label: 0 out-segment ix: 4

Owner: LDP, Persistent: No, Admin Status: Up, Oper Status: Up

Out-segment with ix: 4, owner: LDP, Stale: NO, out intf: eth7, out label: 3

Nexthop addr: 29.1.1.159 cross connect ix: 4, op code: Push

Primary FTN entry with FEC: 32.1.1.0/24, id: 4, row status: Active
Owner: LDP, Stale: NO, Action-type: Redirect to LSP, Exp-bits: 0x0, Incoming DSCP:
none

Tunnel id: 0, Protected LSP id: 0, Description: N/A

Matched bytes:0, pkts:0, TX bytes:0, Pushed pkts:0

Primary: Cross connect ix: 1, in intf: - in label: 0 out-segment ix: 1

Owner: LDP, Persistent: No, Admin Status: Up, Oper Status: Up

Out-segment with ix: 1, owner: LDP, Stale: NO, out intf: eth5, out label: 3

Nexthop addr: 33.1.1.161 cross connect ix: 1, op code: Push

Primary FTN entry with FEC: 40.1.1.0/24, id: 23, row status: Active
Owner: LDP, Stale: NO, Action-type: Redirect to LSP, Exp-bits: 0x0, Incoming DSCP:
none

Tunnel id: 0, Protected LSP id: 0, Description: N/A

Matched bytes:0, pkts:0, TX bytes:0, Pushed pkts:0

Primary: Cross connect ix: 4, in intf: - in label: 0 out-segment ix: 4

Owner: LDP, Persistent: No, Admin Status: Up, Oper Status: Up

Out-segment with ix: 4, owner: LDP, Stale: NO, out intf: eth7, out label: 3

Nexthop addr: 29.1.1.159 cross connect ix: 4, op code: Push

Primary FTN entry with FEC: 42.1.1.0/24, id: 5, row status: Active
Owner: LDP, Stale: NO, Action-type: Redirect to LSP, Exp-bits: 0x0, Incoming DSCP:
none

Tunnel id: 0, Protected LSP id: 0, Description: N/A

Matched bytes:0, pkts:0, TX bytes:0, Pushed pkts:0

Primary: Cross connect ix: 1, in intf: - in label: 0 out-segment ix: 1

Owner: LDP, Persistent: No, Admin Status: Up, Oper Status: Up

Out-segment with ix: 1, owner: LDP, Stale: NO, out intf: eth5, out label: 3

Nexthop addr: 33.1.1.161 cross connect ix: 1, op code: Push

Primary FTN entry with FEC: 50.1.1.0/24, id: 6, row status: Active
Owner: LDP, Stale: NO, Action-type: Redirect to LSP, Exp-bits: 0x0, Incoming DSCP:
none

```
Tunnel id: 0, Protected LSP id: 0, Description: N/A
  Matched bytes:0, pkts:0, TX bytes:0, Pushed pkts:0
Primary: Cross connect ix: 1, in intf: - in label: 0 out-segment ix: 1
  Owner: LDP, Persistent: No, Admin Status: Up, Oper Status: Up
  Out-segment with ix: 1, owner: LDP, Stale: NO, out intf: eth5, out label: 3
  Nexthop addr: 33.1.1.161          cross connect ix: 1, op code: Push

Primary FTN entry with FEC: 60.1.1.0/24, id: 7, row status: Active
  Owner: LDP, Stale: NO, Action-type: Redirect to LSP, Exp-bits: 0x0, Incoming DSCP:
  none
  Tunnel id: 0, Protected LSP id: 0, Description: N/A
  Matched bytes:0, pkts:0, TX bytes:0, Pushed pkts:0
Primary: Cross connect ix: 1, in intf: - in label: 0 out-segment ix: 1
  Owner: LDP, Persistent: No, Admin Status: Up, Oper Status: Up
  Out-segment with ix: 1, owner: LDP, Stale: NO, out intf: eth5, out label: 3
  Nexthop addr: 33.1.1.161          cross connect ix: 1, op code: Push

BR7#show ip bgp labeled-unicast 1.1.1.1/32
BGP routing table entry for 1.1.1.1/32
Paths: (3 available, best #1, table Default-IP-Routing-Table)
  Advertised to non peer-group peers:
  7.7.7.7 15.15.15.15
Local
  3.3.3.3 (metric 12) from 3.3.3.3 (10.12.28.158)
  Origin IGP, metric 0, localpref 100, label    24960, Out-label    24960, In-label
NA , valid, internal, best
  Originator: 10.12.28.156, Cluster list: 10.12.28.158
  rx path_id: -1      tx path_id: 1
  Advertised to non peer-group peers:
  13.13.13.13
  Last update: Mon Aug  6 00:10:31 2018

Local
  8.8.8.8 (metric 12) from 8.8.8.8 (10.12.28.165)
  Origin IGP, metric 0, localpref 100, label    24960, Out-label    24960, In-label
NA , valid, internal, add-path
  Originator: 10.12.28.156, Cluster list: 10.12.28.165
  rx path_id: -1      tx path_id: 0
  Advertised to non peer-group peers:
  13.13.13.13
  Last update: Mon Aug  6 00:10:29 2018

Local
  9.9.9.9 (metric 12) from 9.9.9.9 (10.12.28.166)
  Origin IGP, metric 0, localpref 100, label    24961, Out-label    24961, In-label
NA , valid, internal, add-path
  Originator: 10.12.28.156, Cluster list: 10.12.28.166
  rx path_id: 0       tx path_id: 2
  Advertised to non peer-group peers:
```

BGP IPv4 Additional Paths Configuration

13.13.13.13

Last update: Mon Aug 6 00:10:37 2018

BR7#

AGN4#show ip bgp labeled-unicast all

Status codes: s suppressed, d damped, h history, a add-path, * valid, > best, i - internal, S - stale

Network	Next Hop	In Label	Out Label
*>i 1.1.1.1/32	3.3.3.3	-	24960
* i	3.3.3.3	-	24960
* i	3.3.3.3	-	24960
* i	3.3.3.3	-	24960
* i	8.8.8.8	-	24960
* i	8.8.8.8	-	24960
* i	8.8.8.8	-	24960
* i	8.8.8.8	-	24960
* i	9.9.9.9	-	24961
* i	9.9.9.9	-	24961
* i	9.9.9.9	-	24961
*>i 7.7.7.7/32	7.7.7.7	-	24960
* i	7.7.7.7	-	24960
* i	7.7.7.7	-	24960
* i	7.7.7.7	-	24960
*> 13.13.13.13/32	0.0.0.0	24960(eth6)	-
*>i 14.14.14.14/32	3.3.3.3	-	24961
* i	3.3.3.3	-	24961
* i	3.3.3.3	-	24961
* i	3.3.3.3	-	24961
* i	8.8.8.8	-	24961
* i	8.8.8.8	-	24961
* i	8.8.8.8	-	24961
* i	9.9.9.9	-	24960
* i	9.9.9.9	-	24960
* i	9.9.9.9	-	24960
* i	9.9.9.9	-	24960
*>i 15.15.15.15/32	15.15.15.15	-	24960
* i	15.15.15.15	-	24960
* i	15.15.15.15	-	24960
* i	15.15.15.15	-	24960

AGN4#

AGN4#show ip bgp labeled-unicast all summary

BGP router identifier 10.12.28.170, local AS number 100

BGP table version is 7

1 BGP AS-PATH entries

0 BGP community entries

Neighbor	V	AS	MsgRcv	MsgSen	TblVer	InQ	OutQ	Up/Down	State/ PfxRcd
----------	---	----	--------	--------	--------	-----	------	---------	------------------

5.5.5.5 8	4	100	609	603	7	0	0	05:00:20
10.10.10.10 8	4	100	608	603	7	0	0	05:00:22
11.11.11.11 6	4	100	607	602	7	0	0	05:00:00
12.12.12.12 8	4	100	609	603	7	0	0	05:00:29

Total number of neighbors 4

Total number of Established sessions 4

AGN4#

AGN4#show ip bgp labeled-unicast 1.1.1.1/32

BGP routing table entry for 1.1.1.1/32

Paths: (11 available, best #1, table Default-IP-Routing-Table)

Not advertised to any peer

Local

3.3.3.3 (metric 20) from 5.5.5.5 (10.12.28.160)

Origin IGP, metric 0, localpref 100, label 24960, Out-label 24960, In-label NA, valid, internal, best

Originator: 10.12.28.158, Cluster list: 10.12.28.160 10.12.28.158

rx path_id: 1 tx path_id: -1

Not advertised to any peer

Last update: Mon Aug 6 00:10:36 2018

Local

3.3.3.3 (metric 20) from 10.10.10.10 (10.12.28.167)

Origin IGP, metric 0, localpref 100, label 24960, Out-label 24960, In-label NA, valid, internal

Originator: 10.12.28.158, Cluster list: 10.12.28.167 10.12.28.158

rx path_id: 0 tx path_id: -1

Not advertised to any peer

Last update: Mon Aug 6 00:10:34 2018

Local

3.3.3.3 (metric 20) from 11.11.11.11 (10.12.28.168)

Origin IGP, metric 0, localpref 100, label 24960, Out-label 24960, In-label NA, valid, internal

Originator: 10.12.28.158, Cluster list: 10.12.28.168 10.12.28.158

rx path_id: 0 tx path_id: -1

Not advertised to any peer

Last update: Mon Aug 6 00:10:56 2018

Local

3.3.3.3 (metric 20) from 12.12.12.12 (10.12.28.169)

Origin IGP, metric 0, localpref 100, label 24960, Out-label 24960, In-label NA, valid, internal

Originator: 10.12.28.158, Cluster list: 10.12.28.169 10.12.28.158

rx path_id: 1 tx path_id: -1

Not advertised to any peer

Last update: Mon Aug 6 00:10:31 2018

Local

```
8.8.8.8 (metric 20) from 5.5.5.5 (10.12.28.160)
  Origin IGP, metric 0, localpref 100, label 24960, Out-label 24960, In-label
NA , valid, internal
  Originator: 10.12.28.165, Cluster list: 10.12.28.160 10.12.28.165
  rx path_id: 0      tx path_id: -1
  Not advertised to any peer
  Last update: Mon Aug 6 00:10:40 2018
```

Local

```
8.8.8.8 (metric 20) from 10.10.10.10 (10.12.28.167)
  Origin IGP, metric 0, localpref 100, label 24960, Out-label 24960, In-label
NA , valid, internal
  Originator: 10.12.28.165, Cluster list: 10.12.28.167 10.12.28.165
  rx path_id: 1      tx path_id: -1
  Not advertised to any peer
  Last update: Mon Aug 6 00:10:38 2018
```

Local

```
8.8.8.8 (metric 20) from 11.11.11.11 (10.12.28.168)
  Origin IGP, metric 0, localpref 100, label 24960, Out-label 24960, In-label
NA , valid, internal
  Originator: 10.12.28.165, Cluster list: 10.12.28.168 10.12.28.165
  rx path_id: 2      tx path_id: -1
  Not advertised to any peer
  Last update: Mon Aug 6 00:11:08 2018
```

Local

```
8.8.8.8 (metric 20) from 12.12.12.12 (10.12.28.169)
  Origin IGP, metric 0, localpref 100, label 24960, Out-label 24960, In-label
NA , valid, internal
  Originator: 10.12.28.165, Cluster list: 10.12.28.169 10.12.28.165
  rx path_id: 0      tx path_id: -1
  Not advertised to any peer
  Last update: Mon Aug 6 00:10:31 2018
```

Local

```
9.9.9.9 (metric 20) from 5.5.5.5 (10.12.28.160)
  Origin IGP, metric 0, localpref 100, label 24961, Out-label 24961, In-label
NA , valid, internal
  Originator: 10.12.28.166, Cluster list: 10.12.28.160 10.12.28.166
  rx path_id: 2      tx path_id: -1
  Not advertised to any peer
  Last update: Mon Aug 6 00:10:40 2018
```

Local

```
9.9.9.9 (metric 20) from 10.10.10.10 (10.12.28.167)
  Origin IGP, metric 0, localpref 100, label 24961, Out-label 24961, In-label
NA , valid, internal
  Originator: 10.12.28.166, Cluster list: 10.12.28.167 10.12.28.166
  rx path_id: 2      tx path_id: -1
```

Not advertised to any peer
Last update: Mon Aug 6 00:10:54 2018

Local

9.9.9.9 (metric 20) from 12.12.12.12 (10.12.28.169)
Origin IGP, metric 0, localpref 100, label 24961, Out-label 24961, In-label
NA , valid, internal
Originator: 10.12.28.166, Cluster list: 10.12.28.169 10.12.28.166
rx path_id: 2 tx path_id: -1
Not advertised to any peer
Last update: Mon Aug 6 00:10:43 2018

AGN4#show mpls ftn-table

Primary FTN entry with FEC: 1.1.1.1/32, id: 19, row status: Active
Owner: BGP, Stale: NO, Action-type: Redirect to LSP, Exp-bits: 0x0, Incoming DSCP:
none
Tunnel id: 0, Protected LSP id: 0, Description: N/A
Matched bytes:0, pkts:0, TX bytes:0, Pushed pkts:0
Primary: Cross connect ix: 14, in intf: - in label: 0 out-segment ix: 13
Owner: BGP, Persistent: No, Admin Status: Up, Oper Status: Up
Out-segment with ix: 13, owner: BGP, Stale: NO, out intf: eth6, out label: 24960
Nexthop addr: 3.3.3.3 cross connect ix: 14, op code: Push and Lookup

Primary FTN entry with FEC: 3.3.3.3/32, id: 1, row status: Active
Owner: LDP, Stale: NO, Action-type: Redirect to LSP, Exp-bits: 0x0, Incoming DSCP:
none
Tunnel id: 0, Protected LSP id: 0, Description: N/A
Matched bytes:0, pkts:0, TX bytes:0, Pushed pkts:0
Primary: Cross connect ix: 2, in intf: - in label: 0 out-segment ix: 1
Owner: LDP, Persistent: No, Admin Status: Up, Oper Status: Up
Out-segment with ix: 1, owner: LDP, Stale: NO, out intf: eth6, out label: 24325
Nexthop addr: 32.1.1.161 cross connect ix: 2, op code: Push

Primary FTN entry with FEC: 5.5.5.5/32, id: 2, row status: Active
Owner: LDP, Stale: NO, Action-type: Redirect to LSP, Exp-bits: 0x0, Incoming DSCP:
none
Tunnel id: 0, Protected LSP id: 0, Description: N/A
Matched bytes:0, pkts:0, TX bytes:0, Pushed pkts:0
Primary: Cross connect ix: 3, in intf: - in label: 0 out-segment ix: 2
Owner: LDP, Persistent: No, Admin Status: Up, Oper Status: Up
Out-segment with ix: 2, owner: LDP, Stale: NO, out intf: eth6, out label: 24331
Nexthop addr: 32.1.1.161 cross connect ix: 3, op code: Push

Primary FTN entry with FEC: 6.6.6.6/32, id: 3, row status: Active
Owner: LDP, Stale: NO, Action-type: Redirect to LSP, Exp-bits: 0x0, Incoming DSCP:
none
Tunnel id: 0, Protected LSP id: 0, Description: N/A
Matched bytes:0, pkts:0, TX bytes:0, Pushed pkts:0

BGP IPv4 Additional Paths Configuration

Primary: Cross connect ix: 4, in intf: - in label: 0 out-segment ix: 3
Owner: LDP, Persistent: No, Admin Status: Up, Oper Status: Up
Out-segment with ix: 3, owner: LDP, Stale: NO, out intf: eth6, out label: 3
Nexthop addr: 32.1.1.161 cross connect ix: 4, op code: Push

Primary FTN entry with FEC: 7.7.7.7/32, id: 4, row status: Active
Owner: LDP, Stale: NO, Action-type: Redirect to LSP, Exp-bits: 0x0, Incoming DSCP:
none

Tunnel id: 0, Protected LSP id: 0, Description: N/A
Matched bytes:0, pkts:0, TX bytes:0, Pushed pkts:0
Primary: Cross connect ix: 5, in intf: - in label: 0 out-segment ix: 4
Owner: LDP, Persistent: No, Admin Status: Up, Oper Status: Up
Out-segment with ix: 4, owner: LDP, Stale: NO, out intf: eth6, out label: 24334
Nexthop addr: 32.1.1.161 cross connect ix: 5, op code: Push

Primary FTN entry with FEC: 7.7.7.7/32, id: 20, row status: Active
Owner: BGP, Stale: NO, Action-type: Redirect to LSP, Exp-bits: 0x0, Incoming DSCP:
none

Tunnel id: 0, Protected LSP id: 0, Description: N/A
Matched bytes:0, pkts:0, TX bytes:0, Pushed pkts:0
Primary: Cross connect ix: 15, in intf: - in label: 0 out-segment ix: 14
Owner: BGP, Persistent: No, Admin Status: Down, Oper Status: Down
Out-segment with ix: 14, owner: BGP, Stale: NO, out intf: eth6, out label: 24960
Nexthop addr: 7.7.7.7 cross connect ix: 15, op code: Push

Primary FTN entry with FEC: 8.8.8.8/32, id: 5, row status: Active
Owner: LDP, Stale: NO, Action-type: Redirect to LSP, Exp-bits: 0x0, Incoming DSCP:
none

Tunnel id: 0, Protected LSP id: 0, Description: N/A
Matched bytes:0, pkts:0, TX bytes:0, Pushed pkts:0
Primary: Cross connect ix: 6, in intf: - in label: 0 out-segment ix: 5
Owner: LDP, Persistent: No, Admin Status: Up, Oper Status: Up
Out-segment with ix: 5, owner: LDP, Stale: NO, out intf: eth6, out label: 24327
Nexthop addr: 32.1.1.161 cross connect ix: 6, op code: Push

Primary FTN entry with FEC: 9.9.9.9/32, id: 6, row status: Active
Owner: LDP, Stale: NO, Action-type: Redirect to LSP, Exp-bits: 0x0, Incoming DSCP:
none

Tunnel id: 0, Protected LSP id: 0, Description: N/A
Matched bytes:0, pkts:0, TX bytes:0, Pushed pkts:0
Primary: Cross connect ix: 7, in intf: - in label: 0 out-segment ix: 6
Owner: LDP, Persistent: No, Admin Status: Up, Oper Status: Up
Out-segment with ix: 6, owner: LDP, Stale: NO, out intf: eth6, out label: 24329
Nexthop addr: 32.1.1.161 cross connect ix: 7, op code: Push

Primary FTN entry with FEC: 10.10.10.10/32, id: 7, row status: Active

Owner: LDP, Stale: NO, Action-type: Redirect to LSP, Exp-bits: 0x0, Incoming DSCP: none
Tunnel id: 0, Protected LSP id: 0, Description: N/A
Matched bytes:0, pkts:0, TX bytes:0, Pushed pkts:0
Primary: Cross connect ix: 8, in intf: - in label: 0 out-segment ix: 7
Owner: LDP, Persistent: No, Admin Status: Up, Oper Status: Up
Out-segment with ix: 7, owner: LDP, Stale: NO, out intf: eth6, out label: 24323
Nexthop addr: 32.1.1.161 cross connect ix: 8, op code: Push

Primary FTN entry with FEC: 11.11.11.11/32, id: 8, row status: Active
Owner: LDP, Stale: NO, Action-type: Redirect to LSP, Exp-bits: 0x0, Incoming DSCP: none
Tunnel id: 0, Protected LSP id: 0, Description: N/A
Matched bytes:0, pkts:0, TX bytes:0, Pushed pkts:0
Primary: Cross connect ix: 11, in intf: - in label: 0 out-segment ix: 10
Owner: LDP, Persistent: No, Admin Status: Up, Oper Status: Up
Out-segment with ix: 10, owner: LDP, Stale: NO, out intf: eth6, out label: 24348
Nexthop addr: 32.1.1.161 cross connect ix: 11, op code: Push

Primary FTN entry with FEC: 12.12.12.12/32, id: 9, row status: Active
Owner: LDP, Stale: NO, Action-type: Redirect to LSP, Exp-bits: 0x0, Incoming DSCP: none
Tunnel id: 0, Protected LSP id: 0, Description: N/A
Matched bytes:0, pkts:0, TX bytes:0, Pushed pkts:0
Primary: Cross connect ix: 9, in intf: - in label: 0 out-segment ix: 8
Owner: LDP, Persistent: No, Admin Status: Up, Oper Status: Up
Out-segment with ix: 8, owner: LDP, Stale: NO, out intf: eth6, out label: 24320
Nexthop addr: 32.1.1.161 cross connect ix: 9, op code: Push

Primary FTN entry with FEC: 14.14.14.14/32, id: 21, row status: Active
Owner: BGP, Stale: NO, Action-type: Redirect to LSP, Exp-bits: 0x0, Incoming DSCP: none
Tunnel id: 0, Protected LSP id: 0, Description: N/A
Matched bytes:0, pkts:0, TX bytes:0, Pushed pkts:0
Primary: Cross connect ix: 16, in intf: - in label: 0 out-segment ix: 15
Owner: BGP, Persistent: No, Admin Status: Up, Oper Status: Up
Out-segment with ix: 15, owner: BGP, Stale: NO, out intf: eth6, out label: 24961
Nexthop addr: 3.3.3.3 cross connect ix: 16, op code: Push and Lookup

Primary FTN entry with FEC: 15.15.15.15/32, id: 10, row status: Active
Owner: LDP, Stale: NO, Action-type: Redirect to LSP, Exp-bits: 0x0, Incoming DSCP: none
Tunnel id: 0, Protected LSP id: 0, Description: N/A
Matched bytes:0, pkts:0, TX bytes:0, Pushed pkts:0
Primary: Cross connect ix: 10, in intf: - in label: 0 out-segment ix: 9
Owner: LDP, Persistent: No, Admin Status: Up, Oper Status: Up
Out-segment with ix: 9, owner: LDP, Stale: NO, out intf: eth6, out label: 24321

BGP IPv4 Additional Paths Configuration

Nexthop addr: 32.1.1.161 cross connect ix: 10, op code: Push

Primary FTN entry with FEC: 15.15.15.15/32, id: 18, row status: Active
Owner: BGP, Stale: NO, Action-type: Redirect to LSP, Exp-bits: 0x0, Incoming DSCP:
none
Tunnel id: 0, Protected LSP id: 0, Description: N/A
 Matched bytes:0, pkts:0, TX bytes:0, Pushed pkts:0
Primary: Cross connect ix: 13, in intf: - in label: 0 out-segment ix: 12
 Owner: BGP, Persistent: No, Admin Status: Down, Oper Status: Down
 Out-segment with ix: 12, owner: BGP, Stale: NO, out intf: eth6, out label: 24960
 Nexthop addr: 15.15.15.15 cross connect ix: 13, op code: Push

Primary FTN entry with FEC: 26.1.1.0/24, id: 11, row status: Active
Owner: LDP, Stale: NO, Action-type: Redirect to LSP, Exp-bits: 0x0, Incoming DSCP:
none
Tunnel id: 0, Protected LSP id: 0, Description: N/A
 Matched bytes:0, pkts:0, TX bytes:0, Pushed pkts:0
Primary: Cross connect ix: 4, in intf: - in label: 0 out-segment ix: 3
 Owner: LDP, Persistent: No, Admin Status: Up, Oper Status: Up
 Out-segment with ix: 3, owner: LDP, Stale: NO, out intf: eth6, out label: 3
 Nexthop addr: 32.1.1.161 cross connect ix: 4, op code: Push

Primary FTN entry with FEC: 28.1.1.0/24, id: 12, row status: Active
Owner: LDP, Stale: NO, Action-type: Redirect to LSP, Exp-bits: 0x0, Incoming DSCP:
none
Tunnel id: 0, Protected LSP id: 0, Description: N/A
 Matched bytes:0, pkts:0, TX bytes:0, Pushed pkts:0
Primary: Cross connect ix: 4, in intf: - in label: 0 out-segment ix: 3
 Owner: LDP, Persistent: No, Admin Status: Up, Oper Status: Up
 Out-segment with ix: 3, owner: LDP, Stale: NO, out intf: eth6, out label: 3
 Nexthop addr: 32.1.1.161 cross connect ix: 4, op code: Push

Primary FTN entry with FEC: 33.1.1.0/24, id: 13, row status: Active
Owner: LDP, Stale: NO, Action-type: Redirect to LSP, Exp-bits: 0x0, Incoming DSCP:
none
Tunnel id: 0, Protected LSP id: 0, Description: N/A
 Matched bytes:0, pkts:0, TX bytes:0, Pushed pkts:0
Primary: Cross connect ix: 4, in intf: - in label: 0 out-segment ix: 3
 Owner: LDP, Persistent: No, Admin Status: Up, Oper Status: Up
 Out-segment with ix: 3, owner: LDP, Stale: NO, out intf: eth6, out label: 3
 Nexthop addr: 32.1.1.161 cross connect ix: 4, op code: Push

Primary FTN entry with FEC: 42.1.1.0/24, id: 14, row status: Active
Owner: LDP, Stale: NO, Action-type: Redirect to LSP, Exp-bits: 0x0, Incoming DSCP:
none
Tunnel id: 0, Protected LSP id: 0, Description: N/A

Matched bytes:0, pkts:0, TX bytes:0, Pushed pkts:0
 Primary: Cross connect ix: 4, in intf: - in label: 0 out-segment ix: 3
 Owner: LDP, Persistent: No, Admin Status: Up, Oper Status: Up
 Out-segment with ix: 3, owner: LDP, Stale: NO, out intf: eth6, out label: 3
 Nexthop addr: 32.1.1.161 cross connect ix: 4, op code: Push

Primary FTN entry with FEC: 50.1.1.0/24, id: 15, row status: Active
 Owner: LDP, Stale: NO, Action-type: Redirect to LSP, Exp-bits: 0x0, Incoming DSCP:
 none

Tunnel id: 0, Protected LSP id: 0, Description: N/A
 Matched bytes:0, pkts:0, TX bytes:0, Pushed pkts:0
 Primary: Cross connect ix: 4, in intf: - in label: 0 out-segment ix: 3
 Owner: LDP, Persistent: No, Admin Status: Up, Oper Status: Up
 Out-segment with ix: 3, owner: LDP, Stale: NO, out intf: eth6, out label: 3
 Nexthop addr: 32.1.1.161 cross connect ix: 4, op code: Push

Primary FTN entry with FEC: 60.1.1.0/24, id: 16, row status: Active
 Owner: LDP, Stale: NO, Action-type: Redirect to LSP, Exp-bits: 0x0, Incoming DSCP:
 none

Tunnel id: 0, Protected LSP id: 0, Description: N/A
 Matched bytes:0, pkts:0, TX bytes:0, Pushed pkts:0
 Primary: Cross connect ix: 4, in intf: - in label: 0 out-segment ix: 3
 Owner: LDP, Persistent: No, Admin Status: Up, Oper Status: Up
 Out-segment with ix: 3, owner: LDP, Stale: NO, out intf: eth6, out label: 3
 Nexthop addr: 32.1.1.161 cross connect ix: 4, op code: Push

AGN4#

AGN2#show ip bgp labeled-unicast all

Status codes: s suppressed, d damped, h history, a add-path, * valid, > best, i -
 internal, S - stale

Network	Next Hop	In Label	Out Label
*>i 1.1.1.1/32	3.3.3.3	-	24960
* i	3.3.3.3	-	24960
* i	3.3.3.3	-	24960
* i	3.3.3.3	-	24960
* i	8.8.8.8	-	24960
* i	8.8.8.8	-	24960
* i	8.8.8.8	-	24960
* i	9.9.9.9	-	24961
* i	9.9.9.9	-	24961
*> 7.7.7.7/32	0.0.0.0	24960 (eth2)	-
*>i 13.13.13.13/32	13.13.13.13	-	24960
* i	13.13.13.13	-	24960
* i	13.13.13.13	-	24960
* i	13.13.13.13	-	24960
*>i 14.14.14.14/32	3.3.3.3	-	24961

BGP IPv4 Additional Paths Configuration

```
* i          3.3.3.3          -          24961
* i          3.3.3.3          -          24961
* i          3.3.3.3          -          24961
* i          8.8.8.8          -          24961
* i          8.8.8.8          -          24961
* i          9.9.9.9          -          24960
* i          9.9.9.9          -          24960
* i          9.9.9.9          -          24960
* i          9.9.9.9          -          24960
*>i 15.15.15.15/32 15.15.15.15 -          24960
* i          15.15.15.15     -          24960
* i          15.15.15.15     -          24960
* i          15.15.15.15     -          24960
```

```
AGN2#show ip bgp labeled-unicast all summary
BGP router identifier 10.12.28.162, local AS number 100
BGP table version is 8
1 BGP AS-PATH entries
0 BGP community entries
```

Neighbor PfxRcd	V	AS	MsgRcv	MsgSen	TblVer	InQ	OutQ	Up/Down	State/
5.5.5.5 8	4	100	579	573	8	0	0	04:45:08	
10.10.10.10 8	4	100	578	573	8	0	0	04:45:07	
11.11.11.11 6	4	100	578	573	8	0	0	04:45:05	
12.12.12.12 4	4	100	578	573	8	0	0	04:45:07	

Total number of neighbors 4

Total number of Established sessions 4

```
AGN2#
AGN2#show ip bgp labeled-unicast 1.1.1.1/32
BGP routing table entry for 1.1.1.1/32
Paths: (9 available, best #1, table Default-IP-Routing-Table)
  Not advertised to any peer
  Local
    3.3.3.3 (metric 20) from 5.5.5.5 (10.12.28.160)
      Origin IGP, metric 0, localpref 100, label 24960, Out-label 24960, In-label
NA , valid, internal, best
      Originator: 10.12.28.158, Cluster list: 10.12.28.160 10.12.28.158
      rx path_id: 1      tx path_id: -1
      Not advertised to any peer
      Last update: Mon Aug 6 00:10:32 2018

  Local
    3.3.3.3 (metric 20) from 10.10.10.10 (10.12.28.167)
      Origin IGP, metric 0, localpref 100, label 24960, Out-label 24960, In-label
NA , valid, internal
      Originator: 10.12.28.158, Cluster list: 10.12.28.167 10.12.28.158
      rx path_id: 0      tx path_id: -1
```

Not advertised to any peer
Last update: Mon Aug 6 00:10:34 2018

Local

3.3.3.3 (metric 20) from 11.11.11.11 (10.12.28.168)
Origin IGP, metric 0, localpref 100, label 24960, Out-label 24960, In-label
NA , valid, internal
Originator: 10.12.28.158, Cluster list: 10.12.28.168 10.12.28.158
rx path_id: 0 tx path_id: -1
Not advertised to any peer
Last update: Mon Aug 6 00:10:32 2018

Local

3.3.3.3 (metric 20) from 12.12.12.12 (10.12.28.169)
Origin IGP, metric 0, localpref 100, label 24960, Out-label 24960, In-label
NA , valid, internal
Originator: 10.12.28.158, Cluster list: 10.12.28.169 10.12.28.158
Not advertised to any peer
Last update: Mon Aug 6 00:10:34 2018

Local

8.8.8.8 (metric 20) from 5.5.5.5 (10.12.28.160)
Origin IGP, metric 0, localpref 100, label 24960, Out-label 24960, In-label
NA , valid, internal, backup
Originator: 10.12.28.165, Cluster list: 10.12.28.160 10.12.28.165
rx path_id: 0 tx path_id: -1
Not advertised to any peer
Last update: Mon Aug 6 00:10:28 2018

Local

8.8.8.8 (metric 20) from 10.10.10.10 (10.12.28.167)
Origin IGP, metric 0, localpref 100, label 24960, Out-label 24960, In-label
NA , valid, internal
Originator: 10.12.28.165, Cluster list: 10.12.28.167 10.12.28.165
rx path_id: 1 tx path_id: -1
Not advertised to any peer
Last update: Mon Aug 6 00:10:37 2018

Local

8.8.8.8 (metric 20) from 11.11.11.11 (10.12.28.168)
Origin IGP, metric 0, localpref 100, label 24960, Out-label 24960, In-label
NA , valid, internal
Originator: 10.12.28.165, Cluster list: 10.12.28.168 10.12.28.165
rx path_id: 2 tx path_id: -1
Not advertised to any peer
Last update: Mon Aug 6 00:11:07 2018

Local

9.9.9.9 (metric 20) from 5.5.5.5 (10.12.28.160)
Origin IGP, metric 0, localpref 100, label 24961, Out-label 24961, In-label
NA , valid, internal
Originator: 10.12.28.166, Cluster list: 10.12.28.160 10.12.28.166

BGP IPv4 Additional Paths Configuration

```
rx path_id: 2      tx path_id: -1
Not advertised to any peer
Last update: Mon Aug 6 00:10:39 2018
```

Local

```
9.9.9.9 (metric 20) from 10.10.10.10 (10.12.28.167)
Origin IGP, metric 0, localpref 100, label 24961, Out-label 24961, In-label
NA , valid, internal
Originator: 10.12.28.166, Cluster list: 10.12.28.167 10.12.28.166
rx path_id: 2      tx path_id: -1
Not advertised to any peer
Last update: Mon Aug 6 00:10:52 2018
```

BGP PIC Enabled

AGN2#

AGN2#sh mpls ftn-table

```
Primary FTN entry with FEC: 1.1.1.1/32, id: 19, row status: Active
Owner: BGP, Stale: NO, Action-type: Redirect to LSP, Exp-bits: 0x0, Incoming DSCP:
none
Tunnel id: 0, Protected LSP id: 0, Description: N/A
Matched bytes:0, pkts:0, TX bytes:0, Pushed pkts:0
Primary: Cross connect ix: 13, in intf: - in label: 0 out-segment ix: 12
Owner: BGP, Persistent: No, Admin Status: Up, Oper Status: Up
Out-segment with ix: 12, owner: BGP, Stale: NO, out intf: eth2, out label: 24960
Nexthop addr: 3.3.3.3 cross connect ix: 13, op code: Push and Lookup
```

```
Non-primary FTN entry with FEC: 1.1.1.1/32, id: 24, row status: Active
Owner: BGP, Stale: NO, Action-type: Redirect to LSP, Exp-bits: 0x0, Incoming DSCP:
none
Tunnel id: 0, Protected LSP id: 0, Description: N/A
Matched bytes:0, pkts:0, TX bytes:0, Pushed pkts:0
Primary: Cross connect ix: 17, in intf: - in label: 0 out-segment ix: 16
Owner: BGP, Persistent: No, Admin Status: Up, Oper Status: Up
Out-segment with ix: 16, owner: BGP, Stale: NO, out intf: eth2, out label: 24960
Nexthop addr: 8.8.8.8 cross connect ix: 17, op code: Push and Lookup
```

```
Primary FTN entry with FEC: 3.3.3.3/32, id: 1, row status: Active
Owner: LDP, Stale: NO, Action-type: Redirect to LSP, Exp-bits: 0x0, Incoming DSCP:
none
Tunnel id: 0, Protected LSP id: 0, Description: N/A
Matched bytes:0, pkts:0, TX bytes:0, Pushed pkts:0
Primary: Cross connect ix: 2, in intf: - in label: 0 out-segment ix: 1
Owner: LDP, Persistent: No, Admin Status: Up, Oper Status: Up
Out-segment with ix: 1, owner: LDP, Stale: NO, out intf: eth2, out label: 24325
Nexthop addr: 60.1.1.161 cross connect ix: 2, op code: Push
```

Primary FTN entry with FEC: 5.5.5.5/32, id: 2, row status: Active
Owner: LDP, Stale: NO, Action-type: Redirect to LSP, Exp-bits: 0x0, Incoming DSCP:
none
Tunnel id: 0, Protected LSP id: 0, Description: N/A
Matched bytes:0, pkts:0, TX bytes:0, Pushed pkts:0
Primary: Cross connect ix: 3, in intf: - in label: 0 out-segment ix: 2
Owner: LDP, Persistent: No, Admin Status: Up, Oper Status: Up
Out-segment with ix: 2, owner: LDP, Stale: NO, out intf: eth2, out label: 24331
Nexthop addr: 60.1.1.161 cross connect ix: 3, op code: Push

Primary FTN entry with FEC: 6.6.6.6/32, id: 3, row status: Active
Owner: LDP, Stale: NO, Action-type: Redirect to LSP, Exp-bits: 0x0, Incoming DSCP:
none
Tunnel id: 0, Protected LSP id: 0, Description: N/A
Matched bytes:0, pkts:0, TX bytes:0, Pushed pkts:0
Primary: Cross connect ix: 4, in intf: - in label: 0 out-segment ix: 3
Owner: LDP, Persistent: No, Admin Status: Up, Oper Status: Up
Out-segment with ix: 3, owner: LDP, Stale: NO, out intf: eth2, out label: 3
Nexthop addr: 60.1.1.161 cross connect ix: 4, op code: Push

Primary FTN entry with FEC: 8.8.8.8/32, id: 4, row status: Active
Owner: LDP, Stale: NO, Action-type: Redirect to LSP, Exp-bits: 0x0, Incoming DSCP:
none
Tunnel id: 0, Protected LSP id: 0, Description: N/A
Matched bytes:0, pkts:0, TX bytes:0, Pushed pkts:0
Primary: Cross connect ix: 5, in intf: - in label: 0 out-segment ix: 4
Owner: LDP, Persistent: No, Admin Status: Up, Oper Status: Up
Out-segment with ix: 4, owner: LDP, Stale: NO, out intf: eth2, out label: 24327
Nexthop addr: 60.1.1.161 cross connect ix: 5, op code: Push

Primary FTN entry with FEC: 9.9.9.9/32, id: 5, row status: Active
Owner: LDP, Stale: NO, Action-type: Redirect to LSP, Exp-bits: 0x0, Incoming DSCP:
none
Tunnel id: 0, Protected LSP id: 0, Description: N/A
Matched bytes:0, pkts:0, TX bytes:0, Pushed pkts:0
Primary: Cross connect ix: 6, in intf: - in label: 0 out-segment ix: 5
Owner: LDP, Persistent: No, Admin Status: Up, Oper Status: Up
Out-segment with ix: 5, owner: LDP, Stale: NO, out intf: eth2, out label: 24329
Nexthop addr: 60.1.1.161 cross connect ix: 6, op code: Push

Primary FTN entry with FEC: 10.10.10.10/32, id: 6, row status: Active
Owner: LDP, Stale: NO, Action-type: Redirect to LSP, Exp-bits: 0x0, Incoming DSCP:
none
Tunnel id: 0, Protected LSP id: 0, Description: N/A
Matched bytes:0, pkts:0, TX bytes:0, Pushed pkts:0
Primary: Cross connect ix: 7, in intf: - in label: 0 out-segment ix: 6
Owner: LDP, Persistent: No, Admin Status: Up, Oper Status: Up

BGP IPv4 Additional Paths Configuration

Out-segment with ix: 6, owner: LDP, Stale: NO, out intf: eth2, out label: 24323
Nexthop addr: 60.1.1.161 cross connect ix: 7, op code: Push

Primary FTN entry with FEC: 11.11.11.11/32, id: 7, row status: Active
Owner: LDP, Stale: NO, Action-type: Redirect to LSP, Exp-bits: 0x0, Incoming DSCP:
none
Tunnel id: 0, Protected LSP id: 0, Description: N/A
Matched bytes:0, pkts:0, TX bytes:0, Pushed pkts:0
Primary: Cross connect ix: 11, in intf: - in label: 0 out-segment ix: 10
Owner: LDP, Persistent: No, Admin Status: Up, Oper Status: Up
Out-segment with ix: 10, owner: LDP, Stale: NO, out intf: eth2, out label: 24345
Nexthop addr: 60.1.1.161 cross connect ix: 11, op code: Push

Primary FTN entry with FEC: 12.12.12.12/32, id: 8, row status: Active
Owner: LDP, Stale: NO, Action-type: Redirect to LSP, Exp-bits: 0x0, Incoming DSCP:
none
Tunnel id: 0, Protected LSP id: 0, Description: N/A
Matched bytes:0, pkts:0, TX bytes:0, Pushed pkts:0
Primary: Cross connect ix: 8, in intf: - in label: 0 out-segment ix: 7
Owner: LDP, Persistent: No, Admin Status: Up, Oper Status: Up
Out-segment with ix: 7, owner: LDP, Stale: NO, out intf: eth2, out label: 24320
Nexthop addr: 60.1.1.161 cross connect ix: 8, op code: Push

Primary FTN entry with FEC: 13.13.13.13/32, id: 9, row status: Active
Owner: LDP, Stale: NO, Action-type: Redirect to LSP, Exp-bits: 0x0, Incoming DSCP:
none
Tunnel id: 0, Protected LSP id: 0, Description: N/A
Matched bytes:0, pkts:0, TX bytes:0, Pushed pkts:0
Primary: Cross connect ix: 10, in intf: - in label: 0 out-segment ix: 9
Owner: LDP, Persistent: No, Admin Status: Up, Oper Status: Up
Out-segment with ix: 9, owner: LDP, Stale: NO, out intf: eth2, out label: 24339
Nexthop addr: 60.1.1.161 cross connect ix: 10, op code: Push

Primary FTN entry with FEC: 13.13.13.13/32, id: 17, row status: Active
Owner: BGP, Stale: NO, Action-type: Redirect to LSP, Exp-bits: 0x0, Incoming DSCP:
none
Tunnel id: 0, Protected LSP id: 0, Description: N/A
Matched bytes:0, pkts:0, TX bytes:0, Pushed pkts:0
Primary: Cross connect ix: 12, in intf: - in label: 0 out-segment ix: 11
Owner: BGP, Persistent: No, Admin Status: Down, Oper Status: Down
Out-segment with ix: 11, owner: BGP, Stale: NO, out intf: eth2, out label: 24960
Nexthop addr: 13.13.13.13 cross connect ix: 12, op code: Push

Primary FTN entry with FEC: 14.14.14.14/32, id: 22, row status: Active
Owner: BGP, Stale: NO, Action-type: Redirect to LSP, Exp-bits: 0x0, Incoming DSCP:
none

Tunnel id: 0, Protected LSP id: 0, Description: N/A
Matched bytes:0, pkts:0, TX bytes:0, Pushed pkts:0
Primary: Cross connect ix: 16, in intf: - in label: 0 out-segment ix: 15
Owner: BGP, Persistent: No, Admin Status: Up, Oper Status: Up
Out-segment with ix: 15, owner: BGP, Stale: NO, out intf: eth2, out label: 24961
Nexthop addr: 3.3.3.3 cross connect ix: 16, op code: Push and Lookup

Non-primary FTN entry with FEC: 14.14.14.14/32, id: 25, row status: Active
Owner: BGP, Stale: NO, Action-type: Redirect to LSP, Exp-bits: 0x0, Incoming DSCP:
none
Tunnel id: 0, Protected LSP id: 0, Description: N/A
Matched bytes:0, pkts:0, TX bytes:0, Pushed pkts:0
Primary: Cross connect ix: 18, in intf: - in label: 0 out-segment ix: 17
Owner: BGP, Persistent: No, Admin Status: Up, Oper Status: Up
Out-segment with ix: 17, owner: BGP, Stale: NO, out intf: eth2, out label: 24961
Nexthop addr: 8.8.8.8 cross connect ix: 18, op code: Push and Lookup

Primary FTN entry with FEC: 15.15.15.15/32, id: 10, row status: Active
Owner: LDP, Stale: NO, Action-type: Redirect to LSP, Exp-bits: 0x0, Incoming DSCP:
none
Tunnel id: 0, Protected LSP id: 0, Description: N/A
Matched bytes:0, pkts:0, TX bytes:0, Pushed pkts:0
Primary: Cross connect ix: 9, in intf: - in label: 0 out-segment ix: 8
Owner: LDP, Persistent: No, Admin Status: Up, Oper Status: Up
Out-segment with ix: 8, owner: LDP, Stale: NO, out intf: eth2, out label: 24321
Nexthop addr: 60.1.1.161 cross connect ix: 9, op code: Push

Primary FTN entry with FEC: 15.15.15.15/32, id: 26, row status: Active
Owner: BGP, Stale: NO, Action-type: Redirect to LSP, Exp-bits: 0x0, Incoming DSCP:
none
Tunnel id: 0, Protected LSP id: 0, Description: N/A
Matched bytes:0, pkts:0, TX bytes:0, Pushed pkts:0
Primary: Cross connect ix: 19, in intf: - in label: 0 out-segment ix: 18
Owner: BGP, Persistent: No, Admin Status: Down, Oper Status: Down
Out-segment with ix: 18, owner: BGP, Stale: NO, out intf: eth2, out label: 24960
Nexthop addr: 15.15.15.15 cross connect ix: 19, op code: Push

Primary FTN entry with FEC: 26.1.1.0/24, id: 11, row status: Active
Owner: LDP, Stale: NO, Action-type: Redirect to LSP, Exp-bits: 0x0, Incoming DSCP:
none
Tunnel id: 0, Protected LSP id: 0, Description: N/A
Matched bytes:0, pkts:0, TX bytes:0, Pushed pkts:0
Primary: Cross connect ix: 4, in intf: - in label: 0 out-segment ix: 3
Owner: LDP, Persistent: No, Admin Status: Up, Oper Status: Up
Out-segment with ix: 3, owner: LDP, Stale: NO, out intf: eth2, out label: 3
Nexthop addr: 60.1.1.161 cross connect ix: 4, op code: Push

BGP IPv4 Additional Paths Configuration

Primary FTN entry with FEC: 28.1.1.0/24, id: 12, row status: Active
Owner: LDP, Stale: NO, Action-type: Redirect to LSP, Exp-bits: 0x0, Incoming DSCP: none
Tunnel id: 0, Protected LSP id: 0, Description: N/A
Matched bytes:0, pkts:0, TX bytes:0, Pushed pkts:0
Primary: Cross connect ix: 4, in intf: - in label: 0 out-segment ix: 3
Owner: LDP, Persistent: No, Admin Status: Up, Oper Status: Up
Out-segment with ix: 3, owner: LDP, Stale: NO, out intf: eth2, out label: 3
Nexthop addr: 60.1.1.161 cross connect ix: 4, op code: Push

Primary FTN entry with FEC: 32.1.1.0/24, id: 13, row status: Active
Owner: LDP, Stale: NO, Action-type: Redirect to LSP, Exp-bits: 0x0, Incoming DSCP: none
Tunnel id: 0, Protected LSP id: 0, Description: N/A
Matched bytes:0, pkts:0, TX bytes:0, Pushed pkts:0
Primary: Cross connect ix: 4, in intf: - in label: 0 out-segment ix: 3
Owner: LDP, Persistent: No, Admin Status: Up, Oper Status: Up
Out-segment with ix: 3, owner: LDP, Stale: NO, out intf: eth2, out label: 3
Nexthop addr: 60.1.1.161 cross connect ix: 4, op code: Push

Primary FTN entry with FEC: 33.1.1.0/24, id: 14, row status: Active
Owner: LDP, Stale: NO, Action-type: Redirect to LSP, Exp-bits: 0x0, Incoming DSCP: none
Tunnel id: 0, Protected LSP id: 0, Description: N/A
Matched bytes:0, pkts:0, TX bytes:0, Pushed pkts:0
Primary: Cross connect ix: 4, in intf: - in label: 0 out-segment ix: 3
Owner: LDP, Persistent: No, Admin Status: Up, Oper Status: Up
Out-segment with ix: 3, owner: LDP, Stale: NO, out intf: eth2, out label: 3
Nexthop addr: 60.1.1.161 cross connect ix: 4, op code: Push

Primary FTN entry with FEC: 42.1.1.0/24, id: 15, row status: Active
Owner: LDP, Stale: NO, Action-type: Redirect to LSP, Exp-bits: 0x0, Incoming DSCP: none
Tunnel id: 0, Protected LSP id: 0, Description: N/A
Matched bytes:0, pkts:0, TX bytes:0, Pushed pkts:0
Primary: Cross connect ix: 4, in intf: - in label: 0 out-segment ix: 3
Owner: LDP, Persistent: No, Admin Status: Up, Oper Status: Up
Out-segment with ix: 3, owner: LDP, Stale: NO, out intf: eth2, out label: 3
Nexthop addr: 60.1.1.161 cross connect ix: 4, op code: Push

Primary FTN entry with FEC: 50.1.1.0/24, id: 16, row status: Active
Owner: LDP, Stale: NO, Action-type: Redirect to LSP, Exp-bits: 0x0, Incoming DSCP: none
Tunnel id: 0, Protected LSP id: 0, Description: N/A
Matched bytes:0, pkts:0, TX bytes:0, Pushed pkts:0
Primary: Cross connect ix: 4, in intf: - in label: 0 out-segment ix: 3

Owner: LDP, Persistent: No, Admin Status: Up, Oper Status: Up
 Out-segment with ix: 3, owner: LDP, Stale: NO, out intf: eth2, out label: 3
 Nexthop addr: 60.1.1.161 cross connect ix: 4, op code: Push

AGN2#

AGN5#show ip bgp labeled-unicast all

Status codes: s suppressed, d damped, h history, a add-path, * valid, > best, i - internal, S - stale

Network	Next Hop	In Label	Out Label
*>i 1.1.1.1/32	3.3.3.3	-	24960
* i	3.3.3.3	-	24960
* i	3.3.3.3	-	24960
* i	3.3.3.3	-	24960
*>i 7.7.7.7/32	7.7.7.7	-	24960
* i	7.7.7.7	-	24960
* i	7.7.7.7	-	24960
* i	7.7.7.7	-	24960
*>i 13.13.13.13/32	13.13.13.13	-	24960
* i	13.13.13.13	-	24960
* i	13.13.13.13	-	24960
* i	13.13.13.13	-	24960
*>i 14.14.14.14/32	3.3.3.3	-	24961
* i	8.8.8.8	-	24961
* i	9.9.9.9	-	24960
* i	9.9.9.9	-	24960
*> 15.15.15.15/32	0.0.0.0	24960 (eth7)	-

AGN5#

AGN5#show ip bgp labeled-unicast all summary

BGP router identifier 10.12.28.172, local AS number 100

BGP table version is 8

1 BGP AS-PATH entries

0 BGP community entries

Neighbor PfxRcd	V	AS	MsgRcv	MsgSen	TblVer	InQ	OutQ	Up/Down	State/
5.5.5.5 4	4	100	610	606	8	0	0	05:01:41	
10.10.10.10 4	4	100	609	606	8	0	0	05:01:54	
11.11.11.11 4	4	100	609	606	8	0	0	05:01:39	
12.12.12.12 4	4	100	610	606	8	0	0	05:01:39	

Total number of neighbors 4

Total number of Established sessions 4

AGN5#

BGP IPv4 Additional Paths Configuration

```
AGN5#show ip bgp labeled-unicast 1.1.1.1/32
BGP routing table entry for 1.1.1.1/32
Paths: (4 available, best #1, table Default-IP-Routing-Table)
  Not advertised to any peer
  Local
    3.3.3.3 (metric 20) from 5.5.5.5 (10.12.28.160)
      Origin IGP, metric 0, localpref 100, label    24960, Out-label    24960, In-label
NA , valid, internal, best
      Originator: 10.12.28.158, Cluster list: 10.12.28.160 10.12.28.158
      rx path_id: -1      tx path_id: -1
      Not advertised to any peer
      Last update: Mon Aug  6 00:10:34 2018

  Local
    3.3.3.3 (metric 20) from 10.10.10.10 (10.12.28.167)
      Origin IGP, metric 0, localpref 100, label    24960, Out-label    24960, In-label
NA , valid, internal
      Originator: 10.12.28.158, Cluster list: 10.12.28.167 10.12.28.158
      Not advertised to any peer
      Last update: Mon Aug  6 00:10:32 2018

  Local
    3.3.3.3 (metric 20) from 11.11.11.11 (10.12.28.168)
      Origin IGP, metric 0, localpref 100, label    24960, Out-label    24960, In-label
NA , valid, internal
      Originator: 10.12.28.158, Cluster list: 10.12.28.168 10.12.28.158
      Not advertised to any peer
      Last update: Mon Aug  6 00:10:33 2018

  Local
    3.3.3.3 (metric 20) from 12.12.12.12 (10.12.28.169)
      Origin IGP, metric 0, localpref 100, label    24960, Out-label    24960, In-label
NA , valid, internal
      Originator: 10.12.28.158, Cluster list: 10.12.28.169 10.12.28.158
      Not advertised to any peer
      Last update: Mon Aug  6 00:10:33 2018

BGP PIC Enabled
AGN5#show mpls ftn-table
  Primary FTN entry with FEC: 1.1.1.1/32, id: 19, row status: Active
  Owner: BGP, Stale: NO, Action-type: Redirect to LSP, Exp-bits: 0x0, Incoming DSCP:
none
  Tunnel id: 0, Protected LSP id: 0, Description: N/A
  Matched bytes:0, pkts:0, TX bytes:0, Pushed pkts:0
  Primary: Cross connect ix: 14, in intf: - in label: 0 out-segment ix: 13
  Owner: BGP, Persistent: No, Admin Status: Up, Oper Status: Up
  Out-segment with ix: 13, owner: BGP, Stale: NO, out intf: eth7, out label: 24960
  Nexthop addr: 3.3.3.3      cross connect ix: 14, op code: Push and Lookup
```

Primary FTN entry with FEC: 3.3.3.3/32, id: 11, row status: Active
Owner: LDP, Stale: NO, Action-type: Redirect to LSP, Exp-bits: 0x0, Incoming DSCP:
none
Tunnel id: 0, Protected LSP id: 0, Description: N/A
Matched bytes:0, pkts:0, TX bytes:0, Pushed pkts:0
Primary: Cross connect ix: 4, in intf: - in label: 0 out-segment ix: 4
Owner: LDP, Persistent: No, Admin Status: Up, Oper Status: Up
Out-segment with ix: 4, owner: LDP, Stale: NO, out intf: eth7, out label: 24326
Nexthop addr: 42.1.1.161 cross connect ix: 4, op code: Push

Primary FTN entry with FEC: 5.5.5.5/32, id: 9, row status: Active
Owner: LDP, Stale: NO, Action-type: Redirect to LSP, Exp-bits: 0x0, Incoming DSCP:
none
Tunnel id: 0, Protected LSP id: 0, Description: N/A
Matched bytes:0, pkts:0, TX bytes:0, Pushed pkts:0
Primary: Cross connect ix: 8, in intf: - in label: 0 out-segment ix: 7
Owner: LDP, Persistent: No, Admin Status: Up, Oper Status: Up
Out-segment with ix: 7, owner: LDP, Stale: NO, out intf: eth7, out label: 24333
Nexthop addr: 42.1.1.161 cross connect ix: 8, op code: Push

Primary FTN entry with FEC: 6.6.6.6/32, id: 1, row status: Active
Owner: LDP, Stale: NO, Action-type: Redirect to LSP, Exp-bits: 0x0, Incoming DSCP:
none
Tunnel id: 0, Protected LSP id: 0, Description: N/A
Matched bytes:0, pkts:0, TX bytes:0, Pushed pkts:0
Primary: Cross connect ix: 1, in intf: - in label: 0 out-segment ix: 1
Owner: LDP, Persistent: No, Admin Status: Up, Oper Status: Up
Out-segment with ix: 1, owner: LDP, Stale: NO, out intf: eth7, out label: 3
Nexthop addr: 42.1.1.161 cross connect ix: 1, op code: Push

Primary FTN entry with FEC: 7.7.7.7/32, id: 14, row status: Active
Owner: LDP, Stale: NO, Action-type: Redirect to LSP, Exp-bits: 0x0, Incoming DSCP:
none
Tunnel id: 0, Protected LSP id: 0, Description: N/A
Matched bytes:0, pkts:0, TX bytes:0, Pushed pkts:0
Primary: Cross connect ix: 9, in intf: - in label: 0 out-segment ix: 8
Owner: LDP, Persistent: No, Admin Status: Up, Oper Status: Up
Out-segment with ix: 8, owner: LDP, Stale: NO, out intf: eth7, out label: 24337
Nexthop addr: 42.1.1.161 cross connect ix: 9, op code: Push

Primary FTN entry with FEC: 7.7.7.7/32, id: 21, row status: Active
Owner: BGP, Stale: NO, Action-type: Redirect to LSP, Exp-bits: 0x0, Incoming DSCP:
none
Tunnel id: 0, Protected LSP id: 0, Description: N/A
Matched bytes:0, pkts:0, TX bytes:0, Pushed pkts:0
Primary: Cross connect ix: 15, in intf: - in label: 0 out-segment ix: 14
Owner: BGP, Persistent: No, Admin Status: Down, Oper Status: Down

BGP IPv4 Additional Paths Configuration

Out-segment with ix: 14, owner: BGP, Stale: NO, out intf: eth7, out label: 24960
Nexthop addr: 7.7.7.7 cross connect ix: 15, op code: Push

Primary FTN entry with FEC: 8.8.8.8/32, id: 12, row status: Active
Owner: LDP, Stale: NO, Action-type: Redirect to LSP, Exp-bits: 0x0, Incoming DSCP:
none
Tunnel id: 0, Protected LSP id: 0, Description: N/A
Matched bytes:0, pkts:0, TX bytes:0, Pushed pkts:0
Primary: Cross connect ix: 5, in intf: - in label: 0 out-segment ix: 5
Owner: LDP, Persistent: No, Admin Status: Up, Oper Status: Up
Out-segment with ix: 5, owner: LDP, Stale: NO, out intf: eth7, out label: 24328
Nexthop addr: 42.1.1.161 cross connect ix: 5, op code: Push

Primary FTN entry with FEC: 9.9.9.9/32, id: 13, row status: Active
Owner: LDP, Stale: NO, Action-type: Redirect to LSP, Exp-bits: 0x0, Incoming DSCP:
none
Tunnel id: 0, Protected LSP id: 0, Description: N/A
Matched bytes:0, pkts:0, TX bytes:0, Pushed pkts:0
Primary: Cross connect ix: 6, in intf: - in label: 0 out-segment ix: 6
Owner: LDP, Persistent: No, Admin Status: Up, Oper Status: Up
Out-segment with ix: 6, owner: LDP, Stale: NO, out intf: eth7, out label: 24330
Nexthop addr: 42.1.1.161 cross connect ix: 6, op code: Push

Primary FTN entry with FEC: 10.10.10.10/32, id: 10, row status: Active
Owner: LDP, Stale: NO, Action-type: Redirect to LSP, Exp-bits: 0x0, Incoming DSCP:
none
Tunnel id: 0, Protected LSP id: 0, Description: N/A
Matched bytes:0, pkts:0, TX bytes:0, Pushed pkts:0
Primary: Cross connect ix: 3, in intf: - in label: 0 out-segment ix: 3
Owner: LDP, Persistent: No, Admin Status: Up, Oper Status: Up
Out-segment with ix: 3, owner: LDP, Stale: NO, out intf: eth7, out label: 24324
Nexthop addr: 42.1.1.161 cross connect ix: 3, op code: Push

Primary FTN entry with FEC: 11.11.11.11/32, id: 15, row status: Active
Owner: LDP, Stale: NO, Action-type: Redirect to LSP, Exp-bits: 0x0, Incoming DSCP:
none
Tunnel id: 0, Protected LSP id: 0, Description: N/A
Matched bytes:0, pkts:0, TX bytes:0, Pushed pkts:0
Primary: Cross connect ix: 11, in intf: - in label: 0 out-segment ix: 10
Owner: LDP, Persistent: No, Admin Status: Up, Oper Status: Up
Out-segment with ix: 10, owner: LDP, Stale: NO, out intf: eth7, out label: 24349
Nexthop addr: 42.1.1.161 cross connect ix: 11, op code: Push

Primary FTN entry with FEC: 12.12.12.12/32, id: 2, row status: Active
Owner: LDP, Stale: NO, Action-type: Redirect to LSP, Exp-bits: 0x0, Incoming DSCP:
none

Tunnel id: 0, Protected LSP id: 0, Description: N/A
Matched bytes:0, pkts:0, TX bytes:0, Pushed pkts:0
Primary: Cross connect ix: 2, in intf: - in label: 0 out-segment ix: 2
Owner: LDP, Persistent: No, Admin Status: Up, Oper Status: Up
Out-segment with ix: 2, owner: LDP, Stale: NO, out intf: eth7, out label: 24320
Nexthop addr: 42.1.1.161 cross connect ix: 2, op code: Push

Primary FTN entry with FEC: 13.13.13.13/32, id: 16, row status: Active
Owner: LDP, Stale: NO, Action-type: Redirect to LSP, Exp-bits: 0x0, Incoming DSCP:
none
Tunnel id: 0, Protected LSP id: 0, Description: N/A
Matched bytes:0, pkts:0, TX bytes:0, Pushed pkts:0
Primary: Cross connect ix: 10, in intf: - in label: 0 out-segment ix: 9
Owner: LDP, Persistent: No, Admin Status: Up, Oper Status: Up
Out-segment with ix: 9, owner: LDP, Stale: NO, out intf: eth7, out label: 24343
Nexthop addr: 42.1.1.161 cross connect ix: 10, op code: Push

Primary FTN entry with FEC: 13.13.13.13/32, id: 17, row status: Active
Owner: BGP, Stale: NO, Action-type: Redirect to LSP, Exp-bits: 0x0, Incoming DSCP:
none
Tunnel id: 0, Protected LSP id: 0, Description: N/A
Matched bytes:0, pkts:0, TX bytes:0, Pushed pkts:0
Primary: Cross connect ix: 12, in intf: - in label: 0 out-segment ix: 11
Owner: BGP, Persistent: No, Admin Status: Down, Oper Status: Down
Out-segment with ix: 11, owner: BGP, Stale: NO, out intf: eth7, out label: 24960
Nexthop addr: 13.13.13.13 cross connect ix: 12, op code: Push

Primary FTN entry with FEC: 14.14.14.14/32, id: 20, row status: Active
Owner: BGP, Stale: NO, Action-type: Redirect to LSP, Exp-bits: 0x0, Incoming DSCP:
none
Tunnel id: 0, Protected LSP id: 0, Description: N/A
Matched bytes:0, pkts:0, TX bytes:0, Pushed pkts:0
Primary: Cross connect ix: 16, in intf: - in label: 0 out-segment ix: 15
Owner: BGP, Persistent: No, Admin Status: Up, Oper Status: Up
Out-segment with ix: 15, owner: BGP, Stale: NO, out intf: eth7, out label: 24961
Nexthop addr: 3.3.3.3 cross connect ix: 16, op code: Push and Lookup

Non-primary FTN entry with FEC: 14.14.14.14/32, id: 22, row status: Active
Owner: BGP, Stale: NO, Action-type: Redirect to LSP, Exp-bits: 0x0, Incoming DSCP:
none
Tunnel id: 0, Protected LSP id: 0, Description: N/A
Matched bytes:0, pkts:0, TX bytes:0, Pushed pkts:0
Primary: Cross connect ix: 17, in intf: - in label: 0 out-segment ix: 16
Owner: BGP, Persistent: No, Admin Status: Up, Oper Status: Up
Out-segment with ix: 16, owner: BGP, Stale: NO, out intf: eth7, out label: 24961
Nexthop addr: 8.8.8.8 cross connect ix: 17, op code: Push and Lookup

BGP IPv4 Additional Paths Configuration

Primary FTN entry with FEC: 26.1.1.0/24, id: 3, row status: Active
Owner: LDP, Stale: NO, Action-type: Redirect to LSP, Exp-bits: 0x0, Incoming DSCP: none
Tunnel id: 0, Protected LSP id: 0, Description: N/A
Matched bytes:0, pkts:0, TX bytes:0, Pushed pkts:0
Primary: Cross connect ix: 1, in intf: - in label: 0 out-segment ix: 1
Owner: LDP, Persistent: No, Admin Status: Up, Oper Status: Up
Out-segment with ix: 1, owner: LDP, Stale: NO, out intf: eth7, out label: 3
Nexthop addr: 42.1.1.161 cross connect ix: 1, op code: Push

Primary FTN entry with FEC: 28.1.1.0/24, id: 4, row status: Active
Owner: LDP, Stale: NO, Action-type: Redirect to LSP, Exp-bits: 0x0, Incoming DSCP: none
Tunnel id: 0, Protected LSP id: 0, Description: N/A
Matched bytes:0, pkts:0, TX bytes:0, Pushed pkts:0
Primary: Cross connect ix: 1, in intf: - in label: 0 out-segment ix: 1
Owner: LDP, Persistent: No, Admin Status: Up, Oper Status: Up
Out-segment with ix: 1, owner: LDP, Stale: NO, out intf: eth7, out label: 3
Nexthop addr: 42.1.1.161 cross connect ix: 1, op code: Push

Primary FTN entry with FEC: 32.1.1.0/24, id: 5, row status: Active
Owner: LDP, Stale: NO, Action-type: Redirect to LSP, Exp-bits: 0x0, Incoming DSCP: none
Tunnel id: 0, Protected LSP id: 0, Description: N/A
Matched bytes:0, pkts:0, TX bytes:0, Pushed pkts:0
Primary: Cross connect ix: 1, in intf: - in label: 0 out-segment ix: 1
Owner: LDP, Persistent: No, Admin Status: Up, Oper Status: Up
Out-segment with ix: 1, owner: LDP, Stale: NO, out intf: eth7, out label: 3
Nexthop addr: 42.1.1.161 cross connect ix: 1, op code: Push

Primary FTN entry with FEC: 33.1.1.0/24, id: 6, row status: Active
Owner: LDP, Stale: NO, Action-type: Redirect to LSP, Exp-bits: 0x0, Incoming DSCP: none
Tunnel id: 0, Protected LSP id: 0, Description: N/A
Matched bytes:0, pkts:0, TX bytes:0, Pushed pkts:0
Primary: Cross connect ix: 1, in intf: - in label: 0 out-segment ix: 1
Owner: LDP, Persistent: No, Admin Status: Up, Oper Status: Up
Out-segment with ix: 1, owner: LDP, Stale: NO, out intf: eth7, out label: 3
Nexthop addr: 42.1.1.161 cross connect ix: 1, op code: Push

Primary FTN entry with FEC: 50.1.1.0/24, id: 7, row status: Active
Owner: LDP, Stale: NO, Action-type: Redirect to LSP, Exp-bits: 0x0, Incoming DSCP: none
Tunnel id: 0, Protected LSP id: 0, Description: N/A
Matched bytes:0, pkts:0, TX bytes:0, Pushed pkts:0
Primary: Cross connect ix: 1, in intf: - in label: 0 out-segment ix: 1

Owner: LDP, Persistent: No, Admin Status: Up, Oper Status: Up
Out-segment with ix: 1, owner: LDP, Stale: NO, out intf: eth7, out label: 3
Nexthop addr: 42.1.1.161 cross connect ix: 1, op code: Push

Primary FTN entry with FEC: 60.1.1.0/24, id: 8, row status: Active
Owner: LDP, Stale: NO, Action-type: Redirect to LSP, Exp-bits: 0x0, Incoming DSCP:
none
Tunnel id: 0, Protected LSP id: 0, Description: N/A
Matched bytes:0, pkts:0, TX bytes:0, Pushed pkts:0
Primary: Cross connect ix: 1, in intf: - in label: 0 out-segment ix: 1
Owner: LDP, Persistent: No, Admin Status: Up, Oper Status: Up
Out-segment with ix: 1, owner: LDP, Stale: NO, out intf: eth7, out label: 3
Nexthop addr: 42.1.1.161 cross connect ix: 1, op code: Push

AGN5#

Overview

The Border Gateway Protocol (BGP) ADDPATH feature allows the advertisement of multiple paths through the same peering session for a given prefix without the new paths implicitly replacing any previous paths. This behavior promotes path diversity and reduces the severity of a network failure, thereby improving the control plane convergence in case of network failures.

Normal BGP Behavior

By default, all BGP routers and Route-Reflectors propagate only their best paths over their sessions. In case they advertise any route with the same NLRI as a previously advertised route, the latest one implicitly replaces the previous advertisement, which is known as an Implicit Withdraw. The Implicit Withdraw can achieve better scaling, but at the cost of path diversity.

The use of route-reflectors (or confederations), thus has significant effect on redundancy by hiding alternate paths. Using full-mesh is not an option, so a mechanism is needed to allow the propagation of multiple alternate paths in an RR/Confederation environment. Such mechanism is already available in BGP/MPLS VPN scenarios, where multiple point of attachments for CE sites could utilize different RD values to differentiate the same routes advertised from different connection points. However, a generic solution is required, allowing for advertising multiple alternate paths with IPv4 or any other address-family.

The “Advertisement of Multiple Paths in BGP” or “BGP Add-Path” as the feature is usually called is a BGP extension that allows the advertisement of multiple paths for the same address prefix without the new paths implicitly replacing any previously advertised ones.

BGP Behavior with Additional Paths

The advertisement of multiple paths in BGP is made possible by sending a BGP OPEN message to the neighbor with a BGP capability code of 69, which identifies the BGP ADD-PATH Capability.

Address Family Identifier(AFI)	2 octets
Subsequent Address Family Identifier(SAFI)	1 octet
Send/Receive	1 octet

The send/receive field in the BGP Capability TLV indicates whether for a given <AFI, SAFI>, the sender is able to:

- Receive multiple paths from its peer (value 1)
- Send multiple paths to its peer (value 2), or
- both (value 3)
- Each alternate path is identified by a Path Identifier in addition to the address prefix

Path Identifier	4 octets
-----------------	----------

Length	1 octet
Prefix	variable

In the event of a next-hop failure, the BGP Add-Path feature hence improves the BGP control plane convergence

Topology

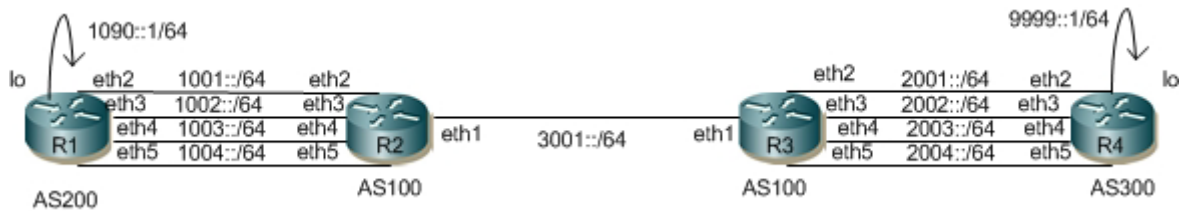

Figure 7-63: BGP4+ additional paths

R1

#configure terminal	Enter the Configure mode.
(config)#interface eth2	Enter interface mode for interface eth2
(config-if)#ipv6 address 1001::1/64	Configure IPv6 address for the interface eth2
(config-if)#exit	Exit the interface mode
(config)#interface eth3	Enter interface mode for interface eth3
(config-if)#ipv6 address 1002::1/64	Configure IPv6 address for the interface eth3
(config-if)#exit	Exit the interface mode
(config)#interface eth4	Enter interface mode for interface eth4
(config-if)#ipv6 address 1003::1/64	Configure IPv6 address for the interface eth4
(config-if)#exit	Exit the interface mode
(config)#interface eth5	Enter interface mode for interface eth5
(config-if)#ipv6 address 1004::1/64	Configure IPv6 address for the interface eth5
(config-if)#exit	Exit the interface mode
(config)#interface lo	Enter interface mode for loopback lo
(config-if)#ipv6 address 1090::1/64	Configure IPv6 address for Loopback interface lo
(config-if)#exit	Exit the interface mode
(config)#router bgp 200	Enter the router bgp mode
(config-router)#neighbor 1001::2 remote-as 100	Specify a neighbor router with peer address and remote-as for BGP peering.
(config-router)#neighbor 1002::2 remote-as 100	Specify a neighbor router with peer address and remote-as for BGP peering.
(config-router)#neighbor 1004::2 remote-as 100	Specify a neighbor router with peer address and remote-as for BGP peering.
(config-router)#neighbor 1003::2 remote-as 100	Specify a neighbor router with peer address and remote-as for BGP peering.
(config-router)#address-family ipv6 unicast	Enter address-family mode for neighbor router session to activate.

(config-router-af)#neighbor 1001::2 activate	Activate the neighbor router with peer address.
(config-router-af)#neighbor 1002::2 activate	Activate the neighbor router with peer address.
(config-router-af)#neighbor 1003::2 activate	Activate the neighbor router with peer address.
(config-router-af)#neighbor 1004::2 activate	Activate the neighbor router with peer address.
(config-router-af)#network 1090::/64	Activate the neighbor router with peer address.
(config-router-af)#exit-address-family	Exit Address Family mode and return to Router mode.
(config-router)#exit	Exit the router BGP mode and enter the config mode
(config)#commit	Apply commit
(config)#exit	Exit the config mode

R2

#configure terminal	Enter the Configure mode.
(config)#interface eth1	Enter interface mode for interface eth1
(config-if)#ipv6 address 3001::1/64	Configure IPv6 address for the interface eth1
(config-if)#ipv6 router ospf area 0	Enable OSPFv3 routing on an interface, and assign the Area ID 0.
(config-if)#exit	Exit the interface mode
(config)#interface eth2	Enter interface mode for interface eth2
(config-if)#ipv6 address 1001::2/64	Configure IPv6 address for the interface eth2
(config-if)#exit	Exit the interface mode
(config)#interface eth3	Enter interface mode for interface eth3
(config-if)#ipv6 address 1002::2/64	Configure IPv6 address for the interface eth3
(config-if)#exit	Exit the interface mode
(config)#interface eth4	Enter interface mode for interface eth4
(config-if)#ipv6 address 1003::2/64	Configure IPv6 address for the interface eth4
(config-if)#exit	Exit the interface mode
(config)#interface eth5	Enter interface mode for interface eth5
(config-if)#ipv6 address 1004::2/64	Configure IPv6 address for the interface eth5
(config-if)#exit	Exit the interface mode
(config)#router bgp 100	Enter the router bgp mode
(config-router)#neighbor 3001::2 remote-as 100	Specify a neighbor router with peer address and remote-as for BGP peering.
(config-router)#neighbor 1001::1 remote-as 200	Specify a neighbor router with peer address and remote-as for BGP peering.
(config-router)#neighbor 1002::1 remote-as 200	Specify a neighbor router with peer address and remote-as for BGP peering.
(config-router)#neighbor 1003::1 remote-as 200	Specify a neighbor router with peer address and remote-as for BGP peering.
(config-router)#neighbor 1004::1 remote-as 200	Specify a neighbor router with peer address and remote-as for BGP peering.
(config-router)#address-family ipv6 unicast	Enter address-family mode for neighbor router session to activate.
(config-router-af)#neighbor 1001::1 activate	Activate the neighbor router with peer address.

BGP4+ Additional Paths Configuration

(config-router-af)#neighbor 1002::1 activate	Activate the neighbor router with peer address.
(config-router-af)#neighbor 1003::1 activate	Activate the neighbor router with peer address.
(config-router-af)#neighbor 1004::1 activate	Activate the neighbor router with peer address.
(config-router-af)#neighbor 3001::2 activate	Activate the neighbor router with peer address.
(config-router-af)#exit-address-family	Exit address family mode.
(config-router)#exit	Exit the router BGP mode and enter the config mode
(config)#router ipv6 ospf	Enter Router OSPFv3 mode.
(config-router)#redistribute connected	Configure Redistribution of Connected networks into OSPF
(config-router)#exit	Exit the router ospf mode and enter the config mode
(config)#commit	Apply commit
(config)#exit	Exit the config mode

R3

#configure terminal	Enter the Configure mode.
(config)#interface eth1	Enter interface mode for interface eth1
(config-if)#ipv6 address 3001::2/64	Configure IPv6 address for the interface eth1
(config-if)#ipv6 router ospf area 0	Enable OSPFv3 routing on an interface, and assign the Area ID 0.
(config-if)#exit	Exit the interface mode
(config)#interface eth2	Enter interface mode for interface eth2
(config-if)#ipv6 address 2001::2/64	Configure IPv6 address for the interface eth2
(config-if)#exit	Exit the interface mode
(config)#interface eth3	Enter interface mode for interface eth3
(config-if)#ipv6 address 2002::2/64	Configure IPv6 address for the interface eth3
(config-if)#exit	Exit the interface mode
(config)#interface eth4	Enter interface mode for interface eth4
(config-if)#ipv6 address 2003::2/64	Configure IPv6 address for the interface eth4
(config-if)#exit	Exit the interface mode
(config)#interface eth5	Enter interface mode for interface eth5
(config-if)#ipv6 address 2004::2/64	Configure IPv6 address for the interface eth5
(config-if)#exit	Exit the interface mode
(config)#router bgp 100	Enter the router bgp mode
(config-router)#neighbor 3001::1 remote-as 100	Specify a neighbor router with peer address and remote-as for BGP peering.
(config-router)#neighbor 2001::1 remote-as 300	Specify a neighbor router with peer address and remote-as for BGP peering.
(config-router)#neighbor 2002::1 remote-as 300	Specify a neighbor router with peer address and remote-as for BGP peering.
(config-router)#neighbor 2003::1 remote-as 300	Specify a neighbor router with peer address and remote-as for BGP peering.
(config-router)#neighbor 2004::1 remote-as 300	Specify a neighbor router with peer address and remote-as for BGP peering.

(config-router)#address-family ipv6 unicast	Enter address-family mode for neighbor router session to activate.
(config-router-af)#neighbor 2001::1 activate	Activate the neighbor router with peer address.
(config-router-af)#neighbor 2002::1 activate	Activate the neighbor router with peer address.
(config-router-af)#neighbor 2003::1 activate	Activate the neighbor router with peer address.
(config-router-af)#neighbor 2004::1 activate	Activate the neighbor router with peer address.
(config-router-af)#neighbor 3001::1 activate	Activate the neighbor router with peer address.
(config-router-af)#exit-address-family	Exit address family mode.
(config-router)#exit	Exit Router BGP mode
(config)#router ipv6 ospf	Enter Router OSPFv3 mode.
(config-router)#redistribute connected	Configure Redistribution of Connected networks into OSPF
(config-router)#exit	Exit the router ospf mode and enter the config mode
(config)#commit	Apply commit
(config)#exit	Exit the config mode

R4

#configure terminal	Enter the Configure mode.
(config)#interface eth2	Enter interface mode for interface eth2
(config-if)#ipv6 address 2001::1/64	Configure IPv6 address for the interface eth2
(config-if)#exit	Exit the interface mode
(config)#interface eth3	Enter interface mode for interface eth3
(config-if)#ipv6 address 2002::1/64	Configure IPv6 address for the interface eth3
(config-if)#exit	Exit the interface mode
(config)#interface eth4	Enter interface mode for interface eth4
(config-if)#ipv6 address 2003::1/64	Configure IPv6 address for the interface eth4
(config-if)#exit	Exit the interface mode
(config)#interface eth5	Enter interface mode for interface eth5
(config-if)#ipv6 address 2004::1/64	Configure IPv6 address for the interface eth5
(config-if)#exit	Exit the interface mode
(config)#interface lo	Enter interface mode for loopback lo
(config-if)#ipv6 address 9999::1/64	Configure IPv6 address for Loopback interface lo
(config-if)#exit	Exit the interface mode
(config)#router bgp 300	Enter the router bgp mode
(config-router)#neighbor 2001::2 remote-as 100	Specify a neighbor router with peer address and remote-as for BGP peering.
(config-router)#neighbor 2002::2 remote-as 100	Specify a neighbor router with peer address and remote-as for BGP peering.
(config-router)#neighbor 2003::2 remote-as 100	Specify a neighbor router with peer address and remote-as for BGP peering.
(config-router)#neighbor 2004::2 remote-as 100	Specify a neighbor router with peer address and remote-as for BGP peering.

(config-router)#address-family ipv6 unicast	Enter address-family mode for neighbor router session to activate.
(config-router-af)#neighbor 2001::2 activate	Activate the neighbor router with peer address.
(config-router-af)#neighbor 2002::2 activate	Activate the neighbor router with peer address.
(config-router-af)#neighbor 2003::2 activate	Activate the neighbor router with peer address.
(config-router-af)#neighbor 2004::2 activate	Activate the neighbor router with peer address.
(config-router-af)#network 9999::/64	Activate the neighbor router with peer address.
(config-router-af)#exit-address-family	Exit Address Family mode and return to Router mode.
(config-router)#exit	Exit the router BGP mode and enter the config mode
(config)#commit	Apply commit
(config)#exit	Exit the config mode

Additional Paths at the Global Level

R2

#configure terminal	Enter the Configure mode.
(config)#router bgp 100	Enter BGP router mode
(config-router)#address-family ipv6 unicast	Enter address-family mode for neighbor router session to activate.
(config-router-af)#bgp additional-paths send	Configure R2 to send additional paths to all iBGP neighbors
(config-router-af)#bgp additional-paths select all	Configure R2 to select all available paths to send to all iBGP neighbors
(config-router-af)#exit-address-family	Exit Address Family mode and return to Router mode.
(config-router)#exit	Exit the router BGP mode and enter the config mode
(config)#commit	Apply commit
(config)#exit	Exit the config mode

R3

#configure terminal	Enter the Configure mode.
(config)#router bgp 100	Enter BGP router mode
(config-router)#address-family ipv6 unicast	Enter address-family mode for neighbor router session to activate.
(config-router-af)#bgp additional-paths receive	Configure R3 to receive additional paths from all iBGP neighbors
(config-router-af)#exit-address-family	Exit Address Family mode and return to Router mode.
(config-router)#exit	Exit the router BGP mode and enter the config mode
(config)#commit	Apply commit
(config)#exit	Exit the config mode

Additional Paths at the Neighbor Level

R2

#configure terminal	Enter the Configure mode.
(config)#router bgp 100	Enter BGP router mode
(config-router)#address-family ipv6 unicast	Enter address-family mode for neighbor router session to activate.
(config-router-af)#neighbor 3001::2 additional-paths send	Configure R2 to send additional paths to all iBGP neighbors
(config-router-af)#neighbor 3001::2 advertise additional-paths all	Configure R2 to select all available paths to send to all iBGP neighbors
(config-router-af)#exit-address-family	Exit Address Family mode and return to Router mode.
(config-router)#exit	Exit the router BGP mode and enter the config mode
(config)#commit	Apply commit
(config)#exit	Exit the config mode

R3

#configure terminal	Enter the Configure mode.
(config)#router bgp 100	Enter BGP router mode
(config-router)#address-family ipv6 unicast	Enter address-family mode for neighbor router session to activate.
(config-router-af)#neighbor 3001::1 additional-paths receive	Configure R3 to receive additional paths from all iBGP neighbors
(config-router-af)#exit-address-family	Exit Address Family mode and return to Router mode.
(config-router)#exit	Exit the router BGP mode and enter the config mode
(config)#commit	Apply commit
(config)#exit	Exit the config mode

Validation

R2

```
#show bgp ipv6 neighbors 3001::2
BGP neighbor is 3001::2, remote AS 100, local AS 100, internal link
  BGP version 4, remote router ID 10.12.5.92
  BGP state = Established, up for 00:14:55
  Last read 00:14:55, hold time is 90, keepalive interval is 30 seconds
  Neighbor capabilities:
    Route refresh: advertised and received (old and new)
    Address family IPv4 Unicast: advertised and received
    Address family IPv6 Unicast: advertised and received
  Received 536 messages, 50 notifications, 0 in queue
  Sent 611 messages, 3 notifications, 0 in queue
  Route refresh request: received 0, sent 0
  Minimum time between advertisement runs is 5 seconds
```

BGP4+ Additional Paths Configuration

For address family: IPv4 Unicast
BGP table version 1, neighbor version 1
Index 5, Offset 0, Mask 0x20
Community attribute sent to this neighbor (both)
0 accepted prefixes
0 announced prefixes

For address family: IPv6 Unicast
BGP table version 38, neighbor version 38
Index 5, Offset 0, Mask 0x20
AF-dependant capabilities:
Add-Path Send Capability : advertised
Add-Path Receive Capability : received
Community attribute sent to this neighbor (both)
1 accepted prefixes
4 announced prefixes

Connections established 3; dropped 2
Local host: 3001::1, Local port: 38451
Foreign host: 3001::2, Foreign port: 179
Nexthop: 10.12.5.93
Nexthop global: 3001::1
Nexthop local: fe80::5054:ff:fe19:1758
BGP connection: shared network
Last Reset: 00:15:00, due to BGP Notification received
Notification Error Message: (Cease/Other Configuration Change.)

#show bgp ipv6 summary
BGP router identifier 10.12.5.93, local AS number 100
BGP table version is 38
2 BGP AS-PATH entries
0 BGP community entries

Neighbor Down State/PfxRcd	V	AS	MsgRcv	MsgSen	TblVer	InQ	OutQ	Up/
1001::1 04:13:51	1	4	200	517	532	38	0	0
1002::1 04:13:51	1	4	200	520	533	38	0	0
1003::1 04:13:51	1	4	200	519	532	38	0	0
1004::1 04:13:51	1	4	200	518	532	38	0	0
3001::2 00:15:42	1	4	100	588	616	38	0	0

Total number of neighbors 5

Total number of Established sessions 5

#show bgp ipv6
BGP table version is 38, local router ID is 10.12.5.93
Status codes: s suppressed, d damped, h history, * valid, > best, i -
internal, l - labeled
S Stale
Origin codes: i - IGP, e - EGP, ? - incomplete

Network	Next Hop	Metric	LocPrf	Weight	Path
---------	----------	--------	--------	--------	------

```

*> 1090::/64      1001::1(fe80::5054:ff:fe9c:b7e6)
                                0          100          0          200 i
*                1002::1(fe80::5054:ff:fe0d:f5e)
                                0          100          0          200 i
*                1003::1(fe80::5054:ff:fec7:1940)
                                0          100          0          200 i
*                1004::1(fe80::5054:ff:fe62:70d8)
                                0          100          0          200 i
*>i 9999::/64      2001::1
i                                0          100          0          300

```

Total number of prefixes 2

```
#show bgp ipv6 1090::/64
```

```
BGP routing table entry for 1090::/64
```

```
Paths: (4 available, best #1, table Default-IP-Routing-Table)
```

```
  Advertised to non peer-group peers:
```

```
  1002::1 1003::1 1004::1
```

```
  200
```

```
    1001::1(fe80::5054:ff:fe9c:b7e6) from 1001::1 (10.12.5.144)
```

```
    (fe80::5054:ff:fe9c:b7e6)
```

```
    Origin IGP, metric 0, localpref 100, valid, external, best
```

```
    rx path_id: -1      tx path_id: 0
```

```
    Advertised to non peer-group peers:
```

```
    3001::2
```

```
    Last update: Wed Jan 11 03:53:54 2017
```

```
  200
```

```
    1002::1(fe80::5054:ff:fe0d:f5e) from 1002::1 (10.12.5.144)
```

```
    (fe80::5054:ff:fe0d:f5e)
```

```
    Origin IGP, metric 0, localpref 100, valid, external
```

```
    rx path_id: -1      tx path_id: 1
```

```
    Advertised to non peer-group peers:
```

```
    3001::2
```

```
    Last update: Wed Jan 11 03:54:01 2017
```

```
  200
```

```
    1003::1(fe80::5054:ff:fec7:1940) from 1003::1 (10.12.5.144)
```

```
    (fe80::5054:ff:fec7:1940)
```

```
    Origin IGP, metric 0, localpref 100, valid, external
```

```
    rx path_id: -1      tx path_id: 2
```

```
    Advertised to non peer-group peers:
```

```
    3001::2
```

```
    Last update: Wed Jan 11 03:53:52 2017
```

```
  200
```

```
    1004::1(fe80::5054:ff:fe62:70d8) from 1004::1 (10.12.5.144)
```

```
    (fe80::5054:ff:fe62:70d8)
```

```
    Origin IGP, metric 0, localpref 100, valid, external
```

```
    rx path_id: -1      tx path_id: 3
```

```
    Advertised to non peer-group peers:
```

```
    3001::2
```

```
    Last update: Wed Jan 11 03:53:48 2017
```

R3

```
#show bgp ipv6 neighbors 3001::1
```

BGP4+ Additional Paths Configuration

```
BGP neighbor is 3001::1, remote AS 100, local AS 100, internal link
BGP version 4, remote router ID 10.12.5.93
BGP state = Established, up for 00:29:37
Last read 00:29:37, hold time is 90, keepalive interval is 30 seconds
Neighbor capabilities:
  Route refresh: advertised and received (old and new)
  Address family IPv4 Unicast: advertised and received
  Address family IPv6 Unicast: advertised and received
Received 518 messages, 2 notifications, 0 in queue
Sent 520 messages, 1 notifications, 0 in queue
Route refresh request: received 0, sent 0
Minimum time between advertisement runs is 5 seconds
For address family: IPv4 Unicast
BGP table version 1, neighbor version 1
Index 5, Offset 0, Mask 0x20
Community attribute sent to this neighbor (both)
0 accepted prefixes
0 announced prefixes
```

```
For address family: IPv6 Unicast
BGP table version 268, neighbor version 268
Index 1, Offset 0, Mask 0x2
AF-dependant capabilities:
  Add-Path Send Capability : received
  Add-Path Receive Capability : advertised
Community attribute sent to this neighbor (both)
4 accepted prefixes
1 announced prefixes
```

```
Connections established 4; dropped 3
Local host: 3001::2, Local port: 179
Foreign host: 3001::1, Foreign port: 38451
Nexthop: 10.12.5.92
Nexthop global: 3001::2
Nexthop local: fe80::5054:ff:fe5d:bb79
BGP connection: shared network
Last Reset: 00:29:37, due to BGP Notification sent
Notification Error Message: (Cease/Other Configuration Change.)
#show bgp ipv6 summary
BGP router identifier 10.12.5.92, local AS number 100
BGP table version is 268
2 BGP AS-PATH entries
0 BGP community entries
```

Neighbor	V	AS	MsgRcv	MsgSen	TblVer	InQ	OutQ	Up/
Down State/PfxRcd								
2001::1	4	300	533	537	268	0	0	
04:16:42	1							
2002::1	4	300	533	536	268	0	0	
04:16:42	1							
2003::1	4	300	537	538	268	0	0	
04:16:42	1							
2004::1	4	300	520	521	268	0	0	
04:16:38	1							
3001::1	4	100	520	521	268	0	0	
00:29:41	4							

```
Total number of neighbors 5
```

Total number of Established sessions 5

#show bgp ipv6

BGP table version is 268, local router ID is 10.12.5.92

Status codes: s suppressed, d damped, h history, * valid, > best, i - internal, l - labeled

S Stale

Origin codes: i - IGP, e - EGP, ? - incomplete

	Network	Next Hop	Metric	LocPrf	Weight	Path
*>i	1090::/64	1001::1	0	100		0 200
i						
* i		1004::1	0	100		0 200
i						
* i		1003::1	0	100		0 200
i						
* i		1002::1	0	100		0 200
i						
*>	9999::/64	2001::1(fe80::5054:ff:fe46:f549)	0	100		0 300 i
*		2004::1(fe80::5054:ff:feb5:9a71)	0	100		0 300 i
*		2003::1(fe80::5054:ff:fe0d:b565)	0	100		0 300 i
*		2002::1(fe80::5054:ff:fed2:4666)	0	100		0 300 i

Total number of prefixes 2

R3#show bgp ipv6 1090::/64

BGP routing table entry for 1090::/64

Paths: (4 available, best #1, table Default-IP-Routing-Table)

Advertised to non peer-group peers:

2001::1 2002::1 2003::1 2004::1

200

1001::1 (metric 20) from 3001::1 (10.12.5.93)

Origin IGP, metric 0, localpref 100, valid, internal, best

rx path_id: 0 tx path_id: 0

Not advertised to any peer

Last update: Wed Jan 11 04:08:51 2017

200

1004::1 (metric 20) from 3001::1 (10.12.5.93)

Origin IGP, metric 0, localpref 100, valid, internal

rx path_id: 3 tx path_id: -1

Not advertised to any peer

Last update: Wed Jan 11 04:09:43 2017

200

1003::1 (metric 20) from 3001::1 (10.12.5.93)

Origin IGP, metric 0, localpref 100, valid, internal

rx path_id: 2 tx path_id: -1

Not advertised to any peer

Last update: Wed Jan 11 04:09:43 2017

200

1002::1 (metric 20) from 3001::1 (10.12.5.93)

```

Origin IGP, metric 0, localpref 100, valid, internal
rx path_id: 1      tx path_id: -1
Not advertised to any peer
Last update: Wed Jan 11 04:09:43 2017

```

Additional Paths Send and Receive at Address-family level

R2

#configure terminal	Enter the Configure mode.
(config)#router bgp 100	Enter BGP router mode
(config-router)#address-family ipv6 unicast	Enter address-family mode for neighbor router session to activate.
(config-router-af)#bgp additional-paths send-receive	Configure R2 to send additional paths to and receive additional paths from all iBGP neighbors
(config-router-af)#bgp additional-paths select all	Configure R2 to select all available paths to send to all iBGP neighbors
(config-router-af)#exit-address-family	Exit Address Family mode and return to Router mode.
(config-router)#exit	Exit the router BGP mode and enter the config mode
(config)#commit	Apply commit
(config)#exit	Exit the config mode

R3

#configure terminal	Enter the Configure mode.
(config)#router bgp 100	Enter BGP router mode
(config-router)#address-family ipv6 unicast	Enter address-family mode for neighbor router session to activate.
(config-router-af)#bgp additional-paths send-receive	Configure R3 to send additional paths to and receive additional paths from all iBGP neighbors
(config-router-af)#bgp additional-paths select all	Configure R3 to select all available paths to send to all iBGP neighbors
(config-router-af)#exit-address-family	Exit Address Family mode and return to Router mode.
(config-router)#exit	Exit the router BGP mode and enter the config mode
(config)#commit	Apply commit
(config)#exit	Exit the config mode

Additional Paths at the Neighbor Level

R2

#configure terminal	Enter the Configure mode.
(config)#router bgp 100	Enter BGP router mode

(config-router)#address-family ipv6 unicast	Enter address-family mode for neighbor router session to activate.
(config-router-af)#neighbor 3001::2 additional-paths send-receive	Configure R2 to send-receive additional paths to the iBGP neighbor R3
(config-router-af)#neighbor 3001::2 advertise additional-paths all	Configure R2 to advertise all available paths to the iBGP neighbor R3
(config-router-af)#exit-address-family	Exit Address Family mode and return to Router mode.
(config-router)#exit	Exit the router BGP mode and enter the config mode
(config)#commit	Apply commit
(config)#exit	Exit the config mode

R3

#configure terminal	Enter the Configure mode.
(config)#router bgp 100	Enter BGP router mode
(config-router)#address-family ipv6 unicast	Enter address-family mode for neighbor router session to activate.
(config-router-af)#neighbor 3001::1 additional-paths send-receive	Configure R3 to receive additional paths from the iBGP neighbor R2
(config-router-af)#neighbor 3001::1 advertise additional-paths all	Configure R2 to advertise all available paths to the iBGP neighbor R3
(config-router-af)#exit-address-family	Exit Address Family mode and return to Router mode.
(config-router)#exit	Exit the router BGP mode and enter the config mode
(config)#commit	Apply commit
(config)#exit	Exit the config mode

Validation**R2**

```
#show bgp ipv6 neighbors 3001::2
BGP neighbor is 3001::2, remote AS 100, local AS 100, internal link
  BGP version 4, remote router ID 10.12.5.92
  BGP state = Established, up for 00:00:29
  Last read 00:00:29, hold time is 90, keepalive interval is 30 seconds
  Neighbor capabilities:
    Route refresh: advertised and received (old and new)
    Address family IPv4 Unicast: advertised and received
    Address family IPv6 Unicast: advertised and received
  Received 588 messages, 51 notifications, 0 in queue
  Sent 664 messages, 4 notifications, 0 in queue
  Route refresh request: received 0, sent 0
  Minimum time between advertisement runs is 5 seconds
For address family: IPv4 Unicast
  BGP table version 1, neighbor version 1
  Index 5, Offset 0, Mask 0x20
  Community attribute sent to this neighbor (both)
  0 accepted prefixes
  0 announced prefixes
```

BGP4+ Additional Paths Configuration

```
For address family: IPv6 Unicast
BGP table version 64, neighbor version 64
Index 5, Offset 0, Mask 0x20
AF-dependant capabilities:
  Add-Path Send Capability : advertised and received
  Add-Path Receive Capability : advertised and received
Community attribute sent to this neighbor (both)
4 accepted prefixes
4 announced prefixes

Connections established 5; dropped 4
Local host: 3001::1, Local port: 179
Foreign host: 3001::2, Foreign port: 39326
Nexthop: 10.12.5.93
Nexthop global: 3001::1
Nexthop local: fe80::5054:ff:fe19:1758
BGP connection: shared network
Last Reset: 00:00:29, due to BGP Notification sent
Notification Error Message: (Cease/Other Configuration Change.)
```

```
#show bgp ipv6 summary
BGP router identifier 10.12.5.93, local AS number 100
BGP table version is 64
2 BGP AS-PATH entries
0 BGP community entries
```

Neighbor Down State/PfxRcd	V	AS	MsgRcv	MsgSen	TblVer	InQ	OutQ	Up/
1001::1 04:35:32	4	200	561	578	64	0	0	
1002::1 04:35:32	1	4	200	564	579	64	0	0
1003::1 04:35:32	1	4	200	563	578	64	0	0
1004::1 04:35:32	1	4	200	562	578	64	0	0
3001::2 00:00:35	4	4	100	640	669	64	0	0

Total number of neighbors 5

Total number of Established sessions 5

```
#show bgp ipv6
BGP table version is 64, local router ID is 10.12.5.93
Status codes: s suppressed, d damped, h history, * valid, > best, i -
internal, l - labeled
                S Stale
Origin codes: i - IGP, e - EGP, ? - incomplete
```

Network	Next Hop	Metric	LocPrf	Weight	Path
*> 1090::/64	1001::1 (fe80::5054:ff:fe9c:b7e6)	0	100	0	200 i
*	1002::1 (fe80::5054:ff:fe0d:f5e)	0	100	0	200 i
*	1003::1 (fe80::5054:ff:fec7:1940)	0	100	0	200 i
*	1004::1 (fe80::5054:ff:fe62:70d8)				

```

0          100          0          200 i
*>i 9999::/64      2001::1          0          100          0          300
i
* i          2002::1          0          100          0          300
i
* i          2003::1          0          100          0          300
i
* i          2004::1          0          100          0          300
i

```

Total number of prefixes 2

```

#show bgp ipv6 1090::/64
BGP routing table entry for 1090::/64
Paths: (4 available, best #1, table Default-IP-Routing-Table)
  Advertised to non peer-group peers:
    1002::1 1003::1 1004::1
  200
    1001::1(fe80::5054:ff:fe9c:b7e6) from 1001::1 (10.12.5.144)
    (fe80::5054:ff:fe9c:b7e6)
      Origin IGP, metric 0, localpref 100, valid, external, best
      rx path_id: -1      tx path_id: 0
      Advertised to non peer-group peers:
        3001::2
      Last update: Wed Jan 11 03:53:54 2017

  200
    1002::1(fe80::5054:ff:fe0d:f5e) from 1002::1 (10.12.5.144)
    (fe80::5054:ff:fe0d:f5e)
      Origin IGP, metric 0, localpref 100, valid, external
      rx path_id: -1      tx path_id: 1
      Advertised to non peer-group peers:
        3001::2
      Last update: Wed Jan 11 03:54:01 2017

  200
    1003::1(fe80::5054:ff:fec7:1940) from 1003::1 (10.12.5.144)
    (fe80::5054:ff:fec7:1940)
      Origin IGP, metric 0, localpref 100, valid, external
      rx path_id: -1      tx path_id: 2
      Advertised to non peer-group peers:
        3001::2
      Last update: Wed Jan 11 03:53:52 2017

  200
    1004::1(fe80::5054:ff:fe62:70d8) from 1004::1 (10.12.5.144)
    (fe80::5054:ff:fe62:70d8)
      Origin IGP, metric 0, localpref 100, valid, external
      rx path_id: -1      tx path_id: 3
      Advertised to non peer-group peers:
        3001::2
      Last update: Wed Jan 11 03:53:48 2017

```

```

#show bgp ipv6 9999::/64
BGP routing table entry for 9999::/64
Paths: (4 available, best #1, table Default-IP-Routing-Table)
  Advertised to non peer-group peers:

```

```
1001::1 1002::1 1003::1 1004::1
300
  2001::1 (metric 20) from 3001::2 (10.12.5.92)
    Origin IGP, metric 0, localpref 100, valid, internal, best
    rx path_id: 0      tx path_id: 0
    Not advertised to any peer
    Last update: Wed Jan 11 04:45:39 2017

300
  2002::1 (metric 20) from 3001::2 (10.12.5.92)
    Origin IGP, metric 0, localpref 100, valid, internal
    rx path_id: 1      tx path_id: 1
    Not advertised to any peer
    Last update: Wed Jan 11 04:45:53 2017

300
  2003::1 (metric 20) from 3001::2 (10.12.5.92)
    Origin IGP, metric 0, localpref 100, valid, internal
    rx path_id: 2      tx path_id: 2
    Not advertised to any peer
    Last update: Wed Jan 11 04:45:53 2017

300
  2004::1 (metric 20) from 3001::2 (10.12.5.92)
    Origin IGP, metric 0, localpref 100, valid, internal
    rx path_id: 3      tx path_id: 3
    Not advertised to any peer
    Last update: Wed Jan 11 04:45:53 2017
```

R3

```
#show bgp ipv6 1090::/64
BGP routing table entry for 1090::/64
Paths: (4 available, best #1, table Default-IP-Routing-Table)
Advertised to non peer-group peers:
2001::1 2002::1 2003::1 2004::1
200
  1001::1 (metric 20) from 3001::1 (10.12.5.93)
    Origin IGP, metric 0, localpref 100, valid, internal, best
    rx path_id: 0      tx path_id: 0
    Not advertised to any peer
    Last update: Wed Jan 11 04:45:39 2017

200
  1002::1 (metric 20) from 3001::1 (10.12.5.93)
    Origin IGP, metric 0, localpref 100, valid, internal
    rx path_id: 1      tx path_id: 1
    Not advertised to any peer
    Last update: Wed Jan 11 04:45:42 2017

200
  1003::1 (metric 20) from 3001::1 (10.12.5.93)
    Origin IGP, metric 0, localpref 100, valid, internal
    rx path_id: 2      tx path_id: 2
    Not advertised to any peer
    Last update: Wed Jan 11 04:45:42 2017
```

```

200
 1004::1 (metric 20) from 3001::1 (10.12.5.93)
   Origin IGP, metric 0, localpref 100, valid, internal
   rx path_id: 3      tx path_id: 3
   Not advertised to any peer
   Last update: Wed Jan 11 04:45:42 2017

R3#show bgp ipv6 9999::/64
BGP routing table entry for 9999::/64
Paths: (4 available, best #1, table Default-IP-Routing-Table)
Advertised to non peer-group peers:
2002::1 2003::1 2004::1
300
 2001::1(fe80::5054:ff:fe46:f549) from 2001::1 (10.12.5.90)
   (fe80::5054:ff:fe46:f549)
   Origin IGP, metric 0, localpref 100, valid, external, best
   rx path_id: -1     tx path_id: 0
   Advertised to non peer-group peers:
     3001::1
   Last update: Wed Jan 11 03:52:32 2017

300
 2002::1(fe80::5054:ff:fed2:4666) from 2002::1 (10.12.5.90)
   (fe80::5054:ff:fed2:4666)
   Origin IGP, metric 0, localpref 100, valid, external
   rx path_id: -1     tx path_id: 1
   Advertised to non peer-group peers:
     3001::1
   Last update: Wed Jan 11 03:52:27 2017

300
 2003::1(fe80::5054:ff:fe0d:b565) from 2003::1 (10.12.5.90)
   (fe80::5054:ff:fe0d:b565)
   Origin IGP, metric 0, localpref 100, valid, external
   rx path_id: -1     tx path_id: 2
   Advertised to non peer-group peers:
     3001::1
   Last update: Wed Jan 11 03:52:37 2017

300
 2004::1(fe80::5054:ff:feb5:9a71) from 2004::1 (10.12.5.90)
   (fe80::5054:ff:feb5:9a71)
   Origin IGP, metric 0, localpref 100, valid, external
   rx path_id: -1     tx path_id: 3
   Advertised to non peer-group peers:
     3001::1
   Last update: Wed Jan 11 03:52:44 2017

#show bgp ipv6
BGP table version is 283, local router ID is 10.12.5.92
Status codes: s suppressed, d damped, h history, * valid, > best, i -
internal, l - labeled
              S Stale
Origin codes: i - IGP, e - EGP, ? - incomplete

      Network          Next Hop          Metric      LocPrf Weight Path

```

BGP4+ Additional Paths Configuration

```
*>i 1090::/64      1001::1          0          100          0          200
i
* i 1002::/64      1002::1          0          100          0          200
i
* i 1003::/64      1003::1          0          100          0          200
i
* i 1004::/64      1004::1          0          100          0          200
i
*> 9999::/64      2001::1(fe80::5054:ff:fe46:f549)
                                0          100          0          300 i
*
                                2002::1(fe80::5054:ff:fed2:4666)
                                0          100          0          300 i
*
                                2003::1(fe80::5054:ff:fe0d:b565)
                                0          100          0          300 i
*
                                2004::1(fe80::5054:ff:feb5:9a71)
                                0          100          0          300 i
```

Total number of prefixes 2

```
#show bgp ipv6 summary
BGP router identifier 10.12.5.92, local AS number 100
BGP table version is 283
2 BGP AS-PATH entries
0 BGP community entries
```

Neighbor Down State/PfxRcd	V	AS	MsgRcv	MsgSen	TblVer	InQ	OutQ	Up/
2001::1 04:28:07	1	4	300	556	562	282	0	0
2002::1 04:28:07	1	4	300	556	560	283	0	0
2003::1 04:28:07	1	4	300	560	563	282	0	0
2004::1 04:28:03	1	4	300	543	546	283	0	0
3001::1 00:04:18	4	4	100	551	553	283	0	0

Total number of neighbors 5

Total number of Established sessions 5

```
#show bgp ipv6 neighbors 3001::1
BGP neighbor is 3001::1, remote AS 100, local AS 100, internal link
BGP version 4, remote router ID 10.12.5.93
BGP state = Established, up for 00:05:02
Last read 00:05:02, hold time is 90, keepalive interval is 30 seconds
Neighbor capabilities:
  Route refresh: advertised and received (old and new)
  Address family IPv4 Unicast: advertised and received
  Address family IPv6 Unicast: advertised and received
Received 550 messages, 3 notifications, 0 in queue
Sent 553 messages, 2 notifications, 0 in queue
Route refresh request: received 0, sent 0
Minimum time between advertisement runs is 5 seconds
For address family: IPv4 Unicast
BGP table version 1, neighbor version 1
Index 5, Offset 0, Mask 0x20
```

Community attribute sent to this neighbor (both)
 0 accepted prefixes
 0 announced prefixes

For address family: IPv6 Unicast
 BGP table version 283, neighbor version 283
 Index 1, Offset 0, Mask 0x2
 AF-dependant capabilities:
 Add-Path Send Capability : advertised and received
 Add-Path Receive Capability : advertised and received
 Community attribute sent to this neighbor (both)
 4 accepted prefixes
 4 announced prefixes

Connections established 6; dropped 5
 Local host: 3001::2, Local port: 39326
 Foreign host: 3001::1, Foreign port: 179
 Nexthop: 10.12.5.92
 Nexthop global: 3001::2
 Nexthop local: fe80::5054:ff:fe5d:bb79
 BGP connection: shared network
 Last Reset: 00:05:07, due to BGP Notification received
 Notification Error Message: (Cease/Other Configuration Change.)

Selection of all Additional Paths at the Address-family Level

R2

#configure terminal	Enter the Configure mode.
(config)#router bgp 100	Enter BGP router mode
(config-router)#address-family ipv6 unicast	Enter address-family mode for neighbor router session to activate.
(config-router-af)#bgp additional-paths send-receive	Configure R2 to send additional paths to and receive additional paths from all iBGP neighbors
(config-router-af)#bgp additional-paths select all	Configure R2 to select all available paths to send to all iBGP neighbors
(config-router-af)#exit-address-family	Exit Address Family mode and return to Router mode.
(config-router)#exit	Exit the router BGP mode and enter the config mode
(config)#commit	Apply commit
(config)#exit	Exit the config mode

Selection of all Additional Paths at the Neighbor Level

R2

#configure terminal	Enter the Configure mode.
(config)#router bgp 100	Enter BGP router mode

(config-router)#address-family ipv6 unicast	Enter address-family mode for neighbor router session to activate.
(config-router-af)#neighbor 3001::2 additional-paths send	Configure R2 to send additional paths to and receive additional paths from all iBGP neighbors
(config-router-af)#neighbor 3001::2 advertise additional-paths all	Configure R2 to select all available paths to send to all iBGP neighbors
(config-router-af)#exit-address-family	Exit Address Family mode and return to Router mode.
(config-router)#exit	Exit the router BGP mode and enter the config mode
(config)#commit	Apply commit
(config)#exit	Exit the config mode

Validation

R2

```
#show bgp ipv6 1090::/64
BGP routing table entry for 1090::/64
Paths: (4 available, best #1, table Default-IP-Routing-Table)
  Advertised to non peer-group peers:
    1002::1 1003::1 1004::1
  200
    1001::1(fe80::5054:ff:fe9c:b7e6) from 1001::1 (10.12.5.144)
    (fe80::5054:ff:fe9c:b7e6)
      Origin IGP, metric 0, localpref 100, valid, external, best
      rx path_id: -1      tx path_id: 0
      Advertised to non peer-group peers:
        3001::2
      Last update: Wed Jan 11 03:53:54 2017

  200
    1002::1(fe80::5054:ff:fe0d:f5e) from 1002::1 (10.12.5.144)
    (fe80::5054:ff:fe0d:f5e)
      Origin IGP, metric 0, localpref 100, valid, external
      rx path_id: -1      tx path_id: 1
      Advertised to non peer-group peers:
        3001::2
      Last update: Wed Jan 11 03:54:01 2017

  200
    1003::1(fe80::5054:ff:fec7:1940) from 1003::1 (10.12.5.144)
    (fe80::5054:ff:fec7:1940)
      Origin IGP, metric 0, localpref 100, valid, external
      rx path_id: -1      tx path_id: 2
      Advertised to non peer-group peers:
        3001::2
      Last update: Wed Jan 11 03:53:52 2017

  200
    1004::1(fe80::5054:ff:fe62:70d8) from 1004::1 (10.12.5.144)
    (fe80::5054:ff:fe62:70d8)
      Origin IGP, metric 0, localpref 100, valid, external
      rx path_id: -1      tx path_id: 3
      Advertised to non peer-group peers:
        3001::2
```

Last update: Wed Jan 11 03:53:48 2017

R3

```
#show bgp ipv6 1090::
BGP routing table entry for 1090::/64
Paths: (4 available, best #1, table Default-IP-Routing-Table)
  Advertised to non peer-group peers:
    2001::1 2002::1 2003::1 2004::1
  200
    1001::1 (metric 20) from 3001::1 (10.12.5.93)
      Origin IGP, metric 0, localpref 100, valid, internal, best
      rx path_id: 0      tx path_id: 0
      Not advertised to any peer
      Last update: Wed Jan 11 05:52:01 2017

  200
    1004::1 (metric 20) from 3001::1 (10.12.5.93)
      Origin IGP, metric 0, localpref 100, valid, internal
      rx path_id: 3      tx path_id: -1
      Not advertised to any peer
      Last update: Wed Jan 11 05:52:43 2017

  200
    1003::1 (metric 20) from 3001::1 (10.12.5.93)
      Origin IGP, metric 0, localpref 100, valid, internal
      rx path_id: 2      tx path_id: -1
      Not advertised to any peer
      Last update: Wed Jan 11 05:52:43 2017

  200
    1002::1 (metric 20) from 3001::1 (10.12.5.93)
      Origin IGP, metric 0, localpref 100, valid, internal
      rx path_id: 1      tx path_id: -1
      Not advertised to any peer
      Last update: Wed Jan 11 05:52:43 2017
```

Selection of Best 2 Additional Paths at AF Level

R2

#configure terminal	Enter the Configure mode.
(config)#router bgp 100	Enter BGP router mode
(config-router)#address-family ipv6 unicast	Enter address-family mode for neighbor router session to activate.
(config-router-af)#bgp additional-paths send	Configure R2 to send additional paths to the iBGP neighbor R3
(config-router-af)#bgp additional-paths select best 2	Configure R2 to select best 2 out of all available paths to all iBGP neighbors
(config-router-af)#exit-address-family	Exit Address Family mode and return to Router mode.
(config-router)#exit	Exit the router BGP mode and enter the config mode

(config)#commit	Apply commit
(config)#exit	Exit the config mode

Selection of Best 2 Additional Paths at the Neighbor Level

R2

#configure terminal	Enter the Configure mode.
(config)#router bgp 100	Enter BGP router mode
(config-router)#address-family ipv6 unicast	Enter address-family mode for neighbor router session to activate.
(config-router-af)#neighbor 3001::2 additional-paths send	Configure R2 to send additional paths to the iBGP neighbor R3
(config-router-af)#neighbor 3001::2 advertise additional-paths best 2	Configure R2 to advertise best 2 out of all available paths to R3
(config-router-af)#exit-address-family	Exit Address Family mode and return to Router mode.
(config-router)#exit	Exit the router BGP mode and enter the config mode
(config)#commit	Apply commit
(config)#exit	Exit the config mode

Validation

R2

```
#show bgp ipv6 1090::/64
BGP routing table entry for 1090::/64
Paths: (4 available, best #1, table Default-IP-Routing-Table)
  Advertised to non peer-group peers:
    1002::1 1003::1 1004::1
  200
    1001::1(fe80::5054:ff:fe9c:b7e6) from 1001::1 (10.12.5.144)
    (fe80::5054:ff:fe9c:b7e6)
    Origin IGP, metric 0, localpref 100, valid, external, best
    rx path_id: -1      tx path_id: 0
    Advertised to non peer-group peers:
      3001::2
    Last update: Wed Jan 11 06:34:49 2017

  200
    1002::1(fe80::5054:ff:fe0d:f5e) from 1002::1 (10.12.5.144)
    (fe80::5054:ff:fe0d:f5e)
    Origin IGP, metric 0, localpref 100, valid, external
    rx path_id: -1      tx path_id: 1
    Advertised to non peer-group peers:
      3001::2
    Last update: Wed Jan 11 06:34:49 2017

  200
    1003::1(fe80::5054:ff:fec7:1940) from 1003::1 (10.12.5.144)
```



```
(fe80::5054:ff:fec7:1940)
  Origin IGP, metric 0, localpref 100, valid, external
  rx path_id: -1      tx path_id: -1
  Not advertised to any peer
  Last update: Wed Jan 11 06:34:49 2017
```

200

```
1004::1(fe80::5054:ff:fe62:70d8) from 1004::1 (10.12.5.144)
(fe80::5054:ff:fe62:70d8)
  Origin IGP, metric 0, localpref 100, valid, external
  rx path_id: -1      tx path_id: -1
  Not advertised to any peer
  Last update: Wed Jan 11 06:34:49 2017
```

R3

```
#show bgp ipv6 1090::
BGP routing table entry for 1090::/64
Paths: (2 available, best #1, table Default-IP-Routing-Table)
  Advertised to non peer-group peers:
    2001::1 2002::1 2003::1 2004::1
200
  1001::1 (metric 20) from 3001::1 (10.12.5.93)
    Origin IGP, metric 0, localpref 100, valid, internal, best
    rx path_id: 0      tx path_id: 0
    Not advertised to any peer
    Last update: Wed Jan 11 06:34:49 2017

200
  1002::1 (metric 20) from 3001::1 (10.12.5.93)
    Origin IGP, metric 0, localpref 100, valid, internal
    rx path_id: 1      tx path_id: -1
    Not advertised to any peer
    Last update: Wed Jan 11 06:34:49 2017

#show bgp ipv6
BGP table version is 407, local router ID is 10.12.5.92
Status codes: s suppressed, d damped, h history, * valid, > best, i -
internal, l - labeled
              S Stale
Origin codes: i - IGP, e - EGP, ? - incomplete
```

	Network	Next Hop	Metric	LocPrf	Weight	Path
*>i	1090::/64	1001::1	0	100	0	200
i						
* i		1002::1	0	100	0	200
i						
*>	9999::/64	2001::1(fe80::5054:ff:fe46:f549)	0	100	0	300 i
*		2002::1(fe80::5054:ff:fed2:4666)	0	100	0	300 i
*		2003::1(fe80::5054:ff:fe0d:b565)	0	100	0	300 i
*		2004::1(fe80::5054:ff:feb5:9a71)	0	100	0	300 i

Total number of prefixes 2

Selection of Best 3 Additional Paths at the AF Level

R2

#configure terminal	Enter the Configure mode.
(config)#router bgp 100	Enter BGP router mode
(config-router)#address-family ipv6 unicast	Enter address-family mode for neighbor router session to activate.
(config-router-af)#bgp additional-paths send	Configure R2 to send additional paths to the iBGP neighbor R3
(config-router-af)#bgp additional-paths select best 3	Configure R2 to select best 3 out of all available paths to all iBGP neighbors
(config-router-af)#exit-address-family	Exit Address Family mode and return to Router mode.
(config-router)#exit	Exit the router BGP mode and enter the config mode
(config)#commit	Apply commit
(config)#exit	Exit the config mode

Selection of Best 3 Additional Paths at the Neighbor Level

R2

#configure terminal	Enter the Configure mode.
(config)#router bgp 100	Enter BGP router mode
(config-router)#address-family ipv6 unicast	Enter address-family mode for neighbor router session to activate.
(config-router-af)#neighbor 3001::2 additional-paths send	Configure R2 to send additional paths to the iBGP neighbor R3
(config-router-af)#neighbor 3001::2 advertise additional-paths best 3	Configure R2 to advertise best 3 out of all available paths to R3
(config-router-af)#exit-address-family	Exit Address Family mode and return to Router mode.
(config-router)#exit	Exit the router BGP mode and enter the config mode
(config)#commit	Apply commit
(config)#exit	Exit the config mode

Validation

R2

```
#show bgp ipv6 1090::/64
BGP routing table entry for 1090::/64
Paths: (4 available, best #1, table Default-IP-Routing-Table)
  Advertised to non-peer-group peers:
    1002::1 1003::1 1004::1
    200
```

```

1001::1(fe80::5054:ff:fe9c:b7e6) from 1001::1 (10.12.5.144)
(fe80::5054:ff:fe9c:b7e6)
  Origin IGP, metric 0, localpref 100, valid, external, best
  rx path_id: -1      tx path_id: 0
  Advertised to non peer-group peers:
    3001::2
  Last update: Wed Jan 11 06:34:49 2017

200
1002::1(fe80::5054:ff:fe0d:f5e) from 1002::1 (10.12.5.144)
(fe80::5054:ff:fe0d:f5e)
  Origin IGP, metric 0, localpref 100, valid, external
  rx path_id: -1      tx path_id: 1
  Advertised to non peer-group peers:
    3001::2
  Last update: Wed Jan 11 06:34:49 2017

200
1003::1(fe80::5054:ff:fec7:1940) from 1003::1 (10.12.5.144)
(fe80::5054:ff:fec7:1940)
  Origin IGP, metric 0, localpref 100, valid, external
  rx path_id: -1      tx path_id: 2
  Advertised to non peer-group peers:
    3001::2
  Last update: Wed Jan 11 06:34:49 2017

200
1004::1(fe80::5054:ff:fe62:70d8) from 1004::1 (10.12.5.144)
(fe80::5054:ff:fe62:70d8)
  Origin IGP, metric 0, localpref 100, valid, external
  rx path_id: -1      tx path_id: -1
  Not advertised to any peer
  Last update: Wed Jan 11 06:34:49 2017

```

R3

```

#show bgp ipv6 1090::/64
BGP routing table entry for 1090::/64
Paths: (3 available, best #1, table Default-IP-Routing-Table)
  Advertised to non peer-group peers:
    2001::1 2002::1 2003::1 2004::1
200
  1001::1 (metric 20) from 3001::1 (10.12.5.93)
    Origin IGP, metric 0, localpref 100, valid, internal, best
    rx path_id: 0      tx path_id: 0
    Not advertised to any peer
    Last update: Wed Jan 11 06:36:11 2017

200
  1003::1 (metric 20) from 3001::1 (10.12.5.93)
    Origin IGP, metric 0, localpref 100, valid, internal
    rx path_id: 2      tx path_id: -1
    Not advertised to any peer
    Last update: Wed Jan 11 06:36:53 2017

200
  1002::1 (metric 20) from 3001::1 (10.12.5.93)

```

BGP4+ Additional Paths Configuration

```
Origin IGP, metric 0, localpref 100, valid, internal
rx path_id: 1      tx path_id: -1
Not advertised to any peer
Last update: Wed Jan 11 06:36:53 2017
```

```
#show bgp ipv6
```

```
BGP table version is 410, local router ID is 10.12.5.92
```

```
Status codes: s suppressed, d damped, h history, * valid, > best, i -
internal, l - labeled
```

```
S Stale
```

```
Origin codes: i - IGP, e - EGP, ? - incomplete
```

	Network	Next Hop	Metric	LocPrf	Weight	Path
*>i	1090::/64	1001::1	0	100	0	200
i						
* i		1003::1	0	100	0	200
i						
* i		1002::1	0	100	0	200
i						
*>	9999::/64	2001::1 (fe80::5054:ff:fe46:f549)	0	100	0	300 i
*		2002::1 (fe80::5054:ff:fed2:4666)	0	100	0	300 i
*		2003::1 (fe80::5054:ff:fe0d:b565)	0	100	0	300 i
*		2004::1 (fe80::5054:ff:feb5:9a71)	0	100	0	300 i

```
Total number of prefixes 2
```

CHAPTER 8 OSPFv2

This chapter contains basic OSPFv2 (Open Shortest Path First) configuration examples.

Enable OSPF on an Interface

The diagram shows the minimum configuration required to enable OSPF on an interface. R1 and R2 are two routers in Area 0 connecting to network 10.10.10.0/24.

Note: Configure one interface so that it belongs to only one area. It is possible, however, to configure different interfaces on a router to belong to different areas.

Topology

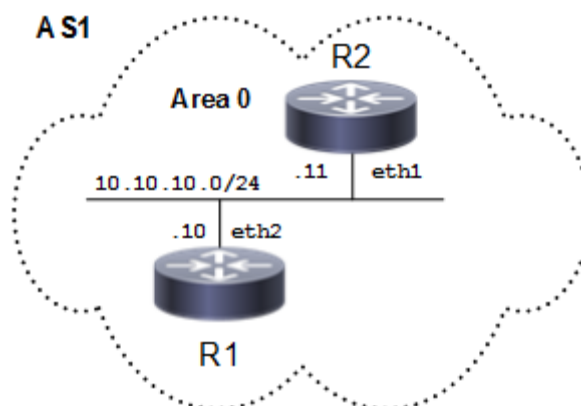

Figure 8-64: Basic OSPF Topology

R1

#configure terminal	Enter configure mode
(config)#router ospf 100	Configure the routing process, and specify the Process ID (100). The Process ID should be a unique positive integer identifying the routing process.
(config-router)#network 10.10.10.0/24 area 0	Define the interface (10.10.10.0/24) on which OSPF runs, and associate the area ID (0) with the interface (area ID 0 specifies the backbone area).
(config-router)#commit	Commit the candidate configuration to the running configuration.

R2

#configure terminal	Enter configure mode
(config)#router ospf 200	Configure the routing process, and specify the Process ID (200). The Process ID should be a unique positive integer identifying the routing process.

(config-router)#network 10.10.10.0/24 area 0	Define the interface (10.10.10.0/24) on which OSPF runs, and associate the area ID (0) with the interface.
(config-router)#commit	Commit the candidate configuration to the running configuration.

Validation

R1

```
#show ip ospf
Routing Process "ospf 100" with ID 10.12.26.88
Process uptime is 1 minute
Process bound to VRF default
Conforms to RFC2328, and RFC1583 Compatibility flag is disabled
Supports only single TOS(TOS0) routes
Supports opaque LSA
Supports Graceful Restart
SPF schedule delay initial 0 secs 500 msec
SPF schedule delay min 0 secs 500 msec
SPF schedule delay max 50 secs 0 msec
Refresh timer 10 secs
Number of incoming current DD exchange neighbors 0/64
Number of outgoing current DD exchange neighbors 0/64
Initial LSA throttle delay 0 secs 0 msec
Minimum hold time for LSA throttle 5 secs 0 msec
Maximum wait time for LSA throttle 5 secs 0 msec
Minimum LSA arrival 1 secs 0 msec
Number of external LSA 0. Checksum 0x000000
Number of opaque AS LSA 0. Checksum 0x000000
Number of non-default external LSA 0
External LSA database is unlimited.
Number of LSA originated 4
Number of LSA received 4
Number of areas attached to this router: 1
  Area 0.0.0.0 (BACKBONE)
    Number of interfaces in this area is 1(1)
    Number of fully adjacent neighbors in this area is 1
    Area has no authentication
    SPF algorithm last executed 00:00:08.102 ago
    SPF algorithm executed 3 times
    Number of LSA 7. Checksum 0x0312b5
Dste Staus: Disabled

#show ip ospf interface
eth2 is up, line protocol is up
  Internet Address 10.10.10.10/24, Area 0.0.0.0, MTU 1500
  Process ID 100, VRF (default), Router ID 10.12.26.88, Network Type
  BROADCAST, Cost: 1
  Transmit Delay is 1 sec, State DR, Priority 1, TE Metric 1
  Designated Router (ID) 10.12.26.88, Interface Address 10.10.10.10
  Backup Designated Router (ID) 10.12.26.89, Interface Address 10.10.10.11
  Timer intervals configured, Hello 10, Dead 40, Wait 40, Retransmit 5
  Hello due in 00:00:11
  Neighbor Count is 1, Adjacent neighbor count is 1
  Suppress hello for 0 neighbor(s)
```

```

Hello received 13 sent 19, DD received 3 sent 4
LS-Req received 1 sent 1, LS-Upd received 3 sent 5
LS-Ack received 3 sent 3, Discarded 0
No authentication

```

```
#show ip ospf neighbor
```

```

Total number of full neighbors: 1
OSPF process 100 VRF(default):
Neighbor ID      Pri  State           Dead Time   Address      Interface
Instance ID
10.12.26.89     1   Full/Backup     00:00:39   10.10.10.11  eth2
0

```

```
#show ip ospf route
```

```

OSPF process 100:
Codes: C - connected, D - Discard, O - OSPF, IA - OSPF inter area
       N1 - OSPF NSSA external type 1, N2 - OSPF NSSA external type 2
       E1 - OSPF external type 1, E2 - OSPF external type 2

C 10.10.10.0/24 [1] is directly connected, eth2, Area 0.0.0.0

```

R2

```

#show ip ospf
Routing Process "ospf 200" with ID 10.12.26.89
Process uptime is 1 minute
Process bound to VRF default
Conforms to RFC2328, and RFC1583 Compatibility flag is disabled
Supports only single TOS(TOS0) routes
Supports opaque LSA
Supports Graceful Restart
SPF schedule delay initial 0 secs 500 msec
SPF schedule delay min 0 secs 500 msec
SPF schedule delay max 50 secs 0 msec
Refresh timer 10 secs
Number of incoming current DD exchange neighbors 0/64
Number of outgoing current DD exchange neighbors 0/64
Initial LSA throttle delay 0 secs 0 msec
Minimum hold time for LSA throttle 5 secs 0 msec
Maximum wait time for LSA throttle 5 secs 0 msec
Minimum LSA arrival 1 secs 0 msec
Number of external LSA 0. Checksum 0x000000
Number of opaque AS LSA 0. Checksum 0x000000
Number of non-default external LSA 0
External LSA database is unlimited.
Number of LSA originated 3
Number of LSA received 5
Number of areas attached to this router: 1
  Area 0.0.0.0 (BACKBONE)
    Number of interfaces in this area is 1(1)
    Number of fully adjacent neighbors in this area is 1
    Area has no authentication
    SPF algorithm last executed 00:00:45.638 ago
    SPF algorithm executed 4 times

```

```
Number of LSA 7. Checksum 0x0312b5
Dste Staus: Disabled

#show ip ospf interface
eth1 is up, line protocol is up
  Internet Address 10.10.10.11/24, Area 0.0.0.0, MTU 1500
  Process ID 200, VRF (default), Router ID 10.12.26.89, Network Type
  BROADCAST, Cost: 1
  Transmit Delay is 1 sec, State Backup, Priority 1, TE Metric 1
  Designated Router (ID) 10.12.26.88, Interface Address 10.10.10.10
  Backup Designated Router (ID) 10.12.26.89, Interface Address 10.10.10.11
  Timer intervals configured, Hello 10, Dead 40, Wait 40, Retransmit 5
  Hello due in 00:00:06
  Neighbor Count is 1, Adjacent neighbor count is 1
  Suppress hello for 0 neighbor(s)
  Hello received 30 sent 31, DD received 4 sent 3
  LS-Req received 1 sent 1, LS-Upd received 5 sent 3
  LS-Ack received 2 sent 3, Discarded 0
  No authentication

#show ip ospf neighbor

Total number of full neighbors: 1
OSPF process 200 VRF(default):
Neighbor ID      Pri   State           Dead Time   Address      Interface
Instance ID
10.12.26.88      1    Full/DR         00:00:33   10.10.10.10  eth1
0

#show ip ospf route

OSPF process 200:
Codes: C - connected, D - Discard, O - OSPF, IA - OSPF inter area
      N1 - OSPF NSSA external type 1, N2 - OSPF NSSA external type 2
      E1 - OSPF external type 1, E2 - OSPF external type 2

C 10.10.10.0/24 [1] is directly connected, eth1, Area 0.0.0.0
```

Set Priority

This example shows how to set the priority for an interface. Set a high priority for a router to make it the Designated Router (DR). Router R3 is configured to have a priority of 10, which is higher than the default priority (1) of R1 and R2; making it the DR.

Topology

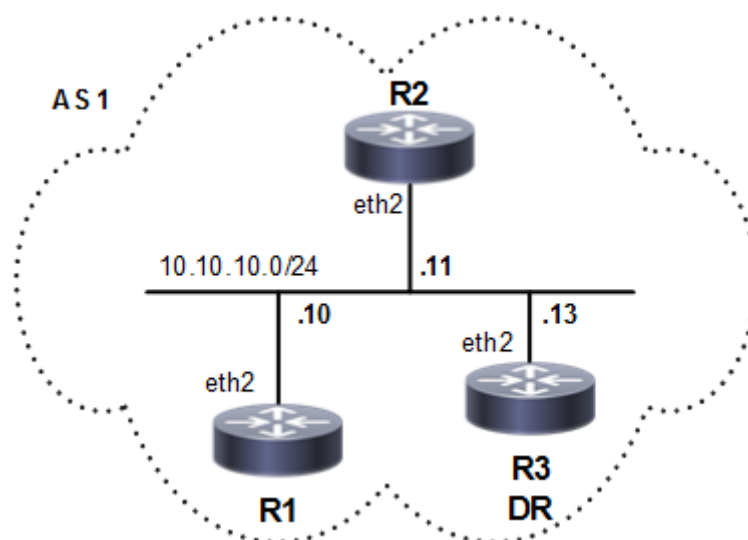

Figure 8-65: Set OSPF Priority

R3

#configure terminal	Enter configure mode
(config)#interface eth2	Enter interface mode.
(config-if)#ip ospf priority 10	Specify the router priority to a higher priority (10) to make R3 the Designated Router (DR).
(config-if)#exit	Exit interface mode.
(config)#router ospf 100	Configure the routing process, and specify the Process ID (100). The Process ID should be a unique positive integer identifying the routing process.
(config-router)#network 10.10.10.0/24 area 0	Define the interface (10.10.10.0/24) on which OSPF runs, and associate the area ID (0) with the interface.
(config-router)#commit	Commit the candidate configuration to the running configuration.

R1

#configure terminal	Enter configure mode
(config)#router ospf 100	Configure the routing process, and specify the Process ID (100). The Process ID should be a unique positive integer identifying the routing process.

(config-router)#network 10.10.10.0/24 area 0	Define the interface (10.10.10.0/24) on which OSPF runs, and associate the area ID (0) with the interface (area ID 0 specifies the backbone area).
(config-router)#commit	Commit the candidate configuration to the running configuration.

R2

#configure terminal	Enter configure mode
(config)#router ospf 200	Configure the routing process, and specify the Process ID (200). The Process ID should be a unique positive integer identifying the routing process.
(config-router)#network 10.10.10.0/24 area 0	Define the interface (10.10.10.0/24) on which OSPF runs, and associate the area ID (0) with the interface.
(config-router)#commit	Commit the candidate configuration to the running configuration.

Validation**R1**

```
#sh ip ospf neighbor
```

```
Total number of full neighbors: 2
```

```
OSPF process 100 VRF(default):
```

Neighbor ID Instance ID	Pri	State	Dead Time	Address	Interface
10.12.26.89 0	1	Full/DROther	00:00:39	10.10.10.11	eth2
10.12.26.90 0	10	Full/DR	00:00:32	10.10.10.13	eth2

```
#sh ip ospf interface
```

```
eth2 is up, line protocol is up
```

```
Internet Address 10.10.10.10/24, Area 0.0.0.0, MTU 1500
```

```
Process ID 100, VRF (default), Router ID 10.12.26.88, Network Type  
BROADCAST, Cost: 1
```

```
Transmit Delay is 1 sec, State Backup, Priority 1, TE Metric 1
```

```
Designated Router (ID) 10.12.26.90, Interface Address 10.10.10.13
```

```
Backup Designated Router (ID) 10.12.26.88, Interface Address 10.10.10.10
```

```
Timer intervals configured, Hello 10, Dead 40, Wait 40, Retransmit 5
```

```
Hello due in 00:00:10
```

```
Neighbor Count is 2, Adjacent neighbor count is 2
```

```
Suppress hello for 0 neighbor(s)
```

```
Hello received 30 sent 19, DD received 6 sent 8
```

```
LS-Req received 2 sent 2, LS-Upd received 16 sent 6
```

```
LS-Ack received 8 sent 7, Discarded 0
```

```
No authentication
```

```
#sh running-config
```

```
!  
no service password-encryption  
!  
hostname rtr1
```

```
!  
logging monitor 7  
!  
ip vrf management  
!  
ip domain-lookup  
!  
ip pim register-rp-reachability  
!  
interface lo  
  mtu 65536  
  ip address 127.0.0.1/8  
  ipv6 address ::1/128  
!  
interface eth0  
  ip address 10.12.26.88/24  
!  
interface eth1  
!  
interface eth2  
  ip address 10.10.10.10/24  
!  
interface eth3  
!  
interface eth4  
!  
interface eth5  
!  
interface eth6  
!  
interface eth7  
!  
router ospf 100  
  network 10.10.10.0/24 area 0.0.0.0  
  
!  
line con 0  
  login  
line vty 0 39  
  login  
!  
end
```

R2

```
#show running-config  
!  
no service password-encryption  
!  
hostname R2  
!  
logging monitor 7  
!  
ip vrf management  
!  
ip domain-lookup  
!
```

```
ip pim register-rp-reachability
!
interface lo
  mtu 65536
  ip address 127.0.0.1/8
  ipv6 address ::1/128
!
interface eth0
  ip address 10.12.26.89/24
!
interface eth1
!
interface eth2
  ip address 10.10.10.11/24
!
interface eth3
!
interface eth4
!
interface eth5
!
interface eth6
!
router ospf 200
  network 10.10.10.0/24 area 0.0.0.0

!
line con 0
  login
line vty 0 39
  login
!
end

#show ip ospf neighbor

Total number of full neighbors: 2
OSPF process 200 VRF(default):
Neighbor ID      Pri   State           Dead Time   Address      Interface
Instance ID
10.12.26.88      1    Full/Backup     00:00:30   10.10.10.10  eth2
0
10.12.26.90      10   Full/DR         00:00:31   10.10.10.13  eth2
0
R2#

R2#show ip ospf interface
eth2 is up, line protocol is up
  Internet Address 10.10.10.11/24, Area 0.0.0.0, MTU 1500
  Process ID 200, VRF (default), Router ID 10.12.26.89, Network Type
BROADCAST, Cost: 1
  Transmit Delay is 1 sec, State DROther, Priority 1, TE Metric 1
  Designated Router (ID) 10.12.26.90, Interface Address 10.10.10.13
  Backup Designated Router (ID) 10.12.26.88, Interface Address 10.10.10.10
  Timer intervals configured, Hello 10, Dead 40, Wait 40, Retransmit 5
  Hello due in 00:00:08
  Neighbor Count is 2, Adjacent neighbor count is 2
```

```
Suppress hello for 0 neighbor(s)
Hello received 71 sent 36, DD received 7 sent 7
LS-Req received 2 sent 2, LS-Upd received 9 sent 4
LS-Ack received 3 sent 4, Discarded 1
No authentication
```

R3

```
#show running-config
!
no service password-encryption
!
hostname R3
!
logging monitor 7
!
ip vrf management
!
ip domain-lookup
spanning-tree mode provider-rstp
data-center-bridging enable
ethernet cfm enable
!
interface lo
  mtu 65536
  ip address 127.0.0.1/8
  ipv6 address ::1/128
!
interface eth0
  ip address 10.12.26.90/24
!
interface eth1
!
interface eth2
  ip address 10.10.10.13/24
  ip ospf priority 10
!
interface eth3
!
interface eth4
!
interface eth5
!
interface eth6
!
router ospf 100
  network 10.10.10.0/24 area 0.0.0.0

!
line con 0
  login
line vty 0 39
  login
!
end

#show ip ospf neighbor
```

Total number of full neighbors: 2

OSPF process 100 VRF(default):

Neighbor ID Instance ID	Pri	State	Dead Time	Address	Interface
10.12.26.88 0	1	Full/Backup	00:00:33	10.10.10.10	eth2
10.12.26.89 0	1	Full/DROther	00:00:30	10.10.10.11	eth2

#show ip ospf interface

eth2 is up, line protocol is up

Internet Address 10.10.10.13/24, Area 0.0.0.0, MTU 1500

Process ID 100, VRF (default), Router ID 10.12.26.90, Network Type
BROADCAST, Cost: 1

Transmit Delay is 1 sec, State DR, Priority 10, TE Metric 1

Designated Router (ID) 10.12.26.90, Interface Address 10.10.10.13

Backup Designated Router (ID) 10.12.26.88, Interface Address 10.10.10.10

Timer intervals configured, Hello 10, Dead 40, Wait 40, Retransmit 5

Hello due in 00:00:05

Neighbor Count is 2, Adjacent neighbor count is 2

Suppress hello for 0 neighbor(s)

Hello received 99 sent 60, DD received 8 sent 6

LS-Req received 2 sent 2, LS-Upd received 9 sent 12

LS-Ack received 9 sent 6, Discarded 1

No authentication

Area Border Router

This example shows configuration for an Area Border Router. R2 is an Area Border Router (ABR). On R2, Interface eth2 is in Area 0, and Interface eth1 is in Area 1.

Topology

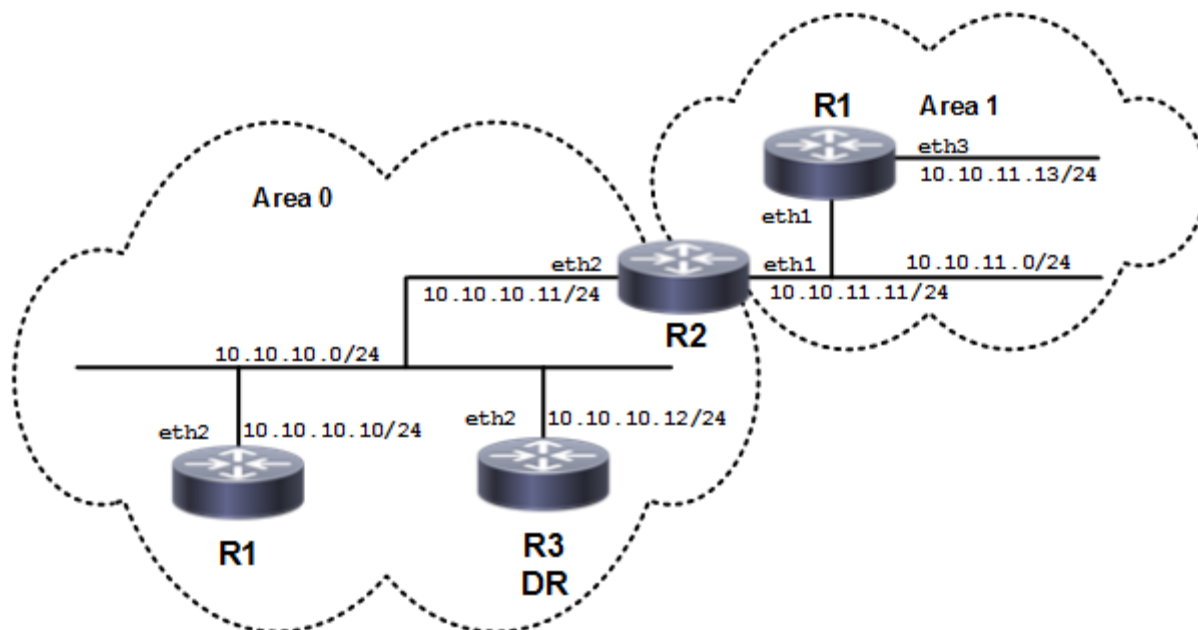

Figure 8-66: OSPF ABR Topology

Configuration

R2

#configure terminal	Enter configure mode
(config)#router ospf 100	Configure the routing process, and specify the Process ID (100). The Process ID should be a unique positive integer.
(config-router)#network 10.10.10.0/24 area 0	Define one interface (10.10.10.0/24) on which OSPF runs, and associate the area ID (0) with the interface.
(config-router)#network 10.10.11.0/24 area 1	Define the other interface (10.10.11.0/24) on which OSPF runs, and associate the area ID (1) with the interface.
(config-router)#commit	Commit the candidate configuration to the running configuration.

Validation

R2

```
#show running-config
!
no service password-encryption
!
hostname R2
!
logging monitor 7
!
```

```
ip vrf management
!
ip domain-lookup
!
ip pim register-rp-reachability
!
interface lo
  mtu 65536
  ip address 127.0.0.1/8
  ipv6 address ::1/128
!
interface eth0
  ip address 10.12.26.89/24
!
interface eth1
  ip address 10.10.11.11/24
!
interface eth2
  ip address 10.10.10.11/24
!
interface eth3
!
interface eth4
!
interface eth5
!
interface eth6
!
router ospf 100
  network 10.10.10.0/24 area 0.0.0.0
  network 10.10.11.0/24 area 0.0.0.1

!
line con 0
  login
line vty 0 39
  login
!
end

#sh ip ospf
Routing Process "ospf 100" with ID 10.12.26.89
Process uptime is 4 minutes
Process bound to VRF default
Conforms to RFC2328, and RFC1583 Compatibility flag is disabled
Supports only single TOS(TOS0) routes
Supports opaque LSA
Supports Graceful Restart
This router is an ABR, ABR Type is Alternative Cisco (RFC3509)
SPF schedule delay initial 0 secs 500 msec
SPF schedule delay min 0 secs 500 msec
SPF schedule delay max 50 secs 0 msec
Refresh timer 10 secs
Number of incoming current DD exchange neighbors 0/64
Number of outgoing current DD exchange neighbors 0/64
Initial LSA throttle delay 0 secs 0 msec
Minimum hold time for LSA throttle 5 secs 0 msec
```



```
Maximum wait time for LSA throttle 5 secs 0 msec
Minimum LSA arrival 1 secs 0 msec
Number of external LSA 0. Checksum 0x000000
Number of opaque AS LSA 0. Checksum 0x000000
Number of non-default external LSA 0
External LSA database is unlimited.
Number of LSA originated 9
Number of LSA received 18
Number of areas attached to this router: 2
  Area 0.0.0.0 (BACKBONE)
    Number of interfaces in this area is 1(1)
    Number of fully adjacent neighbors in this area is 2
    Area has no authentication
    SPF algorithm last executed 00:01:54.085 ago
    SPF algorithm executed 7 times
    Number of LSA 11. Checksum 0x0428ac
  Area 0.0.0.1
    Number of interfaces in this area is 1(1)
    Number of fully adjacent neighbors in this area is 1
    Number of fully adjacent virtual neighbors through this area is 0
    Area has no authentication
    SPF algorithm last executed 00:00:41.737 ago
SPF algorithm executed 3 times
  Number of LSA 8. Checksum 0x043ce4
Dste Staus: Disabled

#show ip ospf interface
eth2 is up, line protocol is up
  Internet Address 10.10.10.11/24, Area 0.0.0.0, MTU 1500
  Process ID 100, VRF (default), Router ID 10.12.26.89, Network Type
BROADCAST, Cost: 1
  Transmit Delay is 1 sec, State DR, Priority 1, TE Metric 1
  Designated Router (ID) 10.12.26.89, Interface Address 10.10.10.11
  Backup Designated Router (ID) 10.12.26.88, Interface Address 10.10.10.10
  Timer intervals configured, Hello 10, Dead 40, Wait 40, Retransmit 5
  Hello due in 00:00:11
  Neighbor Count is 2, Adjacent neighbor count is 2
  Suppress hello for 0 neighbor(s)
  Hello received 66 sent 38, DD received 11 sent 7
  LS-Req received 2 sent 2, LS-Upd received 15 sent 14
  LS-Ack received 14 sent 10, Discarded 0
  No authentication
eth1 is up, line protocol is up
  Internet Address 10.10.11.11/24, Area 0.0.0.1, MTU 1500
  Process ID 100, VRF (default), Router ID 10.12.26.89, Network Type
BROADCAST, Cost: 1
  Transmit Delay is 1 sec, State Backup, Priority 1, TE Metric 1
  Designated Router (ID) 10.12.26.92, Interface Address 10.10.11.13
  Backup Designated Router (ID) 10.12.26.89, Interface Address 10.10.11.11
  Timer intervals configured, Hello 10, Dead 40, Wait 40, Retransmit 5
  Hello due in 00:00:03
  Neighbor Count is 1, Adjacent neighbor count is 1
  Suppress hello for 0 neighbor(s)
  Hello received 22 sent 24, DD received 3 sent 9
  LS-Req received 1 sent 1, LS-Upd received 4 sent 5
  LS-Ack received 4 sent 3, Discarded 0
  No authentication
```

```
#show ip ospf neighbor
```

```
Total number of full neighbors: 3
```

```
OSPF process 100 VRF(default):
```

Neighbor ID Instance ID	Pri	State	Dead Time	Address	Interface
10.12.26.88 0	1	Full/Backup	00:00:34	10.10.10.10	eth2
10.12.26.90 0	1	Full/DROther	00:00:32	10.10.10.12	eth2
10.12.26.92 0	1	Full/DR	00:00:33	10.10.11.13	eth1

```
#show ip ospf database
```

```
OSPF Router with ID (10.12.26.89) (Process ID 100 VRF default)
```

```
Router Link States (Area 0.0.0.0)
```

Link ID	ADV Router	Age	Seq#	CkSum	Link count
10.12.26.88	10.12.26.88	365	0x80000005	0x10bc	1
10.12.26.89	10.12.26.89	312	0x80000006	0x0fb8	1
10.12.26.90	10.12.26.90	363	0x80000003	0x10b8	1

```
Net Link States (Area 0.0.0.0)
```

Link ID	ADV Router	Age	Seq#	CkSum
10.10.10.11	10.12.26.89	364	0x80000002	0xe7fd

```
Summary Link States (Area 0.0.0.0)
```

Link ID	ADV Router	Age	Seq#	CkSum	Route
10.10.11.0	10.12.26.89	312	0x80000001	0x95fd	10.10.11.0/24

```
Area-Local Opaque-LSA (Area 0.0.0.0)
```

Link ID	ADV Router	Age	Seq#	CkSum	Opaque ID
1.0.0.1	10.12.26.88	363	0x80000003	0xa972	1
1.0.0.1	10.12.26.89	362	0x80000003	0xad6c	1
1.0.0.1	10.12.26.90	363	0x80000001	0xb564	1
1.0.0.10	10.12.26.88	363	0x80000003	0x0a32	10
1.0.0.10	10.12.26.89	362	0x80000002	0x2417	10
1.0.0.10	10.12.26.90	363	0x80000001	0x3efb	10

```
Router Link States (Area 0.0.0.1)
```

Link ID	ADV Router	Age	Seq#	CkSum	Link count
10.12.26.89	10.12.26.89	245	0x80000004	0x3d88	1
10.12.26.92	10.12.26.92	241	0x80000004	0x2698	1

```
Net Link States (Area 0.0.0.1)
```

Link ID	ADV Router	Age	Seq#	CkSum
10.10.11.13	10.12.26.92	246	0x80000001	0x6ffb

```
Summary Link States (Area 0.0.0.1)
```

Link ID	ADV Router	Age	Seq#	CkSum	Route
10.10.10.0	10.12.26.89	312	0x80000001	0xa0f3	10.10.10.0/24

Area-Local Opaque-LSA (Area 0.0.0.1)

Link ID	ADV Router	Age	Seq#	CkSum	Opaque ID
1.0.0.1	10.12.26.89	243	0x80000001	0xb16a	1
1.0.0.1	10.12.26.92	244	0x80000001	0xbd58	1
1.0.0.8	10.12.26.89	234	0x80000002	0x96a2	8
1.0.0.8	10.12.26.92	244	0x80000001	0xc272	8

Redistribute Routes into OSPF

In this example, the configuration causes BGP routes to be imported into the OSPF routing table, and advertised as Type 5 External LSAs into Area 0.

Topology

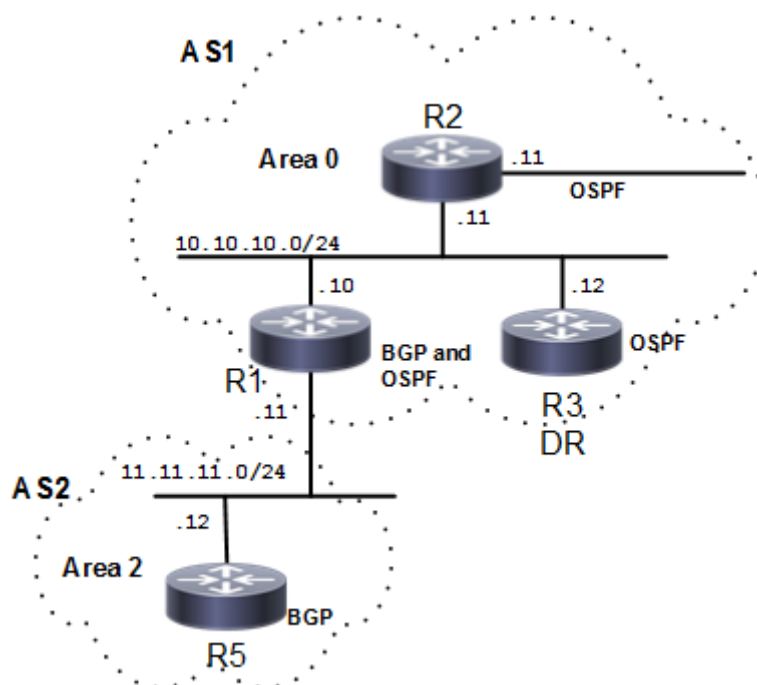

Figure 8-67: Redistribute Routes

R1

#configure terminal	Enter configure mode.
(config)#router ospf 100	Configure the routing process, and specify the Process ID (100). The Process ID should be a unique positive integer identifying the routing process.
(config-router)#network 10.10.10.0/24 area 0	Define one interface (10.10.10.0/24) on which OSPF runs, and associate the area ID (0) with the interface (area ID 0 specifies the backbone area).

(config-router)#redistribute bgp	Specify redistributing routes from other routing protocol (BGP) into OSPF.
(config-router)#commit	Commit the candidate configuration to the running configuration.

Validation

```
#show ip ospf route
```

```
OSPF process 100:
```

```
Codes: C - connected, D - Discard, O - OSPF, IA - OSPF inter area  
N1 - OSPF NSSA external type 1, N2 - OSPF NSSA external type 2  
E1 - OSPF external type 1, E2 - OSPF external type 2
```

```
C 10.10.9.0/24 [1] is directly connected, eth2, Area 0.0.0.0  
C 10.10.10.0/24 [1] is directly connected, eth3, Area 0.0.0.0  
O 10.10.11.0/24 [101] via 10.10.10.11, eth3, Area 0.0.0.0  
C 10.10.12.0/24 [1] is directly connected, eth1, Area 0.0.0.0  
O 10.10.13.0/24 [102] via 10.10.10.11, eth3, Area 0.0.0.0  
O 10.10.14.0/24 [102] via 10.10.10.11, eth3, Area 0.0.0.0
```

Cost

A route can be made the preferred route by changing its cost. In this example, cost has been configured to make R2 the next hop for R1.

The default cost for each interface is 1. Interface eth2 on R2 has a cost of 100, and Interface eth2 on R3 has a cost of 150. The total cost to reach 10.10.14.0/24 (R4) through R2 and R3 is computed as follows:

R2: $1+100 = 101$

R3: $1+150 = 151$

Therefore, R1 chooses R2 as its next hop to destination 10.10.14.0/24 because it has the lower cost.

Topology

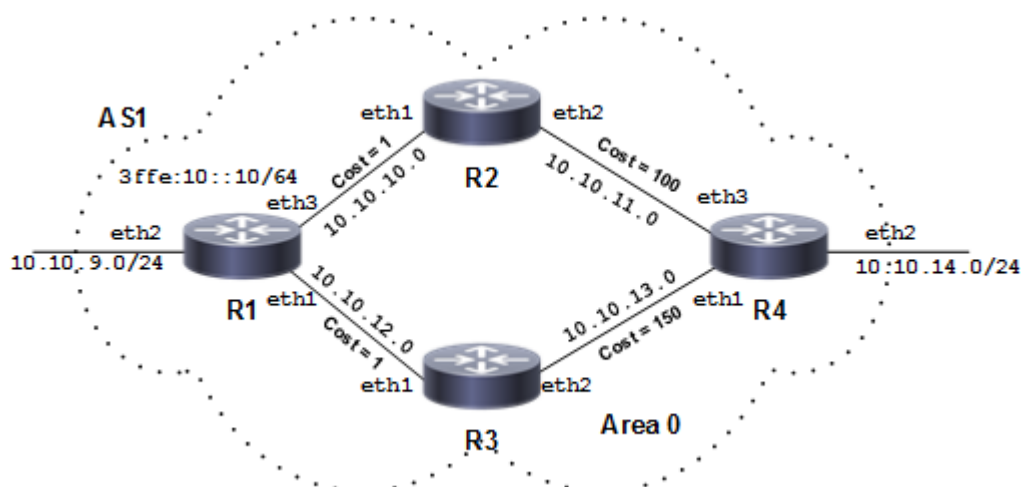

Figure 8-68: Configure Cost Topology

Configuration

R1

#configure terminal	Enter configure mode.
(config)#router ospf 100	Configure the routing process, and specify the Process ID (100). The Process ID should be a unique positive integer identifying the routing process.
(config-router)#network 10.10.9.0/24 area 0	Define interfaces on which OSPF runs, and associate the area ID (0) with the interface (area ID 0 specifies the backbone area).
(config-router)#network 10.10.10.0/24 area 0	Define interfaces on which OSPF runs, and associate the area ID (0) with the interface (area ID 0 specifies the backbone area).
(config-router)#network 10.10.12.0/24 area 0	Define interfaces on which OSPF runs, and associate the area ID (0) with the interface (area ID 0 specifies the backbone area).
(config-router)#commit	Commit the candidate configuration to the running configuration.

R2

(config)#interface eth2	Enter interface mode.
(config-if)#ip ospf cost 100	Set the OSPF cost of this link to 100.
(config-if)#exit	Exit interface mode.
(config)#router ospf 100	Configure the routing process, and specify the Process ID (100). The Process ID should be a unique positive integer identifying the routing process.
(config-router)#network 10.10.10.0/24 area 0	Define the interfaces on which OSPF runs, and associate the area ID (0) with the interface.
(config-router)#network 10.10.11.0/24 area 0	Define the interfaces on which OSPF runs, and associate the area ID (0) with the interface.
(config-router)#commit	Commit the candidate configuration to the running configuration.

R3

(config)#interface eth2	Enter interface mode.
(config-if)#ip ospf cost 150	Set the OSPF cost of this link to 100.
(config-if)#exit	Exit interface mode.
(config)#router ospf 100	Configure the routing process, and specify the Process ID (100). The Process ID should be a unique positive integer identifying the routing process.
(config-router)#network 10.10.12.0/24 area 0	Define interfaces on which OSPF runs, and associate the area ID (0) with the interface.

OSPFv2

(config-router)#network 10.10.13.0/24 area 0	Define interfaces on which OSPF runs, and associate the area ID (0) with the interface.
(config-router)#commit	Commit the candidate configuration to the running configuration.

R4

(config)#router ospf 100	Configure the routing process, and specify the Process ID (100). The Process ID should be a unique positive integer identifying the routing process.
(config-router)#network 10.10.11.0/24 area 0	Define interfaces on which OSPF runs, and associate the area ID (0) with the interface.
(config-router)#network 10.10.13.0/24 area 0	Define interfaces on which OSPF runs, and associate the area ID (0) with the interface.
(config-router)#network 10.10.14.0/24 area 0	Define interfaces on which OSPF runs, and associate the area ID (0) with the interface.
(config-router)#commit	Commit the candidate configuration to the running configuration.

Validation

R1

```
#show ip ospf route
```

```
OSPF process 100:
```

```
Codes: C - connected, D - Discard, O - OSPF, IA - OSPF inter area  
N1 - OSPF NSSA external type 1, N2 - OSPF NSSA external type 2  
E1 - OSPF external type 1, E2 - OSPF external type 2
```

```
C 10.10.9.0/24 [1] is directly connected, eth2, Area 0.0.0.0  
C 10.10.10.0/24 [1] is directly connected, eth3, Area 0.0.0.0  
O 10.10.11.0/24 [101] via 10.10.10.11, eth3, Area 0.0.0.0  
C 10.10.12.0/24 [1] is directly connected, eth1, Area 0.0.0.0  
O 10.10.13.0/24 [102] via 10.10.10.11, eth3, Area 0.0.0.0  
O 10.10.14.0/24 [102] via 10.10.10.11, eth3, Area 0.0.0.0
```

```
#sh ip ospf interface
```

```
eth3 is up, line protocol is up  
Internet Address 10.10.10.10/24, Area 0.0.0.0, MTU 1500  
Process ID 100, VRF (default), Router ID 10.12.26.88, Network Type  
BROADCAST, Cost: 1  
Transmit Delay is 1 sec, State DR, Priority 1, TE Metric 1  
Designated Router (ID) 10.12.26.88, Interface Address 10.10.10.10  
Backup Designated Router (ID) 10.12.26.89, Interface Address 10.10.10.11  
Timer intervals configured, Hello 10, Dead 40, Wait 40, Retransmit 5  
Hello due in 00:00:03  
Neighbor Count is 1, Adjacent neighbor count is 1  
Suppress hello for 0 neighbor(s)  
Hello received 43 sent 69, DD received 3 sent 4  
LS-Req received 1 sent 1, LS-Upd received 16 sent 18  
LS-Ack received 10 sent 11, Discarded 0  
No authentication  
eth2 is up, line protocol is up
```

```

Internet Address 10.10.9.10/24, Area 0.0.0.0, MTU 1500
Process ID 100, VRF (default), Router ID 10.12.26.88, Network Type
BROADCAST, Cost: 1
Transmit Delay is 1 sec, State DR, Priority 1, TE Metric 1
Designated Router (ID) 10.12.26.88, Interface Address 10.10.9.10
No backup designated router on this network
Timer intervals configured, Hello 10, Dead 40, Wait 40, Retransmit 5
Hello due in 00:00:02
Neighbor Count is 0, Adjacent neighbor count is 0
Suppress hello for 0 neighbor(s)
Hello received 0 sent 68, DD received 0 sent 0
LS-Req received 0 sent 0, LS-Upd received 0 sent 0
LS-Ack received 0 sent 0, Discarded 0
No authentication
eth1 is up, line protocol is up
Internet Address 10.10.12.10/24, Area 0.0.0.0, MTU 1500
Process ID 100, VRF (default), Router ID 10.12.26.88, Network Type
BROADCAST, Cost: 1
Transmit Delay is 1 sec, State DR, Priority 1, TE Metric 1
Designated Router (ID) 10.12.26.88, Interface Address 10.10.12.10
Backup Designated Router (ID) 10.12.26.90, Interface Address 10.10.12.11
Timer intervals configured, Hello 10, Dead 40, Wait 40, Retransmit 5
Hello due in 00:00:01
Neighbor Count is 1, Adjacent neighbor count is 1
Suppress hello for 0 neighbor(s)
Hello received 29 sent 66, DD received 3 sent 4
LS-Req received 1 sent 1, LS-Upd received 10 sent 12
LS-Ack received 10 sent 9, Discarded 0
No authentication

```

R2

```

#sh ip ospf route

OSPF process 100:
Codes: C - connected, D - Discard, O - OSPF, IA - OSPF inter area
       N1 - OSPF NSSA external type 1, N2 - OSPF NSSA external type 2
       E1 - OSPF external type 1, E2 - OSPF external type 2

O 10.10.9.0/24 [2] via 10.10.10.10, eth1, Area 0.0.0.0
C 10.10.10.0/24 [1] is directly connected, eth1, Area 0.0.0.0
C 10.10.11.0/24 [100] is directly connected, eth2, Area 0.0.0.0
O 10.10.12.0/24 [2] via 10.10.10.10, eth1, Area 0.0.0.0
O 10.10.13.0/24 [101] via 10.10.11.11, eth2, Area 0.0.0.0
O 10.10.14.0/24 [101] via 10.10.11.11, eth2, Area 0.0.0.0

#sh ip ospf interface
eth2 is up, line protocol is up
Internet Address 10.10.11.10/24, Area 0.0.0.0, MTU 1500
Process ID 100, VRF (default), Router ID 10.12.26.89, Network Type
BROADCAST, Cost: 100
Transmit Delay is 1 sec, State DR, Priority 1, TE Metric 100
Designated Router (ID) 10.12.26.89, Interface Address 10.10.11.10
Backup Designated Router (ID) 10.12.26.92, Interface Address 10.10.11.11
Timer intervals configured, Hello 10, Dead 40, Wait 40, Retransmit 5
Hello due in 00:00:01
Neighbor Count is 1, Adjacent neighbor count is 1
Suppress hello for 0 neighbor(s)

```

```
Hello received 56 sent 77, DD received 3 sent 4
LS-Req received 1 sent 1, LS-Upd received 11 sent 7
LS-Ack received 4 sent 8, Discarded 0
No authentication
eth1 is up, line protocol is up
Internet Address 10.10.10.11/24, Area 0.0.0.0, MTU 1500
Process ID 100, VRF (default), Router ID 10.12.26.89, Network Type
BROADCAST, Cost: 1
Transmit Delay is 1 sec, State Backup, Priority 1, TE Metric 1
Designated Router (ID) 10.12.26.88, Interface Address 10.10.10.10
Backup Designated Router (ID) 10.12.26.89, Interface Address 10.10.10.11
Timer intervals configured, Hello 10, Dead 40, Wait 40, Retransmit 5
Hello due in 00:00:07
Neighbor Count is 1, Adjacent neighbor count is 1
Suppress hello for 0 neighbor(s)
Hello received 74 sent 75, DD received 4 sent 3
LS-Req received 1 sent 1, LS-Upd received 18 sent 16
LS-Ack received 10 sent 12, Discarded 0
No authentication
```

R3

```
#sh ip ospf route
```

```
OSPF process 100:
```

```
Codes: C - connected, D - Discard, O - OSPF, IA - OSPF inter area
N1 - OSPF NSSA external type 1, N2 - OSPF NSSA external type 2
E1 - OSPF external type 1, E2 - OSPF external type 2
```

```
O 10.10.9.0/24 [2] via 10.10.12.10, eth1, Area 0.0.0.0
O 10.10.10.0/24 [2] via 10.10.12.10, eth1, Area 0.0.0.0
O 10.10.11.0/24 [102] via 10.10.12.10, eth1, Area 0.0.0.0
C 10.10.12.0/24 [1] is directly connected, eth1, Area 0.0.0.0
O 10.10.13.0/24 [103] via 10.10.12.10, eth1, Area 0.0.0.0
O 10.10.14.0/24 [103] via 10.10.12.10, eth1, Area 0.0.0.0
```

```
#sh ip ospf interface
```

```
eth2 is up, line protocol is up
Internet Address 10.10.13.10/24, Area 0.0.0.0, MTU 1500
Process ID 100, VRF (default), Router ID 10.12.26.90, Network Type
BROADCAST, Cost: 150
Transmit Delay is 1 sec, State DR, Priority 1, TE Metric 150
Designated Router (ID) 10.12.26.90, Interface Address 10.10.13.10
Backup Designated Router (ID) 10.12.26.92, Interface Address 10.10.13.11
Timer intervals configured, Hello 10, Dead 40, Wait 40, Retransmit 5
Hello due in 00:00:02
Neighbor Count is 1, Adjacent neighbor count is 1
Suppress hello for 0 neighbor(s)
Hello received 85 sent 94, DD received 3 sent 4
LS-Req received 0 sent 0, LS-Upd received 3 sent 4
LS-Ack received 3 sent 3, Discarded 0
No authentication
eth1 is up, line protocol is up
Internet Address 10.10.12.11/24, Area 0.0.0.0, MTU 1500
Process ID 100, VRF (default), Router ID 10.12.26.90, Network Type
BROADCAST, Cost: 1
Transmit Delay is 1 sec, State Backup, Priority 1, TE Metric 1
```

```
Designated Router (ID) 10.12.26.88, Interface Address 10.10.12.10
Backup Designated Router (ID) 10.12.26.90, Interface Address 10.10.12.11
Timer intervals configured, Hello 10, Dead 40, Wait 40, Retransmit 5
  Hello due in 00:00:01
Neighbor Count is 1, Adjacent neighbor count is 1
Suppress hello for 0 neighbor(s)
Hello received 92 sent 92, DD received 4 sent 3
LS-Req received 1 sent 1, LS-Upd received 12 sent 10
LS-Ack received 8 sent 10, Discarded 0
No authentication
```

R4

```
#sh ip ospf route
```

```
OSPF process 100:
Codes: C - connected, D - Discard, O - OSPF, IA - OSPF inter area
      N1 - OSPF NSSA external type 1, N2 - OSPF NSSA external type 2
      E1 - OSPF external type 1, E2 - OSPF external type 2

O 10.10.9.0/24 [3] via 10.10.11.10, eth3, Area 0.0.0.0
                   via 10.10.13.10, eth1, Area 0.0.0.0
O 10.10.10.0/24 [2] via 10.10.11.10, eth3, Area 0.0.0.0
C 10.10.11.0/24 [1] is directly connected, eth3, Area 0.0.0.0
O 10.10.12.0/24 [2] via 10.10.13.10, eth1, Area 0.0.0.0
C 10.10.13.0/24 [1] is directly connected, eth1, Area 0.0.0.0
C 10.10.14.0/24 [1] is directly connected, eth2, Area 0.0.0.0
```

```
#sh ip ospf interface
```

```
eth3 is up, line protocol is up
  Internet Address 10.10.11.11/24, Area 0.0.0.0, MTU 1500
  Process ID 100, VRF (default), Router ID 10.12.26.92, Network Type
  BROADCAST, Cost: 1
  Transmit Delay is 1 sec, State Backup, Priority 1, TE Metric 1
  Designated Router (ID) 10.12.26.89, Interface Address 10.10.11.10
  Backup Designated Router (ID) 10.12.26.92, Interface Address 10.10.11.11
  Timer intervals configured, Hello 10, Dead 40, Wait 40, Retransmit 5
  Hello due in 00:00:04
  Neighbor Count is 1, Adjacent neighbor count is 1
  Suppress hello for 0 neighbor(s)
  Hello received 95 sent 96, DD received 4 sent 3
  LS-Req received 1 sent 1, LS-Upd received 7 sent 11
  LS-Ack received 7 sent 5, Discarded 0
  No authentication

eth2 is up, line protocol is up
  Internet Address 10.10.14.10/24, Area 0.0.0.0, MTU 1500
  Process ID 100, VRF (default), Router ID 10.12.26.92, Network Type
  BROADCAST, Cost: 1
  Transmit Delay is 1 sec, State DR, Priority 1, TE Metric 1
  Designated Router (ID) 10.12.26.92, Interface Address 10.10.14.10
  No backup designated router on this network
  Timer intervals configured, Hello 10, Dead 40, Wait 40, Retransmit 5
  Hello due in 00:00:10
  Neighbor Count is 0, Adjacent neighbor count is 0
  Suppress hello for 0 neighbor(s)
  Hello received 0 sent 95, DD received 0 sent 0
  LS-Req received 0 sent 0, LS-Upd received 0 sent 0
```

```

LS-Ack received 0 sent 0, Discarded 0
No authentication
eth1 is up, line protocol is up
Internet Address 10.10.13.11/24, Area 0.0.0.0, MTU 1500
Process ID 100, VRF (default), Router ID 10.12.26.92, Network Type
BROADCAST, Cost: 1
Transmit Delay is 1 sec, State Backup, Priority 1, TE Metric 1
Designated Router (ID) 10.12.26.90, Interface Address 10.10.13.10
Backup Designated Router (ID) 10.12.26.92, Interface Address 10.10.13.11
Timer intervals configured, Hello 10, Dead 40, Wait 40, Retransmit 5
Hello due in 00:00:00
Neighbor Count is 1, Adjacent neighbor count is 1
Suppress hello for 0 neighbor(s)
Hello received 92 sent 93, DD received 4 sent 3
LS-Req received 0 sent 0, LS-Upd received 4 sent 3
LS-Ack received 3 sent 3, Discarded 0
No authentication
    
```

Path MTU for IPv4 and IPv6

In IPv4, path MTU discovery enables a host to actively identify and adapt to variations in the MTU size across different links along a data path. In contrast, IPv6 adopts an approach where fragmentation is managed by the packet's source when the path MTU of a specific link along the data path cannot accommodate the packet's size. This approach, where IPv6 hosts handle packet fragmentation, conserves processing resources in IPv6 devices and enhances the overall efficiency of IPv6 networks.

Topology

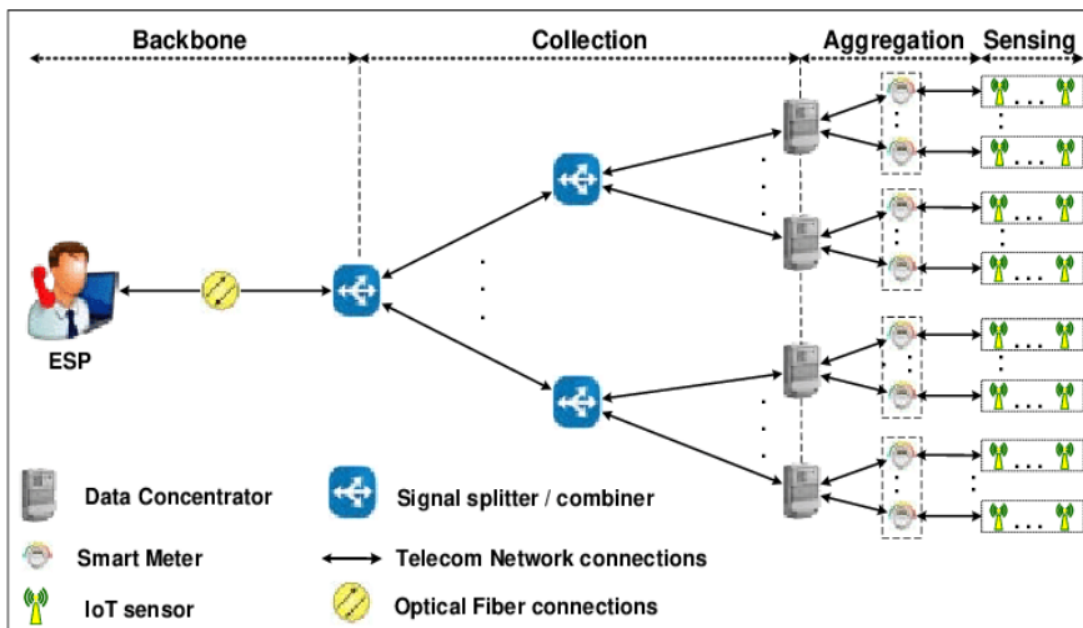

Figure 8-69: Path MTU Topology

R1

OcNOS#configure terminal	Enter configuration mode.
OcNOS (config)#interface cd31/1	Entering in to interface
OcNOS (config-if)#mtu 1500	Configure mtu
OcNOS (config-if)#ip address 12.12.12.1/24	Configure ipv4 address
OcNOS (config-if)#ipv6 address 1001::1/64	Configure ipv6 address
OcNOS (config)#router ospf 1	Configure ip ospf
OcNOS (config-router)#ospf router-id 20.20.20.1	Configure router id under ospf
OcNOS (config-router)#network 12.12.12.0/24 area 0.0.0.0	Add network under ospf
OcNOS (config)#router ipv6 ospf 1	Configure ipv6 ospf
OcNOS (config-router)#router-id 1.1.1.1	Configure router id under ospf
OcNOS (config-router)#commit	Commit all the transactions
OcNOS (config)#exit	Exit

R2

OcNOS#configure terminal	Enter configuration mode.
OcNOS (config)#interface cd31/1	Entering in to interface
OcNOS (config-if)#mtu 1500	Configure mtu
OcNOS (config-if)#ip address 12.12.12.1/24	Configure ipv4 address
OcNOS (config-if)#ipv6 address 1001::1/64	Configure ipv6 address
OcNOS (config)#router ospf 1	Configure ip ospf
OcNOS (config-router)#ospf router-id 20.20.20.1	Configure router id under ospf
OcNOS (config-router)#network 12.12.12.0/24 area 0.0.0.0	Add network under ospf
OcNOS (config)#router ipv6 ospf 1	Configure ipv6 ospf
OcNOS (config-router)#router-id 1.1.1.1	Configure router id under ospf
OcNOS (config-router)#commit	Commit all the transactions
OcNOS (config)#exit	Exit

Validation

```
OcNOS#sh in
installers interface
OcNOS#sh interface cd31/1
Interface cd31/1
 Flexport: Non Control Port (Active)
 Hardware is ETH Current HW addr: e49d.7356.df24
 Physical:e49d.7356.df24 Logical:(not set)
 Forward Error Correction (FEC) configured is Auto (default)
 FEC status is N/A
 Port Mode is Router
```

```
Protected Mode is Promiscuous
Interface index: 10142
Metric 1 mtu 1700 duplex-full link-speed 10g
Debounce timer: disable
ARP ageing timeout 1500
<UP,BROADCAST,RUNNING,MULTICAST>
VRF Binding: Not bound
DHCP client is disabled.
Last Flapped: Never
Statistics last cleared: 2023 Apr 03 17:24:58 (18:36:43 ago)
inet6 fe80::e69d:73ff:fe56:df24/64
ND router advertisements are sent approximately every 411 seconds
ND next router advertisement due in 176 seconds.
ND router advertisements live for 1800 seconds
Hosts use stateless autoconfig for addresses.
5 minute input rate 3 bits/sec, 0 packets/sec
5 minute output rate 1 bits/sec, 0 packets/sec
RX
  unicast packets 0 multicast packets 180 broadcast packets 0
  input packets 180 bytes 15000
  jumbo packets 0
  undersize 0 oversize 0 CRC 0 fragments 0 jabbers 0
  input error 0
  input with dribble 0 input discard 0
  Rx pause 0
TX
  unicast packets 0 multicast packets 176 broadcast packets 0
  output packets 176 bytes 14632
  jumbo packets 0
  output errors 0 collision 0 deferred 0 late collision 0
  output discard 0
  Tx pause 0
```

Virtual Links

Virtual links are used to connect a temporarily-disjointed non-backbone area to the backbone area, or to repair a non-contiguous backbone area. In this example, the ABR R3 has temporarily lost connection to Area 0, in turn, disconnecting Area 2 from the backbone area. The virtual link between ABR R1 and ABR R2 connects Area 2 to Area 0. Area 1 is used as a transit area.

Topology

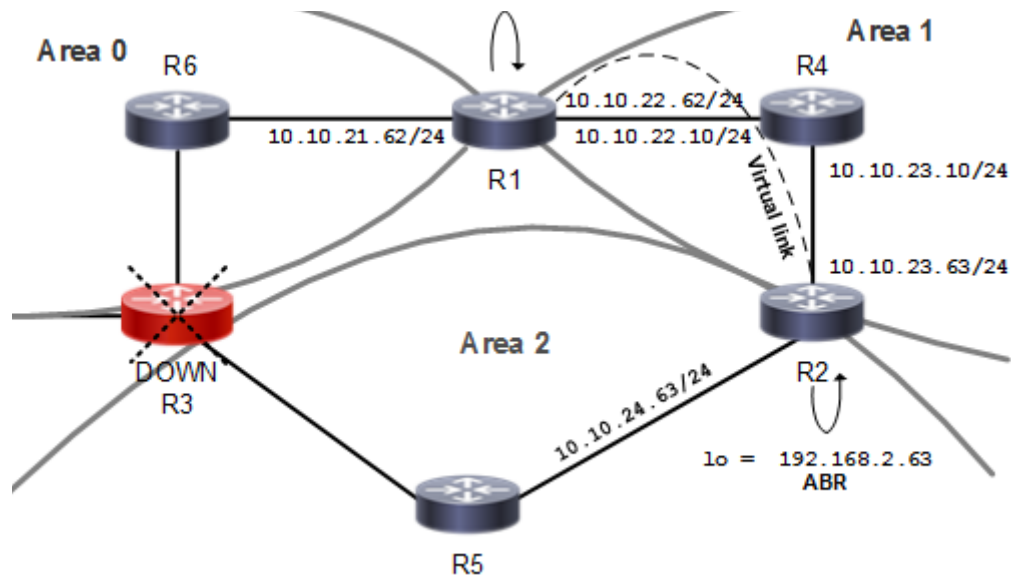

Figure 8-70: Virtual Links Topology

R1

#configure terminal	Enter configure mode.
(config)#interface lo	Specify loopback as the interface you want to configure.
(config-if)#ip address 192.168.1.62/32	Configure the IP address on this interface.
(config-if)#exit	Exit interface mode.
(config)#router ospf 100	Configure the routing process, and specify the Process ID (100). The Process ID should be a unique positive integer identifying the routing process.
(config-router)#ospf router-id 192.168.1.62	Configure the OSPF Router ID (192.168.1.62) for this router.
(config-router)#network 10.10.21.0/24 area 0 (config-router)#network 10.10.22.0/24 area 1	Define interfaces on which OSPF runs, and associate the area IDs (0 and 1) with the interface.
(config-router)#area 1 virtual-link 192.168.2.63	Configure a virtual link between this router R1 and R2 (Router ID 192.168.2.63) through transit area 1.

R2

(config)#interface lo	Specify loopback as the interface you want to configure.
(config-if)#ip address 192.168.2.63/32	Configure the IP address on this interface.
(config-if)#exit	Exit interface mode.
(config)#router ospf 100	Configure the routing process, and specify the Process ID (100). The Process ID should be a unique positive integer identifying the routing process.
(config-router)#ospf router-id 192.168.2.63	Configure the OSPF Router ID (192.168.2.63) for this router.

(config-router)#network 10.10.23.0/24 area 1 (config-router)#network 10.10.24.0/24 area 2 (config-router)#network 192.168.2.63/32 area 2	Define interfaces on which OSPF runs, and associate the area IDs (1 and 2) with the interface.
(config-router)#area 1 virtual-link 192.168.1.62	Configure a virtual link between this router R2 and R1 (Router ID 192.168.2.62) through transit area 1.

Validation

```
R1#show ip ospf virtual-links
Virtual Link VLINK0 to router 2.2.2.2 is up
  Transit area 0.0.0.1 via interface eth2
  Hello suppression enabled
  DoNotAge LSA allowed
  Local address 13.13.13.1/32
  Remote address 12.12.12.1/32
  Transmit Delay is 1 sec, State Point-To-Point,
  Timer intervals configured, Hello 10, Dead 40, Wait 40, Retransmit 5
  Hello due in 00:00:05
  No authentication
  Adjacency state Down
```

```
R2#show ip ospf virtual-links
Virtual Link VLINK0 to router 1.1.1.1 is up
  Transit area 0.0.0.1 via interface eth1
  Hello suppression enabled
  DoNotAge LSA allowed
  Local address 12.12.12.1/32
  Remote address 13.13.13.1/32
  Transmit Delay is 1 sec, State Point-To-Point,
  Timer intervals configured, Hello 10, Dead 40, Wait 40, Retransmit 5
  Hello due in 00:00:05
  No authentication
  Adjacency state Init
```

```
R1#show ip ospf neighbor
```

```
Total number of full neighbors: 1
OSPF process 100 VRF(default):
Neighbor ID   Pri  State           Dead Time   Address      Interface
Instance ID
192.168.20.5  1    Full/DR         00:00:34   13.13.13.2  eth2
0
```

```
R2#show ip ospf neighbor
```

```
Total number of full neighbors: 1
OSPF process 100 VRF(default):
Neighbor ID   Pri  State           Dead Time   Address      Interface
Instance ID
192.168.20.5  1    Full/DR         00:00:36   12.12.12.2  eth1
0
1.1.1.1       1    Init/ -         00:00:32   13.13.13.1  VLINK0
R1#show ip ospf route
```

```
OSPF process 100:
Codes: C - connected, D - Discard, O - OSPF, IA - OSPF inter area
       N1 - OSPF NSSA external type 1, N2 - OSPF NSSA external type 2
       E1 - OSPF external type 1, E2 - OSPF external type 2

IA 2.2.2.2/32 [12] via 13.13.13.2, eth2, Area 0.0.0.1
O 12.12.12.0/24 [2] via 13.13.13.2, eth2, Area 0.0.0.1
C 13.13.13.0/24 [1] is directly connected, eth2, Area 0.0.0.1
```

```
R2#show ip ospf route
```

```
OSPF process 100:
Codes: C - connected, D - Discard, O - OSPF, IA - OSPF inter area
       N1 - OSPF NSSA external type 1, N2 - OSPF NSSA external type 2
       E1 - OSPF external type 1, E2 - OSPF external type 2

C 2.2.2.2/32 [10] is directly connected, lo, Area 0.0.0.2
C 12.12.12.0/24 [1] is directly connected, eth1, Area 0.0.0.1
O 13.13.13.0/24 [2] via 12.12.12.2, eth1, Area 0.0.0.1
```

```
R1#show ip ospf
```

```
Routing Process "ospf 100" with ID 1.1.1.1
Process uptime is 39 minutes
Process bound to VRF default
Conforms to RFC2328, and RFC1583 Compatibility flag is disabled
Supports only single TOS(TOS0) routes
Supports opaque LSA
Supports Graceful Restart
This router is an ABR, ABR Type is Alternative Cisco (RFC3509)
SPF schedule delay initial 0 secs 500 msec
SPF schedule delay min 0 secs 500 msec
SPF schedule delay max 50 secs 0 msec
Refresh timer 10 secs
Number of incoming current DD exchange neighbors 0/64
Number of outgoing current DD exchange neighbors 0/64
Initial LSA throttle delay 0 secs 0 msec
Minimum hold time for LSA throttle 5 secs 0 msec
Maximum wait time for LSA throttle 5 secs 0 msec
Minimum LSA arrival 1 secs 0 msec
Number of external LSA 0. Checksum 0x000000
Number of opaque AS LSA 0. Checksum 0x000000
Number of non-default external LSA 0
External LSA database is unlimited.
Number of LSA originated 6
Number of LSA received 15
Number of areas attached to this router: 2
MemPool - struct ospf lsa : (0-16) | Total (16/100000)
blk_size:160
MemPool - struct rxmt : | Total (0/0) blk_size:8
Area 0.0.0.0 (BACKBONE)
Number of interfaces in this area is 1(1)
Number of fully adjacent neighbors in this area is 0
Area has no authentication
SPF algorithm last executed 00:10:05.434 ago
SPF algorithm executed 1 times
Number of LSA 3. Checksum 0x01bf9c
Area 0.0.0.1
```

```
Number of interfaces in this area is 1(1)
Number of fully adjacent neighbors in this area is 1
Number of fully adjacent virtual neighbors through this area is 0
Area has no authentication
SPF algorithm last executed 00:09:57.432 ago
SPF algorithm executed 7 times
Number of LSA 13. Checksum 0x076e78
Dste Staus: Disabled
```

```
R2#show ip ospf
Routing Process "ospf 100" with ID 2.2.2.2
Process uptime is 16 hours 48 minutes
Process bound to VRF default
Conforms to RFC2328, and RFC1583 Compatibility flag is disabled
Supports only single TOS(TOS0) routes
Supports opaque LSA
Supports Graceful Restart
This router is an ABR, ABR Type is Alternative Cisco (RFC3509)
SPF schedule delay initial 0 secs 500 msec
SPF schedule delay min 0 secs 500 msec
SPF schedule delay max 50 secs 0 msec
Refresh timer 10 secs
Number of incoming current DD exchange neighbors 0/64
Number of outgoing current DD exchange neighbors 0/64
Initial LSA throttle delay 0 secs 0 msec
Minimum hold time for LSA throttle 5 secs 0 msec
Maximum wait time for LSA throttle 5 secs 0 msec
Minimum LSA arrival 1 secs 0 msec
Number of external LSA 0. Checksum 0x000000
Number of opaque AS LSA 0. Checksum 0x000000
Number of non-default external LSA 0
External LSA database is unlimited.
Number of LSA originated 11
Number of LSA received 12
Number of areas attached to this router: 3
MemPool - struct ospf lsa          : (0-20) | Total (20/100000)
blk_size:160
MemPool - struct rxmt              : | Total (0/0) blk_size:8
Area 0.0.0.0 (BACKBONE)
Number of interfaces in this area is 1(1)
Number of fully adjacent neighbors in this area is 0
Area has no authentication
SPF algorithm last executed 00:11:05.618 ago
SPF algorithm executed 1 times
Number of LSA 4. Checksum 0x018ce2
Area 0.0.0.1
Number of interfaces in this area is 1(1)
Number of fully adjacent neighbors in this area is 1
Number of fully adjacent virtual neighbors through this area is 0
Area has no authentication
SPF algorithm last executed 00:11:03.619 ago
SPF algorithm executed 6 times
Number of LSA 13. Checksum 0x076e78
Area 0.0.0.2
Number of interfaces in this area is 1(1)
Number of fully adjacent neighbors in this area is 0
Number of fully adjacent virtual neighbors through this area is 0
```



```

Area has no authentication
SPF algorithm last executed 00:11:05.618 ago
SPF algorithm executed 3 times
Number of LSA 3. Checksum 0x0139cf
Dste Staus: Disabled

```

OSPF Authentication

There are three types of OSPF authentications--Null (Type 0), Simple Text (Type 1), and MD5 (Type 2). With Null authentication, routing exchanges over the network are not authenticated. In Simple Text authentication, the authentication type is the same for all routers that communicate using OSPF in a network. For MD5 authentication, configure a key and a key ID on each router. The router generates a message digest on the basis of the key, key ID, and OSPF packet, and adds it to the OSPF packet.

The authentication type can be configured on a per-interface basis or a per-area basis. Additionally, Interface and Area authentication can be used together. Area authentication is used for an area, and interface authentication is used for a specific interface in the area. If the Interface authentication type is different from the Area authentication type, the Interface authentication type overrides the Area authentication type. If the Authentication type is not specified for an interface, the Authentication type for the area is used. The authentication command descriptions contain details of each type of authentication.

In the example below, R1 and R2 are configured for both the interface and area authentications. The authentication type of interface eth1 on R1 and interface eth2 on R2 is MD5 mode, and is defined by the area authentication command; however, the authentication type of interface eth2 on R1 and interface eth1 on R2 is plain text mode, and is defined by the `ip ospf authentication` command. This interface command overrides the `area authentication` command.

Topology

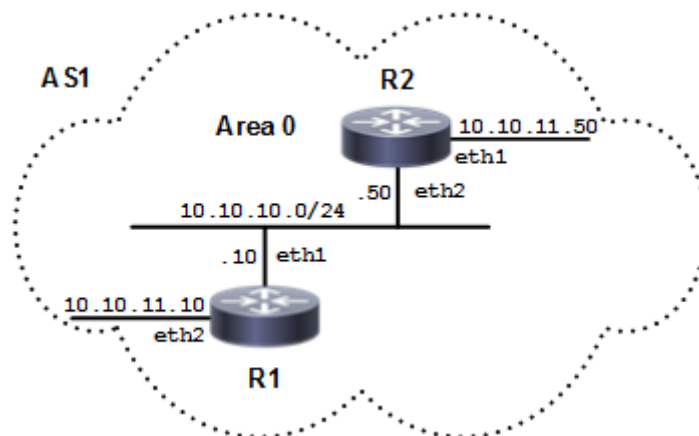

Figure 8-71: OSPF Authentication Topology

R1

#configure terminal	Enter configure mode.
(config)#router ospf 100	Configure the routing process, and specify the Process ID (100). The Process ID should be a unique positive integer identifying the routing process.

OSPFv2

(config-router)#network 10.10.10.0/24 area 0	Define interfaces on which OSPF runs, and associate the area ID (0) with the interface (area ID 0 specifies the backbone area).
(config-router)#network 10.10.11.0/24 area 0	Define interfaces on which OSPF runs, and associate the area ID (0) with the interface (area ID 0 specifies the backbone area).
(config-router)#area 0 authentication message-digest	Enable MD5 authentication on area 0.
(config-router)#exit	Exit Router mode, and return to Configure mode.
(config)#interface eth1	Enter interface mode.
(config-if)#ip ospf message-digest-key 1 md5 test	Register the MD5 key test for OSPF authentication. The key ID is 1.
(config-if)#exit	Exit interface mode
(config)#interface eth2	Enter interface mode.
(config-if)#ip ospf authentication	Enable the OSPF packet to use text authentication on the current interface (eth2).
(config-if)#ip ospf authentication-key test	Specify an OSPF authentication password (test) for the neighboring routers.
(config-if)#commit	Commit the candidate configuration to the running configuration.

R2

#configure terminal	Enter configure mode.
(config)#router ospf 100	Configure the routing process, and specify the Process ID (100). The Process ID should be a unique positive integer identifying the routing process.
(config-router)#network 10.10.10.0/24 area 0	Define interfaces on which OSPF runs, and associate the area ID (0) with the interface (area ID 0 specifies the backbone area).
(config-router)#network 10.10.11.0/24 area 0	Define interfaces on which OSPF runs, and associate the area ID (0) with the interface (area ID 0 specifies the backbone area).
(config-router)#area 0 authentication message-digest	Enable MD5 authentication on area 0.
(config-router)#exit	Exit Router mode, and return to Configure mode.
(config)#interface eth2	Enter interface mode.
(config-if)#ip ospf message-digest-key 1 md5 test	Register MD5 key test for OSPF authentication. The key ID is 1.
(config-if)#exit	Exit interface mode.
(config)#interface eth1	Enter interface mode.
(config-if)#ip ospf authentication	Enable the OSPF packet to use text authentication on the current interface (eth1).
(config-if)#ip ospf authentication-key test	Specify an OSPF authentication password test for the neighboring routers.
(config-if)#commit	Commit the candidate configuration to the running configuration.

Validation

R1

```
R1#sh running-config
!
no service password-encryption
!
hostname R1
!
logging monitor 7
!
ip vrf management
!
ip domain-lookup
!
ip pim register-rp-reachability
!
interface lo
  mtu 65536
  ip address 127.0.0.1/8
  ipv6 address ::1/128
!
interface eth0
  ip address 10.12.26.88/24
!
interface eth1
  ip address 10.10.10.10/24
  ip ospf message-digest-key 1 md5 0x293da85becc67703
!
interface eth2
  ip address 10.10.11.10/24
  ip ospf authentication
  ip ospf authentication-key 0x293da85becc67703
!
interface eth3
!
interface eth4
!
interface eth5
!
interface eth6
!
interface eth7
!
router ospf 100
  area 0.0.0.0 authentication message-digest
  network 10.10.9.0/24 area 0.0.0.0
  network 10.10.10.0/24 area 0.0.0.0
  network 10.10.11.0/24 area 0.0.0.0
  network 10.10.12.0/24 area 0.0.0.0
!
line con 0
  login
line vty 0 39
```

```
login
!  
end
```

```
R1#sh ip ospf neighbor
```

```
Total number of full neighbors: 1  
OSPF process 100 VRF(default):  
Neighbor ID      Pri   State           Dead Time   Address      Interface  
Instance ID  
10.12.26.89      1    Full/DR         00:00:38   10.10.10.50  eth1  
0
```

R2

```
R2#sh running-config  
!  
no service password-encryption  
!  
hostname R2  
!  
logging monitor 7  
!  
ip vrf management  
!  
ip domain-lookup  
!  
ip pim register-rp-reachability  
!  
interface lo  
mtu 65536  
ip address 127.0.0.1/8  
ipv6 address ::1/128  
!  
interface eth0  
ip address 10.12.26.89/24  
!  
interface eth1  
ip address 10.10.11.50/24  
ip ospf authentication  
ip ospf authentication-key 0x293da85becc67703  
!  
interface eth2  
ip address 10.10.10.50/24  
ip ospf message-digest-key 1 md5 0x293da85becc67703  
ip ospf cost 100  
!  
interface eth3  
!  
interface eth4  
!  
interface eth5  
!  
interface eth6  
!  
router ospf 100  
area 0.0.0.0 authentication message-digest
```

```

network 10.10.10.0/24 area 0.0.0.0
network 10.10.11.0/24 area 0.0.0.0

!
line con 0
  login
line vty 0 39
  login
!
end

R2#sh ip ospf neighbor

Total number of full neighbors: 1
OSPF process 100 VRF(default):
Neighbor ID      Pri   State           Dead Time   Address        Interface
Instance ID
10.12.26.88     1    Full/Backup     00:00:33   10.10.10.10   eth2
0

```

Multiple OSPF Instances

By using multiple OSPF instances, OSPF routes can be segregated, based on their instance number. Routes of one instance are stored differently from routes of another instance running in the same router.

To configure multiple OSPF instances, perform the following procedures referring to the topology diagram below:

1. Enable OSPF on an interface.
2. Enable multiple instances.
3. Configure redistribution among multiple instances.

Note: Optionally, redistribution can be configured with the metric, type or route-map options.

Topology

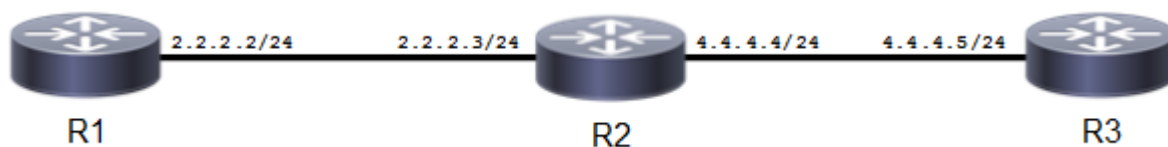

Figure 8-72: Multiple OSPF Instances

Enable Multiple OSPF Instances on a Router

In this example, routers R1, R2, and R3 are in Area 0, and all run OSPF.

R1

(config)#interface eth1	Enter interface mode for eth1.
(config-if)#ip address 2.2.2.2/24	Specify the IP address of the interface.
(config-if)#no shutdown	Activate the interface.

OSPFv2

<code>(config-if)#exit</code>	Exit interface mode.
<code>(config)#router ospf 10</code>	Configure an OSPF instance with an instance ID of 10.
<code>(config-router)#router-id 5.5.5.5</code>	Configure the router ID to use on this instance.
<code>(config-router)#network 2.2.2.0/24 area 0</code>	Advertise the network with the area ID.
<code>(config-router)#commit</code>	Commit the candidate configuration to the running configuration.

R2

<code>(config)#interface eth1</code>	Enter interface mode for eth1.
<code>(config-if)#ip address 2.2.2.3/24</code>	Specify the IP address of the interface.
<code>(config-if)#no shutdown</code>	Activate the interface.
<code>(config-if)#exit</code>	Exit interface mode.
<code>(config)#router ospf 10</code>	Configure an OSPF instance with an instance ID of 10.
<code>(config-router)#router-id 6.6.6.6</code>	Configure the router ID to use on this instance.
<code>(config-router)#network 2.2.2.0/24 area 0</code>	Advertise the network with the area ID.
<code>(config-router)#exit</code>	Exit router mode.
<code>(config)#interface eth2</code>	Enter interface mode for eth2.
<code>(config-if)#ip address 4.4.4.4/24</code>	Configure the IP address.
<code>(config-if)#no shutdown</code>	Activate the interface.
<code>(config-if)#exit</code>	Exit interface mode.
<code>(config)#router ospf 15</code>	Configure an OSPF instance with an instance ID of 15.
<code>(config-router)#router-id 8.8.8.8</code>	Configure the router ID to use on this instance.
<code>(config-router)#network 4.4.4.0/24 area 0</code>	Advertise the network with the area ID.
<code>(config-router)#commit</code>	Commit the candidate configuration to the running configuration.

R3

<code>(config)#interface eth1</code>	Enter interface mode for eth1.
<code>(config-if)#ip address 4.4.4.5/24</code>	Configure the IP address.
<code>(config-if)#no shutdown</code>	Activate the interface.
<code>(config-if)#exit</code>	Exit interface mode.
<code>(config)#router ospf 15</code>	Configure an OSPF instance with an instance ID of 15.
<code>(config-router)#router-id 7.7.7.7</code>	Configure the router ID to use on this instance.
<code>(config-router)#network 4.4.4.0/24 area 0</code>	Advertise the network with the area ID.
<code>(config-router)#commit</code>	Commit the candidate configuration to the running configuration.

Validation

R1

```
R1#sh running-config
```

```
!  
no service password-encryption  
!  
hostname R1  
!  
logging monitor 7  
!  
ip vrf management  
!  
ip domain-lookup  
!  
ip pim register-rp-reachability  
!  
interface lo  
  mtu 65536  
  ip address 127.0.0.1/8  
  ipv6 address ::1/128  
!  
interface eth0  
  ip address 10.12.26.88/24  
!  
interface eth1  
  ip address 2.2.2.2/24  
!  
interface eth2  
  ip address 10.10.11.10/24  
!  
interface eth3  
!  
interface eth4  
!  
interface eth5  
!  
interface eth6  
!  
interface eth7  
!  
router ospf 10  
  ospf router-id 5.5.5.5  
  network 2.2.2.0/24 area 0.0.0.0  
  
!  
line con 0  
  login  
line vty 0 39  
  login  
!  
end
```

```
R1#sh ip ospf neighbor
```

```
Total number of full neighbors: 1
```

```
OSPF process 10 VRF(default):
```

Neighbor ID Instance ID	Pri	State	Dead Time	Address	Interface
6.6.6.6 0	1	Full/Backup	00:00:39	2.2.2.3	eth1

```
R1#sh ip ospf route
```

```
OSPF process 10:
```

```
Codes: C - connected, D - Discard, O - OSPF, IA - OSPF inter area  
       N1 - OSPF NSSA external type 1, N2 - OSPF NSSA external type 2  
       E1 - OSPF external type 1, E2 - OSPF external type 2
```

```
C 2.2.2.0/24 [1] is directly connected, eth1, Area 0.0.0.0
```

R2

```
R2#sh running-config
```

```
!  
no service password-encryption  
!  
hostname R2  
!  
logging monitor 7  
!  
ip vrf management  
!  
ip domain-lookup  
!  
ip pim register-rp-reachability  
!  
interface lo  
  mtu 65536  
  ip address 127.0.0.1/8  
  ipv6 address ::1/128  
!  
interface eth0  
  ip address 10.12.26.89/24  
!  
interface eth1  
  ip address 2.2.2.3/24  
!  
interface eth2  
  ip address 4.4.4.4/24  
!  
interface eth3  
!  
interface eth4  
!  
interface eth5  
!  
interface eth6  
!  
router ospf 10  
  ospf router-id 6.6.6.6  
  network 2.2.2.0/24 area 0.0.0.0  
  
!  
router ospf 15  
  ospf router-id 8.8.8.8  
  network 4.4.4.0/24 area 0.0.0.0  
  no capability cspf
```



```
!  
line con 0  
  login  
line vty 0 39  
  login  
!  
end
```

```
R2#sh ip ospf neighbor
```

```
Total number of full neighbors: 1  
OSPF process 10 VRF(default):  
Neighbor ID      Pri   State           Dead Time   Address     Interface  
Instance ID  
5.5.5.5          1    Full/DR         00:00:33   2.2.2.2    eth1  
0
```

```
Total number of full neighbors: 1  
OSPF process 15 VRF(default):  
Neighbor ID      Pri   State           Dead Time   Address     Interface  
Instance ID  
7.7.7.7          1    Full/Backup     00:00:31   4.4.4.5    eth2  
0
```

```
R2#sh ip ospf route
```

```
OSPF process 10:  
Codes: C - connected, D - Discard, O - OSPF, IA - OSPF inter area  
       N1 - OSPF NSSA external type 1, N2 - OSPF NSSA external type 2  
       E1 - OSPF external type 1, E2 - OSPF external type 2
```

```
C 2.2.2.0/24 [1] is directly connected, eth1, Area 0.0.0.0
```

```
OSPF process 15:  
Codes: C - connected, D - Discard, O - OSPF, IA - OSPF inter area  
       N1 - OSPF NSSA external type 1, N2 - OSPF NSSA external type 2  
       E1 - OSPF external type 1, E2 - OSPF external type 2
```

```
C 4.4.4.0/24 [1] is directly connected, eth2, Area 0.0.0.0
```

R3

```
R3#sh running-config  
!  
no service password-encryption  
!  
hostname R3  
!  
logging monitor 7  
!  
ip vrf management  
!  
ip domain-lookup  
!  
ip pim register-rp-reachability  
!  
interface lo  
  mtu 65536
```

```

    ip address 127.0.0.1/8
    ipv6 address ::1/128
    !
interface eth0
    ip address 10.12.26.90/24
    !
interface eth1
    ip address 4.4.4.5/24
    !
interface eth2
    ip address 10.10.13.10/24
    !
interface eth3
    !
interface eth4
    !
interface eth5
    !
interface eth6
    !
router ospf 15
    ospf router-id 7.7.7.7
    network 4.4.4.0/24 area 0.0.0.0

    !
line con 0
    login
line vty 0 39
    login
    !
end

```

```
R3#sh ip ospf neighbor
```

```

Total number of full neighbors: 1
OSPF process 15 VRF(default):
Neighbor ID      Pri   State           Dead Time   Address      Interface
Instance ID
8.8.8.8          1    Full/DR         00:00:30   4.4.4.4     eth1
0

```

Redistribute among Multiple Instances

In this example, routes of one instance are redistributed to another instance to enable ping from R1 to R3 or vice versa; and R2 redistributes routes from one instance to another.

R2

(config)#router ospf 15	Configure an OSPF instance with instance ID 15.
(config-router)#router-id 8.8.8.8	Configure the router ID.
(config-router)#redistribute ospf 10	Redistribute instance 10 routes.
(config-router)#redistribute connected	Redistribute connected routes to instance 15.
(config-router)#exit	Exit Router mode, and return to Configure mode.
(config)#router ospf 10	Configure an OSPF instance with instance ID 10.

(config-router)#router-id 6.6.6.6	Configure the router ID.
(config-router)#redistribute ospf 15	Redistribute instance 15 routes.
(config-router)#redistribute connected	Redistribute connected routes to instance 10.
(config-router)#commit	Commit the candidate configuration to the running configuration.

Redistribute with the Metric Option

In this example, on R3, R1 and R2 have each other's routes with a metric of 100.

R2

(config)#router ospf 15	Configure an OSPF instance with instance ID 15.
(config-router)#router-id 8.8.8.8	Configure the router ID.
(config-router)#redistribute ospf 10 metric 100	Redistribute instance 10 routes with metric 100.
(config-router)#redistribute connected	Redistribute connected routes to instance 15.
(config-router)#exit	Exit Router mode, and return to Configure mode.
(config)#router ospf 10	Configure an OSPF instance with instance ID 10.
(config-router)#router-id 6.6.6.6	Configure the router ID.
(config-router)#redistribute ospf 15 metric 100	Redistribute instance 15 routes with metric 100.
(config-router)#redistribute connected	Redistribute connected routes to instance 10.
(config-router)#commit	Commit the candidate configuration to the running configuration.

Redistribute with the Type Option

In this example, on R3, R1 has R3 routes as type 2, and R2 has R1 routes as type 1.

R2

(config)#router ospf 15	Configure an OSPF instance with instance ID 15.
(config-router)#router-id 8.8.8.8	Configure the router ID.
(config-router)#redistribute ospf 10 metric-type 1	Redistribute instance 10 routes with metric-type 1.
(config-router)#redistribute connected	Redistribute connected routes to instance 15.
(config-router)#exit	Exit Router mode, and return to Configure mode.
(config)#router ospf 10	Configure an OSPF instance with instance ID 10.
(config-router)#router-id 6.6.6.6	Configure the router ID.
(config-router)#redistribute ospf 15 metric-type 2	Redistribute instance 15 routes with type 2.
(config-router)#redistribute connected	Redistribute connected routes to instance 10.
(config-router)#commit	Commit the candidate configuration to the running configuration.

Redistribute with the Route-Map Option

R2

(config)#route-map 1 permit 10	Enter route-map mode, specifying route-map ID.
(config-route-map)#set metric 100	Set metric value.
(config-route-map)#set metric-type type-2	Set metric-type.
(config-route-map)#exit	Exit route-map mode.
(config)#route-map 2 permit 10	Enter route-map mode, specifying route-map ID.
(config-route-map)#set metric 200	Set metric value.
(config-route-map)#set metric-type type-1	Set metric-type.
(config-route-map)#exit	Exit route-map mode.
(config)#router ospf 15	Configure an OSPF instance with instance ID 15.
(config-router)#router-id 8.8.8.8	Configure the router ID.
(config-router)#redistribute ospf 10 route-map 1	Redistribute instance 10 routes with route map 1.
(config-router)#redistribute connected	Redistribute connected routes to instance 15.
(config-router)#exit	Exit Router mode, and return to Configure mode.
(config)#router ospf 10	Configure an OSPF instance with instance ID 10.
(config-router)#router-id 6.6.6.6	Configure the router ID.
(config-router)#redistribute ospf 15 route-map 2	Redistribute instance 15 routes with route map 2.
(config-router)#redistribute connected	Redistribute connected routes to instance 10.
(config-router)#commit	Commit the candidate configuration to the running configuration.

Validation

```
R1#show ip ospf neighbor
```

```
Total number of full neighbors: 1
```

```
OSPF process 10 VRF(default):
```

Neighbor ID	Pri	State	Dead Time	Address	Interface
Instance ID					
6.6.6.6	1	Full/DR	00:00:39	2.2.2.3	eth1
0					

```
R2#show ip ospf neighbor
```

```
Total number of full neighbors: 1
```

```
OSPF process 10 VRF(default):
```

Neighbor ID	Pri	State	Dead Time	Address	Interface
Instance ID					
5.5.5.5	1	Full/Backup	00:00:35	2.2.2.2	eth1
0					

```
Total number of full neighbors: 1
```

```
OSPF process 15 VRF(default):
```

Neighbor ID Instance ID	Pri	State	Dead Time	Address	Interface
7.7.7.7 0	1	Full/Backup	00:00:36	4.4.4.5	eth2

R3#show ip ospf neighbor

Total number of full neighbors: 1

OSPF process 15 VRF(default):

Neighbor ID Instance ID	Pri	State	Dead Time	Address	Interface
8.8.8.8 0	1	Full/DR	00:00:40	4.4.4.4	eth2

R1#show ip route

Codes: K - kernel, C - connected, S - static, R - RIP, B - BGP

O - OSPF, IA - OSPF inter area

N1 - OSPF NSSA external type 1, N2 - OSPF NSSA external type 2

E1 - OSPF external type 1, E2 - OSPF external type 2

i - IS-IS, L1 - IS-IS level-1, L2 - IS-IS level-2,

ia - IS-IS inter area, E - EVPN,

v - vrf leaked

* - candidate default

IP Route Table for VRF "default"

```
C    2.2.2.0/24 is directly connected, eth1, 00:08:40
O E1 4.4.4.0/24 [110/201] via 2.2.2.3, eth1, 00:01:18
C    5.5.5.5/32 is directly connected, lo, 00:08:41
O E2 6.6.6.6/32 [110/20] via 2.2.2.3, eth1, 00:01:10
O E2 8.8.8.8/32 [110/20] via 2.2.2.3, eth1, 00:01:10
C    127.0.0.0/8 is directly connected, lo, 00:08:44
C    192.168.20.0/24 is directly connected, eth0, 00:08:40
```

Gateway of last resort is not set

R2#show ip route

Codes: K - kernel, C - connected, S - static, R - RIP, B - BGP

O - OSPF, IA - OSPF inter area

N1 - OSPF NSSA external type 1, N2 - OSPF NSSA external type 2

E1 - OSPF external type 1, E2 - OSPF external type 2

i - IS-IS, L1 - IS-IS level-1, L2 - IS-IS level-2,

ia - IS-IS inter area, E - EVPN,

v - vrf leaked

* - candidate default

IP Route Table for VRF "default"

```
C    2.2.2.0/24 is directly connected, eth1, 5d00h02m
C    4.4.4.0/24 is directly connected, eth2, 5d00h02m
C    6.6.6.6/32 is directly connected, lo, 4d23h59m
C    8.8.8.8/32 is directly connected, lo, 4d23h59m
C    127.0.0.0/8 is directly connected, lo, 5d00h09m
C    192.168.20.0/24 is directly connected, eth0, 5d00h08m
```

Gateway of last resort is not set

R3#show ip route

Codes: K - kernel, C - connected, S - static, R - RIP, B - BGP

O - OSPF, IA - OSPF inter area

N1 - OSPF NSSA external type 1, N2 - OSPF NSSA external type 2

E1 - OSPF external type 1, E2 - OSPF external type 2
i - IS-IS, L1 - IS-IS level-1, L2 - IS-IS level-2,
ia - IS-IS inter area, E - EVPN,
v - vrf leaked
* - candidate default

IP Route Table for VRF "default"

```
O E2 2.2.2.0/24 [110/20] via 4.4.4.4, eth2, 00:02:45
C    4.4.4.0/24 is directly connected, eth2, 00:07:12
C    5.5.5.5/32 is directly connected, lo, 00:16:35
O E2 6.6.6.6/32 [110/20] via 4.4.4.4, eth2, 00:02:45
O E2 8.8.8.8/32 [110/20] via 4.4.4.4, eth2, 00:02:45
C    127.0.0.0/8 is directly connected, lo, 00:16:39
C    192.168.20.0/24 is directly connected, eth0, 00:15:36
```

Gateway of last resort is not set

#show ip ospf route

OSPF process 100:

Codes: C - connected, D - Discard, O - OSPF, IA - OSPF inter area
N1 - OSPF NSSA external type 1, N2 - OSPF NSSA external type 2
E1 - OSPF external type 1, E2 - OSPF external type 2

```
C 10.10.9.0/24 [1] is directly connected, eth2, Area 0.0.0.0
C 10.10.10.0/24 [1] is directly connected, eth3, Area 0.0.0.0
O 10.10.11.0/24 [101] via 10.10.10.11, eth3, Area 0.0.0.0
C 10.10.12.0/24 [1] is directly connected, eth1, Area 0.0.0.0
O 10.10.13.0/24 [102] via 10.10.10.11, eth3, Area 0.0.0.0
O 10.10.14.0/24 [102] via 10.10.10.11, eth3, Area 0.0.0.0
```

R2#show route-map

route-map 1, permit, sequence 10

Match clauses:

Set clauses:

metric 100

metric-type type-2

route-map 2, permit, sequence 10

Match clauses:

Set clauses:

metric 200

metric-type type-1

R1#show ip ospf route

OSPF process 10:

Codes: C - connected, D - Discard, O - OSPF, IA - OSPF inter area
N1 - OSPF NSSA external type 1, N2 - OSPF NSSA external type 2
E1 - OSPF external type 1, E2 - OSPF external type 2

```
C 2.2.2.0/24 [1] is directly connected, eth1, Area 0.0.0.0
E1 4.4.4.0/24 [201] via 2.2.2.3, eth1
E2 6.6.6.6/32 [1/20] via 2.2.2.3, eth1
E2 8.8.8.8/32 [1/20] via 2.2.2.3, eth1
E2 192.168.20.0/24 [1/20] via 2.2.2.3, eth1
```

```
R2#show ip ospf route
```

```
OSPF process 10:
```

```
Codes: C - connected, D - Discard, O - OSPF, IA - OSPF inter area
       N1 - OSPF NSSA external type 1, N2 - OSPF NSSA external type 2
       E1 - OSPF external type 1, E2 - OSPF external type 2
```

```
C 2.2.2.0/24 [1] is directly connected, eth1, Area 0.0.0.0
```

```
OSPF process 15:
```

```
Codes: C - connected, D - Discard, O - OSPF, IA - OSPF inter area
       N1 - OSPF NSSA external type 1, N2 - OSPF NSSA external type 2
       E1 - OSPF external type 1, E2 - OSPF external type 2
```

```
C 4.4.4.0/24 [1] is directly connected, eth2, Area 0.0.0.0
```

```
R3#show ip ospf route
```

```
OSPF process 15:
```

```
Codes: C - connected, D - Discard, O - OSPF, IA - OSPF inter area
       N1 - OSPF NSSA external type 1, N2 - OSPF NSSA external type 2
       E1 - OSPF external type 1, E2 - OSPF external type 2
```

```
E2 2.2.2.0/24 [1/20] via 4.4.4.4, eth2
```

```
C 4.4.4.0/24 [1] is directly connected, eth2, Area 0.0.0.0
```

```
E2 6.6.6.6/32 [1/20] via 4.4.4.4, eth2
```

```
E2 8.8.8.8/32 [1/20] via 4.4.4.4, eth2
```

```
E2 192.168.20.0/24 [1/20] via 4.4.4.4, eth2
```

Multiple OSPF Instances on Same Subnet

Multiple OSPF instances can be configured on the same subnet. The OSPF instance ID supports separate OSPFv2 protocol instances. With this feature, an adjacency is formed only if the received packet's instance ID is the same as the instance ID configured for that interface.

Topology

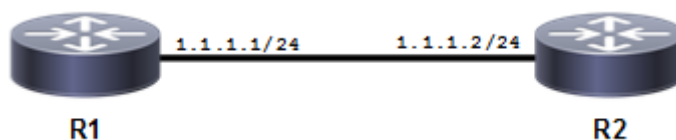

Figure 8-73: Multiple Instances on the Same Subnet

Configuration

R1

```
#configure terminal
```

```
Enter configure mode.
```

```
(config)#enable ext-ospf-multi-inst
```

```
Enable multiple-instance capability.
```

OSPFv2

(config)#router ospf 1	Configure an OSPF instance with an instance ID of 1.
(config-router)#network 1.1.1.0/24 area 0 instance-id 1	Advertise the network in Area 0 with an instance ID of 1.
(config-router)#exit	Exit Router mode, and return to Configure mode.
(config)#router ospf 2	Configure an OSPF instance with an instance ID of 2.
(config-router)#network 1.1.1.0/24 area 0 instance-id 2	Advertise the network in Area 0 with an instance ID of 2.
(config-router)#commit	Commit the candidate configuration to the running configuration.
(config-router)#exit	Exit Router mode, and return to Configure mode.

R2

#configure terminal	Enter configure mode.
(config)#enable ext-ospf-multi-inst	Enable multiple-instance capability.
(config)#router ospf 1	Configure an OSPF instance with an instance ID of 1.
(config-router)#network 1.1.1.0/24 area 0 instance-id 1	Advertise the network in Area 0 with an instance ID of 1.
(config-router)#exit	Exit Router mode, and return to Configure mode.
(config)#router ospf 2	Configure an OSPF instance with an instance ID of 2.
(config-router)#network 1.1.1.0/24 area 0 instance-id 2	Advertise the network in Area 0 with an instance ID of 2.
(config-router)#commit	Commit the candidate configuration to the running configuration.
(config-router)#exit	Exit Router mode, and return to Configure mode.

Validation

R1

```
R1#show ip ospf interface
eth1 is up, line protocol is up
  Internet Address 1.1.1.1/24, Area 0.0.0.0, MTU 1500
  Process ID 1, VRF (default), Router ID 10.12.26.88, Network Type BROADCAST,
Cost: 1
  Transmit Delay is 1 sec, State DR, Priority 1, TE Metric 1
  Designated Router (ID) 10.12.26.88, Interface Address 1.1.1.1
  Backup Designated Router (ID) 10.12.26.89, Interface Address 1.1.1.2
  Timer intervals configured, Hello 10, Dead 40, Wait 40, Retransmit 5
  Hello due in 00:00:10
  Neighbor Count is 1, Adjacent neighbor count is 1
  Suppress hello for 0 neighbor(s)
  Hello received 7 sent 16, DD received 3 sent 4
  LS-Req received 1 sent 1, LS-Upd received 3 sent 5
  LS-Ack received 3 sent 3, Discarded 0
  No authentication
  Internet Address 1.1.1.1/24, Area 0.0.0.0, MTU 1500
  Process ID 2, VRF (default), Router ID 10.12.26.88, Network Type BROADCAST,
Cost: 1
  Transmit Delay is 1 sec, State DR, Priority 1, TE Metric 1
```



```

Designated Router (ID) 10.12.26.88, Interface Address 1.1.1.1
Backup Designated Router (ID) 10.12.26.89, Interface Address 1.1.1.2
Timer intervals configured, Hello 10, Dead 40, Wait 40, Retransmit 5
  Hello due in 00:00:04
Neighbor Count is 1, Adjacent neighbor count is 1
Suppress hello for 0 neighbor(s)
Hello received 4 sent 12, DD received 3 sent 4
LS-Req received 1 sent 1, LS-Upd received 3 sent 5
LS-Ack received 3 sent 3, Discarded 0
No authentication

```

R1#show ip ospf neighbor

```

Total number of full neighbors: 1
OSPF process 1 VRF(default):
Neighbor ID      Pri   State                Dead Time   Address      Interface
Instance ID
10.12.26.89     1    Full/Backup          00:00:35   1.1.1.2     eth1
1

```

```

Total number of full neighbors: 1
OSPF process 2 VRF(default):
Neighbor ID      Pri   State                Dead Time   Address      Interface
Instance ID
10.12.26.89     1    Full/Backup          00:00:33   1.1.1.2     eth1
2

```

R2

```

R2#sh ip ospf interface
eth1 is up, line protocol is up
  Internet Address 1.1.1.2/24, Area 0.0.0.0, MTU 1500
  Process ID 1, VRF (default), Router ID 10.12.26.89, Network Type BROADCAST,
Cost: 1
  Transmit Delay is 1 sec, State Backup, Priority 1, TE Metric 1
  Designated Router (ID) 10.12.26.88, Interface Address 1.1.1.1
  Backup Designated Router (ID) 10.12.26.89, Interface Address 1.1.1.2
  Timer intervals configured, Hello 10, Dead 40, Wait 40, Retransmit 5
    Hello due in 00:00:08
  Neighbor Count is 1, Adjacent neighbor count is 1
  Suppress hello for 0 neighbor(s)
  Hello received 17 sent 17, DD received 4 sent 3
  LS-Req received 1 sent 1, LS-Upd received 5 sent 3
  LS-Ack received 2 sent 3, Discarded 0
  No authentication
  Internet Address 1.1.1.2/24, Area 0.0.0.0, MTU 1500
  Process ID 2, VRF (default), Router ID 10.12.26.89, Network Type BROADCAST,
Cost: 1
  Transmit Delay is 1 sec, State Backup, Priority 1, TE Metric 1
  Designated Router (ID) 10.12.26.88, Interface Address 1.1.1.1
  Backup Designated Router (ID) 10.12.26.89, Interface Address 1.1.1.2
  Timer intervals configured, Hello 10, Dead 40, Wait 40, Retransmit 5
    Hello due in 00:00:07
  Neighbor Count is 1, Adjacent neighbor count is 1
  Suppress hello for 0 neighbor(s)
  Hello received 13 sent 14, DD received 4 sent 3
  LS-Req received 1 sent 1, LS-Upd received 5 sent 3
  LS-Ack received 2 sent 3, Discarded 0
  No authentication

```

```
R2#sh ip ospf neighbor
```

```
Total number of full neighbors: 1
```

```
OSPF process 1 VRF(default):
```

Neighbor ID Instance ID	Pri	State	Dead Time	Address	Interface
10.12.26.88 1	1	Full/DR	00:00:32	1.1.1.1	eth1

```
Total number of full neighbors: 1
```

```
OSPF process 2 VRF(default):
```

Neighbor ID Instance ID	Pri	State	Dead Time	Address	Interface
10.12.26.88 2	1	Full/DR	00:00:37	1.1.1.1	eth1

Multi-Area Adjacency Configuration

Multiple OSPF areas for a same subnet can be configured between two routers. In the diagram below, OSPF is enabled between R2 and R3 under area 0 and area 1, though there is only one link available between these two routers. Multi-area adjacency allows establishing adjacency on multiple areas between the Area Border Routers (ABRs). The specified interface of the ABR is associated with multiple areas.

Each multi-area-adjacency internally implements point-to-point functionality, once the adjacency reaches the FULL state. This point-to-point link provides a topological path for that area. Like a virtual link, there is no restriction for multi-area adjacency that the packets always go through the backbone.

Topology

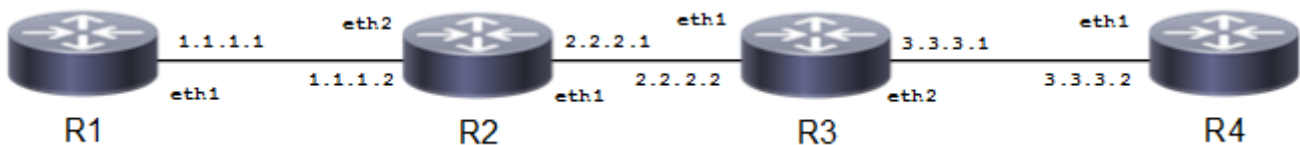

Figure 8-74: One Subnet with Multiple OSPF Areas

Configuration

R1

#configure terminal	Enter configure mode.
(config)#router ospf 1	Configure an OSPF instance with an instance ID of 1.
(config-router)#network 1.1.1.0/24 area 1	Configure OSPF between R1 and R2 under area 1.
(config-router)#commit	Commit the candidate configuration to the running configuration.
(config-router)#exit	Exit Router mode, and return to Configure mode.

R2

#configure terminal	Enter configure mode.
(config)#router ospf 1	Configure an OSPF instance with an instance ID of 1.
(config-router)#network 1.1.1.0/24 area 1	Configure OSPF between R1 and R2 under area 1.
(config-router)#network 2.2.2.0/24 area 0	Configure OSPF between R2 and R3 under area 0.
(config-router)#commit	Commit the candidate configuration to the running configuration.
(config-router)#exit	Exit Router mode, and return to Configure mode.
(config)#interface eth1	Enter interface mode.
(config-if)#ip address 2.2.2.1/24	Configure IP address on the interface.
(config-if)#ip ospf 1 multi-area 0.0.0.1 neighbor 2.2.2.2	Configure multi area adjacency.
(config-if)#commit	Commit the candidate configuration to the running configuration.
(config-if)#exit	Exit interface mode.

R3

#configure terminal	Enter configure mode.
(config)#router ospf 1	Configure an OSPF instance with an instance ID of 1.
(config-router)#network 2.2.2.0/24 area 0	Configure OSPF between R2 and R3 under area 0.
(config-router)#network 3.3.3.0/24 area 1	Configure OSPF between R3 and R4 under area 1.
(config-router)#commit	Commit the candidate configuration to the running configuration.
(config-router)#exit	Exit Router mode, and return to Configure mode.
(config)#interface eth1	Enter interface mode.
(config-if)#ip address 2.2.2.2/24	Configure IP address on the interface.
(config-if)#ip ospf 1 multi-area 0.0.0.1 neighbor 2.2.2.1	Configure multi area adjacency.
(config-if)#commit	Commit the candidate configuration to the running configuration.
(config-if)#exit	Exit interface mode.

R4

#configure terminal	Enter configure mode.
(config)#router ospf 1	Configure an OSPF instance with an instance ID of 1.
(config-router)#network 3.3.3.0/24 area 1	Configure OSPF between R3 and R4 under area 1.
(config-router)#commit	Commit the candidate configuration to the running configuration.
(config-router)#exit	Exit Router mode, and return to Configure mode.

Validation

R2

```
R2#show ip ospf multi-area-adjacencies
Multi-area-adjacency link on interface eth1 to neighbor 2.2.2.2
Internet Address 2.2.2.1/24, Area 0.0.0.1, MTU 1500
Process ID 1, Router ID 10.12.26.89, Network Type POINTTOPOINT, Cost: 1
Transmit Delay is 1 sec, State Point-To-Point, TE Metric 1
Timer intervals configured, Hello 10, Dead 40, Wait 40, Retransmit 5
  Hello due in 00:00:00
Neighbor Count is 1, Adjacent neighbor count is 1
Hello received 16 sent 53, DD received 3 sent 4
LS-Req received 1 sent 1, LS-Upd received 10 sent 5
LS-Ack received 3 sent 9, Discarded 0
```

```
R2#show ip ospf neighbor
```

```
Total number of full neighbors: 3
OSPF process 1 VRF(default):
```

Neighbor ID Instance ID	Pri	State	Dead Time	Address	Interface
10.12.26.88 0	1	Full/DR	00:00:35	1.1.1.1	eth2
10.12.26.90 0	1	Full/Backup	00:00:33	2.2.2.2	eth1
10.12.26.90	1	Full/ -	00:00:35	2.2.2.2	eth1

```
R2#show ip ospf route
```

```
OSPF process 1:
Codes: C - connected, D - Discard, O - OSPF, IA - OSPF inter area
       N1 - OSPF NSSA external type 1, N2 - OSPF NSSA external type 2
       E1 - OSPF external type 1, E2 - OSPF external type 2

C 1.1.1.0/24 [1] is directly connected, eth2, Area 0.0.0.1
C 2.2.2.0/24 [1] is directly connected, eth1, Area 0.0.0.0
O 3.3.3.0/24 [2] via 2.2.2.2, eth1, Area 0.0.0.1
```

```
R2#show ip route
```

```
Codes: K - kernel, C - connected, S - static, R - RIP, B - BGP
       O - OSPF, IA - OSPF inter area
       N1 - OSPF NSSA external type 1, N2 - OSPF NSSA external type 2
       E1 - OSPF external type 1, E2 - OSPF external type 2
       i - IS-IS, L1 - IS-IS level-1, L2 - IS-IS level-2, ia - IS-IS inter
area
       * - candidate default
```

```
IP Route Table for VRF "default"
```

```
C 1.1.1.0/24 is directly connected, eth2
C 2.2.2.0/24 is directly connected, eth1
O 3.3.3.0/24 [110/2] via 2.2.2.2, eth1, 00:05:44
C 10.12.26.0/24 is directly connected, eth0
C 127.0.0.0/8 is directly connected, lo
```

```
Gateway of last resort is not set
```

R3

```
R3#show ip ospf multi-area-adjacencies
Multi-area-adjacency link on interface eth1 to neighbor 2.2.2.1
Internet Address 2.2.2.2/24, Area 0.0.0.1, MTU 1500
Process ID 1, Router ID 10.12.26.90, Network Type POINTTOPOINT, Cost: 1
Transmit Delay is 1 sec, State Point-To-Point, TE Metric 1
Timer intervals configured, Hello 10, Dead 40, Wait 40, Retransmit 5
  Hello due in 00:00:05
Neighbor Count is 1, Adjacent neighbor count is 1
Hello received 41 sent 41, DD received 4 sent 3
LS-Req received 1 sent 1, LS-Upd received 5 sent 10
LS-Ack received 8 sent 3, Discarded 0
```

```
R3#sh ip ospf neighbor
```

```
Total number of full neighbors: 3
OSPF process 1 VRF(default):
Neighbor ID   Pri  State           Dead Time   Address      Interface
Instance ID
10.12.26.89   1    Full/DR         00:00:39   2.2.2.1     eth1
0
10.12.26.92   1    Full/Backup     00:00:36   3.3.3.2     eth2
0
10.12.26.89   1    Full/ -        00:00:30   2.2.2.1     eth1
R3#sh ip ospf route
```

```
OSPF process 1:
```

```
Codes: C - connected, D - Discard, O - OSPF, IA - OSPF inter area
       N1 - OSPF NSSA external type 1, N2 - OSPF NSSA external type 2
       E1 - OSPF external type 1, E2 - OSPF external type 2
```

```
O  1.1.1.0/24 [2] via 2.2.2.1, eth1, Area 0.0.0.1
C  2.2.2.0/24 [1] is directly connected, eth1, Area 0.0.0.0
C  3.3.3.0/24 [1] is directly connected, eth2, Area 0.0.0.1
```

```
R3#sh ip route
```

```
Codes: K - kernel, C - connected, S - static, R - RIP, B - BGP
       O - OSPF, IA - OSPF inter area
       N1 - OSPF NSSA external type 1, N2 - OSPF NSSA external type 2
       E1 - OSPF external type 1, E2 - OSPF external type 2
       i - IS-IS, L1 - IS-IS level-1, L2 - IS-IS level-2, ia - IS-IS inter
area
       * - candidate default
```

```
IP Route Table for VRF "default"
```

```
O    1.1.1.0/24 [110/2] via 2.2.2.1, eth1, 00:07:31
C    2.2.2.0/24 is directly connected, eth1
C    3.3.3.0/24 is directly connected, eth2
C    10.12.26.0/24 is directly connected, eth0
C    127.0.0.0/8 is directly connected, lo
```

```
Gateway of last resort is not set
```

LSA Throttling

This section contains basic OSPF LSA throttling configuration examples.

The OSPF Link-State Advertisement (LSA) throttling feature provides a mechanism to dynamically slow down link-state advertisement (LSA) updates in OSPF during times of network instability. It also allows faster OSPF convergence by providing LSA rate limiting in milliseconds, when the network is stable.

How OSPF LSA Throttling Works

The `timers throttle lsa all` command controls the generation (sending) of LSAs. The first LSA is always generated immediately upon an OSPF topology change, and the next LSA generated is controlled by the minimum start interval. The subsequent LSAs generated for the same LSA are rate-limited until the maximum interval is reached. The “same LSA” is defined as an LSA instance that contains the same LSA ID number, LSA type, and advertising router ID.

The `timers lsa arrival` command controls the minimum interval for accepting the same LSA. If an instance of the same LSA arrives sooner than the interval that is set, the LSA is dropped. It is recommended that the arrival interval be less than or equal to the hold-time interval of the `timers throttle lsa all` command.

Topology

The diagram shows the minimum configuration required to enable OSPF LSA Throttling Timers feature. R1 and R2 are two routers in Area 0 connecting to network 10.10.10.0/24.

Note: Configure one interface so that it belongs to only one area. It is possible, however, to configure different interfaces on a router to belong to different areas.

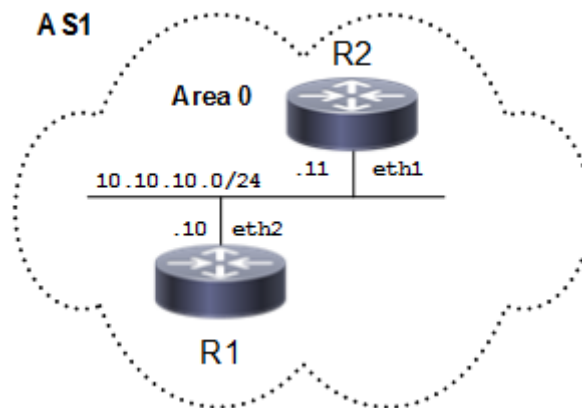

Figure 8-75: Basic OSPF Topology

R1

<code>#configure terminal</code>	Enter configure mode.
<code>(config)#interface lo</code>	Specify the interface loopback to configure.
<code>(config-if)#ip address 1.1.1.1/32 secondary</code>	Configure the ip address (1.1.1.1) of the interface loopback.
<code>(config-if)#exit</code>	Exit interface mode.

(config)#router ospf 1	Configure the routing process, and specify the Process ID (1). The Process ID should be a unique positive integer identifying the routing process.
(config-router)#network 10.10.10.0/24 area 0	Define the interface (10.10.10.0/24) on which OSPF runs, and associate the area ID (0) with the interface (area ID 0 specifies the backbone area).
(config-router)#network 1.1.1.1/32 area 0	Define the interface (1.1.1.1/32) on which OSPF runs, and associate the area ID (0) with the interface (area ID 0 specifies the backbone area).
(config-router)#timers throttle lsa all 10000 20000 45000	Configure LSA Throttling timers (Starting interval: <0-600000>, Min Hold Interval: <1-600000> and Max Wait Interval:< 1-600000>) in milliseconds. The Default value for corresponding timers are: Starting interval: 0, Min Hold Interval: 5 sec and Max Wait Interval: 5 sec.
(config-router)#logging monitor 7	Enable logging monitor globally.
(config)#logging level ospf 7	Enable logging level ospf globally.
(config)#commit	Commit the candidate configuration to the running configuration.
(config)#end	Exit router mode

R2

#configure terminal	Enter configure mode.
(config)#router ospf 1	Configure the routing process, and specify the Process ID (1). The Process ID should be a unique positive integer identifying the routing process.
(config-router)#network 10.10.10.0/24 area 0	Define the interface (10.10.10.0/24) on which OSPF runs, and associate the area ID (0) with the interface.
(config-router)#commit	Commit the candidate configuration to the running configuration.

Validation

R1

Check the output of `show ip ospf` and verify the initial throttle delay, minimum hold time for LSA throttle and maximum wait time for LSA throttle.

```
#show ip ospf 1
Routing Process "ospf 1" with ID 1.1.1.1
Process uptime is 11 minutes
Process bound to VRF default
Conforms to RFC2328, and RFC1583 Compatibility flag is disabled
Supports only single TOS(TOS0) routes
Supports opaque LSA
Supports Graceful Restart
```

```
SPF schedule delay initial 0 secs 500 msec
SPF schedule delay min 0 secs 500 msec
SPF schedule delay max 50 secs 0 msec
Refresh timer 10 secs
Number of incoming current DD exchange neighbors 0/64
Number of outgoing current DD exchange neighbors 0/64
Initial LSA throttle delay 10 secs 0 msec
Minimum hold time for LSA throttle 20 secs 0 msec
Maximum wait time for LSA throttle 45 secs 0 msec
Minimum LSA arrival 1 secs 0 msec
Number of external LSA 0. Checksum 0x000000
Number of opaque AS LSA 0. Checksum 0x000000
Number of non-default external LSA 0
External LSA database is unlimited.
Number of LSA originated 4
Number of LSA received 4
Number of areas attached to this router: 1
MemPool - struct ospf lsa          : (0-8) | Total (8/100000) blk_size:160
MemPool - struct rxmt             : | Total (0/0) blk_size:8
  Area 0.0.0.0 (BACKBONE)
    Number of interfaces in this area is 2(2)
    Number of fully adjacent neighbors in this area is 1
    Area has no authentication
    SPF algorithm last executed 00:10:12.807 ago
    SPF algorithm executed 5 times
    Number of LSA 7. Checksum 0x02c480
Dste Staus: Disabled
```

```
#show ip ospf neighbor
```

```
Total number of full neighbors: 1
OSPF process 1 VRF(default):
Neighbor ID Pri State Dead Time Address Interface Instance ID
3.1.1.1 1 Full/Backup 00:00:34 10.10.10.11 eth1 0
```

```
#debug ospf database-timer rate-limit
```

```
#show debugging ospf
OSPF debugging status:
OSPF rate limit timer events debugging is on
```

Here, we administratively shutdown and then bring up the loopback interface to generate Rate Limit Timer events for OSPF debugging to capture.

```
(config)#int lo
(config-if)#shutdown
2019 Mar 29 16:32:36.838 : OcnOS : OSPF : NOTIF : [OSPF_OPR_LINK_DOWN_4]:
Received Link down for interface: lo
2019 Mar 29 16:32:36.838 : OcnOS : OSPF : INFO : Starting Rate Limit Timer for
LSA[0.0.0.0:Type1:1.1.1.1:(self)]: with 10000 msec delay
2019 Mar 29 16:32:36.838 : OcnOS : OSPF : NOTIF : [OSPF_OPR_STATE_4]:
[lo:1.1.1.1]: Status change Loopback -> Down

(config-if)#no shutdown
2019 Mar 29 16:32:42.705 : OcnOS : OSPF : NOTIF : [OSPF_OPR_LINK_UP_4]:
Received Link up for interface: lo
```



```

2019 Mar 29 16:32:42.705 : OcnOS : OSPF : NOTIF : [OSPF_OPR_STATE_4]:
[lo:1.1.1.1]: Status change Down -> Loopback
2019 Mar 29 16:32:46.853 : OcnOS : OSPF : INFO : Rate Limit Timer for
LSA[0.0.0.0:Type1:1.1.1.1:(self)]: expired
2019 Mar 29 16:32:46.853 : OcnOS : OSPF : INFO : For Next Instance of
LSA[0.0.0.0:Type1:1.1.1.1:(self)]: generation wait 20000 msec

```

```
(config-if)#shutdown
```

```

2019 Mar 29 16:32:54.353 : OcnOS : OSPF : NOTIF : [OSPF_OPR_LINK_DOWN_4]:
Received Link down for interface: lo
2019 Mar 29 16:32:54.353 : OcnOS : OSPF : INFO : Starting Rate Limit Timer for
LSA[0.0.0.0:Type1:1.1.1.1:(self)]: with 12499 msec delay
2019 Mar 29 16:32:54.353 : OcnOS : OSPF : NOTIF : [OSPF_OPR_STATE_4]:
[lo:1.1.1.1]: Status change Loopback -> Down

```

```
(config-if)#no shutdown
```

```

2019 Mar 29 16:32:59.252 : OcnOS : OSPF : NOTIF : [OSPF_OPR_LINK_UP_4]:
Received Link up for interface: lo
2019 Mar 29 16:32:59.252 : OcnOS : OSPF : NOTIF : [OSPF_OPR_STATE_4]:
[lo:1.1.1.1]: Status change Down -> Loopback
2019 Mar 29 16:33:06.870 : OcnOS : OSPF : INFO : Rate Limit Timer for
LSA[0.0.0.0:Type1:1.1.1.1:(self)]: expired
2019 Mar 29 16:33:06.870 : OcnOS : OSPF : INFO : For Next Instance of
LSA[0.0.0.0:Type1:1.1.1.1:(self)]: generation wait 40000 msec

```

R2

Check the output of “show ip ospf neighbor” and verify that OSPF adjacency is up.

```
#show ip ospf neighbor
```

```

Total number of full neighbors: 1
OSPF process 1 VRF(default):
Neighbor ID Pri State Dead Time Address Interface Instance ID
1.1.1.1 1 Full/DR 00:00:33 10.10.10.10 eth1 0

```

Check the output of show ip ospf database and verify that LSA (router LSA in this example) is updated according to the configured LSA throttling timers configured on its neighbor.

```
#show ip ospf database
```

```
OSPF Router with ID (3.1.1.1) (Process ID 1 VRF default)
```

```
Router Link States (Area 0.0.0.0)
```

Link ID	ADV Router	Age	Seq#	CkSum	Link count
3.1.1.1	3.1.1.1	373	0x80000004	0xc60c	1
1.1.1.1	1.1.1.1	71	0x80000008	0xb9f2	2

```
Net Link States (Area 0.0.0.0)
```

Link ID	ADV Router	Age	Seq#	CkSum
10.10.10.10	1.1.1.1	375	0x80000001	0x18e5

```
Area-Local Opaque-LSA (Area 0.0.0.0)
```

Link ID	ADV Router	Age	Seq#	CkSum	Opaque ID
1.0.0.1	3.1.1.1	372	0x80000001	0x2cf6	1

1.0.0.1	1.1.1.1	373	0x80000001	0x2af6	1
1.0.0.8	3.1.1.1	372	0x80000001	0x7d45	8
1.0.0.8	1.1.1.1	373	0x80000001	0x566c	8

```
#show ip ospf database
```

```
OSPF Router with ID (3.1.1.1) (Process ID 1 VRF default)
```

```
Router Link States (Area 0.0.0.0)
```

Link ID	ADV Router	Age	Seq#	CkSum	Link count
3.1.1.1	3.1.1.1	378	0x80000004	0xc60c	1
1.1.1.1	1.1.1.1	76	0x80000008	0xb9f2	2

```
Net Link States (Area 0.0.0.0)
```

Link ID	ADV Router	Age	Seq#	CkSum
10.10.10.10	1.1.1.1	380	0x80000001	0x18e5

```
Area-Local Opaque-LSA (Area 0.0.0.0)
```

Link ID	ADV Router	Age	Seq#	CkSum	Opaque ID
1.0.0.1	3.1.1.1	377	0x80000001	0x2cf6	1
1.0.0.1	1.1.1.1	378	0x80000001	0x2af6	1
1.0.0.8	3.1.1.1	377	0x80000001	0x7d45	8
1.0.0.8	1.1.1.1	378	0x80000001	0x566c	8

```
#show ip ospf database
```

```
OSPF Router with ID (3.1.1.1) (Process ID 1 VRF default)
```

```
Router Link States (Area 0.0.0.0)
```

Link ID	ADV Router	Age	Seq#	CkSum	Link count
3.1.1.1	3.1.1.1	380	0x80000004	0xc60c	1
1.1.1.1	1.1.1.1	78	0x80000008	0xb9f2	2

```
Net Link States (Area 0.0.0.0)
```

Link ID	ADV Router	Age	Seq#	CkSum
10.10.10.10	1.1.1.1	382	0x80000001	0x18e5

```
Area-Local Opaque-LSA (Area 0.0.0.0)
```

Link ID	ADV Router	Age	Seq#	CkSum	Opaque ID
1.0.0.1	3.1.1.1	379	0x80000001	0x2cf6	1
1.0.0.1	1.1.1.1	380	0x80000001	0x2af6	1
1.0.0.8	3.1.1.1	379	0x80000001	0x7d45	8
1.0.0.8	1.1.1.1	380	0x80000001	0x566c	8

```
#show ip ospf database
```

```
OSPF Router with ID (3.1.1.1) (Process ID 1 VRF default)
```

Router Link States (Area 0.0.0.0)

Link ID	ADV Router	Age	Seq#	CkSum	Link count
3.1.1.1	3.1.1.1	381	0x80000004	0xc60c	1
1.1.1.1	1.1.1.1	79	0x80000008	0xb9f2	2

Net Link States (Area 0.0.0.0)

Link ID	ADV Router	Age	Seq#	CkSum
10.10.10.10	1.1.1.1	383	0x80000001	0x18e5

Area-Local Opaque-LSA (Area 0.0.0.0)

Link ID	ADV Router	Age	Seq#	CkSum	Opaque ID
1.0.0.1	3.1.1.1	380	0x80000001	0x2cf6	1
1.0.0.1	1.1.1.1	381	0x80000001	0x2af6	1
1.0.0.8	3.1.1.1	380	0x80000001	0x7d45	8
1.0.0.8	1.1.1.1	381	0x80000001	0x566c	8

#show ip ospf database

OSPF Router with ID (3.1.1.1) (Process ID 1 VRF default)

Router Link States (Area 0.0.0.0)

Link ID	ADV Router	Age	Seq#	CkSum	Link count
3.1.1.1	3.1.1.1	382	0x80000004	0xc60c	1
1.1.1.1	1.1.1.1	80	0x80000008	0xb9f2	2

Net Link States (Area 0.0.0.0)

Link ID	ADV Router	Age	Seq#	CkSum
10.10.10.10	1.1.1.1	384	0x80000001	0x18e5

Area-Local Opaque-LSA (Area 0.0.0.0)

Link ID	ADV Router	Age	Seq#	CkSum	Opaque ID
1.0.0.1	3.1.1.1	381	0x80000001	0x2cf6	1
1.0.0.1	1.1.1.1	382	0x80000001	0x2af6	1
1.0.0.8	3.1.1.1	381	0x80000001	0x7d45	8
1.0.0.8	1.1.1.1	382	0x80000001	0x566c	8

#show ip ospf database

OSPF Router with ID (3.1.1.1) (Process ID 1 VRF default)

Router Link States (Area 0.0.0.0)

Link ID	ADV Router	Age	Seq#	CkSum	Link count
3.1.1.1	3.1.1.1	383	0x80000004	0xc60c	1
1.1.1.1	1.1.1.1	81	0x80000008	0xb9f2	2

Net Link States (Area 0.0.0.0)

Link ID	ADV Router	Age	Seq#	CkSum
---------	------------	-----	------	-------

```
10.10.10.10      1.1.1.1          385      0x80000001 0x18e5
```

```
Area-Local Opaque-LSA (Area 0.0.0.0)
```

Link ID	ADV Router	Age	Seq#	CkSum	Opaque ID
1.0.0.1	3.1.1.1	382	0x80000001	0x2cf6	1
1.0.0.1	1.1.1.1	383	0x80000001	0x2af6	1
1.0.0.8	3.1.1.1	382	0x80000001	0x7d45	8
1.0.0.8	1.1.1.1	383	0x80000001	0x566c	8

Configure OSPF LSA Arrival Timers

The diagram shows the minimum configuration required to enable OSPF Minimum LSA Arrival Timers feature. R1 and R2 are two routers in Area 0 connecting to network 10.10.10.0/24.

Note: Configure one interface so that it belongs to only one area. It is possible, however, to configure different interfaces on a router to belong to different areas.

Topology

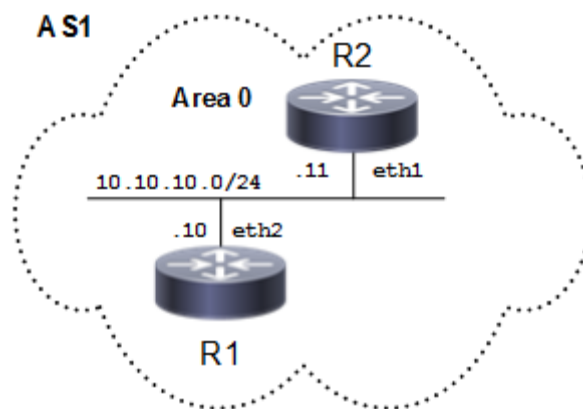

Figure 8-76: Basic OSPF Topology

Configuration

R1

#configure terminal	Enter configure mode.
(config)#interface lo	Specify the interface loopback to configure.
(config-if)#ip address 1.1.1.1/32 secondary	Configure the ip address (1.1.1.1) of the interface loopback.
(config-if)#exit	Exit interface mode.
(config)#router ospf 1	Configure the routing process, and specify the Process ID (1). The Process ID should be a unique positive integer identifying the routing process.
(config-router)#network 10.10.10.0/24 area 0	Define the interface (10.10.10.0/24) on which OSPF runs, and associate the area ID (0) with the interface (area ID 0 specifies the backbone area).

(config-router)#network 1.1.1.1/32 area 0	Define the interface (1.1.1.1/32) on which OSPF runs, and associate the area ID (0) with the interface (area ID 0 specifies the backbone area).
(config-router)#commit	Commit the candidate configuration to the running configuration.
(config-router)#end	Exit router mode

R2

#configure terminal	Enter configure mode.
(config)#router ospf 1	Configure the routing process, and specify the Process ID (1). The Process ID should be a unique positive integer identifying the routing process.
(config-router)#network 10.10.10.0/24 area 0	Define the interface (10.10.10.0/24) on which OSPF runs, and associate the area ID (0) with the interface.
(config-router)#timers lsa arrival 100000	Configure Minimum LSA Arrival timers (Minimum LSA arrival Interval:< 0-600000>) in milliseconds. The Default value for Minimum LSA Arrival timer is: 1 sec.
(config-router)#commit	Commit the candidate configuration to the running configuration.

Validation

R1

Check the output of `show ip ospf` and verify that the minimum LSA arrival timer by default is set to 1 sec.

```
#show ip ospf
Routing Process "ospf 1" with ID 1.1.1.1
Process uptime is 11 minutes
Process bound to VRF default
Conforms to RFC2328, and RFC1583 Compatibility flag is disabled
Supports only single TOS(TOS0) routes
Supports opaque LSA
Supports Graceful Restart
SPF schedule delay initial 0 secs 500 msec
SPF schedule delay min 0 secs 500 msec
SPF schedule delay max 50 secs 0 msec
Refresh timer 10 secs
Number of incoming current DD exchange neighbors 0/64
Number of outgoing current DD exchange neighbors 0/64
Initial LSA throttle delay 10 secs 0 msec
Minimum hold time for LSA throttle 20 secs 0 msec
Maximum wait time for LSA throttle 45 secs 0 msec
Minimum LSA arrival 1 secs 0 msec
Number of external LSA 0. Checksum 0x000000
Number of opaque AS LSA 0. Checksum 0x000000
Number of non-default external LSA 0
External LSA database is unlimited.
```

```
Number of LSA originated 4
Number of LSA received 4
Number of areas attached to this router: 1
MemPool - struct ospf lsa      : (0-8) | Total (8/100000) blk_size:160
MemPool - struct rxmt         : | Total (0/0) blk_size:8
  Area 0.0.0.0 (BACKBONE)
    Number of interfaces in this area is 2(2)
    Number of fully adjacent neighbors in this area is 1
    Area has no authentication
    SPF algorithm last executed 00:10:12.807 ago
    SPF algorithm executed 5 times
    Number of LSA 7. Checksum 0x02c480
  Dste Staus: Disabled

#show ip ospf neighbor
```

```
Total number of full neighbors: 1
OSPF process 1 VRF(default):
Neighbor ID    Pri  State                Dead Time   Address      Interface
Instance ID
3.1.1.1        1   Full/Backup          00:00:34   10.10.10.11 eth1
```

R2

Check the output of `show ip ospf` and verify that the minimum LSA arrival timer is set to 100 sec.

```
#show ip ospf
Routing Process "ospf 1" with ID 3.1.1.1
Process uptime is 23 minutes
Process bound to VRF default
Conforms to RFC2328, and RFC1583 Compatibility flag is disabled
Supports only single TOS(TOS0) routes
Supports opaque LSA
Supports Graceful Restart
SPF schedule delay initial 0 secs 500 msecs
SPF schedule delay min 0 secs 500 msecs
SPF schedule delay max 50 secs 0 msecs
Refresh timer 10 secs
Number of incoming current DD exchange neighbors 0/64
Number of outgoing current DD exchange neighbors 0/64
Initial LSA throttle delay 0 secs 0 msecs
Minimum hold time for LSA throttle 5 secs 0 msecs
Maximum wait time for LSA throttle 5 secs 0 msecs
Minimum LSA arrival 100 secs 0 msecs
Number of external LSA 0. Checksum 0x000000
Number of opaque AS LSA 0. Checksum 0x000000
Number of non-default external LSA 0
External LSA database is unlimited.
Number of LSA originated 3
Number of LSA received 10
Number of areas attached to this router: 1
MemPool - struct ospf lsa      : (0-9) | Total (9/100000) blk_size:160
MemPool - struct rxmt         : | Total (0/0) blk_size:8
  Area 0.0.0.0 (BACKBONE)
    Number of interfaces in this area is 1(1)
    Number of fully adjacent neighbors in this area is 1
    Area has no authentication
    SPF algorithm last executed 00:22:12.911 ago
```

```

SPF algorithm executed 4 times
Number of LSA 7. Checksum 0x02c281
Dste Staus: Disabled

```

Check the output of show ip ospf neighbor and verify that OSPF adjacency is up.

```
#show ip ospf neighbor
```

```

Total number of full neighbors: 1
OSPF process 1 VRF(default):
Neighbor ID      Pri   State           Dead Time   Address      Interface
Instance ID
1.1.1.1          1    Full/DR         00:00:35   10.10.10.10 eth1
0

```

Check the output of "show ip ospf database" and verify that LSA is accepted only after a time difference of 100 sec between two consecutive LSAs.

```
#show ip ospf database
```

```

OSPF Router with ID (3.1.1.1) (Process ID 1 VRF default)

Router Link States (Area 0.0.0.0)

Link ID          ADV Router      Age      Seq#           CkSum  Link count
3.1.1.1          3.1.1.1        1131    0x80000004    0xc60c  1
1.1.1.1          1.1.1.1        829     0x80000008    0xb9f2  2

Net Link States (Area 0.0.0.0)

Link ID          ADV Router      Age      Seq#           CkSum
10.10.10.10     1.1.1.1        1133    0x80000001    0x18e5

Area-Local Opaque-LSA (Area 0.0.0.0)

Link ID          ADV Router      Age      Seq#           CkSum  Opaque ID
1.0.0.1          3.1.1.1        1130    0x80000001    0x2cf6  1
1.0.0.1          1.1.1.1        1131    0x80000001    0x2af6  1
1.0.0.8          3.1.1.1        1130    0x80000001    0x7d45  8
1.0.0.8          1.1.1.1        1131    0x80000001    0x566c  8

```

```
#show ip ospf database
```

```

OSPF Router with ID (3.1.1.1) (Process ID 1 VRF default)

Router Link States (Area 0.0.0.0)

Link ID          ADV Router      Age      Seq#           CkSum  Link count
3.1.1.1          3.1.1.1        1132    0x80000004    0xc60c  1
1.1.1.1          1.1.1.1        831     0x80000008    0xb9f2  2

Net Link States (Area 0.0.0.0)

Link ID          ADV Router      Age      Seq#           CkSum
10.10.10.10     1.1.1.1        1134    0x80000001    0x18e5

Area-Local Opaque-LSA (Area 0.0.0.0)

```

Link ID	ADV Router	Age	Seq#	CkSum	Opaque ID
1.0.0.1	3.1.1.1	1131	0x80000001	0x2cf6	1
1.0.0.1	1.1.1.1	1132	0x80000001	0x2af6	1
1.0.0.8	3.1.1.1	1131	0x80000001	0x7d45	8
1.0.0.8	1.1.1.1	1132	0x80000001	0x566c	8

#show ip ospf database

OSPF Router with ID (3.1.1.1) (Process ID 1 VRF default)

Router Link States (Area 0.0.0.0)

Link ID	ADV Router	Age	Seq#	CkSum	Link count
3.1.1.1	3.1.1.1	1133	0x80000004	0xc60c	1
1.1.1.1	1.1.1.1	831	0x80000008	0xb9f2	2

Net Link States (Area 0.0.0.0)

Link ID	ADV Router	Age	Seq#	CkSum
10.10.10.10	1.1.1.1	1135	0x80000001	0x18e5

Area-Local Opaque-LSA (Area 0.0.0.0)

Link ID	ADV Router	Age	Seq#	CkSum	Opaque ID
1.0.0.1	3.1.1.1	1132	0x80000001	0x2cf6	1
1.0.0.1	1.1.1.1	1133	0x80000001	0x2af6	1
1.0.0.8	3.1.1.1	1132	0x80000001	0x7d45	8
1.0.0.8	1.1.1.1	1133	0x80000001	0x566c	8

#show ip ospf database

OSPF Router with ID (3.1.1.1) (Process ID 1 VRF default)

Router Link States (Area 0.0.0.0)

Link ID	ADV Router	Age	Seq#	CkSum	Link count
3.1.1.1	3.1.1.1	1134	0x80000004	0xc60c	1
1.1.1.1	1.1.1.1	832	0x80000008	0xb9f2	2

Net Link States (Area 0.0.0.0)

Link ID	ADV Router	Age	Seq#	CkSum
10.10.10.10	1.1.1.1	1136	0x80000001	0x18e5

Area-Local Opaque-LSA (Area 0.0.0.0)

Link ID	ADV Router	Age	Seq#	CkSum	Opaque ID
1.0.0.1	3.1.1.1	1133	0x80000001	0x2cf6	1
1.0.0.1	1.1.1.1	1134	0x80000001	0x2af6	1
1.0.0.8	3.1.1.1	1133	0x80000001	0x7d45	8
1.0.0.8	1.1.1.1	1134	0x80000001	0x566c	8

#

#show ip ospf database

OSPF Router with ID (3.1.1.1) (Process ID 1 VRF default)

Router Link States (Area 0.0.0.0)

Link ID	ADV Router	Age	Seq#	CkSum	Link count
3.1.1.1	3.1.1.1	1135	0x80000004	0xc60c	1
1.1.1.1	1.1.1.1	834	0x80000008	0xb9f2	2

Net Link States (Area 0.0.0.0)

Link ID	ADV Router	Age	Seq#	CkSum
10.10.10.10	1.1.1.1	1137	0x80000001	0x18e5

Area-Local Opaque-LSA (Area 0.0.0.0)

Link ID	ADV Router	Age	Seq#	CkSum	Opaque ID
1.0.0.1	3.1.1.1	1134	0x80000001	0x2cf6	1
1.0.0.1	1.1.1.1	1135	0x80000001	0x2af6	1
1.0.0.8	3.1.1.1	1134	0x80000001	0x7d45	8
1.0.0.8	1.1.1.1	1135	0x80000001	0x566c	8

```
#show ip ospf database
```

```
OSPF Router with ID (3.1.1.1) (Process ID 1 VRF default)
```

Router Link States (Area 0.0.0.0)

Link ID	ADV Router	Age	Seq#	CkSum	Link count
3.1.1.1	3.1.1.1	1136	0x80000004	0xc60c	1
1.1.1.1	1.1.1.1	834	0x80000008	0xb9f2	2

Net Link States (Area 0.0.0.0)

Link ID	ADV Router	Age	Seq#	CkSum
10.10.10.10	1.1.1.1	1138	0x80000001	0x18e5

Area-Local Opaque-LSA (Area 0.0.0.0)

Link ID	ADV Router	Age	Seq#	CkSum	Opaque ID
1.0.0.1	3.1.1.1	1135	0x80000001	0x2cf6	1
1.0.0.1	1.1.1.1	1136	0x80000001	0x2af6	1
1.0.0.8	3.1.1.1	1135	0x80000001	0x7d45	8
1.0.0.8	1.1.1.1	1136	0x80000001	0x566c	8

Loop-Free Alternate Fast Reroute

This section contains basic OSPF Loop-Free Alternate Fast Reroute (LFA-FRR) configuration examples.

Overview

The goal of (LFA-FRR) is to reduce failure reaction time to 10s of milliseconds by using a pre-computed alternate next-hop in the event that the currently selected primary next-hop fails, so that the alternate can be rapidly used when the failure is detected. A network with this feature experiences less traffic loss and less micro-looping of packets than a network without LFA-FRR.

After enabling LFA-FRR on routers, routers calculate a backup path for each primary path to reach the destination. The backup path is calculated based on the attributes such as node protecting, link protecting, broadcast-link protecting and secondary path.

Topology

The diagram shows the configuration required to enable the OSPF LFA feature.

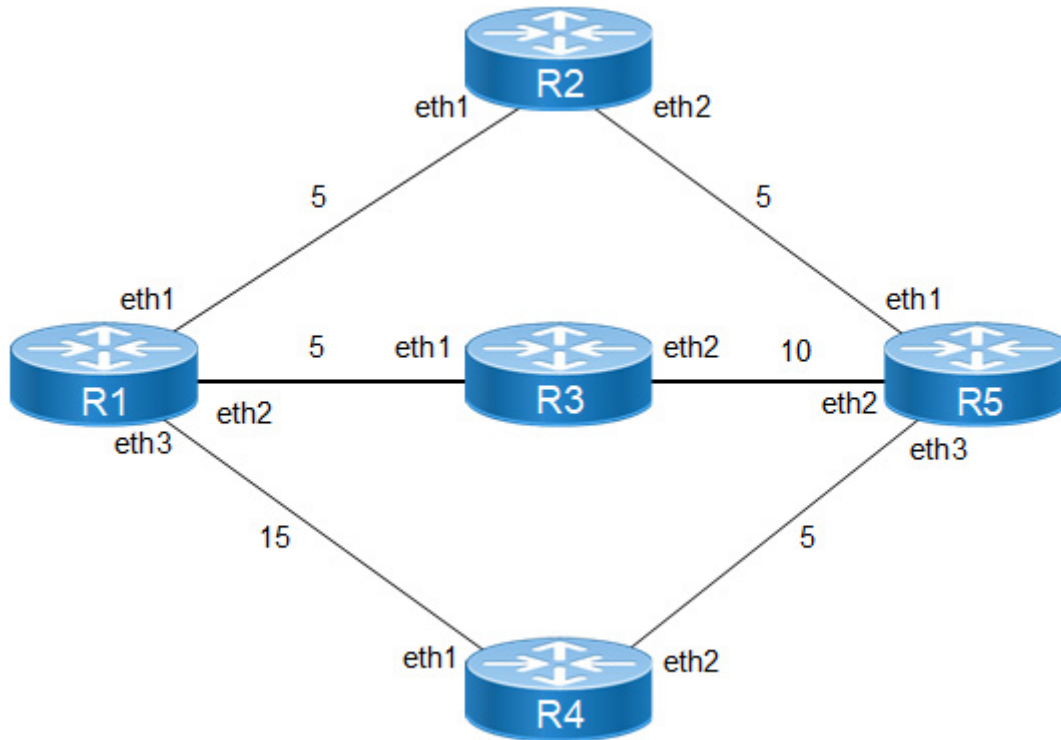

Figure 8-77: Basic OSPF-LFA Topology

R1

#configure terminal	Enter configure mode.
(config)#int eth1	Enter interface mode.
(config-if)#ip address 10.1.1.1/24	Configure the IP address of the interface
(config-if)#exit	Exit interface mode.
(config)#int eth2	Enter interface mode.
(config-if)#ip address 20.1.1.1/24	Configure the IP address of the interface.
(config-if)#exit	Exit interface mode.
(config)#int eth3	Enter interface mode.
(config-if)#ip address 30.1.1.1/24	Configure the IP address of the interface.
(config-if)#exit	Exit interface mode.
(config)#router ospf 1	Configure the routing process and specify the Process ID (1).

(config-router)#network 10.1.1.0/24 area 0	Define the interface (10.1.1.0/24) on which OSPF runs, and associate the area ID (0) with the interface (area ID 0 specifies the backbone area).
(config-router)#network 20.1.1.0/24 area 0	Define the interface (20.1.1.0/24) on which OSPF runs, and associate the area ID (0) with the interface (area ID 0 specifies the backbone area).
(config-router)#network 30.1.1.0/24 area 0	Define the interface (30.1.1.0/24) on which OSPF runs, and associate the area ID (0) with the interface (area ID 0 specifies the backbone area).
(config-router)#fast-reroute keep-all-paths	Configure LFA-FRR to calculate the available backup path.
(config-router)#commit	Commit the candidate configuration to the running configuration.
(config-router)#end	Exit router mode.

R2

#configure terminal	Enter configure mode.
(config)#int eth1	Enter interface mode.
(config-if)#ip address 10.1.1.2/24	Configure the IP address of the interface
(config-if)#exit	Exit interface mode.
(config)#int eth2	Enter interface mode.
(config-if)#ip address 40.1.1.1/24	Configure the IP address of the interface.
(config-if)#exit	Exit interface mode.
(config)#router ospf 1	Configure the routing process, and specify the Process ID (1). The Process ID should be a unique positive integer identifying the routing process.
(config-router)#network 10.1.1.0/24 area 0	Define the interface (20.1.1.0/24) on which OSPF runs, and associate the area ID (0) with the interface (area ID 0 specifies the backbone area).
(config-router)#network 40.1.1.0/24 area 0	Define the interface (40.1.1.0/24) on which OSPF runs, and associate the area ID (0) with the interface (area ID 0 specifies the backbone area).
(config-router)#commit	Commit the candidate configuration to the running configuration.
(config-router)#end	Exit router mode.

R3

#configure terminal	Enter configure mode.
(config)#int eth1	Enter interface mode.
(config-if)#ip address 20.1.1.2/24	Configure the IP address of the interface
(config-if)#exit	Exit interface mode.
(config)#int eth2	Enter interface mode.
(config-if)#ip address 50.1.1.1/24	Configure the IP address of the interface.
(config-if)#exit	Exit interface mode.

OSPFv2

(config)#router ospf 1	Configure the routing process, and specify the Process ID (1). The Process ID should be a unique positive integer identifying the routing process.
(config-router)#network 20.1.1.0/24 area 0	Define the interface (20.1.1.0/24) on which OSPF runs, and associate the area ID (0) with the interface (area ID 0 specifies the backbone area).
(config-router)#network 50.1.1.0/24 area 0	Define the interface (50.1.1.0/24) on which OSPF runs, and associate the area ID (0) with the interface (area ID 0 specifies the backbone area).
(config-router)#commit	Commit the candidate configuration to the running configuration.
(config-router)#end	Exit router mode.

R4

#configure terminal	Enter configure mode.
(config)#int eth1	Enter interface mode.
(config-if)#ip address 30.1.1.2/24	Configure the IP address of the interface
(config-if)#exit	Exit interface mode.
(config)#int eth2	Enter interface mode.
(config-if)#ip address 60.1.1.1/24	Configure the IP address of the interface.
(config-if)#exit	Exit interface mode.
(config)#router ospf 1	Configure the routing process, and specify the Process ID (1). The Process ID should be a unique positive integer identifying the routing process.
(config-router)#network 30.1.1.0/24 area 0	Define the interface (30.1.1.0/24) on which OSPF runs, and associate the area ID (0) with the interface (area ID 0 specifies the backbone area).
(config-router)#network 60.1.1.0/24 area 0	Define the interface (60.1.1.0/24) on which OSPF runs, and associate the area ID (0) with the interface (area ID 0 specifies the backbone area).
(config-router)#commit	Commit the candidate configuration to the running configuration.
(config-router)#end	Exit router mode.

R5

#configure terminal	Enter configure mode.
(config)#int eth1	Enter interface mode.
(config-if)#ip address 40.1.1.2/24	Configure the IP address of the interface
(config-if)#exit	Exit interface mode.
(config)#int eth2	Enter interface mode.
(config-if)#ip address 50.1.1.1/24	Configure the IP address of the interface.
(config-if)#exit	Exit interface mode.
(config)#int eth3	Enter interface mode.
(config-if)#ip address 60.1.1.1/24	Configure the IP address of the interface.

(config-if)#exit	Exit interface mode.
(config)#router ospf 1	Configure the routing process, and specify the Process ID (1). The Process ID should be a unique positive integer identifying the routing process.
(config-router)#network 40.1.1.0/24 area 0	Define the interface (30.1.1.0/24) on which OSPF runs, and associate the area ID (0) with the interface (area ID 0 specifies the backbone area).
(config-router)#network 50.1.1.0/24 area 0	Define the interface (30.1.1.0/24) on which OSPF runs, and associate the area ID (0) with the interface (area ID 0 specifies the backbone area).
(config-router)#network 60.1.1.0/24 area 0	Define the interface (30.1.1.0/24) on which OSPF runs, and associate the area ID (0) with the interface (area ID 0 specifies the backbone area).
(config-router)#commit	Commit the candidate configuration to the running configuration.
(config-router)#end	Exit router mode.

Validation

R1

Check OSPF neighborship.

```
#show ip ospf neighbor
OSPF Process 100 VRF (default)
Neighbor ID      Pri   State           Dead Time   Address    Interface Intance
ID
2.2.2.2          1     Full/DR         00:00:33   10.1.1.2   eth1      0
3.3.3.3          1     Full/DR         00:00:33   20.1.1.2   eth2      0
4.4.4.4          1     Full/DR         00:00:39   30.1.1.2   eth2      0
#
```

Check the OSPF route installation and LFA-FRR backup path for the primary path.

```
#show ip route
Codes: K - kernel, C - connected, S - static, R - RIP, B - BGP O - OSPF, IA -
OSPF inter area
N1 - OSPF NSSA external type 1, N2 - OSPF NSSA external type 2 E1 - OSPF
external type 1, E2 - OSPF external type 2
i - IS-IS, L1 - IS-IS level-1, L2 - IS-IS level-2, ia - IS-IS inter
area
* - candidate default
```

```
IP Route Table for VRF "default"
C    10.1.1.0/24 is directly connected, eth1
C    20.1.1.0/24 is directly connected, eth2
C 30.1.1.0/24 is directly connected, eth3
O    40.1.1.0/24 [110/10] via 10.1.1.2, eth1, 00:16:43
O    50.1.1.0/24 [110/15] via 20.1.1.2, eth2, 00:16:43
O IA  60.1.1.0/24 [110/15] via 10.1.1.2, eth1, 00:16:43
O E2  70.1.1.0/24 [110/20] via 30.1.1.2, eth3, 00:16:43
O E2  80.1.1.0/24 [110/20] via 10.1.1.2, eth1, 00:16:43
C 127.0.0.0/8 is directly connected, lo
C 192.168.100.0/24 is directly connected, eth0
Gateway of last resort is not set
```

Not mandatory that for all primary path, there exists an LFA backup path only if inequality equation satisfies according to attributes configured on routers, backup path will be calculated.

```
#show ip route fast-reroute
```

```
Codes: K - kernel, C - connected, S - static, R - RIP, B - BGP
```

```
O - OSPF, IA - OSPF inter area
```

```
N1 - OSPF NSSA external type 1, N2 - OSPF NSSA external type 2
```

```
E1 - OSPF external type 1, E2 - OSPF external type 2
```

```
i - IS-IS, L1 - IS-IS level-1, L2 - IS-IS level-2, ia - IS-IS inter area ,p - stale info
```

```
* - candidate default
```

```
IP Route Table for VRF "default"
```

```
O      50.1.1.0/24 [110/15] via 20.1.1.2, eth2, 00:00:34
          [FRR-NH] via 10.1.1.2, eth1
```

```
O      60.1.1.0/24 [110/15] via 10.1.1.2, eth1, 00:00:34
          [FRR-NH] via 20.1.1.2, eth2
```

```
O      70.1.1.0/24 [110/20] via 30.1.1.2, eth3, 00:02:27
          [FRR-NH] via 10.1.1.2, eth1
```

```
O      80.1.1.0/24 [110/20] via 10.1.1.2, eth1, 00:02:27
          [FRR-NH] via 20.1.1.2, eth2
```

Not mandatory that for all primary path, there exists an LFA backup path only if inequality equation satisfies according to attributes configured on routers, backup path will be calculated.

To prohibit an interface from being used as a repair path, disable fast reroute calculation on the interface.

```
(config)#int eth3
```

```
(config-if)#ip ospf fast-reroute per-prefix candidate disable
```

```
(config-if)#end
```

Verify that the eth3 interface is not used for backup path calculation.

```
#show ip route
```

```
Codes: K - kernel, C - connected, S - static, R - RIP, B - BGP
```

```
O - OSPF, IA - OSPF inter area
```

```
N1 - OSPF NSSA external type 1, N2 - OSPF NSSA external type 2
```

```
E1 - OSPF external type 1, E2 - OSPF external type 2
```

```
i - IS-IS, L1 - IS-IS level-1, L2 - IS-IS level-2, ia - IS-IS inter area
```

```
* - candidate default
```

```
IP Route Table for VRF "default"
```

```
O      10.1.1.0/24 [110/10] via 20.1.1.1, eth1, 00:34:04
```

```
C      20.1.1.0/24 is directly connected, eth1
```

```
O      30.1.1.0/24 [110/20] via 20.1.1.1, eth1, 00:34:04
```

```
O      40.1.1.0/24 [110/15] via 20.1.1.1, eth1, 00:34:04
          [110/15] via 50.1.1.2, eth2, 00:34:04
```

```
C      50.1.1.0/24 is directly connected, eth2
```

```
O IA   60.1.1.0/24 [110/15] via 50.1.1.2, eth2, 01:08:29
```

```
O E2   70.1.1.0/24 [110/20] via 20.1.1.1, eth1, 00:34:03
```

```
O E2   80.1.1.0/24 [110/20] via 50.1.1.2, eth2, 01:11:17
```

```
C      127.0.0.0/8 is directly connected, lo
```

```
C      192.168.100.0/24 is directly connected, eth0
```

```
#show ip route fast-reroute
```

Codes: K - kernel, C - connected, S - static, R - RIP, B - BGP
 O - OSPF, IA - OSPF inter area
 N1 - OSPF NSSA external type 1, N2 - OSPF NSSA external type 2
 E1 - OSPF external type 1, E2 - OSPF external type 2
 i - IS-IS, L1 - IS-IS level-1, L2 - IS-IS level-2, ia - IS-IS inter
 area ,p - stale info
 * - candidate default

IP Route Table for VRF "default"

```
O      10.1.1.0/24 [110/10] via 20.1.1.1, eth1, 00:00:34
          [FRR-NH] via 50.1.1.2, eth2

O      30.1.1.0/24 [110/20] via 20.1.1.1, eth1, 00:00:34
          [FRR-NH] via 50.1.1.2, eth2

O      60.1.1.0/24 [110/15] via 50.1.1.2, eth2, 00:02:27
          [FRR-NH] via 20.1.1.1, eth1

O      70.1.1.0/24 [110/20] via 20.1.1.1, eth1, 00:02:27
          [FRR-NH] via 50.1.1.2, eth2

O      80.1.1.0/24 [110/20] via 50.1.1.2, eth2, 00:02:27
```

Note: Now the LFA backup paths have been changed, eth3 is not used.

LFA Tie-Breaker

Based on the index values configured, if inequalities are satisfied, protections will be provided:

- Lower the index will have the highest priority, the path which provides protection with highest priority will be selected. If there are multiple paths providing the highest priority protection, then we will check which path provides the protection which has 2nd highest priority and so on.
- If all the paths provide same priority, then the LFA route is chosen on the basis of path cost.
- If none of the paths provides the protection with highest priority, then we will see which path provides the 2nd highest priority and so on.

```
config)#router ospf 100
(config-router)#fast-reroute tie-break ?
broadcast-interface-disjoint  Prefer broadcast link protecting backup path
                                *Default value is 70

downstream-path                Prefer backup path from downstream
                                *Default value is 90

interface-disjoint             Prefer link protecting backup path
                                *Default value is 60

node-protecting                Prefer node protecting backup path
                                *Default value is 30
```

```
primary-path                Prefer backup path from ECMP set
```

```
*Default value is 20
```

```
secondary-path             Prefer non-ECMP backup path
```

```
*Default value is 255
```

```
(config-router)#fast-reroute tie-break broadcast-interface-disjoint index 1
```

```
(config-router)#fast-reroute tie-break node-protecting index 2
```

```
(config-router)#commit
```

Verify show ip route and show ip route fast-reroute for backup path calculated according to attributes configured above.

```
#show ip route
```

```
Codes: K - kernel, C - connected, S - static, R - RIP, B - BGP O - OSPF, IA - OSPF inter area
```

```
N1 - OSPF NSSA external type 1, N2 - OSPF NSSA external type 2 E1 - OSPF external type 1, E2 - OSPF external type 2
```

```
i - IS-IS, L1 - IS-IS level-1, L2 - IS-IS level-2, ia - IS-IS inter area
```

```
* - candidate default
```

```
IP Route Table for VRF "default"
```

```
C 10.1.1.0/24 is directly connected, eth1
```

```
C 20.1.1.0/24 is directly connected, eth2
```

```
C 30.1.1.0/24 is directly connected, eth3
```

```
O 40.1.1.0/24 [110/10] via 10.1.1.2, eth1, 01:07:26
```

```
O 50.1.1.0/24 [110/15] via 20.1.1.2, eth2, 01:07:26
```

```
O IA 60.1.1.0/24 [110/15] via 10.1.1.2, eth1, 01:07:26
```

```
O E2 70.1.1.0/24 [110/20] via 30.1.1.2, eth3, 01:07:26
```

```
O E2 80.1.1.0/24 [110/20] via 10.1.1.2, eth1, 01:07:26
```

```
C 127.0.0.0/8 is directly connected, lo
```

```
C 192.168.100.0/24 is directly connected, eth0
```

```
Gateway of last resort is not set
```

```
#show ip route fast-reroute
```

```
Codes: K - kernel, C - connected, S - static, R - RIP, B - BGP
```

```
O - OSPF, IA - OSPF inter area
```

```
N1 - OSPF NSSA external type 1, N2 - OSPF NSSA external type 2
```

```
E1 - OSPF external type 1, E2 - OSPF external type 2
```

```
i - IS-IS, L1 - IS-IS level-1, L2 - IS-IS level-2, ia - IS-IS inter area ,p - stale info
```

```
* - candidate default
```

```
IP Route Table for VRF "default"
```

```
O 50.1.1.0/24 [110/15] via 20.1.1.2, eth2, 00:00:34  
[FRR-NH] via 10.1.1.2, eth1
```

```
O 60.1.1.0/24 [110/15] via 10.1.1.2, eth1, 00:02:27  
[FRR-NH] via 20.1.1.2, eth2
```

```
O 70.1.1.0/24 [110/20] via 30.1.1.2, eth3, 00:02:27  
[FRR-NH] via 10.1.1.2, eth1
```

```
O 80.1.1.0/24 [110/20] via 10.1.1.2, eth1, 00:02:27
```



```
[FRR-NH] via 20.1.1.2, eth2
```

```
#show ip ospf route fast-reroute
```

```
OSPF process 0:
```

```
Codes: C - connected, D - Discard, O - OSPF, IA - OSPF inter area
       N1 - OSPF NSSA external type 1, N2 - OSPF NSSA external type 2
       E1 - OSPF external type 1, E2 - OSPF external type 2
OSPF LFA attributes:
       P - Primary, SP - Secondary-Path, ID - Interface Disjoint,
       NP - Node Protecting, BID - Broadcast Interface Disjoint
```

```
O 50.1.1.0/24 [15] via 20.1.1.1, eth2, Area 0.0.0.0
    Backup path:
      via 10.1.1.2, eth1, Area 0.0.0.0
    Attributes: Metric: [20] ,LP ,NP, BP
O 60.1.1.0/24 [15] via 10.1.1.2, eth1, Area 0.0.0.0
    Backup path:
      via 20.1.1.2, eth2, Area 0.0.0.0
    Attributes: Metric: [15] ,LP ,NP,BP
O 70.1.1.0/24 [20] via 30.1.1.2, eth3, Area 0.0.0.0
    Backup path:
      via 10.1.1.2, eth1, Area 0.0.0.0
    Attributes: Metric: [20] ,LP ,NP,BP
O 80.1.1.0/24 [20] via 10.1.1.2, eth1, Area 0.0.0.0
    Backup path:
      via 20.1.1.2, eth2, Area 0.0.0.0
    Attributes: Metric: [20] ,LP,NP,BP
```

LFA Termination

A router MUST limit the amount of time an alternate next-hop is used after the primary next-hop has become unavailable. This ensures that the router will start using the new primary next-hops.

LFA termination avoids a micro looping in topology, when particular network goes down, LFA backup path will be installed and if termination interval is configured, LFA backup will be still used till the interval and it is used in order to verify new primary path is loop free.

R1

Configure termination interval on R1 in router mode:

(config)#router ospf 1	Configure the routing process, and specify the Process ID (1). The Process ID should be a unique positive integer identifying the routing process.
(config-router)#fast-reroute terminate-hold-on interval 100000	Configure LFA termination interval
(config-router)#commit	Commit the candidate configuration to the running configuration.
(config-router)#exit	Exit router mode.
(config)#exit	Exit config mode.

If you check “show ip ospf” you can see the configured termination-hold on interval value along with ospf output:

```
#show ip ospf
```

```

IPFRR per-prefix tiebreakers:
  Name                               Index
  Primary path                       20
  Node Protecting                    30
  Interface disjoint                 60
  Broadcast interface disjoint       70
  Secondary path                     255
LFA termination hold-on timer : 100 secs 0 msec

```

```

#show ip route fast-reroute
Codes: K - kernel, C - connected, S - static, R - RIP, B - BGP
       O - OSPF, IA - OSPF inter area
       N1 - OSPF NSSA external type 1, N2 - OSPF NSSA external type 2
       E1 - OSPF external type 1, E2 - OSPF external type 2
       i - IS-IS, L1 - IS-IS level-1, L2 - IS-IS level-2, ia - IS-IS inter
area ,p - stale info
       * - candidate default

```

```

IP Route Table for VRF "default"
O      50.1.1.0/24 [110/15] via 20.1.1.2, eth2, 00:00:34
      [FRR-NH] via 10.1.1.2, eth1

O      60.1.1.0/24 [110/15] via 10.1.1.2, eth1, 00:00:34
      [FRR-NH] via 20.1.1.2, eth2

O      70.1.1.0/24 [110/20] via 30.1.1.2, eth3, 00:02:27
      [FRR-NH] via 10.1.1.2, eth1

O      80.1.1.0/24 [110/20] via 10.1.1.2, eth1, 00:02:27
      [FRR-NH] via 20.1.1.2, eth2

```

Shut down one of the primary nexthops, here eth2 of rtr1:

(config)#interface eth2	Enter interface mode.
(config-if)#shutdown	Shutdown the interface
(config-if)#commit	Commit the candidate configuration to the running configuration.
(config-if)#exit	Exit interface mode
(config-if)#exit	Exit interface mode.

```

#show ip route fast-reroute
Codes: K - kernel, C - connected, S - static, R - RIP, B - BGP
       O - OSPF, IA - OSPF inter area
       N1 - OSPF NSSA external type 1, N2 - OSPF NSSA external type 2
       E1 - OSPF external type 1, E2 - OSPF external type 2
       i - IS-IS, L1 - IS-IS level-1, L2 - IS-IS level-2, ia - IS-IS inter
area ,p - stale info
       * - candidate default

IP Route Table for VRF "default"
O      50.1.1.0/24 [110/15] via 20.1.1.2, eth1, 00:00:34 <<<eth1 which was
back-up path before got installed as new primary path
      [FRR-NH] via 30.1.1.2, eth3

```

- 60.1.1.0/24 [110/15] via 10.1.1.2, eth1, 00:00:34
[FRR-NH] via 30.1.1.2, eth3
- 70.1.1.0/24 [110/20] via 30.1.1.2, eth3, 00:02:27
[FRR-NH] via 10.1.1.2, eth1
- 80.1.1.0/24 [110/20] via 10.1.1.2, eth1, 00:02:27
[FRR-NH] via 30.1.1.2, eth3

Loop-Free Alternate (LFA) ECMP PATH

This section contains configurations for OSPF LFA ECMP which provides LFA/alternate path from primary ECMP path set or non-primary/non-ECMP path set which improve convergence after a primary path failure occur in network.

Overview

With ECMP, a prefix has multiple primary paths to forward traffic. When a particular primary path fails, the other primary paths are not guaranteed to provide protection against the failure scenario. As part of LFA ECMP, alternate paths are determined for each primary path separately. The selected alternate path can be either one of the primary path from the set of ECMP or a loop-free non-ECMP if available.

In OSPF, by default the LFA algorithm tries to find loop free node protecting alternate from the set of existing primary next-hops. If no loop free node-protecting alternate is available, the LFA algorithm tries to find link-protecting alternate from the set of existing primary next-hops. If no loop-free node-protecting and link-protecting alternate is available, then the LFA algorithm should select a loop-free link-protecting from the non-ECMP next-hops.

Topology

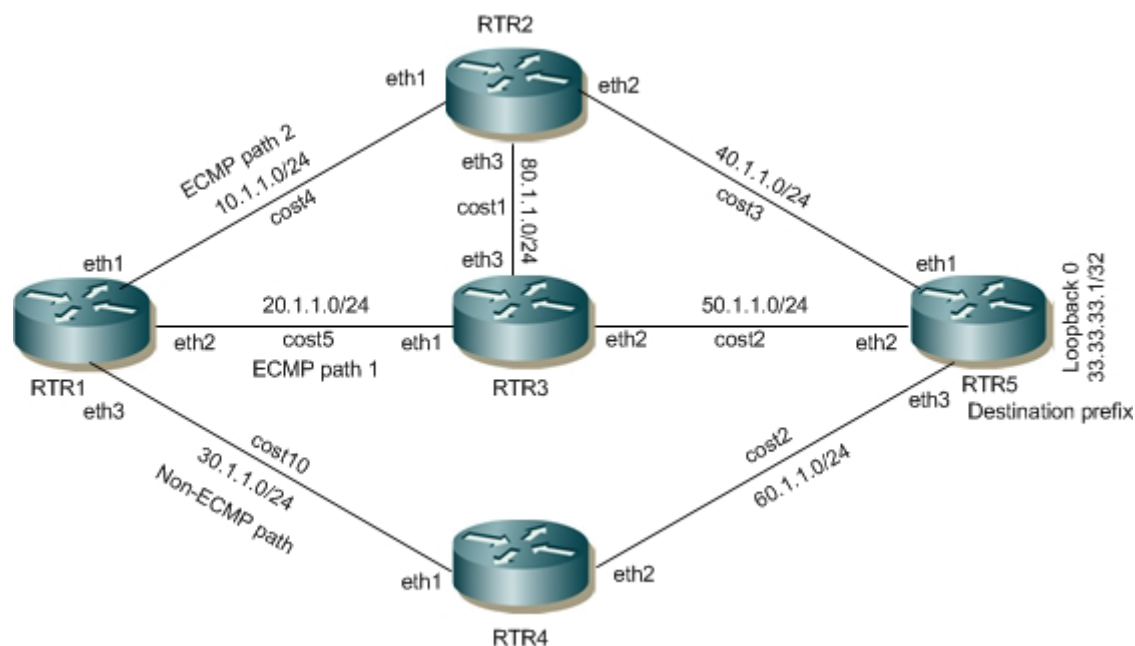

Figure 8-78: OSPF-LFA_ECMP

Configuring OSPF LFA ECMP

Configuration Part 1: with default LFA configuration where primary path priority higher than Secondary-path (non-ECMP) and LFA selection happen within primary ECMP path

RTR1

#configure terminal	Enter configure mode.
(config)#interface eth1	Enter interface mode.
(config-if)#ip address 10.1.1.1/24	Configure the IP address of the interface.
(config-if)#ip ospf cost 4	Assign cost to interface
(config-if)#exit	Exit interface mode.
(config)#interface eth2	Enter interface mode.
(config-if)#ip address 20.1.1.1/24	Assign IP address.
(config-if)#ip ospf cost 5	Assign cost to interface
(config-if)#exit	Exit interface mode.
(config)#interface eth3	Enter interface mode.
(config-if)#ip address 30.1.1.1/24	Assign IP address.
(config-if)#ip ospf cost 10	Assign cost to interface
(config-if)#exit	Exit interface mode.
(config)#router ospf 1	Configure the routing process and specify the Process ID (1).
(config-router)#ospf router-id 1.1.1.1	Configure router-id as 1.1.1.1
(config-router)#bfd all-interfaces	Enable BFD over ospf for all ospf enabled interfaces
(config-router)#network 10.1.1.0/24 area 0	Configure OSPF network for area 0.
(config-router)#network 20.1.1.0/24 area 0	Configure OSPF network for area 0.
(config-router)#network 30.1.1.0/24 area 0	Configure OSPF network for area 0.
(config-router)#fast-reroute keep-all-paths	Configure LFA-FRR to calculate the available backup path.
(config-router)#commit	Commit the candidate configuration to the running configuration.
(config-router)#end	Exit router mode.

RTR2

#configure terminal	Enter configure mode.
(config)#interface eth1	Enter interface mode.
(config-if)#ip address 10.1.1.2/24	Configure the IP address of the interface.
(config-if)#ip ospf cost 4	Assign cost to interface
(config-if)#exit	Exit interface mode.
(config)#interface eth2	Enter interface mode.

(config-if)#ip address 40.1.1.1/24	Assign IP address.
(config-if)#ip ospf cost 3	Assign cost to interface
(config-if)#exit	Exit interface mode.
(config)#interface eth3	Enter interface mode.
(config-if)#ip address 80.1.1.1/24	Assign IP address.
(config-if)#ip ospf cost 1	Assign cost to interface
(config-if)#exit	Exit interface mode.
(config)#router ospf 1	Configure the routing process and specify the Process ID (1).
(config-router)#ospf router-id 2.2.2.2	Configure router-id.
(config-router)#bfd all-interfaces	Enable BFD over ospf for all ospf enabled interfaces
(config-router)#network 10.1.1.0/24 area 0	Configure OSPF network for area 0.
(config-router)#network 40.1.1.0/24 area 0	Configure OSPF network for area 0.
(config-router)#network 80.1.1.0/24 area 0	Configure OSPF network for area 0.
(config-router)#commit	Commit the candidate configuration to the running configuration.
(config-router)#end	Exit router mode.

RTR3

#configure terminal	Enter configure mode.
(config)#interface eth1	Enter interface mode.
(config-if)#ip address 20.1.1.2/24	Configure the IP address of the interface.
(config-if)#ip ospf cost 5	Assign cost to interface
(config-if)#exit	Exit interface mode.
(config)#interface eth2	Enter interface mode.
(config-if)#ip address 50.1.1.1/24	Assign IP address.
(config-if)#ip ospf cost 2	Assign cost to interface
(config-if)#exit	Exit interface mode.
(config)#interface eth3	Enter interface mode.
(config-if)#ip address 80.1.1.2/24	Assign IP address.
(config-if)#ip ospf cost 1	Assign cost to interface
(config-if)#exit	Exit interface mode.
(config)#router ospf 1	Configure the routing process and specify the Process ID (1).
(config-router)#ospf router-id 3.3.3.3	Configure router-id.
(config-router)#bfd all-interfaces	Enable BFD over ospf for all ospf enabled interfaces
(config-router)#network 20.1.1.0/24 area 0	Configure OSPF network for area 0.
(config-router)#network 50.1.1.0/24 area 0	Configure OSPF network for area 0.

OSPFv2

(config-router)#network 80.1.1.0/24 area 0	Configure OSPF network for area 0.
(config-router)#commit	Commit the candidate configuration to the running configuration.
(config-router)#end	Exit router mode.

RTR4

#configure terminal	Enter configure mode.
(config)#interface eth1	Enter interface mode.
(config-if)#ip address 30.1.1.2/24	Configure the IP address of the interface.
(config-if)#ip ospf cost 10	Assign cost to interface
(config-if)#exit	Exit interface mode.
(config)#interface eth2	Enter interface mode.
(config-if)#ip address 60.1.1.1/24	Assign IP address.
(config-if)#ip ospf cost 2	Assign cost to interface
(config-if)#exit	Exit interface mode.
(config)#router ospf 1	Configure the routing process and specify the Process ID (1).
(config-router)#ospf router-id 4.4.4.4	Configure router-id.
(config-router)#bfd all-interfaces	Enable BFD over ospf for all ospf enabled interfaces
(config-router)#network 30.1.1.0/24 area 0	Configure OSPF network for area 0.
(config-router)#network 60.1.1.0/24 area 0	Configure OSPF network for area 0.
(config-router)#commit	Commit the candidate configuration to the running configuration.
(config-router)#end	Exit router mode.

RTR5

#configure terminal	Enter configure mode.
(config)#interface lo	Enter interface mode.
(config-if)#ip address 33.33.33.1/32 secondary	Configure the IP address of the interface loopback.
(config-if)#exit	Exit interface mode.
(config)#interface eth1	Enter interface mode.
(config-if)#ip address 40.1.1.2/24	Configure the IP address of the interface.
(config-if)#ip ospf cost 3	Assign cost to interface
(config-if)#exit	Exit interface mode.
(config)#interface eth2	Enter interface mode.
(config-if)#ip address 50.1.1.2/24	Assign IP address.
(config-if)#ip ospf cost 2	Assign cost to interface

(config-if)#exit	Exit interface mode.
(config)#interface eth3	Enter interface mode.
(config-if)#ip address 60.1.1.2/24	Assign IP address.
(config-if)#ip ospf cost 2	Assign cost to interface
(config-if)#exit	Exit interface mode.
(config)#router ospf 1	Configure the routing process and specify the Process ID (1).
(config-router)#ospf router-id 5.5.5.5	Configure router-id.
(config-router)#bfd all-interfaces	Enable BFD over ospf for all ospf enabled interfaces
(config-router)#network 40.1.1.0/24 area 0	Configure OSPF network for area 0.
(config-router)#network 50.1.1.0/24 area 0	Configure OSPF network for area 0.
(config-router)#network 60.1.1.0/24 area 0	Configure OSPF network for area 0.
(config-router)#network 33.33.33.1/32 area 0	Configure OSPF network for area 0.
(config-router)#commit	Commit the candidate configuration to the running configuration.
(config-router)#end	Exit router mode.

Validation

Validation Part 1: LFA selected from primary ECMP path set

RTR1

```
#show ip ospf route fast-reroute
```

```
OSPF process 1:
```

```
Codes: C - connected, D - Discard, O - OSPF, IA - OSPF inter area
N1 - OSPF NSSA external type 1, N2 - OSPF NSSA external type 2
E1 - OSPF external type 1, E2 - OSPF external type 2
OSPF LFA attributes:
P - Primary, SP - Secondary-Path, ID - Interface Disjoint,
NP - Node Protecting, BID - Broadcast Interface Disjoint
```

```
O 33.33.33.1/32 [17] via 10.1.1.2, eth1, Area 0.0.0.0
    Backup path:
        via 20.1.1.2, eth2, Area 0.0.0.0
        Attributes: Metric: [17] ,P ,NP
    via 20.1.1.2, eth2, Area 0.0.0.0
    Backup path:
        via 10.1.1.2, eth1, Area 0.0.0.0
        Attributes: Metric: [17] ,P ,ID
O 40.1.1.0/24 [7] via 10.1.1.2, eth1, Area 0.0.0.0
    Backup path:
        via 30.1.1.2, eth3, Area 0.0.0.0
        Attributes: Metric: [15] ,SP ,NP
O 50.1.1.0/24 [7] via 20.1.1.2, eth2, Area 0.0.0.0
    Backup path:
```

```
        via 10.1.1.2, eth1, Area 0.0.0.0
        Attributes: Metric: [7] ,P ,ID
    via 10.1.1.2, eth1, Area 0.0.0.0
        Backup path:
        via 20.1.1.2, eth2, Area 0.0.0.0
        Attributes: Metric: [7] ,P ,NP
O 60.1.1.0/24 [9] via 10.1.1.2, eth1, Area 0.0.0.0
        Backup path:
        via 20.1.1.2, eth2, Area 0.0.0.0
        Attributes: Metric: [9] ,P ,NP
    via 20.1.1.2, eth2, Area 0.0.0.0
        Backup path:
        via 10.1.1.2, eth1, Area 0.0.0.0
        Attributes: Metric: [9] ,P ,ID
O 80.1.1.0/24 [5] via 10.1.1.2, eth1, Area 0.0.0.0
        Backup path:
        via 20.1.1.2, eth2, Area 0.0.0.0
        Attributes: Metric: [6] ,SP ,NP
```

```
#show ip route fast-reroute
```

```
Codes: K - kernel, C - connected, S - static, R - RIP, B - BGP
```

```
O - OSPF, IA - OSPF inter area
```

```
N1 - OSPF NSSA external type 1, N2 - OSPF NSSA external type 2
```

```
E1 - OSPF external type 1, E2 - OSPF external type 2
```

```
i - IS-IS, L1 - IS-IS level-1, L2 - IS-IS level-2,
```

```
ia - IS-IS inter area, T - FRR nhp,p - stale info
```

```
* - candidate default
```

```
IP Route Table for VRF "default"
```

```
O      33.33.33.1/32 [110/17] via 20.1.1.2, eth2, 00:00:44
        [FRR-NH] via 10.1.1.2, eth1

        [110/17] via 10.1.1.2, eth1
        [FRR-NH] via 20.1.1.2, eth2

O      40.1.1.0/24 [110/7] via 10.1.1.2, eth1, 00:01:46
        [FRR-NH] via 30.1.1.2, eth3

O      50.1.1.0/24 [110/7] via 10.1.1.2, eth1, 00:01:34
        [FRR-NH] via 20.1.1.2, eth2

        [110/7] via 20.1.1.2, eth2
        [FRR-NH] via 10.1.1.2, eth1

O      60.1.1.0/24 [110/9] via 20.1.1.2, eth2, 00:01:34
        [FRR-NH] via 10.1.1.2, eth1

        [110/9] via 10.1.1.2, eth1
        [FRR-NH] via 20.1.1.2, eth2

O      80.1.1.0/24 [110/5] via 10.1.1.2, eth1, 00:01:46
        [FRR-NH] via 20.1.1.2, eth2
```

```
#show ip ospf route 33.33.33.1
```

```
OSPF process 1:
```

Codes: C - connected, D - Discard, O - OSPF, IA - OSPF inter area
 N1 - OSPF NSSA external type 1, N2 - OSPF NSSA external type 2
 E1 - OSPF external type 1, E2 - OSPF external type 2
 OSPF LFA attributes:
 P - Primary, SP - Secondary-Path, ID - Interface Disjoint,
 NP - Node Protecting, BID - Broadcast Interface Disjoint

```
O 33.33.33.1/32 [17] via 10.1.1.2, eth1, Area 0.0.0.0
   via 20.1.1.2, eth2, Area 0.0.0.0
```

```
#show ip route 33.33.33.1
Routing entry for 33.33.33.1/32
  Known via "ospf", distance 110, metric 17, External Route Tag: 0, best
  Last update 00:00:40 ago
  * 20.1.1.2, via eth2
  * 10.1.1.2, via eth1
```

Configuration Part 2: with non-ECMP tiebreaker configured where secondary-path priority higher than primary (ECMP) path

Configure below configuration with config's shown in Part1:

RTR1

#configure terminal	Enter configure mode.
(config)#router ospf 1	Enter Router OSPF mode.
(config-router)#fast-reroute tie-break secondary-path index 5	Configure LFA tiebreaker for LFA to be calculate from non-ecmp path set if available (this is user defined to decide the priority to select between ecmp/non-ecmp set)
(config-router)#commit	Commit the candidate configuration to the running configuration.
(config-router)#exit	Exit Router OSPF mode and return to Configure mode.

Validation Part 2: LFA selected from non-ecmp path for each primary ecmp path

RTR1

```
#show ip ospf route fast-reroute

OSPF process 1:
Codes: C - connected, D - Discard, O - OSPF, IA - OSPF inter area
       N1 - OSPF NSSA external type 1, N2 - OSPF NSSA external type 2
       E1 - OSPF external type 1, E2 - OSPF external type 2
OSPF LFA attributes:
       P - Primary, SP - Secondary-Path, ID - Interface Disjoint,
       NP - Node Protecting, BID - Broadcast Interface Disjoint

O 33.33.33.1/32 [17] via 10.1.1.2, eth1, Area 0.0.0.0
   Backup path:
     via 30.1.1.2, eth3, Area 0.0.0.0
     Attributes: Metric: [22] ,SP ,NP
   via 20.1.1.2, eth2, Area 0.0.0.0
   Backup path:
```

```

        via 30.1.1.2, eth3, Area 0.0.0.0
        Attributes: Metric: [22] ,SP ,NP
O 40.1.1.0/24 [7] via 10.1.1.2, eth1, Area 0.0.0.0
    Backup path:
        via 30.1.1.2, eth3, Area 0.0.0.0
        Attributes: Metric: [15] ,SP ,NP
O 50.1.1.0/24 [7] via 20.1.1.2, eth2, Area 0.0.0.0
    Backup path:
        via 30.1.1.2, eth3, Area 0.0.0.0
        Attributes: Metric: [14] ,SP ,NP
    via 10.1.1.2, eth1, Area 0.0.0.0
    Backup path:
        via 30.1.1.2, eth3, Area 0.0.0.0
        Attributes: Metric: [14] ,SP ,NP
O 60.1.1.0/24 [9] via 10.1.1.2, eth1, Area 0.0.0.0
    Backup path:
        via 30.1.1.2, eth3, Area 0.0.0.0
        Attributes: Metric: [12] ,SP ,NP
    via 20.1.1.2, eth2, Area 0.0.0.0
    Backup path:
        via 30.1.1.2, eth3, Area 0.0.0.0
        Attributes: Metric: [12] ,SP ,NP
O 80.1.1.0/24 [5] via 10.1.1.2, eth1, Area 0.0.0.0
    Backup path:
        via 20.1.1.2, eth2, Area 0.0.0.0
        Attributes: Metric: [6] ,SP ,NP
```

```
#show ip route fast-reroute
```

```
Codes: K - kernel, C - connected, S - static, R - RIP, B - BGP
O - OSPF, IA - OSPF inter area
N1 - OSPF NSSA external type 1, N2 - OSPF NSSA external type 2
E1 - OSPF external type 1, E2 - OSPF external type 2
i - IS-IS, L1 - IS-IS level-1, L2 - IS-IS level-2,
ia - IS-IS inter area , T - FRR nhp,p - stale info
* - candidate default
```

```
IP Route Table for VRF "default"
```

```
O      33.33.33.1/32 [110/17] via 20.1.1.2, eth2, 00:00:36
        [FRR-NH] via 30.1.1.2, eth3

        [110/17] via 10.1.1.2, eth1
        [FRR-NH] via 30.1.1.2, eth3

O      40.1.1.0/24 [110/7] via 10.1.1.2, eth1, 00:01:38
        [FRR-NH] via 30.1.1.2, eth3

O      50.1.1.0/24 [110/7] via 10.1.1.2, eth1, 00:01:26
        [FRR-NH] via 30.1.1.2, eth3

        [110/7] via 20.1.1.2, eth2
        [FRR-NH] via 30.1.1.2, eth3

O      60.1.1.0/24 [110/9] via 20.1.1.2, eth2, 00:01:26
        [FRR-NH] via 30.1.1.2, eth3

        [110/9] via 10.1.1.2, eth1
        [FRR-NH] via 30.1.1.2, eth3
```

- 80.1.1.0/24 [110/5] via 10.1.1.2, eth1, 00:01:38
[FRR-NH] via 20.1.1.2, eth2

SNMP Support for Multiple Instance of OSPF Configuration

Overview

SNMP operation by default are tied to a specific OID which is unique. However protocol like OSPF can have multiple instances, and have different values of same parameters for different OSPF instances. To be able to support SNMP for each of these instances, it is needed that each instance of the protocol has its own instance of the MIBs. It is aimed to achieve that with mapping each instance to a context. Each context will point to a different copy of the same OID for the protocol.

Topology

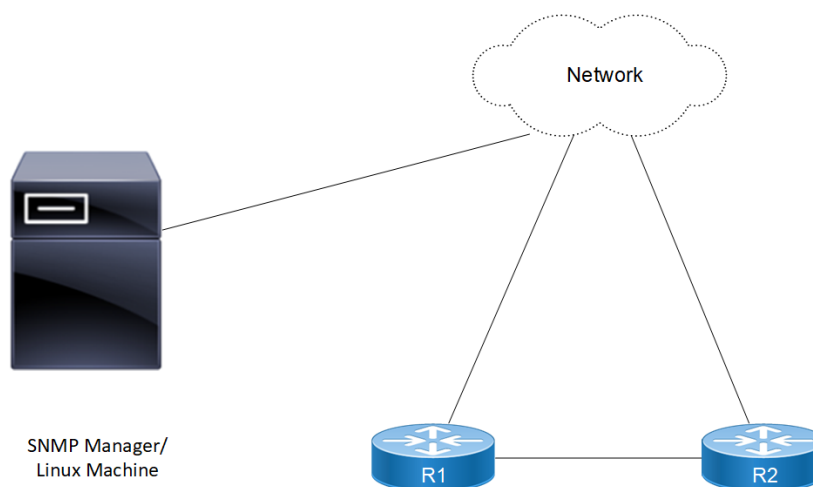

Figure 8-79: SNMP OSPF instance

Enable SNMP and create SNMP Context & Group for OSPF Instances on a Router with SNMPv2

In this example, routers R1 & R2 are in Area 0, and all run OSPF. SNMPv2 user is created and Mapping of user with group and context for SNMPwalk /SNMP get operation on context.

R1

#configure terminal	Enter configure mode.
(config)#snmp-server enable snmp vrf management	Use this command to start the SNMP agent.
(config)#commit	Commit the candidate configuration to the running configuration
(config)#exit	Exit configure mode.
#configure terminal	Enter configure mode.

OSPFv2

(config)#snmp-server context context1 vrf management	Creates SNMP Context with Context name.
(config)#snmp-server group group1 version 2c context context1 vrf management	Creates SNMP group with Group name and for specific context in SNMP v2 version.
(config)#snmp-server user user1 group1 vrf management	Creates SNMP User in SNMPv2 and attach user into a group
(config)#snmp-server community cm1 vrf management	Set community string as "cm1"
(config)#snmp-server community-map cm1 context context1 user user1 vrf management	Creates Community map SNMPv2 with community name mapping user with a context.
(config)#commit	Commit the candidate configuration to the running configuration
(config)#exit	Exit configure mode.
(config)#interface xe1	Enter interface mode for xe1.
(config-if)#ip address 94.94.94.3/24	Specify the IP address of the interface.
(config-if)#no shutdown	Activate the interface.
(config-if)#exit	Exit interface mode.
(config)#router ospf 100	Configure an OSPF instance with an instance ID of 100.
(config-router)#router-id 21.21.21.21	Configure the router ID to use on this instance.
(config-router)#network 94.94.94.0/24 area 0	Advertise the network with the area ID.
(config-router)#snmp context-name context1	SNMP Context is mapped with OSPF Instance
(config-router)#commit	Commit the candidate configuration to the running configuration.

R2

#configure terminal	Enter configure mode.
(config)#snmp-server enable snmp vrf management	Use this command to start the SNMP agent.
(config)#commit	Commit the candidate configuration to the running configuration
(config)#exit	Exit configure mode.
#configure terminal	Enter configure mode.
(config)#snmp-server context context1 vrf management	Creates SNMP Context with Context name.
(config)#snmp-server group group1 version 2c context context1 vrf management	Creates SNMP group with Group name and for specific context in SNMP v2 version.
(config)#snmp-server user user1 group1 vrf management	Creates SNMP User in SNMPv2 and attach user into a group
(config)#snmp-server community cm1 vrf management	Set community string as "cm1"
(config)#snmp-server community-map cm1 context context1 user user1 vrf management	Creates Community map SNMPv2 with community name mapping user with a context.
(config)#commit	Commit the candidate configuration to the running configuration
(config)#exit	Exit configure mode.
(config)#interface xe1	Enter interface mode for xe1.

(config-if)#ip address 94.94.94.2/24	Specify the IP address of the interface.
(config-if)#no shutdown	Activate the interface.
(config-if)#exit	Exit interface mode.
(config)#router ospf 100	Configure an OSPF instance with an instance ID of 100.
(config-router)#router-id 23.23.23.23	Configure the router ID to use on this instance.
(config-router)#network 94.94.94.0/24 area 0	Advertise the network with the area ID.
(config-router)#snmp context-name context1	SNMP Context is mapped with OSPF Instance
(config-router)#commit	Commit the candidate configuration to the running configuration.

Validation

R1

```
R1#sh running-config
!
! Software version: EC_AS7326-56X-OcNOS-5.1.194-DC-MPLS-S0-P0 04/20/2022 18:27:17
!
!Last configuration change at 12:56:57 UTC Fri Apr 22 2022 by ocnos
!
no service password-encryption
!
snmp-server enable traps link linkDown
snmp-server enable traps link linkUp
!
ip vrf management
!
hostname R1
!
feature telnet vrf management
no feature telnet
feature ssh vrf management
no feature ssh
snmp-server enable snmp vrf management
snmp-server view all .1 included vrf management
snmp-server context context1 vrf management
snmp-server group group1 version 2c context context1 vrf management
snmp-server user user1 group1 vrf management
snmp-server community cml vrf management
snmp-server community-map cml context context1 user user1 vrf management

!
interface ce1
!
interface ce2
!
interface eth0
  ip vrf forwarding management
```

OSPFv2

```
ip address dhcp
!
interface lo
ip address 127.0.0.1/8
ip address 21.21.21.21/32 secondary
ipv6 address ::1/128
!
interface lo.management
ip vrf forwarding management
ip address 127.0.0.1/8
ipv6 address ::1/128
!
interface xe1
ip address 94.94.94.3/24
!
interface xe2
!
interface xe3
!
interface xe4
!
interface xe5
!
interface xe6
!
interface xe7
!
interface xe8
!
interface xe9
!
router ospf 100
ospf router-id 21.21.21.21
snmp context-name context1
network 21.21.21.21/32 area 0.0.0.0
network 94.94.94.0/24 area 0.0.0.0
!
end
```

R1#

```
R1#show ip ospf neighbor
```

Total number of full neighbors: 1

OSPF process 100 VRF(default):

Neighbor ID	Pri	State	Dead Time	Address	Interface
23.23.23.23	1	Full/ -	00:00:37	94.94.94.2	xe1

```
R1#sh snmp context
```

```
-----  
context                                groups  
-----  
context1                                group1  
R1#
```

R2

```
R2#sh running-config  
!  
! Software version: EC_AS5912-54X-OcNOS-5.1.194-SP-MPLS-S0-P0 04/20/2022 18:28:57  
!  
!Last configuration change at 13:01:05 UTC Fri Apr 22 2022 by root  
!  
no service password-encryption  
!  
logging console 5  
logging level all 5  
snmp-server enable traps link linkDown  
snmp-server enable traps link linkUp  
!  
hostname R2  
bridge 1 protocol ieee vlan-bridge  
feature telnet vrf management  
no feature telnet  
feature ssh vrf management  
no feature ssh  
snmp-server enable snmp vrf management  
snmp-server view all .1 included vrf management  
snmp-server context context1 vrf management  
snmp-server group group1 version 2c context context1 vrf management  
snmp-server user user1 group1 vrf management  
snmp-server community cml vrf management  
snmp-server community-map cml context context1 user user1 vrf management  
feature ntp vrf management  
ntp enable vrf management  
!  
interface ce49  
!  
interface ce50  
!  
interface ce51  
!  
interface eth0  
 ip vrf forwarding management  
 ip address dhcp  
!  
interface lo  
 ip address 127.0.0.1/8  
 ip address 23.23.23.23/32 secondary
```

OSPFv2

```
ipv6 address ::1/128
!
interface lo.management
 ip vrf forwarding management
 ip address 127.0.0.1/8
 ipv6 address ::1/128
!
interface xe1
 ip address 94.94.94.2/24
!
interface xe3
!
interface xe4
!
interface xe5
!
interface xe6
!
interface xe7
!
interface xe8
!
interface xe9
!
interface xe10
!
router ospf 100
 ospf router-id 23.23.23.23
 snmp context-name context1
 network 23.23.23.23/32 area 0.0.0.0
 network 94.94.94.0/24 area 0.0.0.0
!
end
```

```
R2#
R2#sh snmp context
```

```
-----
context                                groups
-----
context1                                group1
R2#
```

SNMP WALK Command

Perform snmpwalk as mentioned below with IPv4 address using SNMPv2

```
snmpwalk -v2c -c cm1 10.12.86.116 .1.3
```

```
[root@localhost ~]# snmpwalk -v2c -c cm1 10.12.86.116 .1.3
```



```

OSPF-MIB::ospfRouterId.0 = IPAddress: 23.23.23.23
OSPF-MIB::ospfAdminStat.0 = INTEGER: enabled(1)
OSPF-MIB::ospfVersionNumber.0 = INTEGER: version2(2)
OSPF-MIB::ospfExternLsaCount.0 = Gauge32: 0
OSPF-MIB::ospfExternLsaCksumSum.0 = INTEGER: 0
OSPF-MIB::ospfTOSSupport.0 = INTEGER: false(2)
OSPF-MIB::ospfOriginateNewLsas.0 = Counter32: 3
OSPF-MIB::ospfRxNewLsas.0 = Counter32: 14
OSPF-MIB::ospfExtLsdbLimit.0 = INTEGER: -1
OSPF-MIB::ospfMulticastExtensions.0 = INTEGER: 0
OSPF-MIB::ospfExitOverflowInterval.0 = INTEGER: 0
OSPF-MIB::ospfDemandExtensions.0 = INTEGER: false(2)
OSPF-MIB::ospfRFC1583Compatibility.0 = INTEGER: false(2)
OSPF-MIB::ospfOpaqueLsaSupport.0 = INTEGER: true(1)
OSPF-MIB::ospfReferenceBandwidth.0 = Gauge32: 100000 kilobits per second
OSPF-MIB::ospfRestartSupport.0 = INTEGER: plannedAndUnplanned(3)
OSPF-MIB::ospfRestartInterval.0 = INTEGER: 120 seconds
OSPF-MIB::ospfRestartStrictLsaChecking.0 = INTEGER: true(1)
OSPF-MIB::ospfRestartStatus.0 = INTEGER: notRestarting(1)
OSPF-MIB::ospfRestartAge.0 = Gauge32: 0 seconds
OSPF-MIB::ospfRestartExitReason.0 = INTEGER: none(1)
OSPF-MIB::ospfAsLsaCount.0 = Gauge32: 0
OSPF-MIB::ospfAsLsaCksumSum.0 = Gauge32: 0
OSPF-MIB::ospfStubRouterSupport.0 = INTEGER: false(2)
OSPF-MIB::ospfStubRouterAdvertisement.0 = INTEGER: doNotAdvertise(1)
OSPF-MIB::ospfDiscontinuityTime.0 = Timeticks: (0) 0:00:00.00
OSPF-MIB::ospfAreaId.0.0.0.0 = IPAddress: 0.0.0.0
OSPF-MIB::ospfAuthType.0.0.0.0 = INTEGER: none(0)
OSPF-MIB::ospfImportAsExtern.0.0.0.0 = INTEGER: importExternal(1)
OSPF-MIB::ospfSpfRuns.0.0.0.0 = Counter32: 5
OSPF-MIB::ospfAreaBdrRtrCount.0.0.0.0 = Gauge32: 0
OSPF-MIB::ospfAsBdrRtrCount.0.0.0.0 = Gauge32: 0
OSPF-MIB::ospfAreaLsaCount.0.0.0.0 = Gauge32: 6
OSPF-MIB::ospfAreaLsaCksumSum.0.0.0.0 = INTEGER: 199510
OSPF-MIB::ospfAreaSummary.0.0.0.0 = INTEGER: sendAreaSummary(2)
OSPF-MIB::ospfAreaStatus.0.0.0.0 = INTEGER: active(1)
OSPF-MIB::ospfAreaNssaTranslatorRole.0.0.0.0 = INTEGER: 0
OSPF-MIB::ospfAreaNssaTranslatorState.0.0.0.0 = INTEGER: 0
OSPF-MIB::ospfAreaNssaTranslatorStabilityInterval.0.0.0.0 = INTEGER: 40 seconds
OSPF-MIB::ospfAreaLsaCountNumber.0.0.0.0 = Gauge32: 6
OSPF-MIB::ospfAreaLsaCountNumber.0.0.0.0 = No more variables left in this MIB View (It
is past the end of the MIB tree)
[root@localhost ~]#

```

Perform snmpwalk as mentioned below with IPv4 address using SNMPv2 for R2

```
snmpwalk -v2c -c cm1 10.12.86.111 .1.3
```

Enable SNMP and create SNMP Context & Group for OSPF Instances on a Router with SNMPv3 Configuration

In this example, routers R1 & R2 are in Area 0, and all run OSPF. SNMPv3 user is created and Mapping of user with group and context for SNMPwalk /SNMP get operation on context.

R1

#configure terminal	Enter configure mode.
(config)#snmp-server enable snmp vrf management	Use this command to start the SNMP agent.
(config)#commit	Commit the candidate configuration to the running configuration
(config)#exit	Exit configure mode.
#configure terminal	Enter configure mode.
(config)#snmp-server context context1 vrf management	Creates SNMP Context with Context name.
(config)#snmp-server group group2 version 3 auth context context1 vrf management	Creates SNMP group with Group name and for specific context in SNMP v3 version.
(config)#snmp-server user user2 group2 auth md5 password vrf management	Creates SNMP User in SNMPv3 and attach user into a group
(config)#commit	Commit the candidate configuration to the running configuration
(config)#exit	Exit configure mode.
(config)#interface xe1	Enter interface mode for xe1.
(config-if)#ip address 94.94.94.3/24	Specify the IP address of the interface.
(config-if)#no shutdown	Activate the interface.
(config-if)#exit	Exit interface mode.
(config)#router ospf 100	Configure an OSPF instance with an instance ID of 100.
(config-router)#router-id 21.21.21.21	Configure the router ID to use on this instance.
(config-router)#network 94.94.94.0/24 area 0	Advertise the network with the area ID.
(config-router)#snmp context-name context1	SNMP Context is mapped with OSPF Instance
(config-router)#commit	Commit the candidate configuration to the running configuration.

R2

#configure terminal	Enter configure mode.
(config)#snmp-server enable snmp vrf management	Use this command to start the SNMP agent.
(config)#commit	Commit the candidate configuration to the running configuration
(config)#exit	Exit configure mode.
#configure terminal	Enter configure mode.
(config)#snmp-server context context1 vrf management	Creates SNMP Context with Context name.

(config)#snmp-server group group2 version 3 auth context context1 vrf management	Creates SNMP group with Group name and for specific context in SNMP v3 version.
(config)#snmp-server user user2 group2 auth md5 password vrf management	Creates SNMP User in SNMPv2 and attach user into a group
(config)#commit	Commit the candidate configuration to the running configuration
(config)#exit	Exit configure mode.
(config)#interface xe1	Enter interface mode for xe1.
(config-if)#ip address 94.94.94.2/24	Specify the IP address of the interface.
(config-if)#no shutdown	Activate the interface.
(config-if)#exit	Exit interface mode.
(config)#router ospf 100	Configure an OSPF instance with an instance ID of 100.
(config-router)#router-id 23.23.23.23	Configure the router ID to use on this instance.
(config-router)#network 94.94.94.0/24 area 0	Advertise the network with the area ID.
(config-router)#snmp context-name context1	SNMP Context is mapped with OSPF Instance
(config-router)#commit	Commit the candidate configuration to the running configuration.

Validation

R1

```
R1#sh running-config
!
! Software version: EC_AS7326-56X-OcNOS-5.1.194-DC-MPLS-S0-P0 04/20/2022 18:27:1
7
!
!Last configuration change at 14:06:07 UTC Fri Apr 22 2022 by root
!
no service password-encryption
!
snmp-server enable traps link linkDown
snmp-server enable traps link linkUp
!
ip vrf management
!
hostname R1
ip name-server vrf management 10.12.3.23
feature telnet vrf management
no feature telnet
feature ssh vrf management
no feature ssh
snmp-server enable snmp vrf management
snmp-server view all .1 included vrf management
snmp-server context context1 vrf management
snmp-server group grp2 version 3 auth context context2 vrf management
snmp-server user user2 grp2 auth md5 encrypt 0x2eaaa9043312c907 vrf management
```

```
feature ntp vrf management
ntp enable vrf management
feature rsyslog vrf management
!
interface ce49
!
interface ce50
!
interface ce51
!
interface ce52
!
interface ce53
!
interface ce54
!
interface ce55
!
interface ce56
!
interface eth0
 ip vrf forwarding management
 ip address dhcp
!
interface lo
 ip address 127.0.0.1/8
 ip address 21.21.21.21/32 secondary
 ipv6 address ::1/128
!
interface lo.management
 ip vrf forwarding management
 ip address 127.0.0.1/8
 ipv6 address ::1/128
!
interface xe1
 ip address 94.94.94.3/24
!
interface xe2
!
interface xe3
!
interface xe4
!
interface xe5
!
interface xe6
!
interface xe7
!
interface xe8
```

```
!  
interface xe9  
!  
interface xe10  
!  
router ospf 100  
  ospf router-id 21.21.21.21  
  snmp context-name context1  
  network 21.21.21.21/32 area 0.0.0.0  
  network 94.94.94.0/24 area 0.0.0.0  
!  
line console 0  
  exec-timeout 0 0  
line vty 0 871  
  exec-timeout 0 0  
  privilege level 16  
!  
!  
end
```

```
R1#
```

R2

```
R2# sh run  
!  
! Software version: EC_AS5912-54X-OcNOS-5.1.194-SP-MPLS-S0-P0 04/20/2022 18:28:5  
7  
!  
!Last configuration change at 14:28:48 UTC Fri Apr 22 2022 by root  
!  
no service password-encryption  
!  
logging console 5  
logging level all 5  
snmp-server enable traps link linkDown  
snmp-server enable traps link linkUp  
!  
hostname R2  
no ip domain-lookup  
ip domain-lookup vrf management  
feature telnet vrf management  
no feature telnet  
feature ssh vrf management  
no feature ssh  
snmp-server enable snmp vrf management  
snmp-server view all .1 included vrf management  
snmp-server context context1 vrf management  
snmp-server group group2 version 3 auth context context1 vrf management  
snmp-server user user2 group2 auth md5 encrypt 0x2eaaa9043312c907 vrf management  
feature ntp vrf management
```

OSPFv2

```
ntp enable vrf management
feature rsyslog vrf management
!
interface ce49
!
interface ce50
!
interface ce51
!
interface ce52
!
interface ce53
!
interface ce54
!
interface eth0
 ip vrf forwarding management
 ip address dhcp
!
interface lo
 ip address 127.0.0.1/8
 ip address 23.23.23.23/32 secondary
 ipv6 address ::1/128
!
interface lo.management
 ip vrf forwarding management
 ip address 127.0.0.1/8
 ipv6 address ::1/128
!
interface xe1
 ip address 94.94.94.2/24
!
interface xe2
!
interface xe3
!
interface xe4
!
interface xe5
!
interface xe6
!
interface xe7
!
interface xe8
!
interface xe9
!
interface xe10
!
```

```

router ospf 100
  ospf router-id 23.23.23.23
  bfd all-interfaces
  network 23.23.23.23/32 area 0.0.0.0
  network 91.91.91.0/24 area 0.0.0.0
  network 94.94.94.0/24 area 0.0.0.0
  network 96.96.96.0/24 area 0.0.0.0
!
!
end

```

R2#

SNMP WALK Command

Perform snmpwalk as mentioned below with IPv4 address using SNMPv3 of R2

```

snmpwalk -v 3 -u user2 -l auth -r 0 -t 10 -n "context1" -a MD5 -A password 10.12.86.116
iso.3.6.1.2.1

```

```

[root@localhost ~]# snmpwalk -v 3 -u user2 -l auth -r 0 -t 10 -n "context1" -a MD5 -A
password 10.12.86.116 iso.3.6.1.2.1
OSPF-MIB::ospfRouterId.0 = IPAddress: 23.23.23.23
OSPF-MIB::ospfAdminStat.0 = INTEGER: enabled(1)
OSPF-MIB::ospfVersionNumber.0 = INTEGER: version2(2)
OSPF-MIB::ospfExternLsaCount.0 = Gauge32: 0
OSPF-MIB::ospfExternLsaCksumSum.0 = INTEGER: 0
OSPF-MIB::ospfTOSSupport.0 = INTEGER: false(2)
OSPF-MIB::ospfOriginateNewLsas.0 = Counter32: 3
OSPF-MIB::ospfRxNewLsas.0 = Counter32: 7
OSPF-MIB::ospfExtLsdbLimit.0 = INTEGER: -1
OSPF-MIB::ospfMulticastExtensions.0 = INTEGER: 0
OSPF-MIB::ospfExitOverflowInterval.0 = INTEGER: 0
OSPF-MIB::ospfDemandExtensions.0 = INTEGER: false(2)
OSPF-MIB::ospfRFC1583Compatibility.0 = INTEGER: false(2)
OSPF-MIB::ospfOpaqueLsaSupport.0 = INTEGER: true(1)
OSPF-MIB::ospfReferenceBandwidth.0 = Gauge32: 100000 kilobits per second
OSPF-MIB::ospfRestartSupport.0 = INTEGER: plannedAndUnplanned(3)
OSPF-MIB::ospfRestartInterval.0 = INTEGER: 120 seconds
OSPF-MIB::ospfRestartStrictLsaChecking.0 = INTEGER: true(1)
OSPF-MIB::ospfRestartStatus.0 = INTEGER: notRestarting(1)
OSPF-MIB::ospfRestartAge.0 = Gauge32: 0 seconds
OSPF-MIB::ospfRestartExitReason.0 = INTEGER: none(1)
OSPF-MIB::ospfAsLsaCount.0 = Gauge32: 0
OSPF-MIB::ospfAsLsaCksumSum.0 = Gauge32: 0
OSPF-MIB::ospfStubRouterSupport.0 = INTEGER: false(2)
OSPF-MIB::ospfStubRouterAdvertisement.0 = INTEGER: doNotAdvertise(1)
OSPF-MIB::ospfDiscontinuityTime.0 = Timeticks: (0) 0:00:00.00
OSPF-MIB::ospfAreaId.0.0.0.0 = IPAddress: 0.0.0.0
OSPF-MIB::ospfAuthType.0.0.0.0 = INTEGER: none(0)
OSPF-MIB::ospfAreaLsaCountNumber.0.0.0.0 = No more variables left in this MIB View (It
is past the end of the MIB tree)

```

```
[root@localhost ~]#
Perform snmpwalk as mentioned below with IPv4 address using SNMPv3 for R1.
snmpwalk -v 3 -u user2 -l auth -r 0 -t 10 -n "context1" -a MD5 -A password 10.12.86.111
iso.3.6.1.2.1
```

Enable SNMP and create SNMP Context & Group for Multiple OSPF Instances on a Router with SNMPv2/v3

In this example, routers R1, R2 & R3 are in Area 0, and all run OSPF. SNMPv2/v3 user is created and Mapping of user with group and context for SNMPwalk /SNMP get operation on context.

Topology

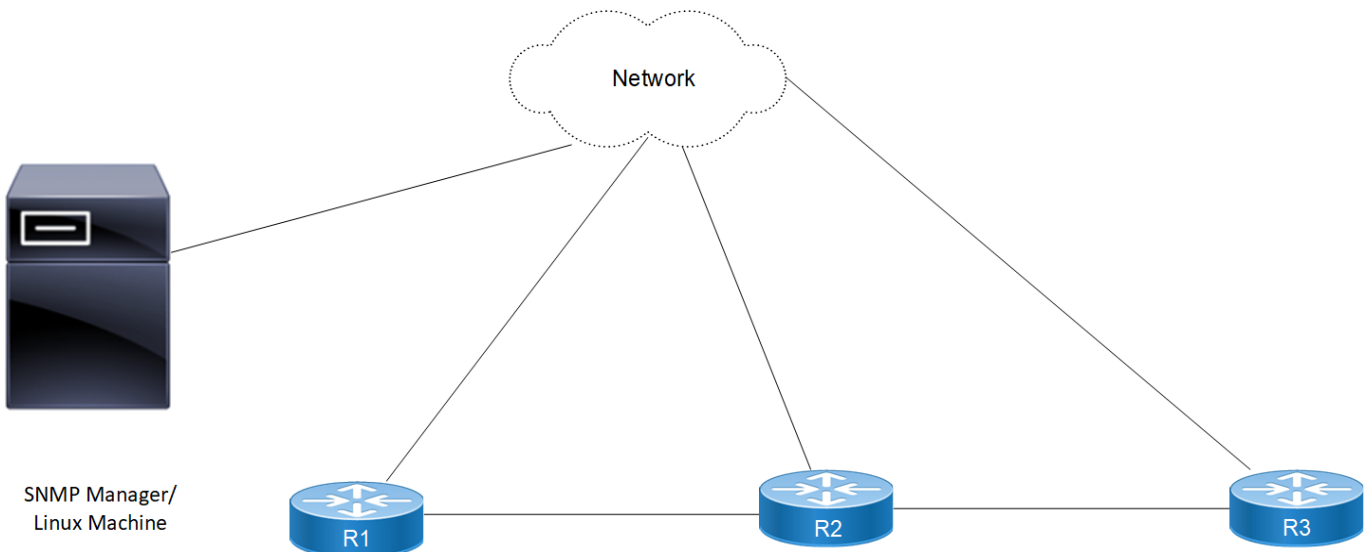

Figure 8-80: SNMP OSPF multiple instance

Configurations

R1

#configure terminal	Enter configure mode.
(config)#snmp-server enable snmp vrf management	Use this command to start the SNMP agent.
(config)#commit	Commit the candidate configuration to the running configuration
(config)#exit	Exit configure mode.
#configure terminal	Enter configure mode.
(config)#snmp-server context context1 vrf management	Creates SNMP Context with Context name.
(config)#snmp-server group group1 version 2c context context1 vrf management	Creates SNMP group with Group name and for specific context in SNMP v2 version.
(config)#snmp-server group group2 version 3 auth context context1 vrf ma	Creates SNMP group with Group name and for specific context in SNMP v3 version

(config)#snmp-server user user1 group1 vrf management	Creates SNMP User in SNMPv2 and attach user into a group
(config)#snmp-server user user2 group2 auth md5 password vrf management	Creates SNMP User in SNMPv3 and attach user into a group
(config)#snmp-server community cm1 vrf management	Set community string as "cm1"
(config)#snmp-server community-map cm1 context context1 user user1 vrf management	Creates Community map SNMPv2 with community name mapping user with a context.
(config)#commit	Commit the candidate configuration to the running configuration
(config)#exit	Exit configure mode.
(config)#interface xe1	Enter interface mode for xe1.
(config-if)#ip address 94.94.94.3/24	Specify the IP address of the interface.
(config-if)#no shutdown	Activate the interface.
(config-if)#exit	Exit interface mode.
(config)#router ospf 100	Configure an OSPF instance with an instance ID of 100.
(config-router)#router-id 21.21.21.21	Configure the router ID to use on this instance.
(config-router)#network 94.94.94.0/24 area 0	Advertise the network with the area ID.
(config-router)#snmp context-name context1	SNMP Context is mapped with OSPF Instance
(config-router)#commit	Commit the candidate configuration to the running configuration.

R2

#configure terminal	Enter configure mode.
(config)#snmp-server enable snmp vrf management	Use this command to start the SNMP agent.
(config)#commit	Commit the candidate configuration to the running configuration
(config)#exit	Exit configure mode.
#configure terminal	Enter configure mode.
(config)#snmp-server context context1 vrf management	Creates SNMP Context with Context name "context1".
(config)#snmp-server context context2 vrf management	Creates SNMP Context with Context name "context2".
(config)#snmp-server group group1 version 3 auth context context1 vrf management	Creates SNMP group with Group name and for context 1 in SNMP v3 version.
(config)#snmp-server group group1 version 3 auth context context2 vrf management	Creates SNMP group with Group name and for context 2 in SNMP v3 version.
(config)#snmp-server user user1 group1 auth md5 password vrf management	Creates SNMP User in SNMPv3 and attach user into a group
(config)#commit	Commit the candidate configuration to the running configuration
(config)#exit	Exit configure mode.
(config)#interface xe1	Enter interface mode for xe1.
(config-if)#ip address 94.94.94.2/24	Specify the IP address of the interface.

OSPFv2

(config-if)#no shutdown	Activate the interface.
(config-if)#exit	Exit interface mode.
(config)#interface xe2	Enter interface mode for xe2.
(config-if)#ip address 10.1.2.2/24	Specify the IP address of the interface.
(config-if)#no shutdown	Activate the interface.
(config-if)#exit	Exit interface mode.
(config)#router ospf 100	Configure an OSPF instance with an instance ID of 100.
(config-router)#router-id 23.23.23.23	Configure the router ID to use on this instance.
(config-router)#network 94.94.94.0/24 area 0	Advertise the network with the area ID.
(config-router)#snmp context-name context1	SNMP Context is mapped with OSPF Instance
(config-router)#commit	Commit the candidate configuration to the running configuration.
(config)#router ospf 200	Configure an OSPF instance with an instance ID of 200.
(config-router)#router-id 24.24.24.24	Configure the router ID to use on this instance.
(config-router)#network 10.1.2.0/24 area 0	Advertise the network with the area ID.
(config-router)#snmp context-name context2	SNMP Context is mapped with OSPF Instance
(config-router)#commit	Commit the candidate configuration to the running configuration.

R3

#configure terminal	Enter configure mode.
(config)#snmp-server enable snmp vrf management	Use this command to start the SNMP agent.
(config)#commit	Commit the candidate configuration to the running configuration
(config)#exit	Exit configure mode.
#configure terminal	Enter configure mode.
(config)#snmp-server context context2 vrf management	Creates SNMP Context with Context name.
(config)#snmp-server group group1 version 2c context context2 vrf management	Creates SNMP group with Group name and for specific context in SNMP v2 version.
(config)#snmp-server group group2 version 3 auth context context2 vrf management	Creates SNMP group with Group name and for specific context in SNMP v3 version
(config)#snmp-server user user1 group1 vrf management	Creates SNMP User in SNMPv2 and attach user into a group
(config)#snmp-server user user2 group2 auth md5 password vrf management	Creates SNMP User in SNMPv3 and attach user into a group
(config)#snmp-server community cm1 vrf management	Set community string as "cm1"
(config)#snmp-server community-map cm1 context context1 user user1 vrf management	Creates Community map SNMPv2 with community name mapping user with a context.
(config)#commit	Commit the candidate configuration to the running configuration
(config)#exit	Exit configure mode.
(config)#interface xe2	Enter interface mode for xe2.

(config-if)#ip address 10.1.2.3/24	Specify the IP address of the interface.
(config-if)#no shutdown	Activate the interface.
(config-if)#exit	Exit interface mode.
(config)#router ospf 200	Configure an OSPF instance with an instance ID of 200.
(config-router)#router-id 24.24.24.24	Configure the router ID to use on this instance.
(config-router)#network 10.1.2.0/24 area 0	Advertise the network with the area ID.
(config-router)#snmp context-name context2	SNMP Context is mapped with OSPF Instance
(config-router)#commit	Commit the candidate configuration to the running configuration.

Validation

R1

```
R1#show run
!
! Software version: EC_AS7326-56X-OcNOS-5.1.194-DC-MPLS-S0-P0 04/20/2022 18:27:1
7
!
!Last configuration change at 15:10:23 UTC Fri Apr 22 2022 by root
!
no service password-encryption
!
snmp-server enable traps link linkDown
snmp-server enable traps link linkUp
!
ip vrf management
!
hostname R1
no ip domain-lookup
ip domain-lookup vrf management
ip name-server vrf management 10.12.3.23
tfo Disable
errdisable cause stp-bpdu-guard
feature telnet vrf management
no feature telnet
feature ssh vrf management
no feature ssh
snmp-server enable snmp vrf management
snmp-server view all .1 included vrf management
snmp-server context context1 vrf management
snmp-server group grp1 version 2c context context1 vrf management
snmp-server group grp2 version 3 auth context context1 vrf management
snmp-server user user1 grp1 vrf management
snmp-server user user2 grp2 auth md5 encrypt 0x2eaaa9043312c907 vrf management
snmp-server community cx1 vrf management
snmp-server community-map cx1 context context1 user user1 vrf management
feature ntp vrf management
```

OSPFv2

```
ntp enable vrf management
feature rsyslog vrf management
!
interface ce49
!
interface ce50
!
interface ce51
!
interface ce52
!
interface ce53
!
interface ce54
!
interface ce55
!
interface ce56
!
interface eth0
 ip vrf forwarding management
 ip address dhcp
!
interface lo
 ip address 127.0.0.1/8
 ip address 21.21.21.21/32 secondary
 ipv6 address ::1/128
!
interface lo.management
 ip vrf forwarding management
 ip address 127.0.0.1/8
 ipv6 address ::1/128
!
interface xe1
 ip address 94.94.94.3/24
!
interface xe2
!
interface xe3
!
interface xe4
!
interface xe5
!
interface xe6

interface xe7
!
interface xe8
!
```

```
interface xe9
!
interface xe10
!
router ospf 100
  ospf router-id 21.21.21.21
  snmp context-name context1
  network 21.21.21.21/32 area 0.0.0.0
  network 94.94.94.0/24 area 0.0.0.0
!
line console 0
  exec-timeout 0 0
line vty 0 871
  exec-timeout 0 0
  privilege level 16
!
!
end
```

R1#

R2

```
R2(config)#show run
!
! Software version: EC_AS5912-54X-OcNOS-5.1.194-SP-MPLS-S0-P0 04/20/2022 18:28:5
7
!
!Last configuration change at 15:19:14 UTC Fri Apr 22 2022 by ocnos
!
no service password-encryption
!
logging console 5
logging level all 5
snmp-server enable traps link linkDown
snmp-server enable traps link linkUp
!
p vrf management
!
hostname R2
no ip domain-lookup
ip domain-lookup vrf management
feature telnet vrf management
no feature telnet
feature ssh vrf management
no feature ssh
snmp-server enable snmp vrf management
snmp-server view all .1 included vrf management
snmp-server context context1 vrf management
snmp-server context context2 vrf management
```

OSPFv2

```
snmp-server group group1 version 3 auth context context1 vrf management
snmp-server group group1 version 3 auth context context2 vrf management
snmp-server user user1 group1 auth md5 encrypt 0x2eaaa9043312c907 vrf management
feature ntp vrf management
ntp enable vrf management
feature rsyslog vrf management
!
interface ce49
!
interface ce50
!
interface ce51
!
interface ce52
!
interface ce53
!
interface ce54
!
interface eth0
 ip vrf forwarding management
 ip address dhcp
!
interface lo
 ip address 127.0.0.1/8
 ip address 23.23.23.23/32 secondary
 ipv6 address ::1/128
!
interface lo.management
 ip vrf forwarding management
 ip address 127.0.0.1/8
 ipv6 address ::1/128
!
interface xe1
 ip address 94.94.94.2/24
!
interface xe2
 ip address 10.1.2.2/24
!
interface xe3
!
interface xe4
!
interface xe5
!
interface xe6
!
interface xe7
!
interface xe8
```

```
!  
interface xe9  
!  
interface xe10  
!  
router ospf 100  
  ospf router-id 23.23.23.23  
  snmp context-name context1  
  network 23.23.23.23/32 area 0.0.0.0  
  network 94.94.94.0/24 area 0.0.0.0  
!  
router ospf 200  
  snmp context-name context2  
  network 10.1.2.0/24 area 0.0.0.0  
!  
end
```

R2#

R3

```
R3#show run  
!  
! Software version: EC_AS7316-26XB-OcNOS-5.1.194-SP-CSR-S0-P0 04/20/2022 18:28:5  
9  
!  
!Last configuration change at 11:05:18 UTC Mon Feb 25 2019 by ocnos  
!  
no service password-encryption  
!  
snmp-server enable traps link linkDown  
snmp-server enable traps link linkUp  
!  
ip vrf management  
!  
hostname R3  
no ip domain-lookup  
ip domain-lookup vrf management  
tfo Disable  
errdisable cause stp-bpdu-guard  
feature telnet vrf management  
no feature telnet  
feature ssh vrf management  
no feature ssh  
snmp-server enable snmp vrf management  
snmp-server view all .1 included vrf management  
snmp-server context context2 vrf management  
snmp-server group group2 version 3 auth context context2 vrf management  
snmp-server group group1 version 2c context context2 vrf management  
snmp-server user user2 group2 auth md5 encrypt 0x2eaaa9043312c907 vrf management  
snmp-server user user1 group1 vrf management
```

OSPFv2

```
snmp-server community cx1 vrf management
snmp-server community-map cx1 context context2 user user1 vrf management
feature ntp vrf management
ntp enable vrf management
feature rsyslog vrf management
!
interface ce0
!
interface ce1
!
interface eth0
 ip vrf forwarding management
 ip address 192.168.3.10/24
!
interface lo
 ip address 127.0.0.1/8
 ip address 24.24.24.24/24 secondary
 ipv6 address ::1/128
!
interface lo.management
 ip vrf forwarding management
 ip address 127.0.0.1/8
 ipv6 address ::1/128
!
interface xe0
!
interface xe1
!
interface xe2
 ip address 10.1.2.3/24
!
interface xe3
!
interface xe4
!
interface xe5
!
interface xe6
!
interface xe7
!
interface xe8
!
interface xe9
!
interface xe10
!
router ospf 200
 ospf router-id 24.24.24.24
 snmp context-name context2
```

```
network 10.1.2.0/24 area 0.0.0.0
network 24.24.24.0/24 area 0.0.0.0
!
!
end
```

```
R3#
```

SNMP WALK Command

Perform snmpwalk as mentioned below with IPv4 address using SNMPv3 for R1:

```
snmpwalk -v 3 -u user2 -l auth -r 0 -t 10 -n "context1" -a MD5 -A password 10.12.86.111
iso.3.6.1.2.1
```

Perform snmpwalk as mentioned below with IPv4 address using SNMPv2/SNMPv3 for R2:

```
snmpwalk -v 3 -u user1 -l auth -r 0 -t 10 -n "context2" -a MD5 -A password 10.12.86.116
iso.3.6.1.2.1
```

Perform snmpwalk as mentioned below with IPv4 address using SNMPv3 for R3:

```
snmpwalk -v 3 -u user2 -l auth -r 0 -t 10 -n "context2" -a MD5 -A password 10.12.86.132
iso.3.6.1.2.1
```

OSPF Stub Router Advertisement

The OSPF Stub router feature lets you to prevent a new router in any network from being used as a transit router.

This feature enables the new router to originate link-state advertisement(LSAs) with a maximum metric, thereby causing other routers in the network to prefer alternate-paths instead of using the new router as a transit path to forward traffic. Thereby this feature allows switching and routing functions to be up and running and routing tables to converge before transit traffic is routed again through this new router

Also a startup timer can be configured on this new router enabling it to advertise a maximum metric when the router is started or reloaded

The configuration given below enables the router R3 to advertise router-LSAs/summary-LSAs with maximum metric two routers in Area 0 connecting to network 10.10.10.0/24.

Note: Configure one interface so that it belongs to only one area. It is possible, however, to configure different interfaces on a router to belong to different areas.

Topology

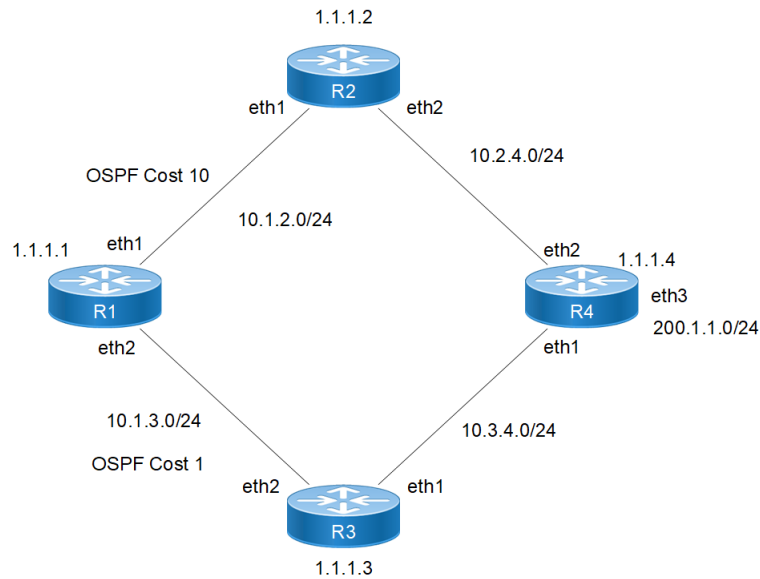

Figure 8-81: OSPF Stub Router Advertisement Topology

Configuration

R1

<code>#configure terminal</code>	Enter configure mode
<code>(config)#router ospf 1</code>	Configure the routing process, and specify the Process ID (1). The Process ID should be a unique positive integer identifying the routing process.
<code>(config)#ospf router-id 1.1.1.1</code>	Configure the OSPF router-id
<code>(config-router)#network 10.1.2.0/24 area 0</code>	Define the interface (10.1.2.0/24) on which OSPF runs, and associate the area ID (0) with the interface (area ID 0 specifies the backbone area).
<code>(config-router)#network 10.1.3.0/24 area 0</code>	Define the interface (10.1.3.0/24) on which OSPF runs, and associate the area ID (0) with the interface (area ID 0 specifies the backbone area).
<code>(config-router)#exit</code>	Exit router mode
<code>(config)#interface eth1</code>	Enter the interface configuration mode for interface eth1
<code>(config-if)#ip ospf cost 10</code>	Configure the OSPF cost for the interface
<code>(config-if)#exit</code>	Exit the interface configuration mode
<code>(config)#commit</code>	Commit the candidate configuration to the running configuration.

R2

#configure terminal	Enter configure mode
(config)#router ospf 1	Configure the routing process, and specify the Process ID (1). The Process ID should be a unique positive integer identifying the routing process.
(config)#ospf router-id 1.1.1.2	Configure the OSPF router-id
(config-router)#network 10.1.2.0/24 area 0	Define the interface (10.1.2.0/24) on which OSPF runs, and associate the area ID (0) with the interface (area ID 0 specifies the backbone area).
(config-router)#network 10.2.4.0/24 area 1	Define the interface (10.2.4.0/24) on which OSPF runs, and associate the area ID (1) with the interface
(config-router)#exit	Exit router mode
(config)#commit	Commit the candidate configuration to the running configuration.

R3

#configure terminal	Enter configure mode
(config)#router ospf 1	Configure the routing process, and specify the Process ID (1). The Process ID should be a unique positive integer identifying the routing process.
(config)#ospf router-id 1.1.1.3	Configure the OSPF router-id
(config-router)#network 1.1.1.3/32 area 0	Define the interface (1.1.1.3/32) on which OSPF runs, and associate the area ID (0) with the interface (area ID 0 specifies the backbone area).
(config-router)#network 10.1.3.0/24 area 0	Define the interface (10.1.3.0/24) on which OSPF runs, and associate the area ID (0) with the interface (area ID 0 specifies the backbone area).
(config-router)#network 10.3.4.0/24 area 1	Define the interface (10.3.4.0/24) on which OSPF runs, and associate the area ID (1) with the interface
(config-router)#max-metric router-lsa include-stub summary-lsa 100	Configure the router to advertise max-metric for router-LSAs, for stub-networks of router-LSAs and to advertise a metric value of 100 for summary-LSAs
(config-router)# max-metric router-lsa on- startup 300 include-stub summary-lsa 222	Configure the router to advertise max-metric for router-LSAs, for stub-networks of router-LSAs and to advertise a metric value of 222 for summary-LSAs on-startup
(config-router)#exit	Exit router mode
(config)#commit	Commit the candidate configuration to the running configuration.

R4

#configure terminal	Enter configure mode
(config)#router ospf 1	Configure the routing process, and specify the Process ID (1). The Process ID should be a unique positive integer identifying the routing process.
(config)#ospf router-id 1.1.1.4	Configure the OSPF router-id

(config-router)#network 10.2.4.0/24 area 1	Define the interface (10.2.4.0/24) on which OSPF runs, and associate the area ID (1) with the interface
(config-router)#network 10.3.4.0/24 area 1	Define the interface (10.3.4.0/24) on which OSPF runs, and associate the area ID (1) with the interface
(config-router)#network 200.1.1.0/24 area 1	Define the interface (200.1.1.0/24) on which OSPF runs, and associate the area ID (1) with the interface
(config-router)#exit	Exit router mode
(config)#commit	Commit the candidate configuration to the running configuration.

Validation

R3

```
R3#show running-config ospf
!
router ospf 1
  ospf router-id 1.1.1.3
  max-metric router-lsa include-stub summary-lsa 100
  max-metric router-lsa on-startup 300 include-stub summary-lsa 222
  network 1.1.1.3/32 area 0.0.0.0
  network 10.1.3.0/24 area 0.0.0.0
  network 10.3.4.0/24 area 0.0.0.1
!
R3#
```

```
R3#show ip ospf
Routing Process "ospf 1" with ID 1.1.1.3
Process uptime is 1 hour 20 minutes
Process bound to VRF default
Conforms to RFC2328, and RFC1583 Compatibility flag is disabled
Supports only single TOS(TOS0) routes
Supports opaque LSA
Originating router-LSAs with maximum metric
  Condition: always State: active
    Advertise stub links with maximum metric in router-LSAs
    Advertise summary-LSAs with metric 100
  Condition: on start-up for 300 seconds State: Inactive
    Advertise stub links with maximum metric in router-LSAs
    Advertise summary-LSAs with metric 222
Supports Graceful Restart
This router is an ABR, ABR Type is Alternative Cisco (RFC3509)
SPF schedule delay initial 0 secs 500 msec
SPF schedule delay min 0 secs 500 msec
SPF schedule delay max 50 secs 0 msec
Refresh timer 10 secs
Number of incoming current DD exchange neighbors 0/64
Number of outgoing current DD exchange neighbors 0/64
Initial LSA throttle delay 0 secs 0 msec
Minimum hold time for LSA throttle 5 secs 0 msec
Maximum wait time for LSA throttle 5 secs 0 msec
Minimum LSA arrival 1 secs 0 msec
Number of external LSA 0. Checksum 0x000000
```

```

Number of opaque AS LSA 0. Checksum 0x000000
Number of non-default external LSA 0
External LSA database is unlimited.
Number of LSA originated 17
Number of LSA received 98
IPFRR per-prefix tiebreakers:
  Name                               Index
  Primary path                       20
  Node Protecting                    30
  Interface disjoint                 60
  Broadcast interface disjoint       70
  Downstream path                    90
  Secondary path                     255
LFA termination hold-on timer : 0 secs 600 msec
Number of areas attached to this router: 2
MemPool - struct ospf lsa           : (0-38) | Total (38/100000)
blk_size:168
MemPool - struct rxmt               : | Total (0/0) blk_size:8
MemPool - OSPF RIB msg4             : | Total (0/0) blk_size:2920
MemPool - OSPF RIB msg4 nh 1       : | Total (0/0) blk_size:24
MemPool - OSPF RIB msg4 nh 2       : | Total (0/0) blk_size:48
MemPool - OSPF RIB msg4 nh 4       : | Total (0/0) blk_size:96
MemPool - OSPF RIB msg4 nh 8       : | Total (0/0) blk_size:192
MemPool - OSPF RIB msg4 nh 16      : | Total (0/0) blk_size:384
MemPool - OSPF RIB msg4 nh 32      : | Total (0/0) blk_size:768
MemPool - OSPF RIB msg4 nh 64      : | Total (0/0) blk_size:1536
MemPool - OSPF RIB msg4 nh 128     : | Total (0/0) blk_size:3072
MemPool - OSPF RIB msg4 nh 255     : | Total (0/0) blk_size:6120
  Area 0.0.0.0 (BACKBONE)
    Number of interfaces in this area is 2(2)
    Number of fully adjacent neighbors in this area is 1
    Area has no authentication
    SPF algorithm last executed 00:03:05.287 ago
    SPF algorithm executed 12 times
    Number of LSA 18. Checksum 0x070234
  Area 0.0.0.1
    Number of interfaces in this area is 1(1)
    Number of fully adjacent neighbors in this area is 1
    Number of fully adjacent virtual neighbors through this area is 0
    Area has no authentication
    SPF algorithm last executed 00:03:34.838 ago
    SPF algorithm executed 7 times
    Number of LSA 18. Checksum 0x09c738

R3#

R3#show ip ospf database router self-originate

      OSPF Router with ID (1.1.1.3) (Process ID 1 VRF default)

        Router Link States (Area 0.0.0.0)

          LS age: 188
          Options: 0x22 (-|-|DC|-|-|-|E|-)
          Flags: 0x1 : ABR
          LS Type: Router-LSA

```

Link State ID: 1.1.1.3
Advertising Router: 1.1.1.3
LS Seq Number: 8000000b
Checksum: 0x9c4b
Length: 48
Number of Links: 2

Link connected to: Stub Network

(Link ID) Network/subnet number: 1.1.1.3
(Link Data) Network Mask: 255.255.255.255
Number of TOS metrics: 0
TOS 0 Metric: 65535

Link connected to: a Transit Network

(Link ID) Designated Router address: 10.1.3.1
(Link Data) Router Interface address: 10.1.3.2
Number of TOS metrics: 0
TOS 0 Metric: 65535

Router Link States (Area 0.0.0.1)

LS age: 188
Options: 0x22 (-|-|DC|-|-|-|E|-)
Flags: 0x1 : ABR
LS Type: Router-LSA
Link State ID: 1.1.1.3
Advertising Router: 1.1.1.3
LS Seq Number: 8000000c
Checksum: 0xc531
Length: 36
Number of Links: 1

Link connected to: a Transit Network

(Link ID) Designated Router address: 10.3.4.2
(Link Data) Router Interface address: 10.3.4.1
Number of TOS metrics: 0
TOS 0 Metric: 65535

R3#

R3#show ip ospf database summary self-originate

OSPF Router with ID (1.1.1.3) (Process ID 1 VRF default)

Summary Link States (Area 0.0.0.0)

LS age: 204
Options: 0x22 (-|-|DC|-|-|-|E|-)
LS Type: Summary-LSA
Link State ID: 10.2.4.0 (summary Network Number)
Advertising Router: 1.1.1.3
LS Seq Number: 80000009
Checksum: 0x7446
Length: 28
Network Mask: /24

TOS: 0 Metric: 100

LS age: 204
Options: 0x22 (-|-|DC|-|-|-|E|-)
LS Type: Summary-LSA
Link State ID: 10.3.4.0 (summary Network Number)
Advertising Router: 1.1.1.3
LS Seq Number: 80000008
Checksum: 0x6a50
Length: 28
Network Mask: /24

TOS: 0 Metric: 100

LS age: 204
Options: 0x22 (-|-|DC|-|-|-|E|-)
LS Type: Summary-LSA
Link State ID: 200.1.1.0 (summary Network Number)
Advertising Router: 1.1.1.3
LS Seq Number: 80000009
Checksum: 0xf10e
Length: 28
Network Mask: /24

TOS: 0 Metric: 100

Summary Link States (Area 0.0.0.1)

LS age: 204
Options: 0x22 (-|-|DC|-|-|-|E|-)
LS Type: Summary-LSA
Link State ID: 1.1.1.3 (summary Network Number)
Advertising Router: 1.1.1.3
LS Seq Number: 80000008
Checksum: 0xfaca
Length: 28
Network Mask: /32

TOS: 0 Metric: 100

LS age: 203
Options: 0x22 (-|-|DC|-|-|-|E|-)
LS Type: Summary-LSA
Link State ID: 10.1.2.0 (summary Network Number)
Advertising Router: 1.1.1.3
LS Seq Number: 8000000c
Checksum: 0x902a
Length: 28
Network Mask: /24

TOS: 0 Metric: 100

LS age: 204
Options: 0x22 (-|-|DC|-|-|-|E|-)
LS Type: Summary-LSA
Link State ID: 10.1.3.0 (summary Network Number)
Advertising Router: 1.1.1.3
LS Seq Number: 80000008
Checksum: 0x8d30
Length: 28

Network Mask: /24
TOS: 0 Metric: 100

R3#

CHAPTER 9 OSPF Sham-link for VPN Sites Configuration

This feature is to ensure that the OSPF Client sites that share a backdoor link can communicate over the MPLS VPN backbone and participate in VPN services.

Suppose that there are two sites in same OSPF area and each of them is attached to a different PE router, and there is also an intra-area ospf backdoor link connecting the two sites. There will be routes between sites that go through the PE routers, but these routes will appear to be inter area routes, and OSPF will consider them less preferable than the intra-area routes through the backdoor link. To make a route through the backbone appear to be an intra-area route, it is necessary to make it appear as if there is an intra-area link connecting the two PE routers. Sham-links are those links routes the intra-area routes through the backbone.

Topology

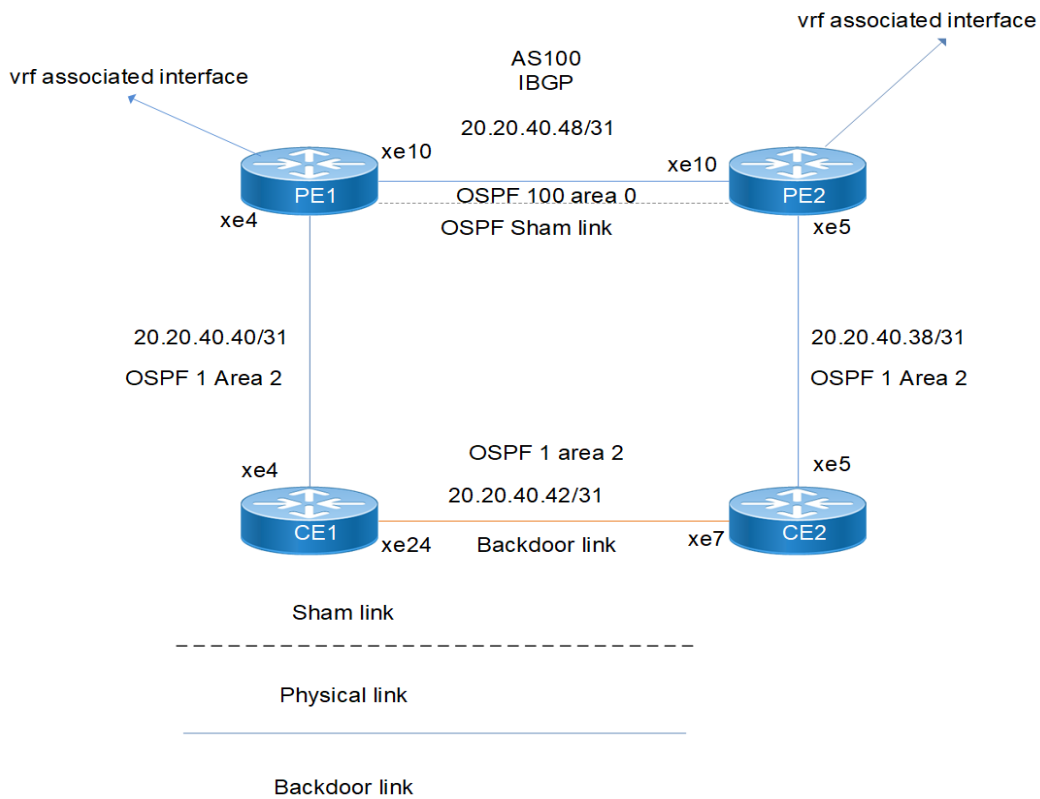

Figure 9-82: OSPF SHAM-LINK FOR VPN SITES

Configuration

CE1

#configure terminal	Enter the Configure mode.
(config)#interface lo	Enter interface mode

OSPF Sham-link for VPN Sites Configuration

(config-if)#ip address 1.1.1.1/32 secondary	Configure the IP address of the interface loopback
(config-if)#exit	Exit interface mode
(config)# commit	Committing the configuration to apply in running configuration
(config)#interface xe4	Enter interface mode
(config-if)#ip address 20.20.40.40/31	Configure the IP address on the interface
(config-if)# description to_pe1	Adding Description to interface
(config-if)#exit	Exit interface mode.
(config)# commit	Committing the configuration to apply in running configuration
(config)#interface xe24	Enter interface mode
(config-if)#ip address 20.20.40.42/31	Configure the IP address on the interface
(config-if)# description ospf backdoor	Adding Description to interface
(config-if)# ip ospf cost 10	Set the OSPF cost of this link
(config-if)#exit	Exit interface mode.
(config)# commit	Committing the configuration to apply in running configuration
(config)#router ospf 1	Configure the routing process OSPF with process id
(config-router)#network 1.1.1.1/32 area 2	Define the interface on which OSPF runs, and associate the area ID with the interface.
(config-router)#network 20.20.40.40/31 area 2	Define the interface on which OSPF runs, and associate the area ID with the interface.
(config-router)#network 20.20.40.42/31 area 2	Define the interface on which OSPF runs, and associate the area ID with the interface.
(config-router)#exit	Exit from router ospf mode
(config)# commit	Committing the configuration to apply in running configuration

PE1

#configure terminal	Enter the Configure mode.
(config)#interface lo	Enter interface mode
(config-if)#ip address 2.2.2.2/32	Configure the IP address of the interface loopback
(config-if)#exit	Exit interface mode
(config)# commit	Committing the configuration to apply in running configuration
(config)#ip vrf vrf1	Create vrf1
(config-vrf)# description vrf1	Adding description to vrf
(config-vrf)#rd 100:1	Specify the route distinguisher in the VRF
(config-vrf)#route-target both 100:1	Specify the import & export route target
(config)# commit	Committing the configuration to apply in running configuration
(config)# router ldp	Configure Router LDP instance
(config)# commit	Committing the configuration to apply in running configuration
(config)#interface xe4	Enter interface mode
(config-if)# description to_cel1	Adding description to interface
(config-if)# ip vrf forwarding vrf1	Associate the interface to vrf1
(config-if)#ip address 20.20.40.41/31	Configure the IP address on the interface

(config-if)#exit	Exit interface mode.
(config)#interface xe10	Enter interface mode
(config-if)# description to_pe2	Adding description to interface
(config-if)#ip address 20.20.40.48/31	Configure the IP address on the interface
(config-if)#label-switching	Enable label-switching on interface
(config-if)# enable-ldp ipv4	Enable LDP process on interface
(config-if)#exit	Exit interface mode.
(config)# commit	Committing the configuration to apply in running configuration
(config)# interface lo.vrf1	Enter interface mode
(config-if)# ip vrf forwarding vrf1	Associate the interface to vrf1
ip address 11.11.11.11/32 secondary	Configure the IP address on the interface
(config)# commit	Committing the configuration to apply in running configuration
(config)#router ospf 1 vrf1	Associate the ospf process with vrf1.
(config-router)# redistribute bgp	Redistribute BGP into OSPF.
(config-router)#network 20.20.40.40/31 area 2	Define the interface on which OSPF runs, and associate the area ID with the interface.
(config-router)# area 0.0.0.2 sham-link 11.11.11.11 22.22.22.22 cost 5	Configuring Sham-link between PE routers with cost 5.
(config-router)#exit	Exit from router ospf mode
(config)#router ospf 100	Configure the routing process OSPF with process id
(config-router)#network 2.2.2.2/32 area 2	Define the interface on which OSPF runs, and associate the area ID with the interface.
(config-router)#network 20.20.40.48/31 area 0	Define the interface on which OSPF runs, and associate the area ID (0) with the interface (area ID 0 specifies the backbone area).
(config-router)#exit	Exit from router ospf mode
(config)# commit	Committing the configuration to apply in running configuration
(config)#router bgp 100	Enter Router BGP mode
(config-router)#neighbor 3.3.3.3 remote-as 100	Add loopback ip of ABR2 as neighbor with neighbor AS
(config-router)#neighbor 3.3.3.3 update-source 2.2.2.2	Update the source for that particular neighbor as loopback interface
(config-router)#address-family vpv4 unicast	Enter into vpv4 unicast address family
(config-router-af)#neighbor 3.3.3.3 activate	Activate the neighbor inside vpv4 address family
(config-router-af)#exit-address-family	Exit from address family vpv4
(config-router)# address-family ipv4 vrf vrf1	Enter into vrf address family
(config-router-af)# network 11.11.11.11/32	Advertise a route via iBGP connection.
(config-router-af)#redistribute ospf 1	Redistribute ospf routes into bgp
(config-router-af)#exit-address-family	Exit from address family vpv4
(config-router)#exit	Exit from router BGP mode
(config)# commit	Committing the configuration to apply in running configuration
(config)#end	Exit from config mode into privilege mode

PE2

#configure terminal	Enter the Configure mode.
(config)#interface lo	Enter interface mode
(config-if)#ip address 3.3.3.3/32	Configure the IP address of the interface loopback
(config-if)#exit	Exit interface mode
(config)# commit	Committing the configuration to apply in running configuration
(config)#ip vrf vrf1	Create vrf1
(config-vrf)# description vrf1	Adding description to vrf
(config-vrf)#rd 100:1	Specify the route distinguisher in the VRF
(config-vrf)#route-target both 100:1	Specify the import & export route target
(config)# commit	Committing the configuration to apply in running configuration
(config)# router ldp	Configure Router LDP instance
(config)# commit	Committing the configuration to apply in running configuration
(config)#interface xe5	Enter interface mode
(config-if)# description to_ce2	Adding description to interface
(config-if)# ip vrf forwarding vrf1	Associate the interface to vrf1
(config-if)# ip address 20.20.40.38/31	Configure the IP address on the interface
(config-if)#exit	Exit interface mode.
(config)#interface xe10	Enter interface mode
(config-if)# description to_pe1	Adding description to interface
(config-if)#ip address 20.20.40.49/31	Configure the IP address on the interface
(config-if)#label-switching	Enable label-switching on interface
(config-if)# enable-ldp ipv4	Enable LDP process on interface
(config-if)#exit	Exit interface mode.
(config)# commit	Committing the configuration to apply in running configuration
(config)# interface lo.vrf1	Enter interface mode
(config-if)# ip vrf forwarding vrf1	Associate the interface to vrf1
ip address 22.22.22.22/32 secondary	Configure the IP address on the interface
(config)# commit	Committing the configuration to apply in running configuration
(config)#router ospf 1 vrf1	Associate the ospf process with vrf1.
(config-router)# redistribute bgp	Redistribute BGP into OSPF.
(config-router)#network 20.20.40.38/31 area 2	Define the interface on which OSPF runs, and associate the area ID with the interface.
(config-router)# area 0.0.0.2 sham-link 22.22.22.22 11.11.11.11 cost 5	Configuring Sham-link between PE routers with cost 5.
(config-router)#exit	Exit from router ospf mode
(config)#router ospf 100	Configure the routing process OSPF with process id
(config-router)#network 3.3.3.3/32 area 2	Define the interface on which OSPF runs, and associate the area ID with the interface.
(config-router)#network 20.20.40.48/31 area 0	Define the interface on which OSPF runs, and associate the area ID (0) with the interface (area ID 0 specifies the backbone area).

(config-router)#exit	Exit from router ospf mode
(config)# commit	Committing the configuration to apply in running configuration
(config)#router bgp 100	Enter Router BGP mode
(config-router)#neighbor 2.2.2.2 remote-as 100	Add loopback ip of ABR2 as neighbor with neighbor AS
(config-router)#neighbor 2.2.2.2 update-source 3.3.3.3	Update the source for that particular neighbor as loopback interface
(config-router)#address-family vpnv4 unicast	Enter into vpnv4 unicast address family
(config-router-af)#neighbor 2.2.2.2 activate	Activate the neighbor inside vpnv4 address family
(config-router-af)#exit-address-family	Exit from address family vpnv4
(config-router)# address-family ipv4 vrf vrfl	Enter into vrf address family
(config-router-af)# network 22.22.22.22/32	Advertise a route via iBGP connection.
(config-router-af)#redistribute ospf 1	Redistribute ospf routes into bgp
(config-router-af)#exit-address-family	Exit from address family vpnv4
(config-router)#exit	Exit from router BGP mode
(config)# commit	Committing the configuration to apply in running configuration
(config)#end	Exit from config mode into privilege mode

CE2

#configure terminal	Enter the Configure mode.
(config)#interface lo	Enter interface mode
(config-if)#ip address 4.4.4.4/32 secondary	Configure the IP address of the interface loopback
(config-if)#exit	Exit interface mode
(config)# commit	Committing the configuration to apply in running configuration
(config)#interface xe5	Enter interface mode
(config-if)#ip address 20.20.40.39/31	Configure the IP address on the interface
(config-if)# description to_pe2	Adding Description to interface
(config-if)#exit	Exit interface mode.
(config)# commit	Committing the configuration to apply in running configuration
(config)#interface xe7	Enter interface mode
(config-if)#ip address 20.20.40.43/31	Configure the IP address on the interface
(config-if)# description ospf backdoor	Adding Description to interface
(config-if)# ip ospf cost 10	Set the OSPF cost of this link
(config-if)#exit	Exit interface mode.
(config)# commit	Committing the configuration to apply in running configuration
(config)#router ospf 1	Configure the routing process OSPF with process id
(config-router)#network 4.4.4.4/32 area 2	Define the interface on which OSPF runs, and associate the area ID with the interface.
(config-router)#network 20.20.40.38/31 area 2	Define the interface on which OSPF runs, and associate the area ID with the interface.

(config-router)#network 20.20.40.42/31 area 2	Define the interface on which OSPF runs, and associate the area ID with the interface.
(config-router)#exit	Exit from router ospf mode
(config)# commit	Committing the configuration to apply in running configuration

Validation

CE1

```
CE1#show ip ospf neighbor
```

```
Total number of full neighbors: 2
OSPF process 1 VRF(default):
Neighbor ID      Pri   State           Dead Time   Address      Interface
Instance ID
11.11.11.11     1    Full/Backup     00:00:34   20.20.40.41  xe4
0
4.4.4.4         1    Full/Backup     00:00:36   20.20.40.43  xe24
0
```

```
CE1#show ip route
```

```
Codes: K - kernel, C - connected, S - static, R - RIP, B - BGP
       O - OSPF, IA - OSPF inter area
       N1 - OSPF NSSA external type 1, N2 - OSPF NSSA external type 2
       E1 - OSPF external type 1, E2 - OSPF external type 2
       i - IS-IS, L1 - IS-IS level-1, L2 - IS-IS level-2,
       ia - IS-IS inter area, E - EVPN,
       v - vrf leaked
       * - candidate default
```

```
IP Route Table for VRF "default"
```

```
C          1.1.1.1/32 is directly connected, lo, 00:08:20
O          4.4.4.4/32 [110/8] via 20.20.40.41, xe4, 00:01:48
O E2      11.11.11.11/32 [110/1] via 20.20.40.41, xe4, 00:01:48
O          20.20.40.38/31 [110/7] via 20.20.40.41, xe4, 00:01:48
C          20.20.40.40/31 is directly connected, xe4, 00:08:20
C          20.20.40.42/31 is directly connected, xe24, 00:08:20
O E2      22.22.22.22/32 [110/1] via 20.20.40.41, xe4, 00:02:22
C          127.0.0.0/8 is directly connected, lo, 00:13:50
```

```
Gateway of last resort is not set
```

PE1

```
PE1#show ip ospf neighbor
```

```
Total number of full neighbors: 2
OSPF process 1 VRF(vrf1):
Neighbor ID      Pri   State           Dead Time   Address      Interface
Instance ID
1.1.1.1          1    Full/DR         00:00:32   20.20.40.40  xe4
0
22.22.22.22     1    Full/ -        00:00:35   22.22.22.22  SLINK0
```

```
Total number of full neighbors: 1
OSPF process 100 VRF(default):
```

```
Neighbor ID      Pri   State           Dead Time   Address      Interface
Instance ID
3.3.3.3         1    Full/Backup     00:00:34   20.20.40.49 xe10
0
```

```
PE1#show ip ospf sham-links
Sham Link SLINK0 to destination 22.22.22.22 is up
  area 0.0.0.2 source 11.11.11.11
  Transmit Delay is 1 sec, State Point-To-Point,
  Timer intervals , Hello 10, Dead 40, Wait 40, Retransmit 5
  Hello due in 00:00:07
  No authentication
  Adjacency state Full
```

```
PE1#show ip ospf sham-links brief
```

```
OSPF Process ID 1 VRF vrf1
Total number of slinks: 1
Shamlink Name      DestinationID  SourceID  Area    Status
SLINK0             22.22.22.22   11.11.11.11 0.0.0.2  up
```

```
OSPF Process ID 100 VRF default
Total number of slinks: 0
Shamlink Name      DestinationID  SourceID  Area    Status
```

```
PE1#show ip bgp vpnv4 all summary
BGP router identifier 2.2.2.2, local AS number 100
BGP table version is 2
1 BGP AS-PATH entries
0 BGP community entries
```

Neighbor	Down	State/PfxRcd	V	AS	MsgRcv	MsgSen	TblVer	InQ	OutQ	Up/
3.3.3.3	00:03:49		4	100	16	17	2	0	0	

```
Total number of neighbors 1
```

```
Total number of Established sessions 1
```

```
PE1#show ldp session
Peer IP Address      IF Name      My Role      State      KeepAlive  UpTime
3.3.3.3              xe10         Passive      OPERATIONAL 30         00:03:39
```

```
PE1#show ip route
Codes: K - kernel, C - connected, S - static, R - RIP, B - BGP
       O - OSPF, IA - OSPF inter area
       N1 - OSPF NSSA external type 1, N2 - OSPF NSSA external type 2
       E1 - OSPF external type 1, E2 - OSPF external type 2
       i - IS-IS, L1 - IS-IS level-1, L2 - IS-IS level-2,
       ia - IS-IS inter area, E - EVPN,
       v - vrf leaked
       * - candidate default
```

```
IP Route Table for VRF "default"
C          2.2.2.2/32 is directly connected, lo, 00:05:56
O IA      3.3.3.3/32 [110/2] via 20.20.40.49, xe10, 00:04:24
C          20.20.40.48/31 is directly connected, xe10, 00:05:56
C          127.0.0.0/8 is directly connected, lo, 00:16:19
```

```
Gateway of last resort is not set
```

PE2

PE2#show ip ospf neighbor

Total number of full neighbors: 2

OSPF process 1 VRF(vrf1):

Neighbor ID Instance ID	Pri	State	Dead Time	Address	Interface
4.4.4.4 0	1	Full/DR	00:00:31	20.20.40.39	xe5
11.11.11.11	1	Full/ -	00:00:36	11.11.11.11	SLINK0

Total number of full neighbors: 1

OSPF process 100 VRF(default):

Neighbor ID Instance ID	Pri	State	Dead Time	Address	Interface
2.2.2.2 0	1	Full/DR	00:00:39	20.20.40.48	xe10

PE2#show ip bgp vpnv4 all summary

BGP router identifier 3.3.3.3, local AS number 100

BGP table version is 2

1 BGP AS-PATH entries

0 BGP community entries

Neighbor Down	State/PfxRcd	V	AS	MsgRcv	MsgSen	TblVer	InQ	OutQ	Up/
2.2.2.2 00:06:23		4	100	22	22	2	0	0	

Total number of neighbors 1

Total number of Established sessions 1

PE2#show ip ospf sham-links

Sham Link SLINK0 to destination 11.11.11.11 is up

area 0.0.0.2 source 22.22.22.22

Transmit Delay is 1 sec, State Point-To-Point,

Timer intervals , Hello 10, Dead 40, Wait 40, Retransmit 5

Hello due in 00:00:03

No authentication

Adjacency state Full

PE2#show ip ospf sham-links brief

OSPF Process ID 1 VRF vrf1

Total number of slinks: 1

Shamlink Name	DestinationID	SourceID	Area	Status
SLINK0	11.11.11.11	22.22.22.22	0.0.0.2	up

OSPF Process ID 100 VRF default

Total number of slinks: 0

Shamlink Name	DestinationID	SourceID	Area	Status
---------------	---------------	----------	------	--------

PE2#show ip bgp vpnv4 all summary

BGP router identifier 3.3.3.3, local AS number 100

BGP table version is 2

1 BGP AS-PATH entries

0 BGP community entries

Neighbor Down	State/PfxRcd	V	AS	MsgRcv	MsgSen	TblVer	InQ	OutQ	Up/
------------------	--------------	---	----	--------	--------	--------	-----	------	-----

```
2.2.2.2      4    100    24          24          2          0          0
00:07:08      4
```

Total number of neighbors 1

Total number of Established sessions 1

PE2#show ip route

Codes: K - kernel, C - connected, S - static, R - RIP, B - BGP
 O - OSPF, IA - OSPF inter area
 N1 - OSPF NSSA external type 1, N2 - OSPF NSSA external type 2
 E1 - OSPF external type 1, E2 - OSPF external type 2
 i - IS-IS, L1 - IS-IS level-1, L2 - IS-IS level-2,
 ia - IS-IS inter area, E - EVPN,
 v - vrf leaked
 * - candidate default

IP Route Table for VRF "default"

```
O IA      2.2.2.2/32 [110/2] via 20.20.40.48, xe10, 00:07:32
C         3.3.3.3/32 is directly connected, lo, 00:07:52
C         20.20.40.48/31 is directly connected, xe10, 00:07:52
C         127.0.0.0/8 is directly connected, lo, 00:18:22
```

Gateway of last resort is not set

CE2

CE2#show ip ospf neighbor

Total number of full neighbors: 2

OSPF process 1 VRF(default):

Neighbor ID	Pri	State	Dead Time	Address	Interface
Instance ID					
22.22.22.22	1	Full/Backup	00:00:38	20.20.40.38	xe5
0					
1.1.1.1	1	Full/DR	00:00:35	20.20.40.42	xe7
0					

CE2#show ip route

Codes: K - kernel, C - connected, S - static, R - RIP, B - BGP
 O - OSPF, IA - OSPF inter area
 N1 - OSPF NSSA external type 1, N2 - OSPF NSSA external type 2
 E1 - OSPF external type 1, E2 - OSPF external type 2
 i - IS-IS, L1 - IS-IS level-1, L2 - IS-IS level-2,
 ia - IS-IS inter area, E - EVPN,
 v - vrf leaked
 * - candidate default

IP Route Table for VRF "default"

```
O         1.1.1.1/32 [110/8] via 20.20.40.38, xe5, 00:09:00
C         4.4.4.4/32 is directly connected, lo, 00:13:45
O E2      11.11.11.11/32 [110/1] via 20.20.40.38, xe5, 00:09:34
C         20.20.40.38/31 is directly connected, xe5, 00:13:45
O         20.20.40.40/31 [110/7] via 20.20.40.38, xe5, 00:09:00
C         20.20.40.42/31 is directly connected, xe7, 00:13:45
O E2      22.22.22.22/32 [110/1] via 20.20.40.38, xe5, 00:09:00
C         127.0.0.0/8 is directly connected, lo, 00:20:15
```

Gateway of last resort is not set

CHAPTER 10 OSPF TE-Metric Extension

This chapter contains basic OSPF TE-Metric Extension configuration examples.

A TE link represents an IS-IS/OSPF link state advertisement and a link state database of certain physical resources and their properties between two nodes. Typically, a TE link is advertised as an adjunct to a "regular" OSPF or IS-IS link. That is, an adjacency is brought up on the link. When the link is up, both the regular IGP properties of the link (for example, the SPF metric) and the TE properties of the link are then advertised.

Note: Bandwidth-measurement values should be less than maximum link bandwidth configuration.

Topology



Figure 10-83: Basic OSPF Topology

Configuration

R1

#configure terminal	Enter configure mode.
(config)# router ospf 100	Configure the routing process, and specify the Process ID (100). The Process ID should be a unique positive integer identifying the routing process.
(config-router)#network 10.10.10.0/24 area 0	Define the interface (10.10.10.0/24) on which OSPF runs, and associate the area ID (0) with the interface (area ID 0 specifies the backbone area).
(config-router)#network 30.30.30.0/24 area 0	Define the interface (30.30.30.0/24) on which OSPF runs, and associate the area ID (0) with the interface (area ID 0 specifies the backbone area).
(config-router)#commit	Commit the configurations
(config-router)#exit	Exit mode
(config)#interface eth1	Interface mode
(config-if)# delay-measurement uni-link-delay static 1	Configure the delay-measurement uni-link-delay
(config-if)# delay-measurement uni-link-delay a-bit-threshold min 2 max 4	Configure the delay-measurement unilink delay a bit threshold
(config-if)# bandwidth-measurement uni-available-bandwidth static 200k	Configure the bandwidth-measurement unilink available bandwidth
(config-if)#commit	Commit the configurations
(config-if)#exit	Exit mode

R2

#configure terminal	Enter configure mode.
(config)# router ospf 100	Configure the routing process, and specify the Process ID (100). The Process ID should be a unique positive integer identifying the routing process.
(config-router)#network 10.10.10.0/24 area 0	Define the interface (10.10.10.0/24) on which OSPF runs, and associate the area ID (0) with the interface (area ID 0 specifies the backbone area).
(config-router)#network 20.20.20.0/24 area 0	Define the interface (20.20.20.0/24) on which OSPF runs, and associate the area ID (0) with the interface (area ID 0 specifies the backbone area).
(config-router)#commit	Commit the configurations
(config-router)#exit	Exit mode
(config-if)# delay-measurement uni-link-delay static 1	Configure the delay-measurement uni-link-delay
(config-if)# delay-measurement uni-link-delay a-bit-threshold min 2 max 4	Configure the delay-measurement unilink delay a bit threshold
(config-if)# bandwidth-measurement uni-available-bandwidth static 200k	Configure the bandwidth-measurement unilink available bandwidth
(config-if)#commit	Commit the configurations

Validation

R1#show ip ospf database opaque-area

OSPF Router with ID (20.20.20.1) (Process ID 100 VRF default)

Area-Local Opaque-LSA (Area 0.0.0.0)

LS age: 1591
 Options: 0x22 (-|-|DC|-|-|-|E|-)
 LS Type: Area-Local Opaque-LSA
 Link State ID: 1.0.0.1 (Area-Local Opaque-Type/ID)
 Opaque Type: 1
 Opaque ID: 1
 Advertising Router: 20.20.20.1
 LS Seq Number: 80000004
 Checksum: 0x2a87
 Length: 28

MPLS TE router ID : 20.20.20.1

Number of Links : 0

LS age: 1678
 Options: 0x22 (-|-|DC|-|-|-|E|-)
 LS Type: Area-Local Opaque-LSA
 Link State ID: 1.0.0.1 (Area-Local Opaque-Type/ID)
 Opaque Type: 1

Opaque ID: 1
Advertising Router: 30.30.30.1
LS Seq Number: 80000004
Checksum: 0x2a4b
Length: 28

MPLS TE router ID : 30.30.30.1

Number of Links : 0

LS age: 121
Options: 0x22 (-|-|DC|-|-|-|E|-)
LS Type: Area-Local Opaque-LSA
Link State ID: 1.0.0.30 (Area-Local Opaque-Type/ID)
Opaque Type: 1
Opaque ID: 30
Advertising Router: 20.20.20.1
LS Seq Number: 80000006
Checksum: 0xeabc
Length: 116

Link connected to Broadcast network

Link ID : 10.10.10.2
Interface Address : 10.10.10.1
Admin Metric : 1
Maximum bandwidth : 10000000.00 Kbits/s
Maximum reservable bandwidth : 10000000.00 Kbits/s
Unreserved Bandwidth :
Number of Priority : 8
Priority 0 : 10000000.00 Kbits/s Priority 1 : 10000000.00 Kbits/s
Priority 2 : 10000000.00 Kbits/s Priority 3 : 10000000.00 Kbits/s
Priority 4 : 10000000.00 Kbits/s Priority 5 : 10000000.00 Kbits/s
Priority 6 : 10000000.00 Kbits/s Priority 7 : 10000000.00 Kbits/s
Link Delay : 1 us, Anomalous : 0

Number of Links : 1

LS age: 36
Options: 0x22 (-|-|DC|-|-|-|E|-)
LS Type: Area-Local Opaque-LSA
Link State ID: 1.0.0.32 (Area-Local Opaque-Type/ID)
Opaque Type: 1
Opaque ID: 32
Advertising Router: 30.30.30.1
LS Seq Number: 80000005
Checksum: 0x0681
Length: 116

Link connected to Broadcast network

Link ID : 10.10.10.2

OSPF TE-Metric Extension

```
Interface Address : 10.10.10.2
Admin Metric : 1
Maximum bandwidth : 10000000.00 Kbits/s
Maximum reservable bandwidth : 10000000.00 Kbits/s
Unreserved Bandwidth :
Number of Priority : 8
Priority 0 : 10000000.00 Kbits/s      Priority 1 : 10000000.00 Kbits/s
Priority 2 : 10000000.00 Kbits/s      Priority 3 : 10000000.00 Kbits/s
Priority 4 : 10000000.00 Kbits/s      Priority 5 : 10000000.00 Kbits/s
Priority 6 : 10000000.00 Kbits/s      Priority 7 : 10000000.00 Kbits/s
Link Delay : 1 us, Anomalous : 0
```

Number of Links : 1

```
R2      IP-Extended 21.21.21.0/24
R2# R2#sh ip ospf database
```

OSPF Router with ID (30.30.30.1) (Process ID 100 VRF default)

Router Link States (Area 0.0.0.0)

Link ID	ADV Router	Age	Seq#	CkSum	Link count
20.20.20.1	20.20.20.1	1773	0x80000005	0xdd4a	2
30.30.30.1	30.30.30.1	1773	0x80000006	0xe9e1	2

Net Link States (Area 0.0.0.0)

Link ID	ADV Router	Age	Seq#	CkSum
10.10.10.2	30.30.30.1	133	0x80000002	0x0520

Area-Local Opaque-LSA (Area 0.0.0.0)

Link ID	ADV Router	Age	Seq#	CkSum	Opaque ID
1.0.0.1	20.20.20.1	138	0x80000002	0x2e85	1
1.0.0.1	30.30.30.1	173	0x80000002	0x2e49	1
1.0.0.30	20.20.20.1	362	0x80000002	0x5555	30
1.0.0.32	30.30.30.1	223	0x80000002	0x3288	32

R2#

```
R1#sh ip ospf database opaque-area
```

OSPF Router with ID (20.20.20.1) (Process ID 100 VRF default)

Area-Local Opaque-LSA (Area 0.0.0.0)

```
LS age: 341
Options: 0x22 (-|-|DC|-|-|-|E|-)
LS Type: Area-Local Opaque-LSA
Link State ID: 1.0.0.1 (Area-Local Opaque-Type/ID)
Opaque Type: 1
Opaque ID: 1
Advertising Router: 20.20.20.1
```

LS Seq Number: 80000006
Checksum: 0x2689
Length: 28

MPLS TE router ID : 20.20.20.1

Number of Links : 0

LS age: 379
Options: 0x22 (-|-|DC|-|-|-|E|-)
LS Type: Area-Local Opaque-LSA
Link State ID: 1.0.0.1 (Area-Local Opaque-Type/ID)
Opaque Type: 1
Opaque ID: 1
Advertising Router: 30.30.30.1
LS Seq Number: 80000006
Checksum: 0x264d
Length: 28

MPLS TE router ID : 30.30.30.1

Number of Links : 0

LS age: 8
Options: 0x22 (-|-|DC|-|-|-|E|-)
LS Type: Area-Local Opaque-LSA
Link State ID: 1.0.0.30 (Area-Local Opaque-Type/ID)
Opaque Type: 1
Opaque ID: 30
Advertising Router: 20.20.20.1
LS Seq Number: 8000000a
Checksum: 0x1c03
Length: 116

Link connected to Broadcast network

Link ID : 10.10.10.2
Interface Address : 10.10.10.1
Admin Metric : 1
Maximum bandwidth : 10000000.00 Kbits/s
Maximum reservable bandwidth : 10000000.00 Kbits/s
Unreserved Bandwidth :
Number of Priority : 8
Priority 0 : 10000000.00 Kbits/s Priority 1 : 10000000.00 Kbits/s
Priority 2 : 10000000.00 Kbits/s Priority 3 : 10000000.00 Kbits/s
Priority 4 : 10000000.00 Kbits/s Priority 5 : 10000000.00 Kbits/s
Priority 6 : 10000000.00 Kbits/s Priority 7 : 10000000.00 Kbits/s
Link Delay : 5 us, Anomalous : 1

Number of Links : 1

LS age: 33
Options: 0x22 (-|-|DC|-|-|-|E|-)
LS Type: Area-Local Opaque-LSA
Link State ID: 1.0.0.32 (Area-Local Opaque-Type/ID)
Opaque Type: 1
Opaque ID: 32
Advertising Router: 30.30.30.1
LS Seq Number: 80000009
Checksum: 0x37c7
Length: 116

Link connected to Broadcast network

Link ID : 10.10.10.2
Interface Address : 10.10.10.2
Admin Metric : 1
Maximum bandwidth : 10000000.00 Kbits/s
Maximum reservable bandwidth : 10000000.00 Kbits/s
Unreserved Bandwidth :
Number of Priority : 8
Priority 0 : 10000000.00 Kbits/s Priority 1 : 10000000.00 Kbits/s
Priority 2 : 10000000.00 Kbits/s Priority 3 : 10000000.00 Kbits/s
Priority 4 : 10000000.00 Kbits/s Priority 5 : 10000000.00 Kbits/s
Priority 6 : 10000000.00 Kbits/s Priority 7 : 10000000.00 Kbits/s
Link Delay : 5 us, Anomalous : 1

Number of Links : 1

R1#sh ip ospf database opaque-area

OSPF Router with ID (20.20.20.1) (Process ID 100 VRF default)

Area-Local Opaque-LSA (Area 0.0.0.0)

LS age: 341
Options: 0x22 (-|-|DC|-|-|-|E|-)
LS Type: Area-Local Opaque-LSA
Link State ID: 1.0.0.1 (Area-Local Opaque-Type/ID)
Opaque Type: 1
Opaque ID: 1
Advertising Router: 20.20.20.1
LS Seq Number: 80000006
Checksum: 0x2689
Length: 28

MPLS TE router ID : 20.20.20.1

Number of Links : 0

LS age: 379
Options: 0x22 (-|-|DC|-|-|-|E|-)
LS Type: Area-Local Opaque-LSA

Link State ID: 1.0.0.1 (Area-Local Opaque-Type/ID)
Opaque Type: 1
Opaque ID: 1
Advertising Router: 30.30.30.1
LS Seq Number: 80000006
Checksum: 0x264d
Length: 28

MPLS TE router ID : 30.30.30.1

Number of Links : 0

LS age: 8
Options: 0x22 (-|-|DC|-|-|-|E|-)
LS Type: Area-Local Opaque-LSA
Link State ID: 1.0.0.30 (Area-Local Opaque-Type/ID)
Opaque Type: 1
Opaque ID: 30
Advertising Router: 20.20.20.1
LS Seq Number: 8000000a
Checksum: 0x1c03
Length: 116

Link connected to Broadcast network

Link ID : 10.10.10.2
Interface Address : 10.10.10.1
Admin Metric : 1
Maximum bandwidth : 10000000.00 Kbits/s
Maximum reservable bandwidth : 10000000.00 Kbits/s
Unreserved Bandwidth :
Number of Priority : 8
Priority 0 : 10000000.00 Kbits/s Priority 1 : 10000000.00 Kbits/s
Priority 2 : 10000000.00 Kbits/s Priority 3 : 10000000.00 Kbits/s
Priority 4 : 10000000.00 Kbits/s Priority 5 : 10000000.00 Kbits/s
Priority 6 : 10000000.00 Kbits/s Priority 7 : 10000000.00 Kbits/s
Link Delay : 5 us, Anomalous : 1

Number of Links : 1

LS age: 33
Options: 0x22 (-|-|DC|-|-|-|E|-)
LS Type: Area-Local Opaque-LSA
Link State ID: 1.0.0.32 (Area-Local Opaque-Type/ID)
Opaque Type: 1
Opaque ID: 32
Advertising Router: 30.30.30.1
LS Seq Number: 80000009
Checksum: 0x37c7
Length: 116

Link connected to Broadcast network

Link ID : 10.10.10.2

Interface Address : 10.10.10.2

Admin Metric : 1

Maximum bandwidth : 10000000.00 Kbits/s

Maximum reservable bandwidth : 10000000.00 Kbits/s

Unreserved Bandwidth :

Number of Priority : 8

Priority 0 : 10000000.00 Kbits/s

Priority 1 : 10000000.00 Kbits/s

Priority 2 : 10000000.00 Kbits/s

Priority 3 : 10000000.00 Kbits/s

Priority 4 : 10000000.00 Kbits/s

Priority 5 : 10000000.00 Kbits/s

Priority 6 : 10000000.00 Kbits/s

Priority 7 : 10000000.00 Kbits/s

Link Delay : 5 us, Anomalous : 1

Number of Links : 1

CHAPTER 11 OSPFv2 LDP Remote Loop-Free Alternate (RLFA)

A basic mechanism using Loop-Free Alternates (LFAs) is described in RFC5286 that provides good repair coverage in many topologies, especially those that are highly meshed.

However, some topologies, notably ring-based topologies, are not well protected by LFAs alone. This is because there is no neighbor of the Point of Local Repair (PLR) that has a cost to the destination via a path that does not traverse the failure that is cheaper than the cost to the destination via the failure.

RFC 7490 provides extensions to the basic repair mechanism in which tunnels are used to provide additional logical links that can be used as loop-free alternates where none exist in the original topology. It provides loop-free alternates that guarantee only link protection.

RFC 8102 provides remote-loop-free-based IP fast reroute mechanisms that specifies procedures for determining whether or not a given PQ-node provides node protection for a specific destination. It provides node protection for all destinations covered by the same remote-LFA alternate, in case of failure of the primary next-hop node

Ospf shall compute PQ node and LDP shall dynamically create tunnel to PQ node so that if primary path fails traffic can be rerouted to backup rLFA tunnel and hence to destination.

Remote LFA involves the use of a tunnel to a next-hop that is not directly connected. This is the primary difference between the LFA and Remote LFA.

RLFA Terminology

Note: Terms used for defining tunnel as below:

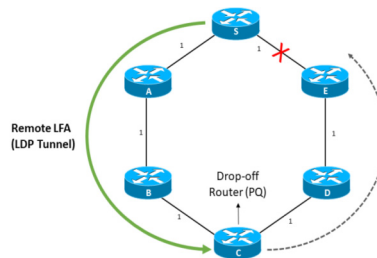

Figure 11-84: Figure 36-14: Understanding RLFA

Repair tunnel

A tunnel established for the purpose of providing a virtual neighbor that is a Loop-Free Alternate.

P-space

The P-space of a router with respect to a protected link is the set of routers reachable from that specific router using the pre-convergence shortest paths, without any of those paths (including equal cost path splits) transiting that protected link.

For example, the P-space of S with respect to link S-E is the set of routers that S can reach without using the protected link S-E.

Extended P-space

Consider the set of neighbors of a router protecting a link. Exclude the router reachable over the protected link from that set of routers. The extended P-space of the protecting router with respect to the protected link is the union of the P spaces of the neighbors in that set of neighbors with respect to the protected link.

Q-space

Q-space of a router with respect to a protected link is the set of routers from which that specific router that can be reached without any path (including ECMP Splits) transiting that protected link.

PQ node

A PQ node of a node S with respect to a protected link S-E is a node that is a member of both the P-space (or the extended P-space) of S with respect to that protected link S-E and the Q-space of E with respect to that protected link S-E. A repair tunnel endpoint is chosen from the set of PQ-nodes.

Remote LFA (RLFA)

The use of a PQ node rather than a neighbor of the repairing node as the next hop in an LFA repair.

In [Figure 11-84](#), S can reach A, B, and C without going via S-E; these form S's extended P-space with respect to S-E. The routers that can reach E without going through S-E will be in E's Q-space with respect to link S-E; these are D and C. B has equal-cost paths to E via B-A-S-E and B-C-D-E, and so the forwarder at S might choose to send a packet to E via link S-E. Hence, B is not in the Q-space of E with respect to link S-E. The single node in both S's extended P-space and E's Q-space is C; thus, node C is selected as the repair tunnel's endpoint. thus, node C is selected as the repair tunnel's endpoint.

Establishing RLFA Tunnel

To calculate the Remote LFA backup path and to determine the Remote LFA node the software requirement can be broadly classified as below:

OSPF

OSPF shall calculate Repair path that are P space (routers it can reach without traversing the protected link) and Q space (routers that can reach the protected destination without traversing the protected link). Hence routers that belong to both spaces called as PQ routers has to be calculated. It has to inform LDP about PQ node so that RLFA tunnel can be established.

LDP

LDP shall establish targeted session with PQ node and shall advertise label to peer node for the destination FEC. LDP shall send primary and backup path FTN/ILM add/delete info to NSM for further programming.

NSM

NSM shall maintain Primary and Backup path FTN/ILM and shall send information to HSL for data-plane programming.

HSL

HSL program primary and backup FTN/ILM entry in hardware.

Configure LDP Remote Loop-Free Alternate (RLFA)

The LDP RLFA configuration process can be divided into the following tasks:

1. Enable label-switching on the interface on NSM.
2. Establish ospf routing between the nodes (to distribute reachability information within the MPLS cloud)
3. Configure ospf RLFA on Source node
4. Enabling LDP on an interface in the LDP daemon
5. Configure LDP FRR with Auto-targeted-session (Allow creating TLDP session dynamically)
6. Enable BFD interval globally and for all ISIS enabled interfaces

Note: Faster convergence can be achieved with lower BFD interval enabled globally.

Note: Dynamically created RLFA T-LDP sessions will be removed only after disabling LDP auto-targeted-session CLI or LDP FRR.

Note: When targeted-peer ipv4 CLI is configured with auto-targeted-session CLI, T-LDP session created for targeted-peer only remove after disabling auto-targeted-session CLI.

Note: After Enabling Ospf RLFA, Both LFA and RLFA computation will be done and RLFA path will be preferred to provide node-protection.

Note: Better convergence can be achieved with LDP-IGP-SYNC enabled.

Assumptions and Limitations

- RLFA Backup path computation will be supported only via IGP as IS-IS/Ospf.
- Only LDP(MPLS) will be used as a tunnel mechanism to reach a Remote-LFA repair node.
- Only IPv4 protocol is supported.
- RFC 7916 [LFA-MANAGE] is not supported.
- ECMP will not be supported for RLFA next-hop.

Topology

Figure 11-85 shows the configuration required to enable the RLFA feature.

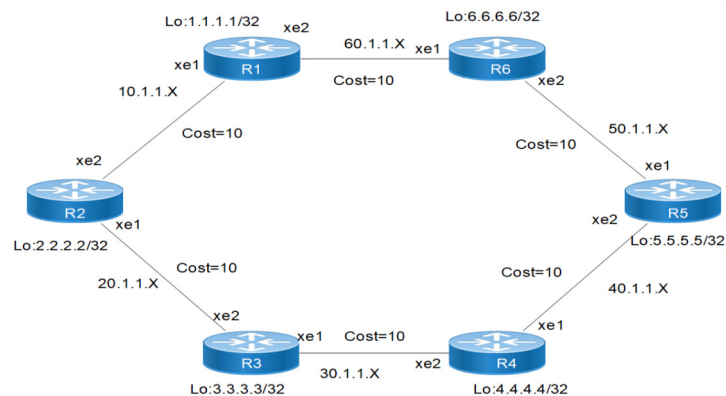

Figure 11-85: RLFA Topology

R1

#configure terminal	Enter configure mode
(config)#router ldp	Enable LDP process
(config-router)#fast-reroute	Enable LDP FRR
(config-router)#auto-targeted-session	To Allow creating TLDP session dynamically
(config-router)#commit	Commit the candidate configuration to the running configuration
(config-router)#exit	Exit LDP process
(config)#router rsvp	Enable RSPVP
(config-router)#srlg-disjoint forced	Configure SRLG to enable MPLS-TE
(config-router)#commit	Commit the candidate configuration to the running configuration
(config)#interface xe1	Enter interface mode.
(config-if)#ip address 10.1.1.1/24	Configure the IP address of the interface.
(config-if)#ip ospf cost 10	Configure the OSPF cost
(config-if)#label-switching	Enable label-switching on interface
(config-if)#enable-ldp ipv4	Enable LDP process on xe1 interface
(config-if)#mpls traffic-eng srlg 11	Enable MPLS-TE
(config-if)#commit	Commit the candidate configuration to the running configuration
(config-if)#exit	Exit interface mode.
(config)#interface xe2	Enter interface mode.
(config-if)#ip address 60.1.1.1/24	Configure the IP address of the interface.
(config-if)#ip ospf cost 10	Configure OSPF cost
(config-if)#label-switching	Enable label-switching on interface
(config-if)#mpls traffic-eng srlg 11	Enable MPLS-TE
(config-if)#enable-ldp ipv4	Enable LDP process on xe2 interface
(config-if)#commit	Commit the candidate configuration to the running configuration
(config-if)#exit	Exit interface mode.
(config)#interface lo	Enter interface mode.
(config-if)#ip address 1.1.1.1/32 secondary	Configure the IP address of the interface
(config-if)#exit	Exit interface mode.
(config)#router ospf 1	Create an OSPF instance
(config-router)# ospf router-id 1.1.1.1	Configure router ID
(config-router)# bfd all-interfaces	Configure BFD
(config-router)# timers spf exp 50 50	Configure the OSPF timers
(config-router)# timers throttle lsa all 0 1 1	Configure the OSPF timer LSA throttle
(config-router)# timers lsa arrival 1	Configure the OSPF timer LSA arrival

(config-router)# fast-reroute per-prefix remote-lfa area 0.0.0.0 tunnel mpls-ldp	Configure Remote LFA to calculate backup paths to those destinations whichever does not satisfy basic LFA FRR inequalities
(config-router)# network 1.1.1.1/32 area 0.0.0.0	Configure the network command to advertise the prefixes
(config-router)# network 10.1.1.0/24 area 0.0.0.0	Configure the network command to advertise the prefixes
(config-router)# network 60.1.1.0/24 area 0.0.0.0	Configure the network command to advertise the prefixes
(config-router)#commit	Commit the candidate configuration to the running configuration
(config-router)#end	Exit router mode.
(config)# bfd interval 3 minrx 3 multiplier 3	Configure BFD interval globally

R2

#configure terminal	Enter configure mode
(config)#router ldp	Enable LDP process
(config-router)#fast-reroute	Enable LDP FRR
(config-router)#auto-targeted-session	To Allow creating TLDP session dynamically
(config-router)#commit	Commit the candidate configuration to the running configuration
(config-router)#exit	Exit LDP process
(config)#router rsvp	Enable RSPVP
(config-router)#srlg-disjoint forced	Configure SRLG to enable mpls-TE
(config-router)#commit	Commit the candidate configuration to the running configuration
(config)#interface xe2	Enter interface mode.
(config-if)#ip address 10.1.1.2/24	Configure the IP address of the interface.
(config-if)#ip ospf cost 10	Configure the OSPF cost
(config-if)#label-switching	Enable label-switching on interface
(config-if)#enable-ldp ipv4	Enable LDP process on xe1 interface
(config-if)#mpls traffic-eng srlg 11	Enable MPLS-TE
(config-if)#commit	Commit the candidate configuration to the running configuration
(config-if)#exit	Exit interface mode.
(config)#interface xe1	Enter interface mode.
(config-if)#ip address 20.1.1.1/24	Configure the IP address of the interface.
(config-if)#ip ospf cost 10	Configure OSPF cost
(config-if)#label-switching	Enable label-switching on interface
(config-if)#mpls traffic-eng srlg 11	Enable MPLS-TE
(config-if)#enable-ldp ipv4	Enable LDP process on xe2 interface
(config-if)#commit	Commit the candidate configuration to the running configuration

OSPFv2 LDP Remote Loop-Free Alternate (RLFA)

(config-if)#exit	Exit interface mode.
(config)#interface lo	Enter interface mode.
(config-if)#ip address 2.2.2.2/32 secondary	Configure the IP address of the interface
(config-if)#exit	Exit interface mode.
(config)#router ospf 1	Create an OSPF instance
(config-router)# ospf router-id 2.2.2.2	Configure router ID
(config-router)# bfd all-interfaces	Configure BFD
(config-router)# timers spf exp 50 50	Configure the OSPF timers
(config-router)# timers throttle lsa all 0 1 1	Configure the OSPF timer LSA throttle
(config-router)# timers lsa arrival 1	Configure the OSPF timer LSA arrival
(config-router)# network 2.2.2.2/32 area 0.0.0.0	Configure the network command to advertise the prefixes
(config-router)# network 10.1.1.0/24 area 0.0.0.0	Configure the network command to advertise the prefixes
(config-router)# network 20.1.1.0/24 area 0.0.0.0	Configure the network command to advertise the prefixes
(config-router)#commit	Commit the candidate configuration to the running configuration
(config)# bfd interval 3 minrx 3 multiplier 3 Configure bfd interval globally	Configure BFD interval globally
(config)#commit	Commit the candidate configuration to the running configuration
(config)#end	Exit configure mode.

R3

#configure terminal	Enter configure mode
(config)#router ldp	Enable LDP process
(config-router)#fast-reroute	Enable LDP FRR
(config-router)#auto-targeted-session	To Allow creating TLDP session dynamically
(config-router)#commit	Commit the candidate configuration to the running configuration
(config-router)#exit	Exit LDP process
(config)#router rsvp	Enable RSPVP
(config-router)#srlg-disjoint forced	Configure SRLG to enable mpls-TE
(config-router)#commit	Commit the candidate configuration to the running configuration
(config)#interface xe2	Enter interface mode.
(config-if)#ip address 20.1.1.2/24	Configure the IP address of the interface.
(config-if)#ip ospf cost 10	Configure the OSPF cost
(config-if)#label-switching	Enable label-switching on interface
(config-if)#enable-ldp ipv4	Enable LDP process on xe1 interface
(config-if)#mpls traffic-eng srlg 11	Enable MPLS-TE

(config-if)#commit	Commit the candidate configuration to the running configuration
(config-if)#exit	Exit interface mode.
(config)#interface xe1	Enter interface mode.
(config-if)#ip address 30.1.1.1/24	Configure the IP address of the interface.
(config-if)#ip ospf cost 10	Configure OSPF cost
(config-if)#label-switching	Enable label-switching on interface
(config-if)#mpls traffic-eng srlg 11	Enable MPLS-TE
(config-if)#enable-ldp ipv4	Enable ldp process on xe2 interface
(config-if)#commit	Commit the candidate configuration to the running configuration
(config-if)#exit	Exit interface mode.
(config)#interface lo	Enter interface mode.
(config-if)#ip address 3.3.3.3/32 secondary	Configure the IP address of the interface
(config-if)#exitv	Exit interface mode.
(config)#router ospf 1	Create an OSPF instance
(config-router)# ospf router-id 3.3.3.3	Configure router id
(config-router)# bfd all-interfaces	Configure BFD
(config-router)# timers spf exp 50 50	Configure the OSPF timers
(config-router)# timers throttle lsa all 0 1 1	Configure the OSPF timer LSA throttle
(config-router)# timers lsa arrival 1	Configure the OSPF timer LSA arrival
(config-router)# network 3.3.3.3/32 area 0.0.0.0	Configure the network command to advertise the prefixes
(config-router)# network 20.1.1.0/24 area 0.0.0.0	Configure the network command to advertise the prefixes
(config-router)# network 30.1.1.0/24 area 0.0.0.0	Configure the network command to advertise the prefixes
(config-router)#commit	Commit the candidate configuration to the running configuration
(config)# bfd interval 3 minrx 3 multiplier 3 Configure bfd interval globally	Configure BFD interval globally
(config)#commit	Commit the candidate configuration to the running configuration
(config)#end	Exit configure mode.

R4

#configure terminal	Enter configure mode
(config)#router ldp	Enable LDP process
(config-router)#fast-reroute	Enable LDP FRR
(config-router)#auto-targeted-session	To Allow creating TLDP session dynamically
(config-router)#commit	Commit the candidate configuration to the running configuration
(config-router)#exit	Exit LDP process
(config)#router rsvp	Enable RSPVP

OSPFv2 LDP Remote Loop-Free Alternate (RLFA)

(config-router)#srlg-disjoint forced	Configure SRLG to enable MPLS-TE
(config-router)#commit	Commit the candidate configuration to the running configuration
(config)#interface xe2	Enter interface mode.
(config-if)#ip address 30.1.1.2/24	Configure the IP address of the interface.
(config-if)#ip ospf cost 10	Configure the OSPF cost
(config-if)#label-switching	Enable label-switching on interface
(config-if)#enable-ldp ipv4	Enable LDP process on xe1 interface
(config-if)#mpls traffic-eng srlg 11	Enable MPLS-TE
(config-if)#commit	Commit the candidate configuration to the running configuration
(config-if)#exit	Exit interface mode.
(config)#interface xe1	Enter interface mode.
(config-if)#ip address 40.1.1.1/24	Configure the IP address of the interface.
(config-if)#ip ospf cost 10	Configure OSPF cost
(config-if)#label-switching	Enable label-switching on interface
(config-if)#mpls traffic-eng srlg 11	Enable MPLS-TE
(config-if)#enable-ldp ipv4	Enable LDP process on xe2 interface
(config-if)#commit	Commit the candidate configuration to the running configuration
(config-if)#exit	Exit interface mode.
(config)#interface lo	Enter interface mode.
(config-if)#ip address 4.4.4.4/32 secondary	Configure the IP address of the interface
(config-if)#exit	Exit interface mode.
(config)#router ospf 1	Create an OSPF instance
(config-router)# ospf router-id 4.4.4.4	Configure router ID
(config-router)# bfd all-interfaces	Configure BFD
(config-router)# timers spf exp 50 50	Configure the OSPF timers
(config-router)# timers throttle lsa all 0 1 1	Configure the OSPF timer LSA throttle
(config-router)# timers lsa arrival 1	Configure the OSPF timer LSA arrival
(config-router)# network 4.4.4.4/32 area 0.0.0.0	Configure the network command to advertise the prefixes
(config-router)# network 40.1.1.0/24 area 0.0.0.0	Configure the network command to advertise the prefixes
(config-router)# network 30.1.1.0/24 area 0.0.0.0	Configure the network command to advertise the prefixes
(config-router)#commit	Commit the candidate configuration to the running configuration
(config)# bfd interval 3 minrx 3 multiplier 3 Configure bfd interval globally	Configure BFD interval globally
(config)#commit	Commit the candidate configuration to the running configuration
(config)#end	Exit configure mode.

R5

#configure terminal	Enter configure mode
(config)#router ldp	Enable LDP process
(config-router)#fast-reroute	Enable LDP FRR
(config-router)#auto-targeted-session	To Allow creating TLDP session dynamically
(config-router)#commit	Commit the candidate configuration to the running configuration
(config-router)#exit	Exit LDP process
(config)#router rsvp	Enable RSPVP
(config-router)#srlg-disjoint forced	Configure SRLG to enable mpls-TE
(config-router)#commit	Commit the candidate configuration to the running configuration
(config)#interface xe2	Enter interface mode.
(config-if)#ip address 40.1.1.2/24	Configure the IP address of the interface.
(config-if)#ip ospf cost 10	Configure the OSPF cost
(config-if)#label-switching	Enable label-switching on interface
(config-if)#enable-ldp ipv4	Enable LDP process on xe1 interface
(config-if)#mpls traffic-eng srlg 11	Enable MPLS-TE
(config-if)#commit	Commit the candidate configuration to the running configuration
(config-if)#exit	Exit interface mode.
(config)#interface xe1	Enter interface mode.
(config-if)#ip address 50.1.1.1/24	Configure the IP address of the interface.
(config-if)#ip ospf cost 10	Configure OSPF cost
(config-if)#label-switching	Enable label-switching on interface
(config-if)#mpls traffic-eng srlg 11	Enable MPLS-TE
(config-if)#enable-ldp ipv4	Enable LDP process on xe2 interface
(config-if)#commit	Commit the candidate configuration to the running configuration
(config-if)#exit	Exit interface mode.
(config)#interface lo	Enter interface mode.
(config-if)#ip address 5.5.5.5/32 secondary	Configure the IP address of the interface
(config-if)#exit	Exit interface mode.
(config)#router ospf 1	Create an OSPF instance
(config-router)# ospf router-id 5.5.5.5	Configure router ID
(config-router)# bfd all-interfaces	Configure BFD
(config-router)# timers spf exp 50 50	Configure the OSPF timers
(config-router)# timers throttle lsa all 0 1 1	Configure the OSPF timer LSA throttle
(config-router)# timers lsa arrival 1	Configure the OSPF timer LSA arrival
(config-router)# network 5.5.5.5/32 area 0.0.0.0	Configure the network command to advertise the prefixes

OSPFv2 LDP Remote Loop-Free Alternate (RLFA)

(config-router)# network 50.1.1.0/24 area 0.0.0.0	Configure the network command to advertise the prefixes
(config-router)# network 40.1.1.0/24 area 0.0.0.0	Configure the network command to advertise the prefixes
(config-router)#commit	Commit the candidate configuration to the running configuration
(config)# bfd interval 3 minrx 3 multiplier 3 Configure bfd interval globally	Configure BFD interval globally
(config)#commit	Commit the candidate configuration to the running configuration
(config)#end	Exit configure mode.

R6

#configure terminal	Enter configure mode
(config)#router ldp	Enable LDP process
(config-router)#fast-reroute	Enable LDP FRR
(config-router)#auto-targeted-session	To Allow creating TLDP session dynamically
(config-router)#commit	Commit the candidate configuration to the running configuration
(config-router)#exit	Exit LDP process
(config)#router rsvp	Enable RSPVP
(config-router)#srlg-disjoint forced	Configure SRLG to enable mpls-TE
(config-router)#commit	Commit the candidate configuration to the running configuration
(config)#interface xe2	Enter interface mode.
(config-if)#ip address 50.1.1.2/24	Configure the IP address of the interface.
(config-if)#ip ospf cost 10	Configure the OSPF cost
(config-if)#label-switching	Enable label-switching on interface
(config-if)#enable-ldp ipv4	Enable LDP process on xe1 interface
(config-if)#mpls traffic-eng srlg 11	Enable MPLS-TE
(config-if)#commit	Commit the candidate configuration to the running configuration
(config-if)#exit	Exit interface mode.
(config)#interface xe1	Enter interface mode.
(config-if)#ip address 60.1.1.2/24	Configure the IP address of the interface.
(config-if)#ip ospf cost 10	Configure OSPF cost
(config-if)#label-switching	Enable label-switching on interface
(config-if)#mpls traffic-eng srlg 11	Enable MPLS-TE
(config-if)#enable-ldp ipv4	Enable LDP process on xe2 interface
(config-if)#commit	Commit the candidate configuration to the running configuration
(config-if)#exit	Exit interface mode.
(config)#interface lo	Enter interface mode.
(config-if)#ip address 6.6.6.6/32 secondary	Configure the IP address of the interface

(config-if)#exit	Exit interface mode.
(config)#router ospf 1	Create an OSPF instance
(config-router)# ospf router-id 6.6.6.6	Configure router id
(config-router)# bfd all-interfaces	Configure BFD
(config-router)# timers spf exp 50 50	Configure the OSPF timers
(config-router)# timers throttle lsa all 0 1 1	Configure the OSPF timer LSA throttle
(config-router)# timers lsa arrival 1	Configure the OSPF timer LSA arrival
(config-router)# network 6.6.6.6/32 area 0.0.0.0	Configure the network command to advertise the prefixes
(config-router)# network 50.1.1.0/24 area 0.0.0.0	Configure the network command to advertise the prefixes
(config-router)# network 60.1.1.0/24 area 0.0.0.0	Configure the network command to advertise the prefixes
(config-router)#commit	Commit the candidate configuration to the running configuration
(config)# bfd interval 3 minrx 3 multiplier 3 Configure bfd interval globally	Configure BFD interval globally
(config)#commit	Commit the candidate configuration to the running configuration
(config)#end	Exit configure mode.

Validation

R1

Check LDP neighborhood before enabling RLFA.

```
#sh ldp session
Peer IP Address          IF Name    My Role    State          KeepAlive  UpTime
2.2.2.2                  xe20       Passive    OPERATIONAL    30         00:02:43
6.6.6.6                  ge10       Passive    OPERATIONAL    30         00:00:30
```

Check the output of show ip ospf neighbors to verify that OSPF adjacency is up.

```
#sh ip ospf neighbor

Total number of full neighbors: 2
OSPF process 1 VRF(default):
Neighbor ID      Pri   State                Dead Time   Address          Interface
Instance ID
2.2.2.2          1     Full/Backup          00:00:39    10.1.1.2         xe20
0
6.6.6.6          1     Full/DR               00:00:35    60.1.1.2         ge10
0
```

Check the OSPF route installation in the OSPF table and RIB table.

```
#sh ip route
Codes: K - kernel, C - connected, S - static, R - RIP, B - BGP
O - OSPF, IA - OSPF inter area
N1 - OSPF NSSA external type 1, N2 - OSPF NSSA external type 2
E1 - OSPF external type 1, E2 - OSPF external type 2
i - IS-IS, L1 - IS-IS level-1, L2 - IS-IS level-2,
ia - IS-IS inter area, E - EVPN,
```

v - vrf leaked
* - candidate default

IP Route Table for VRF "default"

```
C 1.1.1.1/32 is directly connected, lo, 00:37:05
O 2.2.2.2/32 [110/11] via 10.1.1.2, xe20, 00:04:49
O 3.3.3.3/32 [110/21] via 10.1.1.2, xe20, 00:04:49
O 4.4.4.4/32 [110/31] via 60.1.1.2, ge10, 00:04:49
  [110/31] via 10.1.1.2, xe20
O 5.5.5.5/32 [110/21] via 60.1.1.2, ge10, 00:02:29
O 6.6.6.6/32 [110/11] via 60.1.1.2, ge10, 00:02:29
C 10.1.1.0/24 is directly connected, xe20, 00:33:59
O 20.1.1.0/24 [110/20] via 10.1.1.2, xe20, 00:04:49
O 30.1.1.0/24 [110/30] via 10.1.1.2, xe20, 00:04:49
O 40.1.1.0/24 [110/30] via 60.1.1.2, ge10, 00:02:29
O 50.1.1.0/24 [110/20] via 60.1.1.2, ge10, 00:02:29
C 60.1.1.0/24 is directly connected, ge10, 00:02:36
C 127.0.0.0/8 is directly connected, lo, 00:45:19
```

Gateway of last resort is not set

#sh ip ospf route

OSPF process 1:

Codes: C - connected, D - Discard, O - OSPF, IA - OSPF inter area
N1 - OSPF NSSA external type 1, N2 - OSPF NSSA external type 2
E1 - OSPF external type 1, E2 - OSPF external type 2
OSPF LFA attributes:
P - Primary, SP - Secondary-Path, LP - Link Protecting,
NP - Node Protecting, BID - Broadcast Link Protecting
DP - Downstream Protecting

```
C 1.1.1.1/32 [1] is directly connected, lo, Area 0.0.0.0
O 2.2.2.2/32 [11] via 10.1.1.2, xe20, Area 0.0.0.0
O 3.3.3.3/32 [21] via 10.1.1.2, xe20, Area 0.0.0.0
O 4.4.4.4/32 [31] via 10.1.1.2, xe20, Area 0.0.0.0
  via 60.1.1.2, ge10, Area 0.0.0.0
O 5.5.5.5/32 [21] via 60.1.1.2, ge10, Area 0.0.0.0
O 6.6.6.6/32 [11] via 60.1.1.2, ge10, Area 0.0.0.0
C 10.1.1.0/24 [10] is directly connected, xe20, Area 0.0.0.0
O 20.1.1.0/24 [20] via 10.1.1.2, xe20, Area 0.0.0.0
O 30.1.1.0/24 [30] via 10.1.1.2, xe20, Area 0.0.0.0
O 40.1.1.0/24 [30] via 60.1.1.2, ge10, Area 0.0.0.0
O 50.1.1.0/24 [20] via 60.1.1.2, ge10, Area 0.0.0.0
C 60.1.1.0/24 [10] is directly connected, ge10, Area 0.0.0.0
```

Verify OSPF LFA and RLFA backup computed paths for Primary Paths

#sh ip ospf route fast-reroute

OSPF process 1:

Codes: C - connected, D - Discard, O - OSPF, IA - OSPF inter area
N1 - OSPF NSSA external type 1, N2 - OSPF NSSA external type 2
E1 - OSPF external type 1, E2 - OSPF external type 2
OSPF LFA attributes:
P - Primary, SP - Secondary-Path, LP - Link Protecting,
NP - Node Protecting, BID - Broadcast Link Protecting
DP - Downstream Protecting

```

O 2.2.2.2/32 [11] via 10.1.1.2, xe20, Area 0.0.0.0
    Remote FRR path:
    via 4.4.4.4, via 60.1.1.2, ge10, Area 0.0.0.0
    Attributes: Metric: [51] ,LP
O 3.3.3.3/32 [21] via 10.1.1.2, xe20, Area 0.0.0.0
    Remote FRR path:
    via 4.4.4.4, via 60.1.1.2, ge10, Area 0.0.0.0
    Attributes: Metric: [41] ,LP ,NP ,DP
O 4.4.4.4/32 [31] via 10.1.1.2, xe20, Area 0.0.0.0
    Backup path:
    via 60.1.1.2, ge10, Area 0.0.0.0
    Attributes: Metric: [31] ,P ,NP ,BID ,DP
    via 60.1.1.2, ge10, Area 0.0.0.0
    Backup path:
    via 10.1.1.2, xe20, Area 0.0.0.0
    Attributes: Metric: [31] ,P ,NP ,BID ,DP
O 5.5.5.5/32 [21] via 60.1.1.2, ge10, Area 0.0.0.0
    Remote FRR path:
    via 4.4.4.4, via 10.1.1.2, xe20, Area 0.0.0.0
    Attributes: Metric: [41] ,LP ,NP ,DP
O 6.6.6.6/32 [11] via 60.1.1.2, ge10, Area 0.0.0.0
    Remote FRR path:
    via 4.4.4.4, via 10.1.1.2, xe20, Area 0.0.0.0
    Attributes: Metric: [51] ,LP
O 20.1.1.0/24 [20] via 10.1.1.2, xe20, Area 0.0.0.0
    Remote FRR path:
    via 4.4.4.4, via 60.1.1.2, ge10, Area 0.0.0.0
    Attributes: Metric: [50] ,LP ,NP
O 30.1.1.0/24 [30] via 10.1.1.2, xe20, Area 0.0.0.0
    Backup path:
    via 60.1.1.2, ge10, Area 0.0.0.0
    Attributes: Metric: [40] ,SP ,NP ,BID
O 40.1.1.0/24 [30] via 60.1.1.2, ge10, Area 0.0.0.0
    Backup path:
    via 10.1.1.2, xe20, Area 0.0.0.0
    Attributes: Metric: [40] ,SP ,NP ,BID
O 50.1.1.0/24 [20] via 60.1.1.2, ge10, Area 0.0.0.0
    Remote FRR path:
    via 4.4.4.4, via 10.1.1.2, xe20, Area 0.0.0.0
    Attributes: Metric: [50] ,LP ,NP

```

Verify PQ node which is near to source is selected and Target-LDP session is established with PQ node using below commands

```

#sh ldp session
Peer IP Address          IF Name    My Role    State          KeepAlive  UpTime
2.2.2.2                  xe20      Passive    OPERATIONAL    30         00:07:29
6.6.6.6                  ge10      Passive    OPERATIONAL    30         00:05:16
4.4.4.4                  xe20      Passive    OPERATIONAL    30         00:05:04

```

Verify that Primary and Backup FTN's are installed with labels in LDP RLFA route table

```

#sh ldp rlfa-routes
Codes: p - stale rLFA route
Fec          Primary-NH    Backup-NH    rLFA-Addr    Out-Intf
Outer-label Inner-label Owner

```

OSPFv2 LDP Remote Loop-Free Alternate (RLFA)

2.2.2.2	10.1.1.2	60.1.1.2	4.4.4.4	ge10
24964	24969	ospf		
3.3.3.3	10.1.1.2	60.1.1.2	4.4.4.4	ge10
24964	24970	ospf		
5.5.5.5	60.1.1.2	10.1.1.2	4.4.4.4	xe20
24963	24971	ospf		
6.6.6.6	60.1.1.2	10.1.1.2	4.4.4.4	xe20
24963	24972	ospf		
20.1.1.0	10.1.1.2	60.1.1.2	4.4.4.4	ge10
24964	24974	ospf		
50.1.1.0	60.1.1.2	10.1.1.2	4.4.4.4	xe20
24963	24975	ospf		

Verify that backup XC's calculated for primary FTN's in MPLS forwarding table. Verify the same in FTN table.

```
#sh mpls forwarding-table
Codes: > - installed FTN, * - selected FTN, p - stale FTN,
       B - BGP FTN, K - CLI FTN, t - tunnel, P - SR Policy FTN,
       L - LDP FTN, R - RSVP-TE FTN, S - SNMP FTN, I - IGP-Shortcut,
       U - unknown FTN, O - SR-OSPF FTN, i - SR-ISIS FTN, k - SR-CLI FTN
(m) - FTN mapped over multipath transport

Code   FEC          FTN-ID   Nhlfe-ID  Tunnel-id  Pri  LSP-Type
Out-Label  Out-Intf  ELC     Nexthop
3      L>  2.2.2.2/32  1         2         -         Yes  LSP_DEFAULT
      xe20      No      10.1.1.2
24969  ge10      No      4.4.4.4  23
(via 60.1.1.2 ,label 24964)
      L>  3.3.3.3/32  2         4         -         Yes  LSP_DEFAULT
24962  xe20      No      10.1.1.2
24970  ge10      No      4.4.4.4  24
(via 60.1.1.2 ,label 24964)
      L>  4.4.4.4/32  3         6         -         Yes  LSP_DEFAULT
24963  xe20      No      10.1.1.2
24964  ge10      No      60.1.1.2  7
24964  ge10      No      60.1.1.2  7
24963  xe20      No      10.1.1.2  5
      L>  5.5.5.5/32  4         10        -         Yes  LSP_DEFAULT
24965  ge10      No      60.1.1.2
24971  xe20      No      4.4.4.4  25
(via 10.1.1.2 ,label 24963)
      L>  6.6.6.6/32  5         15        -         Yes  LSP_DEFAULT
3      ge10      No      60.1.1.2
24972  xe20      No      4.4.4.4  26
(via 10.1.1.2 ,label 24963)
      L>  20.1.1.0/24  6         11        -         Yes  LSP_DEFAULT
3      xe20      No      10.1.1.2
24974  ge10      No      4.4.4.4  27
```



```
(via 60.1.1.2 ,label 24964)
L> 30.1.1.0/24 7 13 - Yes LSP_DEFAULT
24966 xe20 No 10.1.1.2 16 - No LSP_DEFAULT
24966 ge10 No 60.1.1.2 19 - Yes LSP_DEFAULT
L> 40.1.1.0/24 8 20 - No LSP_DEFAULT
24967 ge10 No 10.1.1.2 22 - Yes LSP_DEFAULT
24967 xe20 No 60.1.1.2 28 - No LSP_DEFAULT
L> 50.1.1.0/24 9 3 - Yes LSP_DEFAULT
3 ge10 No 4.4.4.4 - No LSP_DEFAULT
24975 xe20 No
```

```
(via 10.1.1.2 ,label 24963)
```

```
#sh mpls ftn-table
```

```
Primary FTN entry with FEC: 2.2.2.2/32, id: 1, row status: Active, Tunnel-
Policy: N/A
```

```
Owner: LDP, distance: 0, Action-type: Redirect to LSP, Exp-bits: 0x0,
Incoming DSCP: none
```

```
Tunnel id: 0, Protected LSP id: 0, Description: N/A, Color: 0
```

```
Cross connect ix: 1, in intf: - in label: 0 out-segment ix: 1
```

```
Owner: N/A, Persistent: No, Admin Status: Up, Oper Status: Up
```

```
Out-segment with ix: 1, owner: N/A, Stale: NO, out intf: xe20, out
label: 3
```

```
Nexthop addr: 10.1.1.2 cross connect ix: 1, op code: Push
```

```
Backup Cross connect ix: 9, in intf: - in label: 0 out-segment ix: 23
```

```
Owner: LDP, Persistent: No, Admin Status: Up, Oper Status: Up
```

```
Out-segment with ix: 23, owner: LDP, Stale: NO, out intf: ge10, out
label: 24969
```

```
Nexthop addr: 4.4.4.4 cross connect ix: 9, op code: Push
```

```
Primary FTN entry with FEC: 3.3.3.3/32, id: 2, row status: Active, Tunnel-
Policy: N/A
```

```
Owner: LDP, distance: 0, Action-type: Redirect to LSP, Exp-bits: 0x0,
Incoming DSCP: none
```

```
Tunnel id: 0, Protected LSP id: 0, Description: N/A, Color: 0
```

```
Cross connect ix: 2, in intf: - in label: 0 out-segment ix: 3
```

```
Owner: LDP, Persistent: No, Admin Status: Up, Oper Status: Up
```

```
Out-segment with ix: 3, owner: LDP, Stale: NO, out intf: xe20, out
label: 24962
```

```
Nexthop addr: 10.1.1.2 cross connect ix: 2, op code: Push
```

```
Backup Cross connect ix: 11, in intf: - in label: 0 out-segment ix: 24
```

```
Owner: LDP, Persistent: No, Admin Status: Up, Oper Status: Up
```

```
Out-segment with ix: 24, owner: LDP, Stale: NO, out intf: ge10, out
label: 24970
```

```
Nexthop addr: 4.4.4.4 cross connect ix: 11, op code: Push
```

```
Primary FTN entry with FEC: 4.4.4.4/32, id: 3, row status: Active, Tunnel-
Policy: N/A
```

```
Owner: LDP, distance: 0, Action-type: Redirect to LSP, Exp-bits: 0x0,
Incoming DSCP: none
```

```
Tunnel id: 0, Protected LSP id: 0, Description: N/A, Color: 0
```

```
Cross connect ix: 3, in intf: - in label: 0 out-segment ix: 5
```

```

    Owner: LDP, Persistent: No, Admin Status: Up, Oper Status: Up
    Out-segment with ix: 5, owner: LDP, Stale: NO, out intf: xe20, out
label: 24963
    Nexthop addr: 10.1.1.2          cross connect ix: 3, op code: Push

    Backup Cross connect ix: 2, in intf: - in label: 0 out-segment ix: 7
    Owner: LDP, Persistent: No, Admin Status: Up, Oper Status: Up
    Out-segment with ix: 7, owner: LDP, Stale: NO, out intf: ge10, out
label: 24964
    Nexthop addr: 60.1.1.2          cross connect ix: 3, op code: Push

    Cross connect ix: 3, in intf: - in label: 0 out-segment ix: 7
    Owner: LDP, Persistent: No, Admin Status: Down, Oper Status: Not present
    Out-segment with ix: 7, owner: LDP, Stale: NO, out intf: ge10, out
label: 24964
    Nexthop addr: 60.1.1.2          cross connect ix: 3, op code: Push

    Backup Cross connect ix: 1, in intf: - in label: 0 out-segment ix: 5
    Owner: LDP, Persistent: No, Admin Status: Down, Oper Status: Not present
    Out-segment with ix: 5, owner: LDP, Stale: NO, out intf: xe20, out
label: 24963
    Nexthop addr: 10.1.1.2          cross connect ix: 3, op code: Push

    Primary FTN entry with FEC: 5.5.5.5/32, id: 4, row status: Active, Tunnel-
Policy: N/A
    Owner: LDP, distance: 0, Action-type: Redirect to LSP, Exp-bits: 0x0,
Incoming DSCP: none
    Tunnel id: 0, Protected LSP id: 0, Description: N/A, Color: 0
    Cross connect ix: 5, in intf: - in label: 0 out-segment ix: 9
    Owner: LDP, Persistent: No, Admin Status: Up, Oper Status: Up
    Out-segment with ix: 9, owner: LDP, Stale: NO, out intf: ge10, out
label: 24965
    Nexthop addr: 60.1.1.2          cross connect ix: 5, op code: Push

    Backup Cross connect ix: 13, in intf: - in label: 0 out-segment ix: 25
    Owner: LDP, Persistent: No, Admin Status: Up, Oper Status: Up
    Out-segment with ix: 25, owner: LDP, Stale: NO, out intf: xe20, out
label: 24971
    Nexthop addr: 4.4.4.4          cross connect ix: 13, op code: Push

    Primary FTN entry with FEC: 6.6.6.6/32, id: 5, row status: Active, Tunnel-
Policy: N/A
    Owner: LDP, distance: 0, Action-type: Redirect to LSP, Exp-bits: 0x0,
Incoming DSCP: none
    Tunnel id: 0, Protected LSP id: 0, Description: N/A, Color: 0
    Cross connect ix: 7, in intf: - in label: 0 out-segment ix: 14
    Owner: N/A, Persistent: No, Admin Status: Up, Oper Status: Up
    Out-segment with ix: 14, owner: N/A, Stale: NO, out intf: ge10, out
label: 3
    Nexthop addr: 60.1.1.2          cross connect ix: 7, op code: Push

    Backup Cross connect ix: 15, in intf: - in label: 0 out-segment ix: 26
    Owner: LDP, Persistent: No, Admin Status: Up, Oper Status: Up
    Out-segment with ix: 26, owner: LDP, Stale: NO, out intf: xe20, out
label: 24972
    Nexthop addr: 4.4.4.4          cross connect ix: 15, op code: Push

```

Primary FTN entry with FEC: 20.1.1.0/24, id: 6, row status: Active, Tunnel-Policy: N/A

Owner: LDP, distance: 0, Action-type: Redirect to LSP, Exp-bits: 0x0, Incoming DSCP: none

Tunnel id: 0, Protected LSP id: 0, Description: N/A, Color: 0

Cross connect ix: 1, in intf: - in label: 0 out-segment ix: 1

Owner: N/A, Persistent: No, Admin Status: Up, Oper Status: Up

Out-segment with ix: 1, owner: N/A, Stale: NO, out intf: xe20, out label: 3

Nexthop addr: 10.1.1.2 cross connect ix: 1, op code: Push

Backup Cross connect ix: 17, in intf: - in label: 0 out-segment ix: 27

Owner: LDP, Persistent: No, Admin Status: Up, Oper Status: Up

Out-segment with ix: 27, owner: LDP, Stale: NO, out intf: ge10, out label: 24974

Nexthop addr: 4.4.4.4 cross connect ix: 17, op code: Push

Primary FTN entry with FEC: 30.1.1.0/24, id: 7, row status: Active, Tunnel-Policy: N/A

Owner: LDP, distance: 0, Action-type: Redirect to LSP, Exp-bits: 0x0, Incoming DSCP: none

Tunnel id: 0, Protected LSP id: 0, Description: N/A, Color: 0

Cross connect ix: 6, in intf: - in label: 0 out-segment ix: 12

Owner: LDP, Persistent: No, Admin Status: Up, Oper Status: Up

Out-segment with ix: 12, owner: LDP, Stale: NO, out intf: xe20, out label: 24966

Nexthop addr: 10.1.1.2 cross connect ix: 6, op code: Push

Backup Cross connect ix: 3, in intf: - in label: 0 out-segment ix: 16

Owner: LDP, Persistent: No, Admin Status: Up, Oper Status: Up

Out-segment with ix: 16, owner: LDP, Stale: NO, out intf: ge10, out label: 24966

Nexthop addr: 60.1.1.2 cross connect ix: 3, op code: Push

Primary FTN entry with FEC: 40.1.1.0/24, id: 8, row status: Active, Tunnel-Policy: N/A

Owner: LDP, distance: 0, Action-type: Redirect to LSP, Exp-bits: 0x0, Incoming DSCP: none

Tunnel id: 0, Protected LSP id: 0, Description: N/A, Color: 0

Cross connect ix: 8, in intf: - in label: 0 out-segment ix: 18

Owner: LDP, Persistent: No, Admin Status: Up, Oper Status: Up

Out-segment with ix: 18, owner: LDP, Stale: NO, out intf: ge10, out label: 24967

Nexthop addr: 60.1.1.2 cross connect ix: 8, op code: Push

Backup Cross connect ix: 4, in intf: - in label: 0 out-segment ix: 20

Owner: LDP, Persistent: No, Admin Status: Up, Oper Status: Up

Out-segment with ix: 20, owner: LDP, Stale: NO, out intf: xe20, out label: 24967

Nexthop addr: 10.1.1.2 cross connect ix: 4, op code: Push

Primary FTN entry with FEC: 50.1.1.0/24, id: 9, row status: Active, Tunnel-Policy: N/A

Owner: LDP, distance: 0, Action-type: Redirect to LSP, Exp-bits: 0x0, Incoming DSCP: none

Tunnel id: 0, Protected LSP id: 0, Description: N/A, Color: 0
Cross connect ix: 7, in intf: - in label: 0 out-segment ix: 14
Owner: N/A, Persistent: No, Admin Status: Up, Oper Status: Up
Out-segment with ix: 14, owner: N/A, Stale: NO, out intf: ge10, out
label: 3
Nexthop addr: 60.1.1.2 cross connect ix: 7, op code: Push

Backup Cross connect ix: 19, in intf: - in label: 0 out-segment ix: 28
Owner: LDP, Persistent: No, Admin Status: Up, Oper Status: Up
Out-segment with ix: 28, owner: LDP, Stale: NO, out intf: xe20, out
label: 24975
Nexthop addr: 4.4.4.4 cross connect ix: 19, op code: Push

CHAPTER 12 OSPFv3

This chapter contains basic OSPFv3 configuration examples.

Enable OSPFv3 on an Interface

This example shows the minimum configuration required for enabling OSPFv3 on an interface. R1 and R2 are two routers in Area 0 connecting to the network 3ffe:10::/64. After enabling OSPFv3 on an interface, create a routing instance, and specify the Router ID.

Note: You must explicitly specify a Router ID for the OSPFv3 process to be activated.

Topology

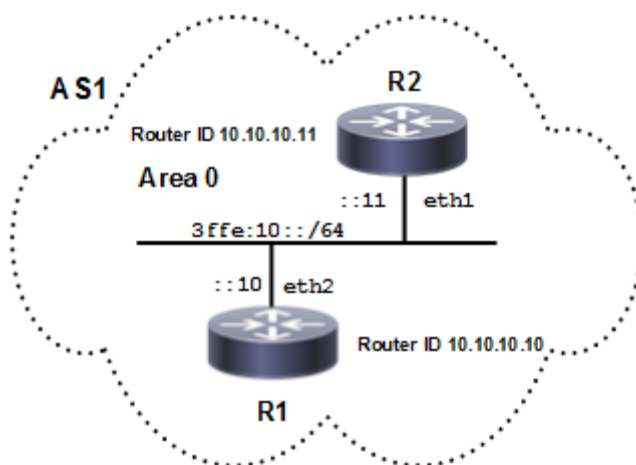

Figure 12-86: Basic OSPFv3 Topology

Configuration

R1

#configure terminal	Enter configure mode.
(config)#router ipv6 ospf	Create an OSPFv3 routing instance.
(config-router)#router-id 10.10.10.10	Specify a Router ID for the OSPFv3 routing process.
(config-router)#exit	Exit OSPF router mode.
(config)#interface eth2	Enter interface mode.
(config-if)#ipv6 router ospf area 0	Enable OSPFv3 routing on an interface, and assign the Area ID 0.
(config-if)#commit	Commit the candidate configuration to the running configuration.

R2

#configure terminal	Enter configure mode.
(config)#router ipv6 ospf	Create an OSPFv3 routing instance.
(config-router)#router-id 10.10.10.11	Specify a Router ID (10.10.10.11) for the OSPFv3 routing process.
(config-router)#exit	Exit OSPF router mode.
(config)#interface eth1	Enter interface mode.
(config-if)#ipv6 router ospf area 0	Enable OSPFv3 routing on an interface, and assign the Area ID (0).
(config-if)#commit	Commit the candidate configuration to the running configuration.

Validation**R1**

```
#show ipv6 ospf neighbor
```

```
OSPFv3 Process (*null*)
```

Neighbor ID	Pri	State	Dead Time	Interface	Instance ID
10.10.10.11	1	Full/Backup	00:00:35	eth2	0

```
#show ipv6 ospf database
```

```
OSPFv3 Router with ID (10.10.10.10) (Process *null*)
```

```
Link-LSA (Interface eth2)
```

Link State ID	ADV Router	Age	Seq#	CkSum	Prefix
0.0.0.4	10.10.10.10	164	0x80000001	0xf3c6	1
0.0.0.3	10.10.10.11	106	0x80000001	0xd973	1

```
Router-LSA (Area 0.0.0.0)
```

Link State ID	ADV Router	Age	Seq#	CkSum	Link
0.0.0.0	10.10.10.10	94	0x80000003	0xb2f0	1
0.0.0.0	10.10.10.11	95	0x80000003	0x9e05	1

```
Network-LSA (Area 0.0.0.0)
```

Link State ID	ADV Router	Age	Seq#	CkSum
0.0.0.4	10.10.10.10	94	0x80000001	0xf990

```
Intra-Area-Prefix-LSA (Area 0.0.0.0)
```

Link State ID	ADV Router	Age	Seq#	CkSum	Prefix	Reference
0.0.0.2	10.10.10.10	93	0x80000001	0xc35d	1	Network-LSA

```
Intra-Area-Te-LSA (Area 0.0.0.0)
```

Link State ID	ADV Router	Age	Seq#	CkSum
0.0.0.4	10.10.10.10	94	0x80000002	0x3504
0.0.0.3	10.10.10.11	95	0x80000002	0x6bcc

```
#show ipv6 ospfv3 topology
```

```
OSPFv3 Process (*null*)
```

```
OSPFv3 paths to Area (0.0.0.0) routers
```

Router ID	Bits	Metric	Next-Hop	Interface
10.10.10.10		--		
10.10.10.11		1	10.10.10.11	eth2

R2

```
#show ipv6 ospf neighbor
```

```
OSPFv3 Process (*null*)
```

Neighbor ID	Pri	State	Dead Time	Interface	Instance ID
10.10.10.10	1	Full/DR	00:00:31	eth1	0

```
R2#show ipv6 ospf database
```

```
OSPFv3 Router with ID (10.10.10.11) (Process *null*)
```

```
Link-LSA (Interface eth1)
```

Link State ID	ADV Router	Age	Seq#	CkSum	Prefix
0.0.0.4	10.10.10.10	341	0x80000001	0xf3c6	1
0.0.0.3	10.10.10.11	281	0x80000001	0xd973	1

```
Router-LSA (Area 0.0.0.0)
```

Link State ID	ADV Router	Age	Seq#	CkSum	Link
0.0.0.0	10.10.10.10	271	0x80000003	0xb2f0	1
0.0.0.0	10.10.10.11	270	0x80000003	0x9e05	1

```
Network-LSA (Area 0.0.0.0)
```

Link State ID	ADV Router	Age	Seq#	CkSum
0.0.0.4	10.10.10.10	271	0x80000001	0xf990

```
Intra-Area-Prefix-LSA (Area 0.0.0.0)
```

Link State ID	ADV Router	Age	Seq#	CkSum	Prefix	Reference
0.0.0.2	10.10.10.10	270	0x80000001	0xc35d	1	Network-LSA

```
Intra-Area-Te-LSA (Area 0.0.0.0)
```

Link State ID	ADV Router	Age	Seq#	CkSum
0.0.0.4	10.10.10.10	271	0x80000002	0x3504
0.0.0.3	10.10.10.11	270	0x80000002	0x6bcc

```
R2#show ipv6 ospfv3 topology
```

```
OSPFv3 Process (*null*)
OSPFv3 paths to Area (0.0.0.0) routers
Router ID      Bits  Metric  Next-Hop      Interface
10.10.10.10    1    1       10.10.10.10   eth1
10.10.10.11    --   --
```

Set Priority

This example shows how to set priority for an interface. Set a high priority for a router to make it the Designated Router (DR). Router R3 is configured with a priority of 10; this is higher than the default priority (default priority is 1) set for R1 and R2. This makes R3 the DR.

Topology

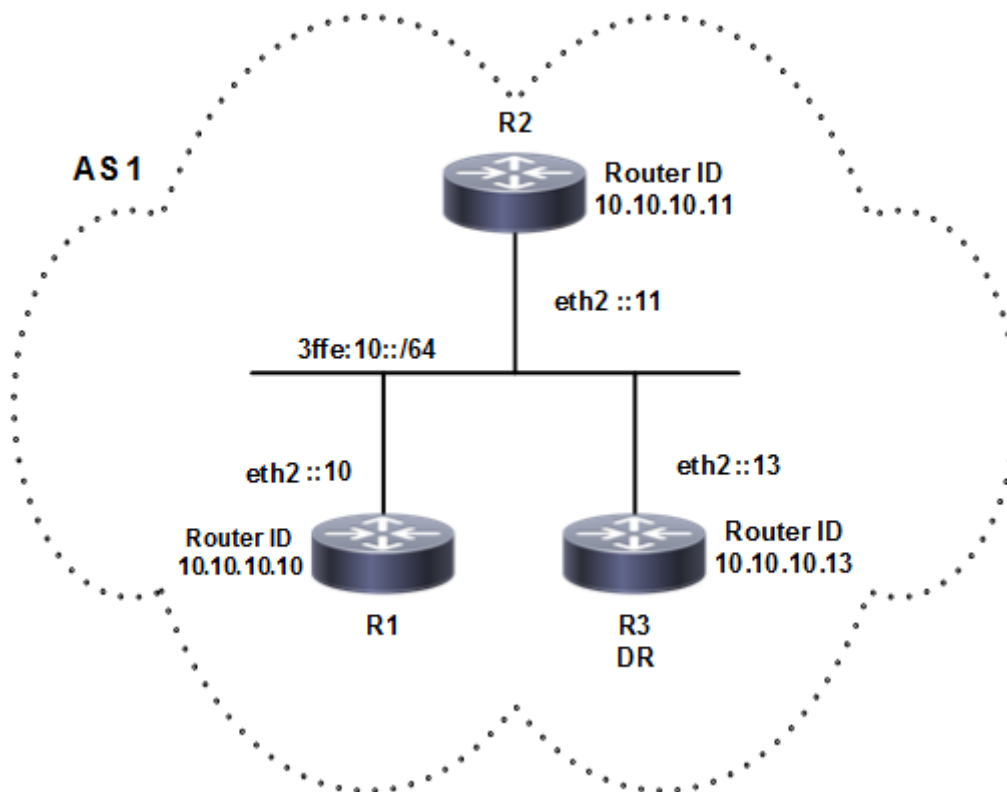

Figure 12-87: OSPFv3 Set Priority

R3

#configure terminal	Enter configure mode.
(config)#router ipv6 ospf	Create an OSPFv3 routing instance.
(config-router)#router-id 10.10.10.13	Specify a Router ID (10.10.10.13) for the OSPFv3 routing process.

(config-router)#exit	Exit OSPF router mode.
(config)#interface eth2	Enter interface mode.
(config-if)#ipv6 router ospf area 0	Enable OSPFv3 routing on an interface, and assign the Area ID (0).
(config-if)#ipv6 ospf priority 10	Specify the router priority to a higher priority (10) to make R3 the Designated Router (DR).
(config-if)#commit	Commit the candidate configuration to the running configuration.

R1

#configure terminal	Enter configure mode.
(config)#router ipv6 ospf	Create an OSPFv3 routing instance.
(config-router)#router-id 10.10.10.10	Specify a Router ID (10.10.10.10) for the OSPFv3 routing process.
(config-router)#exit	Exit OSPF router mode.
(config)#interface eth2	Enter interface mode.
(config-if)#ipv6 router ospf area 0	Enable OSPFv3 routing on an interface, and assign the Area ID (0).
(config-if)#commit	Commit the candidate configuration to the running configuration.

R2

(config)#router ipv6 ospf	Create an OSPFv3 routing instance.
(config-router)#router-id 10.10.10.11	Specify a Router ID (10.10.10.11) for the OSPFv3 routing process.
(config-router)#exit	Exit OSPF router mode.
(config)#interface eth2	Enter interface mode.
(config-if)#ipv6 router ospf area 0	Enable OSPFv3 routing on an interface, and assign the Area ID (0).
(config-if)#commit	Commit the candidate configuration to the running configuration.

Validation**R1**

```

rtr1#show ipv6 ospf neighbor
OSPFv3 Process (*null*)
Neighbor ID      Pri   State           Dead Time   Interface Instance ID
10.10.10.11     1    Full/DROther    00:00:37   eth2        0
10.10.10.13     10   Full/DR         00:00:37   eth2        0

rtr1#show ipv6 ospf database
                OSPFv3 Router with ID (10.10.10.10) (Process *null*)

                Link-LSA (Interface eth2)

```

Link State ID	ADV Router	Age	Seq#	CkSum	Prefix
0.0.0.4	10.10.10.10	398	0x80000001	0xf3c6	1
0.0.0.4	10.10.10.11	71	0x80000001	0x4768	1
0.0.0.4	10.10.10.13	611	0x80000002	0x695b	1

Router-LSA (Area 0.0.0.0)

Link State ID	ADV Router	Age	Seq#	CkSum	Link
0.0.0.0	10.10.10.10	49	0x80000004	0xf2ac	1
0.0.0.0	10.10.10.11	50	0x80000004	0xecb1	1
0.0.0.0	10.10.10.13	61	0x80000004	0xe0bb	1

Network-LSA (Area 0.0.0.0)

Link State ID	ADV Router	Age	Seq#	CkSum
0.0.0.4	10.10.10.13	61	0x80000002	0xa6b0

Intra-Area-Prefix-LSA (Area 0.0.0.0)

Link State ID	ADV Router	Age	Seq#	CkSum	Prefix	Reference
0.0.0.2	10.10.10.13	60	0x80000002	0xd940	1	Network-LSA

Intra-Area-Te-LSA (Area 0.0.0.0)

Link State ID	ADV Router	Age	Seq#	CkSum
0.0.0.4	10.10.10.10	49	0x80000003	0x75bf
0.0.0.4	10.10.10.11	50	0x80000004	0x9f92
0.0.0.4	10.10.10.13	61	0x80000003	0xf935

rtr1#show ipv6 ospfv3 topology

OSPFv3 Process (*null*)

OSPFv3 paths to Area (0.0.0.0) routers

Router ID	Bits	Metric	Next-Hop	Interface
10.10.10.10		--		
10.10.10.11		1	10.10.10.11	eth2
10.10.10.13		1	10.10.10.13	eth2

R2

R2#show ipv6 ospf neighbor

OSPFv3 Process (*null*)

Neighbor ID	Pri	State	Dead Time	Interface	Instance ID
10.10.10.10	1	Full/Backup	00:00:31	eth2	0
10.10.10.13	10	Full/DR	00:00:39	eth2	0

R2#show ipv6 ospf database

OSPFv3 Router with ID (10.10.10.11) (Process *null*)

Link-LSA (Interface eth2)

Link State ID	ADV Router	Age	Seq#	CkSum	Prefix
0.0.0.4	10.10.10.10	525	0x80000001	0xf3c6	1
0.0.0.4	10.10.10.11	194	0x80000001	0x4768	1

```
0.0.0.4      10.10.10.13      736      0x80000002 0x695b      1
```

```
Router-LSA (Area 0.0.0.0)
```

Link State ID	ADV Router	Age	Seq#	CkSum	Link
0.0.0.0	10.10.10.10	175	0x80000004	0xf2ac	1
0.0.0.0	10.10.10.11	174	0x80000004	0xecb1	1
0.0.0.0	10.10.10.13	186	0x80000004	0xe0bb	1

```
Network-LSA (Area 0.0.0.0)
```

Link State ID	ADV Router	Age	Seq#	CkSum
0.0.0.4	10.10.10.13	186	0x80000002	0xa6b0

```
Intra-Area-Prefix-LSA (Area 0.0.0.0)
```

Link State ID	ADV Router	Age	Seq#	CkSum	Prefix	Reference
0.0.0.2 LSA	10.10.10.13	185	0x80000002	0xd940	1	Network-

```
Intra-Area-Te-LSA (Area 0.0.0.0)
```

Link State ID	ADV Router	Age	Seq#	CkSum
0.0.0.4	10.10.10.10	175	0x80000003	0x75bf
0.0.0.4	10.10.10.11	174	0x80000004	0x9f92
0.0.0.4	10.10.10.13	186	0x80000003	0xf935

```
R2#show ipv6 ospfv3 topology
```

```
OSPFv3 Process (*null*)
```

```
OSPFv3 paths to Area (0.0.0.0) routers
```

Router ID	Bits	Metric	Next-Hop	Interface
10.10.10.10		1	10.10.10.10	eth2
10.10.10.11		--		
10.10.10.13		1	10.10.10.13	eth2

R3

```
R3#show ipv6 ospf neighbor
```

```
OSPFv3 Process (*null*)
```

Neighbor ID	Pri	State	Dead Time	Interface	Instance ID
10.10.10.10	1	Full/Backup	00:00:38	eth2	0
10.10.10.11	1	Full/DROther	00:00:29	eth2	0

```
R3#show ipv6 ospf database
```

```
OSPFv3 Router with ID (10.10.10.13) (Process *null*)
```

```
Link-LSA (Interface eth2)
```

Link State ID	ADV Router	Age	Seq#	CkSum	Prefix
0.0.0.4	10.10.10.10	658	0x80000001	0xf3c6	1
0.0.0.4	10.10.10.11	329	0x80000001	0x4768	1
0.0.0.4	10.10.10.13	869	0x80000002	0x695b	1

```
Router-LSA (Area 0.0.0.0)
```

Link State ID	ADV Router	Age	Seq#	CkSum	Link
---------------	------------	-----	------	-------	------

```

0.0.0.0      10.10.10.10    309      0x80000004 0xf2ac    1
0.0.0.0      10.10.10.11    309      0x80000004 0xecb1    1
0.0.0.0      10.10.10.13    319      0x80000004 0xe0bb    1

```

Network-LSA (Area 0.0.0.0)

```

Link State ID  ADV Router      Age      Seq#           CkSum
0.0.0.4        10.10.10.13     319      0x80000002 0xa6b0

```

Intra-Area-Prefix-LSA (Area 0.0.0.0)

```

Link State ID  ADV Router      Age      Seq#           CkSum  Prefix  Reference
0.0.0.2        10.10.10.13     318      0x80000002 0xd940    1  Network-
LSA

```

Intra-Area-Te-LSA (Area 0.0.0.0)

```

Link State ID  ADV Router      Age      Seq#           CkSum
0.0.0.4        10.10.10.10     309      0x80000003 0x75bf
0.0.0.4        10.10.10.11     309      0x80000004 0x9f92
0.0.0.4        10.10.10.13     319      0x80000003 0xf935

```

R3#show ipv6 ospfv3 topology

OSPFv3 Process (*null*)

OSPFv3 paths to Area (0.0.0.0) routers

```

Router ID      Bits Metric      Next-Hop           Interface
10.10.10.10    1          10.10.10.10       eth2
10.10.10.11    1          10.10.10.11       eth2
10.10.10.13    --

```

Area Border Router

This example shows configuration for an Area Border Router. R2 is an Area Border Router (ABR). On R2, interface eth2 is in Area 0, and interface eth1 is in Area 1.

Topology

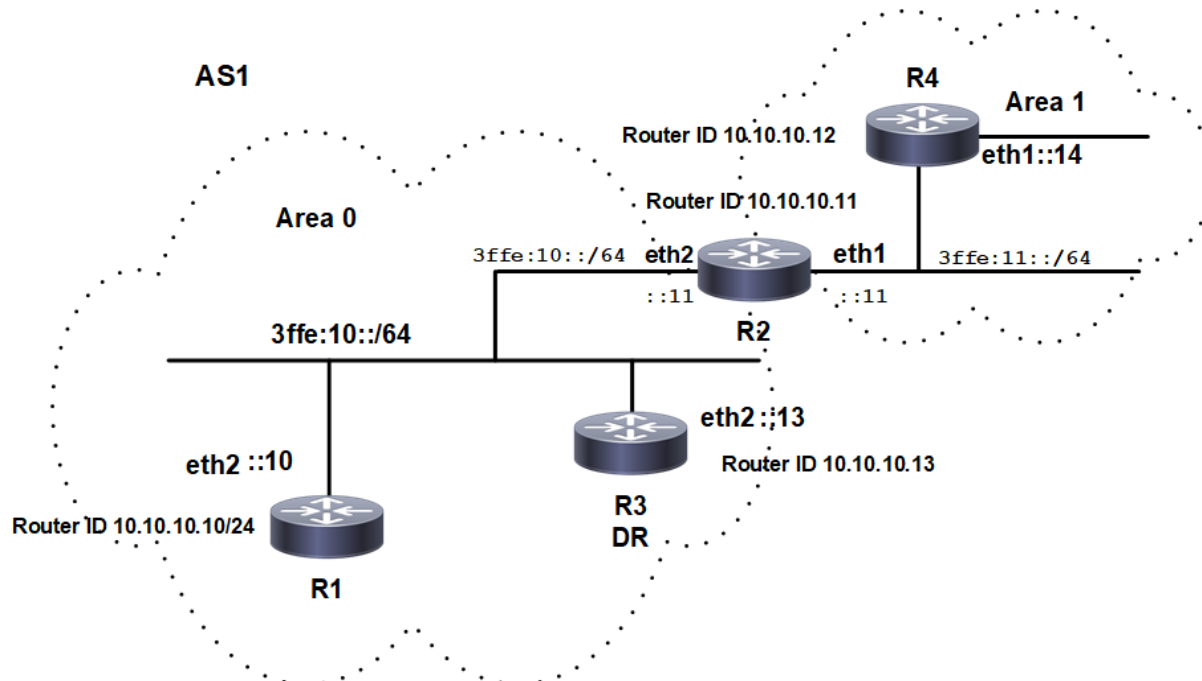

Figure 12-88: OSPFv3 Area Border Router

Configuration

R2

#configure terminal	Enter configure mode.
(config)#router ipv6 ospf	Create an OSPFv3 routing instance.
(config-router)#router-id 10.10.10.11	Specify a Router ID (10.10.10.11) for the OSPFv3 routing process.
(config-router)#exit	Exit OSPF router mode.
(config)#interface eth2	Enter interface mode.
(config-if)#ipv6 router ospf area 0	Enable OSPFv3 routing on an interface, and assign the Area ID (0).
(config-if)#exit	Exit interface mode.
(config)#interface eth1	Enter interface mode.
(config-if)#ipv6 router ospf area 1	Enable OSPFv3 routing on the other interface, and assign the other Area ID (1).
(config-if)#commit	Commit the candidate configuration to the running configuration.
(config-if)#exit	Exit interface mode.

R4

#configure terminal	Enter configure mode.
(config)#router ipv6 ospf	Create an OSPFv3 routing instance.
(config-router)#router-id 10.10.10.12	Specify a Router ID (10.10.10.12) for the OSPFv3 routing process.
(config-if)#exit	Exit interface mode.
(config)#interface eth1	Enter interface mode.
(config-if)#ipv6 router ospf area 1	Enable OSPFv3 routing on the other interface, and assign the other Area ID (1).
(config-if)#commit	Commit the candidate configuration to the running configuration.
(config-if)#exit	Exit interface mode.

Validation**R2**

```
R2#show ipv6 ospf neighbor
```

```
Total number of full neighbors: 3
```

```
OSPFv3 Process (*null*)
```

Neighbor ID	Pri	State	Dead Time	Interface	Instance ID
10.10.10.12	1	Full/Backup	00:00:32	eth1	0
10.10.10.10	1	Full/Backup	00:00:36	eth2	0
10.10.10.13	10	Full/DR	00:00:32	eth2	0

```
R2#
```

```
R2#show ipv6 ospf database
```

```
OSPFv3 Router with ID (10.10.10.11) (Process *null*)
```

```
Link-LSA (Interface eth1)
```

Link State ID	ADV Router	Age	Seq#	CkSum	Prefix
0.0.0.3	10.10.10.11	945	0x80000001	0x9d7f	1
0.0.0.3	10.10.10.12	797	0x80000001	0x271c	1

```
Link-LSA (Interface eth2)
```

Link State ID	ADV Router	Age	Seq#	CkSum	Prefix
0.0.0.4	10.10.10.10	1766	0x80000002	0x9a8b	1
0.0.0.4	10.10.10.11	1719	0x80000002	0x3fb0	1
0.0.0.4	10.10.10.13	6	0x80000004	0xd7e9	1

```
Router-LSA (Area 0.0.0.0)
```

Link State ID	ADV Router	Age	Seq#	CkSum	Link
0.0.0.0	10.10.10.10	1703	0x80000005	0xf0ad	1
0.0.0.0	10.10.10.11	945	0x80000006	0xebaf	1

```

0.0.0.0      10.10.10.13    1708      0x80000005 0xdebc    1

Network-LSA (Area 0.0.0.0)

Link State ID  ADV Router    Age      Seq#      CkSum
0.0.0.4      10.10.10.13    1708      0x80000003 0xa4b1

Inter-Area-Prefix-LSA (Area 0.0.0.0)

Link State ID  ADV Router    Age      Seq#      CkSum
0.0.0.1      10.10.10.11    945      0x80000001 0xdc9f

Intra-Area-Prefix-LSA (Area 0.0.0.0)

Link State ID  ADV Router    Age      Seq#      CkSum  Prefix  Reference
0.0.0.2      10.10.10.13    1708      0x80000003 0xd741    1  Network-LSA

Intra-Area-Te-LSA (Area 0.0.0.0)

Link State ID  ADV Router    Age      Seq#      CkSum
0.0.0.4      10.10.10.10    1703      0x80000004 0x4ef9
0.0.0.4      10.10.10.11    1704      0x80000004 0x7acb
0.0.0.4      10.10.10.13    1708      0x80000004 0xd26f

Router-LSA (Area 0.0.0.1)

Link State ID  ADV Router    Age      Seq#      CkSum  Link
0.0.0.0      10.10.10.11    785      0x80000003 0xa5fc    1
0.0.0.0      10.10.10.12    785      0x80000003 0x9c06    1

Network-LSA (Area 0.0.0.1)

Link State ID  ADV Router    Age      Seq#      CkSum
0.0.0.3      10.10.10.11    785      0x80000001 0x1672

Inter-Area-Prefix-LSA (Area 0.0.0.1)

Link State ID  ADV Router    Age      Seq#      CkSum
0.0.0.1      10.10.10.11    940      0x80000002 0xccaf

Intra-Area-Prefix-LSA (Area 0.0.0.1)

Link State ID  ADV Router    Age      Seq#      CkSum  Prefix  Reference
0.0.0.2      10.10.10.11    784      0x80000001 0xd747    1  Network-LSA

Intra-Area-Te-LSA (Area 0.0.0.1)

Link State ID  ADV Router    Age      Seq#      CkSum
0.0.0.3      10.10.10.11    785      0x80000002 0x70da
0.0.0.3      10.10.10.12    785      0x80000002 0x0146

```

OSPFv3

R2#

R2#show ipv6 ospfv3 topology

OSPFv3 Process (*null*)

OSPFv3 paths to Area (0.0.0.0) routers

Router ID	Bits	Metric	Next-Hop	Interface
10.10.10.10		1	10.10.10.10	eth2
10.10.10.11	B	--		
10.10.10.13		1	10.10.10.13	eth2

OSPFv3 paths to Area (0.0.0.1) routers

Router ID	Bits	Metric	Next-Hop	Interface
10.10.10.11	B	--		
10.10.10.12		1	10.10.10.12	eth1

R2#

R2#show ipv6 route

IPv6 Routing Table

Codes: K - kernel route, C - connected, S - static, R - RIP, O - OSPF,
IA - OSPF inter area, E1 - OSPF external type 1,
E2 - OSPF external type 2, E - EVPN N1 - OSPF NSSA external type 1,
N2 - OSPF NSSA external type 2, i - IS-IS, B - BGP

Timers: Uptime

IP Route Table for VRF "default"

C ::1/128 via ::, lo, 01:09:54
C 3ffe:10::/64 via ::, eth2, 01:06:27
C 3ffe:11::/64 via ::, eth1, 00:21:16 R2#show ipv6 ospf route

OSPFv3 Process (*null*)

Codes: C - connected, D - Discard, O - OSPF, IA - OSPF inter area
N1 - OSPF NSSA external type 1, N2 - OSPF NSSA external type 2
E1 - OSPF external type 1, E2 - OSPF external type 2

Destination	Metric
Next-hop	
C 3ffe:10::/64	1
directly connected, eth2, Area 0.0.0.0	
C 3ffe:11::/64	1
directly connected, eth1, Area 0.0.0.1	

R2#

C fe80::/64 via ::, eth9, 01:09:54

R2#

R1

R1#show ipv6 route

IPv6 Routing Table

Codes: K - kernel route, C - connected, S - static, R - RIP, O - OSPF,
 IA - OSPF inter area, E1 - OSPF external type 1,
 E2 - OSPF external type 2, E - EVPN N1 - OSPF NSSA external type 1,
 N2 - OSPF NSSA external type 2, i - IS-IS, B - BGP

Timers: Uptime

IP Route Table for VRF "default"

C ::1/128 via ::, lo, 01:27:52
 C 3ffe:10::/64 via ::, eth2, 01:25:13
 O IA 3ffe:11::/64 [110/2] via fe80::5054:ff:fe3d:e317, eth2, 00:36:07
 C fe80::/64 via ::, eth9, 01:27:52

R1#

R3

R3#show ipv6 route

IPv6 Routing Table

Codes: K - kernel route, C - connected, S - static, R - RIP, O - OSPF,
 IA - OSPF inter area, E1 - OSPF external type 1,
 E2 - OSPF external type 2, E - EVPN N1 - OSPF NSSA external type 1,
 N2 - OSPF NSSA external type 2, i - IS-IS, B - BGP

Timers: Uptime

IP Route Table for VRF "default"

C ::1/128 via ::, lo, 01:26:53
 C 3ffe:10::/64 via ::, eth2, 01:23:21
 O IA 3ffe:11::/64 [110/2] via fe80::5054:ff:fe3d:e317, eth2, 00:34:39
 C fe80::/64 via ::, eth9, 01:26:53

R3#

R4

R4#show ipv6 route

IPv6 Routing Table

Codes: K - kernel route, C - connected, S - static, R - RIP, O - OSPF,
 IA - OSPF inter area, E1 - OSPF external type 1,
 E2 - OSPF external type 2, E - EVPN N1 - OSPF NSSA external type 1,
 N2 - OSPF NSSA external type 2, i - IS-IS, B - BGP

Timers: Uptime

IP Route Table for VRF "default"

C ::1/128 via ::, lo, 00:47:25
 O IA 3ffe:10::/64 [110/2] via fe80::5054:ff:fe0e:46b7, eth1, 00:30:12
 C 3ffe:11::/64 via ::, eth1, 00:36:23
 C fe80::/64 via ::, eth9, 00:47:25

R4#

Redistribute Routes into OSPFv3

In this example, the BGP routes are imported into the OSPF routing table, and advertised as Type 5 External LSAs into Area 0.

Topology

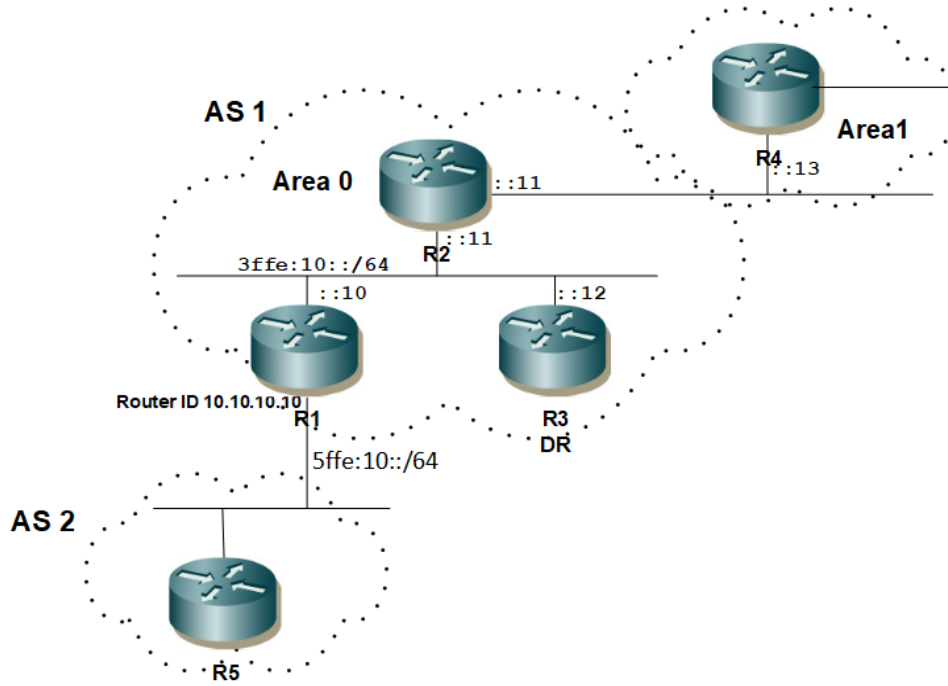

Figure 12-89: OSPFv3 Redistribute Routes

Configuration

R5

(config)#router bgp 2	Configure router bgp instance
(config-router)# neighbor 5ffe:10::10 remote-as 1	Configure R1 as ipv6 BGP neighbor
(config-router)# neighbor 5ffe:10::10 ebgp-multihop 4	Configure the ebgp -multihop for the ebgp neighbor R1
(config-router)# address-family ipv6 unicast	
(config-router-af)# neighbor 5ffe:10::10 activate	Activate the BGP neighbor on R1 for address-family ipv6 unicast to advertise and receive ipv6 routes
(config-router-af)#exit	Exit mode
(config-router)#commit	Commit the candidate configuration to the running configuration.

R1

#configure terminal	Enter configure mode.
(config)#router bgp 2	Configure router bgp instance
(config-router)# neighbor 5ffe:10::55 remote-as 2	Configure R5 as ipv6 BGP neighbor
(config-router)# neighbor 5ffe:10::55 ebgp-multihop 4	Configure the ebgp -multihop for the ebgp neighbor R5
(config-router)# address-family ipv6 unicast	
(config-router-af)# neighbor 5ffe:10::55 activate	Activate the BGP neighbor on R5 for address-family ipv6 unicast to advertise and receive ipv6 routes
(config-router-af)#exit	Exit address-family ipv6 unicast mode
(config-router)#exit	Exit router bgp mode
(config)#router ipv6 ospf	Create an OSPFv3 routing instance.
(config-router)#router-id 10.10.10.10	Specify a Router ID (10.10.10.10) for the OSPFv3 routing process.
(config-router)#redistribute bgp	Specify redistributing routes from the other routing protocol (BGP) into OSPFv3.
(config-router)#exit	Exit OSPF router mode.
(config)#interface eth12	Enter interface mode.
(config-if)#ipv6 router ospf area 0	Enable OSPFv3 routing on an interface, and assign the Area ID (0).
(config-router)#commit	Commit the candidate configuration to the running configuration.

Validation

R2

```
R2#show ipv6 ospf neighbor
```

```
Total number of full neighbors: 3
```

OSPFv3

OSPFv3 Process (*null*)

Neighbor ID	Pri	State	Dead Time	Interface	Instance ID
10.10.10.12	1	Full/Backup	00:00:31	eth1	0
10.10.10.10	1	Full/Backup	00:00:32	eth2	0
10.10.10.13	10	Full/DR	00:00:31	eth2	0

R2#

R2#show ipv6 ospf database

OSPFv3 Router with ID (10.10.10.11) (Process *null*)

Link-LSA (Interface eth1)

Link State ID	ADV Router	Age	Seq#	CkSum	Prefix
0.0.0.3	10.10.10.11	1327	0x80000006	0x9384	1
0.0.0.3	10.10.10.12	1180	0x80000006	0x1d21	1

Link-LSA (Interface eth2)

Link State ID	ADV Router	Age	Seq#	CkSum	Prefix
0.0.0.4	10.10.10.10	348	0x80000008	0x8e91	1
0.0.0.4	10.10.10.11	300	0x80000008	0x33b6	1
0.0.0.4	10.10.10.13	387	0x80000009	0xcdee	1

Router-LSA (Area 0.0.0.0)

Link State ID	ADV Router	Age	Seq#	CkSum	Link
0.0.0.0	10.10.10.10	24	0x8000000d	0xe6ad	1
0.0.0.0	10.10.10.11	1321	0x8000000b	0xe1b4	1
0.0.0.0	10.10.10.13	287	0x8000000b	0xd2c2	1

Network-LSA (Area 0.0.0.0)

Link State ID	ADV Router	Age	Seq#	CkSum
0.0.0.4	10.10.10.13	287	0x80000009	0x98b7

Inter-Area-Prefix-LSA (Area 0.0.0.0)

Link State ID	ADV Router	Age	Seq#	CkSum
0.0.0.1	10.10.10.11	1321	0x80000006	0xd2a4

Intra-Area-Prefix-LSA (Area 0.0.0.0)

Link State ID	ADV Router	Age	Seq#	CkSum	Prefix	Reference
0.0.0.2	10.10.10.13	287	0x80000009	0xcb47	1	Network-LSA

Intra-Area-Te-LSA (Area 0.0.0.0)

Link State ID	ADV Router	Age	Seq#	CkSum
0.0.0.4	10.10.10.10	284	0x8000000a	0x42ff

```

0.0.0.4      10.10.10.11      281      0x8000000a 0x6ed1
0.0.0.4      10.10.10.13      287      0x8000000a 0xc675

```

```

Router-LSA (Area 0.0.0.1)

```

```

Link State ID  ADV Router      Age      Seq#      CkSum      Link
0.0.0.0        10.10.10.11     1165     0x80000008 0x9b02     1
0.0.0.0        10.10.10.12     1162     0x80000008 0x920b     1

```

```

Network-LSA (Area 0.0.0.1)

```

```

Link State ID  ADV Router      Age      Seq#      CkSum
0.0.0.3        10.10.10.11     1165     0x80000006 0x0c77

```

```

Inter-Area-Prefix-LSA (Area 0.0.0.1)

```

```

Link State ID  ADV Router      Age      Seq#      CkSum
0.0.0.1        10.10.10.11     1320     0x80000007 0xc2b4

```

```

Inter-Area-Router-LSA (Area 0.0.0.1)

```

```

Link State ID  ADV Router      Age      Seq#      CkSum
0.0.0.1        10.10.10.11     25       0x80000005 0x941a

```

```

Intra-Area-Prefix-LSA (Area 0.0.0.1)

```

```

Link State ID  ADV Router      Age      Seq#      CkSum  Prefix  Reference
0.0.0.2        10.10.10.11     1165     0x80000006 0xcd4c   1  Network-LSA

```

```

Intra-Area-Te-LSA (Area 0.0.0.1)

```

```

Link State ID  ADV Router      Age      Seq#      CkSum
0.0.0.3        10.10.10.11     1165     0x80000007 0x66df
0.0.0.3        10.10.10.12     1162     0x80000007 0xf64b

```

```

AS-external-LSA

```

```

Link State ID  ADV Router      Age      Seq#      CkSum  Route  Tag
0.0.0.1        10.10.10.10     65       0x80000002 0x284a  E2    0

```

```

R2#

```

```

R2#show ipv6 ospfv3 topology

```

```

OSPFv3 Process (*null*)

```

```

OSPFv3 paths to Area (0.0.0.0) routers

```

```

Router ID      Bits  Metric  Next-Hop      Interface
10.10.10.10    E    1       10.10.10.10   eth2
10.10.10.11    B    --
10.10.10.13    1    1       10.10.10.13   eth2

```

OSPFv3

OSPFv3 paths to Area (0.0.0.1) routers

Router ID	Bits	Metric	Next-Hop	Interface
10.10.10.11	B	--		
10.10.10.12		1	10.10.10.12	eth1

R2#

R2#show ipv6 ospf route

OSPFv3 Process (*null*)

Codes: C - connected, D - Discard, O - OSPF, IA - OSPF inter area

N1 - OSPF NSSA external type 1, N2 - OSPF NSSA external type 2

E1 - OSPF external type 1, E2 - OSPF external type 2

Destination	Metric
Next-hop	
E2 2000::/64	1/20
via fe80::5054:ff:fe2b:20b7, eth2	
C 3ffe:10::/64	1
directly connected, eth2, Area 0.0.0.0	
C 3ffe:11::/64	1
directly connected, eth1, Area 0.0.0.1	

R2#

R2#show ipv6 route

IPv6 Routing Table

Codes: K - kernel route, C - connected, S - static, R - RIP, O - OSPF,

IA - OSPF inter area, E1 - OSPF external type 1,

E2 - OSPF external type 2, E - EVPN N1 - OSPF NSSA external type 1,

N2 - OSPF NSSA external type 2, i - IS-IS, B - BGP

Timers: Uptime

IP Route Table for VRF "default"

C	::1/128	via ::, lo, 03:49:59
O E2	2000::/64 [110/20]	via fe80::5054:ff:fe2b:20b7, eth2, 00:36:38
C	3ffe:10::/64	via ::, eth2, 03:46:32
C	3ffe:11::/64	via ::, eth1, 03:01:21
C	fe80::/64	via ::, eth9, 03:49:59

R2#

R3

R3#show ipv6 ospf route

OSPFv3 Process (*null*)

Codes: C - connected, D - Discard, O - OSPF, IA - OSPF inter area

N1 - OSPF NSSA external type 1, N2 - OSPF NSSA external type 2

E1 - OSPF external type 1, E2 - OSPF external type 2

Destination	Metric
-------------	--------

```

Next-hop
E2 2000::/64                               1/20
    via fe80::5054:ff:fe2b:20b7, eth2
C 3ffe:10::/64                              1
    directly connected, eth2, Area 0.0.0.0
IA 3ffe:11::/64                             2
    via fe80::5054:ff:fe3d:e317, eth2, Area 0.0.0.0
R3#

```

```

R3#show ipv6 route
IPv6 Routing Table
Codes: K - kernel route, C - connected, S - static, R - RIP, O - OSPF,
      IA - OSPF inter area, E1 - OSPF external type 1,
      E2 - OSPF external type 2, E - EVPN  N1 - OSPF NSSA external type 1,
      N2 - OSPF NSSA external type 2, i - IS-IS, B - BGP
Timers: Uptime

```

```

IP Route Table for VRF "default"
C   ::1/128 via ::, lo, 03:51:07
O E2 2000::/64 [110/20] via fe80::5054:ff:fe2b:20b7, eth2, 00:37:50
C   3ffe:10::/64 via ::, eth2, 03:47:35
O IA 3ffe:11::/64 [110/2] via fe80::5054:ff:fe3d:e317, eth2, 02:58:53
C   fe80::/64 via ::, eth9, 03:51:07
R3#

```

R4

```

R4#show ipv6 ospf route
OSPFv3 Process (*null*)
Codes: C - connected, D - Discard, O - OSPF, IA - OSPF inter area
      N1 - OSPF NSSA external type 1, N2 - OSPF NSSA external type 2
      E1 - OSPF external type 1, E2 - OSPF external type 2

```

```

Destination                Metric
Next-hop
E2 2000::/64                2/20
    via fe80::5054:ff:fe0e:46b7, eth1
IA 3ffe:10::/64             2
    via fe80::5054:ff:fe0e:46b7, eth1, Area 0.0.0.1
C 3ffe:11::/64              1
    directly connected, eth1, Area 0.0.0.1

```

R4#

```

R4#show ipv6 route
IPv6 Routing Table
Codes: K - kernel route, C - connected, S - static, R - RIP, O - OSPF,

```

IA - OSPF inter area, E1 - OSPF external type 1,
 E2 - OSPF external type 2, E - EVPN N1 - OSPF NSSA external type 1,
 N2 - OSPF NSSA external type 2, i - IS-IS, B - BGP

Timers: Uptime

IP Route Table for VRF "default"

```
C      ::1/128 via ::, lo, 03:15:06
O E2   2000::/64 [110/20] via fe80::5054:ff:fe0e:46b7, eth1, 00:39:34
O IA   3ffe:10::/64 [110/2] via fe80::5054:ff:fe0e:46b7, eth1, 02:57:53
C      3ffe:11::/64 via ::, eth1, 03:04:04
C      fe80::/64 via ::, eth9, 03:15:06
R4#
```

Cost

Make a route the preferred route by changing its cost. In this example, cost has been configured to make R2 the next hop for R1.

The default cost for each interface is 10. Interface eth2 on R2 has a cost of 100, and Interface eth2 on R3 has a cost of 150. The total cost to reach 10.10.14.0/24 (R4) through R2 and R3 is computed as follows:

R2: 10+100 = 110

R3: 10+150 = 160

For this reason, R1 chooses R2 as its next hop to destination 10.10.14.0/24, because it has the lower cost.

Topology

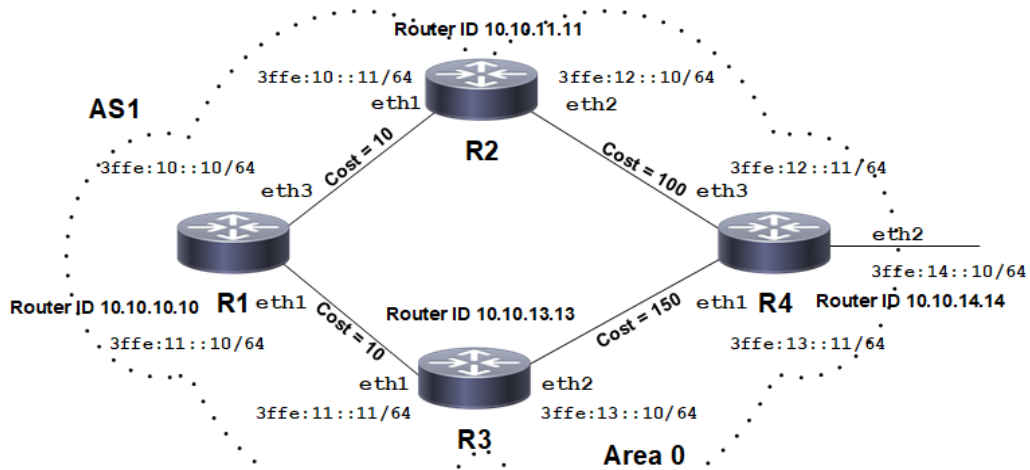

Figure 12-90: Configure Cost OSPFv3

Configuration

R1

#configure terminal	Enter configure mode.
(config)#router ipv6 ospf	Create an OSPFv3 routing instance.
(config-router)#router-id 10.10.10.10	Specify a Router ID (10.10.10.10) for the OSPFv3 routing process.
(config-router)#exit	Exit OSPF router mode.
(config)#interface eth3	Enter interface mode.
(config-if)#ipv6 router ospf area 0	Enable OSPFv3 routing on an interface, and assign the Area ID (0).
(config-if)#exit	Exit interface mode.
(config)#interface eth1	Enter interface mode.
(config-if)#ipv6 router ospf area 0	Enable OSPFv3 routing on an interface, and assign the Area ID (0).
(config-if)#exit	Exit interface mode.
(config)#interface eth2	Enter interface mode.
(config-if)#ipv6 router ospf area 0	Enable OSPFv3 routing on an interface, and assign the Area ID (0).
(config-router)#commit	Commit the candidate configuration to the running configuration.

R2

(config)#router ipv6 ospf	Create an OSPFv3 routing instance.
(config-router)#router-id 10.10.11.11	Specify a Router ID (10.10.11.11) for the OSPFv3 routing process.
(config-router)#exit	Exit OSPF router mode.
(config)#interface eth1	Enter interface mode.
(config-if)#ipv6 router ospf area 0	Enable OSPFv3 routing on an interface, and assign the Area ID (0).
(config-if)#exit	Exit interface mode.
(config)#interface eth2	Enter interface mode.
(config-if)#ipv6 router ospf area 0	Enable OSPFv3 routing on an interface, and assign the Area ID (0).
(config-if)#ipv6 ospf cost 100	Set the cost of the link-state metric (on eth2) to 100.
(config-router)#commit	Commit the candidate configuration to the running configuration.

R3

(config)#router ipv6 ospf	Create an OSPFv3 routing instance.
(config-router)#router-id 10.10.13.13	Specify a Router ID (10.10.13.13) for the OSPFv3 routing process.

OSPFv3

(config-router)#exit	Exit OSPF router mode.
(config)#interface eth1	Enter interface mode.
(config-if)#ipv6 router ospf area 0	Enable OSPFv3 routing on an interface, and assign the Area ID (0).
(config-if)#exit	Exit interface mode.
(config)#interface eth2	Enter interface mode.
(config-if)#ipv6 router ospf area 0	Enable OSPFv3 routing on an interface, and assign the Area ID (0).
(config-if)#ipv6 ospf cost 150	Set the cost of link-state metric to 150.
(config-router)#commit	Commit the candidate configuration to the running configuration.

R4

(config)#router ipv6 ospf	Create an OSPFv3 routing instance.
(config-router)#router-id 10.10.14.14	Specify a Router ID (10.10.14.14) for the OSPFv3 routing process.
(config-router)#exit	Exit OSPF router mode.
(config)#interface eth3	Enter interface mode.
(config-if)#ipv6 router ospf area 0	Enable OSPFv3 routing on an interface, and assign the Area ID (0).
(config-if)#exit	Exit interface mode.
(config)#interface eth1	Enter interface mode.
(config-if)#ipv6 router ospf area 0	Enable OSPFv3 routing on an interface, and assign the Area ID (0).
(config-router)#commit	Commit the candidate configuration to the running configuration.

Validation

R1

```
R1#show ipv6 ospf neighbor
OSPFv3 Process (*null*)
Neighbor ID      Pri   State           Dead Time   Interface   Instance ID
10.10.13.13     1    Full/Backup     00:00:37   eth1        0
10.10.11.11     1    Full/Backup     00:00:34   eth3        0
```

```
R1#show ipv6 ospfv3 topology
```

```
OSPFv3 Process (*null*)
OSPFv3 paths to Area (0.0.0.0) routers
Router ID      Bits  Metric   Next-Hop      Interface
10.10.10.10    --
10.10.11.11    1     1        10.10.11.11   eth3
10.10.13.13    1     1        10.10.13.13   eth1
10.10.14.14    101   101      10.10.11.11   eth3
```

```
rtr1#show ipv6 ospf database
```

```
OSPFv3 Router with ID (10.10.10.10) (Process *null*)
```

```
Link-LSA (Interface eth1)
```

Link State ID	ADV Router	Age	Seq#	CkSum	Prefix
0.0.0.3	10.10.10.10	868	0x80000003	0x4839	1
0.0.0.3	10.10.13.13	747	0x80000003	0x5544	1

```
Link-LSA (Interface eth3)
```

Link State ID	ADV Router	Age	Seq#	CkSum	Prefix
0.0.0.5	10.10.10.10	898	0x80000003	0xf33e	1
0.0.0.3	10.10.11.11	817	0x80000003	0xce7b	1

```
Router-LSA (Area 0.0.0.0)
```

Link State ID	ADV Router	Age	Seq#	CkSum	Link
0.0.0.0	10.10.10.10	58	0x80000008	0xabaf	2
0.0.0.0	10.10.11.11	1767	0x80000008	0x26cd	2
0.0.0.0	10.10.13.13	1753	0x80000008	0x9724	2
0.0.0.0	10.10.14.14	1753	0x80000007	0x96b5	2

```
Network-LSA (Area 0.0.0.0)
```

Link State ID	ADV Router	Age	Seq#	CkSum
0.0.0.3	10.10.10.10	58	0x80000003	0x4341
0.0.0.5	10.10.10.10	163	0x80000003	0xf88d
0.0.0.4	10.10.11.11	1767	0x80000002	0x5c22
0.0.0.4	10.10.13.13	1753	0x80000002	0x680e

```
Intra-Area-Prefix-LSA (Area 0.0.0.0)
```

Link State ID	ADV Router	Age	Seq#	CkSum	Prefix	Reference
0.0.0.1 LSA	10.10.10.10	813	0x80000003	0xd34b	1	Network-
0.0.0.2 LSA	10.10.10.10	743	0x80000003	0xcb53	1	Network-
0.0.0.2 LSA	10.10.11.11	652	0x80000003	0xf91f	1	Network-
0.0.0.3 LSA	10.10.13.13	684	0x80000003	0x22ec	1	Network-

```
Intra-Area-Te-LSA (Area 0.0.0.0)
```

Link State ID	ADV Router	Age	Seq#	CkSum
0.0.0.3	10.10.10.10	868	0x80000004	0x4fe8
0.0.0.5	10.10.10.10	898	0x80000004	0x39fb
0.0.0.3	10.10.11.11	817	0x80000004	0x72c1
0.0.0.4	10.10.11.11	802	0x80000005	0xe1ea
0.0.0.3	10.10.13.13	747	0x80000004	0x5ad6
0.0.0.4	10.10.13.13	727	0x80000005	0x8f02
0.0.0.3	10.10.14.14	688	0x80000004	0x2df8
0.0.0.5	10.10.14.14	653	0x80000004	0x9c8c

```
rtr1#show ipv6 ospf route
OSPFv3 Process (*null*)
Codes: C - connected, D - Discard, O - OSPF, IA - OSPF inter area
       N1 - OSPF NSSA external type 1, N2 - OSPF NSSA external type 2
       E1 - OSPF external type 1, E2 - OSPF external type 2
```

	Destination	Metric
C	3ffe:10::/64 Next-hop directly connected, eth3, Area 0.0.0.0	1
C	3ffe:11::/64 Next-hop directly connected, eth1, Area 0.0.0.0	1
O	3ffe:12::/64 Next-hop via fe80::a00:27ff:fef9:2432, eth3, Area 0.0.0.0	101
O	3ffe:13::/64 Next-hop via fe80::a00:27ff:fef9:2432, eth3, Area 0.0.0.0	102

```
rtr1#show ipv6 route
IPv6 Routing Table
Codes: K - kernel route, C - connected, S - static, R - RIP, O - OSPF,
       IA - OSPF inter area, E1 - OSPF external type 1,
       E2 - OSPF external type 2, N1 - OSPF NSSA external type 1,
       N2 - OSPF NSSA external type 2, I - IS-IS, B - BGP
Timers: Uptime
```

```
IP Route Table for VRF "default"
C      ::1/128 via ::, lo, 01:22:59
C      3ffe:10::/64 via ::, eth3, 00:51:14
C      3ffe:11::/64 via ::, eth1, 00:50:44
O      3ffe:12::/64 [110/101] via fe80::a00:27ff:fef9:2432, eth3, 00:49:33
O      3ffe:13::/64 [110/102] via fe80::a00:27ff:fef9:2432, eth3, 00:48:21
C      fe80::/64 via ::, eth1, 01:13:13
K      ff00::/8 [0/256] via ::, eth0, 01:22:47
```

R2

```
R2#show ipv6 ospf neighbor
OSPFv3 Process (*null*)
Neighbor ID      Pri   State                Dead Time   Interface   Instance ID
10.10.10.10     1    Full/DR              00:00:32   eth1        0
10.10.14.14     1    Full/Backup          00:00:33   eth2        0
```

```
R2#show ipv6 ospfv3 topology
```

```
OSPFv3 Process (*null*)
OSPFv3 paths to Area (0.0.0.0) routers
Router ID      Bits  Metric  Next-Hop      Interface
10.10.10.10    1     1       10.10.10.10   eth1
10.10.11.11    --    --
```

```

10.10.13.13          2          10.10.10.10          eth1
10.10.14.14          100         10.10.14.14          eth2

```

```
R2#show ipv6 ospf database
```

```
OSPFv3 Router with ID (10.10.11.11) (Process *null*)
```

```
Link-LSA (Interface eth1)
```

```

Link State ID  ADV Router      Age      Seq#      CkSum  Prefix
0.0.0.5        10.10.10.10    1373    0x80000003 0xf33e  1
0.0.0.3        10.10.11.11    1290    0x80000003 0xce7b  1

```

```
Link-LSA (Interface eth2)
```

```

Link State ID  ADV Router      Age      Seq#      CkSum  Prefix
0.0.0.4        10.10.11.11    1275    0x80000003 0x802a  1
0.0.0.5        10.10.14.14    1126    0x80000003 0x4f29  1

```

```
Router-LSA (Area 0.0.0.0)
```

```

Link State ID  ADV Router      Age      Seq#      CkSum  Link
0.0.0.0        10.10.10.10    533     0x80000008 0xabaf  2
0.0.0.0        10.10.11.11    440     0x80000009 0x24ce  2
0.0.0.0        10.10.13.13    427     0x80000009 0x9525  2
0.0.0.0        10.10.14.14    426     0x80000008 0x94b6  2

```

```
Network-LSA (Area 0.0.0.0)
```

```

Link State ID  ADV Router      Age      Seq#      CkSum
0.0.0.3        10.10.10.10    533     0x80000003 0x4341
0.0.0.5        10.10.10.10    638     0x80000003 0xf88d
0.0.0.4        10.10.11.11    440     0x80000003 0x5a23
0.0.0.4        10.10.13.13    427     0x80000003 0x660f

```

```
Intra-Area-Prefix-LSA (Area 0.0.0.0)
```

```

Link State ID  ADV Router      Age      Seq#      CkSum  Prefix  Reference
0.0.0.1        10.10.10.10    1288    0x80000003 0xd34b  1  Network-
LSA
0.0.0.2        10.10.10.10    1218    0x80000003 0xcb53  1  Network-
LSA
0.0.0.2        10.10.11.11    1125    0x80000003 0xf91f  1  Network-
LSA
0.0.0.3        10.10.13.13    1158    0x80000003 0x22ec  1  Network-
LSA

```

```
Intra-Area-Te-LSA (Area 0.0.0.0)
```

```

Link State ID  ADV Router      Age      Seq#      CkSum
0.0.0.3        10.10.10.10    1343    0x80000004 0x4fe8
0.0.0.5        10.10.10.10    1373    0x80000004 0x39fb
0.0.0.3        10.10.11.11    1290    0x80000004 0x72c1
0.0.0.4        10.10.11.11    1275    0x80000005 0xe1ea
0.0.0.3        10.10.13.13    1223    0x80000004 0x5ad6
0.0.0.4        10.10.13.13    1203    0x80000005 0x8f02

```

OSPFv3

```
0.0.0.3          10.10.14.14      1161          0x80000004 0x2df8
0.0.0.5          10.10.14.14      1126          0x80000004 0x9c8c
```

R2#show ipv6 ospf route

OSPFv3 Process (*null*)

Codes: C - connected, D - Discard, O - OSPF, IA - OSPF inter area
N1 - OSPF NSSA external type 1, N2 - OSPF NSSA external type 2
E1 - OSPF external type 1, E2 - OSPF external type 2

	Destination	Metric
C	3ffe:10::/64 directly connected, eth1, Area 0.0.0.0	1
O	3ffe:11::/64 via fe80::a00:27ff:fe6e:21d8, eth1, Area 0.0.0.0	2
C	3ffe:12::/64 directly connected, eth2, Area 0.0.0.0	100
O	3ffe:13::/64 via fe80::a00:27ff:fe01:c94d, eth2, Area 0.0.0.0	101

R2#show ipv6 route

IPv6 Routing Table

Codes: K - kernel route, C - connected, S - static, R - RIP, O - OSPF,
IA - OSPF inter area, E1 - OSPF external type 1,
E2 - OSPF external type 2, N1 - OSPF NSSA external type 1,
N2 - OSPF NSSA external type 2, I - IS-IS, B - BGP

Timers: Uptime

IP Route Table for VRF "default"

```
C    ::1/128 via ::, lo, 01:26:25
C    3ffe:10::/64 via ::, eth1, 00:54:14
O    3ffe:11::/64 [110/2] via fe80::a00:27ff:fe6e:21d8, eth1, 00:55:03
C    3ffe:12::/64 via ::, eth2, 00:53:58
O    3ffe:13::/64 [110/101] via fe80::a00:27ff:fe01:c94d, eth2, 00:52:43
C    fe80::/64 via ::, eth2, 01:20:38
K    ff00::/8 [0/256] via ::, eth2, 01:20:39
```

R3

R3#show ipv6 ospf neighbor

OSPFv3 Process (*null*)

Neighbor ID	Pri	State	Dead Time	Interface	Instance ID
10.10.10.10	1	Full/DR	00:00:33	eth1	0
10.10.14.14	1	Full/Backup	00:00:38	eth2	0

R3#show ipv6 ospfv3 topology

OSPFv3 Process (*null*)

OSPFv3 paths to Area (0.0.0.0) routers

Router ID	Bits	Metric	Next-Hop	Interface
10.10.10.10		1	10.10.10.10	eth1
10.10.11.11		2	10.10.10.10	eth1
10.10.13.13		--		

```
10.10.14.14          102          10.10.10.10          eth1
```

```
R3#
```

```
R3#show ipv6 ospf database
```

```
OSPFv3 Router with ID (10.10.13.13) (Process *null*)
```

```
Link-LSA (Interface eth1)
```

Link State ID	ADV Router	Age	Seq#	CkSum	Prefix
0.0.0.3	10.10.10.10	1591	0x80000003	0x4839	1
0.0.0.3	10.10.13.13	1468	0x80000003	0x5544	1

```
Link-LSA (Interface eth2)
```

Link State ID	ADV Router	Age	Seq#	CkSum	Prefix
0.0.0.4	10.10.13.13	1448	0x80000003	0x9d29	1
0.0.0.3	10.10.14.14	1409	0x80000003	0x50cf	1

```
Router-LSA (Area 0.0.0.0)
```

Link State ID	ADV Router	Age	Seq#	CkSum	Link
0.0.0.0	10.10.10.10	780	0x80000008	0xabaf	2
0.0.0.0	10.10.11.11	689	0x80000009	0x24ce	2
0.0.0.0	10.10.13.13	673	0x80000009	0x9525	2
0.0.0.0	10.10.14.14	673	0x80000008	0x94b6	2

```
Network-LSA (Area 0.0.0.0)
```

Link State ID	ADV Router	Age	Seq#	CkSum
0.0.0.3	10.10.10.10	780	0x80000003	0x4341
0.0.0.5	10.10.10.10	885	0x80000003	0xf88d
0.0.0.4	10.10.11.11	689	0x80000003	0x5a23
0.0.0.4	10.10.13.13	673	0x80000003	0x660f

```
Intra-Area-Prefix-LSA (Area 0.0.0.0)
```

Link State ID	ADV Router	Age	Seq#	CkSum	Prefix	Reference
0.0.0.1 LSA	10.10.10.10	1536	0x80000003	0xd34b	1	Network-
0.0.0.2 LSA	10.10.10.10	1466	0x80000003	0xcb53	1	Network-
0.0.0.2 LSA	10.10.11.11	1374	0x80000003	0xf91f	1	Network-
0.0.0.3 LSA	10.10.13.13	1403	0x80000003	0x22ec	1	Network-

```
Intra-Area-Te-LSA (Area 0.0.0.0)
```

Link State ID	ADV Router	Age	Seq#	CkSum
0.0.0.3	10.10.10.10	1591	0x80000004	0x4fe8
0.0.0.5	10.10.10.10	1621	0x80000004	0x39fb
0.0.0.3	10.10.11.11	1539	0x80000004	0x72c1
0.0.0.4	10.10.11.11	1524	0x80000005	0xe1ea
0.0.0.3	10.10.13.13	1468	0x80000004	0x5ad6
0.0.0.4	10.10.13.13	1448	0x80000005	0x8f02
0.0.0.3	10.10.14.14	1409	0x80000004	0x2df8

```
0.0.0.5          10.10.14.14      1374          0x80000004 0x9c8c
```

```
R3#show ipv6 ospf route
```

```
OSPFv3 Process (*null*)
```

```
Codes: C - connected, D - Discard, O - OSPF, IA - OSPF inter area
```

```
       N1 - OSPF NSSA external type 1, N2 - OSPF NSSA external type 2
```

```
       E1 - OSPF external type 1, E2 - OSPF external type 2
```

```

Destination                                Metric
Next-hop
O 3ffe:10::/64                              2
   via fe80::a00:27ff:fe7d:2a72, eth1, Area 0.0.0.0
C 3ffe:11::/64                              1
   directly connected, eth1, Area 0.0.0.0
O 3ffe:12::/64                              102
   via fe80::a00:27ff:fe7d:2a72, eth1, Area 0.0.0.0
O 3ffe:13::/64                              103
   via fe80::a00:27ff:fe7d:2a72, eth1, Area 0.0.0.0
```

```
R3#show ipv6 route
```

```
IPv6 Routing Table
```

```
Codes: K - kernel route, C - connected, S - static, R - RIP, O - OSPF,
```

```
       IA - OSPF inter area, E1 - OSPF external type 1,
```

```
       E2 - OSPF external type 2, N1 - OSPF NSSA external type 1,
```

```
       N2 - OSPF NSSA external type 2, I - IS-IS, B - BGP
```

```
Timers: Uptime
```

```
IP Route Table for VRF "default"
```

```

C   ::1/128 via ::, lo, 01:28:16
O   3ffe:10::/64 [110/2] via fe80::a00:27ff:fe7d:2a72, eth1, 00:58:14
C   3ffe:11::/64 via ::, eth1, 00:55:44
O   3ffe:12::/64 [110/102] via fe80::a00:27ff:fe7d:2a72, eth1, 00:56:36
C   3ffe:13::/64 via ::, eth2, 00:55:26
C   fe80::/64 via ::, eth1, 01:20:39
K   ff00::/8 [0/256] via ::, eth2, 01:21:40
```

R4

```
R4#show ipv6 ospf neighbor
```

```
OSPFv3 Process (*null*)
```

Neighbor ID	Pri	State	Dead Time	Interface	Instance ID
10.10.13.13	1	Full/DR	00:00:30	eth1	0
10.10.11.11	1	Full/DR	00:00:30	eth3	0

```
R4#show ipv6 ospfv3 topology
```

```
OSPFv3 Process (*null*)
```

```
OSPFv3 paths to Area (0.0.0.0) routers
```

Router ID	Bits	Metric	Next-Hop	Interface
10.10.10.10		2	10.10.11.11	eth3
			10.10.13.13	eth1
10.10.11.11		1	10.10.11.11	eth3

```

10.10.13.13          1          10.10.13.13          eth1
10.10.14.14         --

```

R4#show ipv6 ospf database

OSPFv3 Router with ID (10.10.14.14) (Process *null*)

Link-LSA (Interface eth1)

Link State ID	ADV Router	Age	Seq#	CkSum	Prefix
0.0.0.4	10.10.13.13	1634	0x80000003	0x9d29	1
0.0.0.3	10.10.14.14	1592	0x80000003	0x50cf	1

Link-LSA (Interface eth3)

Link State ID	ADV Router	Age	Seq#	CkSum	Prefix
0.0.0.4	10.10.11.11	1708	0x80000003	0x802a	1
0.0.0.5	10.10.14.14	1557	0x80000003	0x4f29	1

Router-LSA (Area 0.0.0.0)

Link State ID	ADV Router	Age	Seq#	CkSum	Link
0.0.0.0	10.10.10.10	966	0x80000008	0xabaf	2
0.0.0.0	10.10.11.11	873	0x80000009	0x24ce	2
0.0.0.0	10.10.13.13	859	0x80000009	0x9525	2
0.0.0.0	10.10.14.14	857	0x80000008	0x94b6	2

Network-LSA (Area 0.0.0.0)

Link State ID	ADV Router	Age	Seq#	CkSum
0.0.0.3	10.10.10.10	966	0x80000003	0x4341
0.0.0.5	10.10.10.10	1071	0x80000003	0xf88d
0.0.0.4	10.10.11.11	873	0x80000003	0x5a23
0.0.0.4	10.10.13.13	859	0x80000003	0x660f

Intra-Area-Prefix-LSA (Area 0.0.0.0)

Link State ID	ADV Router	Age	Seq#	CkSum	Prefix	Reference
0.0.0.1 LSA	10.10.10.10	1721	0x80000003	0xd34b	1	Network-
0.0.0.2 LSA	10.10.10.10	1651	0x80000003	0xcb53	1	Network-
0.0.0.2 LSA	10.10.11.11	1558	0x80000003	0xf91f	1	Network-
0.0.0.3 LSA	10.10.13.13	1589	0x80000003	0x22ec	1	Network-

Intra-Area-Te-LSA (Area 0.0.0.0)

Link State ID	ADV Router	Age	Seq#	CkSum
0.0.0.3	10.10.10.10	1776	0x80000004	0x4fe8
0.0.0.5	10.10.10.10	6	0x80000005	0x37fc
0.0.0.3	10.10.11.11	1723	0x80000004	0x72c1
0.0.0.4	10.10.11.11	1708	0x80000005	0xe1ea
0.0.0.3	10.10.13.13	1654	0x80000004	0x5ad6
0.0.0.4	10.10.13.13	1634	0x80000005	0x8f02

```

0.0.0.3          10.10.14.14      1592          0x80000004 0x2df8
0.0.0.5          10.10.14.14      1557          0x80000004 0x9c8c

```

```

R4#show ipv6 ospf route
OSPFv3 Process (*null*)
Codes: C - connected, D - Discard, O - OSPF, IA - OSPF inter area
       N1 - OSPF NSSA external type 1, N2 - OSPF NSSA external type 2
       E1 - OSPF external type 1, E2 - OSPF external type 2

```

```

      Destination                               Metric
      Next-hop
O  3ffe:10::/64                                 2
   via fe80::a00:27ff:fe0d:fbe3, eth3, Area 0.0.0.0
O  3ffe:11::/64                                 2
   via fe80::a00:27ff:fe0d:fecf:8873, eth1, Area 0.0.0.0
C  3ffe:12::/64                                 1
   directly connected, eth3, Area 0.0.0.0
C  3ffe:13::/64                                 1
   directly connected, eth1, Area 0.0.0.0

```

```

R4#show ipv6 route
IPv6 Routing Table
Codes: K - kernel route, C - connected, S - static, R - RIP, O - OSPF,
       IA - OSPF inter area, E1 - OSPF external type 1,
       E2 - OSPF external type 2, N1 - OSPF NSSA external type 1,
       N2 - OSPF NSSA external type 2, I - IS-IS, B - BGP
Timers: Uptime

```

```

IP Route Table for VRF "default"
C  ::1/128 via ::, lo, 01:32:01
O  3ffe:10::/64 [110/2] via fe80::a00:27ff:fe0d:fbe3, eth3, 01:02:49
O  3ffe:11::/64 [110/2] via fe80::a00:27ff:fe0d:fecf:8873, eth1, 01:02:19
C  3ffe:12::/64 via ::, eth3, 00:58:46
C  3ffe:13::/64 via ::, eth1, 00:59:18
C  fe80::/64 via ::, eth1, 01:27:01
K  ff00::/8 [0/256] via ::, eth3, 01:27:31

```

Virtual Links

Virtual links are used to connect a temporarily-disjointed non-backbone area to the backbone area, or to repair a non-contiguous backbone area. In this example, the ABR R3 has temporarily lost connection to Area 0, in turn disconnecting Area 2 from the backbone area. The virtual link between ABR R1 and ABR R2 connects Area 2 to Area 0. Area 1 is used as a transit area.

Topology

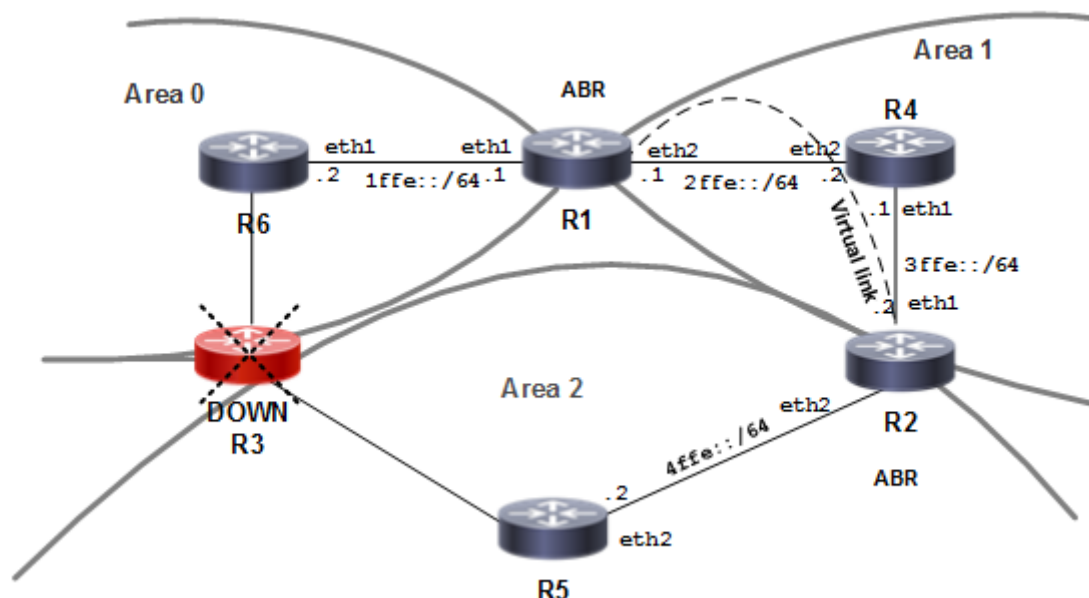

Figure 12-91: OSPFv3 Virtual Links

Configuration

R1

#configure terminal	Enter configure mode.
(config)#interface lo	Setup loopback interface
(config-if)#ip address 1.1.1.1/32 secondary	Specify loopback interface address
(config)#interface eth1	Enter interface mode.
(config-if)#ipv6 router ospf area 0	Enable OSPFv3 routing on this interface, and assign the Area ID (0).
(config-if)#exit	Exit interface mode.
(config)#interface eth2	Enter interface mode.
(config-if)#ipv6 router ospf area 1	Enable OSPFv3 routing on this interface, and assign the Area ID (1).
(config-if)#exit	Exit interface mode.
(config)#router ipv6 ospf	Create an OSPFv3 routing instance.
(config-router)#router-id 1.1.1.1	Specify a Router ID (1.1.1.1) for the OSPFv3 routing process.
(config-router)#area 1 virtual-link 2.2.2.2	Configure a virtual link between this router R1 and R2 (Router ID 2.2.2.2) through transit area 1.
(config-router)#commit	Commit the candidate configuration to the running configuration.

R2

#configure terminal	Enter configure mode.
(config)#interface lo	Setup loopback interface
(config-if)#ip address 2.2.2.2/32 secondary	Specify loopback interface address
(config)#interface eth1	Enter interface mode.
(config-if)#ipv6 router ospf area 1	Enable OSPFv3 routing on this interface, and assign the Area ID (1).
(config-if)#exit	Exit interface mode.
(config)#interface eth2	Enter interface mode.
(config-if)#ipv6 router ospf area 2	Enable OSPFv3 routing on this interface, and assign the Area ID (2).
(config-if)#exit	Exit interface mode.
(config)#router ipv6 ospf	Create an OSPFv3 routing instance.
(config-router)#router-id 2.2.2.2	Specify a Router ID (2.2.2.2) for the OSPFv3 routing process.
(config-router)#area 1 virtual-link 1.1.1.1	Configure a virtual link between this router R1 and R2 (Router ID 1.1.1.1) through transit area 1.
(config-router)#commit	Commit the candidate configuration to the running configuration.

R4

#configure terminal	Enter configure mode.
(config)#interface eth1	Enter interface mode.
(config-if)#ipv6 router ospf area 1	Enable OSPFv3 routing on this interface, and assign the Area ID (1).
(config-if)#exit	Exit interface mode.
(config)#interface eth2	Enter interface mode.
(config-if)#ipv6 router ospf area 1	Enable OSPFv3 routing on this interface, and assign the Area ID (1).
(config-if)#exit	Exit interface mode.
(config)#router ipv6 ospf	Create an OSPFv3 routing instance.
(config-router)#router-id 4.4.4.4	Specify a Router ID (4.4.4.4) for the OSPFv3 routing process.
(config-router)#commit	Commit the candidate configuration to the running configuration.

R5

#configure terminal	Enter configure mode.
(config)#interface eth2	Enter interface mode.
(config-if)#ipv6 router ospf area 2	Enable OSPFv3 routing on this interface, and assign the Area ID (2).
(config-if)#exit	Exit interface mode.

(config)#router ipv6 ospf	Create an OSPFv3 routing instance.
(config-router)#router-id 5.5.5.5	Specify a Router ID (5.5.5.5) for the OSPFv3 routing process.
(config-router)#commit	Commit the candidate configuration to the running configuration.

R6

#configure terminal	Enter configure mode.
(config)#interface eth1	Enter interface mode.
(config-if)#ipv6 router ospf area 0	Enable OSPFv3 routing on this interface, and assign the Area ID (0).
(config-if)#exit	Exit interface mode.
(config)#router ipv6 ospf	Create an OSPFv3 routing instance.
(config-router)#router-id 6.6.6.6	Specify a Router ID (6.6.6.6) for the OSPFv3 routing process.
(config-router)#commit	Commit the candidate configuration to the running configuration.

Validation**R2**

```
#show ipv6 ospf n
OSPFv3 Process (*null*)
Neighbor ID      Pri   State             Dead Time   Interface   Instance ID
10.10.10.10     1    Full/DR           00:00:31   eth1        0
3.3.3.3         1    Full/DR           00:00:32   eth2        0
2.2.2.2         1    Full/ -           inactive    VLINK2147479553 0
```

```
#show ipv6 ospf virtual-links
Virtual Link VLINK2147479553 to router 2.2.2.2 is up
  Transit area 0.0.0.1 via interface eth2, instance ID 0
  Hello suppression Enabled
  DoNotAge LSA allowed
  Local address 2ffe::11/128
  Remote address 3ffe::11/128
  Transmit Delay is 1 sec, State Point-To-Point,
  Timer intervals configured, Hello 10, Dead 40, Wait 40, Retransmit 5
  Hello due in inactive
  Adajcency state Full
```

```
# show ipv6 ospf
Routing Process "OSPFv3 (*null*)" with ID 1.1.1.1
Process uptime is 5 minutes
This router is an ABR, ABR Type is Alternative Cisco (RFC3509)
This router is an ASBR (injecting external routing information)
```

OSPFv3

```
SPF schedule delay initial 0.500 secs
SPF schedule delay min 0.500 secs
SPF schedule delay max 50.0 secs
Minimum LSA interval 5 secs, Minimum LSA arrival 1 secs
Number of incoming current DD exchange neighbors 0/5
Number of outgoing current DD exchange neighbors 0/5
Number of external LSA 0. Checksum Sum 0x0000
Number of AS-Scoped Unknown LSA 0
Number of LSA originated 17
Number of LSA received 50
Number of areas in this router is 2
  Area BACKBONE(0)
    Number of interfaces in this area is 2(2)
    SPF algorithm executed 8 times
    Number of LSA 23. Checksum Sum 0xB35D8
    Number of Unknown LSA 0
  Area 0.0.0.1
    Number of interfaces in this area is 1(1)
    SPF algorithm executed 13 times
    Number of LSA 16. Checksum Sum 0x7845A
    Number of Unknown LSA 0
Dste Staus: Disabled
```

```
#show ipv6 ospf route
OSPFv3 Process (*null*)
Codes: C - connected, D - Discard, O - OSPF, IA - OSPF inter area
       N1 - OSPF NSSA external type 1, N2 - OSPF NSSA external type 2
       E1 - OSPF external type 1, E2 - OSPF external type 2
```

	Destination	Metric
	Next-hop	
C	1ffe::/64	1
	directly connected, eth1, Area 0.0.0.0	
C	2ffe::/64	1
	directly connected, eth2, TransitArea 0.0.0.1	
C	2ffe::11/128	0
	directly connected, eth2, TransitArea 0.0.0.1	
O	3ffe::/64	1
	directly connected, eth2, TransitArea 0.0.0.1	
O	3ffe::11/128	2
	via fe80::5054:ff:fe6f:334d, eth2, TransitArea 0.0.0.1	
IA	4ffe::/64	3
	via fe80::5054:ff:fe6f:334d, eth2, TransitArea 0.0.0.1	
#		

R3

```
#show ipv6 ospf n
OSPFv3 Process (*null*)
Neighbor ID      Pri   State                Dead Time   Interface   Instance ID
```

```

1.1.1.1          1    Full/Backup    00:00:35    eth1        0
2.2.2.2          1    Full/Backup    00:00:30    eth2        0

```

```
# show ipv6 ospf
```

```

Routing Process "OSPFv3 (*null*)" with ID 3.3.3.3
Process uptime is 5 minutes
This router is an ASBR (injecting external routing information)
SPF schedule delay initial 0.500 secs
SPF schedule delay min 0.500 secs
SPF schedule delay max 50.0 secs
Minimum LSA interval 5 secs, Minimum LSA arrival 1 secs
Number of incoming current DD exchange neighbors 0/5
Number of outgoing current DD exchange neighbors 0/5
Number of external LSA 0. Checksum Sum 0x0000
Number of AS-Scoped Unknown LSA 0
Number of LSA originated 10
Number of LSA received 23
Number of areas in this router is 1
  Area 0.0.0.1
    Number of interfaces in this area is 2(2)
    SPF algorithm executed 14 times
    Number of LSA 16. Checksum Sum 0x7845A
    Number of Unknown LSA 0
Dste Staus: Disabled

```

```
#show ipv6 ospf route
```

```

OSPFv3 Process (*null*)
Codes: C - connected, D - Discard, O - OSPF, IA - OSPF inter area
       N1 - OSPF NSSA external type 1, N2 - OSPF NSSA external type 2
       E1 - OSPF external type 1, E2 - OSPF external type 2

```

Destination	Metric
Next-hop	
IA 1ffe::/64	2
via fe80::5054:ff:feb7:cc69, eth1, TransitArea 0.0.0.1	
C 2ffe::/64	1
directly connected, eth2, TransitArea 0.0.0.1	
O 2ffe::11/128	1
via fe80::5054:ff:feb7:cc69, eth1, TransitArea 0.0.0.1	
C 3ffe::/64	1
directly connected, eth1, TransitArea 0.0.0.1	
O 3ffe::11/128	1
via fe80::5054:ff:fec5:2430, eth2, TransitArea 0.0.0.1	
IA 4ffe::/64	2
via fe80::5054:ff:fec5:2430, eth2, TransitArea 0.0.0.1	

R4

```
#show ipv6 ospf n
```

OSPFv3

OSPFv3 Process (*null*)

Neighbor ID	Pri	State	Dead Time	Interface	Instance ID
3.3.3.3	1	Full/DR	00:00:31	eth1	0
1.1.1.1	1	Full/ -	inactive	VLINK2147479554	0

#show ipv6 ospf virtual-links

Virtual Link VLINK2147479554 to router 1.1.1.1 is up
Transit area 0.0.0.1 via interface eth1, instance ID 0
Hello suppression Enabled
DoNotAge LSA allowed
Local address 3ffe::11/128
Remote address 2ffe::11/128
Transmit Delay is 1 sec, State Point-To-Point,
Timer intervals configured, Hello 10, Dead 40, Wait 40, Retransmit 5
Hello due in inactive
Adjacency state Full

show ipv6 ospf

Routing Process "OSPFv3 (*null*)" with ID 2.2.2.2
Process uptime is 4 minutes
This router is an ABR, ABR Type is Alternative Cisco (RFC3509)
This router is an ASBR (injecting external routing information)
SPF schedule delay initial 0.500 secs
SPF schedule delay min 0.500 secs
SPF schedule delay max 50.0 secs
Minimum LSA interval 5 secs, Minimum LSA arrival 1 secs
Number of incoming current DD exchange neighbors 0/5
Number of outgoing current DD exchange neighbors 0/5
Number of external LSA 0. Checksum Sum 0x0000
Number of AS-Scoped Unknown LSA 0
Number of LSA originated 26
Number of LSA received 37
Number of areas in this router is 3
 Area BACKBONE(0)
 Number of interfaces in this area is 1(1)
 SPF algorithm executed 3 times
 Number of LSA 23. Checksum Sum 0xB35D8
 Number of Unknown LSA 0
 Area 0.0.0.1
 Number of interfaces in this area is 1(1)
 SPF algorithm executed 11 times
 Number of LSA 16. Checksum Sum 0x7845A
 Number of Unknown LSA 0
 Area 0.0.0.2
 Number of interfaces in this area is 1(1)
 SPF algorithm executed 4 times
 Number of LSA 11. Checksum Sum 0x5D8B7
 Number of Unknown LSA 0

Dste Staus: Disabled

```
#show ipv6 ospf route
OSPFv3 Process (*null*)
Codes: C - connected, D - Discard, O - OSPF, IA - OSPF inter area
       N1 - OSPF NSSA external type 1, N2 - OSPF NSSA external type 2
       E1 - OSPF external type 1, E2 - OSPF external type 2
```

Destination	Metric
Next-hop	
O 1ffe::/64	3
via fe80::5054:ff:feld:eace, eth1, TransitArea 0.0.0.1	
O 2ffe::/64	1
directly connected, eth1, TransitArea 0.0.0.1	
O 2ffe::11/128	2
via fe80::5054:ff:feld:eace, eth1, TransitArea 0.0.0.1	
C 3ffe::/64	1
directly connected, eth1, TransitArea 0.0.0.1	
C 3ffe::11/128	0
directly connected, eth1, TransitArea 0.0.0.1	
C 4ffe::/64	1
directly connected, eth2, Area 0.0.0.2	

Multiple Instances

By using multiple OSPFv3 instances, OSPFv3 routes can be segregated, based on their instance number. Routes of one instance are stored differently from routes of another instance running in the same router.

To configure multiple OSPFv3 instances, refer to the topology diagram and follow the procedures below.

1. Enable OSPFv3 on an interface.
2. Enable multiple instances.
3. Configure redistribution among multiple instances.

Note: Optionally, redistribution can be configured with the metric, type, or route-map options.

Topology

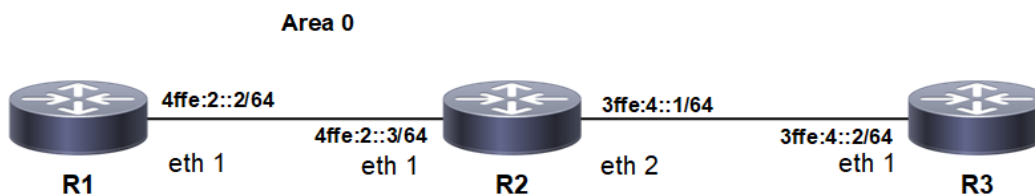

Enable Multiple OSPFv3 Instances on a Router Based on Tags

In this example, routers R1, R2, and R3 are in Area 0, and all run OSPFv3.

R1

<code>(config)#router ipv6 ospf 5</code>	Configure an OSPFv3 instance with an instance ID of 5.
<code>(config-router)#router-id 5.5.5.5</code>	Configure the router ID to use on this instance.
<code>(config-router)#exit</code>	Exit Router mode, and return to Interface mode.
<code>(config)#interface eth1</code>	Specify the interface on which OSPFv3 is to be enabled.
<code>(config-if)#ipv6 address 4ffe:2::2/64</code>	Configure the IPv6 address.
<code>(config-if)#ipv6 router ospf area 0 tag 5</code>	Configure the area number and instance value: match the instance ID with the instance ID created previously.
<code>(config-if)#no shutdown</code>	Activate the interface.
<code>(config-if)#commit</code>	Commit the candidate configuration to the running configuration.

R2

<code>(config)#router ipv6 ospf 5</code>	Configure an OSPFv3 instance with an instance ID of 5.
<code>(config-router)#router-id 149.149.149.149</code>	Configure the router ID to use on this instance.
<code>(config-router)#exit</code>	Exit Router mode, and return to Interface mode.
<code>(config)#interface eth1</code>	Configure the interface to connect to R1.
<code>(config-if)#ipv6 address 4ffe:2::3/64</code>	Configure the IPv6 address.
<code>(config-if)#ipv6 router ospf area 0 tag 5</code>	Configure the area number and instance value: match the instance ID with the instance ID created previously.
<code>(config-if)#no shutdown</code>	Activate the interface.
<code>(config-if)#commit</code>	Commit the candidate configuration to the running configuration.
<code>(config-if)#exit</code>	Exit Interface mode, and return to Configure terminal mode.
<code>(config)#router ipv6 ospf 15</code>	Configure an OSPFv3 instance with an instance ID of 15.
<code>(config-router)#router-id 159.159.159.159</code>	Configure the router ID to use on this instance.
<code>(config-router)#exit</code>	Exit Router mode, and return to Interface mode.
<code>(config)#interface eth2</code>	Configure the interface to connect to R3.
<code>(config-if)#ipv6 address 3ffe:4::1/64</code>	Configure the IPv6 address.
<code>(config-if)#no shutdown</code>	Activate the interface.
<code>(config-if)#ipv6 router ospf area 0 tag 15</code>	Configure the area number and instance value: match the instance ID with the instance ID created previously.
<code>(config-if)#commit</code>	Commit the candidate configuration to the running configuration.

R3

<code>(config)#router ipv6 ospf 15</code>	Configure an OSPFv3 instance with an instance ID of 15.
<code>(config-router)#router-id 152.152.152.152</code>	Configure the router ID to use on this instance.

(config-router)#exit	Exit Router mode, and return to Interface mode.
(config)#interface eth1	Specify the interface on which OSPFv3 is to be enabled.
(config-if)#ipv6 address 3ffe:4::2/64	Configure the IPv6 address.
(config-if)#ipv6 router ospf area 0 tag 15	Configure the area number and instance value: match the instance ID with the instance ID created previously.
(config-if)#no shutdown	Activate the interface.
(config-if)#commit	Commit the candidate configuration to the running configuration.

Validation

R1

```
R1#show ipv6 ospf route
OSPFv3 Process (5)
Codes: C - connected, D - Discard, O - OSPF, IA - OSPF inter area
       N1 - OSPF NSSA external type 1, N2 - OSPF NSSA external type 2
       E1 - OSPF external type 1, E2 - OSPF external type 2
```

```

Destination                                Metric
Next-hop
C 4ffe:2::/64                               1
   directly connected, eth1, Area 0.0.0.0
```

```
R1#show ipv6 ospf neighbor
OSPFv3 Process (5)
Neighbor ID   Pri   State           Dead Time   Interface   Instance ID
149.149.149.149  1   Full/Backup     00:00:32   eth1        0
```

R2

```
R2#show ipv6 ospf route
OSPFv3 Process (15)
Codes: C - connected, D - Discard, O - OSPF, IA - OSPF inter area
       N1 - OSPF NSSA external type 1, N2 - OSPF NSSA external type 2
       E1 - OSPF external type 1, E2 - OSPF external type 2
```

```

Destination                                Metric
Next-hop
C 3ffe:4::/64                               1
   directly connected, eth2, Area 0.0.0.0
```

```
OSPFv3 Process (5)
Codes: C - connected, D - Discard, O - OSPF, IA - OSPF inter area
       N1 - OSPF NSSA external type 1, N2 - OSPF NSSA external type 2
       E1 - OSPF external type 1, E2 - OSPF external type 2
```

```

Destination                                Metric
Next-hop
C 4ffe:2::/64                               1
   directly connected, eth1, Area 0.0.0.0
```

```
R2#sh ipv6 ospf neighbor
OSPFv3 Process (15)
Neighbor ID   Pri   State           Dead Time   Interface   Instance ID
```

OSPFv3

```
152.152.152.152 1 Full/DR 00:00:35 eth2 0
OSPFv3 Process (5)
Neighbor ID Pri State Dead Time Interface Instance ID
5.5.5.5 1 Full/DR 00:00:33 eth1 0
```

R3

```
R3#show ipv6 ospf route
OSPFv3 Process (15)
Codes: C - connected, D - Discard, O - OSPF, IA - OSPF inter area
N1 - OSPF NSSA external type 1, N2 - OSPF NSSA external type 2
E1 - OSPF external type 1, E2 - OSPF external type 2
```

```
Destination Metric
Next-hop
C 3ffe:4::/64 1
directly connected, eth1, Area 0.0.0.0
```

```
R3#sh ipv6 ospf neighbor
OSPFv3 Process (15)
Neighbor ID Pri State Dead Time Interface Instance ID
159.159.159.159 1 Full/Backup 00:00:34 eth1 0
```

Redistribute among Multiple Instances

In this example, routes of one ospfv3 instance are redistributed to another ospfv3 instance to enable ping from R1 to R3 or vice-versa; and R2 redistributes routes from one instance to another.

R2

(config)#router ipv6 ospf 15	Configure an OSPFv3 instance with instance ID 15.
(config-router)#router-id 159.159.159.159	Configure the router ID.
(config-router)#redistribute ospf 5	Redistribute instance 5 routes.
(config-router)#exit	Exit OSPF router mode.
(config)#router ipv6 ospf 5	Configure an OSPFv3 instance with instance ID 5.
(config-router)#router-id 149.149.149.149	Configure the router ID.
(config-router)#redistribute ospf 15	Redistribute instance 15 routes.
(config-router)#commit	Commit the candidate configuration to the running configuration.

Validation

R1

```
R1#show ipv6 ospf route
OSPFv3 Process (5)
Codes: C - connected, D - Discard, O - OSPF, IA - OSPF inter area
N1 - OSPF NSSA external type 1, N2 - OSPF NSSA external type 2
E1 - OSPF external type 1, E2 - OSPF external type 2
```

```
Destination Metric
Next-hop
```

```
E2 3ffe:4::/64                                1/20
    via fe80::a00:27ff:fef9:2432, eth1
C 4ffe:2::/64                                1
    directly connected, eth1, Area 0.0.0.0
```

```
rtr1#show ipv6 ospf neighbor
```

```
OSPFv3 Process (5)
```

Neighbor ID	Pri	State	Dead Time	Interface	Instance ID
149.149.149.149	1	Full/Backup	00:00:32	eth1	0

R2

```
R2#show ipv6 ospf route
```

```
OSPFv3 Process (15)
```

```
Codes: C - connected, D - Discard, O - OSPF, IA - OSPF inter area
       N1 - OSPF NSSA external type 1, N2 - OSPF NSSA external type 2
       E1 - OSPF external type 1, E2 - OSPF external type 2
```

Destination	Metric
Next-hop	
C 3ffe:4::/64	1
directly connected, eth2, Area 0.0.0.0	

```
OSPFv3 Process (5)
```

```
Codes: C - connected, D - Discard, O - OSPF, IA - OSPF inter area
       N1 - OSPF NSSA external type 1, N2 - OSPF NSSA external type 2
       E1 - OSPF external type 1, E2 - OSPF external type 2
```

Destination	Metric
Next-hop	
C 4ffe:2::/64	1
directly connected, eth1, Area 0.0.0.0	

```
R2#show ipv6 ospf neighbor
```

```
OSPFv3 Process (15)
```

Neighbor ID	Pri	State	Dead Time	Interface	Instance ID
152.152.152.152	1	Full/DR	00:00:34	eth2	0

```
OSPFv3 Process (5)
```

Neighbor ID	Pri	State	Dead Time	Interface	Instance ID
5.5.5.5	1	Full/DR	00:00:30	eth1	0

R3

```
R3#show ipv6 ospf route
```

```
OSPFv3 Process (15)
```

```
Codes: C - connected, D - Discard, O - OSPF, IA - OSPF inter area
       N1 - OSPF NSSA external type 1, N2 - OSPF NSSA external type 2
       E1 - OSPF external type 1, E2 - OSPF external type 2
```

Destination	Metric
Next-hop	
C 3ffe:4::/64	1
directly connected, eth1, Area 0.0.0.0	
E2 4ffe:2::/64	1/20
via fe80::a00:27ff:fe0d:fbe3, eth1	

```
R3#show ipv6 ospf neighbor
OSPFv3 Process (15)
Neighbor ID      Pri   State           Dead Time   Interface   Instance ID
159.159.159.159  1    Full/Backup     00:00:33   eth1        0
```

Redistribute with Metric Option

In this example, on R3, routes of instance 15 are redistributed into instance and vice-versa with metric of 100 so that R1 and R2 have each other's routes with a metric of 100.

R2

(config)#router ipv6 ospf 15	Configure an OSPFv3 instance with instance ID 15.
(config-router)#router-id 159.159.159.159	Configure the router ID.
(config-router)#redistribute ospf 5 metric 100	Redistribute instance 5 routes with metric 100.
(config-router)#exit	Exit OSPF router mode.
(config)#router ipv6 ospf 5	Redistribute routes into instance 5.
(config-router)#router-id 149.149.149.149	Configure the router ID.
(config-router)#redistribute ospf 15 metric 100	Redistribute instance 15 routes with metric 100.
(config-router)#commit	Commit the candidate configuration to the running configuration.

Validation

R1

```
R1#show ipv6 ospf route
OSPFv3 Process (5)
Codes: C - connected, D - Discard, O - OSPF, IA - OSPF inter area
       N1 - OSPF NSSA external type 1, N2 - OSPF NSSA external type 2
       E1 - OSPF external type 1, E2 - OSPF external type 2
```

```

Destination                               Metric
Next-hop
E2 3ffe:4::/64                             1/100
   via fe80::a00:27ff:fef9:2432, eth1
C  4ffe:2::/64                              1
   directly connected, eth1, Area 0.0.0.0
R1#
```

```
R1#show ipv6 route
IPv6 Routing Table
Codes: K - kernel route, C - connected, S - static, R - RIP, O - OSPF,
       IA - OSPF inter area, E1 - OSPF external type 1,
       E2 - OSPF external type 2, E - EVPN  N1 - OSPF NSSA external type 1,
       N2 - OSPF NSSA external type 2, i - IS-IS, B - BGP
Timers: Uptime
```

```

IP Route Table for VRF "default"
C      ::1/128 via ::, lo, 18:08:02
O E2   3ffe:4::/64 [110/100] via fe80::5054:ff:fe0e:46b7, eth1, 00:00:25
C      4ffe:2::/64 via ::, eth1, 00:20:39
C      fe80::/64 via ::, eth9, 18:08:02
R1#

```

```

R1#show ipv6 ospf neighbor
OSPFv3 Process (5)
Neighbor ID      Pri   State           Dead Time   Interface   Instance ID
149.149.149.149  1    Full/Backup     00:00:36   eth1        0

```

R2

```

R2#show ipv6 ospf route
OSPFv3 Process (15)
Codes: C - connected, D - Discard, O - OSPF, IA - OSPF inter area
       N1 - OSPF NSSA external type 1, N2 - OSPF NSSA external type 2
       E1 - OSPF external type 1, E2 - OSPF external type 2

```

```

      Destination           Metric
      Next-hop
C 3ffe:4::/64                1
   directly connected, eth2, Area 0.0.0.0

```

```

OSPFv3 Process (5)
Codes: C - connected, D - Discard, O - OSPF, IA - OSPF inter area
       N1 - OSPF NSSA external type 1, N2 - OSPF NSSA external type 2
       E1 - OSPF external type 1, E2 - OSPF external type 2

```

```

      Destination           Metric
      Next-hop
C 4ffe:2::/64                1
   directly connected, eth1, Area 0.0.0.0

```

```

R2#show ipv6 ospf neighbor
OSPFv3 Process (15)
Neighbor ID      Pri   State           Dead Time   Interface   Instance ID
152.152.152.152  1    Full/DR         00:00:33   eth2        0
OSPFv3 Process (5)
Neighbor ID      Pri   State           Dead Time   Interface   Instance ID
5.5.5.5          1    Full/DR         00:00:40   eth1        0

```

R3

```

R3#show ipv6 ospf route
OSPFv3 Process (15)
Codes: C - connected, D - Discard, O - OSPF, IA - OSPF inter area
       N1 - OSPF NSSA external type 1, N2 - OSPF NSSA external type 2
       E1 - OSPF external type 1, E2 - OSPF external type 2

```

```

Destination                                Metric
Next-hop
C 3ffe:4::/64                               1
   directly connected, eth1, Area 0.0.0.0
E2 4ffe:2::/64                              1/100
   via fe80::a00:27ff:fe0d:fbe3, eth1

```

R3#

R3#show ipv6 route

IPv6 Routing Table

Codes: K - kernel route, C - connected, S - static, R - RIP, O - OSPF,
 IA - OSPF inter area, E1 - OSPF external type 1,
 E2 - OSPF external type 2, E - EVPN N1 - OSPF NSSA external type 1,
 N2 - OSPF NSSA external type 2, i - IS-IS, B - BGP

Timers: Uptime

IP Route Table for VRF "default"

```

C ::1/128 via ::, lo, 18:08:13
C 3ffe:4::/64 via ::, eth1, 00:17:55
O E2 4ffe:2::/64 [110/100] via fe80::5054:ff:fe3d:e317, eth1, 00:01:05
C fe80::/64 via ::, eth9, 18:08:13

```

R3#

R3#show ipv6 ospf neighbor

OSPFv3 Process (15)

Neighbor ID	Pri	State	Dead Time	Interface	Instance ID
159.159.159.159	1	Full/Backup	00:00:37	eth1	0

Redistribute with Type Option

In this example, on R3, R1 has R3 routes as type 2, and R3 has R1 routes as type 1.

R2

(config)#router ipv6 ospf 15	Configure an OSPFv3 instance with instance ID 15.
(config-router)#router-id 159.159.159.159	Configure the router ID.
(config-router)#redistribute ospf 5 metric-type 1	Redistribute instance 5 routes as type 1.
(config-router)#exit	Exit OSPF router mode.
(config)#router ipv6 ospf 5	Redistribute routes into instance 5.
(config-router)#router-id 149.149.149.149	Configure the router ID.
(config-router)#redistribute ospf 15 metric-type 2	Redistribute instance 15 routes as type 2.
(config-router)#commit	Commit the candidate configuration to the running configuration.

Validation

R1

```
R1#show ipv6 ospf route
OSPFv3 Process (5)
Codes: C - connected, D - Discard, O - OSPF, IA - OSPF inter area
       N1 - OSPF NSSA external type 1, N2 - OSPF NSSA external type 2
       E1 - OSPF external type 1, E2 - OSPF external type 2
```

Destination	Metric
Next-hop	
E2 3ffe:4::/64	1/20
via fe80::a00:27ff:fef9:2432, eth1	
C 4ffe:2::/64	1
directly connected, eth1, Area 0.0.0.0	

```
rtr1#show ipv6 ospf neighbor
OSPFv3 Process (5)
Neighbor ID      Pri   State           Dead Time   Interface   Instance I
D
149.149.149.149  1    Full/Backup     00:00:32   eth1        0
```

R2

```
R2#show ipv6 ospf route
OSPFv3 Process (15)
Codes: C - connected, D - Discard, O - OSPF, IA - OSPF inter area
       N1 - OSPF NSSA external type 1, N2 - OSPF NSSA external type 2
       E1 - OSPF external type 1, E2 - OSPF external type 2
```

Destination	Metric
Next-hop	
C 3ffe:4::/64	1
directly connected, eth2, Area 0.0.0.0	

```
OSPFv3 Process (5)
Codes: C - connected, D - Discard, O - OSPF, IA - OSPF inter area
       N1 - OSPF NSSA external type 1, N2 - OSPF NSSA external type 2
       E1 - OSPF external type 1, E2 - OSPF external type 2
```

Destination	Metric
Next-hop	
C 4ffe:2::/64	1
directly connected, eth1, Area 0.0.0.0	

```
R2#show ipv6 ospf neighbor
OSPFv3 Process (15)
Neighbor ID      Pri   State           Dead Time   Interface   Instance I
D
152.152.152.152  1    Full/DR         00:00:36   eth2        0
OSPFv3 Process (5)
Neighbor ID      Pri   State           Dead Time   Interface   Instance I
D
5.5.5.5          1    Full/DR         00:00:32   eth1        0
```

R3

```
R3#show ipv6 ospf route
OSPFv3 Process (15)
Codes: C - connected, D - Discard, O - OSPF, IA - OSPF inter area
       N1 - OSPF NSSA external type 1, N2 - OSPF NSSA external type 2
       E1 - OSPF external type 1, E2 - OSPF external type 2
```

Destination	Metric
Next-hop	
C 3ffe:4::/64	1
directly connected, eth1, Area 0.0.0.0	
E2 4ffe:2::/64	1/21
via fe80::a00:27ff:fe0d:fbe3, eth1	

```
R3#show ipv6 ospf neighbor
OSPFv3 Process (15)
Neighbor ID      Pri   State             Dead Time   Interface   Instance I
D
159.159.159.159  1    Full/Backup       00:00:36   eth1        0
```

Redistribute with Route-Map Option**R1**

(config)#interface eth2	Configure the interface eth2 on R1.
(config-if)#ipv6 address 4ffe:1::2/64	Configure the IPv6 address.
(config-if)#ipv6 router ospf area 0 tag 5	Configure interface eth2 for ospfv3 with area 0 and instance 5
(config-if)#commit	Commit the candidate configuration to the running configuration.

Validation

```
R3
R3#show ipv6 ospf route
OSPFv3 Process (15)
Codes: C - connected, D - Discard, O - OSPF, IA - OSPF inter area
       N1 - OSPF NSSA external type 1, N2 - OSPF NSSA external type 2
       E1 - OSPF external type 1, E2 - OSPF external type 2
```

Destination	Metric
Next-hop	
C 3ffe:4::/64	1
directly connected, eth1, Area 0.0.0.0	
E1 4ffe:1::/64	20
via fe80::5054:ff:fe3d:e317, eth1	
E1 4ffe:2::/64	20
via fe80::5054:ff:fe3d:e317, eth1	

R3#

R2

R2(config)#ipv6 prefix-list permit-4ffe-2	Configure and ipv6 prefix-list
R2 (config-ipv6-prefix-list)#seq 5 permit 4ffe:2::/64	Create an access-list to permit the prefix 4ffe:2::/64
R2(config-ipv6-prefix-list)#exit	Exit the prefix-list mode
R2(config)#route-map permit-only-4ffe-2	Configure a route-map to permit only the prefix 4ffe:2::/64
R2(config-route-map)#match ipv6 address prefix-list permit-4ffe-2	Configure a match statement to match the configured ipv6 prefix-list
R2(config-route-map)#exit	Exit route-map mode and return to configure terminal mode
R2(config)#router ipv6 ospf 15	Enter router ipv6 mode for instance 15
R2(config-router)#redistribute ospf 5 route-map permit-only-4ffe-2	Redistribute instance 5 routes with route-map to permit only the ipv6 prefix 4ffe:2::/64
(config-router)#exit	Exit OSPF router mode.
(config)#router ipv6 ospf 5	Redistribute routes into instance 5.
(config-router)#router-id 149.149.149.149	Configure the router ID.
(config-router)#redistribute ospf 15 route-map 1	Redistribute instance 15 routes with route map 1.
(config-router)#redistribute connected	Redistribute connected routes to instance 15.
(config-router)#commit	Commit the candidate configuration to the running configuration.

Validation**R1**

```
R1#show ipv6 ospf route
OSPFv3 Process (5)
Codes: C - connected, D - Discard, O - OSPF, IA - OSPF inter area
       N1 - OSPF NSSA external type 1, N2 - OSPF NSSA external type 2
       E1 - OSPF external type 1, E2 - OSPF external type 2
```

```

      Destination                Metric
      Next-hop
E2 3ffe:4::/64                    1/20
   via fe80::5054:ff:fe0e:46b7, eth1
C 4ffe:1::/64                      1
   directly connected, eth2, Area 0.0.0.0
C 4ffe:2::/64                      1
   directly connected, eth1, Area 0.0.0.0
```

```
R1#
```

```
R1#show ipv6 ospf neighbor
OSPFv3 Process (5)
Neighbor ID   Pri   State           Dead Time   Interface   Instance I
D
149.149.149.149  1   Full/DR         00:00:34   eth1        0
```

R2

```
R2#show ipv6 ospf route
```

```

OSPFv3 Process (15)
Codes: C - connected, D - Discard, O - OSPF, IA - OSPF inter area
       N1 - OSPF NSSA external type 1, N2 - OSPF NSSA external type 2
       E1 - OSPF external type 1, E2 - OSPF external type 2

```

```

Destination                                Metric
Next-hop
C  3ffe:4::/64                              1
   directly connected, eth2, Area 0.0.0.0

```

```

OSPFv3 Process (5)
Codes: C - connected, D - Discard, O - OSPF, IA - OSPF inter area
       N1 - OSPF NSSA external type 1, N2 - OSPF NSSA external type 2
       E1 - OSPF external type 1, E2 - OSPF external type 2

```

```

Destination                                Metric
Next-hop
O  4ffe:1::/64                              2
   via fe80::5054:ff:fe0c:40ed, eth1, Area 0.0.0.0
C  4ffe:2::/64                              1
   directly connected, eth1, Area 0.0.0.0

```

R2#

```
R2#sh ipv6 ospf neighbor
```

```

OSPFv3 Process (15)
Neighbor ID   Pri   State           Dead Time   Interface   Instance ID
152.152.152.152  1   Full/Backup    00:00:32   eth2        0
OSPFv3 Process (5)
Neighbor ID   Pri   State           Dead Time   Interface   Instance ID
5.5.5.5       1   Full/Backup    00:00:38   eth1        0

```

R3

```
R3#show ipv6 ospf route
```

```

OSPFv3 Process (15)
Codes: C - connected, D - Discard, O - OSPF, IA - OSPF inter area
       N1 - OSPF NSSA external type 1, N2 - OSPF NSSA external type 2
       E1 - OSPF external type 1, E2 - OSPF external type 2

```

```

Destination                                Metric
Next-hop
C  3ffe:4::/64                              1
   directly connected, eth1, Area 0.0.0.0
E2 4ffe:2::/64                              1/20
   via fe80::5054:ff:fe3d:e317, eth1

```

R3#

Not-So-Stubby Area

This section contains OSPFv3 NSSA (Not-So-Stubby Area) configuration examples.

An NSSA allows external routes to be advertised into the OSPF autonomous system while retaining the characteristics of a stub area to the rest of the autonomous system. To do this, the ASBR in an NSSA will originate type 7 LSAs to

advertise the external destinations. These NSSA external LSAs are flooded throughout the NSSA but are blocked at the ABR.

The NSSA external LSA has a flag in its header known as the P-bit. The NSSA ASBR has the option of setting or clearing the P-bit. If an NSSA's ABR receives a type 7 LSA with the P-bit set to one, it translates the type 7 LSA into a type 5 LSA and floods it throughout the other areas. If the P-bit is set to zero, no translation takes place and the destination in the type 7 LSA is not advertised outside of the NSSA.

Topology

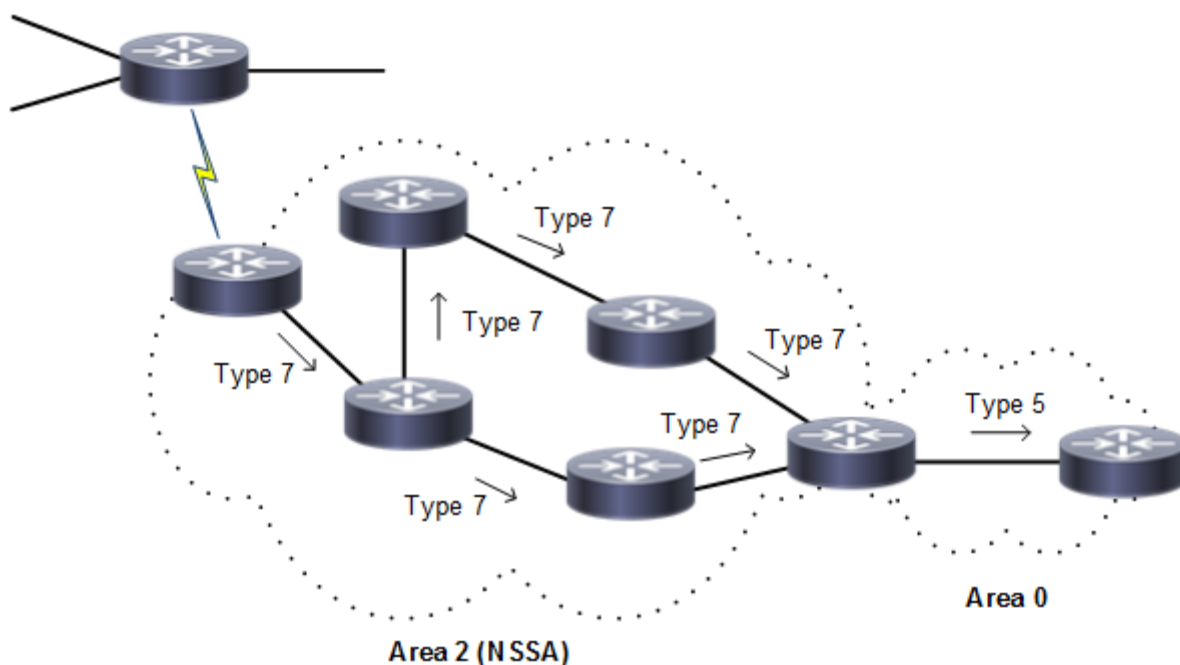

Figure 12-92: Translating Type 7 LSAs into Type 5 LSAs

NSSA with Route Option

This example shows the configuration to enable NSSA and to configure different route options for NSSA. There are three `area nssa` command options for originating default Type-3 LSA and default Type-7 LSA, and for blocking redistribution of Type-7 LSA into an NSSA:

- `no-summary`: The NSSA ABR blocks all type-3 and type-4 LSAs into the NSSA area and sends a single type-3 LSA into the area to advertise a default route
- `default-information-originate`: The NSSA ABR advertises a default route into the NSSA as a type-7 LSA.
- `no-redistribution`: The NSSA ABR blocks type-7 LSA from being redistributed into the NSSA area.

In [Figure 12-93](#), R2 is an NSSA ABR as well as an NSSA ASBR that maps the router interfaces to two different areas and redistributes the connected routes of the loopback interface. Also, this example sets the `no-summary`, `no-redistribution`, and `default-information-originate` options on R2 to originate default Type-3 LSAs and default Type-7 LSAs into the NSSA and to block Type-7 LSAs.

Topology

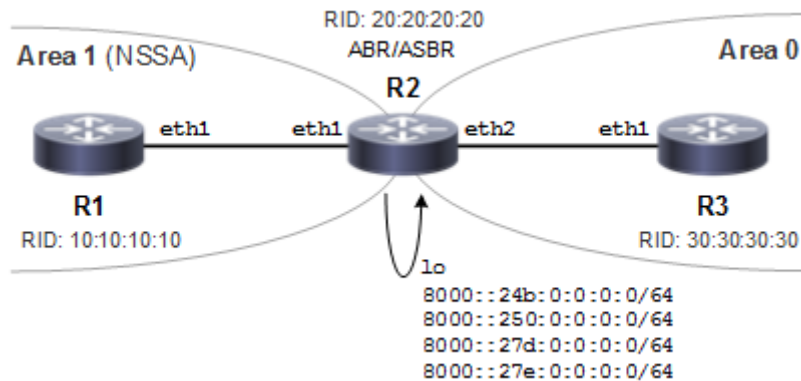

Figure 12-93: NSSA with Route Options

R1

(config)#interface eth1	Enter interface mode for eth1.
(config-if)#ipv6 router ospf tag 100 area 1	Configure interface in an area assigned with the area ID (1).
(config-if)#exit	Exit interface mode.
(config)#router ipv6 ospf 100	Configure the routing process and specify the tag (100).
(config-router)#router-id 10.10.10.10	Configure the router ID to use on this instance (100)
(config-router)#area 1 nssa	Configure area as NSSA
(config-router)#commit	Commit the candidate configuration to the running configuration.
(config-router)#exit	Exit interface mode

R2

(config)#interface eth1	Enter interface mode for eth1.
(config-if)#ipv6 router ospf tag 100 area 1	Configure interface in an area assigned with the area ID (1).
(config-if)#exit	Exit interface mode.
(config)#interface eth2	Enter interface mode for eth2
(config-if)#ipv6 router ospf tag 100 area 0	Configure interface in backbone
(config-if)#interface lo	Enter interface mode for Loopback
(config-if)#ipv6 address 8000::24b:0:0:0/64	Assign IPv6 address to loopback interface
(config-if)#ipv6 address 8000::250:0:0:0/64	Assign IPv6 address to loopback interface
(config-if)#ipv6 address 8000::27d:0:0:0/64	Assign IPv6 address to loopback interface
(config-if)#ipv6 address 8000::27e:0:0:0/64	Assign IPv6 address to loopback interface
(config-if)#commit	Commit the candidate configuration to the running configuration.
(config-if)#exit	Exit interface mode.

(config)#router ipv6 ospf 100	Configure the routing process and specify the tag (100).
(config-router)#router-id 20.20.20.20	Configure the router ID to use on this instance (100)
(config-router)#redistribute connected	Redistribute the configured loopback network into the NSSA
(config-router)#area 1 nssa no-redistribution default-information-originate no-summary	Configure the Router to originate default Type-3 LSAs and default Type-7 LSAs, and to block Type-7 LSAs into the NSSA
(config-router)#commit	Commit the candidate configuration to the running configuration.
(config-router)#exit	Exit interface mode

R3

(config)#interface eth1	Enter interface mode for eth1.
(config-if)#ipv6 router ospf tag 100 area 0	Configure interface in an area assigned with the area ID (1).
(config-if)#exit	Exit interface mode.
(config)#router ipv6 ospf 100	Configure the routing process and specify the tag (100).
(config-router)#router-id 30.30.30.30	Configure the router ID to use on this instance (100)
(config-router)#commit	Commit the candidate configuration to the running configuration.
(config-router)#exit	Exit interface mode

Validation 1

In the output of `show ipv6 ospf neighbor` below, verify that OSPFv3 adjacency is in state “full” for both R1 and R2 under the process identifier 100.

```
R1#sh ipv6 ospf neighbor
OSPFv3 Process (100)
Neighbor ID      Pri   State           Dead Time   Interface   Instance ID
20.20.20.20     1    Full/DR         00:00:34   eth1        0

R2#show ipv6 ospf neighbor

Total number of full neighbors: 2
OSPFv3 Process (100)
Neighbor ID      Pri   State           Dead Time   Interface   Instance ID
10.10.10.10     1    Full/DR         00:00:36   eth1        0
30.30.30.30     1    Full/Backup     00:00:39   eth2        0
R2#
```

Validation 2

The output below shows originating default Type-3 LSAs into the NSSA with the no-summary option. The advertising router identifier is for R2 (20.20.20.20, the NSSA-ABR). Also, the prefix is `::/0` and the LS-Type is Inter-Area-Prefix-LSA for the default Type-3 LSA route into the NSSA.

```
R1#sh ipv6 ospf database inter-prefix

OSPFv3 Router with ID (10.10.10.10) (Process 100)
```

 Inter-Area-Prefix-LSA (Area 0.0.0.1)

```

LS age: 1234
LS Type: Inter-Area-Prefix-LSA
Link State ID: 0.0.0.6
Advertising Router: 20.20.20.20
LS Seq Number: 0x80000001
Checksum: 0x17D0
Length: 28
  Metric: 1
  Prefix: ::/0
  Prefix Options: 0
  
```

Validation 3

The output below shows originating default type-7 LSAs alone after setting the no-redistribution and default-information originate options. The advertising router identifier is for R2 (20.20.20.20, the NSSA-ABR). Also, the prefix is ::/0 and LS-Type is NSSA-external-LSA for the default Type-7 LSA route into the NSSA

```

R1#sh ipv6 ospf database nssa-external

      OSPFv3 Router with ID (10.10.10.10) (Process 100)

      NSSA-external-LSA (Area 0.0.0.1)

LS age: 1758
LS Type: NSSA-external-LSA
Link State ID: 0.0.0.20
Advertising Router: 20.20.20.20
LS Seq Number: 0x80000002
Checksum: 0x6468
Length: 32
  Metric Type: 2 (Larger than any link state path)
  Metric: 1
  Prefix: ::/0
  Prefix Options: 0 (-|-|-|-)
  External Route Tag: 0
  
```

NSSA with the Summary Address Option

Figure 12-94 shows the configuration to originate external LSAs (Type-7) and translate them into external LSAs (Type-5):

- R1 is an NSSA-ASBR configured with loopback IPv6 addresses that are redistributed into OSPFv3
- R2 is an NSSA-ABR
- R3 is backbone router

R1 originates Type-7 LSAs which are summarized into a single Type-7 into the NSSA by the `summary-address` option and this summarized Type-7 is converted to Type-5 LSA by R2.

Also, the summarized route can be tagged using the `tag` command and the advertisement of summarized routes can be suppressed by the `not-advertise` option.

Topology

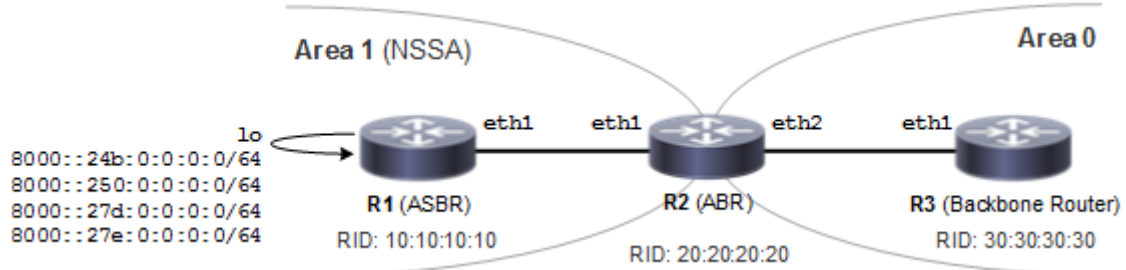

Figure 12-94: Using the summary-address Option

Configuration

R1

(config)#interface eth1	Enter interface mode for eth1.
(config-if)#ipv6 address 1000::1/64	Configure ipv6 address for interface eth1
(config-if)#ipv6 router ospf tag 100 area 1	Configure interface in an area assigned with the area ID (1).
(config-if)#exit	Exit interface mode.
(config-if)#interface lo	Enter interface mode for loopback
(config-if)#ipv6 address 8000::24b:0:0:0:0/64	Assign IPv6 address to loopback interface
(config-if)#ipv6 address 8000::250:0:0:0:0/64	Assign IPv6 address to loopback interface
(config-if)#ipv6 address 8000::27d:0:0:0:0/64	Assign IPv6 address to loopback interface
(config-if)#ipv6 address 8000::27e:0:0:0:0/64	Assign IPv6 address to loopback interface
(config-if)#exit	Exit interface mode.
(config)#router ipv6 ospf 100	Configure the routing process and specify the tag (100).
(config-router)#router-id 10.10.10.10	Configure the router ID to use on this instance (100)
(config-router)#area 1 nssa	Configure the area as NSSA.
(config-router)#redistribute connected	Redistribute the configured loopback network into OSPFv3 NSSA. Note: Connected networks can be redistributed by setting the metric and metric type.
(config-router)#summary-address 8000::/48 all-tag 10	Summarize the address range and tag the summarized route
(config-router)#commit	Commit the candidate configuration to the running configuration.
(config-router)#exit	Exit interface mode

R2

(config)#interface eth1	Enter interface mode for eth1.
(config-if)#ipv6 address 1000::2/64	Configure ipv6 address for interface eth1
(config-if)#ipv6 router ospf tag 100 area 1	Configure interface in an area assigned with the area ID (1).
(config-if)#exit	Exit interface mode.
(config)#interface eth2	Enter interface mode for eth2
(config-if)#ipv6 address 2000::1/64	Configure ipv6 address for interface eth2
(config-if)#ipv6 router ospf tag 100 area 0	Configure interface in backbone area (0)
(config-if)#exit	Exit interface mode.
(config)#router ipv6 ospf 100	Configure the routing process and specify the tag (100).
(config-router)#router-id 20.20.20.20	Configure the router ID to use on this instance (100)
(config-router)#area 1 nssa	Configure the Router in NSSA
(config-router)#commit	Commit the candidate configuration to the running configuration.
(config-router)#exit	Exit interface mode

R3

(config)#interface eth1	Enter interface mode for eth1.
(config-if)#ipv6 address 2000::2/64	Configure ipv6 address for interface eth1
(config-if)#ipv6 router ospf tag 100 area 0	Configure interface in backbone area (0)
(config-if)#exit	Exit interface mode.
(config)#router ipv6 ospf 100	Configure the routing process and specify the tag (100).
(config-router)#router-id 30.30.30.30	Configure the router ID to use on this instance (100)
(config-router)#commit	Commit the candidate configuration to the running configuration.
(config-router)#exit	Exit interface mode

In the configurations above, you can suppress the external route summarization by NSSA-ASBR by specifying the `not-advertise` parameter as shown below:

```
(config-router)#summary-address 8000::/48 not-advertise
```

Also, connected networks can be redistributed by setting the metric and metric type as shown below:

```
(config-router)#redistribute connected metric 20 metric-type 1
```

Validation 1

The output below shows the summarized route generated by NSSA-ASBR (R1) with a tag. The output has the LS Type as NSSA-external-LSA with advertising router identifier (10.10.10.10) of the NSSA-ASBR (R1). Also, check the Prefix which is summarized route and external route tag as configured.

```
R1#sh ipv6 ospf database nssa-external
      OSPFv3 Router with ID (10.10.10.10) (Process 100)
          NSSA-external-LSA (Area 0.0.0.1)
```

```
LS age: 90
LS Type: NSSA-external-LSA
Link State ID: 0.0.0.11
Advertising Router: 10.10.10.10
LS Seq Number: 0x80000003
Checksum: 0x69B3
Length: 40
  Metric Type: 2 (Larger than any link state path)
  Metric: 21
  Prefix: 8000::/48
  Prefix Options: 8 (P|-|-|-)
  External Route Tag: 10
```

Validation 2

The output below on the NSSA-ABR that is translating Type-7 LSAs to Type-5 LSAs shows summarized address in Type-7 and Type-5 LSA. Check for the same prefix, external route tag in both Type7 and Type-5 LSA.

```
R2#sh ipv6 ospf database nssa-external
```

```
OSPFv3 Router with ID (20.20.20.20) (Process 100)
```

```
NSSA-external-LSA (Area 0.0.0.1)
```

```
LS age: 241
LS Type: NSSA-external-LSA
Link State ID: 0.0.0.11
Advertising Router: 10.10.10.10
LS Seq Number: 0x80000003
Checksum: 0x69B3
Length: 40
  Metric Type: 2 (Larger than any link state path)
  Metric: 21
  Prefix: 8000::/48
  Prefix Options: 8 (P|-|-|-)
  External Route Tag: 10
```

```
R2#sh ipv6 ospf database external
```

```
OSPFv3 Router with ID (20.20.20.20) (Process 100)
```

```
AS-external-LSA
```

```
LS age: 245
LS Type: AS-External-LSA
Link State ID: 0.0.0.3
Advertising Router: 20.20.20.20
LS Seq Number: 0x80000003
Checksum: 0x8660
Length: 40
  Metric Type: 2 (Larger than any link state path)
  Metric: 21
  Prefix: 8000::/48
  Prefix Options: 0 (-|-|-|-)
  External Route Tag: 10
```

Validation 3

The output below on the backbone router shows the summarized address in the translated Type-5 LSA. The prefix and external route tag are the same as the summarized Type-7 LSA originated by R1.

```
R3#sh ipv6 ospf database external

      OSPFv3 Router with ID (30.30.30.30) (Process 100)

      AS-external-LSA

LS age: 409
LS Type: AS-External-LSA
Link State ID: 0.0.0.3
Advertising Router: 20.20.20.20
LS Seq Number: 0x80000003
Checksum: 0x8660
Length: 40
  Metric Type: 2 (Larger than any link state path)
  Metric: 21
  Prefix: 8000::/48
  Prefix Options: 0 (-|-|-|-)
  External Route Tag: 10
```

NSSA with the Translator Role Option

Type-7 to Type-5 translation is done by an NSSA-ABR. If an NSSA has multiple NSSA-ABRs, only one will perform the translation. The NSSA-ABR translator role options are:

- Candidate (default)
- Always

In the topology in [Figure 12-95](#):

- R1 is NSSA-ASBR
- R2 and R3 are NSSA-ABRs
- R4 is a backbone router

In this example, the NSSA translator role `candidate` is configured on both NSSA-ABRs (R2 and R3). The Type-7 to Type-5 translation is done by the router with the higher router identifier (R3).

Topology

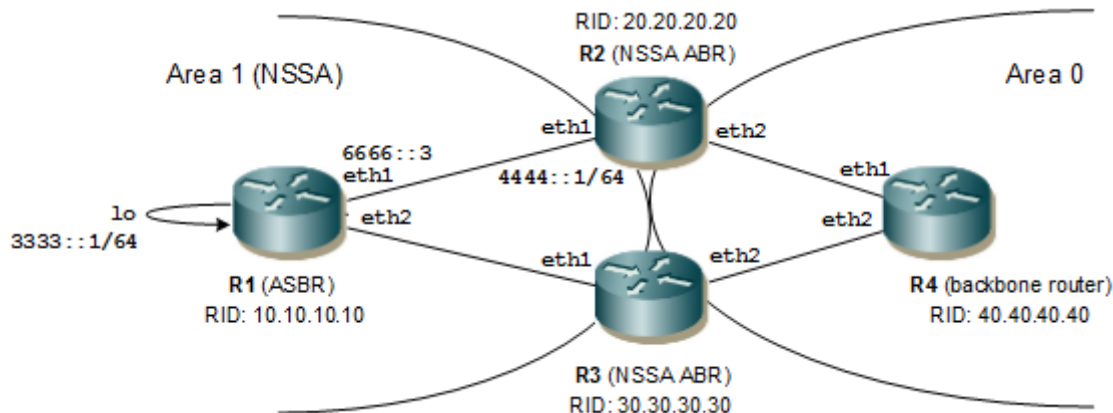

Figure 12-95: Using the translator-role Option

Configuration

When one NSSA-ABR is configured with the translator role as `always` and the other as `candidate`, then translation is done by the router configured as `always`. In this scenario, the translation can be biased by setting the translator role to `always` on the router that has the lower router identifier.

R1

<code>(config)#interface eth1</code>	Enter interface mode for eth1.
<code>(config-if)#ipv6 router ospf tag 100 area 1</code>	Configure interface in an area assigned with the area ID (1).
<code>(config-if)#exit</code>	Exit interface mode.
<code>(config)#interface eth2</code>	Enter interface mode for eth2.
<code>(config-if)#ipv6 router ospf tag 100 area 1</code>	Configure interface in an area assigned with the area ID (1).
<code>(config-if)#exit</code>	Exit interface mode.
<code>(config-if)#interface lo</code>	Enter interface mode for Loopback
<code>(config-if)#ipv6 address 3333::1/64</code>	Assign IPv6 address to loopback interface
<code>(config-if)#exit</code>	Exit interface mode.
<code>(config)#router ipv6 ospf 100</code>	Configure the routing process and specify the tag (100).
<code>(config-router)#router-id 10.10.10.10</code>	Configure the router ID to use on this instance (100)
<code>(config-router)#area 1 nssa</code>	Configure the area as NSSA.
<code>(config-router)#redistribute static</code>	Redistribute the static route configured into the OSPF NSSA
<code>(config-router)#redistribute connected</code>	Redistribute the connected network into OSPF NSSA
<code>(config-router)#commit</code>	Commit the candidate configuration to the running configuration.
<code>(config-router)#exit</code>	Exit interface mode
<code>(config)#ipv6 route 4444::1:0:0:0/64 6666::3</code>	Configure the static route with the next hop address as R2's eth1 IPv6 address
<code>(config)#exit</code>	Exit interface mode.

R2

(config)#interface eth1	Enter interface mode for eth1.
(config-if)#ipv6 router ospf tag 100 area 1	Configure interface in an area assigned with the area ID (1).
(config-if)#exit	Exit interface mode.
(config)#interface eth2	Enter interface mode for eth2
(config-if)#ipv6 router ospf tag 100 area 0	Configure interface in backbone area (0)
(config-if)#exit	Exit interface mode.
(config)#router ipv6 ospf 100	Configure the routing process and specify the tag (100).
(config-router)#router-id 20.20.20.20	Configure the router ID to use on this instance (100)
(config-router)#area 1 nssa translator-role candidate	Configure the NSSA-ABR with the translator role candidate.
(config-router)#commit	Commit the candidate configuration to the running configuration.
(config-router)#exit	Exit interface mode

R3

(config)#interface eth1	Enter interface mode for eth1.
(config-if)#ipv6 router ospf tag 100 area 1	Configure interface in an area assigned with the area ID (1).
(config-if)#exit	Exit interface mode.
(config)#interface eth2	Enter interface mode for eth2
(config-if)#ipv6 router ospf tag 100 area 0	Configure interface in backbone area (0)
(config-if)#exit	Exit interface mode.
(config)#router ipv6 ospf 100	Configure the routing process and specify the tag (100).
(config-router)#router-id 30.30.30.30	Configure the router ID to use on this instance (100)
(config-router)#area 1 nssa translator-role candidate	Configure the NSSA-ABR with the translator role candidate.
(config-router)#commit	Commit the candidate configuration to the running configuration.
(config-router)#exit	Exit interface mode

R4

(config)#interface eth1	Enter interface mode for eth1.
(config-if)#ipv6 router ospf tag 100 area 0	Configure interface in backbone area (0)
(config)#interface eth2	Enter interface mode for eth2
(config-if)#ipv6 router ospf tag 100 area 0	Configure interface in backbone area (0)
(config-if)#exit	Exit interface mode.
(config)#router ipv6 ospf 100	Configure the routing process and specify the tag (100).
(config-router)#router-id 40.40.40.40	Configure the router ID to use on this instance (100)
(config-router)#commit	Commit the candidate configuration to the running configuration.
(config-router)#exit	Exit interface mode

The command to configure the NSSA-Translator role as always is:

```
(config-router)#area 1 nssa translator-role always
```

The NSSA-ABR can continue to perform translation after its services are no longer required for the stability interval which is set using the command below on the NSSA-ABR.

```
(config-router)#area 1 nssa stability-interval 7777
```

Validation 1

The translation is done by the NSSA-ABR with the higher router identifier. In the output below, check the router identifier of the NSSA-ABR. Also, check the router which is elected and the router which is disabled.

```
R2#sh ipv6 ospf
Routing Process "OSPFv3 (100)" with ID 20.20.20.20
Process uptime is 21 minutes
SPF schedule delay min 0.500 secs, SPF schedule delay max 50.0 secs
Minimum LSA interval 5 secs, Minimum LSA arrival 1 secs
Number of incoming current DD exchange neighbors 0/5
Number of outgoing current DD exchange neighbors 0/5
Number of external LSA 4. Checksum Sum 0x1F816
Number of AS-Scoped Unknown LSA 0
Number of LSA originated 28
Number of LSA received 58
Number of areas in this router is 2
  Area BACKBONE(0)
    Number of interfaces in this area is 1(1)
    SPF algorithm executed 7 times
    Number of LSA 19. Checksum Sum 0x7454D
    Number of Unknown LSA 0
  Area 0.0.0.1 (NSSA)
    Number of interfaces in this area is 1(1)
    SPF algorithm executed 14 times
    Number of LSA 19. Checksum Sum 0xA4D18
    Number of Unknown LSA 0
    NSSA Translator State is disabled
R3#sh ipv6 ospf
Routing Process "OSPFv3 (100)" with ID 30.30.30.30
Process uptime is 19 minutes
SPF schedule delay min 0.500 secs, SPF schedule delay max 50.0 secs
Minimum LSA interval 5 secs, Minimum LSA arrival 1 secs
Number of incoming current DD exchange neighbors 0/5
Number of outgoing current DD exchange neighbors 0/5
Number of external LSA 4. Checksum Sum 0x1F816
Number of AS-Scoped Unknown LSA 0
Number of LSA originated 31
Number of LSA received 69
Number of areas in this router is 2
  Area BACKBONE(0)
    Number of interfaces in this area is 1(1)
    SPF algorithm executed 15 times
    Number of LSA 19. Checksum Sum 0x7454D
    Number of Unknown LSA 0
  Area 0.0.0.1 (NSSA)
    Number of interfaces in this area is 1(1)
    SPF algorithm executed 10 times
    Number of LSA 19. Checksum Sum 0xA4D18
```

Number of Unknown LSA 0
NSSA Translator State is elected

Validation 2

The translated Type-5 LSA in R4 in area 0 has the advertising router identifier of R3. In the output below, the LS Type is AS-External-LSA and the advertising router has the higher router identifier.

```
R4#sh ipv6 ospf database external

      OSPFv3 Router with ID (40.40.40.40) (Process 100)

      AS-external-LSA

LS age: 885
LS Type: AS-External-LSA
Link State ID: 0.0.0.7
Advertising Router: 30.30.30.30
LS Seq Number: 0x80000001
Checksum: 0xD3FE
Length: 40
  Metric Type: 2 (Larger than any link state path)
  Metric: 20
  Prefix: 3333::/64
  Prefix Options: 0 (-|-|-|-)
  External Route Tag: 0

LS age: 18
LS Type: AS-External-LSA
Link State ID: 0.0.0.8
Advertising Router: 30.30.30.30
LS Seq Number: 0x80000003
Checksum: 0x7457
Length: 56
  Metric Type: 2 (Larger than any link state path)
  Metric: 20
  Prefix: 4444::/64
  Prefix Options: 0 (-|-|-|-)
  Forwarding Address: 6666::3
  External Route Tag: 0
```

Link LSA Suppression

If link LSA suppression is enabled and the interface type is not broadcast or NBMA, the router will not originate a link-LSA for the link. This implies that other routers on that link will determine the router's next hop address using a mechanism other than the link LSA.

Topology

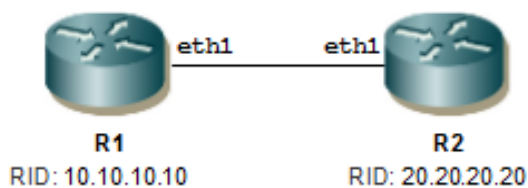

Figure 12-96: LSA Suppression

Configuration

R1

#configure terminal	Enter configure mode.
(config)#router ipv6 ospf 100-ABC	Configure the routing process and specify the tag (100-ABC) which uniquely identifies the routing process.
(config-router)#router-id 10.10.10.10	Configure the router ID to use on this instance.
(config-router)#exit	Exit OSPF router mode
(config)#interface eth1	Enter interface mode
(config-if)#ipv6 router ospf tag 100-ABC area 1	Configure interface in an area assigned with the area ID (1). The tag uniquely identifies the routing process.
(config-if)#ipv6 ospf network point-to-point	Configure the OSPF interface network type as point to point
(config-if)#ipv6 ospf link-lsa-suppression enable	Enable the link LSA suppression mechanism
(config-router)#commit	Commit the candidate configuration to the running configuration.
(config-if)#exit	Exit interface mode

R2

#configure terminal	Enter configure mode.
(config)#router ipv6 ospf 100-ABC	Configure the routing process and specify the tag (100-ABC) which uniquely identifies the routing process.
(config-router)#router-id 20.20.20.20	Configure the router ID to use on this instance.
(config-router)#exit	Exit OSPF router mode
(config)#interface eth1	Enter interface mode
(config-if)#ipv6 router ospf tag 100-ABC area 1	Configure interface in an area assigned with the area ID (1). The tag uniquely identifies the routing process.
(config-if)#ipv6 ospf network point-to-point	Configure the OSPF interface network type as point to point
(config-if)#ipv6 ospf link-lsa-suppression enable	Enable the link LSA Suppression Mechanism
(config-router)#commit	Commit the candidate configuration to the running configuration.
(config-if)#exit	Exit interface mode

Note: This is not applicable for broadcast and NBMA networks.

Validation 1

Verify that adjacency has been established.

```
R1#sh ipv6 ospf neighbor
OSPFv3 Process (100)
Neighbor ID      Pri   State           Dead Time   Interface   Instance ID
20.20.20.20     1    Full/ -         00:00:37   eth1        0
```

Validation 2

Verify that R1 should not have the Link LSA in the Link state database.

Note: The output below is captured after link lsa suppression enabled which has not Link LSA in the LSDB.

```
R1#sh ipv6 ospf database

      OSPFv3 Router with ID (10.10.10.10) (Process 100-ABC)

      Router-LSA (Area 0.0.0.1)

Link State ID    ADV Router      Age  Seq#           CkSum   Link
0.0.0.0         10.10.10.10    15  0x80000004    0x3264   1
0.0.0.0         20.20.20.20    15  0x80000002    0xdbba   1

      Intra-Area-Prefix-LSA (Area 0.0.0.1)

Link State ID    ADV Router      Age  Seq#           CkSum   Prefix Reference
0.0.0.12        10.10.10.10    14  0x80000004    0xaab4   1 Router-LSA
0.0.0.13        20.20.20.20    15  0x80000002    0x8f7f   1 Router-LSA

      Intra-Area-Te-LSA (Area 0.0.0.1)

Link State ID    ADV Router      Age  Seq#           CkSum
0.0.0.4         10.10.10.10    15  0x80000004    0xa326
0.0.0.3         20.20.20.20    15  0x80000002    0xffec
R1#sh ipv6 ospf database link

      OSPFv3 Router with ID (10.10.10.10) (Process 100-ABC)
```

Originate Type-7 LSAs and Translate to Type-5

[Figure 12-97](#) shows the configuration to originate Type-7 LSAs and translate them into Type-5 LSAs. R3 is an NSSA-ASBR that originates Type-7 LSAs into the NSSA which are converted to Type-5 LSAs by R2 which is an NSSA-ABR. R1 is a backbone router.

Topology

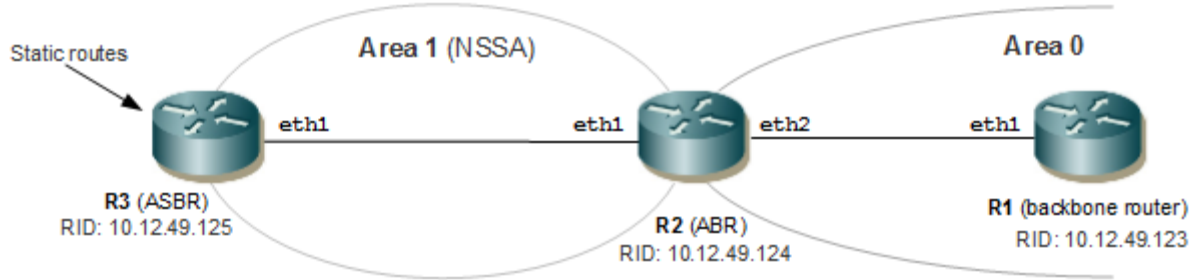

Figure 12-97: Originate Type-7 LSAs and Translate to Type-5 under Address Family IPv4

Configuration

R1

#configure terminal	Enter configure mode.
(config)#router ipv6 ospf 100-ABC	Configure the routing process and specify the tag (100-ABC) which uniquely identifies the routing process
(config-router)#router-id 10.12.49.123	Configure the router ID to use on this tag
(config-router)#exit	Exit OSPF router mode
(config)#interface eth1	Enter interface mode
(config-if)#ipv6 router ospf area 0 tag 100-ABC instance-id 31	Configure the interface in an area assigned with the area ID (0) which uniquely identifies the routing process and the instance identifier which is 0-31 for the IPv6 address family
(config-router)#commit	Commit the candidate configuration to the running configuration.
(config-if)#exit	Exit interface mode

R2

#configure terminal	Enter configure mode.
(config)#router ipv6 ospf 100-ABC	Configure the routing process and specify the tag (100-ABC) which uniquely identifies the routing process.
(config-router)#ip route 15.15.15.0/24 null	Configure the static route with the nexthop address set to null
(config-router)#router-id 10.12.49.125	Configure the router ID to use for this process
(config-router)#area 1 nssa	Configure the area 1 as NSSA.
(config-router)#exit	Exit OSPF router mode
(config)#interface eth1	Enter interface mode
(config-if)#ipv6 router ospf area 0 tag 100-ABC instance-id 31	Configure the interface in an area assigned with the area ID (1) which uniquely identifies the routing process and the instance identifier which is 64-95 for the IPv4 address family.
(config-if)#exit	Exit interface mode
(config)#interface eth2	Enter interface mode

OSPFv3

(config-if)#ipv6 router ospf area 1 tag 100-ABC instance-id 30	Configure the interface in an area assigned with the area ID (1) which uniquely identifies the routing process and the instance identifier which is 0-30 for the IPv6 address family.
(config-router)#commit	Commit the candidate configuration to the running configuration.
(config-if)#exit	Exit interface mode

R3

#configure terminal	Enter configure mode.
(config)#router ipv6 ospf 100-ABC	Configure the routing process and specify the tag (100-ABC) which uniquely identifies the routing process.
(config-router)#router-id 10.12.49.125	Configure the router ID to use for this process
(config-router)#area 1 nssa	Configure the area 1 as NSSA.
(config-router)#exit	Exit OSPF router mode
(config)#interface eth1	Enter interface mode
(config-if)#ipv6 router ospf area 1 tag 100-ABC instance-id 30	Configure the interface in an area assigned with the area ID (1) which uniquely identifies the routing process and the instance identifier which is 0-31 for the IPv6 address family.
(config-router)#commit	Commit the candidate configuration to the running configuration.

Validation 1

Verify that adjacency has been established with the configured instance identifier.

```
R2#sh ipv6 ospf neighbor
OSPFv3 Process (1)
Neighbor ID      Pri   State           Dead Time   Interface   Instance ID
10.12.49.123    1     Full/DR         00:00:31   eth1        31
10.12.49.125    1     Full/Backup     00:00:38   eth2        30
```

Validation 2

Verify that R3 has generated a Type-7 LSA and that the ABR R2 has External LSA Type 5 in its Database.

R3

```
R3#show ipv6 ospf database nssa-external

        OSPFv3 Router with ID (10.12.49.125) (Process 100-ABC)

        NSSA-external-LSA (Area 0.0.0.1)

LS age: 139
LS Type: NSSA-external-LSA
Link State ID: 0.0.0.1
Advertising Router: 10.12.49.125
LS Seq Number: 0x80000001
Checksum: 0xAB34
Length: 48
```

```
Metric Type: 2 (Larger than any link state path)
Metric: 20
Prefix: 15.15.15.0/24
Prefix Options: 8 (P|-|-|-)
Forwarding Address: 22.1.1.2
External Route Tag: 0
```

```
R3#show ipv6 ospf database external
```

```
OSPFv3 Router with ID (10.12.49.125) (Process 100-ABC)
```

```
R3#
```

Validation 3

R2

```
R2#show ipv6 ospf database nssa-external
```

```
OSPFv3 Router with ID (10.12.49.124) (Process 100-ABC)
```

```
NSSA-external-LSA (Area 0.0.0.1)
```

```
LS age: 105
LS Type: NSSA-external-LSA
Link State ID: 0.0.0.1
Advertising Router: 10.12.49.125
LS Seq Number: 0x80000001
Checksum: 0xAB34
Length: 48
Metric Type: 2 (Larger than any link state path)
Metric: 20
Prefix: 15.15.15.0/24
Prefix Options: 8 (P|-|-|-)
Forwarding Address: 22.1.1.2
External Route Tag: 0
```

```
R2#
```

```
R2#show ipv6 ospf database external
```

```
OSPFv3 Router with ID (10.12.49.124) (Process 100-ABC)
```

```
AS-external-LSA
```

```
LS age: 706
LS Type: AS-External-LSA
Link State ID: 0.0.0.1
Advertising Router: 10.12.49.124
LS Seq Number: 0x80000001
Checksum: 0xAB1F
Length: 48
```

```

Metric Type: 2 (Larger than any link state path)
Metric: 20
Prefix: 15.15.15.0/24
Prefix Options: 0 (-|-|-|-)
Forwarding Address: 22.1.1.2

```

R2#

R2#show ip route

```

Codes: K - kernel, C - connected, S - static, R - RIP, B - BGP
       O - OSPF, IA - OSPF inter area
       N1 - OSPF NSSA external type 1, N2 - OSPF NSSA external type 2
       E1 - OSPF external type 1, E2 - OSPF external type 2
       i - IS-IS, L1 - IS-IS level-1, L2 - IS-IS level-2,
       ia - IS-IS inter area, E - EVPN,
       v - vrf leaked
       * - candidate default

```

IP Route Table for VRF "default"

```

C          10.0.0.0/8 is directly connected, eth0, 15:43:05
C          11.1.1.0/24 is directly connected, eth1, 14:54:49
O N2      15.15.15.0/24 [110/20] via 22.1.1.2, eth2, 12:09:25
C          22.1.1.0/24 is directly connected, eth2, 12:22:45
C          127.0.0.0/8 is directly connected, lo, 15:43:05

```

Gateway of last resort is not set

R2#

Validation 3

Verify that FIB of backbone router has External Route as "O E2".

R1#

Verify that FIB of backbone router R1 has External Route as "O E2".

R1#show ip route

```

Codes: K - kernel, C - connected, S - static, R - RIP, B - BGP
       O - OSPF, IA - OSPF inter area
       N1 - OSPF NSSA external type 1, N2 - OSPF NSSA external type 2
       E1 - OSPF external type 1, E2 - OSPF external type 2
       i - IS-IS, L1 - IS-IS level-1, L2 - IS-IS level-2,
       ia - IS-IS inter area, E - EVPN,
       v - vrf leaked
       * - candidate default

```

IP Route Table for VRF "default"

```

C          10.0.0.0/8 is directly connected, eth0, 03:34:25
C          11.1.1.0/24 is directly connected, eth1, 02:46:18
O E2      15.15.15.0/24 [110/20] via 11.1.1.2, eth1, 00:00:36
O IA      22.1.1.0/24 [110/2] via 11.1.1.2, eth1, 00:05:01
C          127.0.0.0/8 is directly connected, lo, 03:34:25

```

Gateway of last resort is not set

Summarize Inter-Area and External Routes

Figure 12-98 shows the configuration to enable inter-area and external route summarization. The IPv4 address family is enabled on R1. R2 summarizes the internal OSPF routes which R3 redistributes.

Topology

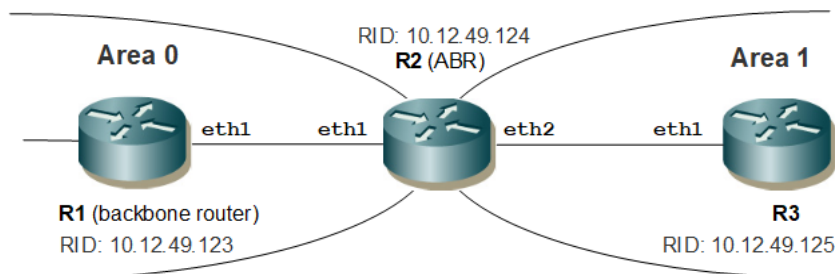

Figure 12-98: Enabling Intra-Area and External Route Summarization

Configuration

R1

#configure terminal	Enter configure mode.
(config)#router ipv6 ospf 100-ABC	Configure the routing process and specify the tag (100-ABC) which uniquely identifies the routing process
(config-router)#router-id 10.12.49.123	Configure the router ID to use for this process.
(config-router)#exit	Exit OSPF router mode
(config)#interface eth1	Enter interface mode
(config-if)#ip address 10.10.10.1/24	Specify IP address for interface eth1
(config-if)#ipv6 router ospf area 0 tag 100-ABC instance-id 31	Configure the interface in an area assigned with the area ID (0) which uniquely identifies the routing process and the instance identifier which is 0-31 for the IPv6 address family.
(config-if)#commit	Commit the candidate configuration to the running configuration.

R2

#configure terminal	Enter configure mode.
(config)#router ipv6 ospf 100-ABC	Configure the routing process and specify the tag (100-ABC) which uniquely identifies the routing process
(config-router)#router-id 10.12.49.124	Configure the router ID to use for this process
(config-router)#exit	Exit OSPF router mode
(config)#interface eth1	Enter interface mode
(config-if)#ip address 10.10.10.2/24	Specify an IP address for the interface
(config-if)#ipv6 router ospf area 0 tag 100-ABC instance-id 31	Configure the interface in an area assigned with the area ID (0) which uniquely identifies the routing process and the instance identifier which is 0-31 for the IPv4 address family.
(config-if)#exit	Exit interface mode
(config)#interface eth2	Enter interface mode
(config-if)#ip address 20.20.20.1/24	Specify an IP address for the interface
(config-if)#ipv6 router ospf area 1 tag 100-ABC instance-id 30	Configure the interface in an area assigned with the area ID (1) which uniquely identifies the routing process and the instance identifier which is 0-31 for the IPv6 address family.
(config-if)#exit	Exit interface mode
(config)#interface lo	Enter interface mode
(config-if)#ipv6 router ospf area 1 tag 101 instance-id 30	Configure the interface in an area assigned with the area ID (1) which uniquely identifies the routing process and the instance identifier which is 0-31 for the IPv6 address family.
(config-if)#commit	Commit the candidate configuration to the running configuration.
(config-if)#exit	Exit interface mode

R3

#configure terminal	Enter configure mode.
(config)#router ipv6 ospf 100-ABC	Configure the routing process and specify the tag (100-ABC) which uniquely identifies the routing process
(config-router)#router-id 10.12.49.125	Configure the router ID to use for this process
(config-router)#exit	Exit OSPF router mode
(config)#interface eth1	Enter interface mode
(config-if)#ip address 20.20.20.2/24	Specify an IP address for the interface
(config-if)#ipv6 router ospf area 1 tag 100-ABC instance-id 30	Configure the interface in an area assigned with the area ID (1) which uniquely identifies the routing process and the instance identifier which is 0-31 for the IPv4 address family.
(config-if)#commit	Commit the candidate configuration to the running configuration.
(config-if)#exit	Exit interface mode

Validation

Validation 1: Verify that adjacency has been established with the configured instance identifier.

```
R2#show ipv6 ospf neighbor
OSPFv3 Process (100-ABC)
Neighbor ID      Pri   State                    Dead Time   Interface   Instance ID
10.12.49.123    1     Full/Backup              00:00:38   eth1        31
10.12.49.125    1     Full/DR                  00:00:38   eth2        30
```

Validation 2: Verify that a single summarized OSPF IA route and a single summarized external route is available in FIB of R1

```
R1#show ip route
Codes: K - kernel, C - connected, S - static, R - RIP, B - BGP
       O - OSPF, IA - OSPF inter area
       N1 - OSPF NSSA external type 1, N2 - OSPF NSSA external type 2
       E1 - OSPF external type 1, E2 - OSPF external type 2
       i - IS-IS, L1 - IS-IS level-1, L2 - IS-IS level-2,
       ia - IS-IS inter area, E - EVPN,
       v - vrf leaked
       * - candidate default
```

```
IP Route Table for VRF "default"
C       10.0.0.0/8 is directly connected, eth0, 00:45:18
C       11.1.1.0/24 is directly connected, eth1, 00:40:01
O IA    22.1.1.0/24 [110/2] via 11.1.1.2, eth1, 00:37:57
O IA    100.1.1.0/24 [110/2] via 11.1.1.2, eth1, 00:24:59
C       127.0.0.0/8 is directly connected, lo, 00:45:18
O E2    200.1.1.0/24 [110/20] via 11.1.1.2, eth1, 00:00:54
```

```
Gateway of last resort is not set
R1#
```

Validation 3: Verify that the Inter-Area Prefix LSA and External LSA in OSPFv3 database of R1 consists of just a single prefix 100.1.1.0/24 and 200.1.1.0/24 respectively

```
R1#show ipv6 ospf database inter-prefix

                OSPFv3 Router with ID (10.12.49.123) (Process 100-ABC)

                Inter-Area-Prefix-LSA (Area 0.0.0.0)

LS age: 771
LS Type: Inter-Area-Prefix-LSA
Link State ID: 0.0.0.1
Advertising Router: 10.12.49.124
LS Seq Number: 0x80000002
Checksum: 0x60E3
Length: 32
  Metric: 1
  Prefix: 22.1.1.0/24
  Prefix Options: 0

LS age: 21
LS Type: Inter-Area-Prefix-LSA
```

Link State ID: 0.0.0.2
Advertising Router: 10.12.49.124
LS Seq Number: 0x80000008
Checksum: 0x489D
Length: 32
Metric: 1
Prefix: 127.0.0.0/8
Prefix Options: 0

LS age: 1795
LS Type: Inter-Area-Prefix-LSA
Link State ID: 0.0.0.5
Advertising Router: 10.12.49.124
LS Seq Number: 0x80000001
Checksum: 0x975B
Length: 32
Metric: 1
Prefix: 100.1.1.0/24
Prefix Options: 0

R1#

R1#show ipv6 ospf database external

OSPFv3 Router with ID (10.12.49.123) (Process 100-ABC)

AS-external-LSA

LS age: 390
LS Type: AS-External-LSA
Link State ID: 0.0.0.1
Advertising Router: 10.12.49.125
LS Seq Number: 0x80000001
Checksum: 0xCE5A
Length: 32
Metric Type: 2 (Larger than any link state path)
Metric: 20
Prefix: 10.0.0.0/8
Prefix Options: 0 (-|-|-|-)

LS age: 364
LS Type: AS-External-LSA
Link State ID: 0.0.0.4
Advertising Router: 10.12.49.125
LS Seq Number: 0x80000001
Checksum: 0x6CE8
Length: 32
Metric Type: 2 (Larger than any link state path)
Metric: 20
Prefix: 200.1.1.0/24
Prefix Options: 0 (-|-|-|-)

R1#

Validation 4: Verify that a single summarized external route is present in the ABR R2

```
R2#show ip route
Codes: K - kernel, C - connected, S - static, R - RIP, B - BGP
       O - OSPF, IA - OSPF inter area
       N1 - OSPF NSSA external type 1, N2 - OSPF NSSA external type 2
       E1 - OSPF external type 1, E2 - OSPF external type 2
       i - IS-IS, L1 - IS-IS level-1, L2 - IS-IS level-2,
       ia - IS-IS inter area, E - EVPN,
       v - vrf leaked
       * - candidate default
```

```
IP Route Table for VRF "default"
```

```
C       10.0.0.0/8 is directly connected, eth0, 00:55:15
C       11.1.1.0/24 is directly connected, eth1, 00:49:17
C       22.1.1.0/24 is directly connected, eth2, 00:48:18
O       100.1.1.0/24 [110/0] is a summary, Null, 00:35:05
C       100.1.1.100/32 is directly connected, lo, 00:35:40
C       100.1.1.110/32 is directly connected, lo, 00:35:36
C       127.0.0.0/8 is directly connected, lo, 00:55:15
O E2    200.1.1.0/24 [110/20] via 22.1.1.2, eth2, 00:11:00
```

```
Gateway of last resort is not set
```

```
R2#
```

Validation 5: Verify that the Type 5 LSA in the ABR's Link State Data Base consists of just a single prefix 200.1.1.0/24

```
R2#show ipv6 ospf database external
```

```
OSPFv3 Router with ID (10.12.49.124) (Process 100-ABC)
```

```
AS-external-LSA
```

```
LS age: 774
LS Type: AS-External-LSA
Link State ID: 0.0.0.1
Advertising Router: 10.12.49.125
LS Seq Number: 0x80000001
Checksum: 0xCE5A
Length: 32
  Metric Type: 2 (Larger than any link state path)
  Metric: 20
  Prefix: 10.0.0.0/8
  Prefix Options: 0 (-|-|-|-)
```

```
LS age: 748
LS Type: AS-External-LSA
Link State ID: 0.0.0.4
Advertising Router: 10.12.49.125
LS Seq Number: 0x80000001
Checksum: 0x6CE8
Length: 32
```

```
Metric Type: 2 (Larger than any link state path)
Metric: 20
Prefix: 200.1.1.0/24
Prefix Options: 0 (-|-|-|-)
```

Distribute List

To filter the routes that Open Shortest Path First Version 3 (OSPFv3) installs in the Routing Information Base (RIB), use the `distribute-list in` command in an appropriate configuration mode.

To filter the routes redistributed into Open Shortest Path First Version 3 (OSPFv3) from other routing protocols, use the `distribute-list out` command in an appropriate configuration mode.

Topology

Figure 12-99 shows the configuration to illustrate the `distribute-list` support for OSPFv3

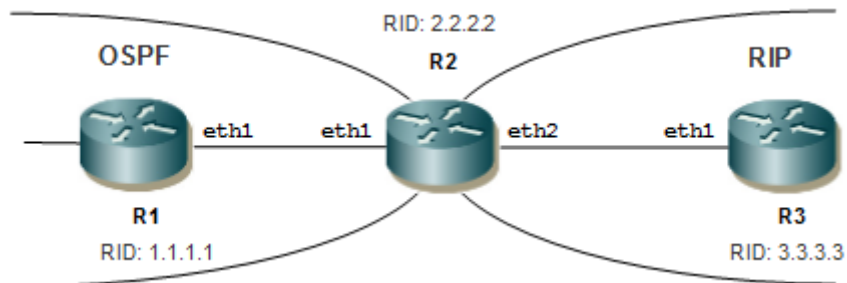

Figure 12-99: Basic Topology for Distribute-list

Configuration

R1

#configure terminal	Enter configure mode.
(config)#interface eth1	Enter interface mode.
(config-if)#ipv6 address 2000::1/64	Configure the IPv6 address of the interface.
(config-if)#ipv6 router ospf area 0 tag procl	Configure the interface in an area assigned with the area ID (0) which uniquely identifies the routing process
(config-if)#exit	Exit interface mode.
(config)#interface lo	Enter interface mode.
(config-if)# ipv6 address 1111::1/128	Configure the IPv6 address of the interface.
(config-if)# ipv6 address 2222::2/128	Configure the IPv6 address of the interface.
(config-if)#exit	Exit interface mode.
(config)#router ipv6 ospf procl	Configure the routing process
(config-router)#router-id 1.1.1.1	Configure router-id to uniquely identify the router
(config-router)#redistribute connected	Redistribute connected routes into ospfv3
(config-router)#commit	Commit the candidate configuration to the running configuration.
(config-router)#end	Exit router mode.

R2

#configure terminal	Enter configure mode.
(config)#interface eth1	Enter interface mode.
(config-if)#ipv6 address 2000::50/64	Configure the IPv6 address of the interface
(config-if)#ipv6 router ospf area 0 tag procl	Configure the interface in an area assigned with the area ID (0) which uniquely identifies the routing process
(config-if)#exit	Exit interface mode
(config)#interface eth2	Enter interface mode
(config-if)#ipv6 address 4000::50/64	Configure the IPv6 address of the interface.
(config-if)#exit	Exit interface mode
(config-if)#ipv6 router rip	Configure rip instance under interface
(config-if)#exit	Exit interface mode
(config)#router ipv6 rip	Configure the rip routing process
(config-router)#neighbor fe80::5054:ff:fe85:19bc eth2	Configure RIP neighbor peer
(config-router)#exit	Exit router mode.
(config)#ipv6 access-list 1	Configure ipv6 access list
(config-ipv6-acl)# permit any 7777::/64 any	Configure ipv6 access-list to permit 7777::/64 and deny 8888::/64
(config-ipv6-acl)#exit	Exit ipv6 access-list mode
(config)#ipv6 access-list 2	Configure ipv6 access-list

OSPFv3

(config-ipv6-acl)#permit any 1111::1/128 any	Configure ipv6 access-list to permit 1111::1/128 and deny 2222::2/128
(config-ipv6-acl)#exit	Exit ipv6 access-list mode
(config)#router ipv6 ospf procl	Configure the ospfv3 routing process
(config-router)#router-id 2.2.2.2	Configure router-id to uniquely identify the router
(config-router)#redistribute rip	Redistribute rip routes
(config-router)#distribute-list 1 out rip	Configure distribute list to allow only the permitted routes redistributed from RIP
(config-router)#distribute-list 2 in	Configure distribute list to allow the installation of only the permitted OSPFv3 routes in RIB
(config-router)#exit	Exit router mode
(config)#ipv6 access-list 1	Enter access-list mode
(config-ipv6-acl)#permit any 8888::/64 any	Configure the ipv6 access-list to permit 8888::/64 alongwith 7777::/64
(config-ipv6-acl)#exit	Exit access-list mode
(config)#ipv6 access-list 2	Enter access-list mode
(config-ipv6-acl)#permit any 2222::2/128 any	Configure the ipv6 access-list to permit 2222::2/128 alongwith 1111::1/128
(config-ipv6-acl)#exit	Exit access-list mode
(config)#commit	Commit the candidate configuration to the running configuration.
(config)#exit	Exit configure mode

R3

#configure terminal	Enter configure mode
(config)#interface eth1	Enter interface mode
(config-if)#ipv6 address 4000::51/64	Configure the IPv6 address of the interface.
(config-if)#ipv6 router rip	Configure rip instance under interface
(config-if)#exit	Exit interface mode
(config)#router ipv6 rip	Configure the rip routing process
(config-router)#neighbor fe80::5054:ff:fec6:69f eth1	Configure rip neighbor peer
(config-router)#exit	Exit router mode
(config)#ipv6 route 7777::/64 eth2	Configure static route
(config)#ipv6 route 8888::/64 eth3	Configure static route
(config)#router ipv6 rip	Configure the rip routing process
(config-router)#redistribute static	Redistribute configured static routes
(config-router)#commit	Commit the candidate configuration to the running configuration.
(config-router)#end	Exit router mode

Validation 1

Verify OSPF neighborship is up between R1 and R2

R2

```
R2#show ipv6 ospf neighbor
OSPFv3 Process (Procl)
Neighbor ID      Pri   State           Dead Time   Interface   Instance ID
1.1.1.1          1    Full/Backup     00:00:38   eth1        0
```

Validation 2

Check if permitted route 7777::/64 is present in R1's routing table and denied route 8888::/64 is not present.

R1

```
R1#show ipv6 ospf route
OSPFv3 Process (Procl)
Codes: C - connected, D - Discard, O - OSPF, IA - OSPF inter area
       N1 - OSPF NSSA external type 1, N2 - OSPF NSSA external type 2
       E1 - OSPF external type 1, E2 - OSPF external type 2
Destination      Metric      Next-hop
C 2000::/64       1           directly connected, eth1, Area 0.0.0.0
E2 7777::/64      1/20      via fe80::5054:ff:fe1e:269d, eth1
```

Validation 3

Check both the routes 7777::/64 and 8888::/64 are present after 8888::/64 is permitted

R1

```
rtr1#show ipv6 ospf route
OSPFv3 Process (Procl)
Codes: C - connected, D - Discard, O - OSPF, IA - OSPF inter area
       N1 - OSPF NSSA external type 1, N2 - OSPF NSSA external type 2
       E1 - OSPF external type 1, E2 - OSPF external type 2
Destination      Metric      Next-hop
C 2000::/64       1           directly connected, eth1, Area 0.0.0.0
E2 7777::/64      1/20      via fe80::5054:ff:fe1e:269d, eth1
E2 8888::/64      1/20      via fe80::5054:ff:fe1e:269d, eth1
```

Validation 4

Check if permitted route 1111::1/128 is present in R2's routing table and denied route 2222::2/128 is not present.

R1

```
R2#show ipv6 route
IPv6 Routing Table
Codes: K - kernel route, C - connected, S - static, R - RIP, O - OSPF,
       IA - OSPF inter area, E1 - OSPF external type 1,
       E2 - OSPF external type 2, E - EVPN N1 - OSPF NSSA external type 1,
       N2 - OSPF NSSA external type 2, i - IS-IS, B - BGP
```

Timers: Uptime

IP Route Table for VRF "default"

```

C      ::1/128 via ::, lo, 00:43:35
O E2   1111::1/128 [110/20] via fe80::5054:ff:fe0c:40ed, eth1, 00:01:17
C      2000::/64 via ::, eth1, 00:36:33
C      4000::/64 via ::, eth2, 00:36:19
R      7777::/64 [120/2] via fe80::5054:ff:fe96:a3f9, eth2, 00:21:57
R      8888::/64 [120/2] via fe80::5054:ff:fe96:a3f9, eth2, 00:21:57
C      fe80::/64 via ::, eth9, 00:43:35
R2#

```

Validation 5

Check both the routes 1111::1/128 and 2222::2/128 are present after 2222::2/128 is permitted.

R1

```

R2#show ipv6 route
IPv6 Routing Table
Codes: K - kernel route, C - connected, S - static, R - RIP, O - OSPF,
      IA - OSPF inter area, E1 - OSPF external type 1,
      E2 - OSPF external type 2, E - EVPN N1 - OSPF NSSA external type 1,
      N2 - OSPF NSSA external type 2, i - IS-IS, B - BGP
Timers: Uptime

```

IP Route Table for VRF "default"

```

C      ::1/128 via ::, lo, 00:54:52
O E2   1111::1/128 [110/20] via fe80::5054:ff:fe0c:40ed, eth1, 00:12:34
C      2000::/64 via ::, eth1, 00:47:50
O E2   2222::2/128 [110/20] via fe80::5054:ff:fe0c:40ed, eth1, 00:00:02
C      4000::/64 via ::, eth2, 00:47:36
R      7777::/64 [120/2] via fe80::5054:ff:fe96:a3f9, eth2, 00:33:14
R      8888::/64 [120/2] via fe80::5054:ff:fe96:a3f9, eth2, 00:33:14
C      fe80::/64 via ::, eth9, 00:54:52

```

OSPFv3 Authentication

This example shows the configuration required for enabling OSPFv3 authentication with IPSEC on an OSPFv3-enabled interface. R1 and R2 are two routers in Area 0 connecting to the network 2000::/64.

Note: You must explicitly specify a Router ID for the OSPFv3 process to be activated.

Topology



Figure 12-100: OSPFv3 Authentication

R1

#configure terminal	Enter configure mode.
(config)#crypto ipsec transform-set tset1 esp-auth esp-md5 esp-enc esp-3des	Create a transform-set with the ESP Authentication and encryption parameters
(config)#crypto map map1 ipsec-manual	Create manual key association to the crypto-map
(config-crypto)#sequence 100	Create sequence in crypto-map
(config-crypto-seq)# set transform-set tset1	Attach transform set to cryptomap
(config-crypto-seq)# set peer fe80::923c:b3ff:fe82:8d88 spi 2	Set IPv6 peer (OSPFv3 neighbor) and SPI value
(config-crypto-seq)# set session-key outbound esp 1 cipher 66546A576E5A72346A586E3272357538782F413F4428472B authenticator 3777217A25432A46763979244226452948404D6351655468	Set the outbound session-key with cipher and auth values
(config-crypto-seq)#exit	Exit sequence mode in crypto
(config-crypto)#exit	Exit crypto mode
(config)#router ipv6 ospf 1	Create an OSPFv3 routing instance.
(config-router)#router-id 1.1.1.1	Specify a Router ID for the OSPFv3 routing process.
(config-router)#exit	Exit OSPF router mode.
(config)#interface eth1	Enter interface mode.
(config-if)#ipv6 router ospf area 0 tag 1	Enable OSPFv3 routing on an interface, and assign the Area ID 0.
(config-if)# ipv6 ospf authentication cryptomap map1	Configure OSPFv3 authentication over the OSPFv3 interface by applying the configured cryptomap
(config-if)#commit	Commit the candidate configuration to the running configuration.

R2

#configure terminal	Enter configure mode.
(config)#crypto ipsec transform-set tset1 esp-auth esp-md5 esp-enc esp-3des	Create a transform-set with the ESP Authentication and encryption parameters
(config)#crypto map map1 ipsec-manual	Create manual key association to the crypto-map
(config-crypto)#sequence 100	Create sequence in crypto-map
(config-crypto-seq)# set transform-set tset1	Attach transform set to cryptomap
(config-crypto-seq)# set peer fe80::fa8e:alff:fe0b:dd9a spi 1	Set IPv6 peer (OSPFv3 neighbor) and SPI value
(config-crypto-seq)# set session-key outbound esp 2 cipher 66546A576E5A72346A586E3272357538782F413F4428472B authenticator 3777217A25432A46763979244226452948404D6351655468	Set the outbound session-key with cipher and auth values
(config-crypto-seq)#exit	Exit sequence mode in crypto
(config-crypto)#exit	Exit crypto mode
(config)#router ipv6 ospf 1	Create an OSPFv3 routing instance.

OSPFv3

(config-router)#router-id 2.2.2.2	Specify a Router ID for the OSPFv3 routing process.
(config-router)#exit	Exit OSPF router mode.
(config)#interface eth2	Enter interface mode.
(config-if)#ipv6 router ospf area 0 tag 1	Enable OSPFv3 routing on an interface, and assign the Area ID (0).
(config-if)# ipv6 ospf authentication cryptomap map1	Configure OSPFv3 authentication over the OSPFv3 interface by applying the configured cryptomap
(config-if)#commit	Commit the candidate configuration to the running configuration.

Validation

R1

```
R1#show running-config ipsec
!  
crypto ipsec transform-set tset1 esp-auth esp-md5 esp-enc esp-3des
```

```
crypto map map1 ipsec-manual
 sequence 100
  set transform-set tset1
  set peer fe80::fa8e:alff:fe0b:dd9a spi 2
  set session-key outbound esp 1 cipher
66546A576E5A72346A586E3272357538782F413F4428472B authenticator
3777217A25432A467639792442264529
```

```
!  
R1#  
R1#show running-config ospfv3
!  
router ipv6 ospf 1
 router-id 1.1.1.1
!  
interface eth1
 ipv6 router ospf area 0.0.0.0 tag 1 instance-id 0
 ipv6 ospf authentication cryptomap map1
!
```

```
R1#show ipv6 ospf neighbor
```

```
Total number of full neighbors: 1
OSPFv3 Process (1)
Neighbor ID      Pri   State           Dead Time   Interface   Instance ID
2.2.2.2          1    Full/DR         00:00:12   eth1        0
```

```
R1#show ipv6 ospf neighbor detail
Neighbor 2.2.2.2, interface address fe80::923c:b3ff:fe82:8d88
  In the area 0.0.0.0 via interface ce0
  Neighbor priority is 1, State is Full, 6 state changes
  DR is 2.2.2.2 BDR is 1.1.1.1
  Options is 0x000113 (AF|*|*| -|R| -| -|E|V6)
  Dead timer due in 00:00:34
```

```
Database Summary List 0
Link State Request List 0
Link State Retransmission List 0
Bidirectional Forwarding Detection is enabled
```

```
R1#show crypto ipsec sadb
```

```
SRC: fe80::923c:b3ff:fe82:8d88      DST:fe80::fa8e:a1ff:fe0b:dd9a
SA: spi=0x2  sta=MATURE  auth=SHA1HMAC  enc=3DES
Added at=Wed Jun 22 03:32:11 2022 First Used at=Never Used
Used bytes=0 Used Count=0
```

```
SRC: fe80::923c:b3ff:fe82:8d88      DST:ff02::6
SA: spi=0x2  sta=MATURE  auth=SHA1HMAC  enc=3DES
Added at=Wed Jun 22 03:32:11 2022 First Used at=Never Used
Used bytes=0 Used Count=0
```

```
SRC:fe80::fa8e:a1ff:fe0b:dd9a      DST:ff02::6
SA: spi=0x1  sta=MATURE  auth=SHA1HMAC  enc=3DES
Added at=Wed Jun 22 03:32:11 2022 First Used at=Never Used
Used bytes=0 Used Count=0
```

```
SRC: fe80::923c:b3ff:fe82:8d88      DST:ff02::5
SA: spi=0x2  sta=MATURE  auth=SHA1HMAC  enc=3DES
Added at=Wed Jun 22 03:32:11 2022 First Used at=Wed Jun 22 03:32:20 2022
Used bytes=0 Used Count=0
```

```
SRC:fe80::fa8e:a1ff:fe0b:dd9a      DST:ff02::5
SA: spi=0x1  sta=MATURE  auth=SHA1HMAC  enc=3DES
Added at=Wed Jun 22 03:32:11 2022 First Used at=Wed Jun 22 03:32:21 2022
Used bytes=908 Used Count=25
```

```
SRC:fe80::fa8e:a1ff:fe0b:dd9a      DST:2000::2
SA: spi=0x1  sta=MATURE  auth=SHA1HMAC  enc=3DES
Added at=Wed Jun 22 03:32:11 2022 First Used at=Never Used
Used bytes=0 Used Count=0
```

```
R1#show crypto ipsec spdb
```

```
SRC:2000::2      DST:ff02::6
Policy Type=ipsec Dir=in
Added at=Wed Jun 22 03:32:11 2022 First Used at=Never Used
```

```
SRC:2000::2      DST:ff02::5
Policy Type=ipsec Dir=in
Added at=Wed Jun 22 03:32:11 2022 First Used at=Never Used
```

```
SRC:2000::2      DST:fe80::fa8e:a1ff:fe0b:dd9a
Policy Type=ipsec Dir=in
Added at=Wed Jun 22 03:32:11 2022 First Used at=Never Used
```

```
SRC:fe80::fa8e:a1ff:fe0b:dd9a      DST:ff02::6
```

OSPFv3

```
Policy Type=ipsec Dir=out
Added at=Wed Jun 22 03:32:11 2022 First Used at=Never Used
```

```
SRC:fe80::fa8e:a1ff:fe0b:dd9a DST:ff02::5
Policy Type=ipsec Dir=out
Added at=Wed Jun 22 03:32:11 2022 First Used at=Wed Jun 22 03:35:02 2022
```

```
SRC:fe80::fa8e:a1ff:fe0b:dd9a DST:2000::2
Policy Type=ipsec Dir=out
Added at=Wed Jun 22 03:32:11 2022 First Used at=Never Used
```

```
root@R1:~# tcpdump -i eth1
tcpdump: verbose output suppressed, use -v or -vv for full protocol decode
listening on eth1, link-type EN10MB (Ethernet), capture size 262144 bytes
03:33:20.393469 IP6 fe80::923c:b3ff:fe82:8d88 > ff02::5: ESP(spi=0x00000002,seq=0x8),
length 68
03:33:21.174899 IP6 fe80::fa8e:a1ff:fe0b:dd9a > ff02::5: ESP(spi=0x00000001,seq=0x7),
length 68
03:33:30.394602 IP6 fe80::923c:b3ff:fe82:8d88 > ff02::5: ESP(spi=0x00000002,seq=0x9),
length 68
03:33:32.175157 IP6 fe80::fa8e:a1ff:fe0b:dd9a > ff02::5: ESP(spi=0x00000001,seq=0x8),
length 68
```

R2

```
R2#show running-config ipsec
!
crypto ipsec transform-set tset1 esp-auth esp-md5 esp-enc esp-3des
```

```
crypto map map1 ipsec-manual
sequence 100
set transform-set tset1
set peer fe80::fa8e:a1ff:fe0b:dd9a spi 1
set session-key outbound esp 2 cipher
462D4A614E6452675166546A576E5A723475377821412544 authenticator
3777217A25432A467639792442264529
!
```

```
R2#show running-config ospfv3
!
router ipv6 ospf 1
router-id 2.2.2.2
bfd all-interfaces
!
interface cel
ipv6 router ospf area 0.0.0.0 tag 1 instance-id 0
ipv6 ospf authentication cryptomap map1
!
```

```
R2#show ipv6 ospf neighbor
Total number of full neighbors: 1
OSPFv3 Process (1)
Neighbor ID Pri State Dead Time Interface Instance ID
```

```
1.1.1.1          1    Full/Backup    00:00:31    ce1          0
```

```
R2#show ipv6 ospf neighbor detail
```

```
Neighbor 1.1.1.1, interface address fe80::fa8e:a1ff:fe0b:dd9a
  In the area 0.0.0.0 via interface ce1
  Neighbor priority is 1, State is Full, 6 state changes
  DR is 2.2.2.2 BDR is 1.1.1.1
  Options is 0x000113 (AF|*|*|*|-|R|*|-|E|V6)
  Dead timer due in 00:00:37
  Database Summary List 0
  Link State Request List 0
  Link State Retransmission List 0
  Bidirectional Forwarding Detection is enabled
```

```
R2#show crypto ipsec sadb
```

```
SRC:fe80::fa8e:a1ff:fe0b:dd9a  DST:fe80::923c:b3ff:fe82:8d88
SA: spi=0x1  sta=MATURE  auth=SHA1HMAC  enc=3DES
Added at=Mon Feb 18 07:39:12 2019 First Used at=Never Used
Used bytes=0 Used Count=0
```

```
SRC:fe80::fa8e:a1ff:fe0b:dd9a  DST:ff02::6
SA: spi=0x1  sta=MATURE  auth=SHA1HMAC  enc=3DES
Added at=Mon Feb 18 07:39:12 2019 First Used at=Never Used
Used bytes=0 Used Count=0
```

```
SRC:fe80::923c:b3ff:fe82:8d88  DST:ff02::6
SA: spi=0x2  sta=MATURE  auth=SHA1HMAC  enc=3DES
Added at=Mon Feb 18 07:39:12 2019 First Used at=Never Used
Used bytes=0 Used Count=0
```

```
SRC:fe80::fa8e:a1ff:fe0b:dd9a  DST:ff02::5
SA: spi=0x1  sta=MATURE  auth=SHA1HMAC  enc=3DES
Added at=Mon Feb 18 07:39:12 2019 First Used at=Mon Feb 18 07:39:14 2019
Used bytes=16072 Used Count=399
```

```
SRC:fe80::923c:b3ff:fe82:8d88  DST:ff02::5
SA: spi=0x2  sta=MATURE  auth=SHA1HMAC  enc=3DES
Added at=Mon Feb 18 07:39:12 2019 First Used at=Mon Feb 18 07:39:20 2019
Used bytes=16096 Used Count=399
```

```
SRC:fe80::923c:b3ff:fe82:8d88  DST:fe80::fa8e:a1ff:fe0b:dd9a
SA: spi=0x2  sta=MATURE  auth=SHA1HMAC  enc=3DES
Added at=Mon Feb 18 07:39:12 2019 First Used at=Never Used
Used bytes=0 Used Count=0
```

```
R2#show crypto ipsec spdb
```

```
SRC:fe80::fa8e:a1ff:fe0b:dd9a  DST:ff02::6
Policy Type=ipsec Dir=in
```

OSPFv3

Added at=Mon Feb 18 07:39:12 2019 First Used at=Never Used

SRC:fe80::fa8e:alff:fe0b:dd9a DST:ff02::5

Policy Type=ipsec Dir=in

Added at=Mon Feb 18 07:39:12 2019 First Used at=Mon Feb 18 08:44:24 2019

SRC:fe80::fa8e:alff:fe0b:dd9a DST:fe80::923c:b3ff:fe82:8d88

Policy Type=ipsec Dir=in

Added at=Mon Feb 18 07:39:12 2019 First Used at=Never Used

SRC:fe80::923c:b3ff:fe82:8d88 DST:ff02::6

Policy Type=ipsec Dir=out

Added at=Mon Feb 18 07:39:12 2019 First Used at=Never Used

SRC:fe80::923c:b3ff:fe82:8d88 DST:ff02::5

Policy Type=ipsec Dir=out

Added at=Mon Feb 18 07:39:12 2019 First Used at=Mon Feb 18 08:44:21 2019

SRC:fe80::923c:b3ff:fe82:8d88 DST:fe80::fa8e:alff:fe0b:dd9a

Policy Type=ipsec Dir=out

Added at=Mon Feb 18 07:39:12 2019 First Used at=Never Used

CHAPTER 13 IS-IS IPv4

This chapter contains basic IS-IS (Intermediate System to Intermediate System) configuration examples.

Enable IS-IS on an Interface

This example shows the minimum configuration required for enabling IS-IS on an interface. R1 and R2 are two routers in the ABC instance connecting to the network 10.10.10.0/24. After enabling IS-IS on an interface, create a routing instance, and specify the Network Entity Title (NET). IS-IS explicitly specifies a NET to begin routing. NET is comprised of the area address and the system ID of the router.

Topology

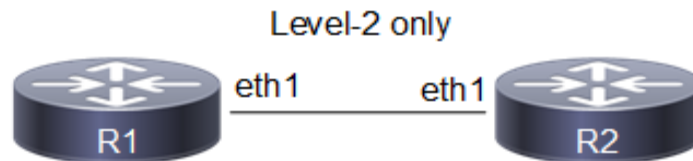

Figure 13-101: Basic IS-IS Topology

Configuration

R1

#configure terminal	Enter configure mode.
(config)#interface eth1	Enter interface mode.
(config)#ip address 21.21.21.2/24	Configure IP address on interface.
(config-if)#ip router isis ABC	Enable IS-IS routing on an interface for area 49 (ABC).
(config-if)#exit	Exit interface mode.
(config)#router isis ABC	Create an IS-IS routing instance for area 49 (ABC).
(config-router)#is-type level-2-only	Configure instance as level-2-only routing.
(config-router)#net 49.0000.0000.0001.00	Set a Network Entity Title for this instance, specifying the area address and the system ID.
(config-router)#commit	Commit candidate configuration to the running configuration

R2

#configure terminal	Enter configure mode.
(config)#interface eth1	Enter interface mode.
(config)#ip address 21.21.21.1/24	Configure IP address on interface.
(config-if)#ip router isis ABC	Enable IS-IS routing on an interface for area 49 (ABC).
(config-if)#commit	Commit candidate configuration to the running configuration

(config-if)#exit	Exit interface mode.
(config)#router isis ABC	Create an IS-IS routing instance for area 49 (ABC).
(config-router)#is-type level-2-only	Configure instance as level-2-only routing.
(config-router)#net 49.0000.0000.0002.00	Set a Network Entity Title for this instance, specifying the area address and the system ID.

Validation

```
R1#show clns neighbors
```

```
Total number of L1 adjacencies: 0
```

```
Total number of L2 adjacencies: 1
```

```
Total number of adjacencies: 1
```

```
Tag ABC: VRF : default
```

System Id	Interface	SNPA	State	Holdtime	Type	Protocol
0000.0000.0002	eth1	5254.002a.230a	Up	24	L2	IS-IS

```
R2#show clns neighbors
```

```
Total number of L1 adjacencies: 0
```

```
Total number of L2 adjacencies: 1
```

```
Total number of adjacencies: 1
```

```
Tag ABC: VRF : default
```

System Id	Interface	SNPA	State	Holdtime	Type	Protocol
0000.0000.0001	eth1	5254.00dc.0b76	Up	6	L2	IS-IS

```
R1#show clns is-neighbors
```

```
Tag ABC: VRF : default
```

System Id	Interface	State	Type	Priority	Circuit Id
0000.0000.0002	eth1	Up	L2	64	0000.0000.0001.01

```
R2#show clns is-neighbors
```

```
Tag ABC: VRF : default
```

System Id	Interface	State	Type	Priority	Circuit Id
0000.0000.0001	eth1	Up	L2	64	0000.0000.0001.01

```
R1#show isis interface
```

```
eth1 is up, line protocol is up
```

```
Routing Protocol: IS-IS (ABC)
```

```
Network Type: Broadcast
```

```
Circuit Type: level-1-2
```

```
Local circuit ID: 0x01
```

```
Extended Local circuit ID: 0x00000003
```

```
Local SNPA: 5254.00dc.0b76
```

```
IP interface address:
```

```
21.21.21.2/24
```

```
IPv6 interface address:
```

```
fe80::5054:ff:fedc:b76/64
```

```
Level-2 Metric: 10/10, Priority: 64, Circuit ID: 0000.0000.0001.01
```

```
Number of active level-2 adjacencies: 1
```

```
Level-2 LSP MTU: 1492
```

```
Next IS-IS LAN Level-2 Hello in 0 milliseconds
```



```
R2#show isis interface
eth1 is up, line protocol is up
  Routing Protocol: IS-IS (ABC)
    Network Type: Broadcast
    Circuit Type: level-1-2
    Local circuit ID: 0x01
    Extended Local circuit ID: 0x00000003
    Local SNPA: 5254.002a.230a
    IP interface address:
      21.21.21.1/24
    IPv6 interface address:
      fe80::5054:ff:fe2a:230a/64
    Level-2 Metric: 10/10, Priority: 64, Circuit ID: 0000.0000.0001.01
    Number of active level-2 adjacencies: 1
    Level-2 LSP MTU: 1492
    Next IS-IS LAN Level-2 Hello in 1 seconds
```

```
R1#show ip isis route
```

```
Codes: C - connected, E - external, L1 - IS-IS level-1, L2 - IS-IS level-2
       ia - IS-IS inter area, D - discard, e - external metric
       ** - invalid
```

```
Tag ABC: VRF : default
```

	Destination	Metric	Next-Hop	Interface	Tag
C	21.21.21.0/24	10	--	eth1	0

```
R2#show ip isis route
```

```
Codes: C - connected, E - external, L1 - IS-IS level-1, L2 - IS-IS level-2
       ia - IS-IS inter area, D - discard, e - external metric
       ** - invalid
```

```
Tag ABC: VRF : default
```

	Destination	Metric	Next-Hop	Interface	Tag
C	21.21.21.0/24	10	--	eth1	0

```
R1#show isis topology
```

```
Tag ABC: VRF : default
```

```
IS-IS paths to level-2 routers
```

System Id	Metric	Next-Hop	Interface	SNPA
0000.0000.0001	--			
0000.0000.0002	10	0000.0000.0002	eth1	
5254.002a.230a				

```
R2#show isis topology
```

```
Tag ABC: VRF : default
```

```
IS-IS paths to level-2 routers
```

System Id	Metric	Next-Hop	Interface	SNPA
0000.0000.0001	10	0000.0000.0001	eth1	
5254.00dc.0b76				
0000.0000.0002	--			

```
R1#show isis database
```

```
Tag ABC: VRF : default
```

IS-IS Level-2 Link State Database:

LSPID	LSP Seq Num	LSP Checksum	LSP Holdtime	ATT/P/OL
0000.0000.0001.00-00*	0x00000009	0x6C2D	980	0/0/0
0000.0000.0001.01-00*	0x00000003	0x1DBB	980	0/0/0
0000.0000.0002.00-00	0x0000000A	0x5444	980	0/0/0

R2#show isis database

Tag ABC: VRF : default

IS-IS Level-2 Link State Database:

LSPID	LSP Seq Num	LSP Checksum	LSP Holdtime	ATT/P/OL
0000.0000.0001.00-00	0x00000009	0x6C2D	942	0/0/0
0000.0000.0001.01-00	0x00000003	0x1DBB	942	0/0/0
0000.0000.0002.00-00*	0x0000000A	0x5444	944	0/0/0

Set Priority

This example describes how to set the priority for an interface. Set a high priority for a router to make it the Designated IS (DIS). Router R2 is configured to have a priority of 125, this is higher than the default priority (64) of R1. This makes R2 the DIS.

Topology

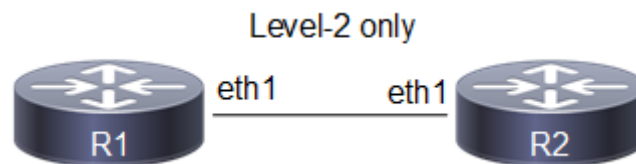

Figure 13-102: Set IS-IS Priority

Configuration

R1

(config)#interface eth1	Enter interface mode.
(config-if)#ip router isis ABC	Enable IS-IS routing on an interface for area 49 (ABC).
(config)#ip address 21.21.21.2/24	Configure IP address on interface.
(config-if)#commit	Commit candidate configuration to the running configuration
(config-if)#exit	Exit interface mode.
(config)#router isis ABC	Create an IS-IS routing instance for area 49 (ABC).
(config-router)#is-type level-2-only	Configure instance as level-2-only routing.
(config-router)#net 49.0000.0000.0001.00	Set a Network Entity Title for this instance, specifying the area address and the system ID.
(config-router)#commit	Commit candidate configuration to the running configuration

R2

(config)#interface eth1	Enter interface mode.
(config)#ip address 21.21.21.1/24	Configure IP address on interface.
(config-if)#ip router isis ABC	Enable IS-IS routing on an interface for area 49 (ABC).
(config-if)#isis priority 125	Specify the router priority to a higher priority (125) to make R2 the designated IS (DIS).
(config-if)#commit	Commit candidate configuration to the running configuration
(config-if)#exit	Exit interface mode.
(config)#router isis ABC	Create an IS-IS routing instance for area 49 (ABC).
(config-router)#is-type level-2-only	Configure instance as level-2-only routing.
(config-router)#net 49.0000.0000.0002.00	Set a Network Entity Title for this instance, specifying the area address and the system ID.

Validation

```
R1#show clns neighbors
```

```
Total number of L1 adjacencies: 0
```

```
Total number of L2 adjacencies: 1
```

```
Total number of adjacencies: 1
```

```
Tag ABC: VRF : default
```

System Id	Interface	SNPA	State	Holdtime	Type	Protocol
0000.0000.0002	eth1	5254.002a.230a	Up	6	L2	IS-IS

```
R2#show clns neighbors
```

```
Total number of L1 adjacencies: 0
```

```
Total number of L2 adjacencies: 1
```

```
Total number of adjacencies: 1
```

```
Tag ABC: VRF : default
```

System Id	Interface	SNPA	State	Holdtime	Type	Protocol
0000.0000.0001	eth1	5254.00dc.0b76	Up	21	L2	IS-IS

```
R1#show clns is-neighbors
```

```
Tag ABC: VRF : default
```

System Id	Interface	State	Type	Priority	Circuit Id
0000.0000.0002	eth1	Up	L2	125	0000.0000.0002.01

```
R2#show clns is-neighbors
```

```
Tag ABC: VRF : default
```

System Id	Interface	State	Type	Priority	Circuit Id
0000.0000.0001	eth1	Up	L2	64	0000.0000.0002.01

```
R1#show isis interface
```

```
eth1 is up, line protocol is up
```

```
Routing Protocol: IS-IS (ABC)
```

```
Network Type: Broadcast
```

```
Circuit Type: level-1-2
```

```
Local circuit ID: 0x01
```

```
Extended Local circuit ID: 0x00000003
Local SNPA: 5254.00dc.0b76
IP interface address:
  21.21.21.2/24
IPv6 interface address:
  fe80::5054:ff:fedc:b76/64
Level-2 Metric: 10/10, Priority: 64, Circuit ID: 0000.0000.0002.01
Number of active level-2 adjacencies: 1
Level-2 LSP MTU: 1492
Next IS-IS LAN Level-2 Hello in 1 seconds
```

```
R2#show isis interface
eth1 is up, line protocol is up
  Routing Protocol: IS-IS (ABC)
    Network Type: Broadcast
    Circuit Type: level-1-2
    Local circuit ID: 0x01
    Extended Local circuit ID: 0x00000003
    Local SNPA: 5254.002a.230a
    IP interface address:
      21.21.21.1/24
    IPv6 interface address:
      fe80::5054:ff:fe2a:230a/64
    Level-2 Metric: 10/10, Priority: 125, Circuit ID: 0000.0000.0002.01
    Number of active level-2 adjacencies: 1
    Level-2 LSP MTU: 1492
    Next IS-IS LAN Level-2 Hello in 737 milliseconds
```

Dynamic hostname

This example shows how to configure Dynamic Hostname for an ISIS instance. Dynamic hostname is the method of mapping name-to-systemID. It allows the routing protocol to advertise symbolic names in the IS-IS PDUs. This is done by the addition of a new TLV which allows the IS-IS routers to include the name-to-systemID mapping data in their LSPs. This allows for simple and reliable transport of name mapping across IS-IS networks. Dynamic hostname can be either the hostname of the node or the tag of the configured ISIS instance.

Note: Dynamic-hostname has to be configured on all nodes for it to take effect.

Topology

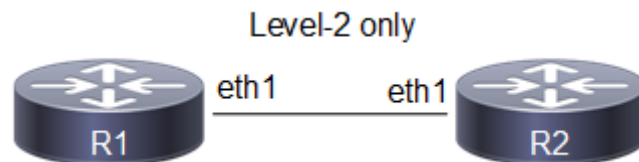

Figure 13-103: Basic dynamic hostname topology

Configuration

R1

(config)#interface eth1	Enter interface mode.
(config-if)#ip router isis ABC	Enable IS-IS routing on an interface for area 49 (ABC).
(config)#ip address 21.21.21.2/24	Configure IP address on interface.
(config-if)#commit	Commit candidate configuration to the running configuration
(config-if)#exit	Exit interface mode.
(config)#router isis ABC	Create an IS-IS routing instance for area 49 (ABC).
(config-router)#is-type level-2-only	Configure instance as level-2-only routing.
(config-router)#net 49.0000.0000.0001.00	Set a Network Entity Title for this instance, specifying the area address and the system ID.
(config-router)#dynamic-hostname	Configure the hostname to be advertised for an ISIS instance.
(config-router)#commit	Commit candidate configuration to the running configuration

R2

(config)#interface eth1	Enter interface mode.
(config)#ip address 21.21.21.1/24	Configure IP address on interface.
(config-if)#ip router isis ABC	Enable IS-IS routing on an interface for area 49 (ABC).
(config-if)#commit	Commit candidate configuration to the running configuration
(config-if)#exit	Exit interface mode.
(config)#router isis ABC	Create an IS-IS routing instance for area 49 (ABC).
(config-router)#is-type level-2-only	Configure instance as level-2-only routing.
(config-router)#net 49.0000.0000.0002.00	Set a Network Entity Title for this instance, specifying the area address and the system ID.
(config-router)#dynamic-hostname	Configure the hostname to be advertised for an ISIS instance.
(config-router)#commit	Commit candidate configuration to the running configuration

Validation

```
R1#show clns neighbors
```

```
Total number of L1 adjacencies: 0
```

```
Total number of L2 adjacencies: 1
```

```
Total number of adjacencies: 1
```

```
Tag ABC: VRF : default
```

System Id	Interface	SNPA	State	Holdtime	Type	Protocol
R2	eth1	5254.002a.230a	Up	28	L2	IS-IS

```
R2#show clns neighbors
```

```
Total number of L1 adjacencies: 0
```

```
Total number of L2 adjacencies: 1
```

```
Total number of adjacencies: 1
```

```
Tag ABC: VRF : default
```

System Id	Interface	SNPA	State	Holdtime	Type	Protocol
R1	eth1	5254.00dc.0b76	Up	7	L2	IS-IS

```
R1#show clns is-neighbors
```

```
Tag ABC: VRF : default
System Id      Interface  State  Type  Priority  Circuit Id
R2             eth1      Up     L2    64        0000.0000.0001.01
```

```
R2#show clns is-neighbors
```

```
Tag ABC: VRF : default
System Id      Interface  State  Type  Priority  Circuit Id
R1             eth1      Up     L2    64        0000.0000.0001.01
```

```
R1#show isis topology
```

```
Tag ABC: VRF : default
IS-IS paths to level-2 routers
System Id      Metric      Next-Hop      Interface  SNPA
R1             --
R2             10         R2            eth1       5254.002a.230a
```

```
R2#show isis topology
```

```
Tag ABC: VRF : default
IS-IS paths to level-2 routers
System Id      Metric      Next-Hop      Interface  SNPA
R1             10         R1            eth1       5254.00dc.0b76
R2             --
```

```
R1#show isis database
```

```
Tag ABC: VRF : default
IS-IS Level-2 Link State Database:
LSPID          LSP Seq Num  LSP Checksum  LSP Holdtime  ATT/P/OL
R1.00-00      * 0x0000000B  0x1D6B        1170          0/0/0
R1.01-00      * 0x00000004  0x1BBC        538           0/0/0
R2.00-00      * 0x0000000C  0x0D79        1166          0/0/0
```

```
R2#show isis database
```

```
Tag ABC: VRF : default
IS-IS Level-2 Link State Database:
LSPID          LSP Seq Num  LSP Checksum  LSP Holdtime  ATT/P/OL
R1.00-00      * 0x0000000B  0x1D6B        1078          0/0/0
R1.01-00      * 0x00000004  0x1BBC        445           0/0/0
R2.00-00      * 0x0000000C  0x0D79        1075          0/0/0
```

Redistribute Routes into IS-IS

In this example, the configuration causes OSPF routes to be imported into the IS-IS routing table, and advertised into the ABC instance.

Topology

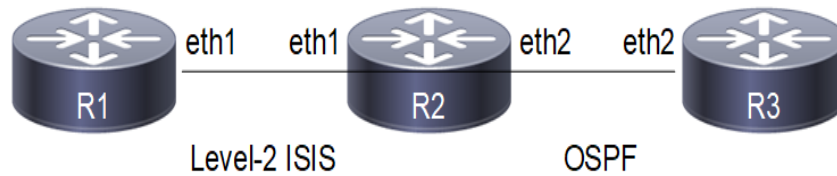

Figure 13-104: Redistribute Routes Into IS-IS

Configuration

R1

<code>(config)#interface eth1</code>	Enter interface mode.
<code>(config-if)#ip router isis ABC</code>	Enable IS-IS routing on an interface for area 49 (ABC).
<code>(config)#ip address 21.21.21.2/24</code>	Configure IP address on interface.
<code>(config-if)#commit</code>	Commit candidate configuration to the running configuration
<code>(config-if)#exit</code>	Exit interface mode.
<code>(config)#router isis ABC</code>	Create an IS-IS routing instance for area 49 (ABC).
<code>(config-router)#is-type level-2-only</code>	Configure instance as level-2-only routing.
<code>(config-router)#net 49.0000.0000.0001.00</code>	Set a Network Entity Title for this instance, specifying the area address and the system ID.
<code>(config-router)#dynamic-hostname</code>	Configure the hostname to be advertised for an ISIS instance.
<code>(config-router)#commit</code>	Commit candidate configuration to the running configuration

R2

<code>(config)#interface eth1</code>	Enter interface mode.
<code>(config-if)#ip address 21.21.21.1/24</code>	Configure IP address on interface.
<code>(config-if)#commit</code>	Commit candidate configuration to the running configuration
<code>(config-if)#ip router isis ABC</code>	Enable IS-IS routing on an interface for area 49 (ABC).
<code>(config-if)#commit</code>	Commit candidate configuration to the running configuration
<code>(config-if)#exit</code>	Exit interface mode.
<code>(config)#interface eth2</code>	Enter interface mode.
<code>(config-if)#ip address 31.31.31.1/24</code>	Configure IP address on interface.
<code>(config-if)#commit</code>	Commit candidate configuration to the running configuration
<code>(config-if)#exit</code>	Exit interface mode.
<code>(config)#router isis ABC</code>	Create an IS-IS routing instance for area 49 (ABC).
<code>(config-router)#is-type level-2-only</code>	Configure instance as level-2-only routing.
<code>(config-router)#net 49.0000.0000.0002.00</code>	Set a Network Entity Title for this instance, specifying the area address and the system ID.
<code>(config-router)#redistribute ospf</code>	Specify redistributing routes from other routing protocol (OSPF) into IS-IS.

(config-router)#dynamic-hostname	Configure the hostname to be advertised for an ISIS instance.
(config-router)#commit	Commit candidate configuration to the running configuration
(config-router)#exit	Exit interface mode.
(config)#interface lo	Configure interface lo
(config-if)#ip address 2.2.2.2/32 secondary	Configure secondary IP address to loopback interface
(config-if)#commit	Commit candidate configuration to the running configuration
(config-if)#exit	Exit interface mode.
(config)#router ospf 100	Configure OSPF routing process and specify the tag (100) which uniquely identifies the routing process
(config-router)#ospf router-id 2.2.2.2	Specify a Router ID (2.2.2.2) for the OSPF routing process.
(config-router)#network 2.2.2.2/32 area 0.0.0.0	Advertising 2.2.2.2 network
(config-router)#network 31.31.31.0/24 area 0.0.0.0	Advertising 31 network
(config-router)#commit	Commit candidate configuration to the running configuration
(config-router)#exit	Exit router mode.

R3

(config)#interface eth2	Enter interface mode.
(config-if)#ip address 31.31.31.2/24	Configure IP address on interface.
(config-if)#commit	Commit candidate configuration to the running configuration
(config-if)#exit	Exit interface mode.
(config)#interface lo	Configure interface lo
(config-if)#ip address 3.3.3.3/32 secondary	Configure secondary IP address to loopback interface
(config-if)#commit	Commit candidate configuration to the running configuration
(config-if)#exit	Exit interface mode.
(config)#router ospf 100	Configure OSPF routing process and specify the tag (100) which uniquely identifies the routing process
(config-router)#ospf router-id 3.3.3.3	Specify a Router ID (3.3.3.3) for the OSPF routing process.
(config-router)#network 3.3.3.3/32 area 0.0.0.0	Advertising 3.3.3.3 network
(config-router)#network 31.31.31.0/24 area 0.0.0.0	Advertising 31 network
(config-if)#commit	Commit candidate configuration to the running configuration

Validation

```
R1#show clns neighbors
```

```
Total number of L1 adjacencies: 0
```

```
Total number of L2 adjacencies: 1
```

```
Total number of adjacencies: 1
```

```
Tag ABC: VRF : default
```

System Id	Interface	SNPA	State	Holdtime	Type	Protocol
R2	eth1	5254.002a.230a	Up	25	L2	IS-IS

R2#show clns neighbors

Total number of L1 adjacencies: 0
 Total number of L2 adjacencies: 1
 Total number of adjacencies: 1

Tag ABC: VRF : default

System Id	Interface	SNPA	State	Holdtime	Type	Protocol
R1	eth1	5254.00dc.0b76	Up	6	L2	IS-IS

R1#show clns is-neighbors

Tag ABC: VRF : default

System Id	Interface	State	Type	Priority	Circuit Id
R2	eth1	Up	L2	64	0000.0000.0001.01

R2#show clns is-neighbors

Tag ABC: VRF : default

System Id	Interface	State	Type	Priority	Circuit Id
R1	eth1	Up	L2	64	0000.0000.0001.01

R1#show isis topology

Tag ABC: VRF : default

IS-IS paths to level-2 routers

System Id	Metric	Next-Hop	Interface	SNPA
R1	--			
R2	10	R2	eth1	5254.002a.230a

R2#show isis topology

Tag ABC: VRF : default

IS-IS paths to level-2 routers

System Id	Metric	Next-Hop	Interface	SNPA
R1	10	R1	eth1	5254.00dc.0b76
R2	--			

R1#show isis database

Tag ABC: VRF : default

IS-IS Level-2 Link State Database:

LSPID	LSP Seq Num	LSP Checksum	LSP Holdtime	ATT/P/OL
R1.00-00	* 0x00000003	0x2D63	1096	0/0/0
R1.01-00	* 0x00000002	0x1FBA	1096	0/0/0
R2.00-00	0x00000004	0xEF02	1108	0/0/0

R2#show isis database

Tag ABC: VRF : default

IS-IS Level-2 Link State Database:

LSPID	LSP Seq Num	LSP Checksum	LSP Holdtime	ATT/P/OL
R1.00-00	0x00000003	0x2D63	1021	0/0/0
R1.01-00	0x00000002	0x1FBA	1021	0/0/0
R2.00-00	* 0x00000004	0xEF02	1035	0/0/0

R1#show ip isis route

Codes: C - connected, E - external, L1 - IS-IS level-1, L2 - IS-IS level-2
 ia - IS-IS inter area, D - discard, e - external metric
 ** - invalid

Tag ABC: VRF : default

	Destination	Metric	Next-Hop	Interface	Tag
L2	2.2.2.2/32	10	21.21.21.1	eth1	0
L2	3.3.3.3/32	10	21.21.21.1	eth1	0
C	21.21.21.0/24	10	--	eth1	0
L2	31.31.31.0/24	10	21.21.21.1	eth1	0

R2#show ip isis route

Codes: C - connected, E - external, L1 - IS-IS level-1, L2 - IS-IS level-2
 ia - IS-IS inter area, D - discard, e - external metric
 ** - invalid

Tag ABC: VRF : default

	Destination	Metric	Next-Hop	Interface	Tag
E	2.2.2.2/32	0	--	--	0
E	3.3.3.3/32	0	--	--	0
C	21.21.21.0/24	10	--	eth1	0
E	31.31.31.0/24	0	--	--	0

R1#show ip route

Codes: K - kernel, C - connected, S - static, R - RIP, B - BGP
 O - OSPF, IA - OSPF inter area
 N1 - OSPF NSSA external type 1, N2 - OSPF NSSA external type 2
 E1 - OSPF external type 1, E2 - OSPF external type 2
 i - IS-IS, L1 - IS-IS level-1, L2 - IS-IS level-2,
 ia - IS-IS inter area, E - EVPN,
 v - vrf leaked
 * - candidate default

IP Route Table for VRF "default"

```
i L2      2.2.2.2/32 [115/10] via 21.21.21.1, eth1, 00:16:54
i L2      3.3.3.3/32 [115/10] via 21.21.21.1, eth1, 00:16:43
C         10.12.30.0/24 is directly connected, eth0, 00:24:28
C         21.21.21.0/24 is directly connected, eth1, 00:18:37
i L2      31.31.31.0/24 [115/10] via 21.21.21.1, eth1, 00:16:54
C         127.0.0.0/8 is directly connected, lo, 00:24:28
```

Gateway of last resort is not set

R2#show ip route

Codes: K - kernel, C - connected, S - static, R - RIP, B - BGP
 O - OSPF, IA - OSPF inter area
 N1 - OSPF NSSA external type 1, N2 - OSPF NSSA external type 2
 E1 - OSPF external type 1, E2 - OSPF external type 2
 i - IS-IS, L1 - IS-IS level-1, L2 - IS-IS level-2,
 ia - IS-IS inter area, E - EVPN,
 v - vrf leaked
 * - candidate default

IP Route Table for VRF "default"

```
C         2.2.2.2/32 is directly connected, lo, 00:21:31
O         3.3.3.3/32 [110/2] via 31.31.31.2, eth2, 00:20:14
```

```

C          10.12.30.0/24 is directly connected, eth0, 00:27:36
C          21.21.21.0/24 is directly connected, eth1, 00:21:31
C          31.31.31.0/24 is directly connected, eth2, 00:21:31
C          127.0.0.0/8 is directly connected, lo, 00:27:36

```

Gateway of last resort is not set

```
R2#show ip ospf neighbor
```

```

Total number of full neighbors: 1
OSPF process 100 VRF(default):
Neighbor ID      Pri  State           Dead Time   Address      Interface
Instance ID
3.3.3.3          1   Full/Backup     00:00:35   31.31.31.2   eth2
0

```

```
R3#show ip ospf neighbor
```

```

Total number of full neighbors: 1
OSPF process 100 VRF(default):
Neighbor ID      Pri  State           Dead Time   Address      Interface
Instance ID
2.2.2.2          1   Full/DR         00:00:32   31.31.31.1   eth2
0

```

```
R2#show ip ospf route
```

```

OSPF process 100:
Codes: C - connected, D - Discard, O - OSPF, IA - OSPF inter area
       N1 - OSPF NSSA external type 1, N2 - OSPF NSSA external type 2
       E1 - OSPF external type 1, E2 - OSPF external type 2
OSPF LFA attributes:
       P - Primary, SP - Secondary-Path, LP - Link Protecting,
       NP - Node Protecting, BID - Broadcast Link Protecting

```

```

C 2.2.2.2/32 [1] is directly connected, lo, Area 0.0.0.0
O 3.3.3.3/32 [2] via 31.31.31.2, eth2, Area 0.0.0.0
C 31.31.31.0/24 [1] is directly connected, eth2, Area 0.0.0.0

```

```
R3#show ip ospf route
```

```

OSPF process 100:
Codes: C - connected, D - Discard, O - OSPF, IA - OSPF inter area
       N1 - OSPF NSSA external type 1, N2 - OSPF NSSA external type 2
       E1 - OSPF external type 1, E2 - OSPF external type 2
OSPF LFA attributes:
       P - Primary, SP - Secondary-Path, LP - Link Protecting,
       NP - Node Protecting, BID - Broadcast Link Protecting

```

```

O 2.2.2.2/32 [2] via 31.31.31.1, eth2, Area 0.0.0.0
C 3.3.3.3/32 [1] is directly connected, lo, Area 0.0.0.0
C 31.31.31.0/24 [1] is directly connected, eth2, Area 0.0.0.0

```

```
R3#show ip route
```

```

Codes: K - kernel, C - connected, S - static, R - RIP, B - BGP
       O - OSPF, IA - OSPF inter area
       N1 - OSPF NSSA external type 1, N2 - OSPF NSSA external type 2

```

E1 - OSPF external type 1, E2 - OSPF external type 2
i - IS-IS, L1 - IS-IS level-1, L2 - IS-IS level-2,
ia - IS-IS inter area, E - EVPN,
v - vrf leaked
* - candidate default

IP Route Table for VRF "default"

```
O      2.2.2.2/32 [110/2] via 31.31.31.1, eth2, 00:19:47
C      3.3.3.3/32 is directly connected, lo, 00:20:40
C      10.12.30.0/24 is directly connected, eth0, 00:26:28
C      31.31.31.0/24 is directly connected, eth2, 00:20:40
C      127.0.0.0/8 is directly connected, lo, 00:26:28
```

Gateway of last resort is not set

Metric

You can make a route the preferred route by changing its metric. In this example, the cost has been configured to make R3 the next hop for R1.

The default metric for each interface is 10. Interface eth3 on R2 has a metric of 20, and Interface eth2 on R3 has a metric of 30. The total cost to reach 10.10.14.0/24 (R4) through R2 and R3 is computed as follows:

R2: $10+20 = 30$

R3: $10+30 = 40$

In this topology, R1 chooses R2 as its next hop for destination 10.10.14.0/24.

Note: Below configuration is applicable for narrow (non-wide) metric-style. Wide metric can be configured by using the CLI's "metric-style wide" under isis instance and "isis wide-metric < 1-16777214>" under interface mode.

Topology

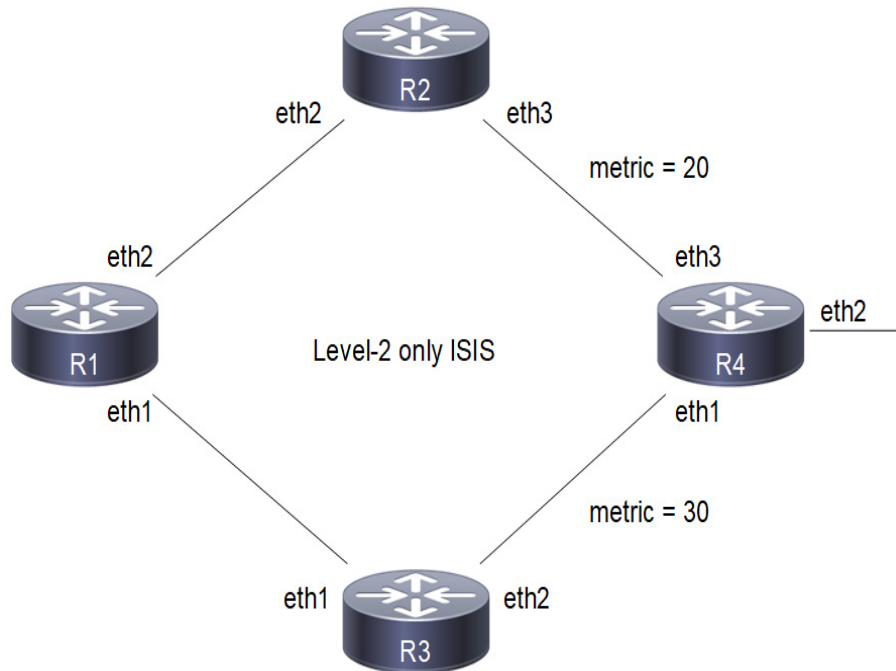

Figure 13-105:

Configuration

R1

#configure terminal	Enter configure mode.
(config)#interface eth1	Enter interface mode.
(config-if)#ip address 20.20.20.1/24	Configure IP address on interface.
(config-if)#ip router isis ABC	Enable IS-IS routing on an interface for area 49 (ABC).
(config-if)#commit	Commit candidate configuration to the running configuration
(config-if)#exit	Exit interface mode.
(config)#interface eth2	Enter interface mode.
(config-if)#ip address 30.30.30.1/24	Configure IP address on interface.
(config-if)#ip router isis ABC	Enable IS-IS routing on an interface for area 49 (ABC).
(config-if)#commit	Commit candidate configuration to the running configuration
(config-if)#exit	Exit interface mode.
(config)#router isis ABC	Create an IS-IS routing instance for area 49 (ABC).
(config-router)#is-type level-2-only	Configure instance as level-2-only routing.
(config-router)#dynamic-hostname	Configure the hostname to be advertised for an ISIS instance.
(config-router)#net 49.0000.0000.0001.00	Set a Network Entity Title for this instance, specifying the area address and the system ID.
(config-router)#commit	Commit candidate configuration to the running configuration

R2

(config)#interface eth2	Enter interface mode.
(config-if)#ip address 30.30.30.2/24	Configure IP address on interface.
(config-if)#ip router isis ABC	Enable IS-IS routing on an interface for area 49 (ABC).
(config-if)#commit	Commit candidate configuration to the running configuration
(config-if)#exit	Exit interface mode.
(config)#interface eth3	Enter interface mode.
(config-if)#ip address 40.40.40.1/24	Configure IP address on interface.
(config-if)#ip router isis ABC	Enable IS-IS routing on an interface for area 49 (ABC).
(config-if)#commit	Commit candidate configuration to the running configuration
(config-if)#isis metric 20	Set the value of IS-IS metric (on eth3) to 20.
(config-if)#exit	Exit interface mode.
(config)#router isis ABC	Create an IS-IS routing instance for area 49 (ABC).
(config-router)#is-type level-2-only	Configure instance as level-2-only routing.
(config-router)#dynamic-hostname	Configure the hostname to be advertised for an ISIS instance.
(config-router)#net 49.0000.0000.0002.00	Set a Network Entity Title for this instance, specifying the area address and the system ID.
(config-router)#commit	Commit candidate configuration to the running configuration

R3

(config)#interface eth1	Enter interface mode.
(config-if)#ip address 20.20.20.2/24	Configure IP address on interface.
(config-if)#ip router isis ABC	Enable IS-IS routing on an interface for area 49 (ABC).
(config-if)#commit	Commit candidate configuration to the running configuration
(config-if)#exit	Exit interface mode.
(config)#interface eth2	Enter interface mode.
(config-if)#ip router isis ABC	Enable IS-IS routing on an interface for area 49 (ABC).
(config-if)#ip address 50.50.50.1/24	Configure IP address on interface.
(config-if)#isis metric 30	Set the value of IS-IS metric (on eth2) to 30.
(config-if)#commit	Commit candidate configuration to the running configuration
(config-if)#exit	Exit interface mode.
(config)#router isis ABC	Create an IS-IS routing instance for area 49 (ABC).
(config-router)#is-type level-2-only	Configure instance as level-2-only routing.

(config-router)#dynamic-hostname	Configure the hostname to be advertised for an ISIS instance.
(config-router)#net 49.0000.0000.0003.00	Set a Network Entity Title for this instance, specifying the area address and the system ID.
(config-router)#commit	Commit candidate configuration to the running configuration

R4

(config)#interface eth1	Enter interface mode.
(config-if)#ip router isis ABC	Enable IS-IS routing on an interface for area 49 (ABC).
(config-if)#ip address 50.50.50.2/24	Configure IP address on interface.
(config-if)#commit	Commit candidate configuration to the running configuration
(config-if)#exit	Exit interface mode.
(config)#interface eth3	Enter interface mode.
(config-if)#ip router isis ABC	Enable IS-IS routing on an interface for area 49 (ABC).
(config-if)#ip address 40.40.40.2/24	Configure IP address on interface.
(config-if)#commit	Commit candidate configuration to the running configuration
(config-if)#exit	Exit interface mode.
(config)#router isis ABC	Create an IS-IS routing instance for area 49 (ABC).
(config-router)#is-type level-2-only	Configure instance as level-2-only routing.
(config-router)#dynamic-hostname	Configure the hostname to be advertised for an ISIS instance.
(config-router)#net 49.0000.0000.0004.00	Set a Network Entity Title for this instance, specifying the area address and the system ID.
(config-if)#commit	Commit candidate configuration to the running configuration

Validation

```
R1#show clns neighbors
```

```
Total number of L1 adjacencies: 0
Total number of L2 adjacencies: 2
Total number of adjacencies: 2
```

```
Tag ABC: VRF : default
```

System Id	Interface	SNPA	State	Holdtime	Type	Protocol
R3	eth1	5254.00dc.2f11	Up	5	L2	IS-IS
R2	eth2	5254.007e.5ade	Up	20	L2	IS-IS

```
R2#show clns neighbors
```

```
Total number of L1 adjacencies: 0
Total number of L2 adjacencies: 2
Total number of adjacencies: 2
```

```
Tag ABC: VRF : default
```

System Id	Interface	SNPA	State	Holdtime	Type	Protocol
R1	eth2	5254.00a1.6afe	Up	7	L2	IS-IS

```
R4          eth3          5254.00b1.d6fb      Up      8          L2      IS-IS
```

```
R3#show clns neighbors
```

```
Total number of L1 adjacencies: 0
```

```
Total number of L2 adjacencies: 2
```

```
Total number of adjacencies: 2
```

```
Tag ABC: VRF : default
```

System Id	Interface	SNPA	State	Holdtime	Type	Protocol
R1	eth1	5254.00dc.0b76	Up	20	L2	IS-IS
R4	eth2	5254.00f5.35a4	Up	8	L2	IS-IS

```
R4#show clns neighbors
```

```
Total number of L1 adjacencies: 0
```

```
Total number of L2 adjacencies: 2
```

```
Total number of adjacencies: 2
```

```
Tag ABC: VRF : default
```

System Id	Interface	SNPA	State	Holdtime	Type	Protocol
R3	eth1	5254.00a8.940d	Up	25	L2	IS-IS
R2	eth3	5254.0049.c509	Up	25	L2	IS-IS

```
R1#show isis topology
```

```
Tag ABC: VRF : default
```

```
IS-IS paths to level-2 routers
```

System Id	Metric	Next-Hop	Interface	SNPA
R1	--			
R2	10	R2 eth2	5254.007e.5ade	
R3	10	R3 eth1	5254.00dc.2f11	
R4	30	R2 eth2	5254.007e.5ade	

```
R2#show isis topology
```

```
Tag ABC: VRF : default
```

```
IS-IS paths to level-2 routers
```

System Id	Metric	Next-Hop	Interface	SNPA
R1	10	R1 eth2	5254.00a1.6afe	
R2	--			
R3	20	R1 eth2	5254.00a1.6afe	
R4	20	R4 eth3	5254.00b1.d6fb	

```
R3#show isis topology
```

```
Tag ABC: VRF : default
```

```
IS-IS paths to level-2 routers
```

System Id	Metric	Next-Hop	Interface	SNPA
R1	10	R1 eth1	5254.00dc.0b76	
R2	20	R1 eth1	5254.00dc.0b76	
R3	--			
R4	30	R4 eth2	5254.00f5.35a4	

```
R4#show isis topology
```

```
Tag ABC: VRF : default
```

```
IS-IS paths to level-2 routers
```

System Id	Metric	Next-Hop	Interface	SNPA
-----------	--------	----------	-----------	------

R1	20	R2	eth3	5254.0049.c509
		R3	eth1	5254.00a8.940d
R2	10	R2	eth3	5254.0049.c509
R3	10	R3	eth1	5254.00a8.940d
R4	--			

R1#show ip isis route

Codes: C - connected, E - external, L1 - IS-IS level-1, L2 - IS-IS level-2
 ia - IS-IS inter area, D - discard, e - external metric
 ** - invalid

Tag ABC: VRF : default

	Destination	Metric	Next-Hop	Interface	Tag
C	20.20.20.0/24	10	--	eth1	0
C	30.30.30.0/24	10	--	eth2	0
L2	40.40.40.0/24	30	30.30.30.2	eth2	0
L2	50.50.50.0/24	40	30.30.30.2	eth2	0
			20.20.20.2	eth1	0

R2#show ip isis route

Codes: C - connected, E - external, L1 - IS-IS level-1, L2 - IS-IS level-2
 ia - IS-IS inter area, D - discard, e - external metric
 ** - invalid

Tag ABC: VRF : default

	Destination	Metric	Next-Hop	Interface	Tag
L2	20.20.20.0/24	20	30.30.30.1	eth2	0
C	30.30.30.0/24	10	--	eth2	0
C	40.40.40.0/24	20	--	eth3	0
L2	50.50.50.0/24	30	40.40.40.2	eth3	0

R3#show ip isis route

Codes: C - connected, E - external, L1 - IS-IS level-1, L2 - IS-IS level-2
 ia - IS-IS inter area, D - discard, e - external metric
 ** - invalid

Tag ABC: VRF : default

	Destination	Metric	Next-Hop	Interface	Tag
C	20.20.20.0/24	10	--	eth1	0
L2	30.30.30.0/24	20	20.20.20.1	eth1	0
L2	40.40.40.0/24	40	20.20.20.1	eth1	0
			50.50.50.2	eth2	0
C	50.50.50.0/24	30	--	eth2	0

R4#show ip isis route

Codes: C - connected, E - external, L1 - IS-IS level-1, L2 - IS-IS level-2
 ia - IS-IS inter area, D - discard, e - external metric
 ** - invalid

Tag ABC: VRF : default

	Destination	Metric	Next-Hop	Interface	Tag
L2	20.20.20.0/24	20	50.50.50.1	eth1	0

L2	30.30.30.0/24	20	40.40.40.1	eth3	0
C	40.40.40.0/24	10	--	eth3	0
C	50.50.50.0/24	10	--	eth1	0

R1#show isis interface

eth1 is up, line protocol is up

Routing Protocol: IS-IS (ABC)

Network Type: Broadcast

Circuit Type: level-1-2

Local circuit ID: 0x01

Extended Local circuit ID: 0x00000003

Local SNPA: 5254.00dc.0b76

IP interface address:

20.20.20.1/24

IPv6 interface address:

fe80::5054:ff:fedc:b76/64

Level-2 Metric: 10/10, Priority: 64, Circuit ID: 0000.0000.0003.01

Number of active level-2 adjacencies: 1

Level-2 LSP MTU: 1492

Next IS-IS LAN Level-2 Hello in 5 seconds

eth2 is up, line protocol is up

Routing Protocol: IS-IS (ABC)

Network Type: Broadcast

Circuit Type: level-1-2

Local circuit ID: 0x02

Extended Local circuit ID: 0x00000004

Local SNPA: 5254.00a1.6afe

IP interface address:

30.30.30.1/24

IPv6 interface address:

fe80::5054:ff:feal:6afe/64

Level-2 Metric: 10/10, Priority: 64, Circuit ID: 0000.0000.0001.02

Number of active level-2 adjacencies: 1

Level-2 LSP MTU: 1492

Next IS-IS LAN Level-2 Hello in 183 milliseconds

R2#show isis interface

eth2 is up, line protocol is up

Routing Protocol: IS-IS (ABC)

Network Type: Broadcast

Circuit Type: level-1-2

Local circuit ID: 0x01

Extended Local circuit ID: 0x00000004

Local SNPA: 5254.007e.5ade

IP interface address:

30.30.30.2/24

IPv6 interface address:

fe80::5054:ff:fe7e:5ade/64

Level-2 Metric: 10/10, Priority: 64, Circuit ID: 0000.0000.0001.02

Number of active level-2 adjacencies: 1

Level-2 LSP MTU: 1492

Next IS-IS LAN Level-2 Hello in 706 milliseconds

eth3 is up, line protocol is up

Routing Protocol: IS-IS (ABC)

Network Type: Broadcast

Circuit Type: level-1-2

Local circuit ID: 0x02

```
Extended Local circuit ID: 0x00000005
Local SNPA: 5254.0049.c509
IP interface address:
  40.40.40.1/24
IPv6 interface address:
  fe80::5054:ff:fe49:c509/64
Level-2 Metric: 20/10, Priority: 64, Circuit ID: 0000.0000.0004.02
Number of active level-2 adjacencies: 1
Level-2 LSP MTU: 1492
Next IS-IS LAN Level-2 Hello in 2 seconds
```

```
R3#show isis interface
eth1 is up, line protocol is up
  Routing Protocol: IS-IS (ABC)
    Network Type: Broadcast
    Circuit Type: level-1-2
    Local circuit ID: 0x01
    Extended Local circuit ID: 0x00000003
    Local SNPA: 5254.00dc.2f11
    IP interface address:
      20.20.20.2/24
    IPv6 interface address:
      fe80::5054:ff:fedc:2f11/64
    Level-2 Metric: 10/10, Priority: 64, Circuit ID: 0000.0000.0003.01
    Number of active level-2 adjacencies: 1
    Level-2 LSP MTU: 1492
    Next IS-IS LAN Level-2 Hello in 2 seconds
eth2 is up, line protocol is up
  Routing Protocol: IS-IS (ABC)
    Network Type: Broadcast
    Circuit Type: level-1-2
    Local circuit ID: 0x02
    Extended Local circuit ID: 0x00000004
    Local SNPA: 5254.00a8.940d
    IP interface address:
      50.50.50.1/24
    IPv6 interface address:
      fe80::5054:ff:fea8:940d/64
    Level-2 Metric: 30/10, Priority: 64, Circuit ID: 0000.0000.0004.01
    Number of active level-2 adjacencies: 1
    Level-2 LSP MTU: 1492
    Next IS-IS LAN Level-2 Hello in 3 seconds
```

```
R4#show isis interface
eth1 is up, line protocol is up
  Routing Protocol: IS-IS (ABC)
    Network Type: Broadcast
    Circuit Type: level-1-2
    Local circuit ID: 0x01
    Extended Local circuit ID: 0x00000003
    Local SNPA: 5254.00f5.35a4
    IP interface address:
      50.50.50.2/24
    IPv6 interface address:
      fe80::5054:ff:fef5:35a4/64
    Level-2 Metric: 10/10, Priority: 64, Circuit ID: 0000.0000.0004.01
    Number of active level-2 adjacencies: 1
```

```
Level-2 LSP MTU: 1492
Next IS-IS LAN Level-2 Hello in 0 milliseconds
eth3 is up, line protocol is up
Routing Protocol: IS-IS (ABC)
Network Type: Broadcast
Circuit Type: level-1-2
Local circuit ID: 0x02
Extended Local circuit ID: 0x00000005
Local SNPA: 5254.00b1.d6fb
IP interface address:
 40.40.40.2/24
IPv6 interface address:
 fe80::5054:ff:feb1:d6fb/64
Level-2 Metric: 10/10, Priority: 64, Circuit ID: 0000.0000.0004.02
Number of active level-2 adjacencies: 1
Level-2 LSP MTU: 1492
Next IS-IS LAN Level-2 Hello in 0 milliseconds
```

L1-L2 Area Routing with a Single Instance

IS-IS supports a two-level hierarchy for handling and scaling the functionality of large networks. The Level-1 (L1) area is mainly for Leaf networks, and the Level-2 (L2) area is the backbone area connecting Level-1 areas. In this example, R3 and R4 are configured as Level-1 routers, and reside in the Level-1 area. R1 and R2 are configured as Level-1-2 routers, and connect these two Level-1 areas with a backbone Level-2 area. You can configure Level-1-2 routers with single or multiple instances: This configuration shows the single-instance version of the Level-1-2 router.

Topology

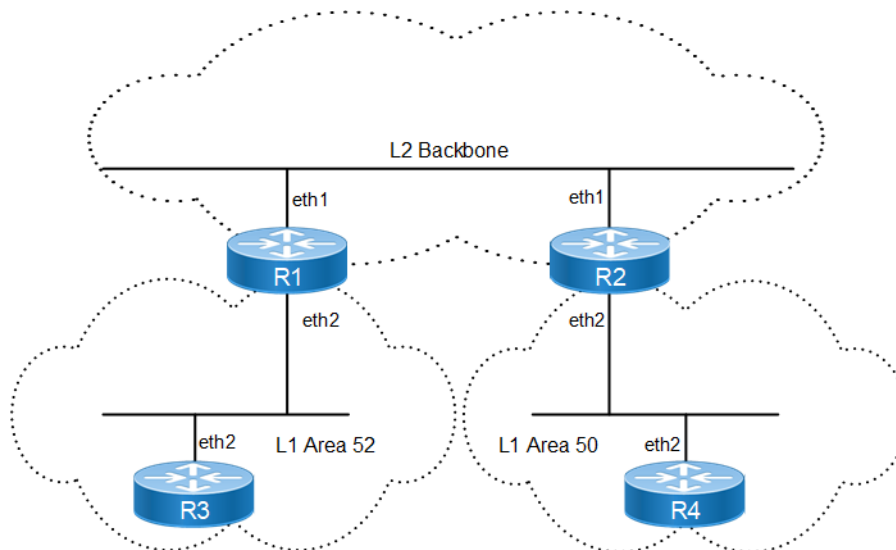

Figure 13-106: Single-Instance L1-L2 Area Routing

Configuration

R1

#configure terminal	Enter configure mode.
(config-if)#commit	Commit candidate configuration to the running configuration
(config)#interface eth1	Enter interface mode.
(config-if)#ip address 20.20.20.1/24	Configure IP address on interface.
(config-if)#ip router isis ABC	Enable IS-IS routing on the interface eth1 for area ABC.
(config-if)#isis circuit-type level-2-only	Set the circuit type for the interface eth1.
(config-if)#exit	Exit interface mode.
(config)#interface eth2	Enter interface mode.
(config-if)#ip address 30.30.30.1/24	Configure IP address on interface.
(config-if)#ip router isis ABC	Enable IS-IS routing on the interface eth2 for area ABC.
(config-if)#isis circuit-type level-1	Set the circuit type for interface eth2 to level 1.
(config-if)#commit	Commit candidate configuration to the running configuration
(config-if)#exit	Exit interface mode.
(config)#router isis ABC	Create an IS-IS routing instance for area ABC.
(config-router)#net 52.0000.0000.0001.00	Set a Network Entity Title for this instance, specifying the area address and the system ID.
(config-router)#commit	Commit candidate configuration to the running configuration

R2

(config)#interface eth1	Enter interface mode.
(config-if)#ip router isis bb	Enable IS-IS routing on the interface eth1 for area bb.
(config-if)#ip address 20.20.20.2/24	Configure IP address on interface.
(config-if)#isis circuit-type level-2-only	Set the circuit type for the interface eth1 to level-2 only.
(config-if)#commit	Commit candidate configuration to the running configuration
(config-if)#exit	Exit interface mode.
(config)#interface eth2	Enter interface mode.
(config-if)#ip address 40.40.40.1/24	Configure IP address on interface.
(config-if)#ip router isis bb	Enable IS-IS routing on interface eth2 for area bb.
(config-if)#isis circuit-type level-1	Set the circuit type for interface eth2 to level 1.
(config-if)#commit	Commit candidate configuration to the running configuration
(config-if)#exit	Exit interface mode.
(config)#router isis bb	Create an IS-IS routing instance for area bb.
(config-router)#net 50.0000.0000.0002.00	Set a Network Entity Title for this instance, specifying the area address and the system ID.
(config-if)#commit	Commit candidate configuration to the running configuration

R3

(config)#interface eth2	Enter interface mode.
(config-if)#ip address 30.30.30.2/24	Configure IP address on interface.
(config-if)#ip router isis xyz	Enable IS-IS routing on the interface eth2 for area xyz.
(config-if)#commit	Commit candidate configuration to the running configuration
(config-if)#exit	Exit interface mode.
(config)#router isis xyz	Create an IS-IS routing instance for area xyz.
(config-router)#is-type level-1	Set the IS level for this area (xyz) as level-1.
(config-router)#net 52.0000.0000.0003.00	Set a Network Entity Title for this instance, specifying the area address and the system ID.
(config-if)#commit	Commit candidate configuration to the running configuration

R4

(config)#interface eth2	Enter interface mode.
(config-if)#ip address 40.40.40.2/24	Configure IP address on interface.
(config-if)#ip router isis aa	Enable IS-IS routing on the interface eth2 for area aa.
(config-if)#commit	Commit candidate configuration to the running configuration
(config-if)#exit	Exit interface mode.
(config)#router isis aa	Create an IS-IS routing instance for area aa.
(config-router)#is-type level-1	Set the IS level for this area (aa) as level-1.
(config-router)#net 50.0000.0000.0004.00	Set a Network Entity Title for this instance, specifying the area address and the system ID.
(config-if)#commit	Commit candidate configuration to the running configuration

Validation

R1#

R1#show clns neighbors

Total number of L1 adjacencies: 1

Total number of L2 adjacencies: 1

Total number of adjacencies: 2

Tag ABC: VRF : default

System Id	Interface	SNPA	State	Holdtime	Type	Protocol
0000.0000.0002	eth1	5254.002a.230a	Up	20	L2	IS-IS
0000.0000.0003	eth2	5254.00a8.940d	Up	6	L1	IS-IS

R2#show clns neighbors

Total number of L1 adjacencies: 1

Total number of L2 adjacencies: 1

Total number of adjacencies: 2

Tag bb: VRF : default

System Id	Interface	SNPA	State	Holdtime	Type	Protocol
0000.0000.0001	eth1	5254.00dc.0b76	Up	8	L2	IS-IS

```
0000.0000.0004 eth2          5254.00e2.aece          Up      7          L1    IS-IS
```

```
R3#show clns neighbors
```

```
Total number of L1 adjacencies: 1
```

```
Total number of L2 adjacencies: 0
```

```
Total number of adjacencies: 1
```

```
Tag xyz: VRF : default
```

System Id	Interface	SNPA	State	Holdtime	Type	Protocol
0000.0000.0001	eth2	5254.00a1.6afe	Up	23	L1	IS-IS

```
R4#show clns neighbors
```

```
Total number of L1 adjacencies: 1
```

```
Total number of L2 adjacencies: 0
```

```
Total number of adjacencies: 1
```

```
Tag aa: VRF : default
```

System Id	Interface	SNPA	State	Holdtime	Type	Protocol
0000.0000.0002	eth2	5254.007e.5ade	Up	25	L1	IS-IS

```
R1#show ip isis route
```

```
Codes: C - connected, E - external, L1 - IS-IS level-1, L2 - IS-IS level-2
       ia - IS-IS inter area, D - discard, e - external metric
       ** - invalid
```

```
Tag ABC: VRF : default
```

	Destination	Metric	Next-Hop	Interface	Tag
C	20.20.20.0/24	10	--	eth1	0
C	30.30.30.0/24	10	--	eth2	0
L2	40.40.40.0/24	20	20.20.20.2	eth1	0

```
R2#show ip isis route
```

```
Codes: C - connected, E - external, L1 - IS-IS level-1, L2 - IS-IS level-2
       ia - IS-IS inter area, D - discard, e - external metric
       ** - invalid
```

```
Tag bb: VRF : default
```

	Destination	Metric	Next-Hop	Interface	Tag
C	20.20.20.0/24	10	--	eth1	0
L2	30.30.30.0/24	20	20.20.20.1	eth1	0
C	40.40.40.0/24	10	--	eth2	0

```
R3#show ip isis route
```

```
Codes: C - connected, E - external, L1 - IS-IS level-1, L2 - IS-IS level-2
       ia - IS-IS inter area, D - discard, e - external metric
       ** - invalid
```

```
Tag xyz: VRF : default
```

	Destination	Metric	Next-Hop	Interface	Tag
L1	0.0.0.0/0	10	30.30.30.1	eth2	0
C	30.30.30.0/24	10	--	eth2	0

```
R4#show ip isis route
```

Codes: C - connected, E - external, L1 - IS-IS level-1, L2 - IS-IS level-2
 ia - IS-IS inter area, D - discard, e - external metric
 ** - invalid

Tag aa: VRF : default

	Destination	Metric	Next-Hop	Interface	Tag
L1	0.0.0.0/0	10	40.40.40.1	eth2	0
C	40.40.40.0/24	10	--	eth2	0

R1#show isis topology

Tag ABC: VRF : default

IS-IS paths to level-1 routers

System Id	Metric	Next-Hop	Interface	SNPA
0000.0000.0001	--			
0000.0000.0003	10	0000.0000.0003	eth2	
5254.00a8.940d				

IS-IS paths to level-2 routers

System Id	Metric	Next-Hop	Interface	SNPA
0000.0000.0001	--			
0000.0000.0002	10	0000.0000.0002	eth1	
5254.002a.230a				

R2#show isis topology

Tag bb: VRF : default

IS-IS paths to level-1 routers

System Id	Metric	Next-Hop	Interface	SNPA
0000.0000.0002	--			
0000.0000.0004	10	0000.0000.0004	eth2	
5254.00e2.aece				

IS-IS paths to level-2 routers

System Id	Metric	Next-Hop	Interface	SNPA
0000.0000.0001	10	0000.0000.0001	eth1	
5254.00dc.0b76				
0000.0000.0002	--			

R3#show isis topology

Tag xyz: VRF : default

IS-IS paths to level-1 routers

System Id	Metric	Next-Hop	Interface	SNPA
0000.0000.0001	10	0000.0000.0001	eth2	
5254.00a1.6afe				
0000.0000.0003	--			

R4#show isis topology

Tag aa: VRF : default

IS-IS paths to level-1 routers

System Id	Metric	Next-Hop	Interface	SNPA
0000.0000.0002	10	0000.0000.0002	eth2	
5254.007e.5ade				
0000.0000.0004	--			

R1#show ip route

```

Codes: K - kernel, C - connected, S - static, R - RIP, B - BGP
       O - OSPF, IA - OSPF inter area
       N1 - OSPF NSSA external type 1, N2 - OSPF NSSA external type 2
       E1 - OSPF external type 1, E2 - OSPF external type 2
       i - IS-IS, L1 - IS-IS level-1, L2 - IS-IS level-2,
       ia - IS-IS inter area, E - EVPN,
       v - vrf leaked
       * - candidate default

```

```
IP Route Table for VRF "default"
```

```

C          10.12.30.0/24 is directly connected, eth0, 00:27:08
C          20.20.20.0/24 is directly connected, eth1, 00:16:57
C          30.30.30.0/24 is directly connected, eth2, 00:15:48
i L2      40.40.40.0/24 [115/20] via 20.20.20.2, eth1, 00:15:05
C          127.0.0.0/8 is directly connected, lo, 00:27:08

```

```
Gateway of last resort is not set
```

```
R2#show ip route
```

```

Codes: K - kernel, C - connected, S - static, R - RIP, B - BGP
       O - OSPF, IA - OSPF inter area
       N1 - OSPF NSSA external type 1, N2 - OSPF NSSA external type 2
       E1 - OSPF external type 1, E2 - OSPF external type 2
       i - IS-IS, L1 - IS-IS level-1, L2 - IS-IS level-2,
       ia - IS-IS inter area, E - EVPN,
       v - vrf leaked
       * - candidate default

```

```
IP Route Table for VRF "default"
```

```

C          10.12.30.0/24 is directly connected, eth0, 00:27:17
C          20.20.20.0/24 is directly connected, eth1, 00:17:13
i L2      30.30.30.0/24 [115/20] via 20.20.20.1, eth1, 00:16:18
C          40.40.40.0/24 is directly connected, eth2, 00:15:36
C          127.0.0.0/8 is directly connected, lo, 00:27:17

```

```
Gateway of last resort is not set
```

```
R3#show ip route
```

```

Codes: K - kernel, C - connected, S - static, R - RIP, B - BGP
       O - OSPF, IA - OSPF inter area
       N1 - OSPF NSSA external type 1, N2 - OSPF NSSA external type 2
       E1 - OSPF external type 1, E2 - OSPF external type 2
       i - IS-IS, L1 - IS-IS level-1, L2 - IS-IS level-2,
       ia - IS-IS inter area, E - EVPN,
       v - vrf leaked
       * - candidate default

```

```
IP Route Table for VRF "default"
```

```
Gateway of last resort is 30.30.30.1 to network 0.0.0.0
```

```

i*L1      0.0.0.0/0 [115/10] via 30.30.30.1, eth2, 00:16:47
C          10.12.30.0/24 is directly connected, eth0, 00:27:46
C          30.30.30.0/24 is directly connected, eth2, 00:16:52
C          127.0.0.0/8 is directly connected, lo, 00:27:46

```

```
R4#show ip route
```

```
Codes: K - kernel, C - connected, S - static, R - RIP, B - BGP
```

O - OSPF, IA - OSPF inter area
 N1 - OSPF NSSA external type 1, N2 - OSPF NSSA external type 2
 E1 - OSPF external type 1, E2 - OSPF external type 2
 i - IS-IS, L1 - IS-IS level-1, L2 - IS-IS level-2,
 ia - IS-IS inter area, E - EVPN,
 v - vrf leaked
 * - candidate default

IP Route Table for VRF "default"

Gateway of last resort is 40.40.40.1 to network 0.0.0.0

```

i*L1      0.0.0.0/0 [115/10] via 40.40.40.1, eth2, 00:16:26
C         10.12.30.0/24 is directly connected, eth0, 00:27:20
C         40.40.40.0/24 is directly connected, eth2, 00:16:36
C         127.0.0.0/8 is directly connected, lo, 00:27:20
  
```

R1#show isis database

Tag ABC: VRF : default

IS-IS Level-1 Link State Database:

LSPID	LSP Seq Num	LSP Checksum	LSP Holdtime	ATT/P/OL
0000.0000.0001.00-00*	0x00000005	0xE66E	1165	1/0/0
0000.0000.0003.00-00	0x00000004	0xDC80	1164	0/0/0
0000.0000.0003.01-00	0x00000002	0x10C8	1163	0/0/0

IS-IS Level-2 Link State Database:

LSPID	LSP Seq Num	LSP Checksum	LSP Holdtime	ATT/P/OL
0000.0000.0001.00-00*	0x00000005	0xD0D8	1148	0/0/0
0000.0000.0001.01-00*	0x00000002	0x1FBA	1109	0/0/0
0000.0000.0002.00-00	0x00000005	0x7219	1189	0/0/0

R2#show isis database

Tag bb: VRF : default

IS-IS Level-1 Link State Database:

LSPID	LSP Seq Num	LSP Checksum	LSP Holdtime	ATT/P/OL
0000.0000.0002.00-00*	0x00000005	0x9583	1179	1/0/0
0000.0000.0004.00-00	0x00000004	0x8B95	1177	0/0/0
0000.0000.0004.01-00	0x00000002	0x2FA6	1177	0/0/0

IS-IS Level-2 Link State Database:

LSPID	LSP Seq Num	LSP Checksum	LSP Holdtime	ATT/P/OL
0000.0000.0001.00-00	0x00000005	0xD0D8	1116	0/0/0
0000.0000.0001.01-00	0x00000002	0x1FBA	1078	0/0/0
0000.0000.0002.00-00*	0x00000005	0x7219	1160	0/0/0

R3#show isis database

Tag xyz: VRF : default

IS-IS Level-1 Link State Database:

LSPID	LSP Seq Num	LSP Checksum	LSP Holdtime	ATT/P/OL
0000.0000.0001.00-00	0x00000005	0xE66E	1094	1/0/0
0000.0000.0003.00-00*	0x00000004	0xDC80	1095	0/0/0
0000.0000.0003.01-00*	0x00000002	0x10C8	1094	0/0/0

R4#show isis database

Tag aa: VRF : default

IS-IS Level-1 Link State Database:

LSPID	LSP Seq Num	LSP Checksum	LSP Holdtime	ATT/P/OL
0000.0000.0002.00-00	0x00000005	0x9583	1105	1/0/0

```
0000.0000.0004.00-00* 0x00000004 0x8B95 1105 0/0/0
0000.0000.0004.01-00* 0x00000002 0x2FA6 1105 0/0/0
```

L1-L2 Area Routing with Multiple Instances

IS-IS supports a two-level hierarchy for handling and scaling the functionality of large networks. The Level-1 (L1) area is mainly for Leaf networks, and the Level-2 (L2) area is the backbone area connecting Level-1 areas. In this example, R3 and R4 are configured as Level-1 routers, and reside in the Level-1 area. R1 and R2 are configured as Level-1-2 routers, and connect these two Level-1 areas with a backbone Level-2 area. You can configure Level-1-2 routers with single or multiple instances: This configuration shows the multiple-instance version of the Level-1-2 router.

Topology

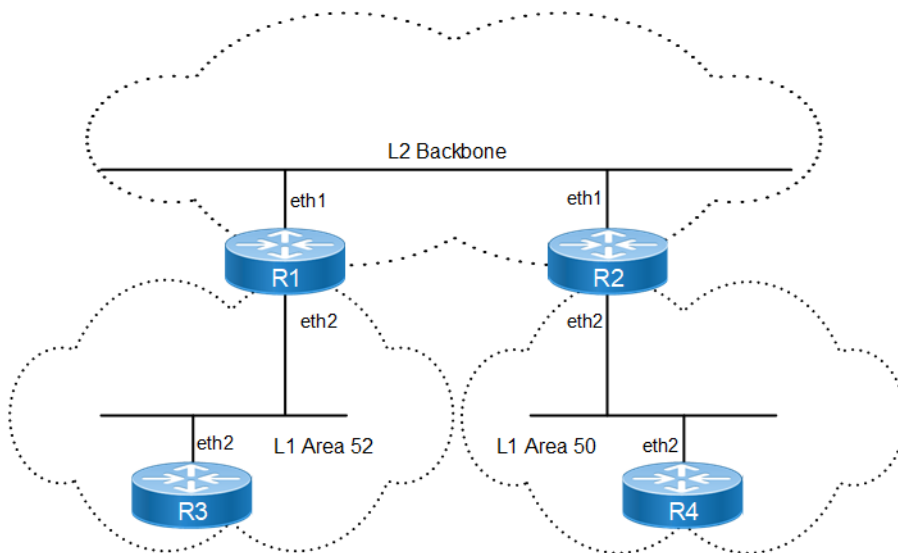

Figure 13-107: Multiple-Instance L1-L2 Area Routing

Configuration

R1

#configure terminal	Enter configure mode.
(config)#interface eth1	Enter interface mode.
(config-if)#ip address 20.20.20.1/24	Configure IP address on interface.
(config-if)#ip router isis aaa	Enable IS-IS routing on interface eth1 for area aaa.
(config-if)#commit	Commit candidate configuration to the running configuration
(config-if)#exit	Exit interface mode.
(config)#router isis aaa	Create an IS-IS routing instance for area aaa.
(config-router)#is-type level-2-only	Set the IS level for this area (aaa) as level-2-only.
(config-router)#net bb.0000.0000.0001.00	Set a Network Entity Title for this instance, specifying the area address and the system ID.

IS-IS IPv4

#configure terminal	Enter configure mode.
(config-if)#commit	Commit candidate configuration to the running configuration
(config-router)#exit	Exit Router mode, and return to Configure mode.
(config)#interface eth2	Enter interface mode.
(config-if)#ip address 30.30.30.1/24	Configure IP address on interface.
(config-if)#ip router isis ccc	Enable IS-IS routing on interface eth2 for area ccc.
(config-if)#commit	Commit candidate configuration to the running configuration
(config-if)#exit	Exit interface mode.
(config)#router isis ccc	Create an IS-IS routing instance for area ccc.
(config-router)#is-type level-1	Set the IS level for this area (ccc) as level-1.
(config-router)#net cc.0000.0000.0002.00	Set a Network Entity Title for this instance, specifying the area address and the system ID.
(config-if)#commit	Commit candidate configuration to the running configuration

R2

(config)#interface eth1	Enter interface mode.
(config-if)#ip address 20.20.20.2/24	Configure IP address on interface.
(config-if)#ip router isis bb	Enable IS-IS routing on interface eth1 for area bb.
(config-if)#commit	Commit candidate configuration to the running configuration
(config-if)#exit	Exit interface mode.
(config)#router isis bb	Create an IS-IS routing instance for area bb.
(config-router)#is-type level-2-only	Set the IS level for this area (bb) as level-2-only.
(config-router)#net bb.0000.0000.0002.00	Set a Network Entity Title for this instance, specifying the area address and the system ID.
(config-if)#commit	Commit candidate configuration to the running configuration
(config-router)#exit	Exit Router mode, and return to Configure mode.
(config)#interface eth2	Enter interface mode.
(config-if)#ip address 40.40.40.1/24	Configure IP address on interface.
(config-if)#ip router isis ABC	Enable IS-IS routing on interface eth2 for area ABC.
(config-if)#commit	Commit candidate configuration to the running configuration
(config-if)#exit	Exit interface mode.
(config)#router isis ABC	Create an IS-IS routing instance for area ABC.
(config-router)#is-type level-1	Set the IS level for this area (ABC) as level-1.
(config-router)#net cc.0000.0000.0003.00	Set a Network Entity Title for this instance, specifying the area address and the system ID.
(config-if)#commit	Commit candidate configuration to the running configuration

R3

(config)#interface eth2	Enter interface mode.
(config-if)#ip address 30.30.30.2/24	Configure IP address on interface.
(config-if)#ip router isis xyz	Enable IS-IS routing on interface eth2 for area xyz.
(config-if)#exit	Exit interface mode.
(config)#router isis xyz	Create an IS-IS routing instance for area xyz.
(config-router)#is-type level-1	Set the IS level for this area (xyz) as level-1.
(config-router)#net 52.0000.0000.0003.00	Set a Network Entity Title for this instance, specifying the area address and the system ID.

R4

(config)#interface eth2	Enter interface mode.
(config-if)#ip address 40.40.40.2/24	Configure IP address on interface.
(config-if)#ip router isis aa	Enable IS-IS routing on interface eth2 for area aa.
(config-if)#exit	Exit interface mode.
(config)#router isis aa	Create an IS-IS routing instance for area aa.
(config-router)#is-type level-1	Set the IS level for this area (aa) as level-1.
(config-router)#net 52.0000.0000.0004.00	Set a Network Entity Title for this instance, specifying the area address and the system ID.

Validation

R1#show clns neighbors

```
Total number of L1 adjacencies: 0
Total number of L2 adjacencies: 1
Total number of adjacencies: 1
Tag aaa: VRF : default
System Id      Interface  SNPA          State  Holdtime  Type Protocol
0000.0000.0002 eth1      5254.002a.230a Up     25        L2   IS-IS
```

```
Total number of L1 adjacencies: 0
Total number of L2 adjacencies: 0
Total number of adjacencies: 0
Tag ccc: VRF : default
```

```
System Id      Interface  SNPA          State  Holdtime  Type Protocol
```

R2#show clns neighbors

```
Total number of L1 adjacencies: 0
Total number of L2 adjacencies: 0
Total number of adjacencies: 0
Tag ABC: VRF : default
```

```
System Id      Interface  SNPA          State  Holdtime  Type Protocol
```

```
Total number of L1 adjacencies: 0
Total number of L2 adjacencies: 1
Total number of adjacencies: 1
```

```
Tag bb: VRF : default
System Id      Interface  SNPA          State  Holdtime  Type  Protocol
0000.0000.0001 eth1      5254.00dc.0b76 Up      6         L2   IS-IS
```

```
R1#show clns is-neighbors
```

```
Tag aaa: VRF : default
System Id      Interface  State  Type  Priority  Circuit Id
0000.0000.0002 eth1      Up     L2   64       0000.0000.0001.01
```

```
Tag ccc: VRF : default
System Id      Interface  State  Type  Priority  Circuit Id
```

```
R2#show clns is-neighbors
```

```
Tag ABC: VRF : default
System Id      Interface  State  Type  Priority  Circuit Id
```

```
Tag bb: VRF : default
System Id      Interface  State  Type  Priority  Circuit Id
0000.0000.0001 eth1      Up     L2   64       0000.0000.0001.01
```

```
R1#show ip isis route
```

```
Codes: C - connected, E - external, L1 - IS-IS level-1, L2 - IS-IS level-2
       ia - IS-IS inter area, D - discard, e - external metric
       ** - invalid
```

```
Tag aaa: VRF : default
Destination    Metric      Next-Hop      Interface      Tag
C 20.20.20.0/24 10           --            eth1           0
```

```
Codes: C - connected, E - external, L1 - IS-IS level-1, L2 - IS-IS level-2
       ia - IS-IS inter area, D - discard, e - external metric
       ** - invalid
```

```
Tag ccc: VRF : default
Destination    Metric      Next-Hop      Interface      Tag
C 30.30.30.0/24 10           --            eth2           0
```

```
R2#show ip isis route
```

```
Codes: C - connected, E - external, L1 - IS-IS level-1, L2 - IS-IS level-2
       ia - IS-IS inter area, D - discard, e - external metric
       ** - invalid
```

```
Tag ABC: VRF : default
Destination    Metric      Next-Hop      Interface      Tag
C 40.40.40.0/24 10           --            eth2           0
```

```
Codes: C - connected, E - external, L1 - IS-IS level-1, L2 - IS-IS level-2
       ia - IS-IS inter area, D - discard, e - external metric
       ** - invalid
```

```
Tag bb: VRF : default
```

	Destination	Metric	Next-Hop	Interface	Tag
C	20.20.20.0/24	10	--	eth1	0

R1#show isis topology

```

Tag aaa: VRF : default
IS-IS paths to level-2 routers
System Id      Metric      Next-Hop      Interface      SNPA
0000.0000.0001  --
0000.0000.0002  10          0000.0000.0002 eth1
5254.002a.230a

```

```

Tag ccc: VRF : default
IS-IS paths to level-1 routers
System Id      Metric      Next-Hop      Interface      SNPA
0000.0000.0002  --

```

R2#show isis topology

```

Tag ABC: VRF : default
IS-IS paths to level-1 routers
System Id      Metric      Next-Hop      Interface      SNPA
0000.0000.0003  --

```

```

Tag bb: VRF : default
IS-IS paths to level-2 routers
System Id      Metric      Next-Hop      Interface      SNPA
0000.0000.0001  10          0000.0000.0001 eth1
5254.00dc.0b76
0000.0000.0002  --

```

R1#show isis database

```

Tag aaa: VRF : default
IS-IS Level-2 Link State Database:
LSPID          LSP Seq Num  LSP Checksum  LSP Holdtime  ATT/P/OL
0000.0000.0001.00-00* 0x00000002  0x181D        1003          0/0/0
0000.0000.0001.01-00* 0x00000001  0x21B9        1003          0/0/0
0000.0000.0002.00-00  0x00000005  0x1818        1080          0/0/0

```

```

Tag ccc: VRF : default
IS-IS Level-1 Link State Database:
LSPID          LSP Seq Num  LSP Checksum  LSP Holdtime  ATT/P/OL
0000.0000.0002.00-00* 0x00000001  0xDFA5        685           0/0/0

```

R2#show isis database

```

Tag ABC: VRF : default
IS-IS Level-1 Link State Database:
LSPID          LSP Seq Num  LSP Checksum  LSP Holdtime  ATT/P/OL
0000.0000.0003.00-00* 0x00000002  0xD571        696           0/0/0

```

Tag bb: VRF : default

```

IS-IS Level-2 Link State Database:
LSPID          LSP Seq Num  LSP Checksum  LSP Holdtime  ATT/P/OL
0000.0000.0001.00-00  0x00000002  0x181D        938           0/0/0
0000.0000.0001.01-00  0x00000001  0x21B9        938           0/0/0

```

```
0000.0000.0002.00-00* 0x00000005 0x1818 1017 0/0/0
```

```
R1#show ip route
```

```
Codes: K - kernel, C - connected, S - static, R - RIP, B - BGP
O - OSPF, IA - OSPF inter area
N1 - OSPF NSSA external type 1, N2 - OSPF NSSA external type 2
E1 - OSPF external type 1, E2 - OSPF external type 2
i - IS-IS, L1 - IS-IS level-1, L2 - IS-IS level-2,
ia - IS-IS inter area, E - EVPN,
v - vrf leaked
* - candidate default
```

```
IP Route Table for VRF "default"
```

```
C 10.12.30.0/24 is directly connected, eth0, 01:37:50
C 20.20.20.0/24 is directly connected, eth1, 00:10:13
C 30.30.30.0/24 is directly connected, eth2, 00:10:13
C 127.0.0.0/8 is directly connected, lo, 01:37:50
```

```
Gateway of last resort is not set
```

```
R2#show ip route
```

```
Codes: K - kernel, C - connected, S - static, R - RIP, B - BGP
O - OSPF, IA - OSPF inter area
N1 - OSPF NSSA external type 1, N2 - OSPF NSSA external type 2
E1 - OSPF external type 1, E2 - OSPF external type 2
i - IS-IS, L1 - IS-IS level-1, L2 - IS-IS level-2,
ia - IS-IS inter area, E - EVPN,
v - vrf leaked
* - candidate default
```

```
IP Route Table for VRF "default"
```

```
C 10.12.30.0/24 is directly connected, eth0, 01:37:26
C 20.20.20.0/24 is directly connected, eth1, 00:05:03
C 40.40.40.0/24 is directly connected, eth2, 00:08:52
C 127.0.0.0/8 is directly connected, lo, 01:37:26
```

```
Gateway of last resort is not set
```

Route Leaking

Route leaking is defined in RFC 2966. For Level-1 (L1) routers, only level-1 routes are populated in the routing table. The L1 router has a default route to the nearest Level-1/Level-2 (L1/L2) router: This could result in sub-optimal routing in certain scenarios. Route leaking causes an L1/L2 router to advertise the level-2 routes in its database to the L1 router, thus allowing the L1 router to acknowledge the prefixes advertised by the Level-2 (L2) router. In this way, the L1 router has the ability to learn the true cost to reach other areas.

In the following example, R1 is the L1 router, R2 is the L1/L2 router doing the route leaking, and R3 is the L2 router. The following configuration is given only for R2, assuming that the adjacency with R1 and R3 are already up, and the route tables with appropriate routes are already populated.

Topology

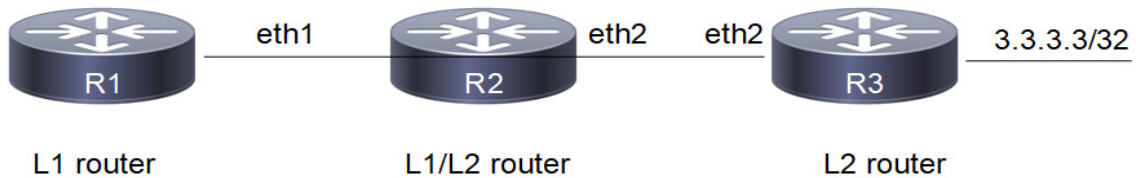

Figure 13-108: Route Leaking Topology

Configuration

R1

#configure terminal	Enter configure mode.
(config)#router isis 1	Create an IS-IS routing instance (1).
(config-router)#net 49.0001.0000.0000.0001.00	Define the NET address.
(config-router)#isis-type level-1	Configure instance as level-1.
(config-if)#commit	Commit candidate configuration to the running configuration
(config-router)#exit	Exit router mode.
(config)#interface eth1	Specify the interface (eth1)to configure and enter Interface mode.
(config-if)#ip address 20.20.20.1/24	Configure IP address on interface.
(config-if)#isis circuit-type level-1	Set the circuit type as level-1 for the interface
(config-if)#ip router isis 1	Enable IS-IS routing on interface eth1 (connected to R2).
(config-if)#commit	Commit candidate configuration to the running configuration

R2

#configure terminal	Enter configure mode.
(config)#interface eth1	Specify the interface (eth1)to configure and enter Interface mode.
(config-if)#ip address 20.20.20.2/24	Configure IP address on interface.
(config-if)#ip router isis 1	Enable IS-IS routing on interface eth1 (connected to R1).
(config-if)#isis circuit-type level-1	Configure instance as level-1-only routing.
(config-if)#commit	Commit candidate configuration to the running configuration
(config-if)#exit	Exit interface mode and return to Configure mode.
(config)#interface eth2	Specify the interface (eth2)to configure and enter Interface mode.
(config-if)#ip address 30.30.30.1/24	Configure IP address on interface.
(config-if)#ip router isis 1	Enable IS-IS routing on interface eth2 (connected to R3).

IS-IS IPv4

(config-if)#isis circuit-type level-2-only	Configure instance as level-2-only routing.
(config-if)#commit	Commit candidate configuration to the running configuration
(config-if)#exit	Exit interface mode and return to Configure mode.
(config)#router isis 1	Create an IS-IS routing instance (1).
(config-router)#net 49.0001.0000.0000.0002.00	Define the NET address.
(config-router-af)#redistribute isis level-2 into level-1	Enable redistribution of isis routes from level-2 into level-1
(config-if)#commit	Commit candidate configuration to the running configuration

R3

#configure terminal	Enter configure mode.
(config)#interface lo	Specify the interface (lo)to configure and enter Interface mode.
(config-if)#ip address 3.3.3.3/32 secondary	Configure IP address on loopback interface.
(config-if)# ip router isis 1	Enable IS-IS routing on interface lo
(config-if)#commit	Commit candidate configuration to the running configuration
(config-if)#exit	Exit interface mode and return to Configure mode.
(config)#router isis 1	Create an IS-IS routing instance (1).
(config-router)#is-type level-2-only	Configure instance as level-2-only routing.
(config-router)#net 49.0001.0000.0000.0003.00	Define the NET address.
(config-if)#commit	Commit candidate configuration to the running configuration
(config-router)#exit	Exit router mode.
(config)#interface eth2	Specify the interface (eth2)to configure and enter Interface mode.
(config-if)#ip address 30.30.30.2/24	Configure IP address on interface.
(config-if)#isis circuit-type level-2-only	Set the circuit type as level-2-only for the interface
(config-if)#ip router isis 1	Enable IS-IS routing on interface eth1 (connected to R2).
(config-if)#commit	Commit candidate configuration to the running configuration

In the example, route, i ia 3.3.3.3/32 [115/30] via 20.20.20.2, eth1, 00:12:29, is the L2 route leaked by the L1/L2 router into the L1 router.

Validation

```
R1#show clns neighbors
```

```
Total number of L1 adjacencies: 1  
Total number of L2 adjacencies: 0  
Total number of adjacencies: 1  
Tag 1: VRF : default
```

System Id	Interface	SNPA	State	Holdtime	Type	Protocol
0000.0000.0002	eth1	5254.002a.230a	Up	21	L1	IS-IS

R2#show clns neighbors

Total number of L1 adjacencies: 1
 Total number of L2 adjacencies: 1
 Total number of adjacencies: 2
 Tag 1: VRF : default

System Id	Interface	SNPA	State	Holdtime	Type	Protocol
0000.0000.0001	eth1	5254.00dc.0b76	Up	5	L1	IS-IS
0000.0000.0003	eth2	5254.00a8.940d	Up	6	L2	IS-IS

R3#show clns neighbors

Total number of L1 adjacencies: 0
 Total number of L2 adjacencies: 1
 Total number of adjacencies: 1
 Tag 1: VRF : default

System Id	Interface	SNPA	State	Holdtime	Type	Protocol
0000.0000.0002	eth2	5254.007e.5ade	Up	21	L2	IS-IS

R1#show ip isis route

Codes: C - connected, E - external, L1 - IS-IS level-1, L2 - IS-IS level-2
 ia - IS-IS inter area, D - discard, e - external metric
 ** - invalid

Tag 1: VRF : default

	Destination	Metric	Next-Hop	Interface	Tag
ia	3.3.3.3/32	30	20.20.20.2	eth1	0
C	20.20.20.0/24	10	--	eth1	0
ia	30.30.30.0/24	20	20.20.20.2	eth1	0

R2#show ip isis route

Codes: C - connected, E - external, L1 - IS-IS level-1, L2 - IS-IS level-2
 ia - IS-IS inter area, D - discard, e - external metric
 ** - invalid

Tag 1: VRF : default

	Destination	Metric	Next-Hop	Interface	Tag
L2	3.3.3.3/32	20	30.30.30.2	eth2	0
C	20.20.20.0/24	10	--	eth1	0
C	30.30.30.0/24	10	--	eth2	0

R3#show ip isis route

Codes: C - connected, E - external, L1 - IS-IS level-1, L2 - IS-IS level-2
 ia - IS-IS inter area, D - discard, e - external metric

** - invalid

Tag 1: VRF : default

	Destination	Metric	Next-Hop	Interface	Tag
C	3.3.3.3/32	10	--	lo	0
L2	20.20.20.0/24	20	30.30.30.1	eth2	0
C	30.30.30.0/24	10	--	eth2	0

R1#show ip route

Codes: K - kernel, C - connected, S - static, R - RIP, B - BGP
O - OSPF, IA - OSPF inter area
N1 - OSPF NSSA external type 1, N2 - OSPF NSSA external type 2
E1 - OSPF external type 1, E2 - OSPF external type 2
i - IS-IS, L1 - IS-IS level-1, L2 - IS-IS level-2,
ia - IS-IS inter area, E - EVPN,
v - vrf leaked
* - candidate default

IP Route Table for VRF "default"

i ia 3.3.3.3/32 [115/30] via 20.20.20.2, eth1, 00:20:53
C 10.12.30.0/24 is directly connected, eth0, 01:02:10
C 20.20.20.0/24 is directly connected, eth1, 00:48:08
i ia 30.30.30.0/24 [115/20] via 20.20.20.2, eth1, 00:23:30
C 127.0.0.0/8 is directly connected, lo, 01:02:10

Gateway of last resort is not set

R2#show ip route

Codes: K - kernel, C - connected, S - static, R - RIP, B - BGP
O - OSPF, IA - OSPF inter area
N1 - OSPF NSSA external type 1, N2 - OSPF NSSA external type 2
E1 - OSPF external type 1, E2 - OSPF external type 2
i - IS-IS, L1 - IS-IS level-1, L2 - IS-IS level-2,
ia - IS-IS inter area, E - EVPN,
v - vrf leaked
* - candidate default

IP Route Table for VRF "default"

i L2 3.3.3.3/32 [115/20] via 30.30.30.2, eth2, 00:21:07
C 10.12.30.0/24 is directly connected, eth0, 01:01:55
C 20.20.20.0/24 is directly connected, eth1, 00:48:12
C 30.30.30.0/24 is directly connected, eth2, 00:48:12
C 127.0.0.0/8 is directly connected, lo, 01:01:55

Gateway of last resort is not set

R3#show ip route

Codes: K - kernel, C - connected, S - static, R - RIP, B - BGP
O - OSPF, IA - OSPF inter area
N1 - OSPF NSSA external type 1, N2 - OSPF NSSA external type 2

E1 - OSPF external type 1, E2 - OSPF external type 2
 i - IS-IS, L1 - IS-IS level-1, L2 - IS-IS level-2,
 ia - IS-IS inter area, E - EVPN,
 v - vrf leaked
 * - candidate default

IP Route Table for VRF "default"

```
C          3.3.3.3/32 is directly connected, lo, 00:21:25
C          10.12.30.0/24 is directly connected, eth0, 01:01:26
i L2      20.20.20.0/24 [115/20] via 30.30.30.1, eth2, 00:24:06
C          30.30.30.0/24 is directly connected, eth2, 00:48:13
C          127.0.0.0/8 is directly connected, lo, 01:01:26
```

Gateway of last resort is not set

R1#show isis database

Tag 1: VRF : default

IS-IS Level-1 Link State Database:

LSPID	LSP Seq Num	LSP Checksum	LSP Holdtime	ATT/P/OL
0000.0000.0001.00-00*	0x0000000C	0xE4B5	642	0/0/0
0000.0000.0001.01-00*	0x00000007	0x13C3	642	0/0/0
0000.0000.0002.00-00	0x00000012	0x8AC8	804	0/0/0

R2#show isis database

Tag 1: VRF : default

IS-IS Level-1 Link State Database:

LSPID	LSP Seq Num	LSP Checksum	LSP Holdtime	ATT/P/OL
0000.0000.0001.00-00	0x00000003	0xF6AC	304	0/0/0
0000.0000.0001.01-00	0x00000002	0x1DBE	304	0/0/0
0000.0000.0002.00-00*	0x00000009	0x2ECA	358	0/0/0

IS-IS Level-2 Link State Database:

LSPID	LSP Seq Num	LSP Checksum	LSP Holdtime	ATT/P/OL
0000.0000.0002.00-00*	0x00000007	0x2F5A	353	0/0/0
0000.0000.0003.00-00	0x00000003	0x25E6	347	0/0/0
0000.0000.0003.02-00	0x00000002	0x24B0	347	0/0/0

R3#show isis database

Tag 1: VRF : default

IS-IS Level-2 Link State Database:

LSPID	LSP Seq Num	LSP Checksum	LSP Holdtime	ATT/P/OL
0000.0000.0002.00-00	0x00000007	0x2F5A	335	0/0/0
0000.0000.0003.00-00*	0x00000003	0x25E6	331	0/0/0
0000.0000.0003.02-00*	0x00000002	0x24B0	331	0/0/0

R1#show isis topology

Tag 1: VRF : default

IS-IS paths to level-1 routers

System Id	Metric	Next-Hop	Interface	SNPA
-----------	--------	----------	-----------	------

```
0000.0000.0001    --
0000.0000.0002    10          0000.0000.0002          eth1          5254.002a.230a
```

```
R2#show isis topology
```

```
Tag 1: VRF : default
```

```
IS-IS paths to level-1 routers
```

System Id	Metric	Next-Hop	Interface	SNPA
0000.0000.0001	10	0000.0000.0001	eth1	5254.00dc.0b76
0000.0000.0002	--			

```
IS-IS paths to level-2 routers
```

System Id	Metric	Next-Hop	Interface	SNPA
0000.0000.0002	--			
0000.0000.0003	10	0000.0000.0003	eth2	5254.00a8.940d

```
R3#show isis topology
```

```
Tag 1: VRF : default
```

```
IS-IS paths to level-2 routers
```

System Id	Metric	Next-Hop	Interface	SNPA
0000.0000.0002	10	0000.0000.0002	eth2	5254.007e.5ade
0000.0000.0003	--			

Route Summarization

Route summarization makes the routing table smaller, but still allows complete IP connectivity, if everything is configured properly.

The following example consists of a three-router topology, in which R2 is doing the summarization. In this example, R1 is the L1 router, R2 is the L1/L2 router doing the summarization, and R3 is the L2 router. The following configuration is given only for R2, assuming that the adjacencies with R1 and R3 are already up, and the route tables with the appropriate routes are already populated.

Topology

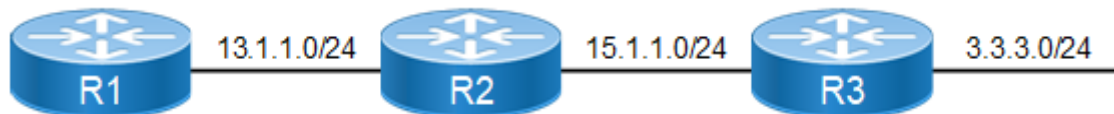

Figure 13-109: Route Summarization Topology

Configuration

R1

#configure terminal	Enter configure mode.
(config)#router isis 1	Create an IS-IS routing instance (1).

(config-router)#net 49.0001.0000.0000.0001.00	Define the NET address.
(config-router)#is-type level-1	Configure instance as level-1.
(config-if)#commit	Commit candidate configuration to the running configuration
(config-router)#exit	Exit router mode.
(config)#interface eth1	Specify the interface (eth1)to configure and enter Interface mode.
(config-if)#ip address 20.20.20.1/24	Configure IP address on interface.
(config-if)#isis circuit-type level-1	Set the circuit type as level-1 for the interface
(config-if)#ip router isis 1	Enable IS-IS routing on interface eth1 (connected to R2).
(config-if)#commit	Commit candidate configuration to the running configuration

R2

#configure terminal	Enter configure mode.
(config)#interface eth1	Specify the interface (eth1)to configure and enter Interface mode.
(config-if)#isis circuit-type level-1	Set the circuit type as level-1 for the interface
(config-if)#ip address 20.20.20.2/24	Configure IP address on interface.
(config-if)#ip router isis 1	Enable IS-IS routing on interface eth1 (connected to R1).
(config-if)#commit	Commit candidate configuration to the running configuration
(config-if)#exit	Exit interface mode and return to Configure mode.
(config)#interface eth2	Specify the interface (eth2)to configure and enter Interface mode.
(config-if)#ip address 30.30.30.1/24	Configure IP address on interface.
(config-if)#isis circuit-type level-2-only	Set the circuit type as level-2-only for the interface
(config-if)#ip router isis 1	Enable IS-IS routing on interface eth2 (connected to R3).
(config-if)#commit	Commit candidate configuration to the running configuration
(config-if)#exit	Exit interface mode and return to Configure mode.
(config)#router isis 1	Create an IS-IS routing instance (1).
(config-router)#net 49.0001.0000.0000.0002.00	Define the NET address.
(config-router-af)#redistribute isis level-2 into level-1	Enable redistribution of isis routes from level-2 into level-1
(config-router-af)# summary-address 66.66.66.0/24 level-1 metric 50	Configure the summary address to summarize IP reachability information.
(config-if)#commit	Commit candidate configuration to the running configuration

R3

#configure terminal	Enter configure mode.
(config)#ip route 66.66.66.1/32 eth2	Configure ip static route.
(config)#ip route 66.66.66.2/32 eth2	Configure ip static route.
(config)#ip route 66.66.66.3/32 eth2	Configure ip static route.

(config)#router isis 1	Create an IS-IS routing instance (1).
(config-router)#is-type level-2-only	Configure instance as level-2-only routing.
(config-router)#net 49.0001.0000.0000.0003.00	Define the NET address.
(config-router)#redistribute static	Enable redistribution of static routes into ISIS instance.
(config-if)#commit	Commit candidate configuration to the running configuration
(config-router)#exit	Exit router mode.
(config)#interface eth2	Specify the interface (eth2)to configure and enter Interface mode.
(config-if)#ip address 30.30.30.2/24	Configure IP address on interface.
(config-if)#isis circuit-type level-2-only	Set the circuit type as level-2-only for the interface
(config-if)#ip router isis 1	Enable IS-IS routing on interface eth1 (connected to R2).
(config-if)#commit	Commit candidate configuration to the running configuration

Validation

```
R1#show clns neighbors
```

```
Total number of L1 adjacencies: 1
```

```
Total number of L2 adjacencies: 0
```

```
Total number of adjacencies: 1
```

```
Tag 1: VRF : default
```

System Id	Interface	SNPA	State	Holdtime	Type	Protocol
0000.0000.0002	eth1	5254.002a.230a	Up	20	L1	IS-IS

```
R2#show clns neighbors
```

```
Total number of L1 adjacencies: 1
```

```
Total number of L2 adjacencies: 1
```

```
Total number of adjacencies: 2
```

```
Tag 1: VRF : default
```

System Id	Interface	SNPA	State	Holdtime	Type	Protocol
0000.0000.0001	eth1	5254.00dc.0b76	Up	6	L1	IS-IS
0000.0000.0003	eth2	5254.00a8.940d	Up	7	L2	IS-IS

```
R3#show clns neighbors
```

```
Total number of L1 adjacencies: 0
```

```
Total number of L2 adjacencies: 1
```

```
Total number of adjacencies: 1
```

```
Tag 1: VRF : default
```

System Id	Interface	SNPA	State	Holdtime	Type	Protocol
0000.0000.0002	eth2	5254.007e.5ade	Up	21	L2	IS-IS

```
R1#show ip isis route
```

```
Codes: C - connected, E - external, L1 - IS-IS level-1, L2 - IS-IS level-2
```

```
ia - IS-IS inter area, D - discard, e - external metric
```

```
** - invalid
```

Tag 1: VRF : default

	Destination	Metric	Next-Hop	Interface	Tag
C	20.20.20.0/24	10	--	eth1	0
ia	30.30.30.0/24	20	20.20.20.2	eth1	0
ia	66.66.66.0/24	60	20.20.20.2	eth1	0

R2#show ip isis route

Codes: C - connected, E - external, L1 - IS-IS level-1, L2 - IS-IS level-2
 ia - IS-IS inter area, D - discard, e - external metric
 ** - invalid

Tag 1: VRF : default

	Destination	Metric	Next-Hop	Interface	Tag
C	20.20.20.0/24	10	--	eth1	0
C	30.30.30.0/24	10	--	eth2	0
D	66.66.66.0/24	0	--	--	
L2	66.66.66.1/32	10	30.30.30.2	eth2	0
L2	66.66.66.2/32	10	30.30.30.2	eth2	0
L2	66.66.66.3/32	10	30.30.30.2	eth2	0

R3#show ip isis route

Codes: C - connected, E - external, L1 - IS-IS level-1, L2 - IS-IS level-2
 ia - IS-IS inter area, D - discard, e - external metric
 ** - invalid

Tag 1: VRF : default

	Destination	Metric	Next-Hop	Interface	Tag
L2	20.20.20.0/24	20	30.30.30.1	eth2	0
C	30.30.30.0/24	10	--	eth2	0
E	66.66.66.1/32	0	--	--	0
E	66.66.66.2/32	0	--	--	0
E	66.66.66.3/32	0	--	--	0

R1#show isis database verbose

Tag 1: VRF : default

IS-IS Level-1 Link State Database:

LSPID	LSP Seq Num	LSP Checksum	LSP Holdtime	ATT/P/OL
0000.0000.0001.00-00*	0x00000004	0xF4AD	850	0/0/0
Area Address: 49.0001				
NLPID: 0xCC				
IP Address: 20.20.20.1				
Metric: 10 IS 0000.0000.0001.01				
Metric: 10 IP 20.20.20.0 255.255.255.0				
0000.0000.0001.01-00*	0x00000003	0x1BBF	850	0/0/0
Metric: 0 IS 0000.0000.0001.00				
Metric: 0 IS 0000.0000.0002.00				
0000.0000.0002.00-00	0x00000010	0xB5E0	1165	0/0/0
Area Address: 49.0001				
NLPID: 0xCC				
IP Address: 20.20.20.2				
Metric: 10 IS 0000.0000.0001.01				
Metric: 10 IP 20.20.20.0 255.255.255.0				
Metric: 10 IP-Interarea 30.30.30.0 255.255.255.0				

Metric: 50 IP-External 66.66.66.0 255.255.255.0

R2#show isis database verbose

Tag 1: VRF : default

IS-IS Level-1 Link State Database:

LSPID	LSP Seq Num	LSP Checksum	LSP Holdtime	ATT/P/OL
0000.0000.0001.00-00	0x00000004	0xF4AD	820	0/0/0
Area Address: 49.0001				
NLPID: 0xCC				
IP Address: 20.20.20.1				
Metric: 10	IS 0000.0000.0001.01			
Metric: 10	IP 20.20.20.0 255.255.255.0			
0000.0000.0001.01-00	0x00000003	0x1BBF	820	0/0/0
Metric: 0	IS 0000.0000.0001.00			
Metric: 0	IS 0000.0000.0002.00			
0000.0000.0002.00-00*	0x00000010	0xB5E0	1137	0/0/0
Area Address: 49.0001				
NLPID: 0xCC				
IP Address: 20.20.20.2				
Metric: 10	IS 0000.0000.0001.01			
Metric: 10	IP 20.20.20.0 255.255.255.0			
Metric: 10	IP-Interarea 30.30.30.0 255.255.255.0			
Metric: 50	IP-External 66.66.66.0 255.255.255.0			

IS-IS Level-2 Link State Database:

LSPID	LSP Seq Num	LSP Checksum	LSP Holdtime	ATT/P/OL
0000.0000.0002.00-00*	0x00000005	0x1577	838	0/0/0
Area Address: 49.0001				
NLPID: 0xCC				
IP Address: 30.30.30.1				
Metric: 10	IS 0000.0000.0003.01			
Metric: 10	IP 30.30.30.0 255.255.255.0			
Metric: 10	IP 20.20.20.0 255.255.255.0			
0000.0000.0003.00-00	0x0000000B	0xFED3	1160	0/0/0
Area Address: 49.0001				
NLPID: 0xCC				
IP Address: 30.30.30.2				
Metric: 10	IS 0000.0000.0003.01			
Metric: 10	IP 30.30.30.0 255.255.255.0			
Metric: 0	IP-External 66.66.66.1 255.255.255.255			
Metric: 0	IP-External 66.66.66.2 255.255.255.255			
Metric: 0	IP-External 66.66.66.3 255.255.255.255			
0000.0000.0003.01-00	0x00000003	0x29AB	837	0/0/0
Metric: 0	IS 0000.0000.0003.00			
Metric: 0	IS 0000.0000.0002.00			

R3#show isis database verbose

Tag 1: VRF : default

IS-IS Level-2 Link State Database:

LSPID	LSP Seq Num	LSP Checksum	LSP Holdtime	ATT/P/OL
0000.0000.0002.00-00	0x00000005	0x1577	818	0/0/0
Area Address: 49.0001				
NLPID: 0xCC				
IP Address: 30.30.30.1				
Metric: 10	IS 0000.0000.0003.01			
Metric: 10	IP 30.30.30.0 255.255.255.0			

```

Metric: 10          IP 20.20.20.0 255.255.255.0
0000.0000.0003.00-00* 0x0000000B  0xFED3          1142          0/0/0
Area Address: 49.0001
NLPID: 0xCC
IP Address: 30.30.30.2
Metric: 10          IS 0000.0000.0003.01
Metric: 10          IP 30.30.30.0 255.255.255.0
Metric: 0           IP-External 66.66.66.1    255.255.255.255
Metric: 0           IP-External 66.66.66.2    255.255.255.255
Metric: 0           IP-External 66.66.66.3    255.255.255.255
0000.0000.0003.01-00* 0x00000003  0x29AB          819          0/0/0
Metric: 0           IS 0000.0000.0003.00
Metric: 0           IS 0000.0000.0002.00

```

IS-IS Distance

Administrative distance in IS-IS can be configured for a specified source ID or for all routes.

This example shows configuring the IS-IS administrative distance for the IPv4 address family.

Topology

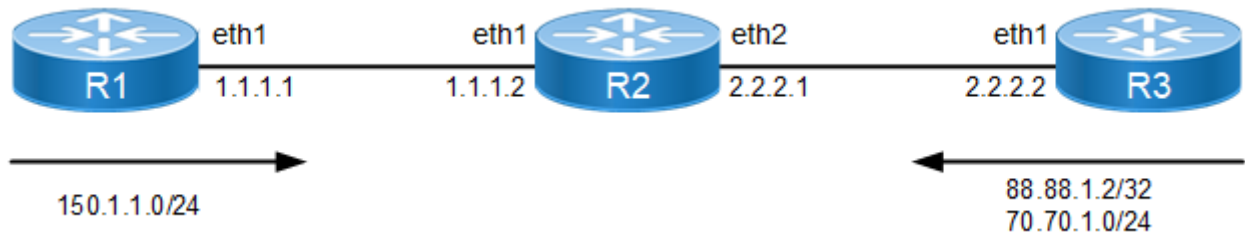

Figure 13-110: IS-IS Distance Topology

Configuration

R1

#configure terminal	Enter configure mode.
(config)#interface eth1	Enter interface mode.
(config-if)#ip address 1.1.1.1/24	Assign the IP address on this interface (eth1).
(config-if)#ip router isis 1	Enable IS-IS routing on interface eth1.
(config-if)#commit	Commit candidate configuration to the running configuration
(config-if)#exit	
(config)#ip route 150.1.1.0/24 eth1	Configure static routes.
(config)#router isis 1	Create an IS-IS routing instance (1).
(config-router)#net 49.0001.0000.0001.00	Set a Network Entity Title (NET) for this instance, specifying the address and the system ID.
(config-router)#redistribute static	Redistribute the static routes.
(config-if)#commit	Commit candidate configuration to the running configuration

R2

#configure terminal	Enter configure mode
(config)#ip access-list DIST	Enter access list mode
(config-ip-acl)#permit ipip 88.88.1.2/32 any	Create an access list to permit the 88.88.1.2/32 route from R3.
(config-if)#commit	Commit candidate configuration to the running configuration
(config-ip-acl)#exit	Exit access list mode
(config)#interface eth1	Enter interface mode.
(config-if)#ip address 1.1.1.2/24	Assign the IP address on this interface (eth1).
(config-if)#ip router isis 1	Enable IS-IS routing on interface eth1
(config-if)#commit	Commit candidate configuration to the running configuration
(config-if)#exit	Exit interface mode
(config)#interface eth2	Enter interface mode.
(config-if)#ip address 2.2.2.1/24	Assign the IP address on this interface (eth2).
(config-if)#ip router isis 1	Enable IS-IS routing on interface eth2
(config-if)#commit	Commit candidate configuration to the running configuration
(config-if)#exit	Exit interface mode
(config)#router isis 1	Create an IS-IS routing instance (1).
(config-router)#net 49.0001.0000.0002.00	Specify the NET address.
(config-router)#distance 100	Configure the administrative distance for all routes received from R1 and R2.
(config-router)#distance 20 0001.0000.0001	Configure the administrative distance for all routes received from R1. This command overwrites the applied distance, 100, and will apply distance 20 for all routes received from R1.
(config-router)#distance 30 0001.0000.0003 DIST	Configure the distance, 30, to the route, 88.88.1.2/32, received from R3. All other routes from R3 (for example, 70.70.1.0/24) will have the distance applied as 100. If the distance, 100, is not configured, all other routes will have a default distance of 115.
(config-if)#commit	Commit candidate configuration to the running configuration

R3

#configure terminal	Enter configure mode.
(config)#interface eth1	Enter interface mode.
(config-if)#ip address 2.2.2.2/24	Assign the IP address on this interface (eth1).
(config-if)#ip router isis 1	Enable IS-IS routing on interface eth1.
(config-if)#commit	Commit candidate configuration to the running configuration
(config-if)#exit	Exit interface mode.
(config)#ip route 88.88.1.2/32 eth2	Configure static routes
(config)#ip route 70.70.1.0/24 eth2	Configure static routes
(config)#router isis 1	Create an IS-IS routing instance (1).
(config-router)#net 49.0001.0000.0003.00	Specify the NET address.

(config-router)#redistribute static	Redistribute the static routes.
(config-if)#commit	Commit candidate configuration to the running configuration

Validation

R1#show clns neighbors

Total number of L1 adjacencies: 1
 Total number of L2 adjacencies: 1
 Total number of adjacencies: 2

Tag 1: VRF : default

System Id	Interface	SNPA	State	Holdtime	Type	Protocol
0001.0000.0002	eth1	5254.002a.230a	Up	18	L1	IS-IS
			Up	18	L2	IS-IS

R2#show clns neighbors

Total number of L1 adjacencies: 2
 Total number of L2 adjacencies: 2
 Total number of adjacencies: 4

Tag 1: VRF : default

System Id	Interface	SNPA	State	Holdtime	Type	Protocol
0001.0000.0001	eth1	5254.00dc.0b76	Up	7	L1	IS-IS
			Up	7	L2	IS-IS
0001.0000.0003	eth2	5254.00a8.940d	Up	8	L1	IS-IS
			Up	8	L2	IS-IS

R3#show clns neighbors

Total number of L1 adjacencies: 1
 Total number of L2 adjacencies: 1
 Total number of adjacencies: 2

Tag 1: VRF : default

System Id	Interface	SNPA	State	Holdtime	Type	Protocol
0001.0000.0002	eth2	5254.007e.5ade	Up	20	L1	IS-IS
			Up	20	L2	IS-IS

R1#show ip isis route

Codes: C - connected, E - external, L1 - IS-IS level-1, L2 - IS-IS level-2
 ia - IS-IS inter area, D - discard, e - external metric
 ** - invalid

Tag 1: VRF : default

	Destination	Metric	Next-Hop	Interface	Tag
C	1.1.1.0/24	10	--	eth1	0
L1	2.2.2.0/24	20	1.1.1.2	eth1	0
L2	70.70.1.0/24	20	1.1.1.2	eth1	0
L2	88.88.1.2/32	20	1.1.1.2	eth1	0
E	150.1.1.0/24	0	--	--	0

R2#show ip isis route

Codes: C - connected, E - external, L1 - IS-IS level-1, L2 - IS-IS level-2
 ia - IS-IS inter area, D - discard, e - external metric
 ** - invalid

Tag 1: VRF : default

	Destination	Metric	Next-Hop	Interface	Tag
C	1.1.1.0/24	10	--	eth1	0
C	2.2.2.0/24	10	--	eth2	0
L2	70.70.1.0/24	10	2.2.2.2	eth2	0
L2	88.88.1.2/32	10	2.2.2.2	eth2	0
L2	150.1.1.0/24	10	1.1.1.1	eth1	0

R3#show ip isis route

Codes: C - connected, E - external, L1 - IS-IS level-1, L2 - IS-IS level-2
 ia - IS-IS inter area, D - discard, e - external metric
 ** - invalid

Tag 1: VRF : default

	Destination	Metric	Next-Hop	Interface	Tag
L1	1.1.1.0/24	20	2.2.2.1	eth2	0
C	2.2.2.0/24	10	--	eth2	0
E	70.70.1.0/24	0	--	--	0
E	88.88.1.2/32	0	--	--	0
L2	150.1.1.0/24	20	2.2.2.1	eth2	0

R1#show ip route

Codes: K - kernel, C - connected, S - static, R - RIP, B - BGP
 O - OSPF, IA - OSPF inter area
 N1 - OSPF NSSA external type 1, N2 - OSPF NSSA external type 2
 E1 - OSPF external type 1, E2 - OSPF external type 2
 i - IS-IS, L1 - IS-IS level-1, L2 - IS-IS level-2,
 ia - IS-IS inter area, E - EVPN,
 v - vrf leaked
 * - candidate default

IP Route Table for VRF "default"

```
C          1.1.1.0/24 is directly connected, eth1, 00:30:56
i L1      2.2.2.0/24 [115/20] via 1.1.1.2, eth1, 00:26:01
C          10.12.30.0/24 is directly connected, eth0, 00:33:46
i L2      70.70.1.0/24 [115/20] via 1.1.1.2, eth1, 00:21:39
i L2      88.88.1.2/32 [115/20] via 1.1.1.2, eth1, 00:15:04
C          127.0.0.0/8 is directly connected, lo, 00:33:46
S          150.1.1.0/24 [1/0] is directly connected, eth1, 00:29:03
```

Gateway of last resort is not set

R2#show ip route

Codes: K - kernel, C - connected, S - static, R - RIP, B - BGP
 O - OSPF, IA - OSPF inter area
 N1 - OSPF NSSA external type 1, N2 - OSPF NSSA external type 2
 E1 - OSPF external type 1, E2 - OSPF external type 2
 i - IS-IS, L1 - IS-IS level-1, L2 - IS-IS level-2,
 ia - IS-IS inter area, E - EVPN,
 v - vrf leaked
 * - candidate default

IP Route Table for VRF "default"

```
C          1.1.1.0/24 is directly connected, eth1, 00:26:46
C          2.2.2.0/24 is directly connected, eth2, 00:26:30
```

```

C          10.12.30.0/24 is directly connected, eth0, 00:33:21
i L2      70.70.1.0/24 [100/10] via 2.2.2.2, eth2, 00:21:55
i L2      88.88.1.2/32 [30/10] via 2.2.2.2, eth2, 00:15:09
C          127.0.0.0/8 is directly connected, lo, 00:33:21
i L2      150.1.1.0/24 [100/10] via 1.1.1.1, eth1, 00:25:53

```

Gateway of last resort is not set

R3#show ip route

```

Codes: K - kernel, C - connected, S - static, R - RIP, B - BGP
       O - OSPF, IA - OSPF inter area
       N1 - OSPF NSSA external type 1, N2 - OSPF NSSA external type 2
       E1 - OSPF external type 1, E2 - OSPF external type 2
       i - IS-IS, L1 - IS-IS level-1, L2 - IS-IS level-2,
       ia - IS-IS inter area, E - EVPN,
       v - vrf leaked
       * - candidate default

```

IP Route Table for VRF "default"

```

i L1      1.1.1.0/24 [115/20] via 2.2.2.1, eth2, 00:22:56
C          2.2.2.0/24 is directly connected, eth2, 00:23:01
C          10.12.30.0/24 is directly connected, eth0, 00:33:57
S          70.70.1.0/24 [1/0] is directly connected, eth2, 00:23:01
S          88.88.1.2/32 [1/0] is directly connected, eth2, 00:16:07
C          127.0.0.0/8 is directly connected, lo, 00:33:57
i L2      150.1.1.0/24 [115/20] via 2.2.2.1, eth2, 00:22:42

```

Gateway of last resort is not set

R1#show isis database

Tag 1: VRF : default

IS-IS Level-1 Link State Database:

LSPID	LSP Seq Num	LSP Checksum	LSP Holdtime	ATT/P/OL
0001.0000.0001.00-00*	0x00000003	0x2AEC	448	0/0/0
0001.0000.0001.01-00*	0x00000002	0x32A4	448	0/0/0
0001.0000.0002.00-00	0x00000004	0x5A80	698	0/0/0
0001.0000.0003.00-00	0x00000006	0xE820	702	0/0/0
0001.0000.0003.01-00	0x00000002	0x3E94	698	0/0/0

IS-IS Level-2 Link State Database:

LSPID	LSP Seq Num	LSP Checksum	LSP Holdtime	ATT/P/OL
0001.0000.0001.00-00*	0x00000008	0xB20F	703	0/0/0
0001.0000.0001.01-00*	0x00000002	0x32A4	448	0/0/0
0001.0000.0002.00-00	0x00000004	0x5A80	698	0/0/0
0001.0000.0003.00-00	0x0000000A	0xB2CE	1108	0/0/0
0001.0000.0003.01-00	0x00000002	0x3E94	698	0/0/0

R2#show isis database

Tag 1: VRF : default

IS-IS Level-1 Link State Database:

LSPID	LSP Seq Num	LSP Checksum	LSP Holdtime	ATT/P/OL
0001.0000.0001.00-00	0x00000003	0x2AEC	402	0/0/0
0001.0000.0001.01-00	0x00000002	0x32A4	401	0/0/0
0001.0000.0002.00-00*	0x00000004	0x5A80	653	0/0/0
0001.0000.0003.00-00	0x00000006	0xE820	656	0/0/0
0001.0000.0003.01-00	0x00000002	0x3E94	652	0/0/0

IS-IS Level-2 Link State Database:

LSPID	LSP Seq Num	LSP Checksum	LSP Holdtime	ATT/P/OL
0001.0000.0001.00-00	0x00000008	0xB20F	657	0/0/0
0001.0000.0001.01-00	0x00000002	0x32A4	401	0/0/0
0001.0000.0002.00-00*	0x00000004	0x5A80	653	0/0/0
0001.0000.0003.00-00	0x0000000A	0xB2CE	1062	0/0/0
0001.0000.0003.01-00	0x00000002	0x3E94	652	0/0/0

R3#show isis database

Tag 1: VRF : default

IS-IS Level-1 Link State Database:

LSPID	LSP Seq Num	LSP Checksum	LSP Holdtime	ATT/P/OL
0001.0000.0001.00-00	0x00000003	0x2AEC	317	0/0/0
0001.0000.0001.01-00	0x00000002	0x32A4	317	0/0/0
0001.0000.0002.00-00	0x00000004	0x5A80	568	0/0/0
0001.0000.0003.00-00*	0x00000006	0xE820	573	0/0/0
0001.0000.0003.01-00*	0x00000002	0x3E94	569	0/0/0

IS-IS Level-2 Link State Database:

LSPID	LSP Seq Num	LSP Checksum	LSP Holdtime	ATT/P/OL
0001.0000.0001.00-00	0x00000008	0xB20F	573	0/0/0
0001.0000.0001.01-00	0x00000002	0x32A4	317	0/0/0
0001.0000.0002.00-00	0x00000004	0x5A80	568	0/0/0
0001.0000.0003.00-00*	0x0000000A	0xB2CE	979	0/0/0
0001.0000.0003.01-00*	0x00000002	0x3E94	569	0/0/0

R1#show isis topology

Tag 1: VRF : default

IS-IS paths to level-1 routers

System Id	Metric	Next-Hop	Interface	SNPA
0001.0000.0001	--			
0001.0000.0002	10	0001.0000.0002	eth1	
5254.002a.230a				
0001.0000.0003	20	0001.0000.0002	eth1	
5254.002a.230a				

IS-IS paths to level-2 routers

System Id	Metric	Next-Hop	Interface	SNPA
0001.0000.0001	--			
0001.0000.0002	10	0001.0000.0002	eth1	
5254.002a.230a				
0001.0000.0003	20	0001.0000.0002	eth1	
5254.002a.230a				

R2#show isis topology

Tag 1: VRF : default

IS-IS paths to level-1 routers

System Id	Metric	Next-Hop	Interface	SNPA
0001.0000.0001	10	0001.0000.0001	eth1	
5254.00dc.0b76				
0001.0000.0002	--			
0001.0000.0003	10	0001.0000.0003	eth2	
5254.00a8.940d				

IS-IS paths to level-2 routers

System Id	Metric	Next-Hop	Interface	SNPA
-----------	--------	----------	-----------	------

```

0001.0000.0001      10      0001.0000.0001      eth1
5254.00dc.0b76
0001.0000.0002      --
0001.0000.0003      10      0001.0000.0003      eth2
5254.00a8.940d

```

```
R3#show isis topology
```

```

Tag 1: VRF : default
IS-IS paths to level-1 routers
System Id      Metric      Next-Hop      Interface      SNPA
0001.0000.0001  20      0001.0000.0002  eth2
5254.007e.5ade
0001.0000.0002  10      0001.0000.0002  eth2
5254.007e.5ade
0001.0000.0003  --
IS-IS paths to level-2 routers
System Id      Metric      Next-Hop      Interface      SNPA
0001.0000.0001  20      0001.0000.0002  eth2
5254.007e.5ade
0001.0000.0002  10      0001.0000.0002  eth2
5254.007e.5ade
0001.0000.0003  --

```

Passive Interface

In ISP and large enterprise networks, many of the distribution routers have more than 200 interfaces. Before the Default Passive-Interface feature, there were two possibilities for obtaining routing information from all of these interfaces:

- Configure a routing protocol on the backbone interfaces and redistribute connected interfaces.
- Configure the routing protocol on all interfaces and manually set most of them as passive, which was time consuming.

The solution to this problem was to configure the routing protocol on all interfaces and manually set the `passive-interface` command on the interfaces where adjacency was not desired. In certain networks, this meant coding 200 or more `passive-interface` statements. With the Default Passive Interface feature, this problem is solved by allowing all interfaces to be set as passive by default using a single `passive-interface default` command, then configuring individual interfaces in which adjacencies are desired using the `passive-interface <interface-name> disable` command.

Usage

1. When a specific interface is configured as passive using the `passive-interface <interface-name>` command:
 - The interface loses its adjacency on that interface, for example, eth1.
 - The interface (eth1) is still advertised by other IS-IS speaking interfaces to their neighbors.
2. When a specific interface is configured as passive using `passive-interface <interface-name>` command followed by removing the configuration using `no passive-interface <interface-name>` command:
 - The interface is IS-IS disabled and must be enabled using the `ip router isis` command (for example, `ip router isis 1`).

- If IS-IS is not configured, the interface (for example, eth1) will not be advertised by other IS-IS speaking interfaces to their neighbors.
3. When an interface is configured with the `passive interface` command:
 - All IS-IS enabled interfaces lose their adjacency.
 - All IS-IS enabled interfaces in the system will be made passive.
 - To establish adjacency on a particular interface, the `passive interface <interface-name> disable` command must be enabled.
 - All interfaces which were made passive are advertised by the active IS-IS speaking interface to its neighbors.
 4. When an interface is configured with the `no passive interface` command:
 - All interfaces which are currently passive, will become active.
 - If IS-IS is configured on those interface, it will start sending out IS-IS packets and attempt to form adjacency.
 - If IS-IS is not configured on those interfaces, it will not be advertised by the active IS-IS speaking interface to its neighbors.

Topology

Figure 13-111 shows a passive-interface configuration example.



Figure 13-111: IS-IS Passive Interface

Configuration

R1

<code>#configure terminal</code>	Enter configure mode.
<code>(config)#router isis 1</code>	Create an IS-IS routing instance (1).
<code>(config-router)#net 49.0001.0000.0000.0001.00</code>	Define the NET address.
<code>(config-router)#is-type level-2-only</code>	Configure instance as level-2-only routing.
<code>(config-if)#commit</code>	Commit candidate configuration to the running configuration
<code>(config-router)#exit</code>	Exit router mode.
<code>(config)#interface eth1</code>	Specify the interface (eth1) to configure and enter Interface mode.
<code>(config-if)#ip address 20.20.20.1/24</code>	Configure IP address on interface.
<code>(config-if)#ip router isis 1</code>	Enable IS-IS routing on interface eth1 (connected to R2).
<code>(config-if)#commit</code>	Commit candidate configuration to the running configuration

R2

#configure terminal	Enter configure mode.
(config)#interface eth1	Specify the interface (eth1)to configure and enter Interface mode.
(config-if)#ip address 20.20.20.2/24	Configure IP address on interface.
(config-if)#ip router isis 1	Enable IS-IS routing on interface eth1 (connected to R1).
(config-if)#exit	Exit interface mode and return to Configure mode.
(config)#interface eth2	Specify the interface (eth2)to configure and enter Interface mode.
(config-if)#ip address 30.30.30.1/24	Configure IP address on interface.
(config-if)#ip router isis 1	Enable IS-IS routing on interface eth2 (connected to R3).
(config-if)#commit	Commit candidate configuration to the running configuration
(config-if)#exit	Exit interface mode and return to Configure mode.
(config)#router isis 1	Create an IS-IS routing instance (1).
(config-router)#net 49.0001.0000.0000.0002.00	Define the NET address.
(config-router)#is-type level-2-only	Configure instance as level-2-only routing.
(config-router)#passive-interface eth1	Configure the eth1 interface as passive.

R3

#configure terminal	Enter configure mode.
(config)#router isis 1	Create an IS-IS routing instance (1).
(config-router)#is-type level-2-only	Configure instance as level-2-only routing.
(config-router)#net 49.0001.0000.0000.0003.00	Define the NET address.
(config-if)#commit	Commit candidate configuration to the running configuration
(config-router)#exit	Exit router mode.
(config)#interface eth2	Specify the interface (eth2)to configure and enter Interface mode.
(config-if)#ip address 30.30.30.2/24	Configure IP address on interface.
(config-if)#ip router isis 1	Enable IS-IS routing on interface eth1 (connected to R2).
(config-if)#commit	Commit candidate configuration to the running configuration

Validation

```
R1#show clns neighbors
```

```
Total number of L1 adjacencies: 0
```

```
Total number of L2 adjacencies: 0
```

```
Total number of adjacencies: 0
```

```
Tag 1: VRF : default
```

```
System Id      Interface      SNPA          State  Holdtime  Type  Protocol
```

```
R2#show clns neighbors
```

```
Total number of L1 adjacencies: 0
Total number of L2 adjacencies: 1
Total number of adjacencies: 1
```

```
Tag 1: VRF : default
```

System Id	Interface	SNPA	State	Holdtime	Type	Protocol
0000.0000.0003	eth2	5254.00a8.940d	Up	9	L2	IS-IS

```
R3#show clns neighbors
```

```
Total number of L1 adjacencies: 0
Total number of L2 adjacencies: 1
Total number of adjacencies: 1
```

```
Tag 1: VRF : default
```

System Id	Interface	SNPA	State	Holdtime	Type	Protocol
0000.0000.0002	eth2	5254.007e.5ade	Up	19	L2	IS-IS

```
R1#show ip isis route
```

```
Codes: C - connected, E - external, L1 - IS-IS level-1, L2 - IS-IS level-2
       ia - IS-IS inter area, D - discard, e - external metric
       ** - invalid
```

```
Tag 1: VRF : default
```

	Destination	Metric	Next-Hop	Interface	Tag
C	20.20.20.0/24	10	--	eth1	0

```
R2#show ip isis route
```

```
Codes: C - connected, E - external, L1 - IS-IS level-1, L2 - IS-IS level-2
       ia - IS-IS inter area, D - discard, e - external metric
       ** - invalid
```

```
Tag 1: VRF : default
```

	Destination	Metric	Next-Hop	Interface	Tag
C	20.20.20.0/24	0	--	eth1	0
C	30.30.30.0/24	10	--	eth2	0

```
R3#show ip isis route
```

```
Codes: C - connected, E - external, L1 - IS-IS level-1, L2 - IS-IS level-2
       ia - IS-IS inter area, D - discard, e - external metric
       ** - invalid
```

```
Tag 1: VRF : default
```

	Destination	Metric	Next-Hop	Interface	Tag
L2	20.20.20.0/24	10	30.30.30.1	eth2	0
C	30.30.30.0/24	10	--	eth2	0

```
R1#show isis database verbose
```

```
Tag 1: VRF : default
```

```
IS-IS Level-2 Link State Database:
```

LSPID	LSP Seq Num	LSP Checksum	LSP Holdtime	ATT/P/OL
0000.0000.0001.00-00*	0x00000004	0x3A02	923	0/0/0

```
Area Address: 49.0001
NLPID: 0xCC
IP Address: 20.20.20.1
Metric: 10 IP 20.20.20.0 255.255.255.0
```

```
0000.0000.0001.01-00* 0x00000001 0xF108 0 (923) 0/0/0
```

```
R2#show isis database verbose
```

```
Tag 1: VRF : default
```

```
IS-IS Level-2 Link State Database:
```

LSPID	LSP Seq Num	LSP Checksum	LSP Holdtime	ATT/P/OL
0000.0000.0001.00-00	0x00000002	0x3EFF	887	0/0/0
Area Address: 49.0001				
NLPID: 0xCC				
IP Address: 20.20.20.1				
Metric: 10 IP 20.20.20.0 255.255.255.0				
0000.0000.0001.01-00	0x00000001	0x21B9	888	0/0/0
Metric: 0 IS 0000.0000.0001.00				
Metric: 0 IS 0000.0000.0002.00				
0000.0000.0002.00-00*	0x00000003	0x3761	906	0/0/0
Area Address: 49.0001				
NLPID: 0xCC				
IP Address: 30.30.30.1				
Metric: 10 IS 0000.0000.0003.01				
Metric: 0 IP 20.20.20.0 255.255.255.0				
Metric: 10 IP 30.30.30.0 255.255.255.0				
0000.0000.0003.00-00	0x00000002	0x530E	909	0/0/0
Area Address: 49.0001				
NLPID: 0xCC				
IP Address: 30.30.30.2				
Metric: 10 IS 0000.0000.0003.01				
Metric: 10 IP 30.30.30.0 255.255.255.0				
0000.0000.0003.01-00	0x00000001	0x2DA9	905	0/0/0
Metric: 0 IS 0000.0000.0003.00				
Metric: 0 IS 0000.0000.0002.00				

```
R3#show isis database verbose
```

```
Tag 1: VRF : default
```

```
IS-IS Level-2 Link State Database:
```

LSPID	LSP Seq Num	LSP Checksum	LSP Holdtime	ATT/P/OL
0000.0000.0001.00-00	0x00000002	0x3EFF	883	0/0/0
Area Address: 49.0001				
NLPID: 0xCC				
IP Address: 20.20.20.1				
Metric: 10 IP 20.20.20.0 255.255.255.0				
0000.0000.0001.01-00	0x00000001	0x21B9	884	0/0/0
Metric: 0 IS 0000.0000.0001.00				
Metric: 0 IS 0000.0000.0002.00				
0000.0000.0002.00-00	0x00000003	0x3761	901	0/0/0
Area Address: 49.0001				
NLPID: 0xCC				
IP Address: 30.30.30.1				
Metric: 10 IS 0000.0000.0003.01				
Metric: 0 IP 20.20.20.0 255.255.255.0				
Metric: 10 IP 30.30.30.0 255.255.255.0				
0000.0000.0003.00-00*	0x00000002	0x530E	906	0/0/0
Area Address: 49.0001				
NLPID: 0xCC				
IP Address: 30.30.30.2				
Metric: 10 IS 0000.0000.0003.01				
Metric: 10 IP 30.30.30.0 255.255.255.0				
0000.0000.0003.01-00*	0x00000001	0x2DA9	902	0/0/0

```

Metric: 0          IS 0000.0000.0003.00
Metric: 0          IS 0000.0000.0002.00

```

```
R1# show isis topology
```

```

Tag 1: VRF : default
IS-IS paths to level-2 routers
System Id          Metric      Next-Hop          Interface      SNPA
0000.0000.0001    --

```

```
R2#show isis topology
```

```

Tag 1: VRF : default
IS-IS paths to level-2 routers
System Id          Metric      Next-Hop          Interface      SNPA
0000.0000.0001    **
0000.0000.0002    --
0000.0000.0003    10         0000.0000.0003   eth2
5254.00a8.940d

```

```
R3#show isis topology
```

```

Tag 1: VRF : default
IS-IS paths to level-2 routers
System Id          Metric      Next-Hop          Interface      SNPA
0000.0000.0001    **
0000.0000.0002    10         0000.0000.0002   eth2
5254.007e.5ade
0000.0000.0003    --

```

IS-IS IPv4 Loop-Free Alternate Fast Reroute

This section contains IS-IS (Intermediate System to Intermediate System) Loop-Free Alternate Fast Reroute (LFA-FRR) configuration examples.

For details about the commands used in these examples, see the *Intermediate System to Intermediate System Command Reference*.

OSPF LFA and ISIS LFA along with MPLS is not supported. Do not configure OSPF LFA or ISIS LFA, if MPLS is configured or vice-versa.

Overview

When a primary next-hop fails, LFA-FRR reduces the failure reaction time to tens of milliseconds using a pre-computed alternate next-hop, so that the alternate can be rapidly used when the failure is detected. A network with this feature experiences less traffic loss and less micro-looping of packets than a network without LFA-FRR.

After you enable LFA-FRR, routers calculate a backup path for each primary path to reach the destination. The backup path is calculated based on the attributes such as node protecting, link protecting, and broadcast link protecting. If there is an ECMP path to reach prefixes, the backup is selected from the same primary set by default; if a secondary tie-breaker is enabled, and if a secondary path is available, the backup will be selected from the secondary path.

Basic Configuration

Topology

Figure 13-112 shows the configuration to enable the basic ISIS LFA feature.

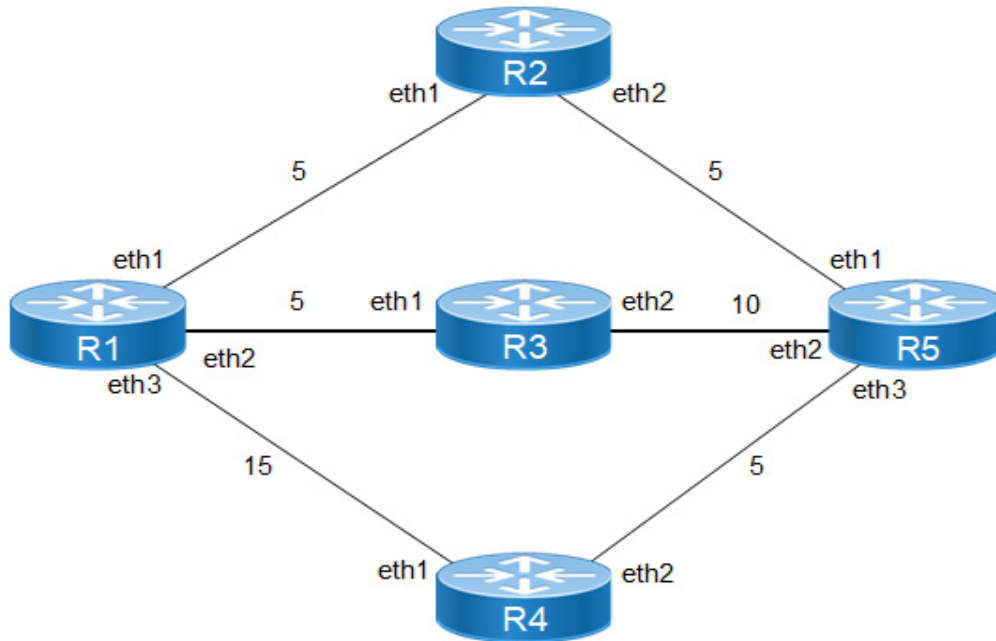

Figure 13-112: ISIS LFA-FRR

R1

#configure terminal	Enter configure mode.
(config)#int eth1	Enter interface mode.
(config-if)#ip address 10.10.10.142/24	Configure the IP address of the interface.
(config-if)#ip router isis 1	Enable ISIS routing on interface for area 49 with instance 1
(config-if)#isis circuit-type level-1	Enable circuit type on interface
(config-if)#isis metric 5	Configure isis metric value for interface
(config-if)#commit	Commit candidate configuration to the running configuration
(config-if)#exit	Exit interface mode.
(config)#int eth2	Enter interface mode.
(config-if)#ip address 20.20.20.142/24	Configure the IP address of the interface.
(config-if)#ip router isis 1	Enable ISIS routing on interface for area 49 with instance 1
(config-if)#isis circuit-type level-1	Enable circuit type on interface
(config-if)#isis metric 5	Configure isis metric value for interface
(config-if)#commit	Commit candidate configuration to the running configuration
(config-if)#exit	Exit interface mode.
(config)#int eth3	Enter interface mode.

(config-if)#ip address 30.30.30.142/24	Configure the IP address of the interface.
(config-if)#ip router isis 1	Enable ISIS routing on interface for area 49 with instance 1
(config-if)#isis circuit-type level-1	Enable circuit type on interface
(config-if)#isis metric 15	Configure isis metric value for interface
(config-if)#commit	Commit candidate configuration to the running configuration
(config-if)#exit	Exit interface mode.
(config)#router isis 1	Create an IS-IS routing instance for area 49 with instance 1
(config-router)#net 49.0000.0000.0001.00	Establish a Network Entity Title for this instance, specifying the area address and the system ID.
(config-router)#bfd all-interfaces	Enable BFD for ISIS on all interfaces
(config-router)#fast-reroute per-prefix level-1 proto ipv4 all	Configure LFA-FRR to calculate the available backup path for all L1 ipv4 prefixes learnt
(config-if)#commit	Commit candidate configuration to the running configuration
(config-router)#exit	Exit router mode.
(config)#exit	Exit config mode.

R2

#configure terminal	Enter configure mode.
(config)#int eth1	Enter interface mode.
(config-if)#ip address 10.10.10.141/24	Configure the IP address of the interface.
(config-if)#ip router isis 1	Enable ISIS routing on interface for area 49 with instance 1
(config-if)#isis circuit-type level-1	Enable circuit type on interface
(config-if)#isis metric 5	Configure isis metric value for interface
(config-if)#commit	Commit candidate configuration to the running configuration
(config-if)#exit	Exit interface mode.
(config)#int eth2	Enter interface mode.
(config-if)#ip address 40.40.40.141/24	Configure the IP address of the interface.
(config-if)#ip router isis 1	Enable ISIS routing on interface for area 49 with instance 1
(config-if)#isis circuit-type level-1	Enable circuit type on interface
(config-if)#isis metric 5	Configure isis metric value for interface
(config-if)#commit	Commit candidate configuration to the running configuration
(config-if)#exit	Exit interface mode.
(config)#router isis 1	Create an IS-IS routing instance for area 49 with instance 1
(config-router)#net 49.0000.0000.0002.00	Establish a Network Entity Title for this instance, specifying the area address and the system ID.
(config-router)#bfd all-interfaces	Enable BFD for ISIS on all interfaces
(config-if)#commit	Commit candidate configuration to the running configuration
(config-router)#exit	Exit router mode.
(config)#exit	Exit config mode.

R3

#configure terminal	Enter configure mode.
(config)#int eth1	Enter interface mode.
(config-if)#ip address 20.20.20.143/24	Configure the IP address of the interface.
(config-if)#ip router isis 1	Enable ISIS routing on interface for area 49 with instance 1
(config-if)#isis metric 5	Configure isis metric value for interface
(config-if)#isis circuit-type level-1	Enable circuit type on interface
(config-if)#commit	Commit candidate configuration to the running configuration
(config-if)#exit	Exit interface mode.
(config)#int eth2	Enter interface mode.
(config-if)#ip address 50.50.50.143/24	Configure the IP address of the interface.
(config-if)#ip router isis 1	Enable ISIS routing on interface for area 49 with instance 1
(config-if)#isis metric 10	Configure isis metric value for interface
(config-if)#isis circuit-type level-1	Enable circuit type on interface
(config-if)#commit	Commit candidate configuration to the running configuration
(config-if)#exit	Exit interface mode.
(config)#router isis 1	Create an IS-IS routing instance for area 49 with instance 1
(config-router)#net 49.0000.0000.0003.00	Establish a Network Entity Title for this instance, specifying the area address and the system ID.
(config-router)#bfd all-interfaces	Enable BFD for ISIS on all interfaces
(config-if)#commit	Commit candidate configuration to the running configuration
(config-router)#exit	Exit router mode.
(config)#exit	Exit config mode.

R4

#configure terminal	Enter configure mode.
(config)#int eth1	Enter interface mode.
(config-if)#ip address 30.30.30.144/24	Configure the IP address of the interface.
(config-if)#ip router isis 1	Enable ISIS routing on interface for area 49 with instance 1
(config-if)#isis metric 15	Configure isis metric value for interface
(config-if)#isis circuit-type level-1	Enable circuit type on interface
(config-if)#commit	Commit candidate configuration to the running configuration
(config-if)#exit	Exit interface mode.
(config)#int eth2	Enter interface mode.
(config-if)#ip address 60.60.60.144/24	Configure the IP address of the interface.
(config-if)#ip router isis 1	Enable ISIS routing on interface for area 49 with instance 1
(config-if)#isis metric 5	Configure isis metric value for interface
(config-if)#isis circuit-type level-1	Enable circuit type on interface
(config-if)#commit	Commit candidate configuration to the running configuration
(config-if)#exit	Exit interface mode.

(config)#router isis 1	Create an IS-IS routing instance for area 49 with instance 1
(config-router)#net 49.0000.0000.0004.00	Establish a Network Entity Title for this instance, specifying the area address and the system ID.
(config-router)#bfd all-interfaces	Enable BFD for ISIS on all interfaces
(config-if)#commit	Commit candidate configuration to the running configuration
(config-router)#exit	Exit router mode.
(config)#exit	Exit config mode.

R5

#configure terminal	Enter configure mode.
(config)#int eth1	Enter interface mode.
(config-if)#ip address 40.40.40.145/24	Configure the IP address of the interface.
(config-if)#ip router isis 1	Enable ISIS routing on interface for area 49 with instance 1
(config-if)#isis metric 5	Configure isis metric value for interface
(config-if)#isis circuit-type level-1	Enable circuit type on interface
(config-if)#commit	Commit candidate configuration to the running configuration
(config-if)#exit	Exit interface mode.
(config)#int eth2	Enter interface mode.
(config-if)#ip address 50.50.50.145/24	Configure the IP address of the interface.
(config-if)#ip router isis 1	Enable ISIS routing on interface for area 49 with instance 1
(config-if)#isis metric 10	Configure isis metric value for interface
(config-if)#isis circuit-type level-1	Enable circuit type on interface
(config-if)#commit	Commit candidate configuration to the running configuration
(config-if)#exit	Exit interface mode.
(config)#int eth3	Enter interface mode.
(config-if)#ip address 60.60.60.145/24	Configure the IP address of the interface.
(config-if)#ip router isis 1	Enable ISIS routing on interface for area 49 with instance 1
(config-if)#isis metric 5	Configure isis metric value for interface
(config-if)#isis circuit-type level-1	Enable circuit type on interface
(config-if)#commit	Commit candidate configuration to the running configuration
(config-if)#exit	Exit interface mode.
(config)#router isis 1	Create an IS-IS routing instance for area 49 with instance 1
(config-router)#net 49.0000.0000.0005.00	Establish a Network Entity Title for this instance, specifying the area address and the system ID.
(config-router)#bfd all-interfaces	Enable BFD for ISIS on all interfaces
(config-if)#commit	Commit candidate configuration to the running configuration
(config-router)#exit	Exit router mode.
(config)#exit	Exit config mode.

Validation

R1

ISIS neighborship:

R1#show clns neighbors

Total number of L1 adjacencies: 3

Total number of L2 adjacencies: 0

Total number of adjacencies: 3

Tag 1: VRF : default

System Id	Interface	SNPA	State	Holdtime	Type	Protocol
0000.0000.0002	eth1	5254.002a.230a	Up	27	L1	IS-IS
0000.0000.0003	eth2	5254.00dc.2f11	Up	7	L1	IS-IS
0000.0000.0004	eth3	5254.00f5.35a4	Up	7	L1	IS-IS

R2#show clns neighbors

Total number of L1 adjacencies: 2

Total number of L2 adjacencies: 0

Total number of adjacencies: 2

Tag 1: VRF : default

System Id	Interface	SNPA	State	Holdtime	Type	Protocol
0000.0000.0001	eth1	5254.00dc.0b76	Up	6	L1	IS-IS
0000.0000.0005	eth2	5254.00b3.110c	Up	7	L1	IS-IS

R3#show clns neighbors

Total number of L1 adjacencies: 2

Total number of L2 adjacencies: 0

Total number of adjacencies: 2

Tag 1: VRF : default

System Id	Interface	SNPA	State	Holdtime	Type	Protocol
0000.0000.0001	eth1	5254.00a1.6afe	Up	22	L1	IS-IS
0000.0000.0005	eth2	5254.0056.7a3d	Up	27	L1	IS-IS

R4#show clns neighbors

Total number of L1 adjacencies: 2

Total number of L2 adjacencies: 0

Total number of adjacencies: 2

Tag 1: VRF : default

System Id	Interface	SNPA	State	Holdtime	Type	Protocol
0000.0000.0001	eth1	5254.0011.a028	Up	21	L1	IS-IS
0000.0000.0005	eth2	5254.00d3.fb41	Up	21	L1	IS-IS

R5#show clns neighbors

Total number of L1 adjacencies: 3

Total number of L2 adjacencies: 0

Total number of adjacencies: 3

Tag 1: VRF : default

System Id	Interface	SNPA	State	Holdtime	Type	Protocol
-----------	-----------	------	-------	----------	------	----------

```

0000.0000.0002 eth1      5254.007e.5ade      Up      27      L1      IS-IS
0000.0000.0003 eth2      5254.00a8.940d      Up       6      L1      IS-IS
0000.0000.0004 eth3      5254.00e2.aece      Up       7      L1      IS-IS

```

Check the ISIS route installation with primary and backup paths in the ISIS table and RIB table.

Primary paths:

```
R1#show ip isis route
```

```

Codes: C - connected, E - external, L1 - IS-IS level-1, L2 - IS-IS level-2
      ia - IS-IS inter area, D - discard, e - external metric
      ** - invalid

```

```
Tag 1: VRF : default
```

	Destination	Metric	Next-Hop	Interface	Tag
C	10.10.10.0/24	5	--	eth1	0
C	20.20.20.0/24	5	--	eth2	0
C	30.30.30.0/24	15	--	eth3	0
L1	40.40.40.0/24	10	10.10.10.141	eth1	0
L1	50.50.50.0/24	15	20.20.20.143	eth2	0
L1	60.60.60.0/24	15	10.10.10.141	eth1	0

```
R1#show ip route
```

```

Codes: K - kernel, C - connected, S - static, R - RIP, B - BGP
      O - OSPF, IA - OSPF inter area
      N1 - OSPF NSSA external type 1, N2 - OSPF NSSA external type 2
      E1 - OSPF external type 1, E2 - OSPF external type 2
      i - IS-IS, L1 - IS-IS level-1, L2 - IS-IS level-2,
      ia - IS-IS inter area, E - EVPN,
      v - vrf leaked
      * - candidate default

```

```
IP Route Table for VRF "default"
```

```

C      10.10.10.0/24 is directly connected, eth1, 00:43:14
C      10.12.30.0/24 is directly connected, eth0, 01:42:55
C      20.20.20.0/24 is directly connected, eth2, 00:43:14
C      30.30.30.0/24 is directly connected, eth3, 00:43:14
i L1   40.40.40.0/24 [115/10] via 10.10.10.141, eth1, 00:16:42
i L1   50.50.50.0/24 [115/15] via 20.20.20.143, eth2, 00:16:55
i L1   60.60.60.0/24 [115/15] via 10.10.10.141, eth1, 00:16:42
C      127.0.0.0/8 is directly connected, lo, 01:42:55

```

```
Gateway of last resort is not set
```

R1#FRR backup paths:

```
R1#show ip isis route fast-reroute
```

```
Tag : 1 VRF : default
```

```

Codes : L1 - IS-IS level-1, L2 - IS-IS level-2, ia - IS-IS inter area,
      D - discard, LP - Link Protecting, NP - Node Protecting,
      BP - Broadcast Interface Disjoint, Pri - Primary Path,
      Sec - Secondary Path, DP - Downstream Path

```

```

L1 40.40.40.0/24
    Primary Path via : 10.10.10.141, eth1

```

```

FRR Backup Path via : 30.30.30.144, eth3
FRR Metric           : 25
Protection Provided  : LP NP BP

L1 50.50.50.0/24
Primary Path via     : 20.20.20.143, eth2
FRR Backup Path via : 10.10.10.141, eth1
FRR Metric           : 20
Protection Provided  : LP NP BP

L1 60.60.60.0/24
Primary Path via     : 10.10.10.141, eth1
FRR Backup Path via : 30.30.30.144, eth3
FRR Metric           : 20
Protection Provided  : LP NP BP DP

R1#show ip route fast-reroute
Codes: K - kernel, C - connected, S - static, R - RIP, B - BGP
       O - OSPF, IA - OSPF inter area
       N1 - OSPF NSSA external type 1, N2 - OSPF NSSA external type 2
       E1 - OSPF external type 1, E2 - OSPF external type 2
       i - IS-IS, L1 - IS-IS level-1, L2 - IS-IS level-2, ia - IS-IS inter
area ,p - stale info
       * - candidate default

IP Route Table for VRF "default"
i L1   40.40.40.0/24 [115/10] via 10.10.10.141, eth1, 00:18:01
        [FRR-NH] via 30.30.30.144, eth3

i L1   50.50.50.0/24 [115/15] via 20.20.20.143, eth2, 00:18:14
        [FRR-NH] via 10.10.10.141, eth1

i L1   60.60.60.0/24 [115/15] via 10.10.10.141, eth1, 00:18:01
        [FRR-NH] via 30.30.30.144, eth3

```

It is not mandatory that for all primary paths, there exists an LFA backup path only if inequality equation satisfies according to attributes configured on routers, backup path will be calculated.

To prohibit an interface from being used as a repair path, disable fast reroute calculation on the interface:

R1(config-if)#interface eth1	Enter interface.
(config-if)# isis fast-reroute per-prefix candidate disable level-1	Disable fast reroute calculation on the interface.
(config-if)#end	Exit.

Verify that the eth1 interface is not used for backup path calculation.

```

R1#show ip isis route fast-reroute

Tag   : 1   VRF : default
Codes : L1 - IS-IS level-1, L2 - IS-IS level-2, ia - IS-IS inter area,
        D - discard, LP - Link Protecting, NP - Node Protecting,
        BP - Broadcast Interface Disjoint, Pri - Primary Path,
        Sec - Secondary Path, DP - Downstream Path

L1 40.40.40.0/24
Primary Path via     : 10.10.10.141, eth1

```

```
FRR Backup Path via : 30.30.30.144, eth3
FRR Metric           : 25
Protection Provided  : LP NP BP
```

```
L1 50.50.50.0/24
Primary Path via    : 20.20.20.143, eth2
FRR Backup Path via : 30.30.30.144, eth3
FRR Metric          : 30
Protection Provided : LP NP BP
```

```
L1 60.60.60.0/24
Primary Path via    : 10.10.10.141, eth1
FRR Backup Path via : 30.30.30.144, eth3
FRR Metric          : 20
Protection Provided : LP NP BP DP
```

```
R1#show ip route fast-reroute
Codes: K - kernel, C - connected, S - static, R - RIP, B - BGP
       O - OSPF, IA - OSPF inter area
       N1 - OSPF NSSA external type 1, N2 - OSPF NSSA external type 2
       E1 - OSPF external type 1, E2 - OSPF external type 2
       i - IS-IS, L1 - IS-IS level-1, L2 - IS-IS level-2, ia - IS-IS inter
       area ,p - stale info
       * - candidate default
```

```
IP Route Table for VRF "default"
i L1 40.40.40.0/24 [115/10] via 10.10.10.141, eth1, 00:20:22
      [FRR-NH] via 30.30.30.144, eth3

i L1 50.50.50.0/24 [115/15] via 20.20.20.143, eth2, 00:20:35
      [FRR-NH] via 30.30.30.144, eth3

i L1 60.60.60.0/24 [115/15] via 10.10.10.141, eth1, 00:20:22
      [FRR-NH] via 30.30.30.144, eth3
```

```
R1#
```

Backup Path based on Route-Map Prefixes

R1

Route-map and access-list configuration:

(config)#ip access-list 1	Create an access-list
(config-ip-acl)#permit any 40.40.40.0 0.0.0.255 any	Configuring rule to permit only one prefix
(config)#route-map rmap1 permit 1	Create a route-map
(config-route-map)#match ip address 1	Apply above created access-list in route-map
(config-if)#commit	Commit candidate configuration to the running configuration
(config)#exit	Exit config mode.

Apply the above created route-map with fast-reroute:

(config)#router isis 1	Create an IS-IS routing instance for area 49 with instance 1
(config-router)#fast-reroute per-prefix level-1 proto ipv4 route-map rmap1	Configure LFA-FRR to calculate the available backup path for routes allowed through route-map
(config-if)#commit	Commit candidate configuration to the running configuration
(config-router)#exit	Exit router mode.
(config)#exit	Exit config mode.

Validation

```
R1#show ip route
Codes: K - kernel, C - connected, S - static, R - RIP, B - BGP
       O - OSPF, IA - OSPF inter area
       N1 - OSPF NSSA external type 1, N2 - OSPF NSSA external type 2
       E1 - OSPF external type 1, E2 - OSPF external type 2
       i - IS-IS, L1 - IS-IS level-1, L2 - IS-IS level-2,
       ia - IS-IS inter area, E - EVPN,
       v - vrf leaked
       * - candidate default
```

```
IP Route Table for VRF "default"
C       10.10.10.0/24 is directly connected, eth1, 01:02:04
C       10.12.30.0/24 is directly connected, eth0, 02:01:45
C       20.20.20.0/24 is directly connected, eth2, 01:02:04
C       30.30.30.0/24 is directly connected, eth3, 01:02:04
i L1    40.40.40.0/24 [115/10] via 10.10.10.141, eth1, 00:35:32
i L1    50.50.50.0/24 [115/15] via 20.20.20.143, eth2, 00:35:45
i L1    60.60.60.0/24 [115/15] via 10.10.10.141, eth1, 00:35:32
C       127.0.0.0/8 is directly connected, lo, 02:01:45
```

Gateway of last resort is not set

```
R1#show ip isis route fast-reroute
```

```
Tag      : 1   VRF : default
Codes : L1 - IS-IS level-1, L2 - IS-IS level-2, ia - IS-IS inter area,
       D - discard, LP - Link Protecting, NP - Node Protecting,
       BP - Broadcast Interface Disjoint, Pri - Primary Path,
       Sec - Secondary Path, DP - Downstream Path
```

```
L1 40.40.40.0/24
   Primary Path via      : 10.10.10.141, eth1
   FRR Backup Path via   : 30.30.30.144, eth3
   FRR Metric            : 25
   Protection Provided   : LP NP BP
```

```
R1#show ip route fast-reroute
Codes: K - kernel, C - connected, S - static, R - RIP, B - BGP
       O - OSPF, IA - OSPF inter area
       N1 - OSPF NSSA external type 1, N2 - OSPF NSSA external type 2
       E1 - OSPF external type 1, E2 - OSPF external type 2
       i - IS-IS, L1 - IS-IS level-1, L2 - IS-IS level-2, ia - IS-IS inter
area ,p - stale info
       * - candidate default
```

```
IP Route Table for VRF "default"
i L1      40.40.40.0/24 [115/10] via 10.10.10.141, eth1, 00:35:48
          [FRR-NH] via 30.30.30.144, eth3  FRR Table has only
allowed prefix through route-map , for remaining prefixes, FRR not present
```

LFA Tie-Breaker

Based on the index values configured, if inequalities are satisfied, protections will be provided:

- Lower the index will have the highest priority, The path which provides protection with highest priority will be selected. If there are multiple paths providing the highest priority protection then we will check which of the path provides the protection which has 2nd highest priority and so on.
- If all the paths provide same priority, then the LFA route is chosen on the basis of path cost.
- If none of the paths provides the protection with highest priority, then we will see which path provides the 2nd highest priority and so on.

The show command below displays default values for tie-breaker, by default maximum protection (link, node, broadcast, if ecmp, ecmp backup path) will be provided.

After configuring tie-breaker with index, values will be changed accordingly.

```
R1#show ip isis lfa-config level-1
```

```
TIE-Breaker Preference values
```

```
-----
Primary Path           : 20
Link Protecting        : 60
Node Protecting        : 30
Broadcast Interface Disjoint : 70
Secondary Path         : 255
Downstream Path        : 90
```

```
Termination Hold On Interval : 1000 ms
```

R1

To change index values, below configurations should be used, with the lower the index highest the priority.

<code>(config)#router isis 1</code>	Create an IS-IS routing instance for area 49 with instance 1
<code>(config-router)#fast-reroute per-prefix level-1 proto ipv4 all</code>	Configure LFA-FRR to calculate the available backup path for all L1 ipv4 prefixes learned
<code>(config-router)#fast-reroute tie-break level-1 proto ipv4 interface-disjoint index 1</code>	Configure index value to change priority for link protection
<code>(config-router)#fast-reroute tie-break level-1 proto ipv4 node-protecting index 2</code>	Configure index value to change priority for node protection
<code>(config-router)#fast-reroute tie-break level-1 proto ipv4 broadcast-interface-disjoint index 3</code>	Configure index value to change priority for broadcast link protection

(config-if)#commit	Commit candidate configuration to the running configuration
(config-router)#exit	Exit router mode.
(config)#exit	Exit config mode.

Validation

```
R1#show ip isis lfa-config level-1
```

```
TIE-Breaker Preference values
```

```
-----
Primary Path           : 20
Link Protecting        : 1
Node Protecting        : 2
Broadcast Interface Disjoint : 3
Secondary Path         : 255
Downstream Path        : 90
```

```
Termination Hold On Interval : 1000 ms
```

```
R1#show ip isis route fast-reroute
```

```
Tag      : 1  VRF : default
Codes : L1 - IS-IS level-1, L2 - IS-IS level-2, ia - IS-IS inter area,
        D - discard, LP - Link Protecting, NP - Node Protecting,
        BP - Broadcast Interface Disjoint, Pri - Primary Path,
        Sec - Secondary Path, DP - Downstream Path
```

```
L1 40.40.40.0/24
Primary Path via      : 10.10.10.141, eth1
FRR Backup Path via  : 30.30.30.144, eth3
FRR Metric            : 25
Protection Provided  : LP NP BP
```

```
L1 50.50.50.0/24
Primary Path via      : 20.20.20.143, eth2
FRR Backup Path via  : 30.30.30.144, eth3
FRR Metric            : 20
Protection Provided  : LP NP BP
```

```
L1 60.60.60.0/24
Primary Path via      : 10.10.10.141, eth1
FRR Backup Path via  : 30.30.30.144, eth3
FRR Metric            : 20
Protection Provided  : LP NP BP DP
```

```
R1#show ip route fast-reroute
```

```
Codes: K - kernel, C - connected, S - static, R - RIP, B - BGP
        O - OSPF, IA - OSPF inter area
        N1 - OSPF NSSA external type 1, N2 - OSPF NSSA external type 2
        E1 - OSPF external type 1, E2 - OSPF external type 2
        i - IS-IS, L1 - IS-IS level-1, L2 - IS-IS level-2, ia - IS-IS inter
area ,p - stale info
        * - candidate default
```

```
IP Route Table for VRF "default"
```

```

i L1    40.40.40.0/24 [115/10] via 10.10.10.141, eth1, 00:45:16
          [FRR-NH] via 30.30.30.144, eth3

i L1    50.50.50.0/24 [115/15] via 20.20.20.143, eth2, 00:45:29
          [FRR-NH] via 30.30.30.144, eth3

i L1    60.60.60.0/24 [115/15] via 10.10.10.141, eth1, 00:45:16
          [FRR-NH] via 30.30.30.144, eth3

```

LFA Termination

A router MUST limit the amount of time an alternate next-hop is used after the primary next-hop has become unavailable. This ensures that the router will start using the new primary next-hops.

LFA termination avoids a micro looping in topology, when particular network goes down, LFA backup path will be installed and if termination interval is configured, LFA backup will be still used till the interval and it is used in order to verify new primary path is loop free.

R1

Configure termination interval on R1 in router mode:

(config)#router isis 1	Create an IS-IS routing instance for area 49 with instance 1
(config-router)#fast-reroute terminate-hold-on interval 100000	Configure LFA termination interval
(config-if)#commit	Commit candidate configuration to the running configuration
(config-router)#exit	Exit router mode.
(config)#exit	Exit config mode.

Validation

```
R1#show ip isis lfa-config level-1
```

```
TIE-Breaker Preference values
```

```

-----
Primary Path           : 20
Link Protecting       : 1
Node Protecting       : 2
Broadcast Interface Disjoint : 3
Secondary Path        : 255
Downstream Path       : 90

```

```
Termination Hold On Interval : 100000 ms
```

```
R1#show ip route
```

```

Codes: K - kernel, C - connected, S - static, R - RIP, B - BGP
       O - OSPF, IA - OSPF inter area
       N1 - OSPF NSSA external type 1, N2 - OSPF NSSA external type 2
       E1 - OSPF external type 1, E2 - OSPF external type 2
       i - IS-IS, L1 - IS-IS level-1, L2 - IS-IS level-2,

```

```

ia - IS-IS inter area, E - EVPN,
v - vrf leaked
* - candidate default

```

IP Route Table for VRF "default"

```

C          10.10.10.0/24 is directly connected, eth1, 01:19:46
C          10.12.30.0/24 is directly connected, eth0, 02:19:27
C          20.20.20.0/24 is directly connected, eth2, 01:19:46
C          30.30.30.0/24 is directly connected, eth3, 01:19:46
i L1      40.40.40.0/24 [115/10] via 10.10.10.141, eth1, 00:53:14
i L1      50.50.50.0/24 [115/15] via 20.20.20.143, eth2, 00:53:27
i L1      60.60.60.0/24 [115/15] via 10.10.10.141, eth1, 00:53:14
C          127.0.0.0/8 is directly connected, lo, 02:19:27

```

Gateway of last resort is not set

Shut down one of the primary nexthops, here eth2 of R1:

(config)#interface eth2	Enter interface mode
(config-if)#shutdown	Shutdown the interface
(config-if)#exit	Exit interface mode
(config)#exit	Exit config mode

Validation

```
R1#show clns neighbors
```

```

Total number of L1 adjacencies: 2
Total number of L2 adjacencies: 0
Total number of adjacencies: 2
Tag 1: VRF : default

```

System Id	Interface	SNPA	State	Holdtime	Type	Protocol
0000.0000.0002	eth1	5254.002a.230a	Up	27	L1	IS-IS
0000.0000.0004	eth3	5254.00f5.35a4	Up	7	L1	IS-IS

Here, eth1 has become a primary path, which was originally a backup path:

```

R1#show ip route
Codes: K - kernel, C - connected, S - static, R - RIP, B - BGP
       O - OSPF, IA - OSPF inter area
       N1 - OSPF NSSA external type 1, N2 - OSPF NSSA external type 2
       E1 - OSPF external type 1, E2 - OSPF external type 2
       i - IS-IS, L1 - IS-IS level-1, L2 - IS-IS level-2,
       ia - IS-IS inter area, E - EVPN,
       v - vrf leaked
       * - candidate default

```

IP Route Table for VRF "default"

```

C          10.10.10.0/24 is directly connected, eth1, 01:24:47
C          10.12.30.0/24 is directly connected, eth0, 02:24:28
C          30.30.30.0/24 is directly connected, eth3, 01:24:47
i L1      40.40.40.0/24 [115/10] via 10.10.10.141, eth1, 00:02:01
i L1      50.50.50.0/24 [115/20] via 10.10.10.141, eth1, 00:02:01
i L1      60.60.60.0/24 [115/15] via 10.10.10.141, eth1, 00:02:01
C          127.0.0.0/8 is directly connected, lo, 02:24:28

```

Gateway of last resort is not set

R1#show ip isis route

Codes: C - connected, E - external, L1 - IS-IS level-1, L2 - IS-IS level-2
 ia - IS-IS inter area, D - discard, e - external metric
 ** - invalid

Tag 1: VRF : default

	Destination	Metric	Next-Hop	Interface	Tag
C	10.10.10.0/24	5	--	eth1	0
C	30.30.30.0/24	15	--	eth3	0
L1	40.40.40.0/24	10	10.10.10.141	eth1	0
L1	50.50.50.0/24	20	10.10.10.141	eth1	0
L1	60.60.60.0/24	15	10.10.10.141	eth1	0

R1#show ip isis route fast-reroute

Tag : 1 VRF : default

Codes : L1 - IS-IS level-1, L2 - IS-IS level-2, ia - IS-IS inter area,
 D - discard, LP - Link Protecting, NP - Node Protecting,
 BP - Broadcast Interface Disjoint, Pri - Primary Path,
 Sec - Secondary Path, DP - Downstream Path

L1 40.40.40.0/24
 Primary Path via : 10.10.10.141, eth1
 FRR Backup Path via : 30.30.30.144, eth3
 FRR Metric : 25
 Protection Provided : LP NP BP

L1 50.50.50.0/24
 Primary Path via : 10.10.10.141, eth1
 FRR Backup Path via : 30.30.30.144, eth3
 FRR Metric : 30
 Protection Provided : LP NP BP DP

L1 60.60.60.0/24
 Primary Path via : 10.10.10.141, eth1
 FRR Backup Path via : 30.30.30.144, eth3
 FRR Metric : 20
 Protection Provided : LP NP BP DP

R1#show ip route fast-reroute

Codes: K - kernel, C - connected, S - static, R - RIP, B - BGP
 O - OSPF, IA - OSPF inter area
 N1 - OSPF NSSA external type 1, N2 - OSPF NSSA external type 2
 E1 - OSPF external type 1, E2 - OSPF external type 2
 i - IS-IS, L1 - IS-IS level-1, L2 - IS-IS level-2, ia - IS-IS inter
 area ,p - stale info
 * - candidate default

IP Route Table for VRF "default"

i L1 40.40.40.0/24 [115/10] via 10.10.10.141, eth1, 00:02:19
 [FRR-NH] via 30.30.30.144, eth3

i L1 50.50.50.0/24 [115/20] via 10.10.10.141, eth1, 00:02:19
 [FRR-NH] via 30.30.30.144, eth3

```
i L1    60.60.60.0/24 [115/15] via 10.10.10.141, eth1, 00:02:19
        [FRR-NH] via 30.30.30.144, eth3
```

LFA For ECMP Paths

Equal-Cost Multi-Path Routing (ECMP) is a routing technique where next-hop packet forwarding to a single destination can occur over multiple “best-paths” that tie in routing metric calculations. Because it is a per-hop decision limited to a single router, it can increase bandwidth by load-balancing traffic over multiple paths.

Here, we provide configuration capabilities for Loop-Free Alternate (LFA) Fast Reroute (FRR) along with ECMP.

Topology

Figure 13-113 shows the configuration to enable the ISIS LFA feature with ECMP.

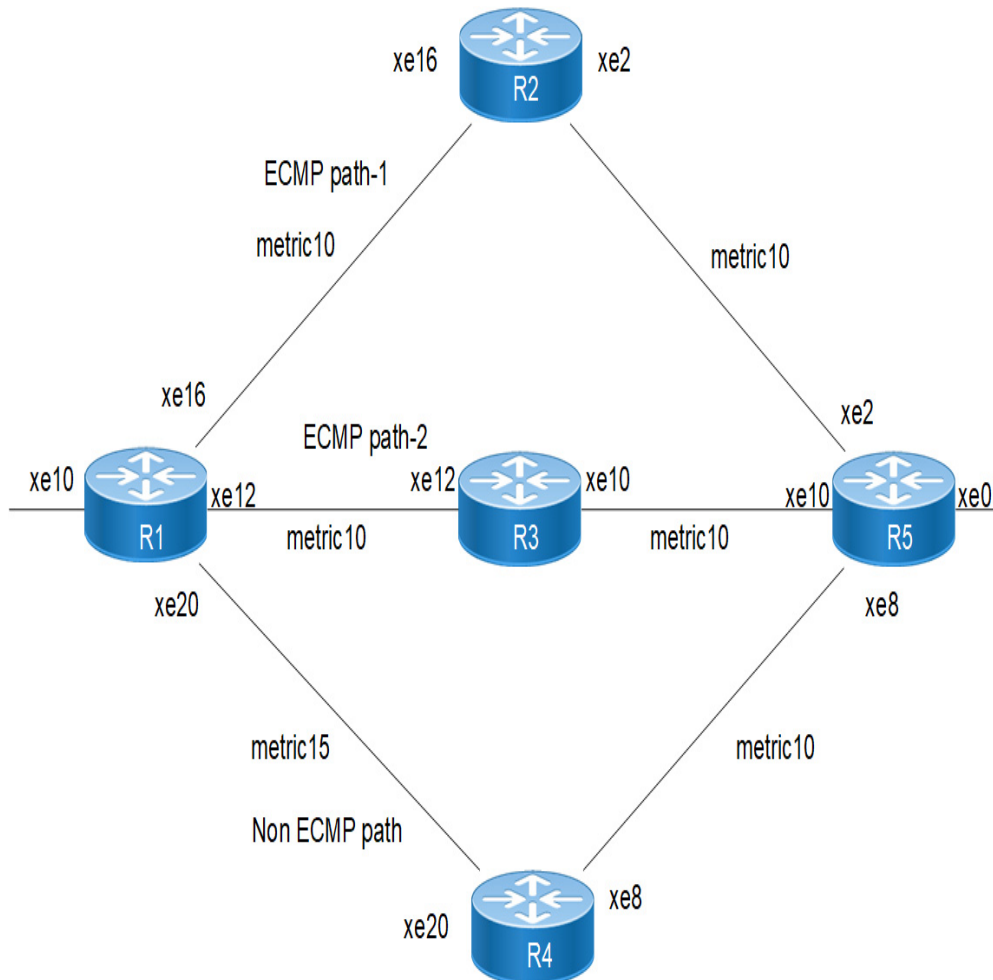

Figure 13-113: ISIS LFA-FRR ECMP

R1

#configure terminal	Enter configure mode.
(config)#int xe16	Enter interface mode.
(config-if)#ip address 10.1.1.1/24	Configure the IP address of the interface.
(config-if)#ip router isis 1	Enable ISIS routing on interface for area 49 with instance 1
(config-if)#isis metric 10	Configure isis metric value for interface
(config-if)#isis circuit-type level-1	Enable circuit type on interface
(config-if)#commit	Commit candidate configuration to the running configuration
(config-if)#exit	Exit interface mode.
(config)#int xe12	Enter interface mode.
(config-if)#ip address 20.1.1.1/24	Configure the IP address of the interface.
(config-if)#ip router isis 1	Enable ISIS routing on interface for area 49 with instance 1
(config-if)#isis metric 10	Configure isis metric value for interface
(config-if)#isis circuit-type level-1	Enable circuit type on interface
(config-if)#commit	Commit candidate configuration to the running configuration
(config-if)#exit	Exit interface mode.
(config)#int xe20	Enter interface mode.
(config-if)#ip address 30.1.1.1/24	Configure the IP address of the interface.
(config-if)#ip router isis 1	Enable ISIS routing on interface for area 49 with instance 1
(config-if)#isis metric 15	Configure isis metric value for interface
(config-if)#isis circuit-type level-1	Enable circuit type on interface
(config-if)#commit	Commit candidate configuration to the running configuration
(config-if)#exit	Exit interface mode.
(config)#int xe10	Enter interface mode.
(config-if)#ip address 31.1.1.1/24	Configure the IP address of the interface.
(config-if)#ip router isis 1	Enable ISIS routing on interface for area 49 with instance 1
(config-if)#isis metric 10	Configure isis metric value for interface
(config-if)#isis circuit-type level-1	Enable circuit type on interface
(config-if)#commit	Commit candidate configuration to the running configuration
(config-if)#exit	Exit interface mode.
(config)#router isis 1	Create an IS-IS routing instance for area 49 with instance 1
(config-router)# net 49.0001.0000.0000.0001.00	Establish a Network Entity Title for this instance, specifying the area address and the system ID.
(config-router)#bfd all-interfaces	Enable BFD for ISIS on all interfaces
(config-router)#fast-reroute per-prefix level-1 proto ipv4 all	Configure LFA-FRR to calculate the available backup path for all L1 ipv4 prefixes learnt
(config-if)#commit	Commit candidate configuration to the running configuration
(config-router)#exit	Exit router mode.
(config)#exit	Exit config mode.

R2

#configure terminal	Enter configure mode.
(config)#int xe16	Enter interface mode.
(config-if)#ip address 10.1.1.2/24	Configure the IP address of the interface.
(config-if)#ip router isis 1	Enable ISIS routing on interface for area 49 with instance 1
(config-if)#isis metric 10	Configure isis metric value for interface
(config-if)#isis circuit-type level-1	Enable circuit type on interface
(config-if)#commit	Commit candidate configuration to the running configuration
(config-if)#exit	Exit interface mode.
(config)#int xe2	Enter interface mode.
(config-if)#ip address 40.1.1.1/24	Configure the IP address of the interface.
(config-if)#ip router isis 1	Enable ISIS routing on interface for area 49 with instance 1
(config-if)#isis metric 10	Configure isis metric value for interface
(config-if)#isis circuit-type level-1	Enable circuit type on interface
(config-if)#commit	Commit candidate configuration to the running configuration
(config-if)#exit	Exit interface mode.
(config)#router isis 1	Create an IS-IS routing instance for area 49 with instance 1
(config-router)# net 49.0001.0000.0000.0002.00	Establish a Network Entity Title for this instance, specifying the area address and the system ID.
(config-router)#bfd all-interfaces	Enable BFD for ISIS on all interfaces
(config-if)#commit	Commit candidate configuration to the running configuration
(config-router)#exit	Exit router mode.
(config)#exit	Exit config mode.

R3

#configure terminal	Enter configure mode.
(config)#int xe12	Enter interface mode.
(config-if)#ip address 20.1.1.1/24	Configure the IP address of the interface.
(config-if)#ip router isis 1	Enable ISIS routing on interface for area 49 with instance 1
(config-if)#isis metric 10	Configure isis metric value for interface
(config-if)#isis circuit-type level-1	Enable circuit type on interface
(config-if)#commit	Commit candidate configuration to the running configuration
(config-if)#exit	Exit interface mode.
(config)#int xe10	Enter interface mode.
(config-if)#ip address 50.1.1.1/24	Configure the IP address of the interface.
(config-if)#ip router isis 1	Enable ISIS routing on interface for area 49 with instance 1
(config-if)#isis metric 10	Configure isis metric value for interface
(config-if)#isis circuit-type level-1	Enable circuit type on interface

(config-if)#commit	Commit candidate configuration to the running configuration
(config-if)#exit	Exit interface mode.
(config)#router isis 1	Create an IS-IS routing instance for area 49 with instance 1
(config-router)# net 49.0001.0000.0000.0003.00	Establish a Network Entity Title for this instance, specifying the area address and the system ID.
(config-router)#bfd all-interfaces	Enable BFD for ISIS on all interfaces
(config-if)#commit	Commit candidate configuration to the running configuration
(config-router)#exit	Exit router mode.
(config)#exit	Exit config mode.

R4

#configure terminal	Enter configure mode.
(config)#int xe20	Enter interface mode.
(config-if)#ip address 30.1.1.2/24	Configure the IP address of the interface.
(config-if)#ip router isis 1	Enable ISIS routing on interface for area 49 with instance 1
(config-if)#isis metric 10	Configure isis metric value for interface
(config-if)#isis circuit-type level-1	Enable circuit type on interface
(config-if)#exit	Exit interface mode.
(config)#int xe8	Enter interface mode.
(config-if)#ip address 60.1.1.1/24	Configure the IP address of the interface.
(config-if)#ip router isis 1	Enable ISIS routing on interface for area 49 with instance 1
(config-if)#isis metric 10	Configure isis metric value for interface
(config-if)#isis circuit-type level-1	Enable circuit type on interface
(config-if)#commit	Commit candidate configuration to the running configuration
(config-if)#exit	Exit interface mode.
(config)#router isis 1	Create an IS-IS routing instance for area 49 with instance 1
(config-router)# net 49.0001.0000.0000.0004.00	Establish a Network Entity Title for this instance, specifying the area address and the system ID.
(config-router)#bfd all-interfaces	Enable BFD for ISIS on all interfaces
(config-if)#commit	Commit candidate configuration to the running configuration
(config-router)#exit	Exit router mode.
(config)#exit	Exit config mode.

R5

#configure terminal	Enter configure mode.
(config)#int xe2	Enter interface mode.
(config-if)#ip address 40.1.1.2/24	Configure the IP address of the interface.
(config-if)#ip router isis 1	Enable ISIS routing on interface for area 49 with instance 1
(config-if)#isis metric 10	Configure isis metric value for interface

(config-if)#isis circuit-type level-1	Enable circuit type on interface
(config-if)#commit	Commit candidate configuration to the running configuration
(config-if)#exit	Exit interface mode.
(config)#int xe10	Enter interface mode.
(config-if)#ip address 50.1.1.1/24	Configure the IP address of the interface.
(config-if)#ip router isis 1	Enable ISIS routing on interface for area 49 with instance 1
(config-if)#isis metric 10	Configure isis metric value for interface
(config-if)#isis circuit-type level-1	Enable circuit type on interface
(config-if)#commit	Commit candidate configuration to the running configuration
(config-if)#exit	Exit interface mode.
(config)#int xe8	Enter interface mode.
(config-if)#ip address 60.1.1.1/24	Configure the IP address of the interface.
(config-if)#ip router isis 1	Enable ISIS routing on interface for area 49 with instance 1
(config-if)#isis metric 10	Configure isis metric value for interface
(config-if)#isis circuit-type level-1	Enable circuit type on interface
(config-if)#commit	Commit candidate configuration to the running configuration
(config-if)#exit	Exit interface mode.
(config)#int xe0	Enter interface mode.
(config-if)#ip address 21.1.1.1/24	Configure the IP address of the interface.
(config-if)#ip router isis 1	Enable ISIS routing on interface for area 49 with instance 1
(config-if)#isis metric 10	Configure isis metric value for interface
(config-if)#isis circuit-type level-1	Enable circuit type on interface
(config-if)#commit	Commit candidate configuration to the running configuration
(config-if)#exit	Exit interface mode.
(config)#router isis 1	Create an IS-IS routing instance for area 49 with instance 1
(config-router)# net 49.0001.0000.0000.0005.00	Establish a Network Entity Title for this instance, specifying the area address and the system ID.
(config-router)#bfd all-interfaces	Enable BFD for ISIS on all interfaces
(config-if)#commit	Commit candidate configuration to the running configuration
(config-router)#exit	Exit router mode.
(config)#exit	Exit config mode.

Validation

R1 (Source):

The backup path will be selected by default from same Primary/ECMP set and "Pri" indicates backup selected from ECMP set.

```
R1#show clns neighbors
```

```
Total number of L1 adjacencies: 3
Total number of L2 adjacencies: 0
Total number of adjacencies: 3
```

```
Tag 1: VRF : default
System Id      Interface  SNPA          State  Holdtime  Type  Protocol
0000.0000.0003 xe12      e8c5.7a6b.732a Up     21       L1    IS-IS
0000.0000.0002 xe16      e8c5.7a7d.532e Up     21       L1    IS-IS
0000.0000.0004 xe20      e8c5.7a25.2752 Up     19       L1    IS-IS
```

```
R2#show clns neighbors
```

```
Total number of L1 adjacencies: 2
Total number of L2 adjacencies: 0
Total number of adjacencies: 2
```

```
Tag 1: VRF : default
System Id      Interface  SNPA          State  Holdtime  Type  Protocol
0000.0000.0005 xe2        e8c5.7a76.5820 Up     28       L1    IS-IS
0000.0000.0001 xe16      e8c5.7af5.ef2e Up     7        L1    IS-IS
```

```
R3#show clns neighbors
```

```
Total number of L1 adjacencies: 2
Total number of L2 adjacencies: 0
Total number of adjacencies: 2
```

```
Tag 1: VRF : default
System Id      Interface  SNPA          State  Holdtime  Type  Protocol
0000.0000.0005 xe10      e8c5.7a76.5828 Up     8        L1    IS-IS
0000.0000.0001 xe12      e8c5.7af5.ef2a Up     5        L1    IS-IS
```

```
R4#show clns neighbors
```

```
Total number of L1 adjacencies: 2
Total number of L2 adjacencies: 0
Total number of adjacencies: 2
```

```
Tag 1: VRF : default
System Id      Interface  SNPA          State  Holdtime  Type  Protocol
0000.0000.0005 xe8        e8c5.7a76.5826 Up     8        L1    IS-IS
0000.0000.0001 xe20      e8c5.7af5.ef32 Up     8        L1    IS-IS
```

```
R5#show clns neighbors
```

```
Total number of L1 adjacencies: 3
Total number of L2 adjacencies: 0
Total number of adjacencies: 3
```

```
Tag 1: VRF : default
System Id      Interface  SNPA          State  Holdtime  Type  Protocol
0000.0000.0002 xe2        e8c5.7a7d.5320 Up     8        L1    IS-IS
0000.0000.0004 xe8        e8c5.7a25.2746 Up     29       L1    IS-IS
0000.0000.0003 xe10      e8c5.7a6b.7328 Up     26       L1    IS-IS
```

```
R1#show ip isis route fast-reroute
```

```
Tag   : 1 VRF : default
Codes : L1 - IS-IS level-1, L2 - IS-IS level-2, ia - IS-IS inter area,
        D - discard, LP - Link Protecting, NP - Node Protecting,
        BP - Broadcast Interface Disjoint, Pri - Primary Path,
        Sec - Secondary Path, DP - Downstream Path
```

```
L1 21.1.1.0/24
   Primary Path via : 10.1.1.2, xe16
```

```

    FRR Backup Path via : 20.1.1.2, xe12
    FRR Metric           : 30
    Protection Provided : LP NP BP Pri DP >>> Here Pri indicates backup
selected from ECMP set

```

```

    Primary Path via    : 20.1.1.2, xe12
    FRR Backup Path via : 10.1.1.2, xe16
    FRR Metric          : 30
    Protection Provided : LP NP BP Pri DP

```

```

L1 40.1.1.0/24
    Primary Path via    : 10.1.1.2, xe16
    FRR Backup Path via : 20.1.1.2, xe12
    FRR Metric          : 30
    Protection Provided : LP NP BP

```

```

L1 50.1.1.0/24
    Primary Path via    : 20.1.1.2, xe12
    FRR Backup Path via : 10.1.1.2, xe16
    FRR Metric          : 30
    Protection Provided : LP NP BP

```

```

L1 60.1.1.0/24
    Primary Path via    : 30.1.1.2, xe20
    FRR Backup Path via : 20.1.1.2, xe12
    FRR Metric          : 30
    Protection Provided : LP NP BP DP

```

```
R1#show ip route fast-reroute
```

```

Codes: K - kernel, C - connected, S - static, R - RIP, B - BGP
       O - OSPF, IA - OSPF inter area
       N1 - OSPF NSSA external type 1, N2 - OSPF NSSA external type 2
       E1 - OSPF external type 1, E2 - OSPF external type 2
       i - IS-IS, L1 - IS-IS level-1, L2 - IS-IS level-2, ia - IS-IS inter
area ,p - stale info, E - EVPN
       * - candidate default

```

```
IP Route Table for VRF "default"
```

```

i L1   21.1.1.0/24 [115/30] via 20.1.1.2, xe12, 00:00:57
        [FRR-NH] via 10.1.1.2, xe16
        [115/30] via 10.1.1.2, xe16
        [FRR-NH] via 20.1.1.2, xe12
i L1   40.1.1.0/24 [115/20] via 10.1.1.2, xe16, 00:07:52
        [FRR-NH] via 20.1.1.2, xe12
i L1   50.1.1.0/24 [115/20] via 20.1.1.2, xe12, 00:07:12
        [FRR-NH] via 10.1.1.2, xe16
i L1   60.1.1.0/24 [115/25] via 30.1.1.2, xe20, 00:06:44
        [FRR-NH] via 20.1.1.2, xe12

```

```
R1#show ip isis lfa-config level-1
```

```
TIE-Breaker Preference values
```

```
-----
```

```

Primary Path           : 20
Link Protecting       : 60
Node Protecting       : 30
Broadcast Interface Disjoint : 70
Secondary Path        : 255
Downstream Path       : 90

Termination Hold On Interval : 1000 ms

```

Backup Path for ECMP Path from Non-ECMP Path

To select Backup path from secondary/Non-ECMP path, configure the below command in R1 with lowest index value. If no backup path available from non-ecmp set , then from primary set itself , backup path will be installed

(config)#router isis 1	Create an IS-IS routing instance for area 49 with instance 1
(config-router)#net 49.0000.0000.0001.00	Establish a Network Entity Title for this instance, specifying the area address and the system ID.
(config-router)#fast-reroute tie-break level-1 proto ipv4 secondary-path index 1	Configure secondary path tie-breaker to select backup path from Non-ECMP path
(config-router)#commit	Commit candidate configuration to the running configuration
(config-router)#exit	Exit router mode.
(config)#exit	Exit config mode.

Validation

```
R1#show ip isis lfa-config level-1
```

```
TIE-Breaker Preference values
```

```

-----
Primary Path           : 20
Link Protecting       : 60
Node Protecting       : 30
Broadcast Interface Disjoint : 70
Secondary Path        : 1
Downstream Path       : 90

```

```
Termination Hold On Interval : 1000 ms
```

R1#Below, "Sec" indicates the backup path is from the Non-ECMP path

```
R1#show ip isis route fast-reroute
```

```

Tag      : 1  VRF : default
Codes : L1 - IS-IS level-1, L2 - IS-IS level-2, ia - IS-IS inter area,
        D - discard, LP - Link Protecting, NP - Node Protecting,
        BP - Broadcast Interface Disjoint, Pri - Primary Path,
        Sec - Secondary Path, DP - Downstream Path

```

```

L1  21.1.1.0/24
    Primary Path via      : 10.1.1.2, xe16
    FRR Backup Path via   : 30.1.1.2, xe20
    FRR Metric            : 35

```

Protection Provided : LP NP BP Sec DP >>> **Sec indicates backup path is from Non-ecmp path**

Primary Path via : 20.1.1.2, xe12
 FRR Backup Path via : 30.1.1.2, xe20
 FRR Metric : 35
 Protection Provided : LP NP BP Sec DP

L1 40.1.1.0/24
 Primary Path via : 10.1.1.2, xe16
 FRR Backup Path via : 20.1.1.2, xe12
 FRR Metric : 30
 Protection Provided : LP NP BP

L1 50.1.1.0/24
 Primary Path via : 20.1.1.2, xe12
 FRR Backup Path via : 10.1.1.2, xe16
 FRR Metric : 30
 Protection Provided : LP NP BP

L1 60.1.1.0/24
 Primary Path via : 30.1.1.2, xe20
 FRR Backup Path via : 20.1.1.2, xe12
 FRR Metric : 30
 Protection Provided : LP NP BP DP

R1#show ip route fast-reroute

Codes: K - kernel, C - connected, S - static, R - RIP, B - BGP

O - OSPF, IA - OSPF inter area

N1 - OSPF NSSA external type 1, N2 - OSPF NSSA external type 2

E1 - OSPF external type 1, E2 - OSPF external type 2

i - IS-IS, L1 - IS-IS level-1, L2 - IS-IS level-2, ia - IS-IS inter area ,p - stale info, E - EVPN

* - candidate default

IP Route Table for VRF "default"

```
i L1    21.1.1.0/24 [115/30] via 20.1.1.2, xe12, 00:02:48
          [FRR-NH] via 30.1.1.2, xe20
          [115/30] via 10.1.1.2, xe16
          [FRR-NH] via 30.1.1.2, xe20

i L1    40.1.1.0/24 [115/20] via 10.1.1.2, xe16, 00:09:43
          [FRR-NH] via 20.1.1.2, xe12

i L1    50.1.1.0/24 [115/20] via 20.1.1.2, xe12, 00:09:03
          [FRR-NH] via 10.1.1.2, xe16

i L1    60.1.1.0/24 [115/25] via 30.1.1.2, xe20, 00:08:35
          [FRR-NH] via 20.1.1.2, xe12
```

CHAPTER 14 IS-IS IPv6 Configuration

This chapter contains basic IS-IS (Intermediate System to Intermediate System) on IPv6 configuration examples.

Enable IS-ISv6 on an Interface

This example shows the minimum configuration required for enabling IS-IS on IPv6 on an interface. R1 and R2 are two routers in the ABC instance connecting to the network 1000::/64. After enabling IS-IS on an interface, create a routing instance, and specify the Network Entity Title (NET). IS-IS explicitly specifies a NET to begin routing. NET is comprised of the area address and the system ID of the router.

Note: IS-ISv6 session will come up even if IPv6 address is not configured, as it will use the link local address present on the interfaces.

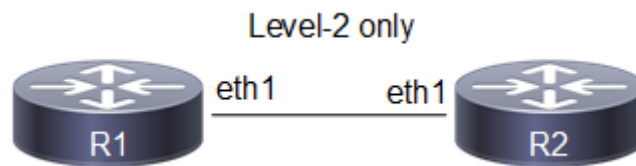

Figure 14-114: Figure 4-46: Basic IS-IS v6 Topology

Configuration

R1

#configure terminal	Enter configure mode.
(config)#interface eth1	Enter interface mode.
(config-if)#ipv6 router isis ABC	Enable IS-ISv6 routing on an interface for area 49(ABC).
(config-if)#ipv6 address 1000::1/64	Configure IPv6 address on interface.
(config-if)#exit	Exit interface mode.
(config)#router isis ABC	Create an IS-IS routing instance for area 49 (ABC).
(config-router)#is-type level-2-only	Configure instance as level-2-only routing.
(config-router)#net 49.0005.0000.0000.0001.00	Set a Network Entity Title for this instance, specifying the area address and the system ID.
(config-router)#commit	Commit candidate configuration to the running configuration

R2

#configure terminal	Enter configure mode.
(config)#interface eth1	Enter interface mode.
(config-if)#ipv6 router isis ABC	Enable IS-ISv6 routing on an interface for area 49(ABC).
(config-if)#ipv6 address 1000::2/64	Configure IPv6 address on interface.

(config-if)#commit	Commit candidate configuration to the running configuration
(config-if)#exit	Exit interface mode.
(config)#router isis ABC	Create an IS-IS routing instance for area 49 (ABC).
(config-router)#is-type level-2-only	Configure instance as level-2-only routing.
(config-router)#net 49.0005.0000.0000.0002.00	Set a Network Entity Title for this instance, specifying the area address and the system ID.
(config-router)#commit	Commit candidate configuration to the running configuration

Validation

```
R1#show clns neighbors
```

```
Total number of L1 adjacencies: 0
Total number of L2 adjacencies: 1
Total number of adjacencies: 1
Tag ABC: VRF : default
System Id      Interface  SNPA          State  Holdtime  Type Protocol
0000.0000.0002 eth1      b86a.97c4.31c5 Up     27        L2   IS-IS
```

```
R2#show clns neighbors
```

```
Total number of L1 adjacencies: 0
Total number of L2 adjacencies: 1
Total number of adjacencies: 1
Tag ABC: VRF : default
System Id      Interface  SNPA          State  Holdtime  Type Protocol
0000.0000.0001 eth1      b86a.97cb.3ec5 Up     7         L2   IS-IS
R2#
```

```
R1#show ipv6 isis route
```

```
Codes: C - connected, E - external, L1 - IS-IS level-1, L2 - IS-IS level-2
       ia - IS-IS inter area, D - discard, e - external metric
```

```
Tag ABC: VRF : default
C   1000::/64 [10]
    via ::, eth1
```

```
R1#
```

```
R2#show ipv6 isis route
```

```
Codes: C - connected, E - external, L1 - IS-IS level-1, L2 - IS-IS level-2
       ia - IS-IS inter area, D - discard, e - external metric
```

```
Tag ABC: VRF : default
C   1000::/64 [10]
    via ::, eth1
```



```
R2#
```

```
R1#
```

```
R1#show ipv6 isis topology
```

```
Tag ABC: VRF : default
```

```
IS-IS paths to level-2 routers
```

System Id	Metric	Next-Hop	Interface	SNPA
0000.0000.0001	--			
0000.0000.0002	10	0000.0000.0002	eth1	b86a.97c4.31c5

```
R1#
```

```
R2#show ipv6 isis topology
```

```
Tag ABC: VRF : default
```

```
IS-IS paths to level-2 routers
```

System Id	Metric	Next-Hop	Interface	SNPA
0000.0000.0001	10	0000.0000.0001	eth1	b86a.97cb.3ec5
0000.0000.0002	--			

Set Priority

This example describes how to set the priority for an interface. Set a high priority for a router to make it the Designated IS (DIS). Router R3 is configured to have a priority of 70, this is higher than the default priority (64) of R1 and R2. This makes R3 the DIS.

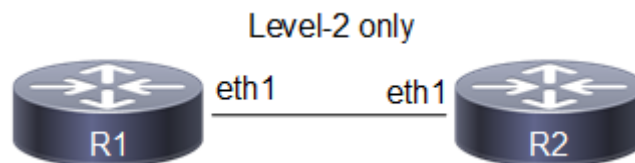

Figure 14-115: Set IS-IS Priority

Configuration

R1

#configure terminal	Enter configure mode.
(config)#interface eth1	Enter interface mode.
(config-if)#ipv6 router isis ABC	Enable IS-ISv6 routing on an interface for area 49(ABC).
(config-if)#ipv6 address 1000::1/64	Configure IPv6 address on interface.
(config-if)#commit	Commit candidate configuration to the running configuration
(config-if)#exit	Exit interface mode.
(config)#router isis ABC	Create an IS-IS routing instance for area 49 (ABC).
(config-router)#is-type level-2-only	Configure instance as level-2-only routing.

(config-router)#net 49.0005.0000.0000.0001.00	Set a Network Entity Title for this instance, specifying the area address and the system ID.
(config-router)#commit	Commit candidate configuration to the running configuration

R2

#configure terminal	Enter configure mode.
(config)#interface eth1	Enter interface mode.
(config-if)#ipv6 router isis ABC	Enable IS-ISv6 routing on an interface for area 49(ABC).
(config-if)#ipv6 address 1000::2/64	Configure IPv6 address on interface.
(config-if)#isis priority 125	Specify the router priority to a higher priority (125) to make R2 the designated IS (DIS).
(config-if)#commit	Commit candidate configuration to the running configuration
(config-if)#exit	Exit interface mode.
(config)#router isis ABC	Create an IS-IS routing instance for area 49 (ABC).
(config-router)#is-type level-2-only	Configure instance as level-2-only routing.
(config-router)#net 49.0005.0000.0000.0002.00	Set a Network Entity Title for this instance, specifying the area address and the system ID.
(config-router)#commit	Commit candidate configuration to the running configuration

Validation

R1#show clns neighbors

```
Total number of L1 adjacencies: 0
Total number of L2 adjacencies: 1
Total number of adjacencies: 1
Tag ABC: VRF : default
System Id      Interface  SNPA          State  Holdtime  Type Protocol
0000.0000.0002 eth1      b86a.97c4.31c5 Up      8          L2  IS-IS
R1#
```

R2#show clns neighbors

```
Total number of L1 adjacencies: 0
Total number of L2 adjacencies: 1
Total number of adjacencies: 1
Tag ABC: VRF : default
System Id      Interface  SNPA          State  Holdtime  Type Protocol
0000.0000.0001 eth1      b86a.97cb.3ec5 Up      26         L2  IS-IS
R2#
```

R1#show clns is-neighbors

```
Tag ABC: VRF : default
System Id      Interface  State  Type Priority  Circuit Id
0000.0000.0002 eth1      Up     L2   125      0000.0000.0002.01
```

R1#

R2#show clns is-neighbors

Tag ABC: VRF : default

System Id	Interface	State	Type	Priority	Circuit Id
0000.0000.0001	eth1	Up	L2	64	0000.0000.0002.01

R2#

R1#show isis interface

eth1 is up, line protocol is up

Routing Protocol: IS-IS (ABC)

Network Type: Broadcast

Circuit Type: level-1-2

Local circuit ID: 0x01

Extended Local circuit ID: 0x00002722

Local SNPA: b86a.97cb.3ec5

IP interface address:

IPv6 interface address:

1000::1/64

fe80::ba6a:97ff:feeb:3ec5/64

Level-2 Metric: 10/10, Priority: 64, Circuit ID: 0000.0000.0002.01

Number of active level-2 adjacencies: 1

Level-2 LSP MTU: 1492

Next IS-IS LAN Level-2 Hello in 0 milliseconds

R1#

R2#show isis interface

eth1 is up, line protocol is up

Routing Protocol: IS-IS (ABC)

Network Type: Broadcast

Circuit Type: level-1-2

Local circuit ID: 0x01

Extended Local circuit ID: 0x00002722

Local SNPA: b86a.97c4.31c5

IP interface address:

IPv6 interface address:

1000::2/64

fe80::ba6a:97ff:fec4:31c5/64

Level-2 Metric: 10/10, Priority: 125, Circuit ID: 0000.0000.0002.01

Number of active level-2 adjacencies: 1

Level-2 LSP MTU: 1492

Next IS-IS LAN Level-2 Hello in 1 seconds

R2#

Dynamic hostname

This example shows how to configure Dynamic Hostname for an ISIS IPv6 instance. Dynamic hostname is the method of mapping name-to-systemID. It allows the routing protocol to advertise symbolic names in the IS-IS PDUs. This is done by the addition of a new TLV which allows the IS-IS routers to include the name-to-systemID mapping data in their LSPs. This allows for simple and reliable transport of name mapping across IS-IS networks.

Dynamic hostname can be either the hostname of the node or the tag of the configured ISISv6 instance.

Note: Dynamic-hostname has to be configured on all nodes for it to take effect.

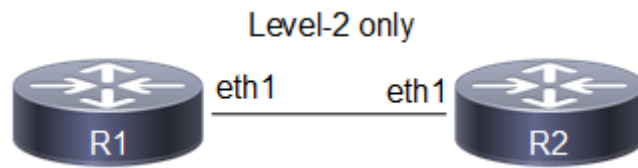

Figure 14-116: Basic dynamic hostname topology

Configuration

R1

#configure terminal	Enter configure mode.
(config)#interface eth1	Enter interface mode.
(config-if)#ipv6 router isis ABC	Enable IS-ISv6 routing on an interface for area 49(ABC).
(config-if)#ipv6 address 1000::1/64	Configure IPv6 address on interface.
(config-if)#commit	Commit candidate configuration to the running configuration
(config-if)#exit	Exit interface mode.
(config)#router isis ABC	Create an IS-IS routing instance for area 49 (ABC).
(config-router)#is-type level-2-only	Configure instance as level-2-only routing.
(config-router)#net 49.0005.0000.0000.0001.00	Set a Network Entity Title for this instance, specifying the area address and the system ID.
(config-router)#dynamic-hostname	Configure the hostname to be advertised for an ISIS instance.
(config-router)#commit	Commit candidate configuration to the running configuration
(config-router)#end	Exit the current mode and enter privilege mode.

R2

#configure terminal	Enter configure mode.
(config)#interface eth1	Enter interface mode.
(config-if)#ipv6 router isis ABC	Enable IS-ISv6 routing on an interface for area 49(ABC).
(config-if)#ipv6 address 1000::2/64	Configure IPv6 address on interface.
(config-if)#commit	Commit candidate configuration to the running configuration
(config-if)#exit	Exit interface mode.

(config)#router isis ABC	Create an IS-IS routing instance for area 49 (ABC).
(config-router)#is-type level-2-only	Configure instance as level-2-only routing.
(config-router)#net 49.0005.0000.0000.0002.00	Set a Network Entity Title for this instance, specifying the area address and the system ID.
(config-router)#dynamic-hostname	Configure the hostname to be advertised for an ISIS instance.
(config-router)#commit	Commit candidate configuration to the running configuration
(config-router)#end	Exit the current mode and enter privilege mode.

Validation

R1#show clns neighbors

```
Total number of L1 adjacencies: 0
Total number of L2 adjacencies: 1
Total number of adjacencies: 1
Tag ABC: VRF : default
System Id      Interface  SNPA          State  Holdtime  Type Protocol
R2             eth1      b86a.97c4.31c5 Up     20        L2  IS-IS
R1#
```

R2#show clns neighbors

```
Total number of L1 adjacencies: 0
Total number of L2 adjacencies: 1
Total number of adjacencies: 1
Tag ABC: VRF : default
System Id      Interface  SNPA          State  Holdtime  Type Protocol
R1             eth1      b86a.97cb.3ec5 Up     8         L2  IS-IS
R2#
```

R1#show isis database

```
Tag ABC: VRF : default
IS-IS Level-2 Link State Database:
LSPID          LSP Seq Num  LSP Checksum  LSP Holdtime  ATT/P/OL
R1.00-00      * 0x00000008  0xFB86        1144           0/0/0
R1.01-00      * 0x00000005  0x19BD        1141           0/0/0
R2.00-00      0x00000007  0x245C        1140           0/0/0
```

R1#

R2#show isis database

```
Tag ABC: VRF : default
IS-IS Level-2 Link State Database:
LSPID          LSP Seq Num  LSP Checksum  LSP Holdtime  ATT/P/OL
R1.00-00      0x00000008  0xFB86        1144           0/0/0
R1.01-00      0x00000005  0x19BD        1140           0/0/0
R2.00-00      * 0x00000007  0x245C        1140           0/0/0
```

```
R2.01-00          * 0x00000002  0xE710          0 (1132)          0/0/0
```

R2#

```
R1#show ipv6 isis topology
```

```
Tag ABC:  VRF : default
IS-IS paths to level-2 routers
System Id      Metric      Next-Hop      Interface      SNPA
R1             --
R2             10           R2            eth1           b86a.97c4.31c5
```

R1#

```
R2#show ipv6 isis topology
```

```
Tag ABC:  VRF : default
IS-IS paths to level-2 routers
System Id      Metric      Next-Hop      Interface      SNPA
R1             10          R1            eth1           b86a.97cb.3ec5
R2             --
```

R2#

Redistribute Routes into IS-IS

In this example, the configuration causes OSPFv3 routes to be imported into the IS-ISv6 routing table, and advertised into the ABC instance.

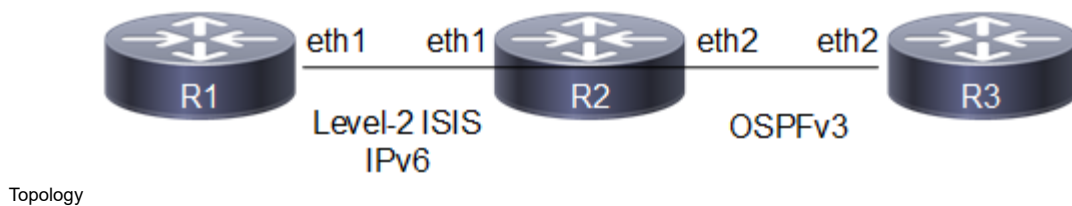

Figure 14-117: Redistribute Routes into IS-IS

Configuration

R1

#configure terminal	Enter configure mode.
(config)#interface eth1	Enter interface mode.
(config-if)#ipv6 router isis ABC	Enable IS-ISv6 routing on an interface for area 49(ABC).
(config-if)#ipv6 address 1000::1/64	Configure IPv6 address on interface.

(config-if)#commit	Commit candidate configuration to the running configuration
(config-if)#exit	Exit interface mode.
(config)#router isis ABC	Create an IS-IS routing instance for area 49 (ABC).
(config-router)#is-type level-2-only	Configure instance as level-2-only routing.
(config-router)#net 49.0005.0000.0000.0001.00	Set a Network Entity Title for this instance, specifying the area address and the system ID.
(config-router)#commit	Commit candidate configuration to the running configuration

R2

#configure terminal	Enter configure mode.
(config)#interface eth1	Enter interface mode.
(config-if)#ipv6 router isis ABC	Enable IS-ISv6 routing on an interface for area 49(ABC).
(config-if)#ipv6 address 1000::2/64	Configure IPv6 address on interface.
(config-if)#commit	Commit candidate configuration to the running configuration
(config-if)#exit	Exit interface mode.
(config)#interface eth2	Enter interface mode.
(config-if)#ipv6 router ospf area 0	Enable OSPFv3 routing on an interface and assign the Area ID 0.
(config-if)#ipv6 address 2000::1/64	Configure IPv6 address on interface.
(config-if)#commit	Commit candidate configuration to the running configuration
(config-if)#exit	Exit interface mode.
(config)#router isis ABC	Create an IS-IS routing instance for area 49 (ABC).
(config-router)#is-type level-2-only	Configure instance as level-2-only routing.
(config-router)#net 49.0005.0000.0000.0002.00	Set a Network Entity Title for this instance, specifying the area address and the system ID.
(config-router)#address-family ipv6	Enter 'address-family ipv6' mode, where users can configure IPv6 routing specific configuration
(config-router-af)#redistribute ospf	Enable redistribution of routes from ospf into the ISIS routing table.
(config-router-af)# exit-address-family	Exit address family mode.
(config-router)#commit	Commit candidate configuration to the running configuration
(config-router)#exit	Exit router mode.
(config)#router ipv6 ospf	Create an OSPFv3 routing instance.
(config-router)#router-id 2.2.2.2	Specify a Router ID (2.2.2.2) for the OSPFv3 routing process .
(config-router)#end	Exit the current mode and enter privilege mode.

R3

#configure terminal	Enter configure mode.
(config)#interface eth2	Enter interface mode.
(config-if)#ipv6 router ospf area 0	Enable OSPFv3 routing on an interface and assign the Area ID 0.
(config-if)#ipv6 address 2000::2/64	Configure IPv6 address on interface.
(config-if)#commit	Commit candidate configuration to the running configuration
(config-if)#exit	Exit interface mode.
(config)#router ipv6 ospf	Create an OSPFv3 routing instance.
(config-router)#router-id 3.3.3.3	Specify a Router ID (3.3.3.3) for the OSPFv3 routing process.
(config-router)#commit	Commit candidate configuration to the running configuration
(config-router)#end	Exit the current mode and enter privilege mode.

Validation

R1#show clns neighbors

```
Total number of L1 adjacencies: 0
Total number of L2 adjacencies: 1
Total number of adjacencies: 1
Tag ABC: VRF : default
System Id      Interface  SNPA                State  Holdtime  Type Protocol
0000.0000.0002 eth1       b86a.97c4.31c5      Up     27        L2   IS-IS
R1#
```

R2#show clns neighbors

```
Total number of L1 adjacencies: 0
Total number of L2 adjacencies: 1
Total number of adjacencies: 1
Tag ABC: VRF : default
System Id      Interface  SNPA                State  Holdtime  Type Protocol
0000.0000.0001 eth1       b86a.97cb.3ec5      Up     8         L2   IS-IS
R2#
```

R2#show ipv6 ospf neighbor

```
Total number of full neighbors: 1
OSPFv3 Process (*null*)
Neighbor ID    Pri  State           Dead Time  Interface  Instance ID
3.3.3.3       1    Full/DR        00:00:34  eth2       0
R2#
```

R1#show ipv6 route isis

```
IP Route Table for VRF "default"
i L2  2000::/64 [115/10] via fe80::ba6a:97ff:fec4:31c5, eth1, 00:21:19
R1#
```



```
R1#show ipv6 route
IPv6 Routing Table
Codes: K - kernel route, C - connected, S - static, R - RIP, O - OSPF,
      IA - OSPF inter area, E1 - OSPF external type 1,
      E2 - OSPF external type 2, E - EVPN  N1 - OSPF NSSA external type 1,
      N2 - OSPF NSSA external type 2, i - IS-IS, B - BGP
Timers: Uptime

IP Route Table for VRF "default"
C      ::1/128 via ::, lo, 01:33:07
C      1000::/64 via ::, eth1, 01:13:36
i L2   2000::/64 [115/10] via fe80::ba6a:97ff:fec4:31c5, eth1, 00:21:29
C      fe80::/64 via ::, xe8, 00:39:44
R1#
```

Interface Metric

You can make a route the preferred route by changing its metric. In this example, the cost has been configured to make R3 the next hop for R1.

The default metric for each interface is 10. Interface eth2 on R2 has a metric of 20, and Interface eth2 on R3 has a metric of 30. The total cost to reach 9999::/64 (R4) through R2 and R3 is computed as follows: R2: 10+20 = 30 R3: 10+30 = 40

In this topology, R1 chooses R2 as its next hop for destination 9999::/64.

Note: Below configuration is applicable for narrow (non-wide) metric-style. Wide metric can be configured by using the CLI's "metric-style wide" under isis instance and "isis wide-metric < 1-16777214>" under interface mode.

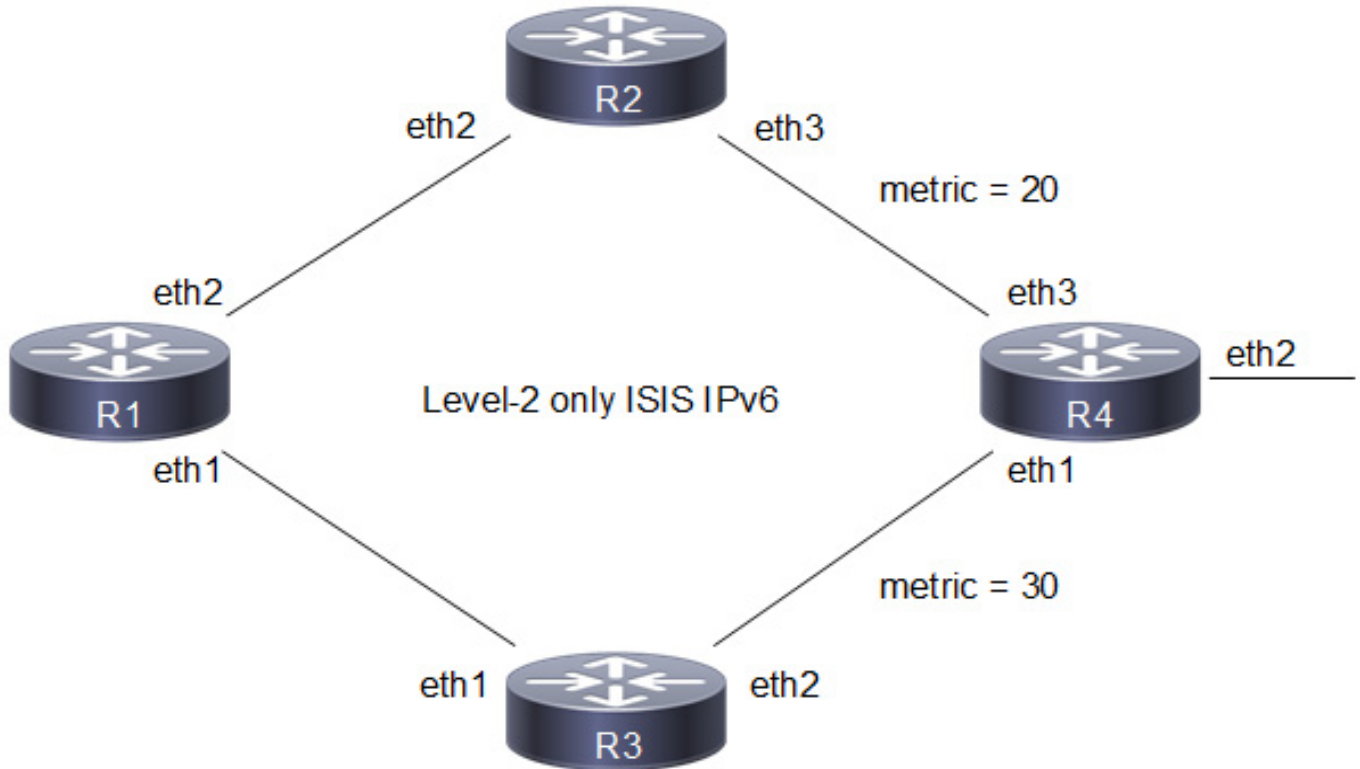

gy
Figure 14-118: Configure IS-IS Metric

Configuration

R1

#configure terminal	Enter configure mode.
(config)#interface eth1	Enter interface mode.
(config-if)#ipv6 router isis ABC	Enable IS-IS routing on an interface for area 49(ABC).
(config-if)#commit	Commit candidate configuration to the running configuration
(config-if)#exit	Exit interface mode.
(config)#interface eth2	Enter interface mode.
(config-if)#ipv6 router isis ABC	Enable IS-IS routing on an interface for area 49(ABC).
(config-if)#commit	Commit candidate configuration to the running configuration
(config-if)#exit	Exit interface mode.
(config)#router isis ABC	Create an IS-IS routing instance for area 49 (ABC).
(config-router)#is-type level-2-only	Configure instance as level-2-only routing.
(config-router)#net 49.0100.0000.0000.0001.00	Set a Network Entity Title for this instance, specifying the area address and the system ID.
(config-router)#commit	Commit candidate configuration to the running configuration
(config-router)#end	Exit current mode and enter privilege mode.

R2

(config)#interface eth2	Enter interface mode.
(config-if)#ipv6 router isis ABC	Enable IS-IS routing on an interface for area 49 (ABC).
(config-if)#commit	Commit candidate configuration to the running configuration
(config-if)#exit	Exit interface mode.
(config)#interface eth3	Enter interface mode.
(config-if)#ipv6 router isis ABC	Enable IS-IS routing on an interface for area 49 (ABC).
(config-if)#isis metric 20	Set the value of IS-IS metric (on eth2) to 20.
(config-if)#commit	Commit candidate configuration to the running configuration
(config-if)#exit	Exit interface mode.
(config)#router isis ABC	Create an IS-IS routing instance for area 49 (ABC).
(config-router)#is-type level-2-only	Configure instance as level-2-only routing.
(config-router)#net 49.0100.0000.0000.0002.00	Set a Network Entity Title for this instance, specifying the area address and the system ID.
(config-router)#commit	Commit candidate configuration to the running configuration

R3

(config)#interface eth1	Enter interface mode.
(config-if)#ipv6 router isis ABC	Enable IS-IS routing on an interface for area 49 (ABC).
(config-if)#commit	Commit candidate configuration to the running configuration
(config-if)#exit	Exit interface mode.
(config)#interface eth2	Enter interface mode.
(config-if)#ipv6 router isis ABC	Enable IS-IS routing on an interface for area 49 (ABC).
(config-if)#isis metric 30	Set the value of IS-IS metric (on eth2) to 30.
(config-if)#commit	Commit candidate configuration to the running configuration
(config-if)#exit	Exit interface mode.
(config)#router isis ABC	Create an IS-IS routing instance for area 49 (ABC).
(config-router)#is-type level-2-only	Configure instance as level-2-only routing.
(config-router)#net 49.0100.0000.0000.0003.00	Set a Network Entity Title for this instance, specifying the area address and the system ID.
(config-router)#commit	Commit candidate configuration to the running configuration

R4

(config)#interface eth1	Enter interface mode.
(config-if)#ipv6 router isis ABC	Enable IS-IS routing on an interface for area 49 (ABC).
(config-if)#commit	Commit candidate configuration to the running configuration
(config-if)#exit	Exit interface mode.
(config)#interface eth2	Enter interface mode.
(config-if)#ipv6 address 9999::1/64	Configure ipv6 address in eth2
(config-if)#commit	Commit candidate configuration to the running configuration

(config-if)#exit	Exit interface mode.
(config)#interface eth3	Enter interface mode.
(config-if)#ipv6 router isis ABC	Enable IS-IS routing on an interface for area 49 (ABC).
(config-if)#ipv6 address 2000::2/64	Configure IPv6 address on interface.
(config-if)#commit	Commit candidate configuration to the running configuration
(config-if)#exit	Exit interface mode.
(config)#router isis ABC	Create an IS-IS routing instance for area 49 (ABC).
(config-router)#is-type level-2-only	Configure instance as level-2-only routing.
(config-router)#net 49.0100.0000.0000.0004.00	Set a Network Entity Title for this instance, specifying the area address and the system ID.
(config-router)#address-family ipv6	Enter ipv6 address family.
(config-router-af)#redistribute connected	Enable redistribution of connected routes into ISIS process
(config-router-af)#commit	Commit candidate configuration to the running configuration
(config-router-af)#end	Exit current mode and enter privilege mode

Validation

R1#show clns neighbors

Total number of L1 adjacencies: 0

Total number of L2 adjacencies: 2

Total number of adjacencies: 2

Tag ABC: VRF : default

System Id	Interface	SNPA	State	Holdtime	Type	Protocol
0000.0000.0002	eth2	b86a.97c4.31c5	Up	25	L2	IS-IS
0000.0000.0003	eth1	b86a.97c9.3cc5	Up	26	L2	IS-IS

R1#

R2#show clns neighbors

Total number of L1 adjacencies: 0

Total number of L2 adjacencies: 2

Total number of adjacencies: 2

Tag ABC: VRF : default

System Id	Interface	SNPA	State	Holdtime	Type	Protocol
0000.0000.0004	eth3	b86a.97c7.32c5	Up	7	L2	IS-IS
0000.0000.0001	eth2	b86a.97cb.3ec5	Up	6	L2	IS-IS

R2#

R3#show clns neighbors

Total number of L1 adjacencies: 0

Total number of L2 adjacencies: 2

Total number of adjacencies: 2

Tag ABC: VRF : default

System Id	Interface	SNPA	State	Holdtime	Type	Protocol
-----------	-----------	------	-------	----------	------	----------

```

0000.0000.0004 eth2      b86a.97c7.32c5      Up    22      L2    IS-IS
0000.0000.0001 eth1      b86a.97cb.3ec5      Up    7        L2    IS-IS
R3#

```

```
R4#show clns neighbors
```

```

Total number of L1 adjacencies: 0
Total number of L2 adjacencies: 2
Total number of adjacencies: 2
Tag ABC: VRF : default
System Id      Interface  SNPA              State  Holdtime  Type  Protocol
0000.0000.0002 eth3      b86a.97c4.31c5    Up    22        L2    IS-IS
0000.0000.0003 eth1      b86a.97c9.3cc5    Up    7         L2    IS-IS
R4#

```

```
R1#show ipv6 isis route
```

```

Codes: C - connected, E - external, L1 - IS-IS level-1, L2 - IS-IS level-2
       ia - IS-IS inter area, D - discard, e - external metric

```

```

Tag ABC: VRF : default
C    1000::/64 [10]
     via ::, ce0
L2   2000::/64 [30]
     via fe80::ce37:abff:fe87:3a74, ce0
C    3000::/64 [10]
     via ::, xe14
L2   4000::/64 [40]
     via fe80::ba6a:97ff:fe87:3ad4, xe14
     via fe80::ce37:abff:fe87:3a74, ce0
L2   9999::/64 [30]
     via fe80::ce37:abff:fe87:3a74, ce0
R1#

```

Route Summarization

Route summarization makes the routing table smaller, but still allows complete IP connectivity.

The following example consists of a three-router topology, in which R2 is doing the summarization. In this example, R1 is the L1 router, R2 is the L1/L2 router doing the summarization, and R3 is the L2 router. The following configuration is given only for R2, assuming that the adjacencies with R1 and R3 are already up, and the route tables with the appropriate routes are already populated.

Topology



Figure 14-119: Route Summarization Topology

Configuration

R1

#configure terminal	Enter configure mode.
(config)#interface eth1	Enter interface mode.
(config-if)#ipv6 router isis ABC	Enable IS-ISv6 routing on an interface for area 49(ABC).
(config-if)#ipv6 address 1000::1/64	Configure IPv6 address on interface.
(config-if)#isis circuit-type level-1	Set the circuit type as level-1 for the interface.
(config-if)#exit	Exit interface mode.
(config)#router isis ABC	Create an IS-IS routing instance for area 49 (ABC).
(config-router)# is-type level-1	Configure instance as level-1 routing.
(config-if)#commit	Commit candidate configuration to the running configuration
(config-router)#net 49.0001.0000.0000.0001.00	Set a Network Entity Title for this instance, specifying the area address and the system ID.
(config-router)#commit	Commit candidate configuration to the running configuration

R2

#configure terminal	Enter configure mode.
(config)#interface eth1	Enter interface mode.
(config-if)#ipv6 router isis ABC	Enable IS-ISv6 routing on an interface for area 49(ABC).
(config-if)#ipv6 address 1000::2/64	Configure IPv6 address on interface.
(config-if)#isis circuit-type level-1	Set the circuit type as level-1 for the interface.
(config-if)#commit	Commit candidate configuration to the running configuration
(config-if)#exit	Exit interface mode.
(config)#interface eth2	Enter interface mode.
(config-if)#ipv6 router isis ABC	Enable IS-ISv6 routing on an interface for area 49(ABC).
(config-if)#ipv6 address 2000::1/64	Configure IPv6 address on interface.
(config-if)#isis circuit-type level-2-only	Set the circuit type as level-2-only for the interface.
(config-if)#commit	Commit candidate configuration to the running configuration
(config-if)#exit	Exit interface mode.
(config)#router isis ABC	Create an IS-IS routing instance for area 49 (ABC).
(config-router)#net 49.0001.0000.0000.0002.00	Set a Network Entity Title for this instance, specifying the area address and the system ID.

(config-router)#address-family ipv6	Enter 'address-family ipv6' mode, where users can configure IPv6 routing specific configuration.
(config-router-af)#redistribute isis level-2 into level-1	Enable redistribution of isis routes from level-2 into level-1
(config-router-af)#summary-prefix 11:1:1:1::/64 level-1 metric 58	Configure the summary prefix to summarize IPv6 reachability information.
(config-if)#commit	Commit candidate configuration to the running configuration
(config-router-af)#exit-address-family	Exit address family mode.
(config-router)#exit	Exit router mode.

R3

#configure terminal	Enter configure mode.
(config)#ipv6 route 11:1:1:1:1:1::/96 eth2	Configure ipv6 static route.
(config)#ipv6 route 11:1:1:1:2:1::/96 eth2	Configure ipv6 static route.
(config)#ipv6 route 11:1:1:1:3:1::/96 eth2	Configure ipv6 static route.
(config)#interface eth2	Enter interface mode.
(config-if)#ipv6 router isis ABC	Enable IS-ISv6 routing on an interface for area 49(ABC).
(config-if)#ipv6 address 2000::2/64	Configure IPv6 address on interface.
(config-if)#isis circuit-type level-2-only	Set the circuit type as level-2-only for the interface.
(config-if)#commit	Commit candidate configuration to the running configuration
(config-if)#exit	Exit interface mode.
(config)#router isis ABC	Create an IS-IS routing instance for area 49 (ABC).
(config-router)#net 49.0001.0000.0000.0003.00	Set a Network Entity Title for this instance, specifying the area address and the system ID.
(config-router)# is-type level-2-only	Configure instance as level-2 -onlyrouting.
(config-router)#address-family ipv6	Enter 'address-family ipv6' mode, where users can configure IPv6 routing specific configuration.
(config-router-af)#redistribute static	Enable redistribution of static routes into ISIS instance.
(config-router-af)#commit	Commit candidate configuration to the running configuration
(config-router-af)#end	Exit the current mode and enter privilege mode.

Validation

R1#show clns neighbors

Total number of L1 adjacencies: 1

Total number of L2 adjacencies: 0

Total number of adjacencies: 1

Tag ABC: VRF : default

System Id	Interface	SNPA	State	Holdtime	Type	Protocol
0000.0000.0002	eth1	b86a.97c4.31c5	Up	21	L1	IS-IS

R2#show clns neighbors

Total number of L1 adjacencies: 1

IS-IS IPv6 Configuration

Total number of L2 adjacencies: 1

Total number of adjacencies: 2

Tag ABC: VRF : default

System Id	Interface	SNPA	State	Holdtime	Type	Protocol
0000.0000.0003	eth2	b86a.97c7.32c5	Up	8	L2	IS-IS
0000.0000.0001	eth1	b86a.97cb.3ec5	Up	8	L1	IS-IS

R3#show clns neighbors

Total number of L1 adjacencies: 0

Total number of L2 adjacencies: 1

Total number of adjacencies: 1

Tag ABC: VRF : default

System Id	Interface	SNPA	State	Holdtime	Type	Protocol
0000.0000.0002	eth2	b86a.97c4.31c5	Up	20	L2	IS-IS

R1#show ipv6 route isis

IP Route Table for VRF "default"

```
i ia 11:1:1:1::/64 [115/68] via fe80::eac5:7aff:fe6b:732e, eth1, 00:00:25
i ia 2000::/64 [115/20] via fe80::eac5:7aff:fe6b:732e, eth1, 00:01:15
```

R1#

R2#show ipv6 route isis

IP Route Table for VRF "default"

```
i 11:1:1:1::/64 [115/0] via ::, Null, 00:01:56
i L2 11:1:1:1:1:1::/96 [115/10] via fe80::eac5:7aff:fe7d:5332, eth2, 00:01:56
i L2 11:1:1:1:2:1::/96 [115/10] via fe80::eac5:7aff:fe7d:5332, eth2, 00:01:56
i L2 11:1:1:1:3:1::/96 [115/10] via fe80::eac5:7aff:fe7d:5332, eth2, 00:01:56
```

R2#

R3#show ipv6 route isis

IP Route Table for VRF "default"

```
i L2 1000::/64 [115/20] via fe80::eac5:7aff:fe6b:7332, eth2, 00:02:08
```

R1#show ipv6 isis route

Codes: C - connected, E - external, L1 - IS-IS level-1, L2 - IS-IS level-2

ia - IS-IS inter area, D - discard, e - external metric

Tag ABC: VRF : default

```
ia 11:1:1:1::/64 [68]
   via fe80::eac5:7aff:fe6b:732e, eth1
```

```
C 1000::/64 [10]
```

```
   via ::, xe16
```

```
ia 2000::/64 [20]
```

```
   via fe80::eac5:7aff:fe6b:732e, eth1
```

R2#show ipv6 isis route

Codes: C - connected, E - external, L1 - IS-IS level-1, L2 - IS-IS level-2

ia - IS-IS inter area, D - discard, e - external metric

```

Tag ABC: VRF : default
D    11:1:1:1::/64 [0]
     via ::
L2   11:1:1:1:1:1::/96 [10]
     via fe80::eac5:7aff:fe7d:5332, eth2
L2   11:1:1:1:2:1::/96 [10]
     via fe80::eac5:7aff:fe7d:5332, eth2
L2   11:1:1:1:3:1::/96 [10]
     via fe80::eac5:7aff:fe7d:5332, eth2
C    1000::/64 [10]
     via ::, xe16
C    2000::/64 [10]
     via ::, xe20

```

```
R3#show ipv6 isis route
```

```

Codes: C - connected, E - external, L1 - IS-IS level-1, L2 - IS-IS level-2
       ia - IS-IS inter area, D - discard, e - external metric

```

```

Tag ABC: VRF : default
E    11:1:1:1:1:1::/96 [0]
     via ::
E    11:1:1:1:2:1::/96 [0]
     via ::
E    11:1:1:1:3:1::/96 [0]
     via ::
L2   1000::/64 [20]
     via fe80::eac5:7aff:fe6b:7332, eth2
C    2000::/64 [10]
     via ::, eth2

```

```
R1# show isis database verbose
```

```

Tag ABC: VRF : default
IS-IS Level-1 Link State Database:
LSPID          LSP Seq Num  LSP Checksum  LSP Holdtime  ATT/P/OL
0000.0000.0001.00-00* 0x00000002   0x4755        686           0/0/0
  Area Address: 49.0001
  NLPID:        0x8E
  IPv6 Address: 1000::1
  Metric:      10          IS 0000.0000.0002.01
  Metric:      10          IPv6 1000::/64
0000.0000.0002.00-00 0x00000004   0x4A36        713           0/0/0
  Area Address: 49.0001
  NLPID:        0x8E
  IPv6 Address: 1000::2
  Metric:      10          IS 0000.0000.0002.01
  Metric:      10          IPv6 1000::/64
  Metric:      10          IPv6-Interarea 2000::/64
  Metric:      58          IPv6-Interarea 11:1:1:1::/64

```

IS-IS IPv6 Configuration

```
0000.0000.0002.01-00 0x00000001 0x0ECB 685 0/0/0
Metric: 0 IS 0000.0000.0002.00
Metric: 0 IS 0000.0000.0001.00
```

R2#show isis database verbose

Tag ABC: VRF : default

IS-IS Level-1 Link State Database:

LSPID	LSP Seq Num	LSP Checksum	LSP Holdtime	ATT/P/OL
0000.0000.0001.00-00	0x00000002	0x4755	657	0/0/0
Area Address: 49.0001				
NLPID: 0x8E				
IPv6 Address: 1000::1				
Metric: 10 IS 0000.0000.0002.01				
Metric: 10 IPv6 1000::/64				
0000.0000.0002.00-00*	0x00000004	0x4A36	686	0/0/0
Area Address: 49.0001				
NLPID: 0x8E				
IPv6 Address: 1000::2				
Metric: 10 IS 0000.0000.0002.01				
Metric: 10 IPv6 1000::/64				
Metric: 10 IPv6-Interarea 2000::/64				
Metric: 58 IPv6-Interarea 11:1:1:1::/64				
0000.0000.0002.01-00*	0x00000001	0x0ECB	658	0/0/0
Metric: 0 IS 0000.0000.0002.00				
Metric: 0 IS 0000.0000.0001.00				

IS-IS Level-2 Link State Database:

LSPID	LSP Seq Num	LSP Checksum	LSP Holdtime	ATT/P/OL
0000.0000.0002.00-00*	0x00000004	0x67A6	676	0/0/0
Area Address: 49.0001				
NLPID: 0x8E				
IPv6 Address: 2000::1				
Metric: 10 IS 0000.0000.0003.01				
Metric: 10 IPv6 2000::/64				
Metric: 10 IPv6 1000::/64				
0000.0000.0003.00-00	0x00000002	0xC118	675	0/0/0
Area Address: 49.0001				
NLPID: 0x8E				
IPv6 Address: 2000::2				
Metric: 10 IS 0000.0000.0003.01				
Metric: 10 IPv6 2000::/64				
Metric: 0 IPv6 11:1:1:1:1:1::/96				
Metric: 0 IPv6 11:1:1:1:2:1::/96				
Metric: 0 IPv6 11:1:1:1:3:1::/96				
0000.0000.0003.01-00	0x00000001	0x2DA9	671	0/0/0
Metric: 0 IS 0000.0000.0003.00				
Metric: 0 IS 0000.0000.0002.00				

R3#show isis database verbose

Tag ABC: VRF : default

IS-IS Level-2 Link State Database:

LSPID	LSP Seq Num	LSP Checksum	LSP Holdtime	ATT/P/OL
0000.0000.0002.00-00	0x00000004	0x67A6	605	0/0/0
Area Address: 49.0001				
NLPID: 0x8E				
IPv6 Address: 2000::1				
Metric: 10 IS 0000.0000.0003.01				
Metric: 10 IPv6 2000::/64				
Metric: 10 IPv6 1000::/64				
0000.0000.0003.00-00*	0x00000002	0xC118	606	0/0/0
Area Address: 49.0001				
NLPID: 0x8E				
IPv6 Address: 2000::2				
Metric: 10 IS 0000.0000.0003.01				
Metric: 10 IPv6 2000::/64				
Metric: 0 IPv6 11:1:1:1:1:1::/96				
Metric: 0 IPv6 11:1:1:1:2:1::/96				
Metric: 0 IPv6 11:1:1:1:3:1::/96				
0000.0000.0003.01-00*	0x00000001	0x2DA9	602	0/0/0
Metric: 0 IS 0000.0000.0003.00				
Metric: 0 IS 0000.0000.0002.00				

Passive Interface

In ISP and large enterprise networks, many of the distribution routers have more than 200 interfaces. Before the Default Passive-Interface feature, there were two possibilities for obtaining routing information from all of these interfaces:

- Configure a routing protocol on the backbone interfaces and redistribute connected interfaces.
- Configure the routing protocol on all interfaces and manually set most of them as passive, which was time consuming.

The solution to this problem was to configure the routing protocol on all interfaces and manually set the passive interface command on the interfaces where adjacency was not desired. In certain networks, this meant coding 200 or more passive-interface statements. With the Default Passive Interface feature, this problem is solved by allowing all interfaces to be set as passive by default using a single passive-interface default command, then configuring individual interfaces in which adjacencies are desired using the no passive-interface command.

Usage

1. When a specific interface is configured as passive using the passive-interface command:
 - The interface loses its adjacency on that interface, for example, eth1.
 - The interface (eth1) is still advertised by other IS-IS speaking interfaces to their neighbors.
2. When a specific interface is configured as passive using passive-interface command followed by removing the configuration using no passive-interface command:
 - The interface is IS-IS disabled and must be enabled using the ipv6 router isis command (for example, ipv6 router isis 1).
 - The interface (for example, eth1) is not advertised by other IS-IS speaking interfaces to their neighbors.

3. When an interface is configured with the passive interface command:
 - All interfaces lose their adjacency, except the interface with the higher index number. (For example: If eth1, eth2, eth3, and eth4 are the router interfaces, eth4 has the highest index number.)
 - All interfaces are advertised by the active IS-IS speaking interface to its neighbors.
4. When an interface is configured with the no passive interface command:
 - All interfaces are IS-IS disabled, except the interface that was active, and all interfaces must enable IS-IS on these interfaces using the ipv6 router isis command (for example, ipv6 router isis 1).
 - All interfaces are not advertised by the active IS-IS speaking interface to its neighbors.

Topology



Figure 14-120: IS-ISv6 Passive Interface

Configuration

R1

#configure terminal	Enter configure mode.
(config)#interface eth1	Enter interface mode.
(config-if)#ipv6 router isis ABC	Enable IS-ISv6 routing on an interface for area 49(ABC).
(config-if)#ipv6 address 1000::1/64	Configure IPv6 address on interface.
(config-if)#commit	Commit candidate configuration to the running configuration
(config-if)#exit	Exit interface mode.
(config)#router isis ABC	Create an IS-IS routing instance for area 49 (ABC).
(config-router)#is-type level-2-only	Configure instance as level-2-only routing.
(config-router)#net 49.0005.0000.0000.0001.00	Set a Network Entity Title for this instance, specifying the area address and the system ID.
(config-if)#commit	Commit candidate configuration to the running configuration
(config-router)#end	Exit the current mode and enter privilege mode.

R2

#configure terminal	Enter configure mode.
(config)#interface eth1	Enter interface mode.
(config-if)#ipv6 router isis ABC	Enable IS-ISv6 routing on an interface for area 49(ABC).
(config-if)#ipv6 address 1000::2/64	Configure IPv6 address on interface.
(config-if)#commit	Commit candidate configuration to the running configuration

(config-if)#exit	Exit interface mode.
(config)#interface eth2	Enter interface mode.
(config-if)# ipv6 router isis ABC	Enable OSPFv3 routing on an interface and assign the Area ID 0.
(config-if)#ipv6 address 2000::1/64	Configure IPv6 address on interface.
(config-if)#commit	Commit candidate configuration to the running configuration
(config-if)#exit	Exit interface mode.
(config)#router isis ABC	Create an IS-IS routing instance for area 49 (ABC).
(config-router)#is-type level-2-only	Configure instance as level-2-only routing.
(config-router)#net 49.0005.0000.0000.0002.00	Set a Network Entity Title for this instance, specifying the area address and the system ID.
(config-router)#passive-interface eth1	Configure interface eth1 as a passive-interface.
(config-if)#commit	Commit candidate configuration to the running configuration
(config-router)#end	Exit the current mode and enter privilege mode.

R3

#configure terminal	Enter configure mode.
(config)#interface eth2	Enter interface mode.
(config-if)#ipv6 router isis ABC	Enable IS-ISv6 routing on an interface for area 49(ABC).
(config-if)#ipv6 address 2000::2/64	Configure IPv6 address on interface.
(config-if)#commit	Commit candidate configuration to the running configuration
(config-if)#exit	Exit interface mode.
(config)#router isis ABC	Create an IS-IS routing instance for area 49 (ABC).
(config-router)#is-type level-2-only	Configure instance as level-2-only routing.
(config-router)#net 49.0005.0000.0000.0003.00	Set a Network Entity Title for this instance, specifying the area address and the system ID.
(config-if)#commit	Commit candidate configuration to the running configuration
(config-router)#end	Exit the current mode and enter privilege mode.

Validation

R1#show clns neighbors

Total number of L1 adjacencies: 0

Total number of L2 adjacencies: 0

Total number of adjacencies: 0

Tag ABC: VRF : default

System Id	Interface	SNPA	State	Holdtime	Type	Protocol
-----------	-----------	------	-------	----------	------	----------

R1#

R2#show clns neighbors

Total number of L1 adjacencies: 0

IS-IS IPv6 Configuration

Total number of L2 adjacencies: 1

Total number of adjacencies: 1

Tag ABC: VRF : default

System Id	Interface	SNPA	State	Holdtime	Type	Protocol
0000.0000.0003	eth2	b86a.97c7.32c5	Up	7	L2	IS-IS

R2#

R3#show clns neighbors

Total number of L1 adjacencies: 0

Total number of L2 adjacencies: 1

Total number of adjacencies: 1

Tag ABC: VRF : default

System Id	Interface	SNPA	State	Holdtime	Type	Protocol
0000.0000.0002	eth2	b86a.97c4.31c5	Up	24	L2	IS-IS

R3#

R1#show ipv6 isis route

Codes: C - connected, E - external, L1 - IS-IS level-1, L2 - IS-IS level-2
ia - IS-IS inter area, D - discard, e - external metric

Tag ABC: VRF : default

C 1000::/64 [10]
via ::, eth1

R1#

R2#show ipv6 isis route

Codes: C - connected, E - external, L1 - IS-IS level-1, L2 - IS-IS level-2
ia - IS-IS inter area, D - discard, e - external metric

Tag ABC: VRF : default

C 1000::/64 [0]
via ::, eth1
C 2000::/64 [10]
via ::, eth2

R2#

R3#show ipv6 isis route

Codes: C - connected, E - external, L1 - IS-IS level-1, L2 - IS-IS level-2
ia - IS-IS inter area, D - discard, e - external metric

Tag ABC: VRF : default

```
L2 1000::/64 [10]
    via fe80::ba6a:97ff:fec4:31c5, eth2
C 2000::/64 [10]
  via ::, eth2
```

R3#

R1#show isis database verbose

Tag ABC: VRF : default

IS-IS Level-2 Link State Database:

LSPID	LSP Seq Num	LSP Checksum	LSP Holdtime	ATT/P/OL
0000.0000.0001.00-00*	0x0000000E	0x0E19	931	0/0/0
Area Address: 49.0005				
NLPID: 0x8E				
IPv6 Address: 1000::1				
Metric: 10 IPv6 1000::/64				
0000.0000.0001.01-00*	0x00000009	0xE110	0 (931)	0/0/0
0000.0000.0002.00-00	0x00000011	0xABC7	440	0/0/0
Area Address: 49.0005				
NLPID: 0x8E				
IPv6 Address: 1000::2				
Metric: 10 IS 0000.0000.0001.01				
Metric: 10 IS 0000.0000.0003.01				
Metric: 10 IPv6 1000::/64				
Metric: 10 IPv6 2000::/64				
0000.0000.0003.00-00	0x00000002	0x9ED3	439	0/0/0
Area Address: 49.0005				
NLPID: 0x8E				
IPv6 Address: 2000::2				
Metric: 10 IS 0000.0000.0003.01				
Metric: 10 IPv6 2000::/64				
0000.0000.0003.01-00	0x00000001	0x2DA9	436	0/0/0
Metric: 0 IS 0000.0000.0003.00				
Metric: 0 IS 0000.0000.0002.00				

R1#

R1#

R2#show isis database verbose

Tag ABC: VRF : default

IS-IS Level-2 Link State Database:

LSPID	LSP Seq Num	LSP Checksum	LSP Holdtime	ATT/P/OL
0000.0000.0001.00-00	0x0000000D	0x2666	879	0/0/0
Area Address: 49.0005				
NLPID: 0x8E				
IPv6 Address: 1000::1				
Metric: 10 IS 0000.0000.0001.01				
Metric: 10 IPv6 1000::/64				
0000.0000.0001.01-00	0x00000009	0x11C1	821	0/0/0

IS-IS IPv6 Configuration

```
Metric: 0 IS 0000.0000.0001.00
Metric: 0 IS 0000.0000.0002.00
0000.0000.0002.00-00* 0x00000012 0x669F 906 0/0/0
Area Address: 49.0005
NLPID: 0x8E
IPv6 Address: 2000::1
Metric: 10 IS 0000.0000.0003.01
Metric: 0 IPv6 1000::/64
Metric: 10 IPv6 2000::/64
0000.0000.0003.00-00 0x00000002 0x9ED3 439 0/0/0
Area Address: 49.0005
NLPID: 0x8E
IPv6 Address: 2000::2
Metric: 10 IS 0000.0000.0003.01
Metric: 10 IPv6 2000::/64
0000.0000.0003.01-00 0x00000001 0x2DA9 436 0/0/0
Metric: 0 IS 0000.0000.0003.00
Metric: 0 IS 0000.0000.0002.00
```

R2#

R3#show isis database verbose

Tag ABC: VRF : default

IS-IS Level-2 Link State Database:

LSPID	LSP Seq Num	LSP Checksum	LSP Holdtime	ATT/P/OL
0000.0000.0001.00-00	0x0000000D	0x2666	879	0/0/0
Area Address: 49.0005				
NLPID: 0x8E				
IPv6 Address: 1000::1				
Metric: 10	IS 0000.0000.0001.01			
Metric: 10	IPv6 1000::/64			
0000.0000.0001.01-00	0x00000009	0x11C1	821	0/0/0
Metric: 0	IS 0000.0000.0001.00			
Metric: 0	IS 0000.0000.0002.00			
0000.0000.0002.00-00	0x00000012	0x669F	905	0/0/0
Area Address: 49.0005				
NLPID: 0x8E				
IPv6 Address: 2000::1				
Metric: 10	IS 0000.0000.0003.01			
Metric: 0	IPv6 1000::/64			
Metric: 10	IPv6 2000::/64			
0000.0000.0003.00-00*	0x00000002	0x9ED3	440	0/0/0
Area Address: 49.0005				
NLPID: 0x8E				
IPv6 Address: 2000::2				
Metric: 10	IS 0000.0000.0003.01			
Metric: 10	IPv6 2000::/64			
0000.0000.0003.01-00*	0x00000001	0x2DA9	437	0/0/0
Metric: 0	IS 0000.0000.0003.00			
Metric: 0	IS 0000.0000.0002.00			

R3#

Enable BFD over IS-ISv6

This example shows how to configure Bidirectional Forwarding Detection with IS-ISv6 instance

Topology

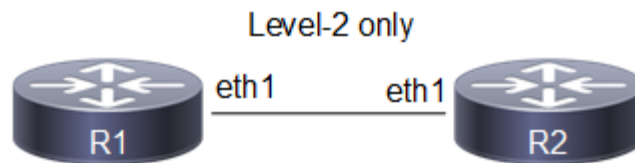

Figure 14-121: Basic BFD over IS-ISv6 Topology

Configuration

R1

#configure terminal	Enter configure mode.
(config)#interface eth1	Enter interface mode.
(config-if)#ipv6 router isis ABC	Enable IS-ISv6 routing on an interface for area 49(ABC).
(config-if)#commit	Commit candidate configuration to the running configuration
(config-if)#exit	Exit interface mode.
(config)#router isis ABC	Create an IS-IS routing instance for area 49 (ABC).
(config-router)#is-type level-2-only	Configure instance as level-2-only routing.
(config-router)#net 49.0005.0000.0000.0001.00	Set a Network Entity Title for this instance, specifying the area address and the system ID.
(config-router)#bfd all-interfaces	Enable the Bidirectional Forwarding Detection (BFD) feature on the interfaces enabled with this ISIS instance.
(config-router)#commit	Commit candidate configuration to the running configuration
(config-router)#end	Exit current mode and enter privilege mode.

R2

#configure terminal	Enter configure mode.
(config)#interface eth1	Enter interface mode.
(config-if)#ipv6 router isis ABC	Enable IS-ISv6 routing on an interface for area 49(ABC).
(config-if)#commit	Commit candidate configuration to the running configuration
(config-if)#exit	Exit interface mode.
(config)#router isis ABC	Create an IS-IS routing instance for area 49 (ABC).
(config-router)#is-type level-2-only	Configure instance as level-2-only routing.

(config-router)#net 49.0005.0000.0000.0002.00	Set a Network Entity Title for this instance, specifying the area address and the system ID.
(config-router)#bfd all-interfaces	Enable the Bidirectional Forwarding Detection (BFD) feature on the interfaces enabled with this ISIS instance.
(config-router)#commit	Commit candidate configuration to the running configuration
(config-router)#end	Exit current mode and enter privilege mode.

Validation

R1#show clns neighbors

Total number of L1 adjacencies: 0
 Total number of L2 adjacencies: 1
 Total number of adjacencies: 1

Tag ABC: VRF : default

System Id	Interface	SNPA	State	Holdtime	Type	Protocol
0000.0000.0002	eth1	b86a.97c4.31c5	Up	24	L2	IS-IS

R1#

R1#show bfd session

BFD process for VRF: (DEFAULT VRF)

```

=====
Sess-Idx  Remote-Disc  Lower-Layer  Sess-Type   Sess-State  UP-Time   Interface
Down-Reason Remote-Addr
256      256          IPv6         Single-Hop  Up          00:04:26 eth1       NA
fe80::ba6a:97ff:fec4:31c5/128
    
```

Number of Sessions: 1

R1#

R1#show bfd session detail

BFD process for VRF: (DEFAULT VRF)

```

=====
Session Interface Index : 10018           Interface name :eth1
Session Index : 256
Lower Layer : IPv6                        Version : 1
Session Type : Single Hop                 Session State : Up
Local Discriminator : 256                 Local Address : fe80::ba6a:97ff:feeb:3ec5/128
Remote Discriminator : 256                Remote Address : fe80::ba6a:97ff:fec4:31c5/128
Local Port : 49152                        Remote Port : 3784
Options :
    
```

Diagnostics : None

Timers in Milliseconds :

Min Tx: 250	Min Rx: 250	Multiplier: 3
Neg Tx: 250	Neg Rx: 250	Neg detect mult: 3
Min echo Tx: 1000	Min echo Rx: 1000	Neg echo intrvl: 0
Storage type : 2		

```
Sess down time : 00:00:00
Sess Down Reason : NA
Bfd GTSM Disabled
Bfd Authentication Disabled
```

Counters values:

```
Pkt In : n/a
Pkt Out : n/a
Pkts Drop : 000000000000000000000000
Auth Pkts Drop : 000000000000000000000000
Echo Out : 000000000000000000000000
IPv6 Echo Out : 000000000000000000000000
IPv6 Pkt In : 0000000000000000000001231
IPv6 Pkt Out : 0000000000000000000001233
UP Count : 1
UPTIME : 00:04:30
```

Protocol Client Info:

```
ISIS-> Client ID: 6      Flags: 4
```

```
-----
Number of Sessions:      1
R1#
```

Originate Default Route to ISISv6 Neighbors

This example shows how to originate default route present to ISISv6 neighbors.

Note: To get a default route in ISIS, we should have it (said default route) in the routing table first otherwise we can use the CLI "default information originate always" which advertises default route.

Topology

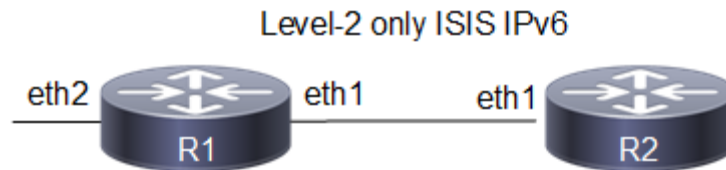

Figure 14-122: Basic IS-ISv6 Topology

Configuration

R1

#configure terminal	Enter configure mode.
(config)#ipv6 route ::/0 2345::2	Configure default route.
(config)#interface eth1	Enter interface mode.
(config-if)#ipv6 router isis ABC	Enable IS-ISv6 routing on an interface for area 49(ABC).
(config-if)#commit	Commit candidate configuration to the running configuration
(config-if)#exit	Exit interface mode.
(config)#interface eth2	Enter interface mode.

IS-IS IPv6 Configuration

(config-if)#ipv6 address 2345::1/64	Configure IPv6 address on interface.
(config)#router isis ABC	Create an IS-IS routing instance for area 49 (ABC).
(config-router)#is-type level-2-only	Configure instance as level-2-only routing.
(config-router)#net 49.0001.0000.0000.0001.00	Set a Network Entity Title for this instance, specifying the area address and the system ID.
(config-router)# address-family ipv6	Enter ipv6 address family.
(config-router-af)#default-information originate	Originate reachability information to Default destination into LSP.
(config-router-af)#commit	Commit candidate configuration to the running configuration
(config-router-af)#end	Exit all modes and enter privilege mode.

R2

#configure terminal	Enter configure mode.
(config)#interface eth1	Enter interface mode.
(config-if)#ipv6 router isis ABC	Enable IS-ISv6 routing on an interface for area 49(ABC).
(config-if)#commit	Commit candidate configuration to the running configuration
(config-if)#exit	Exit interface mode.
(config)#router isis ABC	Create an IS-IS routing instance for area 49 (ABC).
(config-router)#is-type level-2-only	Configure instance as level-2-only routing.
(config-router)#net 49.0005.0000.0000.0002.00	Set a Network Entity Title for this instance, specifying the area address and the system ID.
(config-router)#commit	Commit candidate configuration to the running configuration
(config-router)#end	Exit current mode and enter privilege mode

Validation

R1#sh clns neighbors

```
Total number of L1 adjacencies: 0
Total number of L2 adjacencies: 1
Total number of adjacencies: 1
Tag ABC: VRF : default
System Id      Interface  SNPA          State  Holdtime  Type Protocol
0000.0000.0002 eth1      cc37.ab87.3a74 Up     23        L2  IS-IS
```

R2#show clns neighbors

```
Total number of L1 adjacencies: 0
Total number of L2 adjacencies: 1
Total number of adjacencies: 1
Tag ABC: VRF : default
System Id      Interface  SNPA          State  Holdtime  Type Protocol
0000.0000.0001 eth1      b86a.97cb.3ec5 Up     6         L2  IS-IS
R2#
```

R1#show ipv6 route isis

IP Route Table for VRF "default"

R1#

R1#show ipv6 isis route

Codes: C - connected, E - external, L1 - IS-IS level-1, L2 - IS-IS level-2
 ia - IS-IS inter area, D - discard, e - external metric

Tag ABC: VRF : default

E ::/0 [0]
 via ::

R1#

R2#show ipv6 route isis

IP Route Table for VRF "default"

i L2 ::/0 [115/10] via fe80::ba6a:97ff:feeb:3ec5, eth1, 00:09:12

R2#

R2#show ipv6 isis route

Codes: C - connected, E - external, L1 - IS-IS level-1, L2 - IS-IS level-2
 ia - IS-IS inter area, D - discard, e - external metric

Tag ABC: VRF : default

L2 ::/0 [10]
 via fe80::ba6a:97ff:feeb:3ec5, eth1

R2#

R2#show isis database verbose

Tag ABC: VRF : default

IS-IS Level-2 Link State Database:

LSPID	LSP Seq Num	LSP Checksum	LSP Holdtime	ATT/P/OL
0000.0000.0001.00-00	0x00000006	0x5FA4	1033	0/0/0
Area Address: 49.0001				
NLPID: 0x8E				
Metric: 10 IS 0000.0000.0001.01				
Metric: 0 IPv6 ::/0				
0000.0000.0001.01-00	0x00000001	0x21B9	628	0/0/0
Metric: 0 IS 0000.0000.0001.00				
Metric: 0 IS R2.00				
R2.00-00	* 0x00000002	0xFBED	633	0/0/0
Area Address: 49.0001				
NLPID: 0x8E				
Hostname: R2				
Metric: 10 IS 0000.0000.0001.01				

CHAPTER 15 IS-IS-TE IPv4

This chapter contains basic IS-IS TE configuration examples.

A TE link represents an IS-IS/OSPF link state advertisement and a link state database of certain physical resources and their properties between two nodes. Typically, a TE link is advertised as an adjunct to a “regular” OSPF or IS-IS link. That is, an adjacency is brought up on the link. When the link is up, both the regular IGP properties of the link (for example, the SPF metric) and the TE properties of the link are then advertised.

Enable MPLS-TE in Level-1 and Level-2 on L1-L2 IS

In the following example, R1 is the L1 router, R2 is the L1/L2 router enabling MPLS-TE for both Level-1 and Level-2 IS, and R3 is the L2 router. The following configuration is given for R1, R2 and R3.

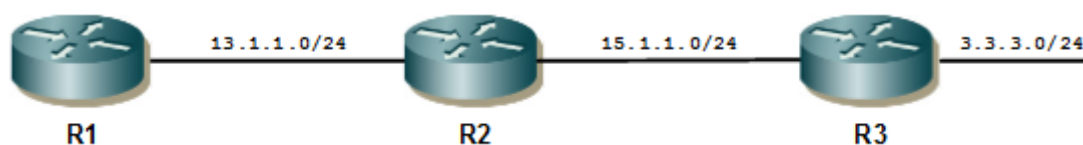

Figure 15-123: MPLS-TE Topology

Configuration

R2

#configure terminal	Enter Configure mode.
(config)#interface eth1	Specify the interface (eth1) to configure, and enter Interface mode.
(config-if)#ip address 13.1.1.2/24	Configure ip address to the interface eth1.
(config-if)#ip router isis 1	Enable ISIS on interface eth1.
(config-if)#isis circuit-type level-1	Configure ISIS circuit-type as Level-1
(config-if)#commit	Commit candidate configuration to the running configuration
(config-if)#exit	Exit from interface configuration mode.
(config)#interface eth2	Enter Interface eth2 configure mode.
(config-if)#ip address 15.1.1.2/24	Configure ip address to the interface eth2.
(config-if)#ip router isis 1	Enable ISIS on interface eth2.
(config-if)#isis circuit-type level-2	Configure ISIS circuit-type as Level-2.
(config-if)#commit	Commit candidate configuration to the running configuration
(config-if)#exit	Exit from interface configuration mode.
(config)#router isis 1	Create an IS-IS routing instance for area 49 (1).
(config-router)#metric-style wide	Configure the new style of metric type as wide.
(config-router)#mpls traffic-eng router-id 2.2.2.2	Configure MPLS-TE unique router-id TLV.
(config-router)#mpls traffic-eng level-1	Enable MPLS-TE in is-type Level-1.
(config-router)#mpls traffic-eng level-2	Enable MPLS-TE in is-type Level-2.

(config-router)#net 49.0001.0000.0000.0002.00	Configure the ISIS net address with area id as: 49.0001 and system id as: 0000.0000.0002.
(config-router)#commit	Commit candidate configuration to the running configuration
(config-router)#end	Exit Router mode.

R1

#configure terminal	Enter Configure mode.
(config)#interface eth1	Specify the interface (eth1) to configure, and enter Interface mode.
(config-if)#ip address 13.1.1.1/24	Configure ip address to the interface eth1.
(config-if)#ip router isis 1	Enable ISIS on interface eth1.
(config-if)#isis circuit-type level-1	Configure ISIS circuit-type as Level-1
(config-if)#commit	Commit candidate configuration to the running configuration
(config-if)#exit	Exit from interface configuration mode.
(config)#router isis 1	Create an IS-IS routing instance for area 49 (1).
(config-router)#metric-style wide	Configure the new style of metric type as wide.
(config-router)#is-type level-1	Configure IS-Type as Level-1 router.
(config-router)#mpls traffic-eng router-id 1.1.1.1	Configure MPLS-TE unique router-id TLV.
(config-router)#mpls traffic-eng level-1	Enable MPLS-TE in is-type Level-1.
(config-router)#net 49.0001.0000.0000.0001.00	Configure the ISIS net address with area id as: 49.0001 and system-id as: 0000.0000.0001.
(config-router)#commit	Commit candidate configuration to the running configuration
(config-router)#end	Exit Router mode.

R3

#configure terminal	Enter Configure mode.
(config)#interface eth2	Specify the interface (eth2) to configure, and enter Interface mode.
(config-if)#ip address 15.1.1.3/24	Configure ip address to the interface eth1.
(config-if)#ip router isis 1	Enable ISIS on interface eth1.
(config-if)#isis circuit-type level-2	Configure ISIS circuit-type as Level-2
(config-if)#commit	Commit candidate configuration to the running configuration
(config-if)#exit	Exit from interface configuration mode.
(config)#router isis 1	Create an IS-IS routing instance for area 49 (1).
(config-router)#metric-style wide	Configure the new style of metric type as wide.
(config-router)#is-type level-2	Configure IS-Type as Level-1 router.
(config-router)#mpls traffic-eng router-id 3.3.3.3	Configure MPLS-TE unique router-id TLV.
(config-router)#mpls traffic-eng level-2	Enable MPLS-TE in is-type Level-2.
(config-router)#net 49.0001.0000.0000.0003.00	Configure the ISIS net address with area id as: 49.0001 and system-id as: 0000.0000.0003.

(config-router)#commit	Commit candidate configuration to the running configuration
(config-router)#end	Exit Router mode.

Validation

R2

Check the output of “show clns neighbors” to verify that ISIS adjacency is up.

```
#show clns neighbors
Area 1:
System Id      Interface      SNPA              State  Holdtime  Type  Protocol
0000.0000.0001 eth1          5254.00bb.5e85    Up     24         L1   IS-IS
0000.0000.0003 eth2          5254.00ac.f960    Up     9          L2   IS-IS
#
```

Check the output of “show isis database level-1 verbose” to verify that LSP does have correct router-id.

```
R2#show isis database level-1 verbose
Tag 1: VRF : default
IS-IS Level-1 Link State Database:
LSPID          LSP Seq Num  LSP Checksum  LSP Holdtime  ATT/P/OL
0000.0000.0001.00-00 0x00000003  0x5D0E        629           0/0/0
  Area Address: 49.0001
  NLPID:        0xCC
  IP Address:   13.1.1.1
  Router ID:    1.1.1.1
  Metric:      10          IS-Extended 0000.0000.0001.01
  IPv4 Interface Address: 13.1.1.1
  Neighbor IP Address: 13.1.1.1
  Maximum Link Bandwidth: 10g
  Reservable Bandwidth: 10g
  Unreserved Bandwidth:
    Unreserved Bandwidth at priority 0: 10g
    Unreserved Bandwidth at priority 1: 10g
    Unreserved Bandwidth at priority 2: 10g
    Unreserved Bandwidth at priority 3: 10g
    Unreserved Bandwidth at priority 4: 10g
    Unreserved Bandwidth at priority 5: 10g
    Unreserved Bandwidth at priority 6: 10g
    Unreserved Bandwidth at priority 7: 10g
  TE-Default Metric: 10
  Metric:      10          IP-Extended 13.1.1.0/24
0000.0000.0001.01-00 0x00000002  0x8D3E        629           0/0/0
  Metric:      0          IS-Extended 0000.0000.0001.00
  Metric:      0          IS-Extended 0000.0000.0002.00
0000.0000.0002.00-00* 0x00000004  0xE080        634           0/0/0
  Area Address: 49.0001
  NLPID:        0xCC
  IP Address:   13.1.1.2
  Router ID:    2.2.2.2
  Metric:      10          IS-Extended 0000.0000.0001.01
  IPv4 Interface Address: 13.1.1.2
  Neighbor IP Address: 13.1.1.1
  Maximum Link Bandwidth: 10g
```

```

Reservable Bandwidth: 10g
Unreserved Bandwidth:
  Unreserved Bandwidth at priority 0: 10g
  Unreserved Bandwidth at priority 1: 10g
  Unreserved Bandwidth at priority 2: 10g
  Unreserved Bandwidth at priority 3: 10g
  Unreserved Bandwidth at priority 4: 10g
  Unreserved Bandwidth at priority 5: 10g
  Unreserved Bandwidth at priority 6: 10g
  Unreserved Bandwidth at priority 7: 10g
TE-Default Metric: 10
Metric: 10          IP-Extended 13.1.1.0/24

```

Check the output of “show isis database level-2 verbose” to verify that LSP does have correct router-id.

```

R2#show isis database level-2 verbose
Tag 1: VRF : default
IS-IS Level-2 Link State Database:
LSPID          LSP Seq Num  LSP Checksum  LSP Holdtime  ATT/P/OL
0000.0000.0002.00-00* 0x00000005  0xEE2C        622           0/0/0
  Area Address: 49.0001
  NLPID:        0xCC
  IP Address:   15.1.1.2
  Router ID:    2.2.2.2
  Metric: 10          IS-Extended 0000.0000.0003.01
  IPv4 Interface Address: 15.1.1.2
  Neighbor IP Address: 15.1.1.3
  Maximum Link Bandwidth: 10g
  Reservable Bandwidth: 10g
  Unreserved Bandwidth:
    Unreserved Bandwidth at priority 0: 10g
    Unreserved Bandwidth at priority 1: 10g
    Unreserved Bandwidth at priority 2: 10g
    Unreserved Bandwidth at priority 3: 10g
    Unreserved Bandwidth at priority 4: 10g
    Unreserved Bandwidth at priority 5: 10g
    Unreserved Bandwidth at priority 6: 10g
    Unreserved Bandwidth at priority 7: 10g
  TE-Default Metric: 10
  Metric: 10          IP-Extended 15.1.1.0/24
  Metric: 10          IP-Extended 13.1.1.0/24
0000.0000.0003.00-00 0x00000003  0x94BA        616           0/0/0
  Area Address: 49.0001
  NLPID:        0xCC
  IP Address:   15.1.1.3
  Router ID:    3.3.3.3
  Metric: 10          IS-Extended 0000.0000.0003.01
  IPv4 Interface Address: 15.1.1.3
  Neighbor IP Address: 15.1.1.3
  Maximum Link Bandwidth: 10g
  Reservable Bandwidth: 10g
  Unreserved Bandwidth:
    Unreserved Bandwidth at priority 0: 10g
    Unreserved Bandwidth at priority 1: 10g
    Unreserved Bandwidth at priority 2: 10g
    Unreserved Bandwidth at priority 3: 10g
    Unreserved Bandwidth at priority 4: 10g

```

```

    Unreserved Bandwidth at priority 5: 10g
    Unreserved Bandwidth at priority 6: 10g
    Unreserved Bandwidth at priority 7: 10g
    TE-Default Metric: 10
    Metric: 10 IP-Extended 15.1.1.0/24
0000.0000.0003.01-00 0x00000002 0x9134 616 0/0/0
    Metric: 0 IS-Extended 0000.0000.0003.00
    Metric: 0 IS-Extended 0000.0000.0002.00

```

R1

Check the output of “show clns neighbors” to verify that ISIS adjacency is up.

```
#show clns neighbors
```

```

Area 1:
System Id      Interface  SNPA                State  Holdtime  Type Protocol
0000.0000.0002 eth1      5254.00f6.4ae7     Up     7         L1   IS-IS

```

Check the output of “show isis database level-1 verbose” to verify that LSP does have correct router-id.

```

R1#show isis database level-1 verbose
Tag 1: VRF : default
IS-IS Level-1 Link State Database:
LSPID          LSP Seq Num  LSP Checksum  LSP Holdtime  ATT/P/OL
0000.0000.0001.00-00* 0x00000003  0x5D0E        364           0/0/0
  Area Address: 49.0001
  NLPID:        0xCC
  IP Address:   13.1.1.1
  Router ID:    1.1.1.1
  Metric: 10 IS-Extended 0000.0000.0001.01
  IPv4 Interface Address: 13.1.1.1
  Neighbor IP Address: 13.1.1.1
  Maximum Link Bandwidth: 10g
  Reservable Bandwidth: 10g
  Unreserved Bandwidth:
    Unreserved Bandwidth at priority 0: 10g
    Unreserved Bandwidth at priority 1: 10g
    Unreserved Bandwidth at priority 2: 10g
    Unreserved Bandwidth at priority 3: 10g
    Unreserved Bandwidth at priority 4: 10g
    Unreserved Bandwidth at priority 5: 10g
    Unreserved Bandwidth at priority 6: 10g
    Unreserved Bandwidth at priority 7: 10g
  TE-Default Metric: 10
  Metric: 10 IP-Extended 13.1.1.0/24
0000.0000.0001.01-00* 0x00000002  0x8D3E        364           0/0/0
  Metric: 0 IS-Extended 0000.0000.0001.00
  Metric: 0 IS-Extended 0000.0000.0002.00
0000.0000.0002.00-00 0x00000004  0xE080        368           0/0/0
  Area Address: 49.0001
  NLPID:        0xCC
  IP Address:   13.1.1.2
  Router ID:    2.2.2.2
  Metric: 10 IS-Extended 0000.0000.0001.01
  IPv4 Interface Address: 13.1.1.2
  Neighbor IP Address: 13.1.1.1
  Maximum Link Bandwidth: 10g

```

```

Reservable Bandwidth: 10g
Unreserved Bandwidth:
  Unreserved Bandwidth at priority 0: 10g
  Unreserved Bandwidth at priority 1: 10g
  Unreserved Bandwidth at priority 2: 10g
  Unreserved Bandwidth at priority 3: 10g
  Unreserved Bandwidth at priority 4: 10g
  Unreserved Bandwidth at priority 5: 10g
  Unreserved Bandwidth at priority 6: 10g
  Unreserved Bandwidth at priority 7: 10g
TE-Default Metric: 10
Metric: 10          IP-Extended 13.1.1.0/24

```

R3

Check the output of “show clns neighbors” to verify that ISIS adjacency is up.

```

#sh clns neighbors

Area 1:
System Id      Interface  SNPA                State  Holdtime  Type  Protocol
0000.0000.0002 eth2      5254.0062.3ea6     Up     21        L2   IS-IS

```

Check the output of “show isis database level-2 verbose” to verify that LSP does have correct router-id.

```

R3#show isis database level-2 verbose
Tag 1: VRF : default
IS-IS Level-2 Link State Database:
LSPID          LSP Seq Num  LSP Checksum  LSP Holdtime  ATT/P/OL
0000.0000.0002.00-00  0x00000005  0xEE2C        337           0/0/0
Area Address: 49.0001
NLPID:         0xCC
IP Address:    15.1.1.2
Router ID:     2.2.2.2
Metric: 10     IS-Extended 0000.0000.0003.01
IPv4 Interface Address: 15.1.1.2
Neighbor IP Address: 15.1.1.3
Maximum Link Bandwidth: 10g
Reservable Bandwidth: 10g
Unreserved Bandwidth:
  Unreserved Bandwidth at priority 0: 10g
  Unreserved Bandwidth at priority 1: 10g
  Unreserved Bandwidth at priority 2: 10g
  Unreserved Bandwidth at priority 3: 10g
  Unreserved Bandwidth at priority 4: 10g
  Unreserved Bandwidth at priority 5: 10g
  Unreserved Bandwidth at priority 6: 10g
  Unreserved Bandwidth at priority 7: 10g
TE-Default Metric: 10
Metric: 10     IP-Extended 15.1.1.0/24
Metric: 10     IP-Extended 13.1.1.0/24
0000.0000.0003.00-00* 0x00000003  0x94BA        333           0/0/0
Area Address: 49.0001
NLPID:         0xCC
IP Address:    15.1.1.3
Router ID:     3.3.3.3
Metric: 10     IS-Extended 0000.0000.0003.01
IPv4 Interface Address: 15.1.1.3

```

```

Neighbor IP Address: 15.1.1.3
Maximum Link Bandwidth: 10g
Reservable Bandwidth: 10g
Unreserved Bandwidth:
  Unreserved Bandwidth at priority 0: 10g
  Unreserved Bandwidth at priority 1: 10g
  Unreserved Bandwidth at priority 2: 10g
  Unreserved Bandwidth at priority 3: 10g
  Unreserved Bandwidth at priority 4: 10g
  Unreserved Bandwidth at priority 5: 10g
  Unreserved Bandwidth at priority 6: 10g
  Unreserved Bandwidth at priority 7: 10g
TE-Default Metric: 10
Metric: 10          IP-Extended 15.1.1.0/24
0000.0000.0003.01-00* 0x00000002  0x9134          333          0/0/0
Metric: 0          IS-Extended 0000.0000.0003.00
Metric: 0          IS-Extended 0000.0000.0002.00

```

Maximum Link Bandwidth and Reservable Bandwidth

In the following example, R1 is the L1 router, R2 is the L1/L2 router enabling MPLS-TE for both Level-1 and Level-2 IS, and R3 is the L2 router. The following configuration is given for R1, R2 & R3.

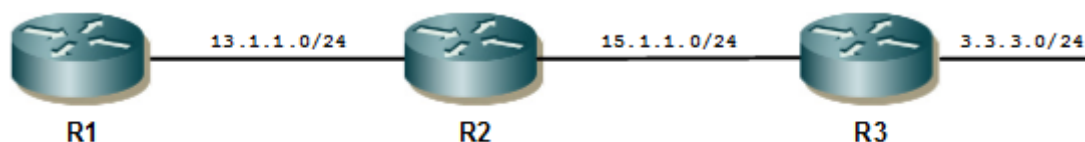

Figure 15-124: MPLS-TE Topology

R2

#configure terminal	Enter Configure mode.
(config)#interface eth1	Specify the interface (eth1) to configure, and enter Interface mode.
(config-if)#ip address 13.1.1.2/24	Configure ip address to the interface eth1.
(config-if)#ip router isis 1	Enable ISIS on interface eth1.
(config-if)#isis circuit-type level-1	Configure ISIS circuit-type as Level-1
(config-if)#commit	Commit candidate configuration to the running configuration
(config-if)#exit	Exit from interface configuration mode.
(config-if)#interface eth2	Enter Interface eth2 configure mode.
(config-if)#ip address 15.1.1.2/24	Configure ip address to the interface eth2.
(config-if)#ip router isis 1	Enable ISIS on interface eth2.
(config-if)#isis circuit-type level-2	Configure ISIS circuit-type as Level-2.
(config-if)#commit	Commit candidate configuration to the running configuration
(config-if)#exit	Exit from interface configuration mode.
(config)#router isis 1	Create an IS-IS routing instance for area 49 (1).
(config-router)#metric-style wide	Configure the new style of metric type as wide.

(config-router)#mpls traffic-eng router-id 2.2.2.2	Configure MPLS-TE unique router-id TLV.
(config-router)#mpls traffic-eng level-1	Enable MPLS-TE in is-type Level-1.
(config-router)#mpls traffic-eng level-2	Enable MPLS-TE in is-type Level-2.
(config-router)#net 49.0001.0000.0000.0002.00	Configure the ISIS net address with area id as: 49.0001 and system id as: 0000.0000.0002.
(config-router)#commit	Commit candidate configuration to the running configuration
(config-router)#exit	Exit Router mode.
(config)#interface eth2	Enter the interface configure mode.
(config-if)#bandwidth 1g	Configure Maximum link Bandwidth as 1g bits per second.
(config-if)#reservable-bandwidth 100m	Specify the maximum reservable bandwidth per interface.
(config-if)#commit	Commit candidate configuration to the running configuration
(config-if)#exit	Exit interface configure mode.
(config)#interface eth1	Enter the interface configure mode.
(config-if)#bandwidth 500m	Configure Maximum link Bandwidth as 500m bits per second.
(config-if)#reservable-bandwidth 200m	Specify the maximum reservable bandwidth per interface.
(config-if)#commit	Commit candidate configuration to the running configuration
(config-if)#exit	Exit interface configure mode.

R1

#configure terminal	Enter Configure mode.
(config)#interface eth1	Specify the interface (eth1) to configure, and enter Interface mode.
(config-if)#ip address 13.1.1.1/24	Configure ip address to the interface eth1.
(config-if)#ip router isis 1	Enable ISIS on interface eth1.
(config-if)#isis circuit-type level-1	Configure ISIS circuit-type as Level-1
(config-if)#commit	Commit candidate configuration to the running configuration
(config-if)#exit	Exit from interface configuration mode.
(config)#router isis 1	Create an IS-IS routing instance for area 49 (1).
(config-router)#metric-style wide	Configure the new style of metric type as wide.
(config-router)#is-type level-1	Configure IS-Type as Level-1 router.
(config-router)#mpls traffic-eng router-id 1.1.1.1	Configure MPLS-TE unique router-id TLV.
(config-router)#mpls traffic-eng level-1	Enable MPLS-TE in is-type Level-1.
(config-router)#net 49.0001.0000.0000.0001.00	Configure the ISIS net address with area id as: 49.0001 and system-id as: 0000.0000.0001.
(config-router)#commit	Commit candidate configuration to the running configuration
(config-router)#exit	Exit Router mode.
(config)#interface eth1	Enter the interface configure mode.
(config-if)#bandwidth 1g	Configure Maximum link Bandwidth as 1g bits per second.
(config-if)#reservable-bandwidth 100m	Specify the maximum reservable bandwidth per interface.

(config-if)#commit	Commit candidate configuration to the running configuration
(config-if)#exit	Exit interface configure mode.

R3

#configure terminal	Enter Configure mode.
(config)#interface eth2	Specify the interface (eth2) to configure, and enter Interface mode.
(config-if)#ip address 15.1.1.3/24	Configure ip address to the interface eth1.
(config-if)#ip router isis 1	Enable ISIS on interface eth1.
(config-if)#isis circuit-type level-2	Configure ISIS circuit-type as Level-1
(config-if)#commit	Commit candidate configuration to the running configuration
(config-if)#exit	Exit from interface configuration mode.
(config)#router isis 1	Create an IS-IS routing instance for area 49 (1).
(config-router)#metric-style wide	Configure the new style of metric type as wide.
(config-router)#is-type level-2	Configure IS-Type as Level-2 router.
(config-router)#mpls traffic-eng router-id 3.3.3.3	Configure MPLS-TE unique router-id TLV.
(config-router)#mpls traffic-eng level-2	Enable MPLS-TE in is-type Level-2.
(config-router)#net 49.0001.0000.0000.0003.00	Configure the ISIS net address with area id as: 49.0001 and system-id as: 0000.0000.0003.
(config-router)#commit	Commit candidate configuration to the running configuration
(config-router)#exit	Exit Router mode.
(config)#interface eth2	Enter the interface configure mode.
(config-if)#bandwidth 1g	Configure Maximum link Bandwidth as 1g bits per second.
(config-if)#reservable-bandwidth 100m	Specify the maximum reservable bandwidth per interface.
(config-if)#commit	Commit candidate configuration to the running configuration
(config-if)#exit	Exit interface configure mode.

Validation

R2

Check the output of “show clns neighbors” to verify that ISIS adjacency is up.

#show clns neighbors

```
Total number of L1 adjacencies: 2
Total number of L2 adjacencies: 1
Total number of adjacencies: 3
Tag 1: VRF : default
System Id      Interface  SNPA                State  Holdtime  Type  Protocol
0000.0000.0001 eth1      5254.003d.2123     Up     6         L1   IS-IS
0000.0000.0003 eth2      5254.00fa.54d5     Up     6         L1   IS-IS
                                Up     6         L2   IS-IS
```

Check the output of "show isis database level-1 verbose" to verify that LSP does have configured Max Link Bandwidth and Reservable Bandwidth.

```
R2#show isis database level-1 verbose
Tag 1: VRF : default
IS-IS Level-1 Link State Database:
LSPID          LSP Seq Num  LSP Checksum  LSP Holdtime  ATT/P/OL
0000.0000.0001.00-00  0x00000007  0xA4DF        1135          0/0/0
  Area Address: 49.0001
  NLPID:        0xCC
  IP Address:   13.1.1.1
  Router ID:   1.1.1.1
  Metric:      10          IS-Extended 0000.0000.0001.01
  IPv4 Interface Address: 13.1.1.1
  Neighbor IP Address: 13.1.1.1
  Maximum Link Bandwidth : 1000000.00 kbits/sec
  Reservable Bandwidth : 100000.00 kbits/sec
  Unreserved Bandwidth:
    Unreserved Bandwidth at priority 0: 100000.00 kbits/sec
    Unreserved Bandwidth at priority 1: 100000.00 kbits/sec
    Unreserved Bandwidth at priority 2: 100000.00 kbits/sec
    Unreserved Bandwidth at priority 3: 100000.00 kbits/sec
    Unreserved Bandwidth at priority 4: 100000.00 kbits/sec
    Unreserved Bandwidth at priority 5: 100000.00 kbits/sec
    Unreserved Bandwidth at priority 6: 100000.00 kbits/sec
    Unreserved Bandwidth at priority 7: 100000.00 kbits/sec
  TE-Default Metric: 10
  Metric:      10          IP-Extended 13.1.1.0/24
  Metric:      10          IP-Extended 1.1.1.1/32
0000.0000.0001.01-00  0x00000004  0x8B3C        683          0/0/0
  Metric:      0          IS-Extended 0000.0000.0001.00
  Metric:      0          IS-Extended 0000.0000.0002.00
0000.0000.0002.00-00* 0x0000000E  0x3961        1069         0/0/0
  Area Address: 49.0001
  NLPID:        0xCC
  IP Address:   13.1.1.2
  Router ID:   2.2.2.2
  Metric:      10          IS-Extended 0000.0000.0001.01
  IPv4 Interface Address: 13.1.1.2
  Neighbor IP Address: 13.1.1.1
  Maximum Link Bandwidth : 500000.00 kbits/sec
  Reservable Bandwidth : 200000.00 kbits/sec
  Unreserved Bandwidth:
    Unreserved Bandwidth at priority 0: 200000.00 kbits/sec
    Unreserved Bandwidth at priority 1: 200000.00 kbits/sec
    Unreserved Bandwidth at priority 2: 200000.00 kbits/sec
    Unreserved Bandwidth at priority 3: 200000.00 kbits/sec
    Unreserved Bandwidth at priority 4: 200000.00 kbits/sec
    Unreserved Bandwidth at priority 5: 200000.00 kbits/sec
    Unreserved Bandwidth at priority 6: 200000.00 kbits/sec
    Unreserved Bandwidth at priority 7: 200000.00 kbits/sec
  TE-Default Metric: 10
  Metric:      10          IS-Extended 0000.0000.0003.02
  IPv4 Interface Address: 15.1.1.2
  Neighbor IP Address: 15.1.1.3
  Maximum Link Bandwidth : 1000000.00 kbits/sec
  Reservable Bandwidth : 100000.00 kbits/sec
```



```

Unreserved Bandwidth:
  Unreserved Bandwidth at priority 0: 100000.00 kbits/sec
  Unreserved Bandwidth at priority 1: 100000.00 kbits/sec
  Unreserved Bandwidth at priority 2: 100000.00 kbits/sec
  Unreserved Bandwidth at priority 3: 100000.00 kbits/sec
  Unreserved Bandwidth at priority 4: 100000.00 kbits/sec
  Unreserved Bandwidth at priority 5: 100000.00 kbits/sec
  Unreserved Bandwidth at priority 6: 100000.00 kbits/sec
  Unreserved Bandwidth at priority 7: 100000.00 kbits/sec
TE-Default Metric: 10
Metric: 10          IP-Extended 2.2.2.0/24
Metric: 10          IP-Extended 13.1.1.0/24
Metric: 10          IP-Extended 15.1.1.0/24
0000.0000.0003.00-00 0x0000000A 0x4C9C          437          0/0/0
Area Address: 49.0001
NLPID: 0xCC
IP Address: 15.1.1.3
Router ID: 3.3.3.3
Metric: 10          IS-Extended 0000.0000.0003.02
Metric: 10          IP-Extended 3.3.3.3/32
Metric: 10          IP-Extended 15.1.1.0/24
0000.0000.0003.02-00 0x00000001 0x8C39          437          0/0/0
Metric: 0           IS-Extended 0000.0000.0003.00
Metric: 0           IS-Extended 0000.0000.0002.00

```

Check the output of “show isis database level-2 verbose” to verify that LSP does have configured Max Link Bandwidth and Reservable Bandwidth.

```

R2#show isis database level-2 verbose
Tag 1: VRF : default
IS-IS Level-2 Link State Database:
LSPID          LSP Seq Num  LSP Checksum  LSP Holdtime  ATT/P/OL
0000.0000.0002.00-00* 0x00000014  0x8C1A        1012          0/0/0
Area Address: 49.0001
NLPID: 0xCC
IP Address: 15.1.1.2
Router ID: 2.2.2.2
Metric: 10          IS-Extended 0000.0000.0003.02
IPv4 Interface Address: 15.1.1.2
Neighbor IP Address: 15.1.1.3
Maximum Link Bandwidth : 1000000.00 kbits/sec
Reservable Bandwidth : 100000.00 kbits/sec
Unreserved Bandwidth:
  Unreserved Bandwidth at priority 0: 100000.00 kbits/sec
  Unreserved Bandwidth at priority 1: 100000.00 kbits/sec
  Unreserved Bandwidth at priority 2: 100000.00 kbits/sec
  Unreserved Bandwidth at priority 3: 100000.00 kbits/sec
  Unreserved Bandwidth at priority 4: 100000.00 kbits/sec
  Unreserved Bandwidth at priority 5: 100000.00 kbits/sec
  Unreserved Bandwidth at priority 6: 100000.00 kbits/sec
  Unreserved Bandwidth at priority 7: 100000.00 kbits/sec
TE-Default Metric: 10
Metric: 20          IP-Extended 1.1.1.1/32
Metric: 10          IP-Extended 15.1.1.0/24
Metric: 10          IP-Extended 13.1.1.0/24
Metric: 20          IP-Extended 3.3.3.3/32
Metric: 10          IP-Extended 2.2.2.0/24

```

```

0000.0000.0003.00-00 0x0000000D 0x7B17 1006 0/0/0
Area Address: 49.0001
NLPID: 0xCC
IP Address: 15.1.1.3
Router ID: 3.3.3.3
Metric: 10 IS-Extended 0000.0000.0003.02
IPv4 Interface Address: 15.1.1.3
Neighbor IP Address: 15.1.1.3
Maximum Link Bandwidth : 1000000.00 kbits/sec
Reservable Bandwidth : 100000.00 kbits/sec
Unreserved Bandwidth:
Unreserved Bandwidth at priority 0: 100000.00 kbits/sec
Unreserved Bandwidth at priority 1: 100000.00 kbits/sec
Unreserved Bandwidth at priority 2: 100000.00 kbits/sec
Unreserved Bandwidth at priority 3: 100000.00 kbits/sec
Unreserved Bandwidth at priority 4: 100000.00 kbits/sec
Unreserved Bandwidth at priority 5: 100000.00 kbits/sec
Unreserved Bandwidth at priority 6: 100000.00 kbits/sec
Unreserved Bandwidth at priority 7: 100000.00 kbits/sec
TE-Default Metric: 10
Metric: 10 IP-Extended 3.3.3.3/32
Metric: 10 IP-Extended 15.1.1.0/24
Metric: 30 IP-Extended 1.1.1.1/32
Metric: 20 IP-Extended 13.1.1.0/24
Metric: 20 IP-Extended 2.2.2.0/24
0000.0000.0003.02-00 0x00000001 0x8C39 375 0/0/0
Metric: 0 IS-Extended 0000.0000.0003.00
Metric: 0 IS-Extended 0000.0000.0002.00

```

R1

Check the output of “show clns neighbors” to verify that ISIS adjacency is up.

```
#show clns neighbors
```

```

Total number of L1 adjacencies: 1
Total number of L2 adjacencies: 0
Total number of adjacencies: 1
Tag 1: VRF : default
System Id      Interface  SNPA                State  Holdtime  Type Protocol
0000.0000.0002 eth1      5254.0028.3734     Up     24        L1   IS-IS

```

Check the output of “show isis database level-1 verbose” to verify that LSP does have configured Max Link Bandwidth and Reservable Bandwidth.

```

R1#show isis database level-1 verbose
Tag 1: VRF : default
IS-IS Level-1 Link State Database:
LSPID          LSP Seq Num  LSP Checksum  LSP Holdtime  ATT/P/OL
PDU Length
0000.0000.0001.00-00* 0x00000006  0xA6DE        331           0/0/0
143
Area Address: 49.0001
NLPID: 0xCC
IP Address: 13.1.1.1
Router ID: 1.1.1.1
Metric: 10 IS-Extended 0000.0000.0001.01
IPv4 Interface Address: 13.1.1.1

```

```

Neighbor IP Address: 13.1.1.1
Maximum Link Bandwidth : 1000000.00 kbits/sec
Reservable Bandwidth : 100000.00 kbits/sec
Unreserved Bandwidth:
  Unreserved Bandwidth at priority 0: 100000.00 kbits/sec
  Unreserved Bandwidth at priority 1: 100000.00 kbits/sec
  Unreserved Bandwidth at priority 2: 100000.00 kbits/sec
  Unreserved Bandwidth at priority 3: 100000.00 kbits/sec
  Unreserved Bandwidth at priority 4: 100000.00 kbits/sec
  Unreserved Bandwidth at priority 5: 100000.00 kbits/sec
  Unreserved Bandwidth at priority 6: 100000.00 kbits/sec
  Unreserved Bandwidth at priority 7: 100000.00 kbits/sec
TE-Default Metric: 10
Metric: 10 IP-Extended 13.1.1.0/24
Metric: 10 IP-Extended 1.1.1.1/32
0000.0000.0001.01-00* 0x00000004 0x8B3C 780 0/0/0 51
Metric: 0 IS-Extended 0000.0000.0001.00
Metric: 0 IS-Extended 0000.0000.0002.00
0000.0000.0002.00-00 0x0000000E 0x3961 1164 0/0/0
224
Area Address: 49.0001
NLPID: 0xCC
IP Address: 13.1.1.2
Router ID: 2.2.2.2
Metric: 10 IS-Extended 0000.0000.0001.01
IPv4 Interface Address: 13.1.1.2
Neighbor IP Address: 13.1.1.1
Maximum Link Bandwidth : 500000.00 kbits/sec
Reservable Bandwidth : 200000.00 kbits/sec
Unreserved Bandwidth:
  Unreserved Bandwidth at priority 0: 200000.00 kbits/sec
  Unreserved Bandwidth at priority 1: 200000.00 kbits/sec
  Unreserved Bandwidth at priority 2: 200000.00 kbits/sec
  Unreserved Bandwidth at priority 3: 200000.00 kbits/sec
  Unreserved Bandwidth at priority 4: 200000.00 kbits/sec
  Unreserved Bandwidth at priority 5: 200000.00 kbits/sec
  Unreserved Bandwidth at priority 6: 200000.00 kbits/sec
  Unreserved Bandwidth at priority 7: 200000.00 kbits/sec
TE-Default Metric: 10
Metric: 10 IS-Extended 0000.0000.0003.02
IPv4 Interface Address: 15.1.1.2
Neighbor IP Address: 15.1.1.3
Maximum Link Bandwidth : 1000000.00 kbits/sec
Reservable Bandwidth : 100000.00 kbits/sec
Unreserved Bandwidth:
  Unreserved Bandwidth at priority 0: 100000.00 kbits/sec
  Unreserved Bandwidth at priority 1: 100000.00 kbits/sec
  Unreserved Bandwidth at priority 2: 100000.00 kbits/sec
  Unreserved Bandwidth at priority 3: 100000.00 kbits/sec
  Unreserved Bandwidth at priority 4: 100000.00 kbits/sec
  Unreserved Bandwidth at priority 5: 100000.00 kbits/sec
  Unreserved Bandwidth at priority 6: 100000.00 kbits/sec
  Unreserved Bandwidth at priority 7: 100000.00 kbits/sec
TE-Default Metric: 10
Metric: 10 IP-Extended 2.2.2.0/24
Metric: 10 IP-Extended 13.1.1.0/24
Metric: 10 IP-Extended 15.1.1.0/24

```

```

0000.0000.0003.00-00 0x0000000A 0x4C9C 533 0/0/0 80
Area Address: 49.0001
NLPID: 0xCC
IP Address: 15.1.1.3
Router ID: 3.3.3.3
Metric: 10 IS-Extended 0000.0000.0003.02
Metric: 10 IP-Extended 3.3.3.3/32
Metric: 10 IP-Extended 15.1.1.0/24
0000.0000.0003.02-00 0x00000001 0x8C39 533 0/0/0 51
Metric: 0 IS-Extended 0000.0000.0003.00
Metric: 0 IS-Extended 0000.0000.0002.00

```

R3

Check the output of “show clns neighbors” to verify that ISIS adjacency is up.

```
#show clns neighbors
```

```

Total number of L1 adjacencies: 1
Total number of L2 adjacencies: 1
Total number of adjacencies: 2
Tag 1: VRF : default
System Id      Interface  SNPA                State  Holdtime  Type  Protocol
0000.0000.0002 eth2      5254.00d4.2c13     Up     20        L1   IS-IS
                Up     20        L2   IS-IS

```

Check the output of “show isis database level-2 verbose” to verify that LSP does have configured Max Link Bandwidth and Reservable Bandwidth.

```

R3#show isis database level-2 verbose
Tag 1: VRF : default
IS-IS Level-2 Link State Database:
LSPID          LSP Seq Num  LSP Checksum  LSP Holdtime  ATT/P/OL
0000.0000.0002.00-00 0x00000010  0xA4E5       942           0/0/0
Area Address: 49.0001
NLPID: 0xCC
IP Address: 6.6.6.6
Router ID: 2.2.2.2
Metric: 10 IS-Extended 0000.0000.0003.02
IPv4 Interface Address: 15.1.1.2
Neighbor IP Address: 15.1.1.3
Maximum Link Bandwidth : 1000000.00 kbits/sec
Reservable Bandwidth : 100000.00 kbits/sec
Unreserved Bandwidth:
Unreserved Bandwidth at priority 0: 100000.00 kbits/sec
Unreserved Bandwidth at priority 1: 100000.00 kbits/sec
Unreserved Bandwidth at priority 2: 100000.00 kbits/sec
Unreserved Bandwidth at priority 3: 100000.00 kbits/sec
Unreserved Bandwidth at priority 4: 100000.00 kbits/sec
Unreserved Bandwidth at priority 5: 100000.00 kbits/sec
Unreserved Bandwidth at priority 6: 100000.00 kbits/sec
Unreserved Bandwidth at priority 7: 100000.00 kbits/sec
TE-Default Metric: 10
Metric: 10 IP-Extended 6.6.6.6/32
Metric: 10 IP-Extended 15.1.1.0/24
Metric: 10 IP-Extended 13.1.1.0/24
Metric: 20 IP-Extended 1.1.1.1/32
Metric: 20 IP-Extended 3.3.3.3/32

```

```

0000.0000.0003.00-00* 0x0000000B  0xF286          950          0/0/0
Area Address: 49.0001
NLPID:          0xCC
IP Address:     15.1.1.3
Router ID:      3.3.3.3
Metric: 10      IS-Extended 0000.0000.0003.02
IPv4 Interface Address: 15.1.1.3
Neighbor IP Address: 15.1.1.3
Maximum Link Bandwidth : 1000000.00 kbits/sec
Reservable Bandwidth : 100000.00 kbits/sec
Unreserved Bandwidth:
  Unreserved Bandwidth at priority 0: 100000.00 kbits/sec
  Unreserved Bandwidth at priority 1: 100000.00 kbits/sec
  Unreserved Bandwidth at priority 2: 100000.00 kbits/sec
  Unreserved Bandwidth at priority 3: 100000.00 kbits/sec
  Unreserved Bandwidth at priority 4: 100000.00 kbits/sec
  Unreserved Bandwidth at priority 5: 100000.00 kbits/sec
  Unreserved Bandwidth at priority 6: 100000.00 kbits/sec
  Unreserved Bandwidth at priority 7: 100000.00 kbits/sec
TE-Default Metric: 10
Metric: 10      IP-Extended 3.3.3.3/32
Metric: 10      IP-Extended 15.1.1.0/24
Metric: 30      IP-Extended 1.1.1.1/32
Metric: 20      IP-Extended 6.6.6.6/32
Metric: 20      IP-Extended 13.1.1.0/24
0000.0000.0003.02-00* 0x00000001  0x8C39          939          0/0/0
Metric: 0       IS-Extended 0000.0000.0003.00
Metric: 0       IS-Extended 0000.0000.0002.00

```

Administrative Group Constraints

To configure administrative group constraints (also known as color constraints) in Level-1 and Level-2 on L1-L2 IS:

- Configure support for required admin groups in NSM on all participating routers
- Configure required administrative groups on all participating interfaces

The configuration in this example forces the primary LSP to be setup through links that belong either to admin group A or C. A link that does not belong to either of these admin groups will not be used for setting up the LSP.

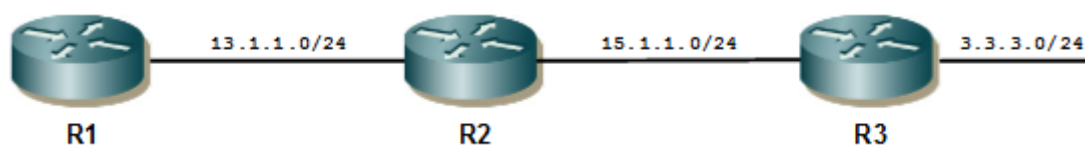

Figure 15-125: MPLS-TE Topology

R2

#configure terminal	Enter Configure mode.
(config)#interface eth1	Specify the interface (eth1) to configure, and enter Interface mode.
(config-if)#ip address 13.1.1.2/24	Configure ip address to the interface eth1.
(config-if)#ip router isis 1	Enable ISIS on interface eth1.

IS-IS-TE IPv4

(config-if)#isis circuit-type level-1	Configure ISIS circuit-type as Level-1
(config)#interface eth2	Enter Interface eth2 configure mode.
(config-if)#ip address 15.1.1.2/24	Configure ip address to the interface eth2.
(config-if)#ip router isis 1	Enable ISIS on interface eth2.
(config-if)#isis circuit-type level-2	Configure ISIS circuit-type as Level-2.
(config-if)#commit	Commit candidate configuration to the running configuration
(config-if)#exit	Exit from interface configuration mode.
(config)#admin-group a 0	Add new administrative groups and specify their names and assign bit values to them.
(config)#admin-group b 1	
(config)#admin-group c 2	
(config)#admin-group d 3	
(config)#router isis 1	Create an IS-IS routing instance for area 49 (1).
(config-router)#metric-style wide	Configure the new style of metric type as wide.
(config-router)#mpls traffic-eng router-id 2.2.2.2	Configure MPLS-TE unique router-id TLV.
(config-router)#mpls traffic-eng level-1	Enable MPLS-TE in is-type Level-1.
(config-router)#mpls traffic-eng level-2	Enable MPLS-TE in is-type Level-2.
(config-router)#net 49.0001.0000.0000.0002.00	Configure the ISIS net address with area id as: 49.0001 and system id as: 0000.0000.0002.
(config-router)#commit	Commit candidate configuration to the running configuration
(config-router)#exit	Exit Router mode.
(config)#interface eth1	Enter the interface configure mode.
(config-if)#admin-group a	Add administrative groups to the links. When used in the interface mode, this command adds a link between an Interface and a group. The name is the name of the group Previously configured. You can have multiple groups per Interface.
(config-if)#admin-group c	
(config-if)#exit	Exit interface configure mode.
(config)#interface eth2	Enter the interface configure mode.
(config-if)#admin-group b	Add administrative groups to the links. When used in the interface mode, this command adds a link between an Interface and a group. The name is the name of the group previously configured. You can have multiple groups per Interface.
(config-if)#admin-group d	
(config-if)#commit	Commit candidate configuration to the running configuration
(config-if)#end	Exit interface configure mode.

R1

#configure terminal	Enter Configure mode.
(config)#interface eth1	Specify the interface (eth1) to configure, and enter Interface mode.
(config-if)#ip address 13.1.1.1/24	Configure ip address to the interface eth1.
(config-if)#ip router isis 1	Enable ISIS on interface eth1.
(config-if)#isis circuit-type level-1	Configure ISIS circuit-type as Level-1

(config-if)#commit	Commit candidate configuration to the running configuration
(config-if)#exit	Exit interface configure mode.
(config)#admin-group a 0	Add new administrative groups and specify their names and assign bit values to them.
(config)#admin-group c 2	
(config)#router isis 1	Create an IS-IS routing instance for area 49 (1).
(config-router)#metric-style wide	Configure the new style of metric type as wide.
(config-router)#is-type level-1	Configure IS-Type as Level-1 router.
(config-router)#mpls traffic-eng router-id 1.1.1.1	Configure MPLS-TE unique router-id TLV.
(config-router)#mpls traffic-eng level-1	Enable MPLS-TE in is-type Level-1.
(config-router)#net 49.0001.0000.0000.0001.00	Configure the ISIS net address with area id as: 49.0001 and system-id as: 0000.0000.0001.
(config-router)#commit	Commit candidate configuration to the running configuration
(config-router)#exit	Exit Router mode.
(config)#interface eth1	Enter the interface configure mode.
(config-if)#admin-group a	Add administrative groups to the links. When used in the interface mode, this command adds a link between an Interface and a group. The name is the name of the group Previously configured. You can have multiple groups per Interface.
(config-if)#admin-group c	
(config-if)#commit	Commit candidate configuration to the running configuration
(config-if)#end	Exit interface configure mode.

R3

#configure terminal	Enter Configure mode.
(config)#interface eth2	Specify the interface (eth2) to configure, and enter Interface mode.
(config-if)#ip address 15.1.1.3/24	Configure ip address to the interface eth1.
(config-if)#ip router isis 1	Enable ISIS on interface eth1.
(config-if)#isis circuit-type level-2	Configure ISIS circuit-type as Level-1
(config-if)#commit	Commit candidate configuration to the running configuration
(config-if)#exit	Exit interface configure mode.
(config)#admin-group b 1	Add new administrative groups and specify their names and assign bit values to them.
(config)#admin-group d 3	
(config)#router isis 1	Create an IS-IS routing instance for area 49 (1).
(config-router)#metric-style wide	Configure the new style of metric type as wide.
(config-router)#is-type level-2	Configure IS-Type as Level-2 router.
(config-router)#mpls traffic-eng router-id 3.3.3.3	Configure MPLS-TE unique router-id TLV.
(config-router)#mpls traffic-eng level-2	Enable MPLS-TE in is-type Level-2.
(config-router)#net 49.0001.0000.0000.0003.00	Configure the ISIS net address with area id as: 49.0001 and system-id as: 0000.0000.0003.
(config-router)#commit	Commit candidate configuration to the running configuration

(config-router)#exit	Exit Router mode.
(config)#interface eth2	Enter the interface configure mode.
(config-if)#admin-group b	Add administrative groups to the links. When used in the interface mode, this command adds a link between an Interface and a group. The name is the name of the group Previously configured. You can have multiple groups per Interface.
(config-if)#admin-group d	
(config-if)#commit	Commit candidate configuration to the running configuration
(config-if)#end	Exit interface configure mode.

Validation

R2

Check the output of “show clns neighbors” to verify that ISIS adjacency is up.

```
#show clns neighbors
```

```
Area 1:
System Id      Interface  SNPA                State  Holdtime  Type  Protocol
0000.0000.0001 eth1       5254.00bb.5e85      Up     24        L1   IS-IS
0000.0000.0003 eth2       5254.00ac.f960      Up     9         L2   IS-IS
```

Check the output of “show isis database level-1 verbose” to verify that LSP does have configured admin-group constraints in Level-1.

```
straints in Level-1.
R2#show isis database level-1 verbose
Tag 1: VRF : default
IS-IS Level-1 Link State Database:
LSPID          LSP Seq Num  LSP Checksum  LSP Holdtime  ATT/P/OL
0000.0000.0001.00-00  0x00000004  0x3022        1020          0/0/0
Area Address: 49.0001
NLPID:         0xCC
IP Address:    13.1.1.1
Router ID:     1.1.1.1
Metric:        10          IS-Extended 0000.0000.0001.01
Admin-Group:
  Group 0
  Group 2
IPv4 Interface Address: 13.1.1.1
Neighbor IP Address: 13.1.1.1
Maximum Link Bandwidth: 10g
Reservable Bandwidth: 10g
Unreserved Bandwidth:
  Unreserved Bandwidth at priority 0: 10g
  Unreserved Bandwidth at priority 1: 10g
  Unreserved Bandwidth at priority 2: 10g
  Unreserved Bandwidth at priority 3: 10g
  Unreserved Bandwidth at priority 4: 10g
  Unreserved Bandwidth at priority 5: 10g
  Unreserved Bandwidth at priority 6: 10g
  Unreserved Bandwidth at priority 7: 10g
TE-Default Metric: 10
Metric:        10          IP-Extended 13.1.1.0/24
```

```

0000.0000.0001.01-00 0x00000001 0x8F3D 820 0/0/0
  Metric: 0 IS-Extended 0000.0000.0001.00
  Metric: 0 IS-Extended 0000.0000.0002.00
0000.0000.0002.00-00* 0x00000004 0xBB8D 1070 0/0/0
Area Address: 49.0001
NLPID: 0xCC
IP Address: 13.1.1.2
Router ID: 2.2.2.2
Metric: 10 IS-Extended 0000.0000.0001.01
Admin-Group:
  Group 0
  Group 2
IPv4 Interface Address: 13.1.1.2
Neighbor IP Address: 13.1.1.1
Maximum Link Bandwidth: 10g
Reservable Bandwidth: 10g
Unreserved Bandwidth:
  Unreserved Bandwidth at priority 0: 10g
  Unreserved Bandwidth at priority 1: 10g
  Unreserved Bandwidth at priority 2: 10g
  Unreserved Bandwidth at priority 3: 10g
  Unreserved Bandwidth at priority 4: 10g
  Unreserved Bandwidth at priority 5: 10g
  Unreserved Bandwidth at priority 6: 10g
  Unreserved Bandwidth at priority 7: 10g
TE-Default Metric: 10
Metric: 10 IP-Extended 13.1.1.0/24

```

Check the output of “show isis database level-2 verbose” to verify that LSP does have configured admin-group constraints in Level-2.

```

R2#show isis database level-2 verbose
Tag 1: VRF : default
IS-IS Level-2 Link State Database:
LSPID LSP Seq Num LSP Checksum LSP Holdtime ATT/P/OL
0000.0000.0002.00-00* 0x00000005 0x1FDE 1058 0/0/0
Area Address: 49.0001
NLPID: 0xCC
IP Address: 15.1.1.2
Router ID: 2.2.2.2
Metric: 10 IS-Extended 0000.0000.0003.01
Admin-Group:
  Group 1
  Group 3
IPv4 Interface Address: 15.1.1.2
Neighbor IP Address: 15.1.1.3
Maximum Link Bandwidth: 10g
Reservable Bandwidth: 10g
Unreserved Bandwidth:
  Unreserved Bandwidth at priority 0: 10g
  Unreserved Bandwidth at priority 1: 10g
  Unreserved Bandwidth at priority 2: 10g
  Unreserved Bandwidth at priority 3: 10g
  Unreserved Bandwidth at priority 4: 10g
  Unreserved Bandwidth at priority 5: 10g
  Unreserved Bandwidth at priority 6: 10g
  Unreserved Bandwidth at priority 7: 10g

```

```

    TE-Default Metric: 10
    Metric: 10          IP-Extended 15.1.1.0/24
    Metric: 10          IP-Extended 13.1.1.0/24
0000.0000.0003.00-00 0x00000004 0x71BF          1081          0/0/0
    Area Address: 49.0001
    NLPID: 0xCC
    IP Address: 15.1.1.3
    Router ID: 3.3.3.3
    Metric: 10          IS-Extended 0000.0000.0003.01
    Admin-Group:
      Group 1
      Group 3
    IPv4 Interface Address: 15.1.1.3
    Neighbor IP Address: 15.1.1.3
    Maximum Link Bandwidth: 10g
    Reservable Bandwidth: 10g
    Unreserved Bandwidth:
      Unreserved Bandwidth at priority 0: 10g
      Unreserved Bandwidth at priority 1: 10g
      Unreserved Bandwidth at priority 2: 10g
      Unreserved Bandwidth at priority 3: 10g
      Unreserved Bandwidth at priority 4: 10g
      Unreserved Bandwidth at priority 5: 10g
      Unreserved Bandwidth at priority 6: 10g
      Unreserved Bandwidth at priority 7: 10g
    TE-Default Metric: 10
    Metric: 10          IP-Extended 15.1.1.0/24
0000.0000.0003.01-00 0x00000001 0x9333          827          0/0/0
    Metric: 0          IS-Extended 0000.0000.0003.00
    Metric: 0          IS-Extended 0000.0000.0002.00

```

R1

Check the output of “show clns neighbors” to verify that ISIS adjacency is up.

```

#show clns neighbors
Area 1:
System Id      Interface  SNPA                State  Holdtime  Type Protocol
0000.0000.0002 eth1      5254.00f6.4ae7      Up     7          L1   IS-IS

```

Check the output of “show isis database level-1 verbose” to verify that LSP does have configured admin-group constraints in Level-1.

```

R1#show isis database level-1 verbose
Tag 1: VRF : default
IS-IS Level-1 Link State Database:
LSPID          LSP Seq Num  LSP Checksum  LSP Holdtime  ATT/P/OL
0000.0000.0001.00-00* 0x00000004  0x3022        1105          0/0/0
    Area Address: 49.0001
    NLPID: 0xCC
    IP Address: 13.1.1.1
    Router ID: 1.1.1.1
    Metric: 10          IS-Extended 0000.0000.0001.01
    Admin-Group:
      Group 0
      Group 2
    IPv4 Interface Address: 13.1.1.1
    Neighbor IP Address: 13.1.1.1

```

```

Maximum Link Bandwidth: 10g
Reservable Bandwidth: 10g
Unreserved Bandwidth:
  Unreserved Bandwidth at priority 0: 10g
  Unreserved Bandwidth at priority 1: 10g
  Unreserved Bandwidth at priority 2: 10g
  Unreserved Bandwidth at priority 3: 10g
  Unreserved Bandwidth at priority 4: 10g
  Unreserved Bandwidth at priority 5: 10g
  Unreserved Bandwidth at priority 6: 10g
  Unreserved Bandwidth at priority 7: 10g
TE-Default Metric: 10
Metric: 10          IP-Extended 13.1.1.0/24
0000.0000.0001.01-00* 0x00000001 0x8F3D          905          0/0/0
Metric: 0          IS-Extended 0000.0000.0001.00
Metric: 0          IS-Extended 0000.0000.0002.00
0000.0000.0002.00-00 0x00000004 0xBB8D          1153         0/0/0
Area Address: 49.0001
NLPID: 0xCC
IP Address: 13.1.1.2
Router ID: 2.2.2.2
Metric: 10          IS-Extended 0000.0000.0001.01
Admin-Group:
  Group 0
  Group 2
IPv4 Interface Address: 13.1.1.2
Neighbor IP Address: 13.1.1.1
Maximum Link Bandwidth: 10g
Reservable Bandwidth: 10g
Unreserved Bandwidth:
  Unreserved Bandwidth at priority 0: 10g
  Unreserved Bandwidth at priority 1: 10g
  Unreserved Bandwidth at priority 2: 10g
  Unreserved Bandwidth at priority 3: 10g
  Unreserved Bandwidth at priority 4: 10g
  Unreserved Bandwidth at priority 5: 10g
  Unreserved Bandwidth at priority 6: 10g
  Unreserved Bandwidth at priority 7: 10g
TE-Default Metric: 10
Metric: 10          IP-Extended 13.1.1.0/24

```

R3

Check the output of “show clns neighbors” to verify that ISIS adjacency is up.

```

#show clns neighbors
Area 1:
System Id      Interface  SNPA                State  Holdtime  Type Protocol
0000.0000.0002 eth2      5254.0062.3ea6     Up     28        L2   IS-IS

```

Check the output of “show isis database level-2 verbose” to verify that LSP does have configured admin-group constraints in Level-2.

```

R3#show isis database level-2 verbose
Tag 1: VRF : default
IS-IS Level-2 Link State Database:
LSPID          LSP Seq Num  LSP Checksum  LSP Holdtime  ATT/P/OL
0000.0000.0002.00-00 0x00000005  0x1FDE        1037          0/0/0

```

```
Area Address: 49.0001
NLPID:       0xCC
IP Address:  15.1.1.2
Router ID:   2.2.2.2
Metric:      10          IS-Extended 0000.0000.0003.01
  Admin-Group:
    Group 1
    Group 3
  IPv4 Interface Address: 15.1.1.2
  Neighbor IP Address: 15.1.1.3
  Maximum Link Bandwidth: 10g
  Reservable Bandwidth: 10g
  Unreserved Bandwidth:
    Unreserved Bandwidth at priority 0: 10g
    Unreserved Bandwidth at priority 1: 10g
    Unreserved Bandwidth at priority 2: 10g
    Unreserved Bandwidth at priority 3: 10g
    Unreserved Bandwidth at priority 4: 10g
    Unreserved Bandwidth at priority 5: 10g
    Unreserved Bandwidth at priority 6: 10g
    Unreserved Bandwidth at priority 7: 10g
  TE-Default Metric: 10
  Metric:      10          IP-Extended 15.1.1.0/24
  Metric:      10          IP-Extended 13.1.1.0/24
0000.0000.0003.00-00* 0x00000004  0x71BF          1063          0/0/0
Area Address: 49.0001
NLPID:       0xCC
IP Address:  15.1.1.3
Router ID:   3.3.3.3
Metric:      10          IS-Extended 0000.0000.0003.01
  Admin-Group:
    Group 1
    Group 3
  IPv4 Interface Address: 15.1.1.3
  Neighbor IP Address: 15.1.1.3
  Maximum Link Bandwidth: 10g
  Reservable Bandwidth: 10g
  Unreserved Bandwidth:
    Unreserved Bandwidth at priority 0: 10g
    Unreserved Bandwidth at priority 1: 10g
    Unreserved Bandwidth at priority 2: 10g
    Unreserved Bandwidth at priority 3: 10g
    Unreserved Bandwidth at priority 4: 10g
    Unreserved Bandwidth at priority 5: 10g
    Unreserved Bandwidth at priority 6: 10g
    Unreserved Bandwidth at priority 7: 10g
  TE-Default Metric: 10
  Metric:      10          IP-Extended 15.1.1.0/24
0000.0000.0003.01-00* 0x00000001  0x9333          808          0/0/0
  Metric:      0          IS-Extended 0000.0000.0003.00
  Metric:      0          IS-Extended 0000.0000.0002.00
```

CHAPTER 16 IS-IS IPv4 TE-Metric Extension

This chapter contains basic IS-IS TE-Metric Extension configuration examples.

A TE link represents an IS-IS/OSPF link state advertisement and a link state database of certain physical resources and their properties between two nodes. Typically, a TE link is advertised as an adjunct to a "regular" OSPF or IS-IS link. That is, an adjacency is brought up on the link. When the link is up, both the regular IGP properties of the link (for example, the SPF metric) and the TE properties of the link are then advertised.

Note: Bandwidth-measurement values should be less than maximum link bandwidth configuration.

Topology

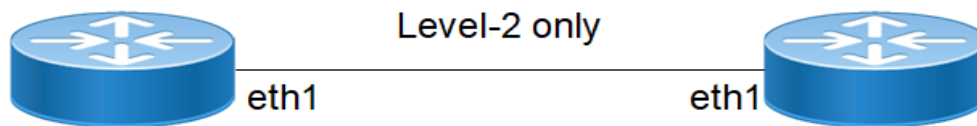

Figure 16-126: Basic IS-IS Topology

Configuration

R1

#configure terminal	Enter configure mode.
(config)#interface eth1	Enter interface mode.
(config-if)#ip address 21.21.21.2/24	Configure IP address on interface.
(config-if)#isis circuit-type level-2	Configure ISIS circuit-type as Level-2.
(config-if)#isis te-metric 40 level-2	Configure ISIS te-metric
(config-if)#bandwidth-measurement static uni-available-bandwidth 8g	Configure Bandwidth-measurement uni-available-bandwidth
(config-if)#delay-measurement static uni-delay-variation 12	Configure delay-measurement uni-delay-variation static
(config-if)#delay-measurement static uni-link-delay 12	Configure delay-measurement uni-link-delay static
(config-if)#loss-measurement static uni-link-loss 12.3	Configure loss-measurement uni-link-loss static
(config-if)#ip router isis ABC	Enable IS-IS routing on an interface for area 49 (ABC).
(config-if)#commit	Commit candidate configuration to the running configuration.
(config-if)#exit	Exit interface mode.
(config)#router isis ABC	Create an IS-IS routing instance for area 49 (ABC).
(config-router)#metric-style wide	Configure the new style of metric type as wide.
(config-router)#mpls traffic-eng level-2	Enable MPLS-TE in is-type Level-2
(config-router)#is-type level-2-only	Configure instance as level-2-only routing.
(config-router)#net 49.0000.0000.0001.00	Set a Network Entity Title for this instance, specifying the area address and the system ID.
(config-router)#commit	Commit candidate configuration to the running configuration.

R2

#configure terminal	Enter configure mode.
(config)#interface eth1	Enter interface mode.
(config)#ip address 21.21.21.1/24	Configure IP address on interface.
(config-if)#isis circuit-type level-2	Configure ISIS circuit-type as Level-2.
(config-if)#isis te-metric 40 level-2	Configure ISIS Te-metric
(config-if)#delay-measurement static uni-delay-variation 12	Configure delay-measurement uni-delay-variation static
(config-if)#delay-measurement static uni-link-delay 24	Configure delay-measurement uni-link-delay static
(config-if)#loss-measurement static uni-link-loss 23.3	Configure loss-measurement uni-link-loss static
(config-if)#commit	Commit candidate configuration to the running configuration.
(config-if)#ip router isis ABC	Enable IS-IS routing on an interface for area 49 (ABC).
(config-if)#exit	Exit interface mode.
(config)#router isis ABC	Create an IS-IS routing instance for area 49 (ABC).
(config-router)#metric-style wide	Configure the new style of metric type as wide.
(config-router)#mpls traffic-eng level-2	Enable MPLS-TE in is-type Level-2
(config-router)#is-type level-2-only	Configure instance as level-2-only routing.
(config-router)#net 49.0000.0000.0002.00	Set a Network Entity Title for this instance, specifying the area address and the system ID.
(config-router)#commit	Commit candidate configuration to the running configuration.

Validation

R1#show clns neighbors

```
Total number of L1 adjacencies: 0
Total number of L2 adjacencies: 1
Total number of adjacencies: 1
Tag ABC: VRF : default
System Id      Interface  SNPA          State  Holdtime  Type Protocol
0000.0000.0002 eth1      5254.002a.230a Up     24        L2   IS-IS
```

R2#show clns neighbors

```
Total number of L1 adjacencies: 0
Total number of L2 adjacencies: 1
Total number of adjacencies: 1
Tag ABC: VRF : default
System Id      Interface  SNPA          State  Holdtime  Type Protocol
0000.0000.0001 eth1      5254.00dc.0b76 Up     6         L2   IS-IS
```

R1#show clns is-neighbors

Tag ABC: VRF : default

```

System Id      Interface  State  Type  Priority  Circuit Id
0000.0000.0002 eth1      Up     L2    64        0000.0000.0001.01

```

```
R2#show clns is-neighbors
```

```
Tag ABC: VRF : default
```

```

System Id      Interface  State  Type  Priority  Circuit Id
0000.0000.0001 eth1      Up     L2    64        0000.0000.0001.01

```

```
R1#show isis database verbose
```

```
Tag ABC: VRF : default
```

```
IS-IS Level-2 Link State Database:
```

```

LSPID                LSP Seq Num  LSP Checksum  LSP Holdtime  ATT/P/OL
0000.0000.0001.00-00* 0x00000091   0x6A2D        1153          0/0/0

```

```
Area Address: 49
```

```
NLPID: 0xCC
```

```
IP Address: 21.21.21.2
```

```
Router ID: 10.12.65.109
```

```
Metric: 10 IS-Extended 0000.0000.0001.01
```

```
IPv4 Interface Address: 21.21.21.2
```

```
Neighbor IP Address: 21.21.21.2
```

```
Maximum Link Bandwidth: 10g
```

```
Reservable Bandwidth: 10g
```

```
Unreserved Bandwidth:
```

```
Unreserved Bandwidth at priority 0: 10g
```

```
Unreserved Bandwidth at priority 1: 10g
```

```
Unreserved Bandwidth at priority 2: 10g
```

```
Unreserved Bandwidth at priority 3: 10g
```

```
Unreserved Bandwidth at priority 4: 10g
```

```
Unreserved Bandwidth at priority 5: 10g
```

```
Unreserved Bandwidth at priority 6: 10g
```

```
Unreserved Bandwidth at priority 7: 10g
```

```
TE-Default Metric: 40
```

```
Link Delay : 12 us Anomalous : 0
```

```
Link Delay-variation : 12 us
```

```
Link Loss : 12.300000%, Anomalous : 0
```

```
Link Available Bandwidth: 8g
```

```
Metric: 10 IP-Extended 21.21.21.0/24
```

```

0000.0000.0001.01-00* 0x0000008D   0x78C5        628          0/0/0

```

```
Metric: 0 IS-Extended 0000.0000.0001.00
```

```
Metric: 0 IS-Extended 0000.0000.0002.00
```

```

0000.0000.0002.00-00 0x0000008F   0xABF0        992          0/0/0

```

```
Area Address: 49
```

```
NLPID: 0xCC
```

```
IP Address: 21.21.21.1
```

```
Router ID: 10.12.65.153
```

```
Metric: 10 IS-Extended 0000.0000.0001.01
```

```
IPv4 Interface Address: 21.21.21.1
```

```
Neighbor IP Address: 21.21.21.2
```

```
Maximum Link Bandwidth: 100m
```

```

Reservable Bandwidth: 100m
Unreserved Bandwidth:
  Unreserved Bandwidth at priority 0: 100m
  Unreserved Bandwidth at priority 1: 100m
  Unreserved Bandwidth at priority 2: 100m
  Unreserved Bandwidth at priority 3: 100m
  Unreserved Bandwidth at priority 4: 100m
  Unreserved Bandwidth at priority 5: 100m
  Unreserved Bandwidth at priority 6: 100m
  Unreserved Bandwidth at priority 7: 100m
TE-Default Metric: 30
Link Delay : 24 us Anomalous : 0
Link Delay-variation : 12 us
Link Loss : 23.299998%, Anomalous : 0
Metric: 10 IP-Extended 21.21.21.0/24
R2#show isis database verbose
Tag ABC: VRF : default
IS-IS Level-2 Link State Database:
LSPID          LSP Seq Num  LSP Checksum  LSP Holdtime  ATT/P/OL
0000.0000.0001.00-00  0x00000092  0x682E        833           0/0/0
  Area Address: 49
  NLPID:        0xCC
  IP Address:   21.21.21.2
  Router ID:   10.12.65.109
  Metric:      10 IS-Extended 0000.0000.0001.01
  IPv4 Interface Address: 21.21.21.2
  Neighbor IP Address: 21.21.21.2
  Maximum Link Bandwidth: 10g
  Reservable Bandwidth: 10g
  Unreserved Bandwidth:
    Unreserved Bandwidth at priority 0: 10g
    Unreserved Bandwidth at priority 1: 10g
    Unreserved Bandwidth at priority 2: 10g
    Unreserved Bandwidth at priority 3: 10g
    Unreserved Bandwidth at priority 4: 10g
    Unreserved Bandwidth at priority 5: 10g
    Unreserved Bandwidth at priority 6: 10g
    Unreserved Bandwidth at priority 7: 10g
  TE-Default Metric: 40
  Link Delay : 12 us Anomalous : 0
  Link Delay-variation : 12 us
  Link Loss : 12.300000%, Anomalous : 0
  Link Available Bandwidth: 8g
  Metric:      10 IP-Extended 21.21.21.0/24
0000.0000.0001.01-00  0x0000008E  0x76C6        308           0/0/0
  Metric:      0 IS-Extended 0000.0000.0001.00
  Metric:      0 IS-Extended 0000.0000.0002.00
0000.0000.0002.00-00* 0x00000090  0xA9F1        674           0/0/0
  Area Address: 49
  NLPID:        0xCC

```

IP Address: 21.21.21.1
Router ID: 10.12.65.153
Metric: 10 IS-Extended 0000.0000.0001.01
IPv4 Interface Address: 21.21.21.1
Neighbor IP Address: 21.21.21.2
Maximum Link Bandwidth: 100m
Reservable Bandwidth: 100m
Unreserved Bandwidth:
Unreserved Bandwidth at priority 0: 100m
Unreserved Bandwidth at priority 1: 100m
Unreserved Bandwidth at priority 2: 100m
Unreserved Bandwidth at priority 3: 100m
Unreserved Bandwidth at priority 4: 100m
Unreserved Bandwidth at priority 5: 100m
Unreserved Bandwidth at priority 6: 100m
Unreserved Bandwidth at priority 7: 100m
TE-Default Metric: 30
Link Delay : 24 us Anomalous : 0
Link Delay-variation : 12 us
Link Loss : 23.299998%, Anomalous : 0
Metric: 10 IP-Extended 21.21.21.0/24

CHAPTER 17 IS-IS Graceful Restart Configuration

The Intermediate System to Intermediate System (IS-IS) routing protocol is a link state intra-domain routing protocol. Normally, when an IS-IS router is restarted, temporary disruption of routing occurs due to events in both the restarting router and the neighbors of the restarting router.

ISIS provides graceful restart, in which the adjacency and routes are maintained in the routing table for the grace period. In this way, the data flow is not affected, and there is no packet loss during the restart phase.

With ISIS GR, the ISIS router should be able to restart gracefully with non-stop forwarding during the recovery. And the Helper ISIS router should be able to help restarting router by maintaining the adjacency.

ISIS Grace Restart Functionality applies to:

- ISIS broadcast network
- ISIS point-to-point network
- IPv4 domain
- IPv6 domain

Topology

In this example, R1 is the L1/L2 router, and R2 is the L1/L2 restart-helper router.

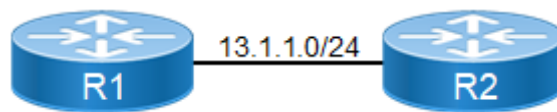

Figure 17-127: IS-IS Graceful Restart

Configuration

The following configuration is given only for R2, assuming that the adjacency with R1 is already up and the route tables with the appropriate routes are already populated.

R2

<code>#configure terminal</code>	Enter configure mode.
<code>(config)#isis restart helper</code>	Configure this router as a restart helper.
<code>(config)#isis restart grace-period 100</code>	Set the grace period to 100 seconds. The restarting router should come up before 100 seconds, otherwise, the adjacency and routes will be deleted.
<code>(config)#commit</code>	Commit candidate configuration to the running configuration

Note: The IS-IS daemon in the restarting router must be manually restarted using `restart isis graceful` command: it does not restart automatically.

Note: The scope of unplanned GR is that if the ISIS daemon crashes or gets killed with SIGSEGV signal then the routes will be stale marked until the hold time (30 seconds), assuming that ISIS will be restarted within the hold time. Neighbor adjacency cannot be maintained in unplanned GR.

Validation

```
R2#show ip route
Codes: K - kernel, C - connected, S - static, R - RIP, B - BGP
       O - OSPF, IA - OSPF inter area
       N1 - OSPF NSSA external type 1, N2 - OSPF NSSA external type 2
       E1 - OSPF external type 1, E2 - OSPF external type 2
       i - IS-IS, L1 - IS-IS level-1, L2 - IS-IS level-2,
       ia - IS-IS inter area, E - EVPN,
       v - vrf leaked
       * - candidate default
```

```
IP Route Table for VRF "default"
C      13.1.1.0/24 is directly connected, eth1, 04:08:20
i ia   20.0.0.0/6 [115/11] via 13.1.1.2, eth1, 00:10:44
i L1   33.0.0.0/24 [115/20] via 13.1.1.2, eth1, 00:10:44
C      127.0.0.0/8 is directly connected, lo, 04:10:59
C      192.168.52.0/24 is directly connected, eth0, 04:10:55
```

```
R2#show clns neighbors
```

```
Tag 1: VRF : default
System Id      Interface      SNPA              State  Holdtime  Type Protocol
0000.0000.0002 eth1          5254.0099.1e21    Up     20        L1   IS-IS
```

```
R2#show ip route database
Codes: K - kernel, C - connected, S - static, R - RIP, B - BGP
       O - OSPF, IA - OSPF inter area
       N1 - OSPF NSSA external type 1, N2 - OSPF NSSA external type 2
       E1 - OSPF external type 1, E2 - OSPF external type 2
       i - IS-IS, L1 - IS-IS level-1, L2 - IS-IS level-2,
       ia - IS-IS inter area, E - EVPN,
       v - vrf leaked
       > - selected route, * - FIB route, p - stale info
```

```
IP Route Table for VRF "default"
C      *> 13.1.1.0/24 is directly connected, eth1, 04:10:56
i L1    13.1.1.0/24 [115/10] is directly connected, eth1, 01:58:50
i ia   *> 20.0.0.0/6 [115/11] via 13.1.1.2, eth1, 00:13:20
i L1   *> 33.0.0.0/24 [115/20] via 13.1.1.2, eth1, 00:13:20
C      *> 127.0.0.0/8 is directly connected, lo, 04:13:35
C      *> 192.168.52.0/24 is directly connected, eth0, 04:13:31
```

```
Gateway of last resort is not set
```

CHAPTER 18 Forwarding Plane Load Balancing

OcNOS uses Forwarding Plane Load Balancing when the kernel supports Equal Cost Multipath (ECMP). OcNOS installs the maximum number of ECMP routes supported by the kernel. This allows for load balancing to be performed with more than one nexthop to reach a destination. If the router receives and installs multiple paths with the same administrative distance and cost to a destination, load-balancing is possible.

Ideally, multiple nexthops have different interfaces to the destination, but this is not mandatory. The algorithm for distributing traffic across ECMP routes is dependent on the kernel, and typically based on the protocol, source address, destination address, and port.

Enable Load Balancing

The following example illustrates how to enable Equal Cost Multipath (ECMP), and configure a routing protocol (OSPF is used in this example) for load balancing. However, this example will not work if the kernel does not support load balancing. In this topology, R1, R2, and R3 are three Linux routers connected to each other. R1 can reach R3 through two links available to R2.

Topology

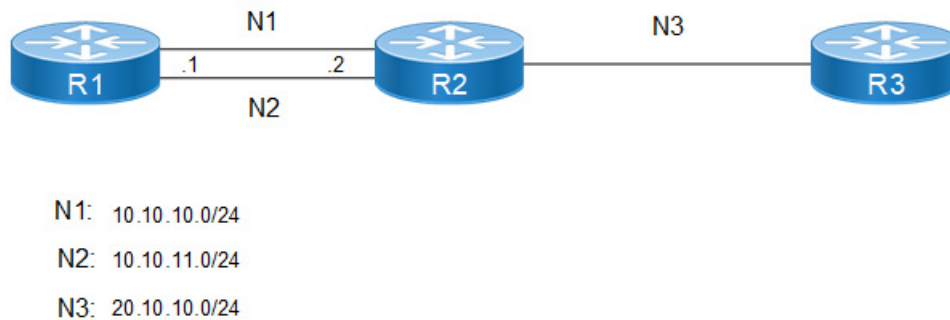

Figure 18-128: Load Balancing Topology

Configuration

R1 - NSM

1. Enable multipath support and set the maximum number of paths to be installed in the Forwarding Information Base (FIB):

#configure terminal	Enter configure mode
(config)#maximum-paths 2	Create maximum paths 2
(config)#commit	Commit the candidate configuration to the running configuration
(config)#exit	Exit interface mode

Note: User can save and reboot to bring changes into effect.

R1 - OSPF

1. Configure OSPF on all interfaces on R1, R2, and R3.

R1 learns about R3 through 2 nexthops (both networks N1 and N2).

#configure terminal	Enter configure mode
(config)#router ospf 1	Enter ospf router mode
(config-router)#router 1.1.1.1	Specify router id
(config-router)#net 10.11.1.1/30 a 0	Configure ospf network in area 0
(config)#commit	Commit the candidate configuration to the running configuration
(config)#end	Exit interface mode

R2 - OSPF

#configure terminal	Enter configure mode
(config)#router ospf 1	Enter ospf router mode
(config-router)#router 2.2.2.2	Specify router id
(config-router)#net 10.11.1.2/30 a 0	Configure ospf network in area 0
(config)#commit	Commit the candidate configuration to the running configuration
(config)#end	Exit interface mode

R3 - OSPF

#configure terminal	Enter configure mode
(config)#router ospf 1	Enter ospf router mode
(config-router)#router 3.3.3.3	Specify router id
(config-router)#net 10.1.1.2/30 a 0	Configure ospf network in area 0
(config)#commit	Commit the candidate configuration to the running configuration
(config)#end	Exit interface mode

Validation

R1 - OSPF

Run the `show ip ospf route` command on R1. The OSPF routing table displays that it can reach R3 through both of the nexthops:

```
R1#show ip ospf route
```

```
OSPF process 100:
```

```
Codes: C - connected, D - Discard, O - OSPF, IA - OSPF inter area
```

```
       N1 - OSPF NSSA external type 1, N2 - OSPF NSSA external type 2
```

```
       E1 - OSPF external type 1, E2 - OSPF external type 2
```

```
C 10.10.10.0/24 [10] is directly connected, eth1, Area 0.0.0.0
C 10.10.11.0/24 [10] is directly connected, eth2, Area 0.0.0.0
O 20.10.10.0/24 [11] via 10.10.10.3, eth1, Area 0.0.0.0
    via 10.10.11.3, eth2, Area 0.0.0.0
```

Run the `show ip route` command on R1. It displays that R1 has installed both nexthops to reach R3 in the NSM routing table:

```
R1#show ip route
Codes: K - kernel, C - connected, S - static, R - RIP, B - BGP
       O - OSPF, IA - OSPF inter area
       N1 - OSPF NSSA external type 1, N2 - OSPF NSSA external type 2
       E1 - OSPF external type 1, E2 - OSPF external type 2
       i - IS-IS, L1 - IS-IS level-1, L2 - IS-IS level-2,
       ia - IS-IS inter area, E - EVPN,
       v - vrf leaked
       * - candidate default
```

```
IP Route Table for VRF "default"
C    10.10.10.0/24 is directly connected, eth1, 00:17:08
C    10.10.11.0/24 is directly connected, eth2, 00:16:49
O    20.10.10.0/24 [110/11] via 10.10.11.3, eth2, 00:08:52
    [110/11] via 10.10.10.3, eth1
C    127.0.0.0/8 is directly connected, lo, 00:25:21
C    192.168.52.0/24 is directly connected, eth0, 00:25:16
```

Gateway of last resort is not set

CHAPTER 19 VLAN Interfaces

This chapter contains examples for configuring VLAN interfaces.

Overview

Several Virtual LAN (VLAN) interfaces can be configured on a single Ethernet interface. Once created, a VLAN interface functions the same as any physical interface.

NSM recognizes VLAN interfaces as physical interfaces. Once VLAN interfaces are created in the kernel, and IP addresses are assigned to them, OcnOS commands can be used to configure and display VLAN interfaces the same as any physical interface. OcnOS routing protocols, such as OSPF and BGP can run across networks using VLAN interfaces.

Two systems with physical connectivity (either directly connected or connected through a switch), can communicate with each other via VLAN interfaces that have the same VLAN IDs and belong to the same network.

If the physical interfaces are not directly connected to a switch, the corresponding ports on the switch must be configured as trunks, and should not be associated to any VLANs in the switch. The commands to configure switch ports as trunks depend on the type of the switch, and are beyond the scope of this document.

Topology

Figure 19-129 is used to describe VLAN interface configuration. In this example, there are two routers, R1 and R2, and the eth1 interface of R1 is connected directly to eth2 using an ethernet cable.

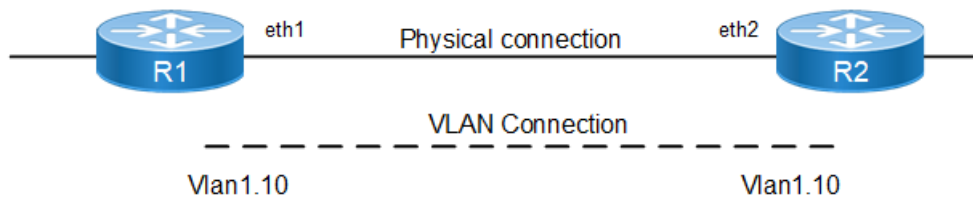

Figure 19-129: VLAN Connections

The `vlan1.10` VLAN interface is created on R1, and `vlan1.10` is created on R2. The VLAN interfaces are configured in the same network: R1 and R2 can reach each other using the VLAN connection.

Note: A VLAN ID of both VLAN interfaces is the same (10). Two systems with different VLAN IDs cannot communicate, even if they are in the same network, since a VLAN ID tags packets sent on a VLAN interface.

Create a VLAN Interface

When a VLAN interface is configured, a Layer 3 interface based on the bridge-group number and VLAN ID is created. This Layer 3 interface is advertised to all the Layer 3 protocols.

<code>#configure terminal</code>	Enter configure mode.
<code>(config)#bridge 1 protocol mstp</code>	Create a MSTP bridge.
<code>(config)#vlan database</code>	Enter VLAN mode.
<code>(config-vlan)#vlan 10 bridge 1</code>	Enable VLAN 10 on bridge 1.
<code>(config-vlan)#exit</code>	Exit VLAN mode.

VLAN Interfaces

<code>(config)#interface eth1</code>	Enter interface mode
<code>(config-if)#switchport</code>	Configure interface as Layer2 interface.
<code>(config-if)#bridge-group 1</code>	Associate bridge group 1.
<code>(config-if)#switchport mode trunk</code>	Configure interface eth1 as Layer2 trunk mode.
<code>(config-if)#switchport trunk allowed vlan add 10</code>	Associate VLAN 10 as trunk port.
<code>(config-if)#commit</code>	Commit the candidate configuration to the running
<code>(config-if)#exit</code>	Exit interface mode.

Add IP Addresses to VLAN Interface

In NSM, you can add or remove IP addresses from VLAN interfaces, like normal interfaces. Using IMISH type:

<code>#configure terminal</code>	Enter configure mode
<code>(config)#interface vlan1.10</code>	Enter interface mode
<code>(config-if)#ip address 192.168.1.50/24</code>	Assign ip address to vlan interface
<code>(config-if)#commit</code>	Commit the candidate configuration to the running
<code>(config-if)#end</code>	Exit interface mode.

Display VLAN Interfaces

In OcnOS, VLAN interfaces appear as any physical interfaces, in the `show running-config` or the `show ip interface brief` outputs, and can be configured as any other interface.

The following is a sample output of the `show ip interface brief` command on R1.

Note: The IP address of interface `vlan1.10` has correctly been changed by NSM:

```
#show ip interface brief
```

```
'*' - address is assigned by dhcp client
```

Interface	IP-Address	Admin-Status	Link-Status
eth0	10.12.56.26	up	up
lo	127.0.0.1	up	up
lo.management	127.0.0.1	up	up
vlan1.1	unassigned	up	up
vlan1.10	192.168.1.50	up	up
xe1	unassigned	up	up
xe2	unassigned	up	up
xe3	unassigned	up	down
xe4	unassigned	up	down
xe5	unassigned	up	down
xe6	unassigned	up	down
xe7	unassigned	up	down
xe8	unassigned	up	down
xe9	unassigned	up	down
xe10	unassigned	up	down

xe11	unassigned	up	down
xe12	unassigned	up	down
xe13	unassigned	up	up
xe14	unassigned	up	down
xe15	unassigned	up	down
xe16	unassigned	up	up
xe17	unassigned	up	down
xe18	unassigned	up	down
xe19	unassigned	up	down
xe20	unassigned	up	down
xe21	unassigned	up	down
xe22	unassigned	up	down
xe23	unassigned	up	down
xe24	unassigned	up	down
xe25	unassigned	up	down
xe26	unassigned	up	down
xe28	unassigned	up	down
xe29	unassigned	up	down
xe30	unassigned	up	down
xe31	unassigned	up	down
xe32	unassigned	up	up
xe33	unassigned	up	down
xe34	unassigned	up	down
xe35	unassigned	up	down
xe36	unassigned	up	down
xe37	unassigned	up	up
xe38	unassigned	up	down
xe39	unassigned	up	down
xe40	unassigned	up	down
xe41	unassigned	up	up
xe42	unassigned	up	down
xe43	unassigned	up	down
xe44	unassigned	up	down
xe45	unassigned	up	up
xe46	unassigned	up	down
xe47	unassigned	up	down
xe48	unassigned	up	up
xe49/1	unassigned	up	up
xe49/2	unassigned	up	down
xe49/3	unassigned	up	down
xe49/4	unassigned	up	down
xe50/1	unassigned	up	up
xe50/2	unassigned	up	down
xe50/3	unassigned	up	down
xe50/4	unassigned	up	down
xe51/1	unassigned	up	down
xe51/2	unassigned	up	down
xe51/3	unassigned	up	down
xe51/4	unassigned	up	down
xe52/1	unassigned	up	down

VLAN Interfaces

xe52/2	unassigned	up	down
xe52/3	unassigned	up	down
xe52/4	unassigned	up	down
xe53/1	unassigned	up	up
xe53/2	unassigned	up	down
xe53/3	unassigned	up	down
xe53/4	unassigned	up	down
xe54/1	unassigned	up	up
xe54/2	unassigned	up	down
xe54/3	unassigned	up	down
xe54/4	unassigned	up	down

Below is the NSM routing table, which shows the connected network 192.168.1.0/24 of vlan1.10. These interfaces will now act as any physical interfaces, and all routing protocols will run across this network.

```
#show ip route
```

```
Codes: K - kernel, C - connected, S - static, R - RIP, B - BGP  
O - OSPF, IA - OSPF inter area  
N1 - OSPF NSSA external type 1, N2 - OSPF NSSA external type 2  
E1 - OSPF external type 1, E2 - OSPF external type 2  
i - IS-IS, L1 - IS-IS level-1, L2 - IS-IS level-2,  
ia - IS-IS inter+F27 area, E - EVPN,  
v - vrf leaked  
* - candidate default
```

```
IP Route Table for VRF "default"
```

```
C    127.0.0.0/8 is directly connected, lo, 00:16:43  
C    192.168.1.0/24 is directly connected, vlan1.10, 00:02:05  
C    192.168.52.0/24 is directly connected, eth0, 00:16:39
```

```
Gateway of last resort is not set
```

CHAPTER 20 Layer 3 Link Aggregation

This chapter contains a complete sample Link Aggregation Control Protocol (LACP) configuration (L3 LAG).

Link Aggregation is the method of combining individual physical network interfaces or ports to increase the capacity of the link to support and sustain beyond the individual port capability. Features like Spanning Tree, VLAN, FDB, Multicast operate on both physical ports as well as Link Aggregated Logical Ports. It bundles all of the controller's distribution system ports into a single 802.3ad port channel, thereby reducing the number of IP addresses needed to configure the ports on your controller. When LAG is enabled, the system dynamically manages port redundancy and load balances access points transparently to the user.

LACP is based on the 802.3ad IEEE specification. It allows bundling of several physical interfaces to form a single logical channel providing enhanced performance and redundancy. The aggregated interface is viewed as a single link to each switch. The spanning tree views it as one interface and not as two or three interfaces. When there is a failure in one physical interface, the other interfaces stay up and there is no disruption.

The OcnOS LACP implementation supports the aggregation of a maximum of six physical Ethernet links into a single logical channel.

Topology

In this example, 3 links are configured between the two switches R1 and R2. These three links are assigned the same administrative key (1) so that they aggregate to form a single channel 1. They are viewed by STP as one interface.

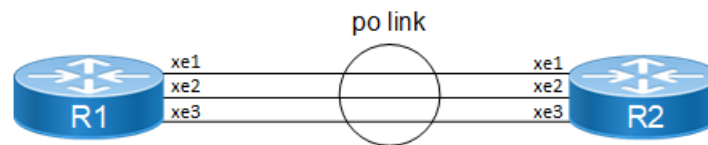

Figure 20-130: L3_LAG Topology

Configuration

R1

R1#configure terminal	Enter configure mode.
R1(config)#interface po10	Enter interface mode.
R1(config-if)#ip address 1.1.1.1/24	Assigning IP Address to PO Interface
R1(config-if)#commit	Commit the candidate configuration to the running configuration
R1(config-if)#exit	Exit interface mode.
R1(config)#lacp system-priority 20000	Set the system priority of this switch. This priority is used for determining the system that is responsible for resolving conflicts in the choice of aggregation groups. A lower numerical value has a higher priority.
R1(config)#interface xe1	Enter interface mode.
R1(config-if)#no switchport	Making Interface as L3 Port (This command will remove if switchport configuration is present).

Layer 3 Link Aggregation

R1(config-if)#channel-group 10 mode active	Add this interface to channel group 10 and enable link aggregation so that it can be selected for aggregation by the local system.
R1(config-if)#commit	Commit the candidate configuration to the running configuration
R1(config-if)#exit	Exit interface mode.
R1(config)#interface xe2	Enter interface mode.
R1(config-if)#no switchport	Making Interface as L3 Port (This command will remove if switchport configuration is present).
R1(config-if)#channel-group 10 mode active	Add this interface to channel group 10 and enable link aggregation so that it can be selected for aggregation by the local system.
R1(config-if)#exit	Exit interface mode.
R1(config)#interface xe3	Enter interface mode.
R1(config-if)#no switchport	Making Interface as L3 Port (This command will remove if switchport configuration is present).
R1(config-if)#channel-group 10 mode active	Add this interface to channel group 10 and enable link aggregation so that it can be selected for aggregation by the local system.
R1(config-if)#commit	Commit the candidate configuration to the running configuration
R1(config-if)#exit	Exit interface mode.

R2

R2#configure terminal	Enter configure mode.
R2(config)#interface po10	Enter interface mode.
R2(config-if)#ip address 1.1.1.2/24	Assigning IP Address to PO Interface
R2(config-if)#commit	Commit the candidate configuration to the running configuration
R2(config-if)#exit	Exit interface mode.
R2(config)#lacp system-priority 20000	Set the system priority of this switch. This priority is used for determining the system that is responsible for resolving conflicts in the choice of aggregation groups. A lower numerical value has a higher priority.
R2(config)#interface xe1	Enter interface mode.
R2(config-if)#no switchport	Making Interface as L3 Port (This command will remove if switchport configuration is present).
R2(config-if)#channel-group 10 mode active	Add this interface to channel group 10 and enable link aggregation so that it can be selected for aggregation by the local system.
R1(config-if)#commit	Commit the candidate configuration to the running configuration
R2(config-if)#exit	Exit interface mode.
R2(config)#interface xe2	Enter interface mode.
R2(config-if)#no switchport	Making Interface as L3 Port (This command will remove if switchport configuration is present).

R2(config-if)#channel-group 10 mode active	Add this interface to channel group 10 and enable link aggregation so that it can be selected for aggregation by the local system.
R2(config-if)#exit	Exit interface mode.
R2(config)#interface xe3	Enter interface mode.
R2(config-if)#no switchport	Making Interface as L3 Port (This command will remove if switchport configuration is present).
R2(config-if)#channel-group 10 mode active	Add this interface to channel group 10 and enable link aggregation so that it can be selected for aggregation by the local system.
R2(config-if)#commit	Commit the candidate configuration to the running configuration
R2(config-if)#exit	Exit interface mode.

Static Channel-group

R1

R1#configure terminal	Enter configure mode
R1(config)#interface sa12	Enter interface mode
R1(config-if)#no switchport	Making Interface as L3 Port (This command will remove if switchport configuration is present).
R1(config-if)#ip address 2.2.2.1/24	Assigning IP Address to PO Interface
R1(config-if)#commit	Commit the candidate configuration to the running configuration
R1(config-if)#exit	Exit interface mode
R1(config)#interface xe1	Enter interface mode
R1(config-if)#static-channel-group 12	Add this interface to channel group 12 and enable link aggregation so that it can be selected for aggregation by the local system.
R1(config-if)#commit	Commit the candidate configuration to the running configuration
R1(config-if)#exit	Exit interface mode

R2

R2#configure terminal	Enter configure mode
R2(config)#interface sa12	Enter interface mode
R2(config-if)#no switchport	Making Interface as L3 Port (This command will remove if switchport configuration is present).
R2(config-if)#ip address 2.2.2.2/24	Assigning IP Address to PO Interface
R1(config-if)#commit	Commit the candidate configuration to the running configuration
R2(config-if)#exit	Exit interface mode
R2(config)#interface xe1	Enter interface mode

Layer 3 Link Aggregation

R2(config-if)#static-channel-group 12	Add this interface to channel group 12 and enable link aggregation so that it can be selected for aggregation by the local system.
R1(config-if)#commit	Commit the candidate configuration to the running configuration
R2(config-if)#exit	Exit interface mode

Validation

show etherchannel detail, show etherchannel summary

```
#sh etherchannel summary
% Aggregator po10 100010
% Aggregator Type: Layer3
% Admin Key: 0010 - Oper Key 0010
% Link: xe1 (10049) sync: 1
% Link: xe2 (10050) sync: 1
% Link: xe3 (10051) sync: 1

#sh etherchannel detail
% Aggregator po10 100010
% Aggregator Type: Layer3
% Mac address: 14:18:77:5d:5c:01
% Admin Key: 0010 - Oper Key 0010
% Actor LAG ID- 0x4e20,14-18-77-01-5c-00,0x000a
% Receive link count: 3 - Transmit link count: 3
% Individual: 0 - Ready: 1
% Partner LAG ID- 0x4e20,14-18-77-01-73-00,0x000a
% Link: xe1 (10049) sync: 1
% Link: xe2 (10050) sync: 1
% Link: xe3 (10051) sync: 1
% Collector max delay: 5

#sh etherchannel 10
% Aggregator po10 100010 Admin Key: 0010 - Oper Key 0010
% Partner LAG ID: 0x4e20,14-18-77-01-73-00,0x000a
% Partner Oper Key 0010

#sh etherchannel
% LACP Aggregator: po10
% Member:
  xe1
  xe2
  xe3

#show static-channel-group
%Static Aggregator: sa12
% Member Status
% xe1 up
% xe2 up
% xe3 up
```

CHAPTER 21 Static Routes

This chapter contains basic static routing configuration examples.

This example shows the complete configuration to enable static routing in a simple network topology. A static route is composed of a network prefix (host address) and a next hop (gateway). Static routes are useful in small networks. They are simple solutions for making a few destinations reachable. Large networks use dynamic routing protocols.

For details about the commands used in these examples, see the *Unicast Routing Information Base Command Reference*.

Topology

Router R1 is configured with these static routes:

- The remote network 10.10.12.0/24
- The loopback address (host addresses) of router R2
- The loopback address of router R3

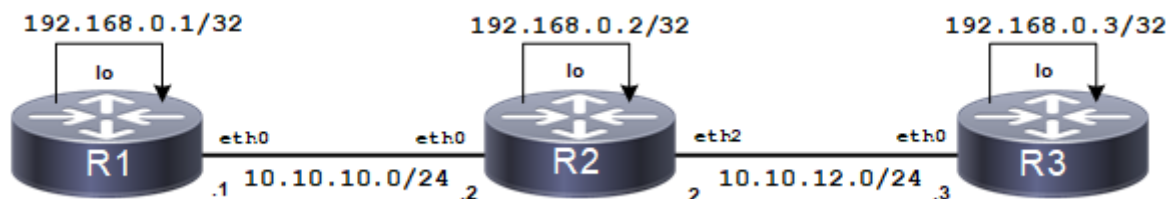

Figure 21-131: Basic Static Route

In all three routes, interface `eth0` of router R2 is the gateway. Router R3 is configured with a default static route that is equivalent to configuring separate static routes with the same gateway or next hop address. Router R2 has two routes, one for each of the remote routers' loopback address.

Configuration

R1

<code>#configure terminal</code>	Enter configure mode.
<code>(config)#interface lo</code>	Enter interface mode.
<code>(config-if)#ip address 192.168.0.1/32 secondary</code>	Configure the IP address on this interface, and specify a 32-bit mask, making it a host address.
<code>(config-if)#commit</code>	Commit the candidate configuration to the running configuration
<code>(config-if)#exit</code>	Exit interface mode.
<code>(config)#ip route 10.10.12.0/24 10.10.10.2</code>	Specify the destination prefix and mask for the network and a gateway. Because R2 is the only next hop available, you can configure a default route instead of configuring the same static route for individual addresses. See the configuration of R3.
<code>(config)#ip route 192.168.0.2/32 10.10.10.2</code>	
<code>(config)#ip route 192.168.0.3/32 10.10.10.2</code>	

Static Routes

<code>(config-if)#commit</code>	Commit the candidate configuration to the running configuration
<code>(config)#exit</code>	Exit configure mode

R2

<code>#configure terminal</code>	Enter configure mode.
<code>(config)#interface lo</code>	Enter interface mode.
<code>(config-if)#ip address 192.168.0.2/32 secondary</code>	Configure the IP address on this interface, and specify a 32-bit mask, making it a host address.
<code>(config-if)#commit</code>	Commit the candidate configuration to the running configuration
<code>(config-if)#exit</code>	Exit Interface mode.
<code>(config)#ip route 192.168.0.1/32 10.10.10.1</code> <code>(config)#ip route 192.168.0.3/32 10.10.12.3</code>	Specify the destination and mask for the network and a gateway.
<code>(config-if)#commit</code>	Commit the candidate configuration to the running configuration
<code>(config)#exit</code>	Exit configure mode

R3

<code>#configure terminal</code>	Enter configure mode.
<code>(config)#interface lo</code>	Enter interface mode.
<code>(config-if)#ip address 192.168.0.3/32 secondary</code>	Configure the IP address on this interface, and specify a 32-bit mask, making it a host address.
<code>(config-if)#commit</code>	Commit the candidate configuration to the running configuration
<code>(config-if)#exit</code>	Exit Interface mode.
<code>(config)#ip route 0.0.0.0/0 10.10.12.2</code>	Specify 10.10.12.2 as a default gateway to reach any network. Because 10.10.12.2 is the only available route, you can specify it as the default gateway instead of specifying it as the gateway for an individual network or host address.
<code>(config-if)#commit</code>	Commit the candidate configuration to the running configuration
<code>(config)#exit</code>	Exit configure mode

Validation

show ip route, show ip route summary, show ip route database

R1

```
#sh ip route
Codes: K - kernel, C - connected, S - static, R - RIP, B - BGP
       O - OSPF, IA - OSPF inter area
       N1 - OSPF NSSA external type 1, N2 - OSPF NSSA external type 2
       E1 - OSPF external type 1, E2 - OSPF external type 2
       i - IS-IS, L1 - IS-IS level-1, L2 - IS-IS level-2, ia - IS-IS inter
area
```

```

* - candidate default

IP Route Table for VRF "default"
Gateway of last resort is 10.12.4.1 to network 0.0.0.0

K*    0.0.0.0/0 [0/0] via 10.12.4.1, eth0
C     10.10.10.0/24 is directly connected, eth1
S     10.10.12.0/24 [1/0] via 10.10.10.2, eth1
C     10.12.4.0/24 is directly connected, eth0
C     127.0.0.0/8 is directly connected, lo
C     192.168.0.1/32 is directly connected, lo
S     192.168.0.2/32 [1/0] via 10.10.10.2, eth1
S     192.168.0.3/32 [1/0] via 10.10.10.2, eth1

```

```

#show ip route summary
IP routing table name is Default-IP-Routing-Table(0)
IP routing table maximum-paths      : 8
Total number of IPv4 routes         : 8
Total number of IPv4 paths          : 8
Route Source      Networks
kernel            1
connected         4
static            3
Total             8
FIB               0

```

```

ECMP statistics (active in ASIC):
-----
Total number of IPv4 ECMP routes   : 0
Total number of IPv4 ECMP paths    : 0
-----

```

```

#show ip route database
Codes: K - kernel, C - connected, S - static, R - RIP, B - BGP
       O - OSPF, IA - OSPF inter area
       N1 - OSPF NSSA external type 1, N2 - OSPF NSSA external type 2
       E1 - OSPF external type 1, E2 - OSPF external type 2
       i - IS-IS, L1 - IS-IS level-1, L2 - IS-IS level-2, ia - IS-IS inter
area
       > - selected route, * - FIB route, p - stale info

```

```

IP Route Table for VRF "default"
K    *> 0.0.0.0/0 [0/0] via 10.12.4.1, eth0
C    *> 10.10.10.0/24 is directly connected, eth1
S    *> 10.10.12.0/24 [1/0] via 10.10.10.2, eth1
C    *> 10.12.4.0/24 is directly connected, eth0
C    *> 127.0.0.0/8 is directly connected, lo
C    *> 192.168.0.1/32 is directly connected, lo
S    *> 192.168.0.2/32 [1/0] via 10.10.10.2, eth1
S    *> 192.168.0.3/32 [1/0] via 10.10.10.2, eth1

```

```

Gateway of last resort is not set

```

R2

```

#sh ip route
Codes: K - kernel, C - connected, S - static, R - RIP, B - BGP

```

Static Routes

```
O - OSPF, IA - OSPF inter area
N1 - OSPF NSSA external type 1, N2 - OSPF NSSA external type 2
E1 - OSPF external type 1, E2 - OSPF external type 2
i - IS-IS, L1 - IS-IS level-1, L2 - IS-IS level-2, ia - IS-IS inter
area
* - candidate default
```

```
IP Route Table for VRF "default"
Gateway of last resort is 10.12.4.1 to network 0.0.0.0
```

```
K*    0.0.0.0/0 [0/0] via 10.12.4.1, eth0
C     10.10.10.0/24 is directly connected, eth1
C     10.10.12.0/24 is directly connected, eth2
C     10.12.4.0/24 is directly connected, eth0
C     127.0.0.0/8 is directly connected, lo
S     192.168.0.1/32 [1/0] via 10.10.10.1, eth1
C     192.168.0.2/32 is directly connected, lo
S     192.168.0.3/32 [1/0] via 10.10.12.3, eth2
```

```
#sh ip route summary
IP routing table name is Default-IP-Routing-Table(0)
IP routing table maximum-paths      : 8
Total number of IPv4 routes         : 9
Total number of IPv4 paths          : 9
Route Source      Networks
kernel            1
connected         5
static            3
Total             9
FIB               0
```

```
ECMP statistics (active in ASIC):
-----
Total number of IPv4 ECMP routes   : 0
Total number of IPv4 ECMP paths    : 0
-----
```

```
#sh ip route database
Codes: K - kernel, C - connected, S - static, R - RIP, B - BGP
O - OSPF, IA - OSPF inter area
N1 - OSPF NSSA external type 1, N2 - OSPF NSSA external type 2
E1 - OSPF external type 1, E2 - OSPF external type 2
i - IS-IS, L1 - IS-IS level-1, L2 - IS-IS level-2, ia - IS-IS inter
area
> - selected route, * - FIB route, p - stale info
```

```
IP Route Table for VRF "default"
K    *> 0.0.0.0/0 [0/0] via 10.12.4.1, eth0
C    *> 10.10.10.0/24 is directly connected, eth1
C    *> 10.10.12.0/24 is directly connected, eth2
C    *> 10.12.4.0/24 is directly connected, eth0
C    *> 127.0.0.0/8 is directly connected, lo
S    *> 192.168.0.1/32 [1/0] via 10.10.10.1, eth1
C    *> 192.168.0.2/32 is directly connected, lo
S    *> 192.168.0.3/32 [1/0] via 10.10.12.3, eth2
```

Gateway of last resort is not set

R3

```
#sh ip route
Codes: K - kernel, C - connected, S - static, R - RIP, B - BGP
       O - OSPF, IA - OSPF inter area
       N1 - OSPF NSSA external type 1, N2 - OSPF NSSA external type 2
       E1 - OSPF external type 1, E2 - OSPF external type 2
       i - IS-IS, L1 - IS-IS level-1, L2 - IS-IS level-2, ia - IS-IS inter
area
       * - candidate default
```

```
IP Route Table for VRF "default"
Gateway of last resort is 10.12.4.1 to network 0.0.0.0
```

```
K*      0.0.0.0/0 [0/0] via 10.12.4.1, eth0
C       10.10.12.0/24 is directly connected, eth2
C       10.12.4.0/24 is directly connected, eth0
C       127.0.0.0/8 is directly connected, lo
C       192.168.0.3/32 is directly connected, lo
```

```
#sh ip route summary
IP routing table name is Default-IP-Routing-Table(0)
IP routing table maximum-paths      : 8
Total number of IPv4 routes         : 6
Total number of IPv4 paths          : 6
Route Source      Networks
kernel            2
connected         4
Total             6
FIB               0
```

```
ECMP statistics (active in ASIC):
-----
Total number of IPv4 ECMP routes   : 0
Total number of IPv4 ECMP paths    : 0
-----
```

```
#sh ip route database
Codes: K - kernel, C - connected, S - static, R - RIP, B - BGP
       O - OSPF, IA - OSPF inter area
       N1 - OSPF NSSA external type 1, N2 - OSPF NSSA external type 2
       E1 - OSPF external type 1, E2 - OSPF external type 2
       i - IS-IS, L1 - IS-IS level-1, L2 - IS-IS level-2, ia - IS-IS inter
area
       > - selected route, * - FIB route, p - stale info
```

```
IP Route Table for VRF "default"
K      *> 0.0.0.0/0 [0/0] via 10.12.4.1, eth0
S      0.0.0.0/0 [1/0] via 10.10.12.2 inactive
C      *> 10.10.12.0/24 is directly connected, eth2
C      *> 10.12.4.0/24 is directly connected, eth0
C      *> 127.0.0.0/8 is directly connected, lo
C      *> 192.168.0.3/32 is directly connected, lo
```

Gateway of last resort is not set

IPv6 Static Routing

This example shows complete configuration to enable IPv6 static routing in a simple network topology.

Note: IPv6 static route with interface alone as gateway (without gateway IPv6 address) is not supported.

Topology

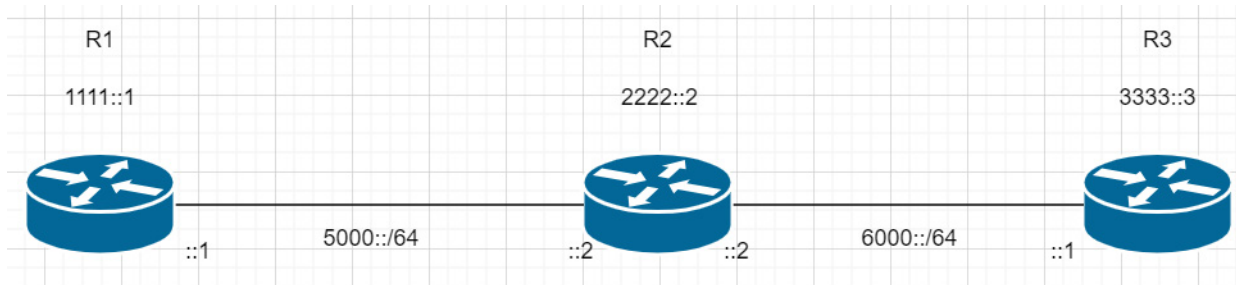

Figure 21-132: IPv6 static routing

Configuration

R1

R1#conf t	Enter Configure mode.
R1(config)#interface lo	Enter interface mode.
R1(config-if)#ipv6 address 1111::1/128	Configure IPv6 address
R1(config-if)#commit	Commit the candidate configuration to the running configuration
R1(config-if)#exit	Exit interface mode.
R1(config)#ipv6 route 6000::/64 5000::2	Configure IPv6 Static route to reach remote network with R2 as nexthop
R1(config)#ipv6 route 2222::2/128 5000::2	Configure IPv6 static route to reach R2 lo with R2 as nexthop
R1(config)#ipv6 route 3333::3/128 5000::2	Configure IPv6 static route to reach R3 lo with R2 as nexthop
R1(config)#commit	Commit the candidate configuration to the running configuration
R1(config)#exit	Exit configure mode

R2

R2#conf t	Enter Configure mode.
R2(config)#int lo	Enter interface mode.
R2(config-if)#ipv6 address 2222::2/128	Configure IPv6 address

R2(config)#commit	Commit the candidate configuration to the running configuration
R2(config)#exit	Exit configure mode
R2(config)#ipv6 route 1111::1/128 5000::1	Configure IPv6 static route to reach R1 lo with R1 as nexthop
R2(config)#ipv6 route 3333::3/128 6000::1	Configure IPv6 static route to reach R3 lo with R3 as nexthop
R2(config)#commit	Commit the candidate configuration to the running configuration
R2(config)#exit	Exit configure mode

R3

R3#conf t	Enter Configure mode.
R3(config)#int lo	Enter interface mode.
R3(config-if)#ipv6 add 3333::3/128	Configure IPv6 address
R3(config)#commit	Commit the candidate configuration to the running configuration
R3(config-if)#exit	Exit interface mode.
R3(config)#ipv6 route ::/0 6000::2	Configure Default IPv6 Static route with R2 as nexthop
R3(config)#commit	Commit the candidate configuration to the running configuration
R3(config)#exit	Exit configure mode

Validation

show ipv6 route, show ipv6 route summary, show ipv6 route database

R1

```
R1#show ipv6 route
IPv6 Routing Table
Codes: K - kernel route, C - connected, S - static, R - RIP, O - OSPF,
      IA - OSPF inter area, E1 - OSPF external type 1,
      E2 - OSPF external type 2, E - EVPN  N1 - OSPF NSSA external type 1,
      N2 - OSPF NSSA external type 2, i - IS-IS, B - BGP
Timers: Uptime

IP Route Table for VRF "default"
C      ::1/128 via ::, lo, 20:51:02
C      1111::1/128 via ::, lo, 00:01:13
S      2222::2/128 [1/0] via 5000::2, xe3, 00:00:32
S      3333::3/128 [1/0] via 5000::2, xe3, 00:00:13
C      5000::/64 via ::, xe3, 00:01:42
S      6000::/64 [1/0] via 5000::2, xe3, 00:00:54
C      fe80::/64 via ::, ce45, 01:45:19
R1#show ipv6 route summary
IPv6 routing table name is Default-IPv6-Routing-Table(0)
IPv6 routing table maximum-paths : 8
Total number of IPv6 routes      : 7
```

Static Routes

```
Total number of IPv6 paths      : 7
Pending routes (due to route max reached): 0
Route Source    Networks
connected      4
static         3
Total          7
FIB            7
```

ECMP statistics (active in ASIC):

```
-----
Total number of IPv6 ECMP routes : 0
Total number of IPv6 ECMP paths  : 0
```

```
R1#
R1#show ipv6 route database
IPv6 Routing Table
Codes: K - kernel route, C - connected, S - static, R - RIP, O - OSPF,
      IA - OSPF inter area, E1 - OSPF external type 1,
      E2 - OSPF external type 2, E - EVPN, N1 - OSPF NSSA external type 1,
      N2 - OSPF NSSA external type 2, i - IS-IS, B - BGP
      > - selected route, * - FIB route, p - stale info
Timers: Uptime
```

```
IP Route Table for VRF "default"
C   *> ::1/128 via ::, lo, 20:51:19
C   *> 1111::1/128 via ::, lo, 00:01:30
S   *> 2222::2/128 [1/0] via 5000::2, xe3, 00:00:49
S   *> 3333::3/128 [1/0] via 5000::2, xe3, 00:00:30
C   *> 5000::/64 via ::, xe3, 00:01:59
S   *> 6000::/64 [1/0] via 5000::2, xe3, 00:01:11
C   *> fe80::/64 via ::, ce45, 01:45:36
C   fe80::/64 via ::, ce44, 01:45:36
C   fe80::/64 via ::, xe39, 01:45:36
C   fe80::/64 via ::, xe32, 01:45:36
C   fe80::/64 via ::, xe29, 01:45:36
C   fe80::/64 via ::, xe13, 01:45:36
C   fe80::/64 via ::, ce46, 03:56:36
C   fe80::/64 via ::, ce43, 03:56:36
C   fe80::/64 via ::, xe25, 03:56:36
C   fe80::/64 via ::, xe23, 03:56:36
C   fe80::/64 via ::, xe3, 03:56:36
C   fe80::/64 via ::, xe34, 20:41:33
C   fe80::/64 via ::, xe33, 20:41:33
C   fe80::/64 via ::, xe36, 20:50:48
C   fe80::/64 via ::, xe22, 20:50:48
C   fe80::/64 via ::, xe21, 20:50:48
C   fe80::/64 via ::, xe10, 20:50:48
C   fe80::/64 via ::, xe9, 20:50:48
R1#
```

R2

```
R2#show ipv6 route
IPv6 Routing Table
Codes: K - kernel route, C - connected, S - static, R - RIP, O - OSPF,
      IA - OSPF inter area, E1 - OSPF external type 1,
      E2 - OSPF external type 2, E - EVPN  N1 - OSPF NSSA external type 1,
      N2 - OSPF NSSA external type 2, i - IS-IS, B - BGP
Timers: Uptime
```

```
IP Route Table for VRF "default"
C    ::1/128 via ::, lo, 03:59:56
S    1111::1/128 [1/0] via 5000::1, xe3, 00:00:46
C    2222::2/128 via ::, lo, 00:01:27
S    3333::3/128 [1/0] via 6000::1, xe5, 00:00:26
C    5000::/64 via ::, xe3, 00:01:52
C    6000::/64 via ::, xe5, 00:01:10
C    fe80::/64 via ::, vlan1.2, 01:17:00
```

```
R2#
R2#show ipv6 route summary
IPv6 routing table name is Default-IPv6-Routing-Table(0)
IPv6 routing table maximum-paths : 8
Total number of IPv6 routes      : 7
Total number of IPv6 paths       : 7
Pending routes (due to route max reached): 0
Route Source    Networks
connected       5
static          2
Total           7
FIB             7
```

```
ECMP statistics (active in ASIC):
```

```
-----
Total number of IPv6 ECMP routes : 0
Total number of IPv6 ECMP paths  : 0
```

```
R2#show ipv6 route database
IPv6 Routing Table
Codes: K - kernel route, C - connected, S - static, R - RIP, O - OSPF,
      IA - OSPF inter area, E1 - OSPF external type 1,
      E2 - OSPF external type 2, E - EVPN  N1 - OSPF NSSA external type 1,
      N2 - OSPF NSSA external type 2, i - IS-IS, B - BGP
      > - selected route, * - FIB route,p - stale info
Timers: Uptime
```

```
IP Route Table for VRF "default"
C    *> ::1/128 via ::, lo, 04:00:02
S    *> 1111::1/128 [1/0] via 5000::1, xe3, 00:00:52
C    *> 2222::2/128 via ::, lo, 00:01:33
S    *> 3333::3/128 [1/0] via 6000::1, xe5, 00:00:32
C    *> 5000::/64 via ::, xe3, 00:01:58
```

Static Routes

```
C    *> 6000::/64 via ::, xe5, 00:01:16
C    *> fe80::/64 via ::, vlan1.2, 01:17:06
C    fe80::/64 via ::, vlan1.1, 01:17:06
C    fe80::/64 via ::, xe29, 01:48:22
C    fe80::/64 via ::, xe27, 01:48:22
C    fe80::/64 via ::, ce47, 03:59:22
C    fe80::/64 via ::, ce46, 03:59:22
C    fe80::/64 via ::, ce45, 03:59:22
C    fe80::/64 via ::, ce43, 03:59:22
C    fe80::/64 via ::, xe42, 03:59:22
C    fe80::/64 via ::, xe41, 03:59:22
C    fe80::/64 via ::, xe34, 03:59:22
C    fe80::/64 via ::, xe33, 03:59:22
C    fe80::/64 via ::, xe32, 03:59:22
C    fe80::/64 via ::, xe31, 03:59:22
C    fe80::/64 via ::, xe25, 03:59:22
C    fe80::/64 via ::, xe23, 03:59:22
C    fe80::/64 via ::, xe5, 03:59:22
C    fe80::/64 via ::, xe3, 03:59:22
```

R2#

R3

R3#show ipv6 route

IPv6 Routing Table

Codes: K - kernel route, C - connected, S - static, R - RIP, O - OSPF,
IA - OSPF inter area, E1 - OSPF external type 1,
E2 - OSPF external type 2, E - EVPN N1 - OSPF NSSA external type 1,
N2 - OSPF NSSA external type 2, i - IS-IS, B - BGP

Timers: Uptime

IP Route Table for VRF "default"

```
S    ::/0 [1/0] via 6000::2, xe5, 00:00:07
C    ::1/128 via ::, lo, 20:46:35
C    3333::3/128 via ::, lo, 00:00:57
C    6000::/64 via ::, xe5, 00:00:46
C    fe80::/64 via ::, ce43, 01:50:07
```

R3#show ipv6 route summary

IPv6 routing table name is Default-IPv6-Routing-Table(0)

IPv6 routing table maximum-paths : 8

Total number of IPv6 routes : 5

Total number of IPv6 paths : 5

Pending routes (due to route max reached): 0

Route Source Networks

```
connected 4
static 1
Total 5
FIB 5
```

ECMP statistics (active in ASIC):

```
Total number of IPv6 ECMP routes    : 0
Total number of IPv6 ECMP paths     : 0
R3#
R3#show ipv6 route database
IPv6 Routing Table
Codes: K - kernel route, C - connected, S - static, R - RIP, O - OSPF,
      IA - OSPF inter area, E1 - OSPF external type 1,
      E2 - OSPF external type 2, E - EVPN  N1 - OSPF NSSA external type 1,
      N2 - OSPF NSSA external type 2, i - IS-IS, B - BGP
      > - selected route, * - FIB route,p - stale info
Timers: Uptime

IP Route Table for VRF "default"
S  *> ::/0 [1/0] via 6000::2, xe5, 00:00:18
C  *> ::1/128 via ::, lo, 20:46:46
C  *> 3333::3/128 via ::, lo, 00:01:08
C  *> 6000::/64 via ::, xe5, 00:00:57
C  *> fe80::/64 via ::, ce43, 01:50:18
C    fe80::/64 via ::, xe32, 01:50:18
C    fe80::/64 via ::, xe29, 01:50:18
C    fe80::/64 via ::, xe15, 01:50:18
C    fe80::/64 via ::, xe3, 01:50:18
C    fe80::/64 via ::, ce47, 04:01:18
C    fe80::/64 via ::, ce45, 04:01:18
C    fe80::/64 via ::, xe42, 04:01:18
C    fe80::/64 via ::, xe41, 04:01:18
C    fe80::/64 via ::, xe5, 04:01:18
C    fe80::/64 via ::, xe34, 20:46:15
C    fe80::/64 via ::, xe33, 20:46:15
C    fe80::/64 via ::, xe12, 20:46:15
C    fe80::/64 via ::, xe11, 20:46:15
```

CHAPTER 22 Static Route Discard Configuration

This chapter show how to configure the static route discard feature.

Overview

If you identify some routers/attackers distributing invalid/bogus routes just to use the resources of the device or to make the device unstable, you can configure route-map rules, discard all routes, and black hole traffic corresponding to those routes.

To so this, you add “discard” route entries for a prefix in a route map with the “set interface null0” command. You then apply that route map to a BGP neighbor.

IPv4 Route Discard

Figure 22-133 shows the configuration required to enable static route discard for IPv4.

Topology



Figure 22-133: Static route discard topology

Configuration

R1

R1#configure terminal	Enter configure mode
R1(config)#interface xe1	Enter interface mode for xe1
R1(config-if)#ip address 2.2.2.2/24	Assign an IP address to the interface
R1(config-if)#commit	Commit the candidate configuration to the running configuration
R1(config-if)#exit	Exit interface mode.
R1(config)#interface xe2	Enter interface mode for xe1
R1(config-if)#ip address 1.1.1.2/24	Assign an IP address to the interface
R1(config-if)#commit	Commit the candidate configuration to the running configuration
R1(config-if)#exit	Exit interface mode
R1(config)#router bgp 2	Enter BGP router mode
R1(config-router)#neighbor 2.2.2.3 remote-as 3	Create static BGP neighbor 2.2.2.3 with remote autonomous system value 3
R1(config-router)#redistribute connected	Advertise the connected network into BGP

Static Route Discard Configuration

R1(config-if)#commit	Commit the candidate configuration to the running configuration
R1(config-router)#end	Exit BGP router mode

R2

R2#configure terminal	Enter configure mode
R2(config)#ip prefix-list p1	Configure IP prefix list
R2(config-ip-prefix-list)#seq 5 permit any	Create an access rule to permit any IP packets
R2(config)#route-map r1	Enter route-map mode
R2(config-route-map)#match ip address prefix-list p1	Configure match ip prefix list p1
R2(config-route-map)#set interface null0	Set the interface to null0
R2(config-if)#commit	Commit the candidate configuration to the running configuration
R2(config-route-map)#exit	Exit route-map mode.
R2(config)#interface xe1	Enter interface mode for xe1
R2(config-if)#ip address 2.2.2.3/24	Assign an IP address to the interface
R2(config-if)#commit	Commit the candidate configuration to the running configuration
R2(config-if)#exit	Exit interface mode.
R2(config)#interface xe2	Enter interface mode for xe2
R2(config-if)#ip address 3.3.3.2/24	Assign an IP address to the interface
R2(config-if)#commit	Commit the candidate configuration to the running configuration
R2(config-if)#exit	Exit interface mode
R2(config)#router bgp 3	Enter into BGP router mode
R2(config-router)#neighbor 2.2.2.2 remote-as 2	Create static BGP neighbor 2.2.2.2 with remote autonomous system value 2
R2(config-router)#neighbor 3.3.3.3 remote-as 4	Create static BGP neighbor 3.3.3.3 with remote autonomous system value 4
R2(config-router)#redistribute connected	Advertise the connected network into BGP
R2(config-router)#neighbor 2.2.2.2 route-map r1 in	Attach the route-map with route discard configured for the neighbor 2.2.2.2 in IN direction
R2(config-if)#commit	Commit the candidate configuration to the running configuration
R2(config-router)#end	Exit BGP router mode

R3

R3#configure terminal	Enter configure mode.
R3(config)#interface xe2	Enter interface mode for xe2
R3(config-if)#ip address 3.3.3.3/24	Assign an IP address to the interface
R3(config-if)#commit	Commit the candidate configuration to the running configuration

R3(config-if)#exit	Exit interface mode
R3(config)#interface xe1	Enter interface mode for xe1
R3(config-if)#ip address 4.4.4.2/24	Assign an IP address to the interface
R3(config-if)#commit	Commit the candidate configuration to the running configuration
R3(config-if)#exit	Exit interface mode.
R3(config)#router bgp 4	Enter into BGP router mode
R3(config-router)#neighbor 3.3.3.2 remote-as 3	Create static BGP neighbor 3.3.3.2 with remote autonomous system value 3
R3(config-router)#redistribute connected	Advertise the connected network into BGP
R3(config-if)#commit	Commit the candidate configuration to the running configuration
R3(config-router)#end	Exit BGP router.

Validation

```
R2#show running-config bgp
```

```
!
router bgp 3
 redistribute connected
 neighbor 2.2.2.2 remote-as 2
 neighbor 2.2.2.2 route-map r1 in
 neighbor 3.3.3.3 remote-as 4
!
```

```
R2#show ip bgp
```

```
BGP table version is 3, local router ID is 2.2.2.3
Status codes: s suppressed, d damped, h history, * valid, > best, i - internal,
               l - labeled, S Stale
Origin codes: i - IGP, e - EGP, ? - incomplete
   Network        Next Hop         Metric  LocPrf   Weight    Path
*>  1.1.1.0/24     2.2.2.2           0       100      0         2 ?
*>  2.2.2.0/24     0.0.0.0           0       100     32768      ?
*      2.2.2.2           0       100      0         2 ?
*>  3.3.3.0/24     0.0.0.0           0       100     32768      ?
*      3.3.3.3           0       100      0         4 ?
*>  4.4.4.0/24     3.3.3.3           0       100      0         4 ?
Total number of prefixes 4
```

```
R2#show running-config prefix-list
```

```
!
ip prefix-list p1
 permit any
!
```

```
R2#show ip route
```

```
Codes: K - kernel, C - connected, S - static, R - RIP, B - BGP
       O - OSPF, IA - OSPF inter area
```

Static Route Discard Configuration

N1 - OSPF NSSA external type 1, N2 - OSPF NSSA external type 2
E1 - OSPF external type 1, E2 - OSPF external type 2
i - IS-IS, L1 - IS-IS level-1, L2 - IS-IS level-2, ia - IS-IS inter area,
v - vrf leaked
* - candidate default

IP Route Table for VRF "default"

```
B 1.1.1.0/24 [20/0] is a summary, Null, 00:00:01
C 2.2.2.0/24 is directly connected, xe1, 00:09:57
C 3.3.3.0/24 is directly connected, xe2, 00:09:50
B 4.4.4.0/24 [20/0] via 3.3.3.3, xe2, 00:00:03
C 127.0.0.0/8 is directly connected, lo, 01:18:30
```

Gateway of last resort is not set

R2#show hsl nh-table

IPv4 FIB 0

```
0.0.0.0, Null, 00:00:00:00:00:00, Valid ,
    1.1.1.0/24, Installed FORWARD
2.2.2.2, xe1, 00:18:23:26:16:45, Valid , lport:0x8000026, Egress object id:1
00004, refcnt 0, rulecnt 0
3.3.3.3, xe2, 00:18:23:cb:fb:b7, Valid , lport:0x800002a, Egress object id:1
00003, refcnt 1, rulecnt 0,
    4.4.4.0/24, Installed FORWARD
```

```
IPv4 FIB 1 10.12.29.1, eth0, 00:00:00:00:00:00, Invalid,
    , Not Installed TO_CPU
```

IPv6 FIB 0

IPv6 FIB 1

IPv6 Route Discard

[Figure 22-133](#) shows the configuration required to enable static route discard for IPv6.

Configuration

R1

R1#configure terminal	Enter configure mode.
R1(config)#interface lo	Enter interface mode for loopback
R1(config-if)#ip address 1.1.1.2/24 secondary	Assign an IPv4 address to the interface
R1(config-if)#commit	Commit the candidate configuration to the running configuration
R1(config-if)#exit	Exit interface mode

R1(config)#interface xe1	Enter interface mode for xe1
R1(config-if)#ipv6 address 2001::2/64	Assign an IPv6 address to the interface
R1(config-if)#commit	Commit the candidate configuration to the running configuration
R1(config-if)#exit	Exit interface mode
R1(config)#interface xe2	Enter interface mode for xe2
R1(config-if)#ipv6 address 1001::2/64	Assign an IPv6 address to the interface
R1(config-if)#commit	Commit the candidate configuration to the running configuration
R1(config-if)#exit	Exit interface mode
R1(config)#router bgp 2	Enter BGP router mode
R1(config-router)#bgp router-id 1.1.1.1	Specify router ID
R1(config-router)#neighbor 2001::3 remote-as 3	Create static BGP neighbor 2001::3 with remote autonomous system value 3
R1(config-router)#address-family ipv6 unicast	Enter address family IPv6 unicast mode
R1(config-router-af)#neighbor 2001::3 activate	Activate neighbor in IPv6 address family
R1(config-router-af)#redistribute connected	Advertise the connected network into BGP
R1(config-router-af)#commit	Commit the candidate configuration to the running configuration
R1(config-router)#end	Exit BGP router mode

R2

R2#configure terminal	Enter configure mode
R2(config)#interface lo	Enter interface mode for loopback
R2(config-if)#ip address 2.2.2.2/24 secondary	Assign an IPv4 address
R2(config-router-if)#commit	Commit the candidate configuration to the running configuration
R2(config-if)#exit	Exit interface mode
R2(config)#ipv6 prefix-list p1	Configure IPv6 prefix list.
R2(config-ipv6-prefix-list)#permit any	Create an access rule to permit any IP packets
R2(config)#route-map r1	Enter route-map mode.
R2(config-route-map)#match ipv6 address prefix-list p1	Configure match IPv6 prefix list p1
R2(config-route-map)#set interface null0	Set the interface to null0
R2(config-router-map)#commit	Commit the candidate configuration to the running configuration
R2(config-route-map)#exit	Exit route-map mode
R2(config)#interface xe1	Enter interface mode for xe1
R2(config-if)#ipv6 address 2001::3/64	Assign ipv6 address to the interface
R2(config-if)#commit	Commit the candidate configuration to the running configuration

Static Route Discard Configuration

R2(config-if)#exit	Exit interface mode
R2(config)#interface xe2	Enter interface mode for xe2
R2(config-if)#ipv6 address 3001::2/64	Assign an IPv6 address to the interface
R2(config-if)#commit	Commit the candidate configuration to the running configuration
R2(config-if)#exit	Exit interface mode
R2(config)#router bgp 3	Enter BGP router mode
R2(config-router)#bgp router-id 2.2.2.2	Specify router ID
R2(config-router)#neighbor 2001::2 remote-as 2	Create static BGP neighbor 2001::2 with remote autonomous system value 2
R2(config-router)#neighbor 3001::3 remote-as 4	Create static BGP neighbor 3001::3 with remote autonomous system value 4
R2(config-router)#address-family ipv6 unicast	Enter address family IPv6 unicast mode
R2(config-router-af)#redistribute connected	Advertise the connected network into BGP
R2(config-router-af)#neighbor 2001::2 activate	Activate the neighbor in IPv6 address family
R2(config-router-af)#neighbor 3001::3 activate	Activate the neighbor in IPv6 address family
R2(config-router-af)#neighbor 2001::2 route-map r1 in	Attach the route-map with route discard configured for the neighbor 2001::2 in IN direction
R2(config-router-af)#commit	Commit the candidate configuration to the running configuration
R2(config-router-af)#end	Exit BGP router mode

R3

R3#configure terminal	Enter configure mode
R3(config)#interface lo	Enter interface mode for loopback
R3(config-if)#ip address 3.3.3.2/24 secondary	Assign an IPv4 address to the interface
R3(config-if)#commit	Commit the candidate configuration to the running configuration
R3(config-if)#exit	Exit interface mode
R3(config)#interface xe1	Enter interface mode for xe1
R3(config-if)#ipv6 address 4001::2/64	Assign an IPv6 address to the interface
R3(config-if)#commit	Commit the candidate configuration to the running configuration
R3(config-if)#exit	Exit interface mode
R3(config)#interface xe2	Enter interface mode for xe2
R3(config-if)#ipv6 address 3001::3/64	Assign an IPv6 address to the interface
R3(config-if)#commit	Commit the candidate configuration to the running configuration
R3(config-if)#exit	Exit interface mode
R3(config)#router bgp 4	Enter into BGP router mode
R3(config-router)#bgp router-id 3.3.3.3	Specify router ID

R3(config-router)#neighbor 3001::2 remote-as 3	Create static BGP neighbor 3001::2 with remote autonomous system value 3
R3(config-router)#address-family ipv6 unicast	Enter address family IPv6 unicast mode
R3(config-router-af)#neighbor 3001::2 activate	Activate neighbor in IPv6 address family
R3(config-router-af)#redistribute connected	Advertise the connected network into BGP
R3(config-router-af)#commit	Commit the candidate configuration to the running configuration
R3(config-router-af)#end	Exit BGP router mode.

Validation

```
R2#show running-config bgp
```

```
!
router bgp 3
  bgp router-id 2.2.2.2
  neighbor 2001::2 remote-as 2
  neighbor 3001::3 remote-as 4
  !
  address-family ipv6 unicast
  redistribute connected
  neighbor 2001::2 activate
  neighbor 2001::2 route-map r1 in
  neighbor 3001::3 activate
  exit-address-family
!
```

```
R2#show bgp ipv6
```

```
BGP table version is 3, local router ID is 2.2.2.3
Status codes: s suppressed, d damped, h history, * valid, > best, i - internal,
               l - labeled, S Stale
Origin codes: i - IGP, e - EGP, ? - incomplete
```

Network	Next Hop	Metric	LocPrf	Weight	Path
*> 1001::/64	2001::2 (fe80::218:23ff:fede:eecf)	0	100	0	2?
*> 2001::/64	::	0	100	32768	?
*	2001::2 (fe80::218:23ff:fede:eecf)	0	100	0	2?
*> 3001::/64	::	0	100	32768	?
*	3001::3 (fe80::eef4:bbff:fe84:781b)	0	100	0	4? *> 4001::/64
64 3001::3 (fe80::eef4:bbff:fe84:781b)	0	100	0	4?	

```
Total number of prefixes 4
```

```
R2#show running-config ipv6 prefix-list
```

```
!
ipv6 prefix-list p1
  seq 5 permit any
```

Static Route Discard Configuration

```
!  
  
R2#  
  
R2#show ipv6 route  
IPv6 Routing Table  
Codes: K - kernel route, C - connected, S - static, R - RIP, O - OSPF,  
       IA - OSPF inter area, E1 - OSPF external type 1,  
       E2 - OSPF external type 2, N1 - OSPF NSSA external type 1,  
       N2 - OSPF NSSA external type 2, I - IS-IS, B - BGP  
Timers: Uptime  
  
IP Route Table for VRF "default"  
C      ::1/128 via ::, lo, 00:56:44  
B      1001::/64 [20/0] via ::, Null, 00:00:04  
C      2001::/64 via ::, xe1, 00:13:03  
C      3001::/64 via ::, xe2, 00:12:56  
B      4001::/64 [20/0] via fe80::eef4:bbff:fe84:781b, xe50, 00:00:02  
C      fe80::/64 via ::, xe50, 00:46:14  
  
R2#show hsl nh-table  
IPv4 FIB 0  
  
IPv4 FIB 1  
10.12.29.1, eth0, 00:00:00:00:00:00, Invalid,  
                , Not Installed TO_CPU  
  
IPv6 FIB 0  
    , Null, 00:00:00:00:00:00, Valid ,  
                1001::/64, Installed FORWARD  
2001::2, xe1, 00:18:23:de:ee:cf, Valid , lport:0x8000034, Egress object id:100003,  
refcnt 0, rulecnt 0  
3001::3, xe2, ec:f4:bb:84:78:1b, Valid , lport:0x8000032, Egress object id:100004,  
refcnt 0, rulecnt 0  
fe80::218:23ff:fede:ee:cf, xe52, 00:18:23:de:ee:cf, Valid , lport:0x8000034, Egress  
object id:100003, refcn  
t 0, rulecnt 0  
fe80::eef4:bbff:fe84:781b, xe50, ec:f4:bb:84:78:1b, Valid , lport:0x8000032, Egress  
object id:100004, refc  
nt 1, rulecnt 0,  
                4001::/64, Installed FORWARD  
  
IPv6 FIB 1
```

CHAPTER 23 Static Route Object Tracking using IP SLA

This feature is used to track the state of an object for reachability using IP SLA. A client process such as Virtual Router Redundancy Protocol (VRRP), or RIB, can register its interest in tracking objects and then be notified when a state change occurs.

IP SLA (Service-Level Assurance) is a performance measurement protocol. The protocol is used to Analyze IP Service Levels for IP applications and services. IP SLAs uses active traffic-monitoring technology to monitor continuous traffic on the network.

IP SLA uses Internet Control Message Protocol (ICMP) pings to identify a link failure and notifies to the clients that are registered for tracking.

The Object Tracking feature provides complete separation between the objects to be tracked and the action to be taken by a client when a tracked object state changes. Thus, several clients such as VRRP, or RIB can register their interest with the tracking process, track the same object, and each take different action when the object changes. The Tracking feature will be present in OAMD.

Each tracked object is identified by a unique number that is specified in the tracking command. Client processes use this number to track a specific object.

The tracking process processes events from the tracked objects and notes any change of value. The changes in the tracked object are communicated to interested client processes, either immediately or after a specified delay. The object values are reported as either up or down.

Topology

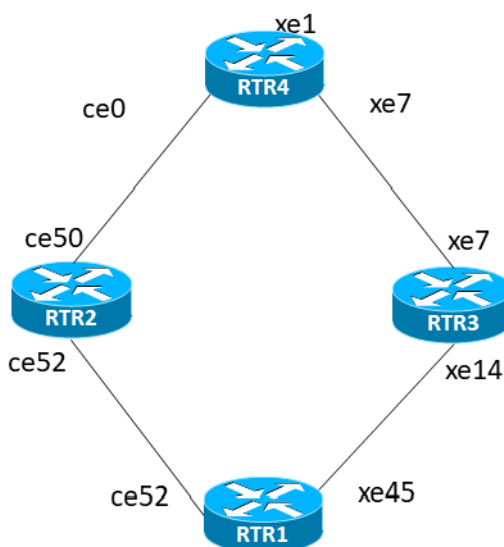

Figure 23-134: Static Route Object Tracking

Configuration

R1

R1#conf t	Enter Configure mode.
R1(config)#interface ce52	Enter interface mode.
R1(config-if)#ip address 2.2.2.1/24	Configure IPv4 address
R1(config-if)# interface ce0	Enter interface mode.
R1(config-if)#ip address 4.4.4.1/24	Configure IPv4 address
R1(config)#ip sla 1	Configure IP SLA with a unique no
R1(config)#icmp-echo ipv4 2.2.2.2 source-interface ce52	Configure the icmp-echo using destination Ip Address and source interface name
R1(config-ip-sla-echo)#threshold 1000	Configure the threshold value
R1(config-ip-sla-echo)#timeout 1000	Configure the Timeout value
R1(config-ip-sla-echo)#frequency 5	Configure the frequency value
R1(config)#time-range tr1	Configure a time-range
R1(config-tr)#start-time 11:22 3 july 2021	Configure a start-time
R1(config-tr)#end-time after 200	Configure end-time
R1(config)#ip sla schedule 1 time-range tr1	Schedule a IP SLA measurement
R1(config)# track 1 ip sla 1 reachability	Configure the Track for IP SLA
R1(config)#ip route 3.3.3.0/24 2.2.2.2 track 1	Configure the static route with the nexthop address.
R1(config)#ip route 5.5.5.0/24 4.4.4.2	Configure the static route with the nexthop address.
R1(config)#ip route 6.6.6.0/24 2.2.2.2 track 1	Configure the static route with the nexthop address.
R1(config)#ip route 6.6.6.0/24 4.4.4.2 10	Configure the static route with the nexthop address with some delay
R1(config)#commit	Commit the candidate configuration to the running configuration
R1(config)#exit	Exit configure mode

R2

R2#conf t	Enter Configure mode.
R2(config)#int ce50	Enter interface mode.
R2(config-if)#ip address 3.3.3.1/24	Configure IPv4 address
R2(config)#int ce52	Enter interface mode.
R2(config-if)#ip address 2.2.2.2/24	Configure IPv4 address
R2(config)#ip route 6.6.6.0/24 3.3.3.2	Configure the static route with the nexthop address.

R2(config)#commit	Commit the candidate configuration to the running configuration
R2(config)#exit	Exit configure mode

R3

R3#conf t	Enter Configure mode.
R3(config)#int xe7	Enter interface mode.
R3(config-if)#ip address 5.5.5.1/24	Configure IPv4 address
R3(config)#int xe14	Enter interface mode.
R3(config-if)#ip address 4.4.4.2/24	Configure IPv4 address
R3(config)#commit	Commit the candidate configuration to the running configuration
R3(config-if)#exit	Exit interface mode.
R3(config)#ip route 6.6.6.0/24 5.5.5.2	Configure the static route with the nexthop address.
R3(config)#commit	Commit the candidate configuration to the running configuration
R3(config)#exit	Exit configure mode

R4

R4#conf t	Enter Configure mode.
R4(config)#interface ce0	Enter interface mode.
R4(config-if)#ip address 3.3.3.2/24	Configure IPv4 address
R4(config)#interface xe1	Enter interface mode.
R4(config-if)#ip address 6.6.6.6/24	Configure IPv4 address
R4(config)#interface xe7	Enter interface mode.
R4(config-if)#ip address 5.5.5.2/24	Configure IPv4 address
R4(config-if)#commit	Commit the candidate configuration to the running configuration
R4(config-if)#exit	Exit interface mode.
R4(config)#ip route 2.2.2.0/24 3.3.3.1	Configure the static route with the nexthop address.
R4(config)#ip route 4.4.4.0/24 5.5.5.1	Configure the static route with the nexthop address.
R4(config)#commit	Commit the candidate configuration to the running configuration
R1(config)#exit	Exit configure mode

Validation

```
R1#sh track
TRACK Id: 1
  IP SLA 1 reachability
  Reachability is UP
  4 changes, last change : 2019 Mar 14 14:53:47
```

Static Route Object Tracking using IP SLA

```
R1#sh ip route track-table
ip route 3.3.3.0 255.255.255.0 2.2.2.2 track 1 state is [up]
ip route 6.6.6.0 255.255.255.0 2.2.2.2 track 1 state is [up]
```

```
R1#sh ip route
```

```
Codes: K - kernel, C - connected, S - static, R - RIP, B - BGP
       O - OSPF, IA - OSPF inter area
       N1 - OSPF NSSA external type 1, N2 - OSPF NSSA external type 2
       E1 - OSPF external type 1, E2 - OSPF external type 2
       i - IS-IS, L1 - IS-IS level-1, L2 - IS-IS level-2,
       ia - IS-IS inter area, E - EVPN,
       v - vrf leaked
       * - candidate default
```

```
IP Route Table for VRF "default"
```

```
C          1.1.1.0/24 is directly connected, xe1, 00:55:39
C          2.2.2.0/24 is directly connected, ce52, 00:55:38
S          3.3.3.0/24 [1/0] via 2.2.2.2, ce52, 00:00:03
C          4.4.4.0/24 is directly connected, xe45, 00:49:50
S          5.5.5.0/24 [1/0] via 4.4.4.2, xe45, 00:08:12
S          6.6.6.0/24 [1/0] via 2.2.2.2, ce52, 00:00:03
C          127.0.0.0/8 is directly connected, lo, 6d23h24m
```

```
Gateway of last resort is not set
```

```
RTR2
```

```
=====
```

```
R2#sh running-config interface ce52
```

```
!
interface ce52
 ip address 2.2.2.2/24
!
```

```
R2#conf t
```

```
Enter configuration commands, one per line.  End with CNTL/Z.
```

```
R2(config)#int ce52
R2(config-if)#no ip address
R2(config-if)#commit
```

```
R1#sh ip route track-table 2019 Mar 14 14:55:14.350 : R1 : OAM : CRITI :
[IPSLA_ICMP_ECHO_THRESHOLD_CROSSED_2]: IP SLA 1, response packet 15 exceeds the
threshold 10000 ms
2019 Mar 14 14:55:14.351 : R1 : OAM : CRITI : [IPSLA_ICMP_ECHO_TIMEOUT_2]: IP SLA 1,
response packet 15 exceeds the timeout 10000 ms
2019 Mar 14 14:55:14.351 : R1 : OAM : CRITI : [IPSLA_ICMP_ECHO_DISCONNECT_2]: Stopping
IP SLA measurement for sla(1) as timeout(10000) observed for packet(15)
```

```
ip route 3.3.3.0 255.255.255.0 2.2.2.2 track 1 state is [down]
ip route 6.6.6.0 255.255.255.0 2.2.2.2 track 1 state is [down]
```



```

R1#sh track
TRACK Id: 1
  IP SLA 1 reachability
  Reachability is DOWN
    5 changes, last change : 2019 Mar 14 14:55:14
R1#2019 Mar 14 14:55:19.352 : R1 : OAM : CRITI : [IPSLA_ICMP_ECHO_THRESHOLD_CROSSED_2]:
IP SLA 1, response packet 16 exceeds the threshold 10000 ms
2019 Mar 14 14:55:19.353 : R1 : OAM : CRITI : [IPSLA_ICMP_ECHO_TIMEOUT_2]: IP SLA 1,
response packet 16 exceeds the timeout 10000 ms
2019 Mar 14 14:55:19.353 : R1 : OAM : CRITI : [IPSLA_ICMP_ECHO_DISCONNECT_2]: Stopping
IP SLA measurement for sla(1) as timeout(10000) observed for packet(16)
sh ip route
Codes: K - kernel, C - connected, S - static, R - RIP, B - BGP
       O - OSPF, IA - OSPF inter area
       N1 - OSPF NSSA external type 1, N2 - OSPF NSSA external type 2
       E1 - OSPF external type 1, E2 - OSPF external type 2
       i - IS-IS, L1 - IS-IS level-1, L2 - IS-IS level-2,
       ia - IS-IS inter area, E - EVPN,
       v - vrf leaked
       * - candidate default

IP Route Table for VRF "default"
C      1.1.1.0/24 is directly connected, xe1, 00:56:16
C      2.2.2.0/24 is directly connected, ce52, 00:56:15
C      4.4.4.0/24 is directly connected, xe45, 00:50:27
S      5.5.5.0/24 [1/0] via 4.4.4.2, xe45, 00:08:49
S      6.6.6.0/24 [10/0] via 4.4.4.2, xe45, 00:00:07
C      127.0.0.0/8 is directly connected, lo, 6d23h24m

Gateway of last resort is not set

R1#ping 6.6.6.6
Press CTRL+C to exit
PING 6.6.6.6 (6.6.6.6) 56(84) bytes of data.
64 bytes from 6.6.6.6: icmp_seq=1 ttl=63 time=0.713 ms
64 bytes from 6.6.6.6: icmp_seq=2 ttl=63 time=0.658 ms
64 bytes from 6.6.6.6: icmp_seq=3 ttl=63 time=0.531 ms
64 bytes from 6.6.6.6: icmp_seq=4 ttl=63 time=0.505 ms

sh ip route database
Codes: K - kernel, C - connected, S - static, R - RIP, B - BGP
       O - OSPF, IA - OSPF inter area
       N1 - OSPF NSSA external type 1, N2 - OSPF NSSA external type 2
       E1 - OSPF external type 1, E2 - OSPF external type 2
       i - IS-IS, L1 - IS-IS level-1, L2 - IS-IS level-2,
       ia - IS-IS inter area, E - EVPN,
       v - vrf leaked
       > - selected route, * - FIB route, p - stale info

IP Route Table for VRF "default"
C      *> 1.1.1.0/24 is directly connected, xe1, 00:56:58

```

Static Route Object Tracking using IP SLA

```
C *> 2.2.2.0/24 is directly connected, ce52, 00:56:57
S     3.3.3.0/24 [1/0] via 2.2.2.2, ce52, 00:01:22
C *> 4.4.4.0/24 is directly connected, xe45, 00:51:09
S *> 5.5.5.0/24 [1/0] via 4.4.4.2, xe45, 00:09:31
S *> 6.6.6.0/24 [10/0] via 4.4.4.2, xe45, 00:00:49
S     6.6.6.0/24 [1/0] via 2.2.2.2, ce52, 00:01:22
C *> 127.0.0.0/8 is directly connected, lo, 6d23h25m
```

```
R1#sh ip sla summary
IP SLA Operation Summary
Codes: * active, ^ inactive
```

ID	Type	Destination	Stats (usec)	Return Code	Last Run
*1	icmp-echo	2.2.2.2	14000	OK	2019 Mar 14 14:56:26

```
RTR2(5014)
```

```
=====
R2#conf t
Enter configuration commands, one per line. End with CNTL/Z.
R2(config)#int ce52
R2(config-if)#ip address 2.2.2.2/24
R2(config-if)#commit
```

```
R1#sh track
TRACK Id: 1
  IP SLA 1 reachability
  Reachability is UP
  10 changes, last change : 2019 Mar 14 14:56:32
```

```
R1#sh ip route track-table
ip route 3.3.3.0 255.255.255.0 2.2.2.2 track 1 state is [up]
ip route 6.6.6.0 255.255.255.0 2.2.2.2 track 1 state is [up]
```

```
R1#sh ip route
Codes: K - kernel, C - connected, S - static, R - RIP, B - BGP
       O - OSPF, IA - OSPF inter area
       N1 - OSPF NSSA external type 1, N2 - OSPF NSSA external type 2
       E1 - OSPF external type 1, E2 - OSPF external type 2
       i - IS-IS, L1 - IS-IS level-1, L2 - IS-IS level-2,
       ia - IS-IS inter area, E - EVPN,
       v - vrf leaked
       * - candidate default
```

```
IP Route Table for VRF "default"
```

```
C     1.1.1.0/24 is directly connected, xe1, 00:57:39
C     2.2.2.0/24 is directly connected, ce52, 00:57:38
S     3.3.3.0/24 [1/0] via 2.2.2.2, ce52, 00:00:11
```

```
C      4.4.4.0/24 is directly connected, xe45, 00:51:50
S      5.5.5.0/24 [1/0] via 4.4.4.2, xe45, 00:10:12
S      6.6.6.0/24 [1/0] via 2.2.2.2, ce52, 00:00:11
C      127.0.0.0/8 is directly connected, lo, 6d23h26m
```

```
R1#sh ip route database
```

```
Codes: K - kernel, C - connected, S - static, R - RIP, B - BGP
       O - OSPF, IA - OSPF inter area
       N1 - OSPF NSSA external type 1, N2 - OSPF NSSA external type 2
       E1 - OSPF external type 1, E2 - OSPF external type 2
       i - IS-IS, L1 - IS-IS level-1, L2 - IS-IS level-2,
       ia - IS-IS inter area, E - EVPN,
       v - vrf leaked
       > - selected route, * - FIB route, p - stale info
```

```
IP Route Table for VRF "default"
```

```
C      *> 1.1.1.0/24 is directly connected, xe1, 01:14:49
C      *> 2.2.2.0/24 is directly connected, ce52, 01:14:48
S      *> 3.3.3.0/24 [1/0] via 2.2.2.2, ce52, 00:17:21
C      *> 4.4.4.0/24 is directly connected, xe45, 01:09:00
S      *> 5.5.5.0/24 [1/0] via 4.4.4.2, xe45, 00:27:22
S      *> 6.6.6.0/24 [1/0] via 2.2.2.2, ce52, 00:17:21
S      6.6.6.0/24 [10/0] via 4.4.4.2, xe45, 00:17:25
C      *> 127.0.0.0/8 is directly connected, lo, 6d23h43m
```

CHAPTER 24 RIP

This chapter contains basic Router Information Protocol (RIP) configuration examples.

Enable RIP

This example shows the minimum configuration required to enable RIP on an interface. R1 and R2 are two routers connecting to network 10.10.11.0/24. R1 and R2 are also connected to networks 10.10.10.0/24 and 10.10.12.0/24, respectively. To enable RIP, first define the RIP routing process, then associate a network with the routing process.

Topology

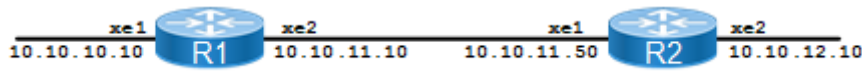

Figure 24-135: Enable RIP Topology

R1

#configure terminal	Enter configure mode.
(config)#router rip	Define a RIP routing process, and enter Router mode.
(config-router)#network 10.10.10.0/24	Associate networks with the RIP process.
(config-router)#network 10.10.11.0/24	
(config-router)#exit	Exit router mode and return to configure mode.
(config)#commit	Commit the candidate configuration to the running configuration

R2

#configure terminal	Enter configure mode.
(config)#router rip	Define a RIP routing process, and enter Router mode.
(config-router)#network 10.10.11.0/24	Associate networks with the RIP process.
(config-router)#network 10.10.12.0/24	
(config-router)#exit	Exit router mode and return to configure mode.
(config)#commit	Commit the candidate configuration to the running configuration

Validation

show ip rip, show running-config, show ip protocols rip, show ip rip interface, show ip route

R1

```
#show ip rip
```

```
Codes: R - RIP, Rc - RIP connected, Rs - RIP static, K - Kernel,
       C - Connected, S - Static, O - OSPF, I - IS-IS, B - BGP,
```

X - Default

	Network	Next Hop	Metric	From	If	Time
Rc	10.10.10.0/24		1		xe1	
Rc	10.10.11.0/24		1		xe2	
R	10.10.12.0/24	10.10.11.50	2	10.10.11.50	xe2	02:32

```
#show running-config rip
```

```
!  
router rip  
  network 10.10.10.0/24  
  network 10.10.11.0/24  
!
```

```
#show ip protocols rip
```

```
RIP Database for VRF (default)
```

```
Routing Protocol is "rip"
```

```
  Sending updates every 30 seconds with +/-50%, next due in 2 seconds
```

```
  Timeout after 180 seconds, garbage collect after 120 seconds
```

```
  Outgoing update filter list for all interface is not set
```

```
  Incoming update filter list for all interface is not set
```

```
  Default redistribution metric is 1
```

```
  Redistributing:
```

```
  Default version control: send version 2, receive version 2
```

```
    Interface      Send  Recv  Key-chain
```

```
    xe48            2     2
```

```
    ce49            2     2
```

```
Routing for Networks:
```

```
  10.10.10.0/24
```

```
  10.10.11.0/24
```

```
Routing Information Sources:
```

```
  Gateway          Distance  Last Update  Bad Packets  Bad Routes
```

```
  10.10.11.50      120      00:00:06    0            0
```

```
Number of routes (including connected): 3
```

```
Distance: (default is 120)
```

```
#show ip rip interface
```

```
lo is up, line protocol is up
```

```
  RIP is not enabled on this interface
```

```
eth0 is up, line protocol is up
```

```
  RIP is not enabled on this interface
```

```
xe1 is up, line protocol is up
```

```
  Routing Protocol: RIP
```

```
    Receive RIP packets
```

```
    Send RIP packets
```

```
    Passive interface: Disabled
```

```
    Split horizon: Enabled with Poisoned Reversed
```

```
    IP interface address:
```

```
      10.10.10.10/24
```

```
xe2 is up, line protocol is up
```

```
  Routing Protocol: RIP
```

```
    Receive RIP packets
```

```
    Send RIP packets
```

```
    Passive interface: Disabled
```

```
    Split horizon: Enabled with Poisoned Reversed
```

```
    IP interface address:
```

```
      10.10.11.10/24
```

```
xe3 is up, line protocol is up
  RIP is not enabled on this interface
...
```

```
#show ip route
```

```
Codes: K - kernel, C - connected, S - static, R - RIP, B - BGP
       O - OSPF, IA - OSPF inter area
       N1 - OSPF NSSA external type 1, N2 - OSPF NSSA external type 2
       E1 - OSPF external type 1, E2 - OSPF external type 2
       i - IS-IS, L1 - IS-IS level-1, L2 - IS-IS level-2,
       ia - IS-IS inter area, E - EVPN,
       v - vrf leaked
       * - candidate default
```

```
IP Route Table for VRF "default"
```

```
C       10.10.10.0/24 is directly connected, xe1, 00:08:01
C       10.10.11.0/24 is directly connected, xe2, 00:07:34
R       10.10.12.0/24 [120/2] via 10.10.11.50, xe2, 00:05:10
C       127.0.0.0/8 is directly connected, lo, 4d18h40m
C       192.168.0.2/32 is directly connected, lo, 4d13h46m
```

```
Gateway of last resort is not set
```

R2

```
#show ip rip
```

```
Codes: R - RIP, Rc - RIP connected, Rs - RIP static, K - Kernel,
       C - Connected, S - Static, O - OSPF, I - IS-IS, B - BGP,
       X - Default
```

	Network	Next Hop	Metric	From	If	Time
R	10.10.10.0/24	10.10.11.10	2	10.10.11.10	xe1	02:34
Rc	10.10.11.0/24		1		xe1	
Rc	10.10.12.0/24		1		xe2	

```
#show running-config rip
```

```
!
router rip
  network 10.10.11.0/24
  network 10.10.12.0/24
!
```

```
#show ip protocols rip
```

```
RIP Database for VRF (default)
```

```
Routing Protocol is "rip"
```

```
  Sending updates every 30 seconds with +/-50%, next due in 25 seconds
```

```
  Timeout after 180 seconds, garbage collect after 120 seconds
```

```
  Outgoing update filter list for all interface is not set
```

```
  Incoming update filter list for all interface is not set
```

```
  Default redistribution metric is 1
```

```
  Redistributing:
```

```
  Default version control: send version 2, receive version 2
```

Interface	Send	Recv	Key-chain
xe2	2	2	
ce49	2	2	

```
  Routing for Networks:
```

```
10.10.11.0/24
10.10.12.0/24
Routing Information Sources:
  Gateway         Distance  Last Update  Bad Packets  Bad Routes
  10.10.11.10      120      00:00:13    0            0
Number of routes (including connected): 3
Distance: (default is 120)

#show ip rip interface
lo is up, line protocol is up
  RIP is not enabled on this interface
eth0 is up, line protocol is up
  RIP is not enabled on this interface
xe1 is up, line protocol is up
  Routing Protocol: RIP
    Receive RIP packets
    Send RIP packets
    Passive interface: Disabled
    Split horizon: Enabled with Poisoned Reversed
    IP interface address:
      10.10.11.50/24
xe2 is up, line protocol is up
  Routing Protocol: RIP
    Receive RIP packets
    Send RIP packets
    Passive interface: Disabled
    Split horizon: Enabled with Poisoned Reversed
    IP interface address:
      10.10.12.10/24
xe3 is up, line protocol is up
  RIP is not enabled on this interface
...

#show ip route
Codes: K - kernel, C - connected, S - static, R - RIP, B - BGP
       O - OSPF, IA - OSPF inter area
       N1 - OSPF NSSA external type 1, N2 - OSPF NSSA external type 2
       E1 - OSPF external type 1, E2 - OSPF external type 2
       i - IS-IS, L1 - IS-IS level-1, L2 - IS-IS level-2,
       ia - IS-IS inter area, E - EVPN,
       v - vrf leaked
       * - candidate default

IP Route Table for VRF "default"
R      10.10.10.0/24 [120/2] via 10.10.11.10, xe1, 00:11:08
C      10.10.11.0/24 is directly connected, xe1, 00:13:00
C      10.10.12.0/24 is directly connected, xe2, 00:12:26
C      127.0.0.0/8 is directly connected, lo, 4d18h50m
C      192.168.0.1/32 is directly connected, lo, 4d14h01m

Gateway of last resort is not set
```

Specify RIP Version

Configure a router to receive and send specific versions of packets on an interface. In this example, router R2 is configured to receive and send RIP version 1 and version 2 information on both eth1 and eth2 interfaces.

Topology

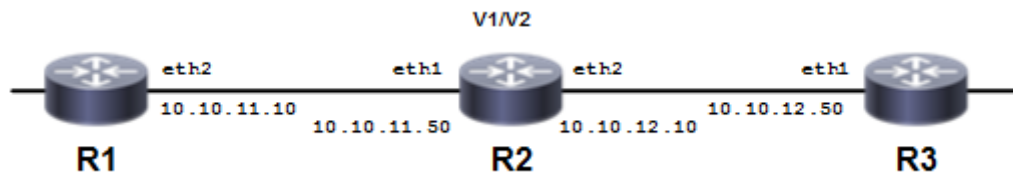

Figure 24-136: RIP Version Topology

R2

#configure terminal	Enter configure mode
(config)#router rip	Enable the RIP routing process
(config-router)#exit	Exit router mode
(config)#interface eth1	Enter interface mode
(config-if)#ip rip send version 1 2	Send RIP version 1 and version 2 packets out this interface
(config-if)#ip rip receive version 1 2	Receive RIP version 1 and version 2 packets from this interface
(config-if)#exit	Exit interface mode
(config)#commit	Commit the candidate configuration to the running configuration
(config)#interface eth2	Enter interface mode
(config-if)#ip rip send version 1 2	Send RIP version 1 and version 2 packets out this interface
(config-if)#ip rip receive version 1 2	Receive RIP version 1 and version 2 packets from this interface
(config-if)#exit	Exit router mode and return to configure mode.
(config)#commit	Commit the candidate configuration to the running configuration

Validation

R2

```
#sh ip rip
```

```
Codes: R - RIP, Rc - RIP connected, Rs - RIP static, K - Kernel,
       C - Connected, S - Static, O - OSPF, I - IS-IS, B - BGP,
       X - Default
```

```

Network          Next Hop          Metric From          If          Time
Rc 10.10.11.0/24  10.10.11.50      1             eth1
Rc 10.10.12.0/24  10.10.12.10     1             eth2

```

```
#sh running-config
!
no service password-encryption
!
logging monitor 7
!
ip vrf management
!
ip domain-lookup
spanning-tree mode provider-rstp
data-center-bridging enable
feature telnet
feature ssh
no feature tacacs+
snmp-server view all .1 included
ntp enable
sFlow disable
software-watchdog keep-alive-time 30
!
ip pim register-rp-reachability
!
interface lo
  mtu 65536
  ip address 127.0.0.1/8
  ip address 192.168.0.2/32 secondary
  ipv6 address ::1/128
!
interface eth0
  ip address 10.12.4.108/24
!
interface eth1
  ip address 10.10.11.50/24
  ip rip send version 1 2
  ip rip receive version 1 2
!
interface eth2
  ip address 10.10.12.10/24
  ip rip send version 1 2
  ip rip receive version 1 2
!
router rip
  network 10.10.11.0/24
  network 10.10.12.0/24
!
line con 0
  login
line vty 0 39
  login
!
end

#show ip protocols rip
RIP Database for VRF (default)
Routing Protocol is "rip"
  Sending updates every 30 seconds with +/-50%, next due in 29 seconds
  Timeout after 180 seconds, garbage collect after 120 seconds
  Outgoing update filter list for all interface is not set
```

```

Incoming update filter list for all interface is not set
Default redistribution metric is 1
Redistributing:
Default version control: send version 2, receive version 2
Interface          Send Recv  Key-chain
eth1                1 2    1 2
eth2                1 2    1 2
Routing for Networks:
10.10.11.0/24
10.10.12.0/24
Routing Information Sources:
Gateway            Distance  Last Update  Bad Packets  Bad Routes
10.10.11.10        120      00:00:31     0             0
10.10.12.50        120      00:00:08     0             0
Number of routes (including connected): 2
Distance: (default is 120)

```

```

#show ip rip interface
svlan0.1 is down, line protocol is down
RIP is not enabled on this interface
eth2 is up, line protocol is up
Routing Protocol: RIP
Receive RIPv1 and RIPv2 packets
Send RIPv1 and RIPv2 packets
Passive interface: Disabled
Split horizon: Enabled with Poisoned Reversed
IP interface address:
10.10.12.10/24
eth1 is up, line protocol is up
Routing Protocol: RIP
Receive RIPv1 and RIPv2 packets
Send RIPv1 and RIPv2 packets
Passive interface: Disabled
Split horizon: Enabled with Poisoned Reversed
IP interface address:
10.10.11.50/24
eth0 is up, line protocol is up
RIP is not enabled on this interface
lo is up, line protocol is up
RIP is not enabled on this interface

```

```

#show ip route
Codes: K - kernel, C - connected, S - static, R - RIP, B - BGP
O - OSPF, IA - OSPF inter area
N1 - OSPF NSSA external type 1, N2 - OSPF NSSA external type 2
E1 - OSPF external type 1, E2 - OSPF external type 2
i - IS-IS, L1 - IS-IS level-1, L2 - IS-IS level-2,
ia - IS-IS inter area, E - EVPN,
v - vrf leaked
* - candidate default

```

```

IP Route Table for VRF "default"
C      10.10.11.0/24 is directly connected, eth1, 00:04:22
C      10.10.12.0/24 is directly connected, eth2, 00:10:59
C      127.0.0.0/8 is directly connected, lo, 4d19h04m
C      192.168.0.1/32 is directly connected, lo, 4d14h15m

```

Authentication with a Single Key

OcNOS RIP provides a choice of configuring authentication with a single key or with multiple keys. This example shows authenticating routing information exchange using a single key.

Topology

Routers R1 and R2 are running RIP and exchanging routing updates. To configure single-key authentication on R1, specify an interface, then define a key or password for that interface. Next, specify an authentication mode. Any receiving RIP packet on this specified interface should have the same string as the password. For an exchange of updates between R1 and R2, define the same password and authentication mode on R2.

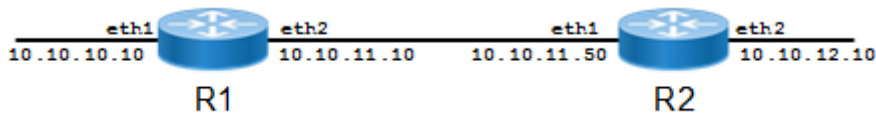

Figure 24-137: Single-key Topology

R1

#configure terminal	Enter configure mode.
(config)#router rip	Define a RIP routing process, and enter Router mode.
(config-router)#network 10.10.10.0/24	Associate network 10.10.10.0/24 with the RIP process.
(config-router)#redistribute connected	Enable redistributing from connected routes.
(config-router)#exit	Exit router mode.
(config)#commit	Commit the candidate configuration to the running configuration
(config)#interface eth1	Specify the interface (eth1) for authentication.
(config-if)#ip rip authentication string ABC	Specify the authentication string (ABC) for this interface.
(config-if)#ip rip authentication mode md5	Specify the authentication mode to be MD5.
(config-if)#exit	Exit router mode and return to configure mode.
(config)#commit	Commit the candidate configuration to the running configuration

R2

#configure terminal	Enter configure mode.
(config)#router rip	Define a RIP routing process, and enter Router mode.
(config-router)#network 10.10.11.0/24	Associate network 10.10.11.0/24 with the RIP process.
(config-router)#redistribute connected	Enable redistributing from connected routes.
(config-router)#exit	Exit router mode.
(config)#commit	Commit the candidate configuration to the running configuration

(config)#interface eth2	Specify the interface (eth2) for authentication.
(config-if)#ip rip authentication string ABC	Specify the authentication string (ABC) on this interface.
(config-if)#ip rip authentication mode md5	Specify the authentication mode to be MD5.
(config-if)#exit	Exit router mode and return to configure mode.
(config)#commit	Commit the candidate configuration to the running configuration

Validation

show running-config, show ip rip, show ip protocol rip, show ip rip interface, show ip route

R1

```
#show running-config
!
no service password-encryption
!
hostname rtr1
!
logging monitor 7
!
ip vrf management
!
ip domain-lookup
spanning-tree mode provider-rstp
data-center-bridging enable
feature telnet
feature ssh
no feature tacacs+
snmp-server view all .1 included
ntp enable
sFlow disable
software-watchdog keep-alive-time 30
!
ip pim register-rp-reachability
!
interface lo
  mtu 65536
  ip address 127.0.0.1/8
  ip address 192.168.0.1/32 secondary
  ipv6 address ::1/128
!
interface eth0
  ip address 10.12.4.92/24
!
interface eth1
  ip address 10.10.10.10/24
  ip rip authentication mode md5
  ip rip authentication string 0x5c5b790e25d29287
!
interface eth2
  ip address 10.10.11.10/24
!
router rip
```

```
network 10.10.10.0/24
redistribute connected
!
line con 0
login
line vty 0 39
login
!
end
```

```
#show ip rip
```

```
Codes: R - RIP, Rc - RIP connected, Rs - RIP static, K - Kernel,
       C - Connected, S - Static, O - OSPF, I - IS-IS, B - BGP,
       X - Default
```

Network	Next Hop	Metric	From	If	Time
Rc 10.10.10.0/24		1		eth1	
Rc 10.10.11.0/24		1		eth2	
R 10.10.12.0/24	10.10.11.50	2	10.10.11.50	eth2	02:41
R 192.168.0.1/32	10.10.11.50	2	10.10.11.50	eth2	02:41
C 192.168.0.2/32		1		lo	

```
#show ip protocol rip
```

```
RIP Database for VRF (default)
```

```
Routing Protocol is "rip"
```

```
  Sending updates every 30 seconds with +/-50%, next due in 26 seconds
```

```
  Timeout after 180 seconds, garbage collect after 120 seconds
```

```
  Outgoing update filter list for all interface is not set
```

```
  Incoming update filter list for all interface is not set
```

```
  Default redistribution metric is 1
```

```
  Redistributing: connected
```

```
  Default version control: send version 2, receive version 2
```

Interface	Send	Recv	Key-chain
eth1	2	2	

```
Routing for Networks:
```

```
  10.10.10.0/24
```

```
Routing Information Sources:
```

Gateway	Distance	Last Update	Bad Packets	Bad Routes
10.10.10.50	120	00:00:31	0	0

```
Number of routes (including connected): 6
```

```
Distance: (default is 120)
```

```
#show ip rip interface
```

```
svlan0.1 is down, line protocol is down
```

```
  RIP is not enabled on this interface
```

```
eth2 is up, line protocol is up
```

```
  RIP is not enabled on this interface
```

```
eth1 is up, line protocol is up
```

```
  Routing Protocol: RIP
```

```
    Receive RIP packets
```

```
    Send RIP packets
```

```
    Passive interface: Disabled
```

```
    Split horizon: Enabled with Poisoned Reversed
```

```
    IP interface address:
```

```
      10.10.10.10/24
```

```
eth0 is up, line protocol is up
```

```
RIP is not enabled on this interface
lo is up, line protocol is up
RIP is not enabled on this interface
```

```
#show ip route
Codes: K - kernel, C - connected, S - static, R - RIP, B - BGP
       O - OSPF, IA - OSPF inter area
       N1 - OSPF NSSA external type 1, N2 - OSPF NSSA external type 2
       E1 - OSPF external type 1, E2 - OSPF external type 2
       i - IS-IS, L1 - IS-IS level-1, L2 - IS-IS level-2, ia - IS-IS inter
area
       * - candidate default
```

```
IP Route Table for VRF "default"
Gateway of last resort is 10.12.4.1 to network 0.0.0.0
```

```
K*    0.0.0.0/0 [0/0] via 10.12.4.1, eth0
C     10.10.10.0/24 is directly connected, eth1
C     10.10.11.0/24 is directly connected, eth2
R     10.10.12.0/24 [120/2] via 10.10.10.50, eth1, 00:04:05
C     10.12.4.0/24 is directly connected, eth0
C     127.0.0.0/8 is directly connected, lo
C     192.168.0.1/32 is directly connected, lo
R     192.168.0.2/32 [120/2] via 10.10.10.50, eth1, 00:04:05
```

R2

```
#sh running-config
!
no service password-encryption
!
logging monitor 7
!
ip vrf management
!
ip domain-lookup
spanning-tree mode provider-rstp
data-center-bridging enable
feature telnet
feature ssh
no feature tacacs+
snmp-server view all .1 included
ntp enable
sFlow disable
software-watchdog keep-alive-time 30
!
ip pim register-rp-reachability
!
interface lo
  mtu 65536
  ip address 127.0.0.1/8
  ip address 192.168.0.2/32 secondary
  ipv6 address ::1/128
!
interface eth0
  ip address 10.12.4.108/24
!
interface eth1
```

```
ip address 10.10.12.50/24
!  
interface eth2  
ip address 10.10.10.50/24  
ip rip authentication mode md5  
ip rip authentication string 0x5c5b790e25d29287  
!  
router rip  
network 10.10.10.0/24  
redistribute connected  
!  
line con 0  
login  
line vty 0 39  
login  
!  
end
```

```
#show ip rip
```

```
Codes: R - RIP, Rc - RIP connected, Rs - RIP static, K - Kernel,  
C - Connected, S - Static, O - OSPF, I - IS-IS, B - BGP,  
X - Default
```

	Network	Next Hop	Metric	From	If	Time
R	10.10.10.0/24	10.10.11.10	2	10.10.11.10	eth1	02:37
Rc	10.10.11.0/24		1		eth1	
Rc	10.10.12.0/24		1		eth2	
C	192.168.0.1/32		1		lo	
R	192.168.0.2/32	10.10.11.10	2	10.10.11.10	eth1	02:37

```
#show ip protocol rip
```

```
RIP Database for VRF (default)
```

```
Routing Protocol is "rip"
```

```
  Sending updates every 30 seconds with +/-50%, next due in 5 seconds
```

```
  Timeout after 180 seconds, garbage collect after 120 seconds
```

```
  Outgoing update filter list for all interface is not set
```

```
  Incoming update filter list for all interface is not set
```

```
  Default redistribution metric is 1
```

```
  Redistributing: connected
```

```
  Default version control: send version 2, receive version 2
```

Interface	Send	Recv	Key-chain
eth2	2	2	

```
  Routing for Networks:
```

```
  10.10.10.0/24
```

```
  Routing Information Sources:
```

Gateway	Distance	Last Update	Bad Packets	Bad Routes
10.10.10.10	120	00:00:01	0	0

```
  Number of routes (including connected): 6
```

```
  Distance: (default is 120)
```

```
#show ip rip interface
```

```
svlan0.1 is down, line protocol is down
```

```
  RIP is not enabled on this interface
```

```
eth2 is up, line protocol is up
```

```
  Routing Protocol: RIP
```

```
  Receive RIP packets
```



```

Send RIP packets
Passive interface: Disabled
Split horizon: Enabled with Poisoned Reversed
IP interface address:
  10.10.10.50/24
eth1 is up, line protocol is up
  RIP is not enabled on this interface
eth0 is up, line protocol is up
  RIP is not enabled on this interface
lo is up, line protocol is up
  RIP is not enabled on this interface

#show ip route
Codes: K - kernel, C - connected, S - static, R - RIP, B - BGP
       O - OSPF, IA - OSPF inter area
       N1 - OSPF NSSA external type 1, N2 - OSPF NSSA external type 2
       E1 - OSPF external type 1, E2 - OSPF external type 2
       i - IS-IS, L1 - IS-IS level-1, L2 - IS-IS level-2, ia - IS-IS inter
area
       * - candidate default

IP Route Table for VRF "default"
Gateway of last resort is 10.12.4.1 to network 0.0.0.0

K*    0.0.0.0/0 [0/0] via 10.12.4.1, eth0
C     10.10.10.0/24 is directly connected, eth2
R     10.10.11.0/24 [120/2] via 10.10.10.10, eth2, 00:07:36
C     10.10.12.0/24 is directly connected, eth1
C     10.12.4.0/24 is directly connected, eth0
C     127.0.0.0/8 is directly connected, lo
R     192.168.0.1/32 [120/2] via 10.10.10.10, eth2, 00:07:36
C     192.168.0.2/32 is directly connected, lo

```

Text Authentication with Multiple Keys

This example illustrates text authentication of the routing information exchange process for RIP using multiple keys. Routers R1 and R2 are running RIP, and exchanging routing updates. To configure authentication on R1, define a key chain, specify keys in the key chain, then define the authentication string or passwords to use by the keys. Set the time period during which it is valid to receive or send the authentication key by specifying the accept and send lifetimes. After defining the key string, specify the key chain (or set of keys) that will be used for authentication on each interface, and the authentication mode to use.

R1 receives all packets that contain any key string that matches one of the key strings included in the specified key chain (within the accept lifetime) on that interface. The key ID is not considered for matching. For additional security, the accept lifetime and send lifetime are configured such that every fifth day, the key ID and key string changes. To maintain continuity, the accept lifetimes should be configured to overlap. This will accommodate different time setup on machines. However, the send lifetime is not required to overlap, and IP Infusion Inc. recommends configuring no overlapping for the send lifetime.

Topology

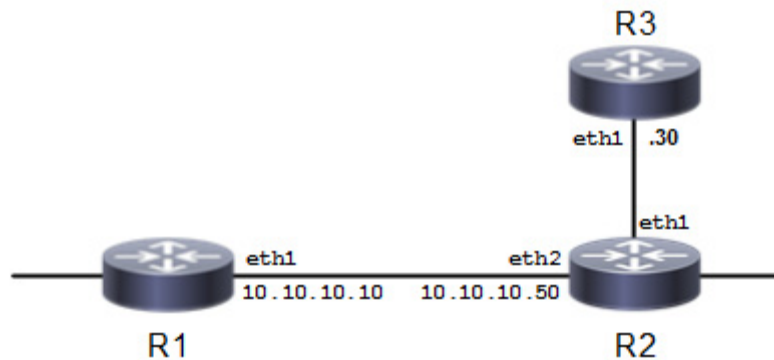

Figure 24-138: Multiple-key Topology

R1

#configure terminal	Enter configure mode.
(config)#router rip	Define a RIP routing process, and enter Router mode.
(config-router)#network 10.10.10.0/24	Associate network 10.10.10.0/24 with the RIP process.
(config-router)#redistribute connected	Enable redistributing from connected routes.
(config-router)#exit	Exit router mode.
(config)#commit	Commit the candidate configuration to the running configuration
(config)#key chain SUN	Enter Keychain management mode to add keys to the key chain SUN.
(config-keychain)#key-id 10	Add authentication key ID (10) to the key chain SUN.
(config-keychain-key)#key-string ABC	Specify a password (ABC) to use by the specified key.
(config-keychain-key)#accept-lifetime 12:00:00 Mar 02 2003 14:00:00 Mar 07 2003	Specify the time period during which the authentication key can be received. In this case, key string ABC can be received from noon of March 02 to 2 pm March 07, 2003, for single-digit day input, must input the leading 0.
(config-keychain-key)#send-lifetime 12:00:00 Mar 02 2003 12:00:00 Mar 07 2003	Specify the time period during which the authentication key can be sent. In this case, key string ABC can be sent from noon of March 02 to noon of March 07, 2003, for single-digit day input, must input the leading 0.
(config-keychain-key)#exit	Exit Keychain-Key mode, and return to Keychain mode.
(config-keychain)#commit	Commit the candidate configuration to the running configuration
(config-keychain)#key-id 20	Add another authentication key (20) to the key chain SUN.
(config-keychain-key)#key-string Earth	Specify a password (Earth) to use by the specified key.

(config-keychain-key)#accept-lifetime 12:00:00 Mar 07 2003 14:00:00 Mar 12 2003	Specify the time period during which authentication key string <code>Earth</code> can be received. In this case, key string <code>Earth</code> can be received from noon of March 07 to 2 pm March 12, 2003, for single-digit day input, must input the leading 0.
(config-keychain-key)#send-lifetime 12:00:00 Mar 07 2003 12:00:00 Mar 12 2003	Specify the time period during which the authentication key can be sent. In this case, key string <code>Earth</code> can be sent from noon of March 07 to noon of March 12, 2003, for single-digit day input, must input the leading 0.
(config-keychain-key)#commit	Commit the candidate configuration to the running configuration
(config-keychain-key)#exit	Exit Keychain-Key mode.
#configure terminal	Enter configure mode.
(config)#interface eth1	Specify interface <code>eth1</code> as the interface you want to configure.
(config-if)#ip rip authentication key-chain SUN	Enable RIPv2 authentication on <code>eth1</code> interface and specify the key-chain <code>SUN</code> to use for authentication.
(config-if)#ip rip authentication mode text	Specify text authentication mode to use for RIP packets. This step is optional, because text is the default mode.
(config-if)#exit	Exit interface mode.
(config)#commit	Commit the candidate configuration to the running configuration

R2

#configure terminal	Enter configure mode.
(config)#router rip	Define a RIP routing process, and enter Router mode.
(config-router)#network 10.10.10.0/24	Associate network <code>10.10.10.0/24</code> with the RIP process.
(config-router)#redistribute connected	Enable redistributing from connected routes.
(config-router)#exit	Exit router mode.
(config)#commit	Commit the candidate configuration to the running configuration
(config)#key chain MOON	Enter Keychain management mode to add keys to the key chain <code>MOON</code> .
(config-keychain)#key-id 30	Add authentication key ID (30) to the key chain <code>MOON</code> .
(config-keychain-key)#key-string ABC	Specify a password (ABC) to use by the specified key.
(config-keychain-key)#accept-lifetime 12:00:00 Mar 02 2003 14:00:00 Mar 07 2003	Specify the time period during which the authentication key can be received. In this case, key string <code>ABC</code> can be received from noon of March 02 to 2 pm March 07, 2003, for single-digit day input, must input the leading 0.
(config-keychain-key)#send-lifetime 12:00:00 Mar 02 2003 12:00:00 Mar 07 2003	Specify the time period during which the authentication key can be sent. In this case, key string <code>ABC</code> can be sent from noon of March 02 to noon of March 07, 2003, for single-digit day input, must input the leading 0.
(config-keychain-key)#exit	Exit Keychain-Key mode, and return to Keychain mode.

RIP

<code>(config-keychain)#commit</code>	Commit the candidate configuration to the running configuration
<code>(config-keychain)#key-id 40</code>	Add another authentication key (40) to the key chain MOON.
<code>(config-keychain-key)#key-string Earth</code>	Specify a password (Earth) to use by the specified key.
<code>(config-keychain-key)#accept-lifetime 12:00:00 Mar 07 2003 14:00:00 Mar 12 2003</code>	Specify the time period during which authentication key string Earth can be received. In this case, key string Earth can be received from noon of March 07 to 2 pm March 12, 2003, for single-digit day input, must input the leading 0.
<code>(config-keychain-key)#send-lifetime 12:00:00 Mar 07 2003 12:00:00 Mar 12 2003</code>	Specify the time period during which the authentication key can be sent. In this case, key string Earth can be sent from noon of March 07 to noon of March 12, 2003, for single-digit day input, must input the leading 0.
<code>(config-keychain-key)#commit</code>	Commit the candidate configuration to the running configuration
<code>(config-keychain-key)#exit</code>	Exit Keychain-Key mode.
<code>#configure terminal</code>	Enter configure mode.
<code>(config)#interface eth2</code>	Specify interface eth2 as the interface you want to configure.
<code>(config-if)#ip rip authentication key-chain MOON</code>	Enable RIPv2 authentication on the eth1 interface, and specify the key-chain MOON to use for authentication.
<code>(config-if)#ip rip authentication mode text</code>	Specify the authentication mode to use for RIP packets. This step is optional, because text is the default mode.
<code>(config-if)#exit</code>	Exit interface mode.
<code>(config)#commit</code>	Commit the candidate configuration to the running configuration

Validation

show running-config, show ip rip, show ip protocol rip, show ip rip interface, show ip route

R1

```
#sh running-config
!
no service password-encryption
!
hostname rtr1
!
logging monitor 7
!
ip vrf management
!
key chain SUN
  key 10
    key-string encrypted 0x5c5b790e25d29287
    accept-lifetime 12:00:00 Mar 02 2003 14:00:00 Mar 07 2003
    send-lifetime 12:00:00 Mar 02 2003 12:00:00 Mar 07 2003
  key 20
```

```
key-string encrypted 0x51b2c401dd313187
accept-lifetime 12:00:00 Mar 07 2003 14:00:00 Mar 12 2003
send-lifetime 12:00:00 Mar 07 2003 12:00:00 Mar 12 2003
!
ip domain-lookup
spanning-tree mode provider-rstp
data-center-bridging enable
feature telnet
feature ssh
no feature tacacs+
snmp-server view all .1 included
ntp enable
sFlow disable
software-watchdog keep-alive-time 30
!
ip pim register-rp-reachability
!
interface lo
mtu 65536
ip address 127.0.0.1/8
ip address 192.168.0.1/32 secondary
ipv6 address ::1/128
!
interface eth0
ip address 10.12.4.92/24
!
interface eth1
ip address 10.10.10.10/24
ip rip authentication mode text
ip rip authentication key-chain chain SUN
!
interface eth2
!
router rip
network 10.10.10.0/24
redistribute connected
!
line con 0
login
line vty 0 39
login
!
end
```

#show ip rip

Codes: R - RIP, Rc - RIP connected, Rs - RIP static, K - Kernel,
C - Connected, S - Static, O - OSPF, I - IS-IS, B - BGP,
X - Default

Network	Next Hop	Metric	From	If	Time
Rc 10.10.10.0/24		1		eth1	
C 10.12.4.0/24		1		eth0	
C 192.168.0.1/32		1		lo	

```
#show ip protocol rip
RIP Database for VRF (default)
```

```
Routing Protocol is "rip"
  Sending updates every 30 seconds with +/-50%, next due in 16 seconds
  Timeout after 180 seconds, garbage collect after 120 seconds
  Outgoing update filter list for all interface is not set
  Incoming update filter list for all interface is not set
  Default redistribution metric is 1
  Redistributing: connected
  Default version control: send version 2, receive version 2
    Interface          Send  Recv   Key-chain
    eth1                2     2     chain SUN
  Routing for Networks:
    10.10.10.0/24
  Routing Information Sources:
    Gateway            Distance  Last Update  Bad Packets  Bad Routes
  Number of routes (including connected): 3
  Distance: (default is 120)

#show ip rip interface
svlan0.1 is down, line protocol is down
  RIP is not enabled on this interface
eth2 is down, line protocol is down
  RIP is not enabled on this interface
eth1 is up, line protocol is up
  Routing Protocol: RIP
  Receive RIP packets
  Send RIP packets
  Passive interface: Disabled
  Split horizon: Enabled with Poisoned Reversed
  IP interface address:
    10.10.10.10/24
eth0 is up, line protocol is up
  RIP is not enabled on this interface
lo is up, line protocol is up
  RIP is not enabled on this interface

#show ip route
Codes: K - kernel, C - connected, S - static, R - RIP, B - BGP
       O - OSPF, IA - OSPF inter area
       N1 - OSPF NSSA external type 1, N2 - OSPF NSSA external type 2
       E1 - OSPF external type 1, E2 - OSPF external type 2
       i - IS-IS, L1 - IS-IS level-1, L2 - IS-IS level-2, ia - IS-IS inter
area
       * - candidate default

IP Route Table for VRF "default"
Gateway of last resort is 10.12.4.1 to network 0.0.0.0

K*    0.0.0.0/0 [0/0] via 10.12.4.1, eth0
C     10.10.10.0/24 is directly connected, eth1
C     10.12.4.0/24 is directly connected, eth0
C     127.0.0.0/8 is directly connected, lo
C     192.168.0.1/32 is directly connected, lo
```

R2

```
#sh running-config
!
no service password-encryption
```

```
!  
logging monitor 7  
!  
ip vrf management  
!  
key chain MOON  
  key 30  
    key-string encrypted 0x5c5b790e25d29287  
    accept-lifetime 12:00:00 Mar 02 2003 14:00:00 Mar 07 2003  
    send-lifetime 12:00:00 Mar 02 2003 12:00:00 Mar 07 2003  
  key 40  
    key-string encrypted 0x51b2c401dd313187  
    accept-lifetime 12:00:00 Mar 07 2003 14:00:00 Mar 12 2003  
    send-lifetime 12:00:00 Mar 07 2003 12:00:00 Mar 12 2003  
!  
ip domain-lookup  
spanning-tree mode provider-rstp  
data-center-bridging enable  
feature telnet  
feature ssh  
no feature tacacs+  
snmp-server view all .1 included  
ntp enable  
sFlow disable  
software-watchdog keep-alive-time 30  
!  
ip pim register-rp-reachability  
!  
interface lo  
  mtu 65536  
  ip address 127.0.0.1/8  
  ip address 192.168.0.2/32 secondary  
  ipv6 address ::1/128  
!  
interface eth0  
  ip address 10.12.4.108/24  
!  
interface eth1  
!  
interface eth2  
  ip address 10.10.10.50/24  
  ip rip authentication mode text  
  ip rip authentication key-chain chain MOON  
!  
router rip  
  network 10.10.10.0/24  
  redistribute connected  
!  
line con 0  
  login  
line vty 0 39  
  login  
!  
end  
  
#show ip rip
```

Codes: R - RIP, Rc - RIP connected, Rs - RIP static, K - Kernel,
C - Connected, S - Static, O - OSPF, I - IS-IS, B - BGP,
X - Default

	Network	Next Hop	Metric From	If	Time
Rc	10.10.10.0/24		1	eth2	
C	10.12.4.0/24		1	eth0	
C	192.168.0.2/32		1	lo	

```
#show ip protocol rip
```

```
RIP Database for VRF (default)
```

```
Routing Protocol is "rip"
```

```
  Sending updates every 30 seconds with +/-50%, next due in 5 seconds
```

```
  Timeout after 180 seconds, garbage collect after 120 seconds
```

```
  Outgoing update filter list for all interface is not set
```

```
  Incoming update filter list for all interface is not set
```

```
  Default redistribution metric is 1
```

```
  Redistributing: connected
```

```
  Default version control: send version 2, receive version 2
```

Interface	Send	Recv	Key-chain
eth2	2	2	chain MOON

```
Routing for Networks:
```

```
  10.10.10.0/24
```

```
Routing Information Sources:
```

Gateway	Distance	Last Update	Bad Packets	Bad Routes
---------	----------	-------------	-------------	------------

```
Number of routes (including connected): 3
```

```
Distance: (default is 120)
```

```
#show ip rip interface
```

```
svlan0.1 is down, line protocol is down
```

```
  RIP is not enabled on this interface
```

```
eth2 is up, line protocol is up
```

```
  Routing Protocol: RIP
```

```
    Receive RIP packets
```

```
    Send RIP packets
```

```
    Passive interface: Disabled
```

```
    Split horizon: Enabled with Poisoned Reversed
```

```
  IP interface address:
```

```
    10.10.10.50/24
```

```
eth1 is down, line protocol is down
```

```
  RIP is not enabled on this interface
```

```
eth0 is up, line protocol is up
```

```
  RIP is not enabled on this interface
```

```
lo is up, line protocol is up
```

```
  RIP is not enabled on this interface
```

```
#show ip route
```

```
Codes: K - kernel, C - connected, S - static, R - RIP, B - BGP
```

```
       O - OSPF, IA - OSPF inter area
```

```
       N1 - OSPF NSSA external type 1, N2 - OSPF NSSA external type 2
```

```
       E1 - OSPF external type 1, E2 - OSPF external type 2
```

```
       i - IS-IS, L1 - IS-IS level-1, L2 - IS-IS level-2, ia - IS-IS inter
```

```
area
```

```
       * - candidate default
```

```
IP Route Table for VRF "default"
```

```
Gateway of last resort is 10.12.4.1 to network 0.0.0.0
```



```

K*      0.0.0.0/0 [0/0] via 10.12.4.1, eth0
C       10.10.10.0/24 is directly connected, eth2
C       10.12.4.0/24 is directly connected, eth0
C       127.0.0.0/8 is directly connected, lo
C       192.168.0.2/32 is directly connected, lo

```

MD5 Authentication with Multiple Keys

This example illustrates the MD5 authentication of the routing information exchange process for RIP using multiple keys. Routers R1 and R2 are running RIP, and exchanging routing updates. To configure authentication on R1, define a key chain, specify keys in the key chain, then define the authentication string or passwords to use by the keys. Then, set the time period during which it is valid to receive or send the authentication key by specifying the accept and send lifetimes. After defining the key string, specify the key chain (or the set of keys) that will be used for authentication on the interface, and the authentication mode to use. Configure R2 and R3 to have the same key ID and key string as R1 for the time that updates are to be exchanged.

In MD5 authentication, both the key ID and key string are matched for authentication. R1 will receive only packets that match both the key ID and the key string in the specified key chain (within the accept lifetime) on that interface. In the following example, R2 has the same key ID and key string as R1. For additional security, the accept lifetime and send lifetime are configured such that every fifth day, the key ID and key string changes. To maintain continuity, the accept lifetimes should be configured to overlap; however, the send lifetime should not overlap.

Topology

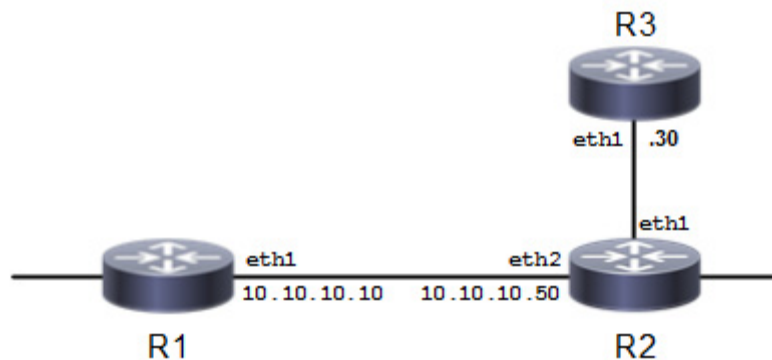

Figure 24-139: MD5 Multiple-key Topology

R1

#configure terminal	Enter configure mode.
(config)#router rip	Define a RIP routing process, and enter Router mode.
(config-router)#network 10.10.10.0/24	Associate network 10.10.10.0/24 with the RIP process.
(config-router)#redistribute connected	Enable redistributing from connected routes.
(config-router)#exit	Exit router mode.
(config)#commit	Commit the candidate configuration to the running configuration

RIP

(config)#key chain SUN	Enter Keychain management mode to add keys to the key chain SUN.
(config-keychain)#key-id 1	Add authentication key ID (1) to the key chain SUN.
(config-keychain-key)#key-string ABC	Specify a password (ABC) to use by the specified key.
(config-keychain-key)#accept-lifetime 12:00:00 Mar 02 2003 14:00:00 Mar 07 2003	Specify the time period during which the authentication key can be received. In this case, key string ABC can be received from noon of March 02 to 2 pm March 07, 2003, for single-digit day input, must input the leading 0.
(config-keychain-key)#send-lifetime 12:00:00 Mar 02 2003 12:00:00 Mar 07 2003	Specify the time period during which the authentication key can be sent. In this case, key string ABC can be sent from noon of March 02 to noon of March 07, 2003, for single-digit day input, must input the leading 0.
(config-keychain-key)#exit	Exit Keychain-Key mode, and return to Keychain mode.
(config-keychain)#commit	Commit the candidate configuration to the running configuration
(config-keychain)#key-id 2	Add another authentication key (2) to the key chain SUN.
(config-keychain-key)#key-string Earth	Specify a password (Earth) to use by the specified key.
(config-keychain-key)#accept-lifetime 12:00:00 Mar 07 2003 14:00:00 Mar 12 2003	Specify the time period during which authentication key string Earth can be received. In this case, key string Earth can be received from noon of March 07 to 2 pm March 12, 2003, for single-digit day input, must input the leading 0.
(config-keychain-key)#send-lifetime 12:00:00 Mar 07 2003 12:00:00 Mar 12 2003	Specify the time period during which the authentication key can be sent. In this case, key string Earth can be sent from noon of March 07 to noon of March 12, 2003, for single-digit day input, must input the leading 0.
(config-keychain-key)#commit	Commit the candidate configuration to the running configuration
(config-keychain-key)#exit	Exit Keychain-Key mode.
#configure terminal	Enter configure mode.
(config)#interface eth1	Specify interface eth1 as the interface you want to configure.
(config-if)#ip rip authentication key chain SUN	Enable RIPv2 authentication on the eth1 interface, and specify the key chain SUN to use for authentication.
(config-if)#ip rip authentication mode md5	Specify MD5 authentication mode to use for RIP packets.
(config-if)#exit	Exit interface mode.
(config)#commit	Commit the candidate configuration to the running configuration

R2

#configure terminal	Enter configure mode.
(config)#router rip	Define a RIP routing process, and enter Router mode.

(config-router)#network 10.10.10.0/24	Associate network 10.10.10.0/24 with the RIP process.
(config-router)#redistribute connected	Enable redistributing from connected routes.
(config-router)#exit	Exit router mode.
(config)#commit	Commit the candidate configuration to the running configuration
(config)#key chain MOON	Enter Keychain management mode to add keys to the key chain MOON.
(config-keychain)#key-id 1	Add authentication key ID (1) to the key chain MOON.
(config-keychain-key)#key-string ABC	Specify a password (ABC) to use by the specified key.
(config-keychain-key)#accept-lifetime 12:00:00 Mar 02 2003 14:00:00 Mar 07 2003	Specify the time period during which the authentication key can be received. In this case, key string ABC can be received from noon of March 02 to 2 pm March 07, 2003, for single-digit day input, must input the leading 0.
(config-keychain-key)#send-lifetime 12:00:00 Mar 02 2003 12:00:00 Mar 07 2003	Specify the time period during which the authentication key can be sent. In this case, key string ABC can be sent from noon of March 02 to noon of March 07, 2003, for single-digit day input, must input the leading 0.
(config-keychain-key)#exit	Exit Keychain-Key mode, and return to Keychain mode.
(config-keychain)#commit	Commit the candidate configuration to the running configuration
(config-keychain)#key-id 2	Add another authentication key (2) to the key chain MOON.
(config-keychain-key)#key-string Earth	Specify a password (Earth) to use by the specified key.
(config-keychain-key)#accept-lifetime 12:00:00 Mar 07 2003 14:00:00 Mar 12 2003	Specify the time period during which the authentication key can be received. In this case, key string Earth can be received from noon of March 07 to 2 pm March 12, 2003, for single-digit day input, must input the leading 0.
(config-keychain-key)#send-lifetime 12:00:00 Mar 07 2003 12:00:00 Mar 12 2003	Specify the time period during which the authentication key can be sent. In this case, key string Earth can be sent from noon of March 07 to noon of March 12, 2003, for single-digit day input, must input the leading 0.
(config-keychain-key)#commit	Commit the candidate configuration to the running configuration
(config-keychain-key)#end	Enter Privileged Exec mode.
#configure terminal	Enter configure mode.
(config)#interface eth2	Specify interface eth2 as the interface you want to configure.
(config-if)#ip rip authentication key chain MOON	Enable RIPv2 authentication on the eth1 interface, and specify the key chain MOON to use for authentication.
(config-if)#ip rip authentication mode md5	Specify the authentication mode to use for RIP packets.

(config-if)#exit	Exit interface mode.
(config)#commit	Commit the candidate configuration to the running configuration

Validation

show running-config, show ip rip, show ip protocol rip, show ip rip interface

R1

```
#sh running-config
!
no service password-encryption
!
hostname rtr1
!
logging monitor 7
!
ip vrf management
!
key chain SUN
  key 1
    key-string encrypted 0x5c5b790e25d29287
    accept-lifetime 12:00:00 Mar 02 2003 14:00:00 Mar 07 2003
    send-lifetime 12:00:00 Mar 02 2003 12:00:00 Mar 07 2003
  key 2
    key-string encrypted 0x51b2c401dd313187
    accept-lifetime 12:00:00 Mar 07 2003 14:00:00 Mar 12 2003
    send-lifetime 12:00:00 Mar 07 2003 12:00:00 Mar 12 2003
!
ip domain-lookup
spanning-tree mode provider-rstp
data-center-bridging enable
feature telnet
feature ssh
no feature tacacs+
snmp-server view all .1 included
ntp enable
sFlow disable
software-watchdog keep-alive-time 30
!
ip pim register-rp-reachability
!
interface lo
  mtu 65536
  ip address 127.0.0.1/8
  ip address 192.168.0.1/32 secondary
  ipv6 address ::1/128
!
interface eth0
  ip address 10.12.4.92/24
!
interface eth1
  ip address 10.10.10.10/24
  ip rip authentication mode md5
  ip rip authentication key-chain chain SUN
```

```
!  
interface eth2  
!  
router rip  
network 10.10.10.0/24  
redistribute connected  
!  
line con 0  
login  
line vty 0 39  
login  
!  
end
```

```
#show ip rip
```

Codes: R - RIP, Rc - RIP connected, Rs - RIP static, K - Kernel,
C - Connected, S - Static, O - OSPF, I - IS-IS, B - BGP,
X - Default

	Network	Next Hop	Metric	From	If	Time
Rc	10.10.10.0/24		1		eth1	
C	10.12.4.0/24		1		eth0	
C	192.168.0.1/32		1		lo	

```
#show ip protocol rip  
RIP Database for VRF (default)  
Routing Protocol is "rip"  
Sending updates every 30 seconds with +/-50%, next due in 19 seconds  
Timeout after 180 seconds, garbage collect after 120 seconds  
Outgoing update filter list for all interface is not set  
Incoming update filter list for all interface is not set  
Default redistribution metric is 1  
Redistributing: connected  
Default version control: send version 2, receive version 2  
Interface Send Recv Key-chain  
eth1 2 2 chain SUN  
Routing for Networks:  
10.10.10.0/24  
Routing Information Sources:  
Gateway Distance Last Update Bad Packets Bad Routes  
Number of routes (including connected): 3  
Distance: (default is 120)
```

```
#show ip rip interface  
svlan0.1 is down, line protocol is down  
RIP is not enabled on this interface  
eth2 is down, line protocol is down  
RIP is not enabled on this interface  
eth1 is up, line protocol is up  
Routing Protocol: RIP  
Receive RIP packets  
Send RIP packets  
Passive interface: Disabled  
Split horizon: Enabled with Poisoned Reversed  
IP interface address:  
10.10.10.10/24
```

```
eth0 is up, line protocol is up
  RIP is not enabled on this interface
lo is up, line protocol is up
  RIP is not enabled on this interface
```

R2

```
#show running-config
!
no service password-encryption
!
logging monitor 7
!
ip vrf management
!
key chain MOON
  key 1
    key-string encrypted 0x5c5b790e25d29287
    accept-lifetime 12:00:00 Mar 02 2003 14:00:00 Mar 07 2003
    send-lifetime 12:00:00 Mar 02 2003 12:00:00 Mar 07 2003
  key 2
    key-string encrypted 0x51b2c401dd313187
    accept-lifetime 12:00:00 Mar 07 2003 14:00:00 Mar 12 2003
    send-lifetime 12:00:00 Mar 07 2003 12:00:00 Mar 12 2003
!
ip domain-lookup
spanning-tree mode provider-rstp
data-center-bridging enable
feature telnet
feature ssh
no feature tacacs+
snmp-server view all .1 included
ntp enable
sFlow disable
software-watchdog keep-alive-time 30
!
ip pim register-rp-reachability
!
interface lo
  mtu 65536
  ip address 127.0.0.1/8
  ip address 192.168.0.2/32 secondary
  ipv6 address ::1/128
!
interface eth0
ip address 10.12.4.108/24
!
interface eth1
!
interface eth2
  ip address 10.10.10.50/24
  ip rip authentication mode md5
  ip rip authentication key-chain chain MOON
!
router rip
  network 10.10.10.0/24
  redistribute connected
```

```
!  
line con 0  
  login  
line vty 0 39  
  login  
!  
end
```

```
#show ip rip
```

```
Codes: R - RIP, Rc - RIP connected, Rs - RIP static, K - Kernel,  
       C - Connected, S - Static, O - OSPF, I - IS-IS, B - BGP,  
       X - Default
```

	Network	Next Hop	Metric	From	If	Time
Rc	10.10.10.0/24		1		eth2	
C	10.12.4.0/24		1		eth0	
R	192.168.0.1/32	10.10.10.10	16	10.10.10.10	eth2	01:29
C	192.168.0.2/32		1		lo	

```
#show ip protocol rip
```

```
RIP Database for VRF (default)
```

```
Routing Protocol is "rip"
```

```
  Sending updates every 30 seconds with +/-50%, next due in 9 seconds
```

```
  Timeout after 180 seconds, garbage collect after 120 seconds
```

```
  Outgoing update filter list for all interface is not set
```

```
  Incoming update filter list for all interface is not set
```

```
  Default redistribution metric is 1
```

```
  Redistributing: connected
```

```
  Default version control: send version 2, receive version 2
```

Interface	Send	Recv	Key-chain
eth2	2	2	chain MOON

```
  Routing for Networks:
```

```
    10.10.10.0/24
```

```
  Routing Information Sources:
```

```
    Gateway           Distance  Last Update  Bad Packets  Bad Routes
```

```
  Number of routes (including connected): 4
```

```
  Distance: (default is 120)
```

```
#show ip rip interface
```

```
svlan0.1 is down, line protocol is down
```

```
  RIP is not enabled on this interface
```

```
eth2 is up, line protocol is up
```

```
  Routing Protocol: RIP
```

```
    Receive RIP packets
```

```
    Send RIP packets
```

```
    Passive interface: Disabled
```

```
    Split horizon: Enabled with Poisoned Reversed
```

```
  IP interface address:
```

```
    10.10.10.50/24
```

```
eth1 is down, line protocol is down
```

```
  RIP is not enabled on this interface
```

```
eth0 is up, line protocol is up
```

```
  RIP is not enabled on this interface
```

```
lo is up, line protocol is up
```

```
  RIP is not enabled on this interface
```

RIPV2 VRF Configuration

RIPV2 can be configured along with vrf between two nodes and also between PE-CE nodes.

Topology

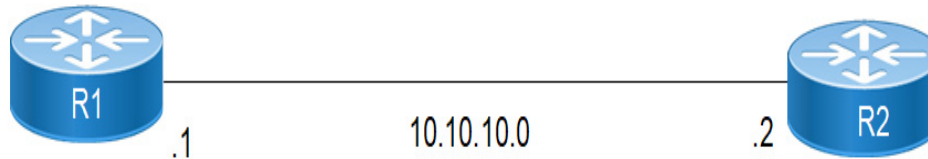

Figure 24-140: RIPV2 VRF Topology

RIPV2 VRF Configuration

This document captures requirements to use RIPv2 with vrf between two nodes.

R1

#configure terminal	Enter configuration mode.
(config)#ip vrf ripv2	Configure ip vrf
(config-vrf)#rd 1:1	Configure rd
(config-vrf)#route-target both 1:100	Configure rt value
(config-vrf)#int xe48	Enter in to interface
(config-if)#ip vrf forwarding ripv2	Enable ip vrf forwarding
(config-if)#ip address 10.10.10.1/24	Configure ip address
(config-if)#router rip	Enter in to router rip
(config-router)#address-family ipv4 vrf ripv2	Address family ipv4 with vrf name
(config-router-af)#network 10.10.10.0/24	Configure network command
(config-router-af)#redistribute static	Configure Redistribute static
(config-router-af)#redistribute connected	Configure Redistribute connected
(config-router-af)#commit	Commit the transactions
(config)#ip route vrf ripv2 191.1.1.10/32 xe48	Configure static route with vrf
(config)#commit	Commit the transaction

R2

#configure terminal	Enter configuration mode.
(config)#ip vrf ripv2	Configure ip vrf
(config-vrf)#rd 1:1	Configure rd
(config-vrf)#route-target both 1:100	Configure rt value

(config-vrf)#int xe10	Enter in to interface
(config-if)#ip vrf forwarding ripv2	Enable ip vrf forwarding
(config-if)#ip address 10.10.10.2/24	Configure ip address
(config-if)#router rip	Enter in to router rip
(config-router)#address-family ipv4 vrf ripv2	Address family ipv4 with vrf name
(config-router-af)#network 10.10.10.0/24	Configure network command
(config-router-af)#redistribute static	Configure Redistribute static
(config-router-af)#redistribute connected	Configure Redistribute connected
(config-router-af)#commit	Commit the transactions

Validation

R1

```
#sh ip rip database vrf ripv2
```

Codes: R - RIP, Rc - RIP connected, Rs - RIP static, K - Kernel,
C - Connected, S - Static, O - OSPF, I - IS-IS, B - BGP,
X - Default

Network	Next Hop	Metric	From	If	Time
Rc 10.10.10.0/24		1		xe48	
S 191.1.1.10/32		1		xe48	

R2

```
#sh ip rip database vrf ripv2
```

Codes: R - RIP, Rc - RIP connected, Rs - RIP static, K - Kernel,
C - Connected, S - Static, O - OSPF, I - IS-IS, B - BGP,
X - Default

Network	Next Hop	Metric	From	If	Time
Rc 10.10.10.0/24		1		xe10	
R 191.1.1.10/32	10.10.10.1	2	10.10.10.1	xe10	02:48

CHAPTER 25 RIPng

This chapter contains a basic RIPng configuration example.

For details about the commands used in these examples, see the *Routing Information Protocol Command Reference*.

Topology

The diagram shows the minimum configuration required to enable RIPng on an interface. R1 and R2 are two routers connected to network 3ffe:11::/64. To enable RIPng, first define the RIPng routing process, then enable RIPng on each interface.

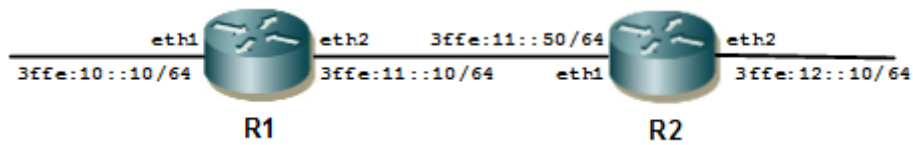

Figure 25-141: RIPng Topology

Configuration

R1

#configure terminal	Enter Configure mode.
(config)#interface eth1	Specify the interface (eth1) to configure, and enter Interface mode.
(config-if)#ipv6 router rip	Enable RIPng routing on interface eth1.
(config-if)#exit	Exit Interface mode, and enter Configure mode.
(config)#interface eth2	Specify the interface (eth2) to configure, and enter Interface mode.
(config-if)#ipv6 router rip	Enable RIPng routing on interface eth2.
(config-if)#exit	Exit Interface mode, and enter Configure mode.
(config)#router ipv6 rip	Define a RIPng routing process, and enter Router mode.
(config)# commit	Commit the transaction.

R2

#configure terminal	Enter Configure mode.
(config)#interface eth1	Specify the interface (eth1) to configure, and enter Interface mode.
(config-if)#ipv6 router rip	Enable RIPng routing on interface eth1.
(config-if)#exit	Exit Interface mode, and enter Configure mode.
(config)#interface eth2	Specify the interface (eth2) to configure, and enter Interface mode.
(config-if)#ipv6 router rip	Enable RIPng routing on interface eth2.
(config-if)#exit	Exit Interface mode, and enter Configure mode.

(config)#router ipv6 rip	Define a RIPng routing process, and enter Router mode.
(config)# commit	Commit the transaction.

Validation

R1

```
R1#show ipv6 rip
```

```
Codes: R - RIP, Rc - RIP connected, Rs - RIP static, Ra - RIP aggregated,
       Rcx - RIP connect suppressed, Rsx - RIP static suppressed,
       K - Kernel, C - Connected, S - Static, O - OSPF, I - IS-IS, B - BGP
```

Network Time	Next Hop	If	Met	Tag
Rc 3ffe:10::/64	::	eth1	1	0
Rc 3ffe:11::/64	::	eth2	1	0
R 3ffe:12::/64	fe80::aa2b:b5ff:fe1c:c561	eth2	2	0

02:40

```
R1#show ipv6 rip interface
```

```
lo.management is up, line protocol is up
  RIPng is not enabled on this interface
eth1 is up, line protocol is up
  Routing Protocol: RIPng
  Passive interface: Disabled
  Split horizon: Enabled with Poisoned Reversed
  IPv6 interface address:
    3ffe:11::10/64
    fe80::aa2b:b5ff:fe2f:41cb/64
eth2 is up, line protocol is up
  Routing Protocol: RIPng
  Passive interface: Disabled
  Split horizon: Enabled with Poisoned Reversed
  IPv6 interface address:
    3ffe:10::10/64
    fe80::aa2b:b5ff:fe2f:41cb/64
```

```
R1#show ipv6 protocols rip
```

```
Routing Protocol is "ripng"
```

```
  Sending updates every 30 seconds with +/-50%, next due in 4294967295 seconds
  Timeout after 180 seconds, garbage collect after 120 seconds
  Outgoing update filter list for all interface is not set
  Incoming update filter list for all interface is not set
  Default redistribute metric is 1
  Redistributing:
  Interface
    xe48
    ce49
  Routing for Networks:
```

```
R1#show ipv6 route
```

```
IPv6 Routing Table
```

```
Codes: K - kernel route, C - connected, S - static, R - RIP, O - OSPF,
```

IA - OSPF inter area, E1 - OSPF external type 1,
 E2 - OSPF external type 2, E - EVPN N1 - OSPF NSSA external type 1,
 N2 - OSPF NSSA external type 2, i - IS-IS, B - BGP
 Timers: Uptime

IP Route Table for VRF "default"
 C ::1/128 via ::, lo, 4d19h49m
 C 3ffe:10::/64 via ::, eth1, 00:10:53
 C 3ffe:11::/64 via ::, eth2, 00:10:08
 R 3ffe:12::/64 [120/2] via fe80::aa2b:b5ff:fe1c:c561, eth2, 00:04:26
 C fe80::/64 via ::, eth2, 00:54:20

R2

R2#show ipv6 rip

Codes: R - RIP, Rc - RIP connected, Rs - RIP static, Ra - RIP aggregated,
 Rcx - RIP connect suppressed, Rsx - RIP static suppressed,
 K - Kernel, C - Connected, S - Static, O - OSPF, I - IS-IS, B - BGP

Network	Next Hop	If	Met	Tag
R 3ffe:10::/64 02:36	fe80::aa2b:b5ff:fe2f:41cb	eth1	2	0
Rc 3ffe:11::/64	::	eth1	1	0
Rc 3ffe:12::/64	::	eth2	1	0

R2#show ipv6 rip interface
 eth1 is up, line protocol is up
 Routing Protocol: RIPng
 Passive interface: Disabled
 Split horizon: Enabled with Poisoned Reversed
 IPv6 interface address:
 3ffe:11::50/64
 fe80::aa2b:b5ff:fe1c:c561/64
 eth2 is up, line protocol is up
 Routing Protocol: RIPng
 Passive interface: Disabled
 Split horizon: Enabled with Poisoned Reversed
 IPv6 interface address:
 3ffe:12::10/64
 fe80::aa2b:b5ff:fe1c:c561/64

CHAPTER 26 Layer 3 Subinterface Configuration

This chapter contains examples of configuring subinterfaces.

A single physical interface when required to handle multiple VLAN traffic, can be divided into multiple logical interfaces called sub-interfaces.

All sub-interfaces under a physical port will use their parent port for transmitting and receiving data.

Sub-interfaces can be used for various purposes, as for inter-vlan routing to happen when router has only one physical interface, two sub-interfaces each with different IP network can be created under it and data can be routed between them.

Sub-interfaces let you divide a physical interface into multiple logical interfaces that are tagged with different VLAN identifiers. Because VLANs allow you to keep traffic separate on a given physical interface, you can increase the number of interfaces available to your network without adding additional physical interfaces.

Note: Refer to the release note for features supported by L3 Sub-interface.

Topology

Figure 26-142 shows an example of subinterface configuration. In this example, there are two routers, R1 and R2, and the eth1 interface of R1 is connected directly to eth2 of R2 using an Ethernet cable.

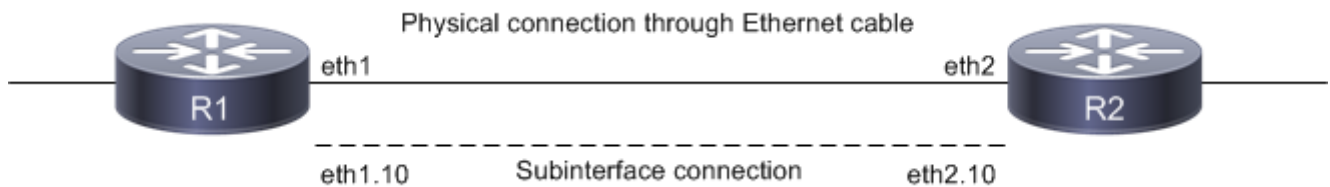

Figure 26-142: Subinterface connections

The eth1.10 subinterface is created on R1, and eth2.10 is created on R2.

Note: Layer 3 Subinterfaces can be created on physical and LAG interfaces.

Creating a Subinterface

#configure terminal	Enter configure mode.
(config)#interface eth1	Enter interface mode
(config-if)#interface eth1.10	Creates a sub-interface as eth1.10
(config-if)#encapsulation dot1q 10	Configure the encapsulation as dot1q matching vlan 10
(config-if)#ip address 10.10.10.1/24	Assigning IP address to sub-interface
(config-if)#commit	Commit the candidate configuration to the running configuration
(config-if)#exit	Exit interface mode

Creating a Subinterface with Encapsulation

Double encapsulation as dot1q

#configure terminal	Configure terminal
(config)#interface eth1.1010	Configure subinterface
(config-if)# encapsulation dot1q 10 inner-dot1q 10	Configure encapsulation with inner tag
(config-if)#ip address 192.168.1.50/24	Configuring ip address
(config-if)#commit	Commit the candidate configuration to the running configuration
(config-if)#exit	Exit configure mode

Double encapsulation as dot1ad

#configure terminal	Configure terminal
(config)#interface eth1.20	Configure subinterface
(config-if)# encapsulation dot1ad 20 inner-dot1q 20	Configure encapsulation with inner tag
(config-if)#ip address 192.168.2.50/24	Configuring ip address
(config-if)#commit	Commit the candidate configuration to the running configuration
(config-if)#exit	Exit configure mode

Note: Use `dot1ad ethertype (0x8100 | 0x88a8 | 0x9100 | 0x9200)` command to configure the service-tpid value on parent port of a subinterface. By this the tpid used for service tag for a subinterface may be inherited from the one applied to parent interface.

Note: For any dot1ad subinterface to be functional, dot1ad ethertype should be set to desired value as 0x88a8/0x9100/0x9200. Default value is 0x8100. To verify the ethertype value for the interface use `show interface <subinterface>` command.

L3SI Statistics

Enable below commands to get subinterface statistics

#configure terminal	Configure terminal
(config)#hardware-profile statistics ac-lif enable	Enable hardware profile statistics
(config)#commit	Commit the candidate configuration to the running configuration
(config)#exit	Exit configure mode

Note: Reload the node, and then only statistics command will get effective.

Displaying Subinterfaces

In OcNOS, subinterfaces appear as any physical interface in the `show running-config` or the `show ip interface brief` output and can be configured as any other interface.

The following examples display subinterface information from various `show` commands.

Note: The below command output is just for reference and is not directly related to the configuration provided above

show interface brief

```
RTR1#show interface brief
```

```
Codes: ETH - Ethernet, LB - Loopback, AGG - Aggregate, MLAG - MLAG Aggregate
FR - Frame Relay, TUN -Tunnel, PBB - PBB Logical Port, VP - Virtual Port
CVP - Channelised Virtual Port, METH - Management Ethernet, UNK- Unknown
ED - ErrDisabled, PD - Protocol Down, AD - Admin Down, PD(Min-links) -
Protocol Down Min-links
DV - DDM Violation, NA - Not Applicable
NOM - No operational members, PVID - Port Vlan-id
HD - ESI Hold Timer Down
```

```
-----
Ethernet  Type  PVID  Mode                Status  Reason  Speed  Port
Interface                                     Ch #
-----
ce49      ETH   --    routed              up      none    100g   --
```

```
-----
Interface      Type                Status  Reason  Speed
-----
ce49.2         SUBINTERFACE        up      --      0
ce49.3         SUBINTERFACE        up      --      0
ce49.4         SUBINTERFACE        up      --      0
ce49.5         SUBINTERFACE        up      --      0
ce49.6         SUBINTERFACE        up      --      0
```

show ip interface brief

```
RTR1#show ip interface brief
```

'*' - address is assigned by dhcp client

```
Interface      IP-Address      Admin-Status      Link-Status
ce49            unassigned      up                 up
ce49.2          49.49.2.1       up                 up
ce49.3          49.49.3.1       up                 up
ce49.4          49.49.4.1       up                 up
ce49.5          49.49.5.1       up                 up
ce49.6          49.49.6.1       up                 up
```

show ip ospf neighbor with VRF enabled

RTR1#show ip ospf neighbor

Total number of full neighbors: 2

OSPF process 1 VRF(default):

Neighbor ID Instance ID	Pri	State	Dead Time	Address	Interface	
4.4.4.4	1	Full/DR	00:00:32	48.48.2.2	vlan1.2	0
4.4.4.4	1	Full/DR	00:00:38	48.48.3.2	vlan1.3	0

Total number of full neighbors: 1

OSPF process 2 VRF(CUST-2):

Neighbor ID Instance ID	Pri	State	Dead Time	Address	Interface	
11.11.2.1	1	Full/DR	00:00:39	49.49.2.2	ce49.2	0

Total number of full neighbors: 1

OSPF process 3 VRF(CUST-3):

Neighbor ID Instance ID	Pri	State	Dead Time	Address	Interface	
11.11.3.1	1	Full/Backup	00:00:33	49.49.3.2	ce49.3	0

Total number of full neighbors: 1

OSPF process 4 VRF(CUST-4):

Neighbor ID Instance ID	Pri	State	Dead Time	Address	Interface	
11.11.4.1	1	Full/Backup	00:00:31	49.49.4.2	ce49.4	0

Total number of full neighbors: 1

OSPF process 5 VRF(CUST-5):

Neighbor ID Instance ID	Pri	State	Dead Time	Address	Interface	
11.11.5.1	1	Full/Backup	00:00:39	49.49.5.2	ce49.5	0

show ip route with VRF enabled

RTR1#show ip route

Codes: K - kernel, C - connected, S - static, R - RIP, B - BGP

O - OSPF, IA - OSPF inter area

N1 - OSPF NSSA external type 1, N2 - OSPF NSSA external type 2

E1 - OSPF external type 1, E2 - OSPF external type 2

i - IS-IS, L1 - IS-IS level-1, L2 - IS-IS level-2,

ia - IS-IS inter area, E - EVPN,

v - vrf leaked

* - candidate default

IP Route Table for VRF "default"

```

C          1.2.200.0/24 is directly connected, xe1.200, 01:29:19
O          4.4.4.4/32 [110/11] via 48.48.3.2, vlan1.3, 00:37:17
           [110/11] via 48.48.2.2, vlan1.2
O          44.44.44.0/24 [110/2] via 48.48.3.2, vlan1.3, 00:37:17
           [110/2] via 48.48.2.2, vlan1.2
C          47.47.2.0/24 is directly connected, xe47.2, 00:34:42
C          48.48.2.0/24 is directly connected, vlan1.2, 00:41:19
C          48.48.3.0/24 is directly connected, vlan1.3, 00:41:19
C          127.0.0.0/8 is directly connected, lo, 01:30:09

```

Gateway of last resort is not set

RTR1#show ip route vrf all

Codes: K - kernel, C - connected, S - static, R - RIP, B - BGP

O - OSPF, IA - OSPF inter area

N1 - OSPF NSSA external type 1, N2 - OSPF NSSA external type 2

E1 - OSPF external type 1, E2 - OSPF external type 2

i - IS-IS, L1 - IS-IS level-1, L2 - IS-IS level-2,

ia - IS-IS inter area, E - EVPN,

v - vrf leaked

* - candidate default

IP Route Table for VRF "default"

```

C          1.2.200.0/24 is directly connected, xe1.200, 01:29:32
O          4.4.4.4/32 [110/11] via 48.48.3.2, vlan1.3, 00:37:30
           [110/11] via 48.48.2.2, vlan1.2
O          44.44.44.0/24 [110/2] via 48.48.3.2, vlan1.3, 00:37:30
           [110/2] via 48.48.2.2, vlan1.2
C          47.47.2.0/24 is directly connected, xe47.2, 00:34:55
C          48.48.2.0/24 is directly connected, vlan1.2, 00:41:32
C          48.48.3.0/24 is directly connected, vlan1.3, 00:41:32
C          127.0.0.0/8 is directly connected, lo, 01:30:22

```

IP Route Table for VRF "management"

C 127.0.0.0/8 is directly connected, lo.management, 01:30:22

C 192.168.10.0/24 is directly connected, eth0, 01:30:22

IP Route Table for VRF "CUST-1"

C 127.0.0.0/8 is directly connected, lo.CUST-1, 01:30:22

IP Route Table for VRF "CUST-2"

Layer 3 Subinterface Configuration

```
C      1.1.2.0/24 is directly connected, xe1.2, 01:29:35
C      1.2.101.0/24 is directly connected, xe1.101, 01:29:34
C      1.3.201.0/24 is directly connected, xe1.201, 01:29:32
O      11.11.2.0/24 [110/20] via 49.49.2.2, ce49.2, 00:51:06
O      11.12.101.0/24 [110/20] via 49.49.2.2, ce49.2, 00:51:06
O      11.13.201.0/24 [110/20] via 49.49.2.2, ce49.2, 00:51:06
C      49.49.2.0/24 is directly connected, ce49.2, 01:29:31
C      127.0.0.0/8 is directly connected, lo.CUST-2, 01:30:22
IP Route Table for VRF "CUST-3"
C      1.1.3.0/24 is directly connected, xe1.3, 01:29:35
C      1.2.102.0/24 is directly connected, xe1.102, 01:29:34
C      1.3.202.0/24 is directly connected, xe1.202, 01:29:32
O      11.11.3.0/24 [110/20] via 49.49.3.2, ce49.3, 01:12:44
O      11.12.102.0/24 [110/20] via 49.49.3.2, ce49.3, 01:12:44
O      11.13.202.0/24 [110/20] via 49.49.3.2, ce49.3, 01:12:44
C      49.49.3.0/24 is directly connected, ce49.3, 01:29:31
```

CHAPTER 27 Two-way Active Measurement Protocol

Two-way Active Measurement Protocol (TWAMP) is an open protocol for measuring network performance between any two devices.

In OcNOS, TWAMP measurement is configured under the interface mode using the “delay-measurement dynamic twamp” command. When the command is configured, the measurement is started on the corresponding interface and using the configuration data in the delay-measurement command. The measurement is stopped by unconfiguring the “delay-measurement” command on the interface.

The TWAMP hardware profile filter should be enabled so that the timestamps used in the TWAMP protocol calculations are obtained accurately from the DNX hardware.

After the measurement is done, the result can be checked by the user using the OcNOS cli or netconf. The result is also advertised to IGP TE. There are 2 modes of advertisement, periodic and accelerated. Both periodic and accelerated advertisements can be enabled in parallel.

Periodic Advertisement

Periodic advertisement is enabled by default. In this case, the link delay metrics are calculated at a periodic “computation” interval. The calculated minimum delay for a link is compared with the minimum delay value advertised previously:

- The delay metrics for the link are advertised only if the variation in values is beyond any of the configured periodic thresholds.
- If the variation in values is within configured periodic thresholds, the delay metrics for the link are not advertised.

Accelerated Advertisement

Accelerated advertisement is disabled by default. In this case, the link delay metrics are calculated after receiving every burst of data. The calculated minimum delay for a link is compared with the minimum delay value advertised previously:

- The delay metrics for the link are advertised only if the variation in values is beyond any of the configured accelerated thresholds.
- If the variation in values is within configured accelerated thresholds, the delay metrics for the link are not advertised.

Limitation and Assumptions

- To verify delay, loss and bandwidth measurement with IGP_TE, the pre-requisites are that the ISIS and OSPF sessions should be up and running. (Check OSPF and ISIS configuration in corresponding chapters).
- The a-bit-threshold configures the Anomalous (A) bit. The A bit is set when the measured value of this parameter exceeds its configured maximum threshold. The A bit is cleared when the measured value falls below its configured reuse threshold.
- The “test-session-name” command is no longer supported and should not be used. The “delay-measurement” command under interface mode should be used instead.

Topology

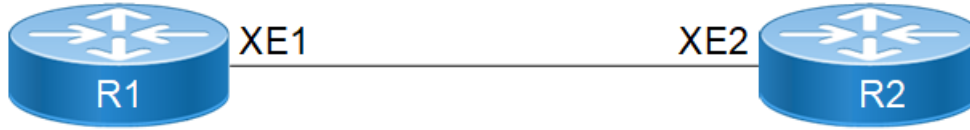

Figure 27-143: TWAMP topology

Configuring TWAMP Measurement on ROUTER

Configure the router R1 to send TWAMP measurement packets on interface xe1 towards the reflector on R2.

R1

#configure terminal	Enter to Config mode
(config)# hardware-profile filter twamp-ipv4 enable	Enable the hardware profile filter for TWAMP ipv4 so that HW timestamps can be retrieved in the DNX hardware for IPv4
(config)# hardware-profile filter twamp-ipv6 enable	Enable the hardware profile filter for TWAMP ipv6 so that HW timestamps can be retrieved in the DNX hardware for IPv6
(config)#twamp-light control	Enter to Twamp-Light control mode
(config-twamp-light-ctrl)#control-admin-state enable	Enable the Twamp-light sender framework
(config-twamp-light-ctrl)#exit	Exit the Twamp-light control mode
(config)#interface xe1	Enter interface mode.
(config-if)#ip address 23.1.1.1/24	Configure ipv4 address
(config-if)#ipv6 address 222::1/64	Configure ipv4 address
(config-if)# delay-measurement dynamic twamp reflector-ip 23.1.1.2 reflector-port 1235 sender-ip 23.1.1.1 sender-port 1234 dscp 56	Configure the TWAMP delay measurement
(config-if)#commit	Commit the candidate configuration to running configuration.

Configure the router R2 to receive and reflect TWAMP measurement packets on interface xe2.

R2

#configure terminal	Enter Configure mode
(config)# hardware-profile filter twamp-ipv4 enable	Enable the hardware profile filter for TWAMP ipv4 so that HW timestamps can be retrieved in the DNX hardware for IPv4
(config)# hardware-profile filter twamp-ipv6 enable	Enable the hardware profile filter for TWAMP ipv6 so that HW timestamps can be retrieved in the DNX hardware for IPv6
(config)#interface xe2	Enter interface mode.
(config-if)#ip address 23.1.1.2/24	Configure ipv4 address
(config-if)#ipv6 address 222::2/64	Configure ipv6 address
(config-if)#exit	Exit interface mode
(config)#twamp-light reflector	Enter to Twamp-Light reflector mode

<code>(config-twamp-light-ref)#reflector-admin-state enable</code>	Enable the Twamp-light reflector framework
<code>(config-twamp-light-ref)#reflector-name r1 reflector-ip 23.1.1.2 reflector-port 1235 sender-ip 23.1.1.1 sender-port 1234</code>	Create a reflector instance
<code>(config-twamp-light-ref)#commit</code>	Commit the candidate configuration to the running configuration
<code>(config-twamp-light-ref)#exit</code>	Exit Twamp-Light reflector mode

Configuring TWAMP Delay Profiles

The delay profile “interfaces” configures the way the TWAMP packets are sent (burst, interval...) and the way the data is advertised after the measurement data is collected

R1

<code>#configure terminal</code>	Enter Configure mode
<code>(config)# delay-profile interfaces</code>	Enter in to delay profile mode
<code>(config-dp-int)#burst interval 3000</code>	To config the burst interval for TWAMP packets in milliseconds(default value is 3000 milliseconds).
<code>(config-dp-int)#burst count 10</code>	To set the number of packets to be sent at each burst interval (default=10)
<code>(config-dp-int)#interval 30</code>	To set the computation interval for TWAMP packets in seconds. (Default=30 sec)
<code>(config-dp-int)#interval 120</code>	To set the computation interval of TWAMP packets for advertisement periodic mode
<code>(config-dp-int)# advertisement periodic threshold 10</code>	Config threshold value inside advertisement periodic mode for TWAMP packets
<code>(config-dp-int)# advertisement periodic minimum-change 1000</code>	Config minimum change value inside advertisement periodic mode for TWAMP packets
<code>(config-dp-int)# advertisement accelerated</code>	Enable advertisement accelerated in delay profile mode
<code>(config-dp-int)# advertisement accelerated threshold 20</code>	Config advertisement accelerated minimum change value inside delay profile mode for TWAMP packets
<code>(config-dp-int)# advertisement accelerated minimum-change 2000</code>	Config advertisement accelerated minimum change value inside delay profile mode for TWAMP packets
<code>(config--dp-int)#commit</code>	Commit the candidate configuration to running configuration

Configuring Loss Measurement

Loss measurement is disabled by default and should be configured separately after the delay-measurement has been configured.

R1

<code>#configure terminal</code>	Enter configure mode
<code>(config)#interface xe1</code>	Enter interface mode

(config-if)#delay-measurement dynamic twamp reflector-ip 23.1.1.2 reflector-port 1235 sender-ip 23.1.1.1 sender port 1234 dscp 56	Configure delay measurement
config-if)#loss-measurement dynamic	Configure loss measurement after delay measurement is already configured
(config-if)#commit	Commit the candidate configuration to running configuration
(config-if)#exit	Exit interface mode

Un-Configuring/Stopping TWAMP Measurement

R1

#configure terminal	Enter configure mode
(config)# hardware-profile filter twamp-ipv4 disable	Disable hardware profile filter for TWAMP ipv4
(config)# hardware-profile filter twamp-ipv6 disable	Disable hardware profile filter for TWAMP ipv6
(config)#interface xel	Enter interface mode
(config-if)# no delay-measurement dynamic twamp reflector-ip 23.1.1.2	Unconfigure delay measurement
(config-if)#no loss-measurement dynamic	Unconfigure loss measurement
(config-if)#commit	Commit the candidate configuration to running configuration
(config-if)#exit	Exit interface mode

Un-Configuring TWAMP Delay profile

R1

#configure terminal	Enter configure mode
(config)# delay-profile interfaces	Enter in to delay profile mode
(config-dp-int)#no burst interval	Un-Config burst interval value inside delay profile mode
(config-dp-int)#no burst count	Un-Config burst count value inside delay profile mode
(config-dp-int)#no interval	Un-Config interval value inside delay profile mode
(config-dp-int)#no sender-port	Un-Config sender port value inside delay profile mode

<code>(config-dp-int)#no advertisement periodic</code>	Disable advertisement periodic mode
<code>config-dp-int)#no interval</code>	Un-Config interval value inside for advertisement periodic mode
<code>(config-dp-int)#no advertisement periodic threshold</code>	Un-Config threshold value inside advertisement periodic mode
<code>(config-dp-int)# no advertisement periodic minimum-change</code>	Un-Config minimum change value inside advertisement periodic mode
<code>(config-dp-int)#no advertisement accelerated</code>	Un-Config accelerated inside advertisement mode
<code>(config-dp-int)#no advertisement accelerated minimum-change</code>	Un-Config advertisement accelerated minimum change value inside delay profile mode
<code>(config-dp-int)# no advertisement accelerated threshold</code>	Un-Config advertisement accelerated threshold value inside delay profile mode
<code>(config-dp-if)#commit</code>	Commit the candidate configuration to running configuration

Clearing TWAMP Statistics

R1

<code>Router1# clear twamp measurement interface xel</code>	This command will restart the measurement on the specified interface, resetting the collected stats.
<code>Router1# clear twamp measurement interface all</code>	This command will restart the measurement on all the interfaces, resetting all the collected stats. If there are any non-applied configuration changes to the delay profile, they will be applied when this command is issued.

Validation

Configuration Validation on the Sender Side

```
#show running-config twamp
twamp-light control
  control-admin-state enable
#show running-config interface xel | inc delay-measurement
delay-measurement
dynamic twamp
reflector-ip 23.1.1.2
reflector-port 1235
sender-ip 23.1.1.1
sender-port 1234
dscp 56
```

Configuration validation on reflector side

```
#show running config twamp
twamp-light reflector
  reflector-admin-state enable
  reflector-name r1
  reflector-ip 23.1.1.2
```

```
reflector-port 1234
```

Validation of TWAMP statistics

```
#show twamp-statistics interfaces xe1
```

```
Interface name      : xe1
Sender IP           : 23.1.1.1
Reflector IP        : 23.1.1.2
Reflector port      : 1234
DSCP value          : 56
Last Advertised stats:
  Time: 2019-02-14 10:19:38
  Average delay      : 2
  Minimum delay      : 2
  Maximum delay      : 2
  Average delay variation: 0
  Minimum delay variation: 0
  Maximum delay variation: 0
  Packets sent       : 100
  Packets received   : 100
  Packets timeout    : 0
  Packet Loss: 0
```

```
Last Calculated stats:
  Time: 2019-02-14 10:23:39
  Average delay      : 2
  Minimum delay      : 2
  Maximum delay      : 2
  Average delay variation: 0
  Minimum delay variation: 0
  Maximum delay variation: 0
  Packets sent       : 100
  Packets received   : 100
  Packets timeout    : 0
  Packet Loss : 0
```

End-to-End Measurement

When a reflector is multiple hops away from the sender and there are multiple paths available to the reflector, End-to-End measurement ensures that the TWAMP packets should go out of only the interface with the configured Sender IP/ Reflector IP on sender and reflector side respectively.

Topology

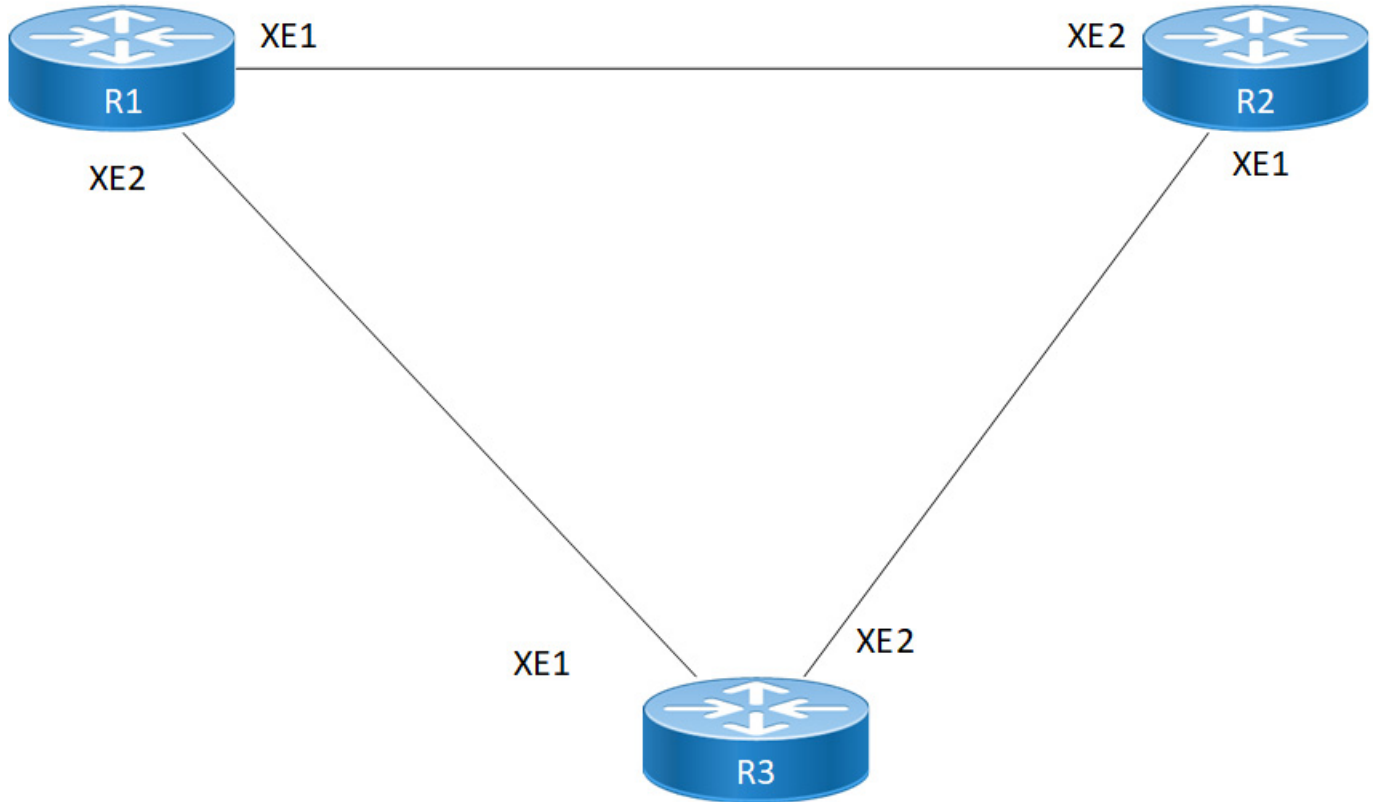

Figure 27-144: TWAMP topology

Configuration

ROUTER1 - Sender

#configure terminal	Enter configure mode.
(config)# hardware-profile filter twamp-ipv4 enable	Enable the hardware profile filter for TWAMP ipv4 so that HW timestamps can be retrieved in the DNX hardware for IPv4
(config)#twamp-light control	Enter the Twamp-Light control mode
(config-twamp-light-ctrl)#control-admin-state enable	Enable the Twamp-light sender framework
(config-twamp-light-ctrl)#exit	Exit the Twamp-light Control mode
(config)#interface xe1	Enter xe1 interface mode
(config-if)#ip address 10.10.10.1/24	Configure ipv4 address
(config-if)#exit	Exit interface mode
(config)#interface xe2	Enter xe2 interface mode
(config-if)#ip address 20.20.20.1/24	Configure ipv4 address
(config-if)# delay-measurement dynamic twamp sender-ip 20.20.20.1 reflector-ip 30.30.30.2 reflector-port 1234	Configuring delay measurement. Since it is applied on interface xe2, it will force the packets to go out from xe2 even if others paths are available

Two-way Active Measurement Protocol

(config-if)#commit	Commit the candidate configuration to running configuration.
(config-if)#exit	Exit interface mode
(config)#ip route 30.30.30.0/24 20.20.20.2	Set static route to reflector.
(config)#commit	Commit the candidate configuration to running configuration

ROUTER2 - Reflector

#configure terminal	Enter Configure mode
(config)# hardware-profile filter twamp-ipv4 enable	Enable the hardware profile filter for TWAMP ipv4 so that HW timestamps can be retrieved in the DNX hardware for IPv4
(config)#interface xe1	Enter xe1 interface mode
(config-if)#ip address 30.30.30.2/24	Configure ipv4 address
(config)#interface xe2	Enter xe2 interface mode
(config-if)#ip address 10.10.10.2/24	Configure ipv4 address
(config-if)#exit	Exit interface mode.
(config)#twamp-light reflector	Enter the Twamp-Light reflector mode
(config-twamp-light-ref)#reflector-admin-state enable	Enabling the Twamp-light reflector framework
(config-twamp-light-ref)#reflector-name r1 reflector-ip 30.30.30.2 reflector-port 1234 sender-ip 20.20.20.1	Configuring the reflector instance with reflector ip and port number. Specifying explicitly the sender-ip in the reflector command will force the reflector to reply from the interface where the reflector-ip is configured.
(config-twamp-light-ref)#commit	Commit the candidate configuration to the running configuration
(config-if)#exit	Exit interface mode
(config)#ip route 20.20.20.0/24 30.30.30.1	Set static route to sender
(config)#commit	Commit the candidate configuration to running configuration

ROUTER3 - Intermediate

#configure terminal	Enter Configure mode
(config)#interface xe1	Enter xe1 interface mode
(config-if)#ip address 20.20.20.2/24	Configure ipv4 address
(config)#interface xe2	Enter xe2 interface mode
(config-if)#ip address 30.30.30.1/24	Configure ipv4 address
(config-if)#commit	Commit

Validation

Validation On Sender Side

```
R1#show running-config twamp  
twamp-light control  
control-admin-state enable
```

```
#show twamp-statistics interfaces xe2
```

```
Interface name      : xe2
Sender IP           : 20.20.20.1
Reflector IP       : 30.30.30.2
Reflector port     : 1234
DSCP value          : 0
HW Status           : -
```

```
Last Advertised stats:
```

```
Time: 2019-03-07 10:45:54
Average delay       : 628
Minimum delay       : 558
Maximum delay       : 697
Average delay variation: 17
Minimum delay variation: 8
Maximum delay variation: 23
Packets sent        : 50
Packets received    : 50
Packets timeout     : 0
Packet Loss: Not Enabled
```

```
Last Calculated stats:
```

```
Time: 2019-03-07 10:48:34
Average delay       : 646
Minimum delay       : 494
Maximum delay       : 701
Average delay variation: 8
Minimum delay variation: 2
Maximum delay variation: 21
Packets sent        : 50
Packets received    : 50
Packets timeout     : 0
```

```
Packet Loss : Not Enabled
```

```
#show twamp-statistics
```

```
=====
TWAMP Test-Session Statistics
=====
```

```
Test-Session Name      : __internal_interface_10024
Start Time              : 2019 Mar 07 10:43:13
Elapsed time(milli sec) : 348057
Packets Sent            : 435
Packets Received        : 435
Packet Loss(%)          : 0.0000
Round Trip Delay(usec)
  Minimum                : 607
  Maximum                 : 3373
  Average                 : 1216
Forward Delay(usec)
  Minimum                 : (*)
  Maximum                 : (*)
```

Two-way Active Measurement Protocol

```
Average                : (*)
Reverse Delay(usec)
  Minimum               : (*)
  Maximum               : (*)
  Average               : (*)
Round Trip Delay Variation(usec)
  Minimum               : 144
  Maximum               : 852
  Average               : 243
Forward Delay Variation(usec)
  Minimum               : (*)
  Maximum               : (*)
  Average               : (*)
Reverse Delay Variation(usec)
  Minimum               : (*)
  Maximum               : (*)
  Average               : (*)
```

(*) - Time is not in sync between Sender and Reflector

```
# show twamp-statistics interfaces
```

Interface	Last Advertisement	Delay(us)	Min(us)	Max(us)	Var(us)	Loss(%)
xe2	2019-03-07 10:45:54	628	558	697	17	Not Enabled

Validation On Reflector side

```
#show running-config twamp
twamp-light reflector
  reflector-admin-state enable
  reflector-name r1 reflector-ip ipv4 30.30.30.2 reflector-port 1234 sender-ip
  ipv4 20.20.20.1
```

CHAPTER 28 Two-way Active Measurement Protocol Server

Two-way Active Measurement Protocol (TWAMP) is an open protocol for measuring network performance between any two devices.

Here, we need to start the TWAMP server by using server admin state enable command. From TWAMP client, we need to configure test session with client control connection name, test session name along with ip address of server interface, probe count & dscp code points.

The sessions will stop automatically, once it reached the configure inactivity time set from twamp server. To stop TWAMP server, the user need to disable server admin state from twamp server.

Topology

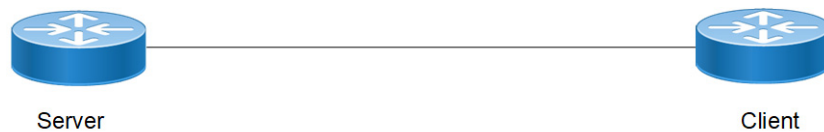

Figure 28-145: BGP Peer-Groups with L2VPN EVPN address-family

Note: TWAMP client is not supported on OcNOS.

Configuration

Configuring TWAMP Server on the Router

SERVER(config)# twamp server	Use this command to change to the twamp server mode.
SERVER(config-twamp-server)#port 5555	Set the TCP port value where the twamp server will be listening. It could be either the default value 862, or in the range 1025-65535.
SERVER(config-twamp-server)# max-connection-duration 3	Set the maximum connection duration value between 0 and 120 hours.
SERVER(config-twamp-server)# max-connections 17	Set the maximum number of connections value between 1 and 32.
SERVER(config-twamp-server)# max-connections-per-client 3	Set the maximum number of connections per client value between 1 and 4.
SERVER(config-twamp-server)# maximum-sessions 25	Set the maximum number of sessions between 1 and 64.
SERVER(config-twamp-server)# maximum-sessions-per-connection 20	Set the maximum number of sessions per connection between 1 and 64.
SERVER(config-twamp-server)# inactivity-timeout 5	Set the inactivity timeout to a value between 0 and 30 in minutes.

```
SERVER(config-twamp-server)# listen-vrf  
vrf123
```

Use this command to add custom VRFs to the list of VRFs where the TWAMP server is running. If no listen-vrf is specified, the TWAMP server is started in the default VRF only. Multiple VRFs can be specified. The user can issue the same command multiple times, once for each VRF. Only clients in the configured VRFs are allowed to connect to the server and only sessions to IPs in the configured VRFs are allowed to be established.

```
SERVER(config-twamp-server)# server-admin-  
state enable
```

Use this command to Start/Stop the TWAMP server with the above configured parameters. In case any of the twamp server parameters are modified after the server is started, the modification will be applied after the server is stopped and started again.

```
SERVER(config-twamp-server)#commit
```

Commit the candidate configuration to the running configuration

Validation

```
SERVER#sh running-config twamp  
twamp server  
max-connection-duration 2  
max-connections 10  
max-connections-per-client 4  
maximum-sessions 30  
maximum-sessions-per-connection 20  
inactivity-timeout 2  
listen-vrf default  
listen-vrf management  
listen-vrf vrf-111  
listen-vrf vrf-112  
listen-vrf vrf-222  
listen-vrf vrf1  
listen-vrf vrf2
```

Show twamp server status:

```
SERVER#show twamp server status
```

```
Status : Not Enabled  
Listening Port : 862  
Server VRF list : default management vrf-111 vrf-112 vrf-222 vrf1  
vrf2  
Number of connections : 0  
Number of sessions : 0  
Number of running sessions: 0
```

```
OcNOS#show twamp server status
```

```
Status : Enabled  
Listening Port : 862  
Server VRF list : management default vrf1  
Number of connections : 3  
Number of sessions : 15  
Number of running sessions: 5
```

Show twamp server connections information

```
OcNOS# show twamp server connection
Connection ID Client Address Client Port
 1 100.1.0.1 59807
 2 100.1.0.2 59808
 3 100.1.0.3 59809
 4 100.1.0.4 59810
```

```
OcNOS# show twamp server connection 2
Connection ID : 2
Client Address : 100.1.0.2
Client Port : 59808
Client VRF : default
State : Control session established
Connection Time : Thu Feb 14 12:13:51 2019
Last Activity Time : Thu Feb 14 12:13:51 2019
Number of session requests : 7
Number of accepted sessions: 3
OcNOS#
```

Show twamp server sessions information

```
7047-TWAMP#show twamp server session
Connection ID      Session Id
Sender            Receiver         State
-----
43.0.0.2          199 2B.00.00.03:E7548F41C6BC5154:5D180E4F
                  43.0.0.3         Started
41.0.0.2          200 29.00.00.03:E7548F41C6DAA92E:103A923B
                  41.0.0.3         Started
44.0.0.2          201 2C.00.00.03:E7548F41C6E5ABC0:36294112
                  44.0.0.3         Started
44.0.0.2          202 2C.00.00.03:E7548F41C7161A1D:63CFE863
                  44.0.0.3         Started
42.0.0.2          203 2A.00.00.03:E7548F41C82B94D9:47C8C30A
                  42.0.0.3         Started
44.0.0.2          204 2C.00.00.03:E7548F41C917A461:E0C3DE71
                  44.0.0.3         Started
7047-TWAMP#
```

```
OcNOS# show twamp server session
Connection ID Session Id Sender
Receiver State
 1 5B.5B.5B.03:E00FD9FF99B7F173:D8CE5E5D 91.91.91.2
91.91.91.3 Started
 2 5B.5B.5B.03:E00FCF8221DF548E:EF824500 9.1.9.1
91.91.91.3 Started
```

```
OcNOS# show twamp server session 5B.5B.5B.03:E00FCF8221DF548E:EF824500
State : Started
Connection ID : 2
Session ID : 5B.5B.5B.03:E00FCF8221DF548E:EF824500
Sender address : 9.1.9.1
Sender port : 44566
Receiver address: 91.91.91.3
Receiver port : 44001
Receiver VRF : default
Start time : 2022-08-31 16:44:00
```

Timeout : 5 sec

CHAPTER 29 Hybrid Switch Router Configuration

This chapter describes configurations that can be done with the Hybrid Switch Router solution. OcNOS can be configured as a Layer 2 switch, a Layer 3 router or a Hybrid Switch Router.

Overview

An OcNOS Hybrid Switch Router offers Layer 3 forwarding found in routers with the high-speed performance associated with traditional Layer 2 switches. The following are some advantages of Hybrid Switch Routers:

- Reduced system cost and infrastructure. Traditionally you would require a separate box for switching and one for routing.
- Off-loading IP traffic from backbone routers, thus making them more efficient for firewalls and WAN connectivity.
- Simplified network design and maintenance.

Routing and Switching

Layer 2 and Layer 3 switches are similar at a high-level, both look at the packet headers, and steer the packets toward their destination port. Therefore, after being passed through a switch or router, the packet is closer to its destination.

Layer 2 Switching

Layer 2 switches are typically used to provide connectivity within high bandwidth local area networks (LANs). A Layer 2 switch makes forwarding decisions based on the MAC or the Layer 2 header. It extracts the Layer 2 header from the packet, finds a matching destination address in the forwarding table, and transmits the packet out to the port associated with the specific destination address in the forwarding table. The forwarding table is populated through a self-learning process, whereby each arriving packet is used to update the entries in the table. Typically, the Layer 2 switch implements the switching function in the hardware, as that requires stripping of the packet only in two layers (the physical and data link layer) to get to the useful part of the packet header. This allows switches to steer packets at wire-speed rates without slowing down arriving streams of packets to process them.

Layer 3 Routing

Layer 3 (L3) routers are typically used to provide connectivity between different LANs. A Layer 3 router discards MAC headers, and indexes further into the packet—making decisions based on the IP or Layer 3 header. It extracts the Layer-3 header from the packet, finds a matching destination address in a routing table, identifies a new MAC address for the packet from an ARP cache, wraps the IP packet in a new MAC header, and then transmits the packet out to the port associated with that destination address in the routing table.

The routing table is populated through statically configured command line interface entries or through routing protocol messages from neighboring routers. A Layer 3 router must strip through 3 layers (physical, data link, and network) which is more complicated than a Layer 2 switch. Layer 3 routers historically implement the routing function in software. This often results in limited packet-forwarding rates. However, improvements in VLSI circuit technology have allowed Layer 3 routing functions to be implemented rapidly in hardware, enabling wire-speed performance similar to the performance of Layer 2 switches. As a result, along with the complexity of next-generation Layer 3 routers, the throughput of these routers has also been increasing.

An architecture is required that is flexible enough to accommodate the demands of different customers, and accommodate the changing demands of a single customer whose requirements may change over time. Typical Layer 2 switches and Layer 3 routers fail to provide this flexibility.

An optimal configuration can be an integrated solution, a Layer 3 router with Layer 2 bridge groups around it. The OcNOS Hybrid Switch Router implementation allows easy configuration of different combinations of routers and

switches. OcNOS can be configured as an absolute Layer 3 router, absolute Layer 2 switch (Figure 29-146) or a hybrid Layer 2/Layer 3 switch router, (Figure 29-147) that can easily change modes with the use of a single command.

System Configuration

- OcNOS stack will bring up all the ports of the board as routed ports by default.
- However OcNOS provides flexibility to create a Layer 2 bridge, and ports can be converted to switch ports and added to the bridge.
- OcNOS also supports VLAN interfaces and routing between VLANs.

Thus it can work as a router, a switch, or as a hybrid switch.

Hybrid Switch Router Possibilities

With only Layer 2 protocols configured, the OcNOS Hybrid Switch Router can become an absolute Layer 2 switch.

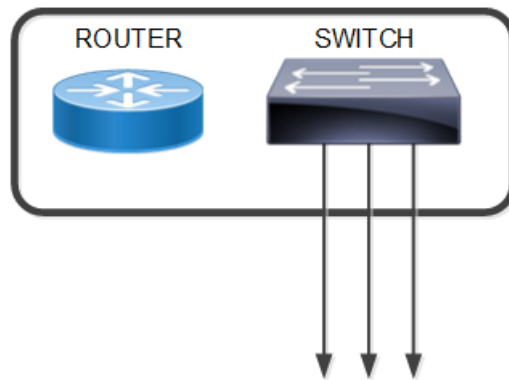

Figure 29-146: Layer 2 Switch

With Layer 2 and Layer 3 protocols configured, the OcNOS Hybrid Switch Router can become a Switch and/or a Router.

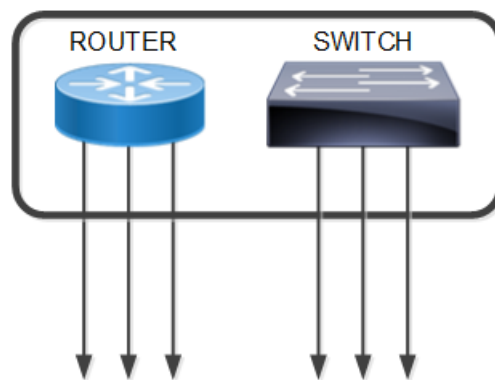

Figure 29-147: Working as a Router or a Switch

With only Layer 3 protocols enabled, the OcNOS Hybrid Switch Router can become an absolute router.

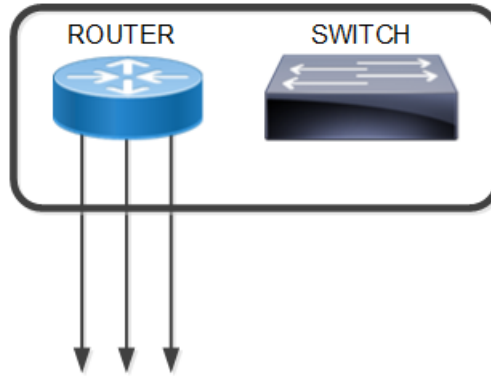

Figure 29-148: Working as Layer 3 Router

On switch ports, VLANs can be created for different broadcast domains.

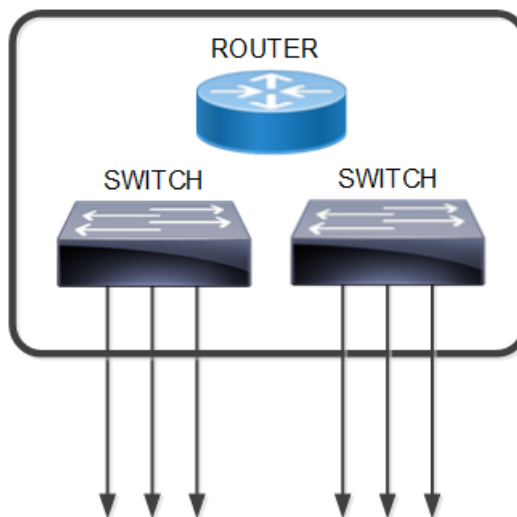

Figure 29-149: Port- or Policy-based VLANs

For routing between VLANs, the OcnOS routing protocols or static routing via NSM can be utilized.

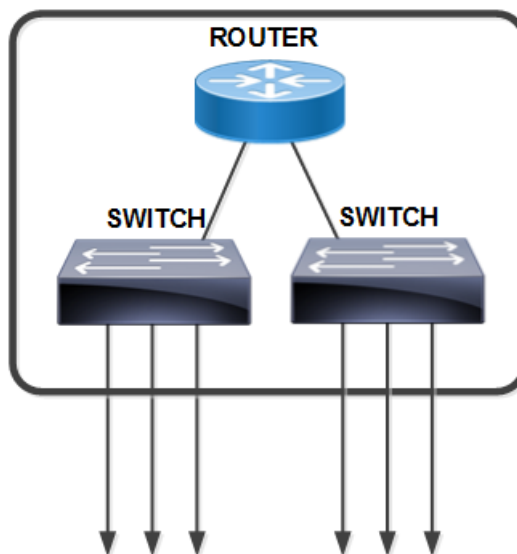

Figure 29-150: Routing between VLANs

For routing between VLANs and other routing ports, OcnOS routing protocols or static routing via NSM can be utilized.

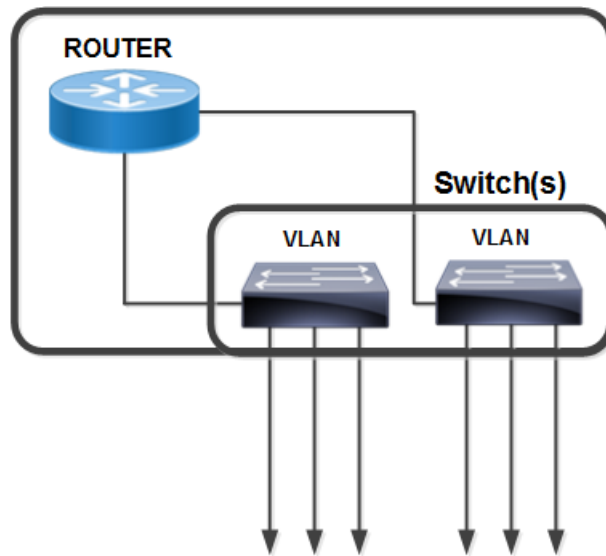

Figure 29-151: Routing between VLANs and Routing Ports

Configuring Layer 2 Interfaces

For the Hybrid Switch Router, it is important to understand that by default, all interfaces are configured as routed interfaces. To configure a Layer 2 interface (switched interface), you must explicitly configure this using the `switchport` command in the interface mode. For example:

<code>#configure terminal</code>	Enter the Configure mode.
<code>(config)#bridge 1 protocol mstp</code>	Create a MSTP bridge.
<code>(config)#interface eth2</code>	Specify an interface to configure and enter the Interface mode.
<code>(config-if)#switchport</code>	Configure eth2 as a Layer 2 port.
<code>(config-if)#bridge-group 1</code>	Associate interface to bridge 1.
<code>(config-if)#no shutdown</code>	Start interface.eth2
<code>(config-if)#commit</code>	Commit the candidate configuration to the running configuration
<code>(config-if)#exit</code>	Exit interface mode

Configuring Layer 3 Interfaces

For the Hybrid Switch Router, it is important to understand that by default, all interfaces in OcnOS are L3 ports. If a port has been configured as L2, then use the `no switchport` command to make it a L3 port.

For example:

<code>#configure terminal</code>	Enter the Configure mode.
<code>(config)#interface eth3</code>	Specify an interface to configure and enter the Interface mode.
<code>(config-if)#no switchport</code>	Configure eth3 as a Layer 3 port.

(config-if)#commit	Commit the candidate configuration to the running configuration
(config-if)#exit	Exit interface mode

In the Hybrid Switch Router mode, if a VLAN is configured, a Layer 3 interface based on the bridge-group number and VLAN ID is created. This Layer 3 interface is advertised to all the Layer 3 protocols. For example:

#configure terminal	Enter the Configure mode.
(config)#bridge 1 protocol mstp	Creating bridge.
(config)#vlan database	Enter the VLAN configure mode.
(config-vlan)#vlan 2 bridge 1	Enable VLAN 2 on bridge 1.
(config-vlan)#commit	Commit the candidate configuration to the running configuration
(config-vlan)#exit	Exit VLAN configure mode

The last step in the example above show an interface given a name with the following format:

```
vlanXX.YYYY
```

Where XX is the bridge ID, and YYYY is the VLAN ID,

For example, the name, vlan1.3 indicates that VLAN IP's interface is in VLAN 3, and bridge-group 1.

CHAPTER 30 Policy Based Routing Configuration

This chapter contains a sample Policy Based Routing (PBR) configuration.

Overview

Policy Based Routing (PBR) is an advanced packet forwarding feature which is different from conventional destination address based routing. Policy Based Routing (PBR) allows data packets forwarding based on policies defined by network administrators.

In conventional routing, when a packet is received on the router, destination address in the packet is looked upon in the routing table and if the routing entry is found, packet is routed based on routing entry. In policy based routing, routing decision could be made from source address, destination address, transport protocol id, source port, destination port, or a combination of these criteria.

PBR includes a mechanism for selectively applying policies based on an access list or other criteria. Actions taken might include (a) Forwarding a packet to a directly connected ip nexthop (b) Black hole/Drop. If traffic doesn't match the route-map's match criteria, then it will be routed as if no PBR policy exists. PBR config is interface oriented, hence when applied it affects only the traffic ingressing on that interface. It does not apply on traffic egressing on that interface or traffic ingressing on an interface without a pbr route-map.

Topology

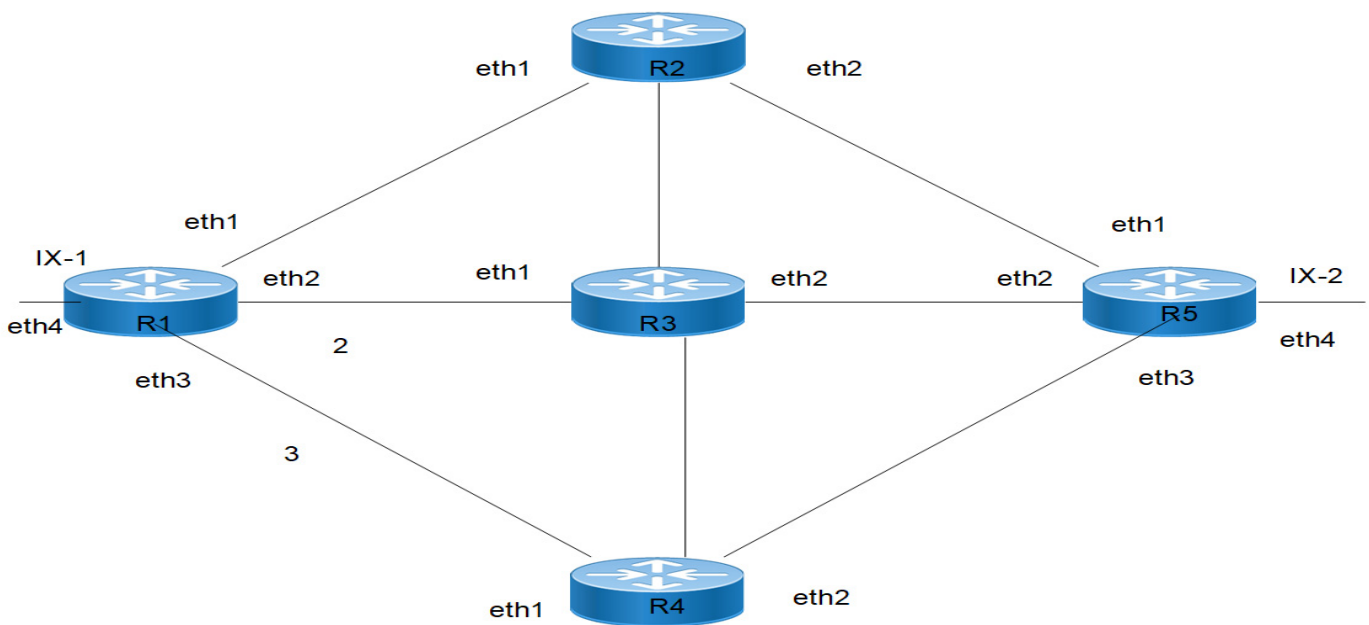

IPv4 Configurations for PBR

R1

R1#configure terminal	Enter configure mode.
R1(config)#feature pbr	Enable PBR support
R1(config)#hardware-profile filter ingress-ipv4-ext enable	Enable Ingress IPv4 group extended for PBR support
R1(config)#ip access-list 123	Create ip access-list named 123
R1(config-ip-acl)#10 permit any 101.1.1.0/24 201.1.1.0/24	Create an access rule to permit IP packets with source 101.1.1.0/24 and destination 201.1.1.0/24
R1(config-ip-acl)#commit	Commit the candidate configuration to the running configuration.
R1(config-ip-acl)#exit	Exit access-list mode
R1(config)#route-map 123 permit 10	Configure route-map with name 123 and sequence number 10
R1(config-route-map)#match ip address 123	Match ip address with ACL 123
R1(config-route-map)#set ip next-hop 13.1.1.2	Set next-hop to forward the matching IP packets
R1(config-route-map)#commit	Commit the candidate configuration to the running configuration.
R1(config-route-map)#exit	Exit route-map mode
R1(config)#interface lo	Enter interface mode.
R1(config-if)#ip address 1.1.1.1/32	Configure the IP address of the interface.
R1(config-if)#exit	Exit interface mode.
R1(config)#interface eth1	Enter interface mode.
R1(config-if)#ip address 2.1.1.1/24	Configure the IP address of the interface.
R1(config)#interface eth2	Enter interface mode.
R1(config-if)#ip address 6.1.1.1/24	Configure the IP address of the interface.
R1(config-if)#ip ospf cost 2	Configuring ospf cost as 2
R1(config)#interface eth3	Enter interface mode.
R1(config-if)#ip address 13.1.1.1/24	Configure the IP address of the interface.
R1(config-if)#ip ospf cost 3	Configuring ospf cost as 3
R1(config)#interface eth4	Enter interface mode.
R1(config-if)#ip address 101.1.1.2/24	Configure the IP address of the interface.
R1(config-if)#ip policy route-map 123	Attach PBR on the ingress interface
R1(config-if)#exit	Exit interface mode.
R1(config)#router ospf 1	Set the routing process ID .
R1(config-router)# ospf router-id 1.1.1.1	Configure OSPF router-id
R1(config-router)#network 1.1.1.1/32 area 0.0.0.0	Configure OSPF network in area 0
R1(config-router)# network 2.1.1.0/24 area 0.0.0.0	Configure OSPF network in area 0

R1(config-router)#network 6.1.1.0/24 area 0.0.0.0	Configure OSPF network in area 0
R1(config-router)#network 13.1.1.0/24 area 0.0.0.0	Configure OSPF network in area 0
R1(config-router)#network 101.1.1.0/24 area 0.0.0.0	Configure OSPF network in area 0
R1(config-router)#commit	Commit the candidate configuration to the running configuration.
R1(config-router)#exit	Exit router mode.

R2

R2#configure terminal	Enter configure mode.
R2(config)#interface lo	Enter interface mode.
R2(config-if)#ip address 2.2.2.2/32	Configure the IP address of the interface.
R2(config-if)#exit	Exit interface mode.
R2(config)#interface eth1	Enter interface mode.
R2(config-if)#ip address 2.1.1.2/24	Configure the IP address of the interface.
R2(config-if)#exit	Exit interface mode.
R2(config)#interface eth2	Enter interface mode.
R2(config-if)#ip address 10.1.1.1/24	Configure the IP address of the interface.
R2(config-if)#exit	Exit interface mode.
R2(config)#router ospf 1	Set the routing process ID .
R2(config-router)# ospf router-id 2.2.2.2	Configure OSPF router-id
R2(config-router)#network 2.2.2.2/32 area 0.0.0.0	Configure OSPF network in area 0
R2(config-router)# network 2.1.1.0/24 area 0.0.0.0	Configure OSPF network in area 0
R2(config-router)#network 10.1.1.0/24 area 0.0.0.0	Configure OSPF network in area 0
R2(config-router)#commit	Commit the candidate configuration to the running configuration.
R2(config-router)#exit	Exit router mode.

R3

R3#configure terminal	Enter configure mode.
R3(config)#interface lo	Enter interface mode.
R3(config-if)#ip address 3.3.3.3/32	Configure the IP address of the interface.
R3(config-if)#exit	Exit interface mode.
R3(config)#interface eth1	Enter interface mode.
R3(config-if)#ip address 6.1.1.2/24	Configure the IP address of the interface.
R3(config-if)#exit	Exit interface mode.
R3(config)#interface eth2	Enter interface mode.
R3(config-if)#ip address 12.1.1.1/24	Configure the IP address of the interface.

Policy Based Routing Configuration

R3(config-if)#exit	Exit interface mode.
R3(config)#router ospf 1	Set the routing process ID .
R3(config-router)# ospf router-id 3.3.3.3	Configure OSPF router-id
R3(config-router)#network 3.3.3.3/32 area 0.0.0.0	Configure OSPF network in area 0
R3(config-router)# network 6.1.1.0/24 area 0.0.0.0	Configure OSPF network in area 0
R3(config-router)#network 12.1.1.0/24 area 0.0.0.0	Configure OSPF network in area 0
R3(config-router)#commit	Commit the candidate configuration to the running configuration.
R3(config-router)#exit	Exit router mode.

R4

R4#configure terminal	Enter configure mode.
R4(config)#interface lo	Enter interface mode.
R4(config-if)#ip address 4.4.4.4/32	Configure the IP address of the interface.
R4(config-if)#exit	Exit interface mode.
R4(config)#interface eth1	Enter interface mode.
R4(config-if)#ip address 13.1.1.2/24	Configure the IP address of the interface.
R4(config-if)#exit	Exit interface mode.
R4(config)#interface eth2	Enter interface mode.
R4(config-if)#ip address 15.1.1.1/24	Configure the IP address of the interface.
R4(config-if)#exit	Exit interface mode.
R4(config)#router ospf 1	Set the routing process ID .
R4(config-router)# ospf router-id 4.4.4.4	Configure OSPF router-id
R4(config-router)#network 4.4.4.4/32 area 0.0.0.0	Configure OSPF network in area 0
R4(config-router)# network 13.1.1.0/24 area 0.0.0.0	Configure OSPF network in area 0
R4(config-router)#network 15.1.1.0/24 area 0.0.0.0	Configure OSPF network in area 0
R4(config-router)#commit	Commit the candidate configuration to the running configuration.
R4(config-router)#exit	Exit router mode.

R5

R5#configure terminal	Enter configure mode.
R5(config)#interface lo	Enter interface mode.
R5(config-if)#ip address 5.5.5.5/32	Configure the IP address of the interface.
R5(config-if)#exit	Exit interface mode.
R5(config)#interface eth1	Enter interface mode.
R5(config-if)#ip address 10.1.1.2/24	Configure the IP address of the interface.

R4(config-if)#exit	Exit interface mode.
R5(config)#interface eth2	Enter interface mode.
R5(config-if)#ip address 12.1.1.1/24	Configure the IP address of the interface.
R5(config-if)#exit	Exit interface mode.
R5(config)#interface eth3	Enter interface mode.
R5(config-if)#ip address 15.1.1.2/24	Configure the IP address of the interface.
R5(config-if)#exit	Exit interface mode.
R5(config)#interface eth4	Enter interface mode.
R5(config-if)#ip address 202.1.1.2/24	Configure the IP address of the interface.
R5(config-if)#exit	Exit interface mode.
R5(config)#router ospf 1	Set the routing process ID .
R5(config-router)# ospf router-id 5.5.5.5	Configure OSPF router-id
R5(config-router)#network 5.5.5.5/32 area 0.0.0.0	Configure OSPF network in area 0
R5(config-router)# network 10.1.1.0/24 area 0.0.0.0	Configure OSPF network in area 0
R5(config-router)# network 12.1.1.0/24 area 0.0.0.0	Configure OSPF network in area 0
R5(config-router)#network 15.1.1.0/24 area 0.0.0.0	Configure OSPF network in area 0
R5(config-router)#network 202.1.1.0/24 area 0.0.0.0	Configure OSPF network in area 0
R5(config-router)#commit	Commit the candidate configuration to the running configuration.
R5(config-router)#exit	Exit router mode.

Validation

R1

```

R1#show run aclmgr
ip access-list 123
 10 permit any 101.1.1.0/24 201.1.1.0/24
R1#show run interface eth4
!
interface eth4
 ip address 101.1.1.2/24
 ip policy route-map 123
!
R1#
R1#show route-map 123
route-map 123, permit, sequence 10
  Match clauses:
    ip address: 123
  Set clauses:
    ip next-hop 13.1.1.2
R1#
R1#show ip policy
Interface      Route-map      Status      VRF-Name

```

eth4 123 Active default

```
R1#
R1#clear route-map 123 pbr-statistics
R1#show route-map 123 pbr-statistics

Route-map 123, family IP
IP PBR Count: 1
VRF-name: default
  Sequence 10, permit
    Policy routing matches: 38764427 packets
    Current action in HW: Route
```

IPv6 Configurations for PBR

R1

R1#configure terminal	Enter configure mode.
R1(config)#feature pbr	Enable PBR support
R1(config)#hardware-profile filter ingress-ipv6 enable	Enable Ingress IPv6 group for PBR support
R1(config)# ipv6 access-list 123	Create ipv6 access-list named 123
R1(config-ipv6-acl)#10 permit any 101::/64 202::/64	Create an access rule to permit IPv6 packets with source 101::/64 and destination 202::/64
R1(config-ipv6-acl)#commit	Commit the candidate configuration to the running configuration.
R1(config-ipv6-acl)#exit	Exit access-list mode
R1(config)#route-map 123 permit 10	Configure route-map with name 123 and sequence number 10
R1(config-route-map)# match ipv6 address 123	Match ip address with ACL 123
R1(config-route-map)#set ipv6 next-hop 6111::2	Set next-hop to forward the matching IP packets
R1(config-route-map)#commit	Commit the candidate configuration to the running configuration.
R1(config-route-map)#exit	Exit route-map mode
R1(config)#interface lo	Enter interface mode.
R1(config-if)#ip address 1.1.1.1/32	Configure the IPv6 address of the interface.
R1(config-if)#exit	Exit interface mode.
R1(config)#router ipv6 ospf 100	Creating OSPFv3 routing instance
R1(config-router)#exit	Exit router mode.
R1(config)#interface eth1	Enter interface mode.
R1(config-if)#ipv6 address 2111::1/64	Configure the IPv6 address of the interface.
R1(config-if)#ipv6 router ospf area 0.0.0.0 tag 100	Enable OSPFv3 routing on an interface, and assign the Area ID 0.
R1(config-if)#exit	Exit interface mode.
R1(config)#interface eth2	Enter interface mode.

R1(config-if)#ipv6 address 6111::1/64	Configure the IPv6 address of the interface.
R1(config-if)#ipv6 router ospf area 0.0.0.0 tag 100	Enable OSPFv3 routing on an interface, and assign the Area ID 0.
R1(config-if)# ipv6 ospf cost 2	Configuring ospf cost as 2
R1(config-if)#exit	Exit interface mode.
R1(config)#interface eth3	Enter interface mode.
R1(config-if)#ipv6 address 1311::1/64	Configure the IPv6 address of the interface.
R1(config-if)#ipv6 router ospf area 0.0.0.0 tag 100	Enable OSPFv3 routing on an interface, and assign the Area ID 0.
R1(config-if)# ipv6 ospf cost 3	Configuring ospf cost as 3
R1(config-if)#exit	Exit interface mode.
R1(config)#interface eth4	Enter interface mode.
R1(config-if)#ipv6 router ospf area 0.0.0.0 tag 100	Enable OSPFv3 routing on an interface, and assign the Area ID 0.
R1(config-if)#ipv6 address 101::2/64	Configure the IPv6 address of the interface.
R1(config-if)#ipv6 policy route-map 123	Attach PBR on the ingress interface
R1(config-if)#commit	Commit the candidate configuration to the running configuration.
R1(config-if)#exit	Exit interface mode.

R2

R2#configure terminal	Enter configure mode.
R2(config)#interface lo	Enter interface mode.
R2(config-if)#ip address 2.2.2.2/32	Configure the IPv6 address of the interface.
R2(config-if)#exit	Exit interface mode.
R2(config)#router ipv6 ospf 100	Creating OSPFv3 routing instance
R2(config-router)#exit	Exit router mode.
R2(config)#interface eth1	Enter interface mode.
R2(config-if)#ipv6 address 2111::2/64	Configure the IPv6 address of the interface.
R2(config-if)#ipv6 router ospf area 0.0.0.0 tag 100	Enable OSPFv3 routing on an interface, and assign the Area ID 0.
R2(config-if)#exit	Exit interface mode.
R2(config)#interface eth2	Enter interface mode.
R2(config-if)#ipv6 address 1011::1/64	Configure the IPv6 address of the interface.
R2(config-if)#ipv6 router ospf area 0.0.0.0 tag 100	Enable OSPFv3 routing on an interface, and assign the Area ID 0.
R2(config-if)#commit	Commit the candidate configuration to the running configuration.
R2(config-if)#exit	Exit interface mode.

R3

R3#configure terminal	Enter configure mode.
R3(config)#router ipv6 ospf 100	Creating OSPFv3 routing instance
R3(config-router)#exit	Exit router mode.
R3(config)#interface lo	Enter interface mode.
R3(config-if)#ip address 3.3.3.3/32	Configure the IPv6 address of the interface.
R3(config-if)#exit	Exit interface mode.
R3(config)#interface eth1	Enter interface mode.
R3(config-if)#ipv6 address 6111::2/64	Configure the IPv6 address of the interface.
R3(config-if)#ipv6 router ospf area 0.0.0.0 tag 100	Enable OSPFv3 routing on an interface, and assign the Area ID 0.
R2(config-router)#exit	Exit router mode.
R3(config)#interface eth2	Enter interface mode.
R3(config-if)#ipv6 address 1211::1/64	Configure the IPv6 address of the interface.
R3(config-if)#ipv6 router ospf area 0.0.0.0 tag 100	Enable OSPFv3 routing on an interface, and assign the Area ID 0.
R2(config-if)#commit	Commit the candidate configuration to the running configuration.
R3(config-if)#exit	Exit interface mode.

R4

R4#configure terminal	Enter configure mode.
R4(config)#router ipv6 ospf 100	Creating OSPFv3 routing instance
R4(config-router)#exit	Exit router mode.
R4(config)#interface lo	Enter interface mode.
R4(config-if)#ip address 4.4.4.4/32	Configure the IPv6 address of the interface.
R4(config-if)#exit	Exit interface mode.
R4(config)#interface eth1	Enter interface mode.
R4(config-if)#ipv6 address 1311::2/64	Configure the IPv6 address of the interface.
R4(config-if)#ipv6 router ospf area 0.0.0.0 tag 100	Enable OSPFv3 routing on an interface, and assign the Area ID 0.
R4(config-if)#exit	Exit interface mode.
R4(config)#interface eth2	Enter interface mode.
R4(config-if)#ipv6 address 1511::1/64	Configure the IPv6 address of the interface.
R4(config-if)#ipv6 router ospf area 0.0.0.0 tag 100	Enable OSPFv3 routing on an interface, and assign the Area ID 0.
R4(config-if)#commit	Commit the candidate configuration to the running configuration.
R4(config-if)#exit	Exit interface mode.

R5

R5#configure terminal	Enter configure mode.
R5(config)#router ipv6 ospf 100	Creating OSPFv3 routing instance
R5(config-router)#exit	Exit router mode.
R5(config)#interface lo	Enter interface mode.
R5(config-if)#ip address 5.5.5.5/32	Configure the IPv6 address of the interface.
R5(config-if)#exit	Exit interface mode.
R5(config)#interface eth1	Enter interface mode.
R5(config-if)#ipv6 address 1011::2/64	Configure the IPv6 address of the interface.
R5(config-if)#ipv6 router ospf area 0.0.0.0 tag 100	Enable OSPFv3 routing on an interface, and assign the Area ID 0.
R5(config-if)#exit	Exit interface mode.
R5(config)#interface eth2	Enter interface mode.
R5(config-if)#ipv6 address 1211::2/64	Configure the IPv6 address of the interface.
R5(config-if)#ipv6 router ospf area 0.0.0.0 tag 100	Enable OSPFv3 routing on an interface, and assign the Area ID 0.
R5(config-if)#exit	Exit interface mode.
R5(config)#interface eth3	Enter interface mode.
R5(config-if)#ipv6 address 1511::2/64	Configure the IPv6 address of the interface.
R5(config-if)#ipv6 router ospf area 0.0.0.0 tag 100	Enable OSPFv3 routing on an interface, and assign the Area ID 0.
R5(config-if)#exit	Exit interface mode.
R5(config)#interface eth4	Enter interface mode.
R5(config-if)#ipv6 address 202::2/64	Configure the IPv6 address of the interface.
R5(config-if)#ipv6 router ospf area 0.0.0.0 tag 100	Enable OSPFv3 routing on an interface, and assign the Area ID 0.
R5(config-if)#commit	Commit the candidate configuration to the running configuration.
R5(config-if)#exit	Exit interface mode.

Validation**R1**

```

R1#show run aclmgr
ipv6 access-list 123
 10 permit any 101::/64 202::/64
 268435453 permit icmpv6 any any
R1#show run interface eth4
!
interface eth4
 ip address 101.1.1.2/24
 ipv6 address 101::2/64
 ipv6 policy route-map 123
 ipv6 router ospf area 0.0.0.0 tag 100
!
```

Policy Based Routing Configuration

```
R1#show route-map 123
route-map 123, permit, sequence 10
  Match clauses:
    ipv6 address: 123
  Set clauses:
    ipv6 next-hop 6111::2
```

```
R1#show ipv6 policy
Interface      Route-map      Status      VRF-Name      default
eth4           123            Active      default
```

```
R1#
R1#clear route-map 123 pbr-statistics
R1#sho route-map 123 pbr-statistics
```

```
Route-map 123, family IPv6
IPv6 PBR Count: 1
VRF-name: default
Sequence 10, permit
  Policy routing matches: 1077577 packets
  Current action in HW: Route
```

CHAPTER 31 Route-map Continue Configuration

This section contains Route-map continue configuration with BGP.

Overview

The continue clauses allow you to configure and organize more modular policy definitions to reduce the number of policy configurations that are repeated within the same route map.

Continue clause under a route-map provides the capability to execute additional entries in a route map after an entry is executed with a successful match and set clauses. The continue command allows multiple entries to be evaluated within a single route-map. Continue commands can be assigned optional sequence numbers that indicates the order in which clauses are to be evaluated.

Using Continue with Match Clauses

When a `match` clause exists in a route-map with continue clause then `continue` clause is executed only when a successful match occurs. If a `match` clause does not exist in the route-map and if a `continue` clause exists, the `continue` clause will be evaluated and will go to the specified route-map entry. When a successful match occurs and we have a `continue` clause, the route-map executes the `set` clauses and then goes to the specified route-map entry. If a `continue` clause does not exist in the next route map, then the route-map will behave normally. If a `continue` clause exists in the next route-map but a match is not successful, the route-map will not continue and will “fall through” to the next sequence number if one exists

Using Continue with Set Actions

`Set` clauses are executed after the route-map evaluation is done. The `set` clauses are evaluated and executed in the order in which they were configured. `Set` clauses are only executed after a successful match occurs. The `continue` statement proceeds to the specified route-map entry only after configured `set` actions are performed. If a `set` action is configured in the first route-map and then the same `set` action occurs again but with a different value, in a subsequent route-map entry, then the last `set` action will override the previous `set` actions which were configured with the same `set` command.

Topology

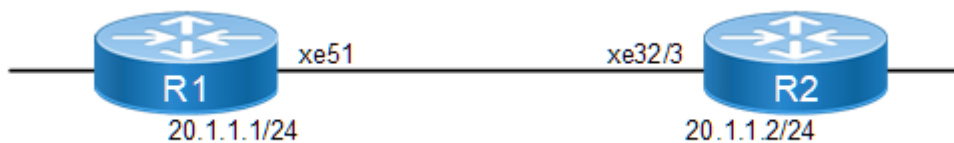

Figure 31-152: Route-map continue

Configure Route-map *continue* on R1

In the below example we will apply route-map `continue` on R1 under BGP 100, with redistributed connected routes from R2 on R1. Here, 10.1.0.0/16 is a superset, while 10.1.1.0/24, 10.1.2.0/24, 10.1.3.0/24, 10.1.4.0/24, and 10.1.5.0/24 are subsets and will filter PF1, which is a superset and sets several prefixes.

Route-map Continue Configuration

R1

R1#configure terminal	Enter configure mode.
R1(config)#interface xe51	Enter interface mode.
R1(config-if)#ip address 20.1.1.1/24	Configure the IP address of the interface.
R1(config-if)#commit	Commit the candidate configuration to the running configuration
R1(config-if)#exit	Exit interface mode.
R1(config)#ip prefix-list PF1	Configure IP prefix-list PF1
R1(config-ip-prefix-list)#seq 5 permit 10.1.0.0/16 le 32	Create an access rule to permit IP packets with Maximum prefix length match
R1(config-ip-prefix-list)#seq 10 permit 10.1.1.0/24 le 32	Create an access rule to permit IP packets with Maximum prefix length match
R1(config-ip-prefix-list)#seq 15 permit 10.1.2.0/24 le 32	Create an access rule to permit IP packets with Maximum prefix length match
R1(config-ip-prefix-list)#seq 20 permit 10.1.3.0/24 le 32	Create an access rule to permit IP packets with Maximum prefix length match
R1(config-if)#commit	Commit the candidate configuration to the running configuration
R1(config-if)#exit	Exit interface mode.
R1(config)#router bgp 100	Configure bgp process 100
R1(config-router)#bgp router-id 1.1.1.1	Configure bgp router id
R1(config-router)#neighbor 20.1.1.2 remote-as 100	Configure bgp remote-as 100 with neighbor IP
R1(config-router)#neighbor 20.1.1.2 route-map myid1 in	Configure bgp route-map myid1 as In bound policy with neighbor ip
R1(config-if)#commit	Commit the candidate configuration to the running configuration
R1(config-routed)#exit	Exit the router bgp mode
R1(config)#route-map myid1 permit 1	Configure route-map myid1 with sequence number 1
R1(config-route-map)match ip address prefix-list PF1	Match for prefix PF1
R1(config-route-map)continue	Configure continue command without sequence number
R1(config-route-map)set metric 10	Set metric as 10
R1(config-route-map)set weight 3465789	Set weight as 3465789
R1(config-route-map)route-map myid1 permit 2	Configure route-map myid1 with sequence number 2
R1(config-route-map)match ip address prefix-list P1	Match for IP prefix-list P1
R1(config-route-map)continue 3	Configure continue with sequence number 3
R1(config-route-map)set metric 20	Set metric as 20.
R1(config-route-map)set origin igp	Set origin as IGP protocol
R1(config-route-map)route-map myid1 permit 3	Configure route-map myid1 with sequence number 3
R1(config-route-map)match ip address prefix-list P2	Match for IP prefix-list P2
R1(config-route-map)continue 4	Configure continue with sequence number 4

R1(config-route-map)set metric 30	Set metric as 30.
R1(config-route-map)set as-path prepend 600	Set as-path prepend as 600
R1(config-route-map)route-map myid1 permit 4	Configure route-map myid1 with sequence number 4
R1(config-route-map)match ip address prefix-list P3	Match for IP prefix-list P3.
R1(config-route-map)set local-preference 400	Set local preference as 400
R1(config-route-map)set weight 400	Set weight as 400
R1(config-if)#commit	Commit the candidate configuration to the running configuration
R1(config-route-map)exit	End the route-map

R2

R2(config)#interface xe32/1	Enter interface mode.
R2(config-if)#ip address 10.1.1.1/24	Configure the IP address of the interface on an interface which is up and running
R2(config-if)#commit	Commit the candidate configuration to the running configuration
R2(config-if)#interface xe32/2	Enter interface mode.
R2(config-if)#ip address 10.1.2.1/24	Configure the IP address of the interface on an interface which is up and running
R2(config-if)#commit	Commit the candidate configuration to the running configuration
R2(config-if)#interface xe32/4	Enter interface mode.
R2(config-if)#ip address 10.1.3.1/24	Configure the IP address of the interface on an interface which is up and running
R2(config-if)#commit	Commit the candidate configuration to the running configuration
R2(config-if)#interface xe17/1	Enter interface mode.
R2(config-if)#ip address 10.1.4.1/24	Configure the IP address of the interface on an interface which is up and running
R2(config-if)#commit	Commit the candidate configuration to the running configuration
R2(config-if)#interface xe21/1	Enter interface mode.
R2(config-if)#ip address 10.1.5.1/24	Configure the IP address of the interface on an interface which is up and running
R2(config-if)#commit	Commit the candidate configuration to the running configuration
R2(config-if)#interface xe32/3	Enter interface mode.
R2(config-if)#ip address 20.1.1.2/24	Configure the IP address on the connected interface.
R2(config-if)#commit	Commit the candidate configuration to the running configuration
R2(config-if)#exit	Exit interface mode.
R2(config)#router bgp 100	Configure BGP process 100
R2(config-router)#bgp router-id 2.2.2.2	Configure BGP router id

Route-map Continue Configuration

R2(config-router)#neighbor 20.1.1.1 remote-as 100	Configure BGP remote-as 100 with neighbor IP
R2(config-router)#redistribute connected	Redistribute the connected routes which are 10 networks here.
R2(config-if)#commit	Commit the candidate configuration to the running configuration
R2(config-if)#exit	Exit interface mode.

Validation

R1

```
R1#show ip bgp summary
BGP router identifier 1.1.1.1, local AS number 100
BGP table version is 5
2 BGP AS-PATH entries
0 BGP community entries
```

Neighbor	V	AS	MsgRcv	MsgSen	TblVer	InQ	OutQ	Up/
Down State/PfxRcd								
20.1.1.2	4	100	145	177	5	0	0	
00:40:05	5							

Total number of neighbors 1

Total number of Established sessions 1

Note: Check the prefixes learnt here are 5.

R1#

```
R1#show ip bgp
BGP table version is 5, local router ID is 1.1.1.1
Status codes: s suppressed, d damped, h history, * valid, > best, i -
internal,
                l - labeled, S Stale
Origin codes: i - IGP, e - EGP, ? - incomplete
```

	Network	Next Hop	Metric	LocPrf	Weight	Path
*>i	10.1.1.0/24	20.1.1.2	20	100	3465789	i
*>i	10.1.2.0/24	20.1.1.2	30	100	3465789	600
?						
*>i	10.1.3.0/24	20.1.1.2	10	400	400	?
*>i	10.1.4.0/24	20.1.1.2	10	100	3465789	?
*>i	10.1.5.0/24	20.1.1.2	10	100	3465789	?

Total number of prefixes 5

R1#

Note: In the above example, 10.1.4.0/24 and 10.1.5.0/24 prefixes will match only on PF1 which is a super set prefix and metric is set as 10, while the 10.1.1.0/24, 10.1.2.0/24 and 10.1.3.0/24 prefixes will match in P1, P2 and P3 prefix-lists and execute the set clauses respectively.

```
R1#show ip route
Codes: K - kernel, C - connected, S - static, R - RIP, B - BGP
       O - OSPF, IA - OSPF inter area
       N1 - OSPF NSSA external type 1, N2 - OSPF NSSA external type 2
       E1 - OSPF external type 1, E2 - OSPF external type 2
       i - IS-IS, L1 - IS-IS level-1, L2 - IS-IS level-2,
       ia - IS-IS inter area, E - EVPN,
       v - vrf leaked
       * - candidate default
```

```
IP Route Table for VRF "default"
```

```
B 10.1.1.0/24 [200/20] via 20.1.1.2, xe51, 00:45:05
B 10.1.2.0/24 [200/30] via 20.1.1.2, xe51, 00:45:05
B 10.1.3.0/24 [200/10] via 20.1.1.2, xe51, 00:45:05
B 10.1.4.0/24 [200/10] via 20.1.1.2, xe51, 00:25:05
B 10.1.5.0/24 [200/10] via 20.1.1.2, xe51, 00:24:35
C 20.1.1.0/24 is directly connected, xe51, 01:00:40
C 127.0.0.0/8 is directly connected, lo, 02:26:41
```

```
Gateway of last resort is not set
```

```
R1#
```

```
R1#show ip bgp route-map myidl
```

```
BGP table version is 5, local router ID is 1.1.1.1
```

```
Status codes: s suppressed, d damped, h history, * valid, > best, i -
internal,
```

```
l - labeled, S Stale
```

```
Origin codes: i - IGP, e - EGP, ? - incomplete
```

Network	Next Hop	Metric	LocPrf	Weight	Path
*>i 10.1.1.0/24	20.1.1.2	20	100	3465789	i
*>i 10.1.2.0/24	20.1.1.2	30	100	3465789	600
?					
*>i 10.1.3.0/24	20.1.1.2	10	400	400	?
*>i 10.1.4.0/24	20.1.1.2	10	100	3465789	?
*>i 10.1.5.0/24	20.1.1.2	10	100	3465789	?

```
Total number of prefixes 5
```

```
R1#
```

```
R1#
```

R2

```
R2#show ip bgp summary
```

```
BGP router identifier 2.2.2.2, local AS number 100
```

```
BGP table version is 3
```

```
1 BGP AS-PATH entries
```

```
0 BGP community entries
```

Neighbor	V	AS	MsgRcv	MsgSen	TblVer	InQ	OutQ	Up/
Down State/PfxRcd								
20.1.1.1	4	100	133	133	3	0	0	
00:39:57	0							

```
Total number of neighbors 1
```

```
Total number of Established sessions 1
```

Route-map Continue Configuration

R2#
R2#

```
R2#show ip bgp
BGP table version is 3, local router ID is 2.2.2.2
Status codes: s suppressed, d damped, h history, * valid, > best, i -
internal,
                l - labeled, S Stale
Origin codes: i - IGP, e - EGP, ? - incomplete
```

	Network	Next Hop	Metric	LocPrf	Weight	Path
*>	10.1.1.0/24	0.0.0.0	0	100	32768	?
*>	10.1.2.0/24	0.0.0.0	0	100	32768	?
*>	10.1.3.0/24	0.0.0.0	0	100	32768	?
*>	10.1.4.0/24	0.0.0.0	0	100	32768	?
*>	10.1.5.0/24	0.0.0.0	0	100	32768	?
*>	20.1.1.0/24	0.0.0.0	0	100	32768	?

```
Total number of prefixes 6
R2#
```

```
R2#show ip route
Codes: K - kernel, C - connected, S - static, R - RIP, B - BGP
       O - OSPF, IA - OSPF inter area
       N1 - OSPF NSSA external type 1, N2 - OSPF NSSA external type 2
       E1 - OSPF external type 1, E2 - OSPF external type 2
       i - IS-IS, L1 - IS-IS level-1, L2 - IS-IS level-2,
       ia - IS-IS inter area, E - EVPN,
       v - vrf leaked
       * - candidate default
```

```
IP Route Table for VRF "default"
C    10.1.1.0/24 is directly connected, xe32/1, 01:02:22
C    10.1.2.0/24 is directly connected, xe32/2, 01:01:46
C    10.1.3.0/24 is directly connected, xe32/4, 01:02:21
C    10.1.4.0/24 is directly connected, xe17/1, 00:26:52
C    10.1.5.0/24 is directly connected, xe21/1, 00:26:32
C    20.1.1.0/24 is directly connected, xe32/3, 01:02:22
C    127.0.0.0/8 is directly connected, lo, 01:34:40
```

```
Gateway of last resort is not set
R2#
```

Route-map Show Commands

```
R1#show running-config route-map
!
route-map myid1 permit 1
  match ip address prefix-list PF1
  continue
  set metric 10
  set weight 3465789
!
route-map myid1 permit 2
```



```
match ip address prefix-list P1
continue 3
set metric 20
set origin igp
!
route-map myid1 permit 3
match ip address prefix-list P2
continue 4
set metric 30
set as-path prepend 600
!
route-map myid1 permit 4
match ip address prefix-list P3
set local-preference 400
set weight 400
!
R1#
R1#show route-map
route-map myid1, permit, sequence 1
  Match clauses:
    ip address prefix-list: PF1
  Continue clause:  next sequence
  Set clauses:
    metric 10
    weight 3465789
route-map myid1, permit, sequence 2
  Match clauses:
    ip address prefix-list: P1
  Continue clause:  sequence 3:
  Set clauses:
    metric 20
    origin igp
route-map myid1, permit, sequence 3
  Match clauses:
    ip address prefix-list: P2
  Continue clause:  sequence 4:
  Set clauses:
    metric 30
    as-path prepend 600
route-map myid1, permit, sequence 4
  Match clauses:
    ip address prefix-list: P3
  Set clauses:
    local-preference 400
    weight 400
```

CHAPTER 32 TOS based Queue Distribution Configuration

This feature allows both type of configuration (precedence or DSCP). Before the implementation of this feature only allows DSCP profiles. The most significant three bits of the DSCP are Class Selector bits, which provides backward compatibility with ip precedence.

We will utilize these DSCP bits to set Precedence. For example when user configure Precedence 101 in CLI, we just need to convert this value to DSCPs(101000 ~ 101111), then normally set the DSCP.

Indicate the standards to be imposed or other all-embracing blanket requirements.

On the basis of already existing DSCP profiles, new precedence profiles are introducing as qos map-profile in this chapter.

The working on these precedence profile is similar to that of DSCP but now we can permit both the configurations according to our requirement.

There are 2 Qos-map Precedence profiles introduced:

- Precedence-to-queue
- Precedence-to-precedence

Precedence-to-queue

This is an ingress profile similar to dscp-to-queue. This profile will map precedence value 0-7 to queue 0-7.

Topology



Figure 32-153: Precedence-to-queue topology

Configuration

Basic configuration

#configure terminal	Enter configure mode
(config)#enable qos	Enable Qos
(config)#exit	Exit configure mode
(config)# qos profile precedence-to-queue Prece1_que1	Configure qos-map profile precedence-to-queue with Profile name as Prece1_que1
(config-ingress-prec-map)# precedence 1 queue 2	Configure mapping of prece 1 to queue 2, so that traffic with precedence 1 should take queue as q2
(config)#exit	Exit configure mode
(config)# interface xe1	Configure ingress interface xe1
(config-if)#qos map-profile precedence-to-queue Prece1_que1	Map the profile Prec1_que1 to interface xe1 so that ingress traffic hitting the xe1 interface with prece as 1 should take queue q2

(config-if)#commit	Commit the configuration
(config-if)#end	Exit the configuration.

Validation

```
#show run int xel
!  
interface xel
  qos map-profile precedence-to-queue Precl_que1
!
```

```
#show qos-profile type precedence-to-queue
profile name: Precl_que1
profile type: precedence-to-queue
profile attached to 1 instances
configured mapping:
precedence 1 queue 2
Detailed mapping:
```

INPUT	OUTPUT
PREC	Queue Out PREC
0	0 0
1	1 2
2	2 0
3	3 0
4	4 0
5	5 0
6	6 0
7	7 0

```
R1#show run qos
qos enable
!  
qos profile precedence-to-queue Precl_que1
  precedence 1 queue 2
!  
interface xel
  qos map-profile precedence-to-queue Precl_que1
!
```

Precedence-to-precedence

This is an egress profile similar to dscp-to-dscp. This profile will map precedence value 0-7 to precedence value 0-7. It will change the egress queue according to new mapped precedence value.

Topology

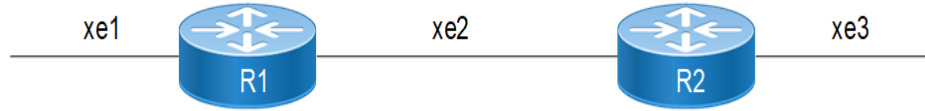

Figure 32-154: Precedence-to-precedence topology

Basic configuration

#configure terminal	Enter configure mode
(config)#enable qos	Enable Qos
(config)#exit	Exit configure mode
(config)# qos profile precedence-to- precedence prec_prec2	Configure qos-map profile precedence-to-precedence with Profile name as prec_prec2
(config-ingress-prec-map)# precedence 2 precedence 5	Configure mapping of prece 2 to precedence 5, so that traffic with precedence 2 should remark to precedence 5 and should take corresponding queue q5 on next DUT
(config)#exit	Exit configure mode
(config)# interface xe2	Configure ingress interface xe2
(config-if)#qos map-profile precedence-to- queue prec_prec2	Map the profile prec_prec2 to egress interface xe2 of 1st node.
(config-if)#commit	Commit the configuration
(config-if)#end	Exit the configuration.

Valodation

```

#show run qos
qos enable
!
qos profile precedence-to-precedence prec_prec2
  precedence 2 precedence 5
!
!
!
!
interface xe2
  qos map-profile precedence-to-precedence prec_prec2
!

#show qos-profile prec_prec2
profile name: prec_prec2
profile type: precedence-to-precedence
profile attached to 1 instances
configured mapping:
  precedence 2 precedence 5
Detailed mapping:
-----+-----

```

TOS based Queue Distribution Configuration

INPUT	OUTPUT
PREC	PREC
0	0
1	1
2	5
3	3
4	4
5	5
6	6
7	7

CHAPTER 33 BGP Flowspec Support for IPv4

This chapter contains configurations of BGP Flowspec support for ipv4.

The BGP flow specification (flowspec) feature allows users to rapidly deploy and propagate filtering and policing functionality among a large number of BGP peer routers to mitigate the effects of a distributed denial-of-service (DDoS) attack over your network.

The BGP flowspec, specifically stated in here, allows users effectively to construct instructions to match a particular flow with source, destination, L4 parameters and packet specifics such as length, fragment and so on. Flowspec allows for a dynamic installation of an action at the border routers to either:

- Drop the traffic
- Inject it in a different VRF for analysis or
- Allow it, but police it at a specific defined rate

Topology

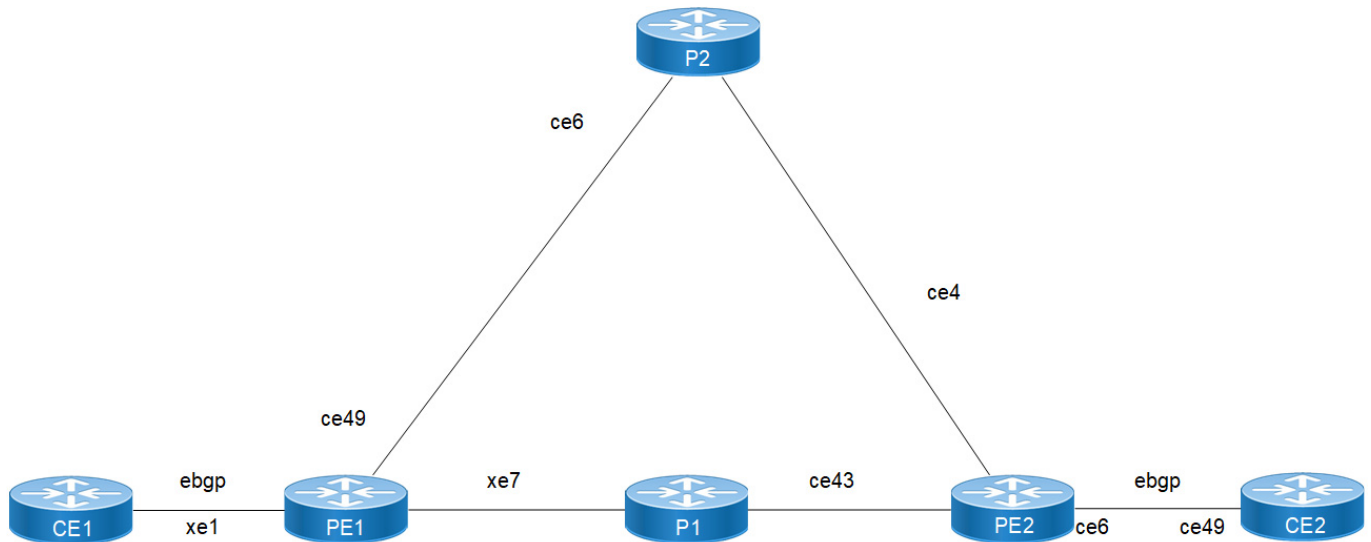

Figure 33-155: BGP Flowspec support for IPv4

Configuration

CE1

CE1#configure terminal	Enter configure mode.
CE1(config)# class-map type traffic match-all ocnos	Configure class map with class name
CE1(config-cmap-tr)#match destination-address ipv4 3.3.3.3/32	Configure match with destination ip address
CE1(config-cmap-tr)#match source-address ipv4 3.3.3.3/32	Enable match with source ip address
CE1(config-cmap-tr)# match destination-port 44-144	Enable match with destination port

BGP Flowspec Support for IPv4

CE1 (config-cmap-tr) #exit	Exit from class map traffic
CE1 (config) #commit	Commits the configuration
CE1 (config) #class-map type traffic match-all ocnos2	Configure class map with class name
CE1 (config-cmap-tr) # match destination-address ipv4 10.1.1.0/24	Configure match with destination ip address
CE1 (config-cmap-tr) # match source-address ipv4 10.1.1.0/24	Enable match with source ip address
CE1 (config-cmap-tr) # match source-port 22-122	Enter match with source port
CE1 (config-cmap-tr) #exit	Exit from class map traffic
CE1 (config) #commit	Commits the configuration
CE1 (config) #policy-map type pbr CE1	Configure policy map type pbr with policy name
CE1 (config-pmap-pbr) # class type traffic ocnos2	Enter class map traffic class name
CE1 (config-pmap-pbr-c) # police rate 21000 bps	Enable policy rate
CE1 (config-pmap-pbr-c) #exit	Exit from policy map traffic
CE1 (config-pmap-pbr) #exit	Exit from policy map
CE1 (config) #policy-map type pbr PE1	Configure policy map type pbr with policy name
CE1 (config-pmap-pbr) # class type traffic ocnos	Enter class map traffic class name
CE1 (config-pmap-pbr-c) # police rate 4444444 bps	Enable policy rate
CE1 (config-cmap-tr) #exit	Exit from class map
CE1 (config) #commit	Commits the configuration
CE1 (config) #flowspec	Configure flowspec
CE1 (config-flowspec) #address-family ipv4	Enter address-family mode with ipv4
CE1 (config-flowspec-af) #service-policy type pbr PE1	Enable service policy type pbr with policy name
CE1 (config-flowspec-af) #service-policy type pbr CE1	Enable service policy type pbr with policy name
CE1 (config-flowspec-af) #exit	Exit from address family mode
CE1 (config-flowspec) #commit	Commits the configuration
CE1 (config) #interface xe1	Enter interface mode
CE1 (config-if) #ip address 10.1.1.1/24	Configure ip address
CE1 (config-if) #exit	Exit from interface mode
CE1 (config) #interface xe1.10	Enter the sub interface mode
CE1 (config-if) # encapsulation dot1q 10	Enable encapsulate dot 1q
CE1 (config-if) # ip address 66.1.1.1/24	Configure ip address
CE1 (config-if) #exit	Exit from interface mode
CE1 (config) #commit	Commits the configuration
CE1 (config) #router bgp 100	Configure bgp instance
CE1 (config-router) #neighbor 10.1.1.2 remote-as 65000	Enable neighbour ip address with remote-as 65000

CE1(config-router)# neighbor 66.1.1.2 remote-as 65000	Enable neighbour ip address with remote-as 65000
CE1(config-router)#address-family ipv4 unicast	Enter address family ipv4 unicast mode
CE1(config-router-af)#redistribute connected	Enable redistribute connected
CE1(config-router-af)#neighbor 10.1.1.2 activate	Activate the neighbour
CE1(config-router-af)#neighbor 66.1.1.2 activate	Activate the neighbour
CE1(config-router-af)#exit-address-family	Exit from address family mode
CE1(config-router)#address-family ipv4 flowspec	Enter address family ipv4 flowspec mode
CE1(config-router-af)#neighbor 10.1.1.2 activate	Activate the neighbour
CE1(config-router-af)#neighbor 66.1.1.2 activate	Activate the neighbour
CE1(config-router-af)#exit-address-family	Exit from address family mode
CE1(config-router)#exit	Exit from router mode
CE1(config)#commit	Commits the configuration

PE1

PE1#configure terminal	Enter configure mode.
PE1(config)#ip vrf vrf100	Enter vrf vrf name
PE1(config-vrf)# rd 100:1	Enter rd value
PE1(config-vrf)# route-target both 100:1	Enter router targeted as both
PE1(config-vrf)#exit	Exit from vrf mode
PE1(config)#commit	Commits the configuration
PE1(config)#ip vrf vrf101	Enter vrf vrf name
PE1(config-vrf)# rd 101:1	Enter rd value
PE1(config-vrf)# route-target both 101:1	Enter router targeted as both
PE1(config-vrf)#exit	Exit from vrf mode
PE1(config)#commit	Commits the configuration
PE1(config)#qos enable	Enable qos
PE1(config)#qos statistics	Enable qos statistics
PE1(config)#class-map type traffic match-all clas1	Configure class map with class name
PE1(config-cmap-tr)# match destination- address ipv4 4.4.4.4/32	Configure match with destination ip address
PE1(config-cmap-tr)# match destination-port 400-499	Enable match with destination-port
PE1(config-cmap-tr)#exit	Exit from class map traffic mode
PE1(config)#commit	Commits the configuration
PE1(config)#policy-map type pbr pol1	Configure policy map type pbr with policy name

BGP Flowspec Support for IPv4

PE1(config-pmap-pbr)# class type traffic clas1	Enable class type traffic with class map name
PE1(config-pmap-pbr-c)# redirect ipv4 extcommunity rt 100:10	Enable redirect ipv4 extcommunity with rt
PE1(config-pmap-pbr-c)#exit	Exit from policy map traffic
PE1(config-pmap-pbr)#exit	Exit from policy map
PE1(config)#commit	Commits the configuration
PE1(config)#flowspec	Configure flowspec
PE1(config-flowspec)# address-family ipv4	Enter address-family mode with ipv4
PE1(config-flowspec-af)# service-policy type pbr poll	Enable service policy type pbr with policy name
PE1(config-flowspec-af)#exit	Exit from address family mode
PE1(config-flowspec)#exit	Exit from flowspec mode
PE1(config)#commit	Commits the configuration
PE1(config)#router ldp	Configure router ldp
PE1(config-router)# targeted-peer ipv4 3.3.3.3	Configure targeted peer ipv4 address
PE1(config-router-targeted-peer)# exit-targeted-peer-mode	Exit from targeted peer mode
PE1(config-router)#exit	Exit from router mode
PE1(config)#commit	Commits the configuration
PE1(config)#interface lo	Enter interface mode
PE1(config-if)# ip address 1.1.1.1/32 secondary	Assign ip address as secondary
PE1(config-if)# ip router isis 1	Enable router isis instance
PE1(config-if)#exit	Exit from interface mode
PE1(config)#commit	Commits the configuration
PE1(config)#interface ce51	Enter interface mode
PE1(config-if)# ip address 40.1.1.1/24	Assign ip address
PE1(config-if)# label-switching	Enable label switching
PE1(config-if)# ip router isis 1	Enable router isis instance
PE1(config-if)# enable-ldp ipv4	Enable ldp ipv4
PE1(config-if)#exit	Exit from interface mode
PE1(config)#commit	Commits the configuration
PE1(config)#interface xe1	Enter interface mode
PE1(config-if)# ip vrf forwarding vrf100	Enable vrf forwarding with vrf name
PE1(config-if)# ip address 10.1.1.2/24	Assign the ip address
PE1(config-if)#exit	Exit from interface mode
PE1(config)#commit	Commits the configuration
PE1-7026(config)#interface xe1.10	Enter the sub interface mode
PE1-7026(config-if)# encapsulation dot1q 10	Enable encapsulate dot 1q
PE1-7026(config-if)# ip vrf forwarding vrf100	Enable vrf forwarding under interface

PE1-7026(config-if)# ip address 66.1.1.2/24	Assign the ip address
PE1-7026(config-if)#exit	Exit from interface mode
PE1(config)#interface xe7	Enter the interface mode
PE1(config-if)# ip address 20.1.1.1/24	Enter ip address
PE1(config-if)# label-switching	Enable label switching
PE1(config-if)# ip router isis 1	Enable router isis instance
PE1(config-if)# enable-ldp ipv4	Enable ldp ipv4
PE1(config-if)#exit	Exit from interface mode
PE1(config)#commit	Commits the configuration
PE1(config)#router isis 1	Configure isis instance
PE1(config-router)# is-type level-1-2	Enable is-type level-1-2
PE1(config-router)# metric-style wide	Enable metric style wide
PE1(config-router)# mpls traffic-eng router-id 1.1.1.1	Enter router id
PE1(config-router)# mpls traffic-eng level-1	Enable traffic engg level-1
PE1(config-router)# mpls traffic-eng level-2	Enable traffic engg level-2
PE1(config-router)# dynamic-hostname	Enable hostname
PE1(config-router)# bfd all-interfaces	Enable bfd all the interfaces
PE1(config-router)# net 49.0000.0000.0001.00	Enter network id
PE1(config-router)#exit	Exit from isis instance
PE1(config)#commit	Commits the configuration
PE1(config)#router bgp 65000	Configure bgp instance
PE1(config-router)# neighbor 3.3.3.3 remote-as 65000	Enable neighbour address with remote-as 65000
PE1(config-router)#neighbor 10.1.1.1 remote-as 100	Enable neighbour address with remote-as 100
PE1(config-router)#neighbor 3.3.3.3 update-source lo	Enable neighbour address with update loppbacl
PE1(config-router)# address-family ipv4 unicast	Enter address family ipv4 unicast mode
PE1(config-router-af)# neighbor 3.3.3.3 activate	Activate the neighbour
PE1(config-router-af)# neighbor 10.1.1.1 activate	Activate the neighbour
PE1(config-router-af)# exit-address-family	Exit from address family mode
PE1(config-router)# address-family vpnv4 unicast	Enter address family vpnv4 mode
PE1(config-router-af)# neighbor 3.3.3.3 activate	Activate the neighbour
PE1(config-router-af)# exit-address-family	Exit from address family
PE1(config-router)# address-family ipv4 flowspec	Enter address family ipv4 flowspec mode
PE1(config-router-af)# neighbor 3.3.3.3 activate	Activate the neighbour

BGP Flowspec Support for IPv4

PE1(config-router-af)# neighbor 10.1.1.1 activate	Activate the neighbour
PE1(config-router-af)# exit-address-family	Exit from address family
PE1(config-router)# address-family vpnv4 flowspec	Enter address family vpnv4 flowpsec mode
PE1(config-router-af)# neighbor 3.3.3.3 activate	Activate the neighbour
PE1(config-router-af)# exit-address-family	Exit from address family
PE1(config-router)# address-family ipv4 vrf vrf100	Enter address family ipv4 vrf mode
PE1(config-router-af)# neighbor 66.1.1.1 remote-as 100	Enter neighbor ip add with remote-as 100
PE1(config-router-af)# neighbor 66.1.1.1 activate	Activate the neighbour
PE1(config-router)# address-family ipv4 flowspec vrf vrf100	Enter address family ipv4 vrf flowspec mode
PE1(config-router-af)# neighbor 66.1.1.1 activate	Activate the neighbour
PE1(config-router-af)# exit-address-family	Exit from address family
PE1(config-router)#exit	Exit from router mode
PE1(config)#commit	Commits the configuration

P1

P1#configure terminal	Enter configure mode.
P1(config)#router ldp	Enter router ldp
P1(config-router)#exit	Exit from ldp mode
P1(config)#commit	Commits the configuration
P1(config)#interface lo	Enter interface mode
P1(config-if)#ip address 2.2.2.2/32 secondary	Assigned ip add as secondary
P1(config-if)# ip router isis 1	Enter isis instance
P1(config-if)#exit	Exit from interface mode
P1(config)#commit	Commits the configuration
P1(config)#interface ce43	Enter interface mode
P1(config-if)# speed 40g	Set the speed
P1(config-if)# ip address 11.1.1.2/24	Assign the ip add
P1(config-if)# label-switching	Enable label switching
P1(config-if)# ip router isis 1	Enter router isis instance
P1(config-if)# enable-ldp ipv4	Enable ldp ipv4
P1(config-if)#exit	Exit from interface mode
P1(config)#commit	Commits the configuration
P1(config)#interface xe7	Enter interface mode
P1(config-if)# ip address 20.1.1.2/24	Assign the ip add
P1(config-if)# label-switching	Enable label switching

P1(config-if)# ip router isis 1	Enter router isis instance
P1(config-if)# enable-ldp ipv4	Enable ldp ipv4
P1(config-if)#exit	Exit from interface mode
P1(config)#commit	Commits the configuration
P1(config)#router isis 1	Configure isis instance
P1(config-router)# is-type level-1-2	Configure is-type-level-1-2
P1(config-router)# metric-style wide	Configure metric style wide
P1(config-router)# mpls traffic-eng router-id 2.2.2.2	Configure router id
P1(config-router)# mpls traffic-eng level-1	Configure traffic engg level-1
P1(config-router)# mpls traffic-eng level-2	Configure traffic engg level-2
P1(config-router)# dynamic-hostname	Configure hostname
P1(config-router)# bfd all-interfaces	Enable bfd all interfaces
P1(config-router)# net 49.0000.0000.0002.00	Configure network id
P1(config-router)#exit	Exit from isis instance mode
P1(config)#commit	Commits the configuration

P2

P2#configure terminal	Enter configure mode.
P2(config)#router ldp	Enter router ldp
P2(config-router)#exit	Exit from ldp mode
P2(config)#commit	Commits the configuration
P2(config)#interface lo	Enter the interface mode
P2(config-if)# ip address 6.6.6.6/32 secondary	Assign the ip address secondary
P2(config-if)# ip router isis 1	Enter router isis instance
P2(config-if)#exit	Exit from interface mode
P2(config)#commit	Commits the configuration
P2(config)#interface ce53	Enter the interface mode
P2(config-if)# ip address 50.1.1.2/24	Assign the ip add
P2(config-if)# label-switching	Enable label switching
P2(config-if)# ip router isis 1	Enter router isis instance
P2(config-if)# enable-ldp ipv4	Enable ldp ipv4
P2(config-if)#exit	Exit from interface mode
P2(config)#commit	Commits the configuration
P2(config)#interface ce51	Enter the interface mode
P2(config-if)# ip address 40.1.1.2/24	Assign the ip add
P2(config-if)# label-switching	Enable label switching
P2(config-if)# ip router isis 1	Enter router isis instance
P2(config-if)# enable-ldp ipv4	Enable ldp ipv4
P2(config-if)#exit	Exit from interface mode

BGP Flowspec Support for IPv4

P2(config)#commit	Commits the configuration
P2(config)#router isis 1	Configure isis instance
P2(config-router)# is-type level-1-2	Configure is-type-level-1-2
P2(config-router)# metric-style wide	Configure metric style wide
P2(config-router)# mpls traffic-eng router-id 6.6.6.6	Configure router id
P2(config-router)# mpls traffic-eng level-1	Configure traffic engg level-1
P2(config-router)# mpls traffic-eng level-2	Configure traffic engg level-2
P2(config-router)# dynamic-hostname	Configure hostname
P2(config-router)# bfd all-interfaces	Enable bfd all interfaces
P2(config-router)# net 49.0000.0000.0006.00	Configure network id
P2(config-router)#exit	Exit from isis instance mode
P2(config)#commit	Commits the configuration

PE2

PE2#configure terminal	Enter configure mode.
PE2(config)#router ldp	Configure router ldp
PE2(config-router)# targeted-peer ipv4 1.1.1.1	Configure targeted peer ipv4 address
PE2(config-router-targeted-peer)#exit-targeted-peer-mode	Exit from targeted peer mode
PE2(config-router)#exit	Exit from router mode
PE2(config)#commit	Commits the configuration
PE2(config)#ip vrf vrf100	Enter vrf vrf name
PE2(config-vrf)# rd 100:1	Enter rd value
PE2(config-vrf)# route-target both 100:1	Enter router targeted as both
PE2(config-vrf)#exit	Exit from vrf mode
PE2(config)#commit	Commits the configuration
PE2(config)#ip vrf vrf101	Enter vrf vrf name
PE2(config-vrf)# rd 101:1	Enter rd value
PE2(config-vrf)# route-target both 101:1	Enter router targeted as both
PE2(config-vrf)#exit	Exit from vrf mode
PE2(config)#commit	Commits the configuration
PE2(config)#class-map type traffic match-all cl1	Configure class map with class name
PE2(config-cmap-tr)# match destination-address ipv4 1.1.1.1/32	Configure match with destination ip address
PE2(config-cmap-tr)# match source-address ipv4 3.3.3.3/32	Enable match with source ip address
PE2(config-cmap-tr)# match destination-port 300-399	Enable match with destination-port
PE2(config-cmap-tr)#exit	Exit from class map traffic mode
PE2(config)#commit	Commits the configuration

PE2(config)#policy-map type pbr poll	Configure policy map type pbr with policy name
PE2(config-pmap-pbr)# class type traffic c11	Enable class type traffic with class map name
PE2(config-pmap-pbr-c)# police rate 1111111 bps	Enable policy rate
PE2(config-pmap-pbr-c)#exit	Exit from policy map traffic
PE2(config-pmap-pbr)#exit	Exit from policy map
PE2(config)#commit	Commits the configuration
PE2(config)#flowspec	Configure flowspec
PE2(config-flowspec)# address-family ipv4	Enter address-family mode with ipv4
PE2(config-flowspec-af)# service-policy type pbr poll	Enable service policy type pbr with policy name
PE2(config-flowspec-af)#exit	Exit from address family mode
PE2(config-flowspec)#exit	Exit from flowspec mode
PE2(config)#commit	Commits the configuration
PE2(config)#interface lo	Enter the interface mode
PE2(config-if)# ip address 3.3.3.3/32 secondary	Assign the ip add secondary
PE2(config-if)# ip router isis 1	Enter router isis instance
PE2(config-if)#exit	Exit from interface mode
PE2(config)#commit	Commits the configuration
PE2(config)#interface ce4	Enter the interface mode
PE2(config-if)# ip address 50.1.1.1/24	Assign the ip add
PE2(config-if)# label-switching	Enable label switching
PE2(config-if)# ip router isis 1	Enter router isis instance
PE2(config-if)# enable-ldp ipv4	Enable ldp ipv4
PE2(config-if)#exit	Exit from interface mode
PE2(config)#commit	Commits the configuration
PE2(config)#interface ce43	Enter the interface mode
PE2(config-if)# speed 40g	Set the interface speed
PE2(config-if)# ip address 11.1.1.1/24	Assign the ip add
PE2(config-if)# label-switching	Enable label switching
PE2(config-if)# ip router isis 1	Enter router isis instance
PE2(config-if)#enable-ldp ipv4	Enable ldp ipv4
PE2(config-if)#exit	Exit from interface mode
PE2(config)#commit	Commits the configuration
PE2(config)#interface ce6	Enter the interface mode
PE2(config-if)# ip address 30.1.1.2/24	Assign the ip add
PE2(config-if)#exit	Exit from interface mode
PE2(config)#commit	Commits the configuration
PE2-7023(config)#interface ce6.10	Enter the sub interface mode
PE2-7023(config-if)# encapsulation dot1q 10	Enable encapsulate dot 1q

BGP Flowspec Support for IPv4

PE2-7023(config-if)# ip vrf forwarding vrf100	Enable vrf forwarding vrf under interface
PE2-7023(config-if)# ip address 55.1.1.1/24	Assign the ip add
PE2-7023(config-if)#exit	Exit from interface mode
PE2(config)#router isis 1	Configure isis instance
PE2(config-router)# is-type level-1-2	Configure is-type-level-1-2
PE2(config-router)# metric-style wide	Configure metric style wide
PE2(config-router)# mpls traffic-eng router-id 3.3.3.3	Configure router id
PE2(config-router)# mpls traffic-eng level-1	Configure traffic engg level-1
PE2(config-router)# mpls traffic-eng level-2	Configure traffic engg level-2
PE2(config-router)# dynamic-hostname	Configure hostname
PE2(config-router)# bfd all-interfaces	Enable bfd all interfaces
PE2(config-router)# net 49.0000.0000.0003.00	Configure network id
PE2(config-router)#exit	Exit from isis instance mode
PE2(config)#commit	Commits the configuration
PE2(config)#router bgp 65000	Configure bgp instance
PE2(config-router)# neighbor 1.1.1.1 remote-as 65000	Enable neighbour address with remote-as 65000
PE2(config-router)# neighbor 30.1.1.1 remote-as 200	Enable neighbour address with remote-as 200
PE2(config-router)# neighbor 1.1.1.1 update-source lo	Enable neighbour address with update loppbacl
PE2(config-router)# address-family ipv4 unicast	Enter address family ipv4 unicast mode
PE2(config-router-af)# neighbor 1.1.1.1 activate	Activate the neighbour
PE2(config-router-af)# neighbor 30.1.1.1 activate	Activate the neighbour
PE2(config-router-af)# exit-address-family	Exit from address family mode
PE2(config-router)# address-family vpnv4 unicast	Enter address family vpnv4 mode
PE2(config-router-af)# neighbor 1.1.1.1 activate	Activate the neighbour
PE2(config-router-af)# exit-address-family	Exit from address family
PE2(config-router)# address-family ipv4 flowspec	Enter address family ipv4 flowspec mode
PE2(config-router-af)# neighbor 1.1.1.1 activate	Activate the neighbour
PE2(config-router-af)# neighbor 30.1.1.1 activate	Activate the neighbour
PE2(config-router-af)# exit-address-family	Exit from address family
PE2(config-router)# address-family vpnv4 flowspec	Enter address family vpnv4 flowpsec mode
PE2(config-router-af)# neighbor 1.1.1.1 activate	Activate the neighbour

PE2(config-router-af)# exit-address-family	Exit from address family
PE2(config-router)# address-family ipv4 vrf vrf100	Enter address family ipv4 vrf mode
PE2(config-router-af)# neighbor 55.1.1.2 remote-as 200	Enter neighbor ip add with remote-as 100
PE2(config-router-af)# neighbor 55.1.1.2 activate	Activate the neighbour
PE2(config-router-af)# exit-address-family	Exit from address family
PE2(config-router)# address-family ipv4 flowspec vrf vrf100	Enter address family ipv4 vrf flowspec mode
PE2(config-router-af)# neighbor 55.1.1.2 activate	Activate the neighbour
PE2(config-router-af)# exit-address-family	Exit from address family
PE2(config-router)#exit	Exit from router mode
PE2(config)#commit	Commits the configuration

CE2

CE2#configure terminal	Enter configure mode.
CE2(config)#class-map type traffic match-all clas1	Configure class map with class name
CE2(config-cmap-tr)# match destination-address ipv4 4.4.4.4/32	Configure match with destination ip address
CE2(config-cmap-tr)# match source-address ipv4 5.5.5.5/32	Enable match with source ip address
CE2(config-cmap-tr)# match destination-port 1300-1400	Enable match with destination-port
CE2(config-cmap-tr)#exit	Exit from class map traffic mode
CE2(config)#commit	Commits the configuration
CE2(config)#class-map type traffic match-all clas2	Configure class map with class name
CE2(config-cmap-tr)# match destination-address ipv4 30.1.1.0/24	Configure match with destination ip address
CE2(config-cmap-tr)# match source-address ipv4 30.1.1.0/24	Enable match with source ip address
CE2(config-cmap-tr)# match source-port 500-600	Enable match with source-port
CE2(config-cmap-tr)# match tcp-flag 21 bit-mask 3f	Enable match with tcp flag bit
CE2(config-cmap-tr)# match dscp 21	Enable match with dscp
CE2(config-cmap-tr)#exit	Exit from class map traffic mode
CE2(config)#commit	Commits the configuration
CE2(config)#policy-map type pbr poll	Configure policy map type pbr with policy name
CE2(config-pmap-pbr)#class type traffic clas1	Enable class type traffic with class map name
CE2(config-pmap-pbr-c)#police rate 100000 bps	Enable policy rate

BGP Flowspec Support for IPv4

CE2 (config-pmap-pbr-c) #exit	Exit from policy map traffic
CE2 (config-pmap-pbr) #exit	Exit from policy map
CE2 (config) #commit	Commits the configuration
CE2 (config) #policy-map type pbr pol2	Configure policy map type pbr with policy name
CE2 (config-pmap-pbr) # class type traffic clas2	Enable class type traffic with class map name
CE2 (config-pmap-pbr-c) # police rate 500000 bps	Enable policy rate
CE2 (config-pmap-pbr-c) # set dscp 1e	Exit from policy map traffic
CE2 (config-pmap-pbr-c) #exit	Exit from policy map
CE2 (config-pmap-pbr) #exit	Commits the configuration
CE2 (config) #commit	Configure policy map type pbr with policy name
CE2 (config) #flowspec	Configure flowspec
CE2 (config-flowspec) # address-family ipv4	Enter address-family mode with ipv4
CE2 (config-flowspec-af) # service-policy type pbr pol1	Enable service policy type pbr with policy name
CE2 (config-flowspec-af) # service-policy type pbr pol2	Enable service policy type pbr with policy name
CE2 (config-flowspec-af) #exit	Exit from address family mode
CE2 (config-flowspec) #exit	Exit from flowspec mode
CE2 (config) #commit	Commits the configuration
CE2 (config) #interface lo	Enter interface mode
CE2 (config-if) # ip address 5.5.5.5/32 secondary	Assign the ip address secondary
CE2 (config-if) # ip router isis 1	Enter router isis instance
CE2 (config-if) #exit	Exit from interface mode
CE2 (config) #commit	Commits the configuration
CE2 (config) #interface ce49	Enter interface mode
CE2 (config-if) # ip address 30.1.1.1/24	Enter interface mode
CE2 (config-if) #exit	Exit from interface mode
CE2 (config) #commit	Commits the configuration
CE2 (config) #router bgp 200	Configure bgp instance
CE2 (config-router) # neighbor 30.1.1.2 remote-as 65000	Enable neighbour address with remote-as 65000
CE2 (config-router) # neighbor 55.1.1.1 remote-as 65000	Enable neighbour address with remote-as 200
CE2 (config-router) # address-family ipv4 unicast	Enter address family ipv4 unicast mode
CE2 (config-router-af) # redistribute connected	Enter redistribute connected
CE2 (config-router-af) # neighbor 30.1.1.2 activate	Activate the neighbour
CE2 (config-router-af) # neighbor 55.1.1.1 activate	Activate the neighbour

CE2(config-router-af)# exit-address-family	Exit from address family mode
CE2(config-router)# address-family ipv4 flowspec	Enter address family ipv4 flowspec mode
CE2(config-router-af)# neighbor 30.1.1.2 activate	Activate the neighbour
CE2(config-router-af)# neighbor 55.1.1.1 activate	Activate the neighbour
CE2(config-router-af)# exit-address-family	Exit from address family
CE2(config-router)#exit	Exit from router bgp mode
CE2(config)#commit	Commits the configuration

Validation

CE1

```
CE1#sh ip bgp
BGP table version is 5, local router ID is 4.4.4.4
Status codes: s suppressed, d damped, h history, a add-path, * valid, > best, i -
internal,
                l - labeled, S Stale
Origin codes: i - IGP, e - EGP, ? - incomplete
```

	Network	Next Hop	Metric	LocPrf	Weight	Path
*>	4.4.4.4/32	0.0.0.0	0	100	32768	?
*>	5.5.5.5/32	66.1.1.2	0	100	0	65000 200 ?
*>	10.1.1.0/24	0.0.0.0	0	100	32768	?
*>	30.1.1.0/24	66.1.1.2	0	100	0	65000 200 ?
*>	55.1.1.0/24	66.1.1.2	0	100	0	65000 ?
*>	66.1.1.0/24	0.0.0.0	0	100	32768	?
*		66.1.1.2	0	100	0	65000 ?
*>	100.1.1.0/24	0.0.0.0	0	100	32768	?
*>	200.1.1.0	66.1.1.2	0	100	0	65000 200 ?

Total number of prefixes 8

CE1#

CE1#show ip bgp neighbors

```
BGP neighbor is 10.1.1.2, remote AS 65000, local AS 100, external link
  BGP version 4, local router ID 4.4.4.4, remote router ID 1.1.1.1
  BGP state = Established, up for 02:20:12
  Last read 00:00:07, hold time is 90, keepalive interval is 30 seconds
  Neighbor capabilities:
    Route refresh: advertised and received (old and new)
    Address family IPv4 Unicast: advertised and received
    Address family IPv4 Flow Specification: advertised and received
  Received 345 messages, 0 notifications, 0 in queue
  Sent 358 messages, 0 notifications, 0 in queue
  Route refresh request: received 0, sent 0
```

BGP Flowspec Support for IPv4

Minimum time between advertisement runs is 30 seconds

For address family: IPv4 Unicast BGP table version 5, neighbor version 5
Index 0, Offset 0, Mask 0x1
Community attribute sent to this neighbor (both)
Large Community attribute sent to this neighbor
0 accepted prefixes
8 announced prefixes

For address family: IPv4 Flow Specification BGP table version 8, neighbor version 8
Index 0, Offset 0, Mask 0x1
Community attribute sent to this neighbor (both)
Large Community attribute sent to this neighbor
4 accepted prefixes
4 announced prefixes

Connections established 1; dropped 0
Local host: 10.1.1.1, Local port: 179
Foreign host: 10.1.1.2, Foreign port: 59044
Nexthop: 10.1.1.1
Nexthop global: ::
Nexthop local: ::
BGP connection: non shared network

BGP neighbor is 66.1.1.2, remote AS 65000, local AS 100, external link
BGP version 4, local router ID 4.4.4.4, remote router ID 66.1.1.2
BGP state = Established, up for 02:20:12
Last read 00:00:04, hold time is 90, keepalive interval is 30 seconds
Neighbor capabilities:
Route refresh: advertised and received (old and new)
Address family IPv4 Unicast: advertised and received
Address family IPv4 Flow Specification: advertised and received
Received 348 messages, 0 notifications, 0 in queue
Sent 343 messages, 0 notifications, 0 in queue
Route refresh request: received 0, sent 0
Minimum time between advertisement runs is 30 seconds

For address family: IPv4 Unicast BGP table version 5, neighbor version 5
Index 1, Offset 0, Mask 0x2
Community attribute sent to this neighbor (both)
Large Community attribute sent to this neighbor
5 accepted prefixes
4 announced prefixes

For address family: IPv4 Flow Specification BGP table version 8, neighbor version 8
Index 1, Offset 0, Mask 0x2
Community attribute sent to this neighbor (both)
Large Community attribute sent to this neighbor

2 accepted prefixes
2 announced prefixes

Connections established 1; dropped 0
Local host: 66.1.1.1, Local port: 179
Foreign host: 66.1.1.2, Foreign port: 54954
Nexthop: 66.1.1.1
Nexthop global: ::
Nexthop local: ::
BGP connection: non shared network

CE1#

CE1#show ip bgp flowspec summary
BGP router identifier 4.4.4.4, local AS number 100
BGP table version is 8
3 BGP AS-PATH entries
0 BGP community entries

Neighbor PfxRcd	V	AS	MsgRcv	MsgSen	TblVer	InQ	OutQ	Up/Down	State/
10.1.1.2 4	4	65000	346	360	8	0	0	02:20:46	
66.1.1.2 2	4	65000	349	344	8	0	0	02:20:46	

Total number of neighbors 2

Total number of Established sessions 2
CE1#

CE1#show ip bgp ipv4 flowspec
BGP table version is 8, local router ID is 4.4.4.4
Status codes: s suppressed, d damped, h history, a add-path, * valid, > best, i - internal,
l - labeled, S Stale
Origin codes: i - IGP, e - EGP, ? - incomplete

	Network	Next Hop	Metric	LocPrf	Weight	Path
*>	flowspec/136	0.0.0.0	0	100	32768	i
*>	flowspec/200	66.1.1.2	0	100	0	65000 200 i
*		10.1.1.2	0	100	0	65000 200 i
*	flowspec/152	10.1.1.2	0	100	0	65000 i
*>	flowspec/152	0.0.0.0	0	100	32768	i
*	flowspec/48	10.1.1.2	0	100	0	65000 i
*>	flowspec/152	66.1.1.2	0	100	0	65000 200 i
*		10.1.1.2	0	100	0	65000 200 i

Total number of prefixes 6
CE1#

BGP Flowspec Support for IPv4

```
CE1#show ip bgp ipv4 flowspec detail
BGP table version is 8, local router ID is 4.4.4.4
Status codes: s suppressed, d damped, h history, a add-path, * valid, > best, i -
internal,
                l - labeled, S Stale
Origin codes: i - IGP, e - EGP, ? - incomplete
```

	Network	Next Hop	Metric	LocPrf	Weight	Path
*>	flowspec/136	0.0.0.0	0	100	32768	i

```
FlowSpec:
destination ip address: 10.1.1.0/24
source ip address: 10.1.1.0/24
TCP/UDP source port:
  e:0 a:0 len:1 lt:0 gt:1 eq:1 data:22
  e:1 a:1 len:1 lt:1 gt:0 eq:1 data:122
```

```
FlowSpec Actions:
traffic_rate: 21000 bps
```

*>	flowspec/200	66.1.1.2	0	100	0	65000 200 i
----	--------------	----------	---	-----	---	-------------

```
FlowSpec:
destination ip address: 30.1.1.0/24
source ip address: 30.1.1.0/24
TCP/UDP source port:
  e:0 a:0 len:1 lt:0 gt:1 eq:1 data:500
  e:1 a:1 len:1 lt:1 gt:0 eq:1 data:600
TCP flags:
  e:0 a:0 len:0 not:0 m:1 data:0x21
  e:1 a:1 len:0 not:1 m:0 data:0x1e
DSCP:
  e:1 a:0 len:0 lt:0 gt:0 eq:1 data:0x21
```

```
FlowSpec Actions:
traffic_rate: 500000 bps
traffic marking DSCP: 1e
```

*		10.1.1.2	0	100	0	65000 200 i
---	--	----------	---	-----	---	-------------

```
FlowSpec Actions:
traffic_rate: 500000 bps
traffic marking DSCP: 1e
```

*	flowspec/152	10.1.1.2	0	100	0	65000 i
---	--------------	----------	---	-----	---	---------

```
FlowSpec:
destination ip address: 1.1.1.1/32
source ip address: 3.3.3.3/32
TCP/UDP destination port:
  e:0 a:0 len:1 lt:0 gt:1 eq:1 data:300
  e:1 a:1 len:1 lt:1 gt:0 eq:1 data:399
```

```

FlowSpec Actions:
  traffic_rate: 1111111 bps
*>  flowspec/152      0.0.0.0              0          100          32768  i

FlowSpec:
  destination ip address: 3.3.3.3/32
  source ip address: 3.3.3.3/32
  TCP/UDP destination port:
    e:0 a:0 len:1 lt:0 gt:1 eq:1 data:44
    e:1 a:1 len:1 lt:1 gt:0 eq:1 data:144

FlowSpec Actions:
  traffic_rate: 4444444 bps
*   flowspec/48      10.1.1.2             0          100          0 65000 i

FlowSpec:
  destination ip address: 4.4.4.4/32

FlowSpec Actions:
  rt_redirect: as_type: as 100:10 vrf_id:0 fib_id:0
*>  flowspec/152      66.1.1.2             0          100          0 65000 200 i

FlowSpec:
  destination ip address: 5.5.5.5/32
  source ip address: 5.5.5.5/32
  TCP/UDP destination port:
    e:0 a:0 len:1 lt:0 gt:1 eq:1 data:1300
    e:1 a:1 len:1 lt:1 gt:0 eq:1 data:1400

FlowSpec Actions:
  traffic_rate: 100000 bps
*           10.1.1.2             0          100          0 65000 200 i

FlowSpec Actions:
  traffic_rate: 100000 bps

Total number of prefixes 6
CE1#

CE1#show ip bgp ipv4 flowspec vrf all
BGP table version is 8, local router ID is 4.4.4.4
Status codes: s suppressed, d damped, h history, a add-path, * valid, > best, i -
internal,
              l - labeled, S Stale
Origin codes: i - IGP, e - EGP, ? - incomplete

```

BGP Flowspec Support for IPv4

	Network	Next Hop	Metric	LocPrf	Weight	Path
*>	flowspec/136	0.0.0.0	0	100	32768	i
*>	flowspec/200	66.1.1.2	0	100	0	65000 200 i
*		10.1.1.2	0	100	0	65000 200 i
*	flowspec/152	10.1.1.2	0	100	0	65000 i
*>	flowspec/152	0.0.0.0	0	100	32768	i
*	flowspec/48	10.1.1.2	0	100	0	65000 i
*>	flowspec/152	66.1.1.2	0	100	0	65000 200 i
*		10.1.1.2	0	100	0	65000 200 i

Total number of prefixes 6

CE1#

CE1#show ip bgp ipv4 flowspec vrf all detail

BGP table version is 8, local router ID is 4.4.4.4

Status codes: s suppressed, d damped, h history, a add-path, * valid, > best, i - internal,

l - labeled, S Stale

Origin codes: i - IGP, e - EGP, ? - incomplete

	Network	Next Hop	Metric	LocPrf	Weight	Path
*>	flowspec/136	0.0.0.0	0	100	32768	i

FlowSpec:

destination ip address: 10.1.1.0/24

source ip address: 10.1.1.0/24

TCP/UDP source port:

e:0 a:0 len:1 lt:0 gt:1 eq:1 data:22

e:1 a:1 len:1 lt:1 gt:0 eq:1 data:122

FlowSpec Actions:

traffic_rate: 21000 bps

*>	flowspec/200	66.1.1.2	0	100	0	65000 200 i
----	--------------	----------	---	-----	---	-------------

FlowSpec:

destination ip address: 30.1.1.0/24

source ip address: 30.1.1.0/24

TCP/UDP source port:

e:0 a:0 len:1 lt:0 gt:1 eq:1 data:500

e:1 a:1 len:1 lt:1 gt:0 eq:1 data:600

TCP flags:

e:0 a:0 len:0 not:0 m:1 data:0x21

e:1 a:1 len:0 not:1 m:0 data:0x1e

DSCP:

e:1 a:0 len:0 lt:0 gt:0 eq:1 data:0x21

FlowSpec Actions:

traffic_rate: 500000 bps

traffic marking DSCP: 1e

```
*          10.1.1.2          0          100          0  65000 200 i
```

FlowSpec Actions:

```
  traffic_rate: 500000 bps
  traffic marking DSCP: 1e
```

```
*  flowspec/152    10.1.1.2          0          100          0  65000 i
```

FlowSpec:

```
  destination ip address: 1.1.1.1/32
  source ip address: 3.3.3.3/32
  TCP/UDP destination port:
    e:0 a:0 len:1 lt:0 gt:1 eq:1 data:300
    e:1 a:1 len:1 lt:1 gt:0 eq:1 data:399
```

FlowSpec Actions:

```
  traffic_rate: 1111111 bps
```

```
*>  flowspec/152    0.0.0.0          0          100          32768 i
```

FlowSpec:

```
  destination ip address: 3.3.3.3/32
  source ip address: 3.3.3.3/32
  TCP/UDP destination port:
    e:0 a:0 len:1 lt:0 gt:1 eq:1 data:44
    e:1 a:1 len:1 lt:1 gt:0 eq:1 data:144
```

FlowSpec Actions:

```
  traffic_rate: 4444444 bps
```

```
*  flowspec/48     10.1.1.2          0          100          0  65000 i
```

FlowSpec:

```
  destination ip address: 4.4.4.4/32
```

FlowSpec Actions:

```
  rt_redirect: as_type: as 100:10 vrf_id:0 fib_id:0
```

```
*>  flowspec/152    66.1.1.2          0          100          0  65000 200 i
```

FlowSpec:

```
  destination ip address: 5.5.5.5/32
  source ip address: 5.5.5.5/32
  TCP/UDP destination port:
    e:0 a:0 len:1 lt:0 gt:1 eq:1 data:1300
    e:1 a:1 len:1 lt:1 gt:0 eq:1 data:1400
```

FlowSpec Actions:

```
  traffic_rate: 100000 bps
```

```
*          10.1.1.2          0          100          0  65000 200 i
```

BGP Flowspec Support for IPv4

FlowSpec Actions:

traffic_rate: 100000 bps

Total number of prefixes 6

CE1#

PE1

PE1#show clns neighbors

Total number of L1 adjacencies: 2

Total number of L2 adjacencies: 2

Total number of adjacencies: 4

Tag 1: VRF : default

System Id	Interface	SNPA	State	Holdtime	Type	Protocol
P1	xe7	3417.ebe4.af08	Up	27	L1	IS-IS
			Up	27	L2	IS-IS
P2	ce51	3c2c.99c7.07ad	Up	19	L1	IS-IS
			Up	19	L2	IS-IS

PE1#

PE1#show isis database verbose

Tag 1: VRF : default

IS-IS Level-1 Link State Database:

LSPID	LSP Seq Num	LSP Checksum	LSP Holdtime	ATT/P/OL
PE1.00-00	* 0x00000013	0x9F2C	1079	0/0/0

Area Address: 49

NLPID: 0xCC

Hostname: PE1

IP Address: 20.1.1.1

Router ID: 1.1.1.1

Metric: 10 IS-Extended PE1.02

IPv4 Interface Address: 20.1.1.1

Neighbor IP Address: 20.1.1.1

Maximum Link Bandwidth : 10000000.00 kbits/sec

Reservable Bandwidth : 10000000.00 kbits/sec

Unreserved Bandwidth:

Unreserved Bandwidth at priority 0: 10000000.00 kbits/sec

Unreserved Bandwidth at priority 1: 10000000.00 kbits/sec

Unreserved Bandwidth at priority 2: 10000000.00 kbits/sec

Unreserved Bandwidth at priority 3: 10000000.00 kbits/sec

Unreserved Bandwidth at priority 4: 10000000.00 kbits/sec

Unreserved Bandwidth at priority 5: 10000000.00 kbits/sec

Unreserved Bandwidth at priority 6: 10000000.00 kbits/sec

Unreserved Bandwidth at priority 7: 10000000.00 kbits/sec

TE-Default Metric: 10

Metric: 10 IS-Extended PE1.03

IPv4 Interface Address: 40.1.1.1

Neighbor IP Address: 40.1.1.1

Maximum Link Bandwidth : 100000000.00 kbits/sec

```

Reservable Bandwidth : 100000000.00 kbits/sec
Unreserved Bandwidth:
  Unreserved Bandwidth at priority 0: 100000000.00 kbits/sec
  Unreserved Bandwidth at priority 1: 100000000.00 kbits/sec
  Unreserved Bandwidth at priority 2: 100000000.00 kbits/sec
  Unreserved Bandwidth at priority 3: 100000000.00 kbits/sec
  Unreserved Bandwidth at priority 4: 100000000.00 kbits/sec
  Unreserved Bandwidth at priority 5: 100000000.00 kbits/sec
  Unreserved Bandwidth at priority 6: 100000000.00 kbits/sec
  Unreserved Bandwidth at priority 7: 100000000.00 kbits/sec
TE-Default Metric: 10
Metric: 10      IP-Extended 20.1.1.0/24
Metric: 0      IP-Extended 1.1.1.1/32
Metric: 10      IP-Extended 40.1.1.0/24
PE1.02-00      * 0x0000000E  0x704C          640          0/0/0
Metric: 0      IS-Extended PE1.00
Metric: 0      IS-Extended P1.00
PE1.03-00      * 0x00000003  0xCFF2          743          0/0/0
Metric: 0      IS-Extended PE1.00
Metric: 0      IS-Extended P2.00
P1.00-00      0x00000013  0x6CF5          1159         0/0/0
Area Address: 49
NLPID: 0xCC
Hostname: P1
IP Address: 2.2.2.2
Router ID: 2.2.2.2
Metric: 10      IS-Extended PE2.02
IPv4 Interface Address: 11.1.1.2
Neighbor IP Address: 11.1.1.1
Maximum Link Bandwidth : 100000000.00 kbits/sec
Reservable Bandwidth : 100000000.00 kbits/sec
Unreserved Bandwidth:
  Unreserved Bandwidth at priority 0: 100000000.00 kbits/sec
  Unreserved Bandwidth at priority 1: 100000000.00 kbits/sec
  Unreserved Bandwidth at priority 2: 100000000.00 kbits/sec
  Unreserved Bandwidth at priority 3: 100000000.00 kbits/sec
  Unreserved Bandwidth at priority 4: 100000000.00 kbits/sec
  Unreserved Bandwidth at priority 5: 100000000.00 kbits/sec
  Unreserved Bandwidth at priority 6: 100000000.00 kbits/sec
  Unreserved Bandwidth at priority 7: 100000000.00 kbits/sec
TE-Default Metric: 10
Metric: 10      IS-Extended PE1.02
IPv4 Interface Address: 20.1.1.2
Neighbor IP Address: 20.1.1.1
Maximum Link Bandwidth : 10000000.00 kbits/sec
Reservable Bandwidth : 10000000.00 kbits/sec
Unreserved Bandwidth:
  Unreserved Bandwidth at priority 0: 10000000.00 kbits/sec
  Unreserved Bandwidth at priority 1: 10000000.00 kbits/sec
  Unreserved Bandwidth at priority 2: 10000000.00 kbits/sec

```

```
Unreserved Bandwidth at priority 3: 10000000.00 kbits/sec
Unreserved Bandwidth at priority 4: 10000000.00 kbits/sec
Unreserved Bandwidth at priority 5: 10000000.00 kbits/sec
Unreserved Bandwidth at priority 6: 10000000.00 kbits/sec
Unreserved Bandwidth at priority 7: 10000000.00 kbits/sec
TE-Default Metric: 10
Metric: 10          IP-Extended 20.1.1.0/24
Metric: 10          IP-Extended 2.2.2.2/32
Metric: 10          IP-Extended 11.1.1.0/24
PE2.00-00          0x00000013   0x2F15           1167           0/0/0
Area Address: 49
NLPID:            0xCC
Hostname:         PE2
IP Address:       11.1.1.1
Router ID:        3.3.3.3
Metric: 10        IS-Extended PE2.02
IPv4 Interface Address: 11.1.1.1
Neighbor IP Address: 11.1.1.1
Maximum Link Bandwidth : 100000000.00 kbits/sec
Reservable Bandwidth : 100000000.00 kbits/sec
Unreserved Bandwidth:
Unreserved Bandwidth at priority 0: 100000000.00 kbits/sec
Unreserved Bandwidth at priority 1: 100000000.00 kbits/sec
Unreserved Bandwidth at priority 2: 100000000.00 kbits/sec
Unreserved Bandwidth at priority 3: 100000000.00 kbits/sec
Unreserved Bandwidth at priority 4: 100000000.00 kbits/sec
Unreserved Bandwidth at priority 5: 100000000.00 kbits/sec
Unreserved Bandwidth at priority 6: 100000000.00 kbits/sec
Unreserved Bandwidth at priority 7: 100000000.00 kbits/sec
TE-Default Metric: 10
Metric: 10          IS-Extended PE2.01
IPv4 Interface Address: 50.1.1.1
Neighbor IP Address: 50.1.1.1
Maximum Link Bandwidth : 100000000.00 kbits/sec
Reservable Bandwidth : 100000000.00 kbits/sec
Unreserved Bandwidth:
Unreserved Bandwidth at priority 0: 100000000.00 kbits/sec
Unreserved Bandwidth at priority 1: 100000000.00 kbits/sec
Unreserved Bandwidth at priority 2: 100000000.00 kbits/sec
Unreserved Bandwidth at priority 3: 100000000.00 kbits/sec
Unreserved Bandwidth at priority 4: 100000000.00 kbits/sec
Unreserved Bandwidth at priority 5: 100000000.00 kbits/sec
Unreserved Bandwidth at priority 6: 100000000.00 kbits/sec
Unreserved Bandwidth at priority 7: 100000000.00 kbits/sec
TE-Default Metric: 10
Metric: 10          IP-Extended 50.1.1.0/24
Metric: 0           IP-Extended 3.3.3.3/32
Metric: 10          IP-Extended 11.1.1.0/24
PE2.01-00          0x0000000D   0xCBFA           542           0/0/0
Metric: 0           IS-Extended PE2.00
```

```

Metric: 0          IS-Extended P2.00
PE2.02-00          0x0000000E  0x7246          503          0/0/0
Metric: 0          IS-Extended PE2.00
Metric: 0          IS-Extended P1.00
P2.00-00          0x00000011  0x788C          1147         0/0/0

```

Area Address: 49

NLPID: 0xCC

Hostname: P2

IP Address: 6.6.6.6

Router ID: 6.6.6.6

Metric: 10 IS-Extended PE2.01

IPv4 Interface Address: 50.1.1.2

Neighbor IP Address: 50.1.1.1

Maximum Link Bandwidth : 100000000.00 kbits/sec

Reservable Bandwidth : 100000000.00 kbits/sec

Unreserved Bandwidth:

Unreserved Bandwidth at priority 0: 100000000.00 kbits/sec

Unreserved Bandwidth at priority 1: 100000000.00 kbits/sec

Unreserved Bandwidth at priority 2: 100000000.00 kbits/sec

Unreserved Bandwidth at priority 3: 100000000.00 kbits/sec

Unreserved Bandwidth at priority 4: 100000000.00 kbits/sec

Unreserved Bandwidth at priority 5: 100000000.00 kbits/sec

Unreserved Bandwidth at priority 6: 100000000.00 kbits/sec

Unreserved Bandwidth at priority 7: 100000000.00 kbits/sec

TE-Default Metric: 10

Metric: 10 IS-Extended PE1.03

IPv4 Interface Address: 40.1.1.2

Neighbor IP Address: 40.1.1.1

Maximum Link Bandwidth : 100000000.00 kbits/sec

Reservable Bandwidth : 100000000.00 kbits/sec

Unreserved Bandwidth:

Unreserved Bandwidth at priority 0: 100000000.00 kbits/sec

Unreserved Bandwidth at priority 1: 100000000.00 kbits/sec

Unreserved Bandwidth at priority 2: 100000000.00 kbits/sec

Unreserved Bandwidth at priority 3: 100000000.00 kbits/sec

Unreserved Bandwidth at priority 4: 100000000.00 kbits/sec

Unreserved Bandwidth at priority 5: 100000000.00 kbits/sec

Unreserved Bandwidth at priority 6: 100000000.00 kbits/sec

Unreserved Bandwidth at priority 7: 100000000.00 kbits/sec

TE-Default Metric: 10

Metric: 10 IP-Extended 6.6.6.6/32

Metric: 10 IP-Extended 40.1.1.0/24

Metric: 10 IP-Extended 50.1.1.0/24

IS-IS Level-2 Link State Database:

LSPID	LSP Seq Num	LSP Checksum	LSP Holdtime	ATT/P/OL
PE1.00-00	* 0x00000017	0x40F9	1079	0/0/0

Area Address: 49

NLPID: 0xCC

Hostname: PE1

BGP Flowspec Support for IPv4

```
IP Address: 20.1.1.1
Router ID: 1.1.1.1
Metric: 10 IS-Extended PE1.02
  IPv4 Interface Address: 20.1.1.1
  Neighbor IP Address: 20.1.1.1
  Maximum Link Bandwidth : 10000000.00 kbits/sec
  Reservable Bandwidth : 10000000.00 kbits/sec
  Unreserved Bandwidth:
    Unreserved Bandwidth at priority 0: 10000000.00 kbits/sec
    Unreserved Bandwidth at priority 1: 10000000.00 kbits/sec
    Unreserved Bandwidth at priority 2: 10000000.00 kbits/sec
    Unreserved Bandwidth at priority 3: 10000000.00 kbits/sec
    Unreserved Bandwidth at priority 4: 10000000.00 kbits/sec
    Unreserved Bandwidth at priority 5: 10000000.00 kbits/sec
    Unreserved Bandwidth at priority 6: 10000000.00 kbits/sec
    Unreserved Bandwidth at priority 7: 10000000.00 kbits/sec
  TE-Default Metric: 10
Metric: 10 IS-Extended PE1.03
  IPv4 Interface Address: 40.1.1.1
  Neighbor IP Address: 40.1.1.1
  Maximum Link Bandwidth : 100000000.00 kbits/sec
  Reservable Bandwidth : 100000000.00 kbits/sec
  Unreserved Bandwidth:
    Unreserved Bandwidth at priority 0: 100000000.00 kbits/sec
    Unreserved Bandwidth at priority 1: 100000000.00 kbits/sec
    Unreserved Bandwidth at priority 2: 100000000.00 kbits/sec
    Unreserved Bandwidth at priority 3: 100000000.00 kbits/sec
    Unreserved Bandwidth at priority 4: 100000000.00 kbits/sec
    Unreserved Bandwidth at priority 5: 100000000.00 kbits/sec
    Unreserved Bandwidth at priority 6: 100000000.00 kbits/sec
    Unreserved Bandwidth at priority 7: 100000000.00 kbits/sec
  TE-Default Metric: 10
Metric: 10 IP-Extended 20.1.1.0/24
Metric: 0 IP-Extended 1.1.1.1/32
Metric: 20 IP-Extended 2.2.2.2/32
Metric: 20 IP-Extended 11.1.1.0/24
Metric: 20 IP-Extended 3.3.3.3/32
Metric: 20 IP-Extended 50.1.1.0/24
Metric: 20 IP-Extended 6.6.6.6/32
Metric: 10 IP-Extended 40.1.1.0/24
PE1.02-00 * 0x0000000E 0x704C 640 0/0/0
  Metric: 0 IS-Extended PE1.00
  Metric: 0 IS-Extended P1.00
PE1.03-00 * 0x00000003 0xCFF2 743 0/0/0
  Metric: 0 IS-Extended PE1.00
  Metric: 0 IS-Extended P2.00
P1.00-00 0x00000019 0xCCF2 1159 0/0/0
  Area Address: 49
  NLPID: 0xCC
  Hostname: P1
```

```

IP Address: 2.2.2.2
Router ID: 2.2.2.2
Metric: 10 IS-Extended PE2.02
  IPv4 Interface Address: 11.1.1.2
  Neighbor IP Address: 11.1.1.1
  Maximum Link Bandwidth : 100000000.00 kbits/sec
  Reservable Bandwidth : 100000000.00 kbits/sec
  Unreserved Bandwidth:
    Unreserved Bandwidth at priority 0: 100000000.00 kbits/sec
    Unreserved Bandwidth at priority 1: 100000000.00 kbits/sec
    Unreserved Bandwidth at priority 2: 100000000.00 kbits/sec
    Unreserved Bandwidth at priority 3: 100000000.00 kbits/sec
    Unreserved Bandwidth at priority 4: 100000000.00 kbits/sec
    Unreserved Bandwidth at priority 5: 100000000.00 kbits/sec
    Unreserved Bandwidth at priority 6: 100000000.00 kbits/sec
    Unreserved Bandwidth at priority 7: 100000000.00 kbits/sec
  TE-Default Metric: 10
Metric: 10 IS-Extended PE1.02
  IPv4 Interface Address: 20.1.1.2
  Neighbor IP Address: 20.1.1.1
  Maximum Link Bandwidth : 10000000.00 kbits/sec
  Reservable Bandwidth : 10000000.00 kbits/sec
  Unreserved Bandwidth:
    Unreserved Bandwidth at priority 0: 10000000.00 kbits/sec
    Unreserved Bandwidth at priority 1: 10000000.00 kbits/sec
    Unreserved Bandwidth at priority 2: 10000000.00 kbits/sec
    Unreserved Bandwidth at priority 3: 10000000.00 kbits/sec
    Unreserved Bandwidth at priority 4: 10000000.00 kbits/sec
    Unreserved Bandwidth at priority 5: 10000000.00 kbits/sec
    Unreserved Bandwidth at priority 6: 10000000.00 kbits/sec
    Unreserved Bandwidth at priority 7: 10000000.00 kbits/sec
  TE-Default Metric: 10
Metric: 10 IP-Extended 20.1.1.0/24
Metric: 10 IP-Extended 2.2.2.2/32
Metric: 10 IP-Extended 11.1.1.0/24
Metric: 10 IP-Extended 3.3.3.3/32
Metric: 20 IP-Extended 50.1.1.0/24
Metric: 10 IP-Extended 1.1.1.1/32
Metric: 30 IP-Extended 6.6.6.6/32
Metric: 20 IP-Extended 40.1.1.0/24
PE2.00-00 0x00000016 0x1BA1 1167 0/0/0
Area Address: 49
NLPID: 0xCC
Hostname: PE2
IP Address: 11.1.1.1
Router ID: 3.3.3.3
Metric: 10 IS-Extended PE2.02
  IPv4 Interface Address: 11.1.1.1
  Neighbor IP Address: 11.1.1.1
  Maximum Link Bandwidth : 100000000.00 kbits/sec

```

```
Reservable Bandwidth : 100000000.00 kbits/sec
Unreserved Bandwidth:
  Unreserved Bandwidth at priority 0: 100000000.00 kbits/sec
  Unreserved Bandwidth at priority 1: 100000000.00 kbits/sec
  Unreserved Bandwidth at priority 2: 100000000.00 kbits/sec
  Unreserved Bandwidth at priority 3: 100000000.00 kbits/sec
  Unreserved Bandwidth at priority 4: 100000000.00 kbits/sec
  Unreserved Bandwidth at priority 5: 100000000.00 kbits/sec
  Unreserved Bandwidth at priority 6: 100000000.00 kbits/sec
  Unreserved Bandwidth at priority 7: 100000000.00 kbits/sec
TE-Default Metric: 10
Metric: 10          IS-Extended PE2.01
IPv4 Interface Address: 50.1.1.1
Neighbor IP Address: 50.1.1.1
Maximum Link Bandwidth : 100000000.00 kbits/sec
Reservable Bandwidth : 100000000.00 kbits/sec
Unreserved Bandwidth:
  Unreserved Bandwidth at priority 0: 100000000.00 kbits/sec
  Unreserved Bandwidth at priority 1: 100000000.00 kbits/sec
  Unreserved Bandwidth at priority 2: 100000000.00 kbits/sec
  Unreserved Bandwidth at priority 3: 100000000.00 kbits/sec
  Unreserved Bandwidth at priority 4: 100000000.00 kbits/sec
  Unreserved Bandwidth at priority 5: 100000000.00 kbits/sec
  Unreserved Bandwidth at priority 6: 100000000.00 kbits/sec
  Unreserved Bandwidth at priority 7: 100000000.00 kbits/sec
TE-Default Metric: 10
Metric: 10          IP-Extended 50.1.1.0/24
Metric: 0           IP-Extended 3.3.3.3/32
Metric: 10          IP-Extended 11.1.1.0/24
Metric: 20          IP-Extended 2.2.2.2/32
Metric: 20          IP-Extended 20.1.1.0/24
Metric: 20          IP-Extended 1.1.1.1/32
Metric: 20          IP-Extended 6.6.6.6/32
Metric: 20          IP-Extended 40.1.1.0/24
PE2.01-00           0x0000000D  0xCBEB          542          0/0/0
  Metric: 0         IS-Extended PE2.00
  Metric: 0         IS-Extended P2.00
PE2.02-00           0x0000000E  0x7246          503          0/0/0
  Metric: 0         IS-Extended PE2.00
  Metric: 0         IS-Extended P1.00
P2.00-00            0x00000014  0x3E72          1147         0/0/0
Area Address: 49
NLPID: 0xCC
Hostname: P2
IP Address: 6.6.6.6
Router ID: 6.6.6.6
Metric: 10          IS-Extended PE2.01
IPv4 Interface Address: 50.1.1.2
Neighbor IP Address: 50.1.1.1
Maximum Link Bandwidth : 100000000.00 kbits/sec
```

```
Reservable Bandwidth : 100000000.00 kbits/sec
Unreserved Bandwidth:
  Unreserved Bandwidth at priority 0: 100000000.00 kbits/sec
  Unreserved Bandwidth at priority 1: 100000000.00 kbits/sec
  Unreserved Bandwidth at priority 2: 100000000.00 kbits/sec
  Unreserved Bandwidth at priority 3: 100000000.00 kbits/sec
  Unreserved Bandwidth at priority 4: 100000000.00 kbits/sec
  Unreserved Bandwidth at priority 5: 100000000.00 kbits/sec
  Unreserved Bandwidth at priority 6: 100000000.00 kbits/sec
  Unreserved Bandwidth at priority 7: 100000000.00 kbits/sec
TE-Default Metric: 10
Metric: 10          IS-Extended PE1.03
IPv4 Interface Address: 40.1.1.2
Neighbor IP Address: 40.1.1.1
Maximum Link Bandwidth : 100000000.00 kbits/sec
Reservable Bandwidth : 100000000.00 kbits/sec
Unreserved Bandwidth:
  Unreserved Bandwidth at priority 0: 100000000.00 kbits/sec
  Unreserved Bandwidth at priority 1: 100000000.00 kbits/sec
  Unreserved Bandwidth at priority 2: 100000000.00 kbits/sec
  Unreserved Bandwidth at priority 3: 100000000.00 kbits/sec
  Unreserved Bandwidth at priority 4: 100000000.00 kbits/sec
  Unreserved Bandwidth at priority 5: 100000000.00 kbits/sec
  Unreserved Bandwidth at priority 6: 100000000.00 kbits/sec
  Unreserved Bandwidth at priority 7: 100000000.00 kbits/sec
TE-Default Metric: 10
Metric: 10          IP-Extended 6.6.6.6/32
Metric: 10          IP-Extended 40.1.1.0/24
Metric: 10          IP-Extended 50.1.1.0/24
Metric: 10          IP-Extended 1.1.1.1/32
Metric: 30          IP-Extended 2.2.2.2/32
Metric: 10          IP-Extended 3.3.3.3/32
Metric: 20          IP-Extended 11.1.1.0/24
Metric: 20          IP-Extended 20.1.1.0/24

PE1#

PE1#show ip bgp neighbors
BGP neighbor is 3.3.3.3, remote AS 65000, local AS 65000, internal link
  BGP version 4, local router ID 1.1.1.1, remote router ID 3.3.3.3
  BGP state = Established, up for 02:26:21
  Last read 00:00:15, hold time is 90, keepalive interval is 30 seconds
  Neighbor capabilities:
    Route refresh: advertised and received (old and new)
    Address family IPv4 Unicast: advertised and received
    Address family VPNv4 Unicast: advertised and received
    Address family IPv4 Flow Specification: advertised and received
    Address family VPNv4 Flow Specification: advertised and received
  Received 376 messages, 0 notifications, 0 in queue
  Sent 367 messages, 0 notifications, 0 in queue
```

BGP Flowspec Support for IPv4

Route refresh request: received 0, sent 0
Minimum time between advertisement runs is 5 seconds
Update source is lo

For address family: IPv4 Unicast BGP table version 6, neighbor version 6
Index 1, Offset 0, Mask 0x2
AIGP is enabled
Community attribute sent to this neighbor (both)
Large Community attribute sent to this neighbor
4 accepted prefixes
4 announced prefixes

For address family: VPNv4 Unicast BGP table version 4, neighbor version 4
Index 1, Offset 0, Mask 0x2
AIGP is enabled
Community attribute sent to this neighbor (both)
Large Community attribute sent to this neighbor
4 accepted prefixes
4 announced prefixes

For address family: IPv4 Flow Specification BGP table version 17, neighbor version 17
Index 1, Offset 0, Mask 0x2
Community attribute sent to this neighbor (both)
Large Community attribute sent to this neighbor
3 accepted prefixes
2 announced prefixes

For address family: VPNv4 Flow Specification BGP table version 5, neighbor version 5
Index 1, Offset 0, Mask 0x2
Community attribute sent to this neighbor (both)
Large Community attribute sent to this neighbor
2 accepted prefixes
1 announced prefixes

Connections established 1; dropped 0
Local host: 1.1.1.1, Local port: 44219
Foreign host: 3.3.3.3, Foreign port: 179
Next hop: 1.1.1.1
Next hop global: ::
Next hop local: ::
BGP connection: non shared network

BGP neighbor is 10.1.1.1, remote AS 100, local AS 65000, external link
BGP version 4, local router ID 1.1.1.1, remote router ID 4.4.4.4
BGP state = Established, up for 02:26:21
Last read 00:00:05, hold time is 90, keepalive interval is 30 seconds
Neighbor capabilities:

Route refresh: advertised and received (old and new)
Address family IPv4 Unicast: advertised and received
Address family IPv4 Flow Specification: advertised and received
Received 372 messages, 0 notifications, 0 in queue
Sent 359 messages, 0 notifications, 0 in queue
Route refresh request: received 0, sent 0
Minimum time between advertisement runs is 30 seconds

For address family: IPv4 Unicast BGP table version 6, neighbor version 6
Index 2, Offset 0, Mask 0x4
Community attribute sent to this neighbor (both)
Large Community attribute sent to this neighbor
4 accepted prefixes
0 announced prefixes

For address family: IPv4 Flow Specification BGP table version 17, neighbor version 17
Index 2, Offset 0, Mask 0x4
Community attribute sent to this neighbor (both)
Large Community attribute sent to this neighbor
2 accepted prefixes
4 announced prefixes

Connections established 1; dropped 0
Local host: 10.1.1.2, Local port: 59044
Foreign host: 10.1.1.1, Foreign port: 179
Next hop: 10.1.1.2
Next hop global: ::
Next hop local: ::
BGP connection: non shared network

BGP neighbor is 66.1.1.1, vrf vrf100, remote AS 100, local AS 65000, external link
BGP version 4, local router ID 66.1.1.2, remote router ID 4.4.4.4
BGP state = Established, up for 02:26:21
Last read 00:00:17, hold time is 90, keepalive interval is 30 seconds
Neighbor capabilities:
Route refresh: advertised and received (old and new)
Address family IPv4 Unicast: advertised and received
Address family IPv4 Flow Specification: advertised and received
Received 356 messages, 0 notifications, 0 in queue
Sent 362 messages, 0 notifications, 0 in queue
Route refresh request: received 0, sent 0
Minimum time between advertisement runs is 30 seconds

For address family: IPv4 Unicast BGP table version 3, neighbor version 3
Index 0, Offset 0, Mask 0x1
Community attribute sent to this neighbor (standard)
Large Community attribute sent to this neighbor
4 accepted prefixes
5 announced prefixes

BGP Flowspec Support for IPv4

For address family: IPv4 Flow Specification BGP table version 1, neighbor version 1
Index 0, Offset 0, Mask 0x1
Community attribute sent to this neighbor (both)
Large Community attribute sent to this neighbor
2 accepted prefixes
2 announced prefixes

Connections established 1; dropped 0
Local host: 66.1.1.2, Local port: 54954
Foreign host: 66.1.1.1, Foreign port: 179
Nexthop: 66.1.1.2
Nexthop global: ::
Nexthop local: ::
BGP connection: non shared network

PE1#

PE1#show ip bgp flowspec summary
BGP router identifier 1.1.1.1, local AS number 65000
BGP table version is 17
3 BGP AS-PATH entries
0 BGP community entries

Neighbor PfxRcd	V	AS	MsgRcv	MsgSen	TblVer	InQ	OutQ	Up/Down	State/
3.3.3.3 3	4	65000	378	368	17	0	0	02:27:00	
10.1.1.1 2	4	100	373	361	17	0	0	02:27:00	

Total number of neighbors 2

Total number of Established sessions 2
BGP router identifier 66.1.1.2, local AS number 65000
BGP VRF vrf100 Route Distinguisher: 100:1
BGP table version is 1
3 BGP AS-PATH entries
0 BGP community entries

Neighbor PfxRcd	V	AS	MsgRcv	MsgSen	TblVer	InQ	OutQ	Up/Down	State/
66.1.1.1 2	4	100	358	363	1	0	0	02:27:00	

Total number of neighbors 1

Total number of Established sessions 1
PE1#

```

PE1#sh ip bgp ipv4 flowspec
BGP table version is 17, local router ID is 1.1.1.1
Status codes: s suppressed, d damped, h history, a add-path, * valid, > best, i -
internal,
                l - labeled, S Stale
Origin codes: i - IGP, e - EGP, ? - incomplete

```

	Network	Next Hop	Metric	LocPrf	Weight	Path
*>	flowspec/136	10.1.1.1	0	100	0	100 i
*>i	flowspec/200	3.3.3.3	0	100	0	200 i
*>i	flowspec/152	3.3.3.3	0	100	0	i
*	flowspec/152	10.1.1.1	0	100	0	100 i
*>	flowspec/48	0.0.0.0	0	100	32768	i
*>i	flowspec/152	3.3.3.3	0	100	0	200 i

Total number of prefixes 6

PE1#

```

PE1#sh ip bgp ipv4 flowspec detail
BGP table version is 17, local router ID is 1.1.1.1
Status codes: s suppressed, d damped, h history, a add-path, * valid, > best, i -
internal,
                l - labeled, S Stale
Origin codes: i - IGP, e - EGP, ? - incomplete

```

	Network	Next Hop	Metric	LocPrf	Weight	Path
*>	flowspec/136	10.1.1.1	0	100	0	100 i

FlowSpec:

```

destination ip address: 10.1.1.0/24
source ip address: 10.1.1.0/24
TCP/UDP source port:
  e:0 a:0 len:1 lt:0 gt:1 eq:1 data:22
  e:1 a:1 len:1 lt:1 gt:0 eq:1 data:122

```

FlowSpec Actions:

```

traffic_rate: 21000 bps

```

*>i	flowspec/200	3.3.3.3	0	100	0	200 i
-----	--------------	---------	---	-----	---	-------

FlowSpec:

```

destination ip address: 30.1.1.0/24
source ip address: 30.1.1.0/24
TCP/UDP source port:
  e:0 a:0 len:1 lt:0 gt:1 eq:1 data:500
  e:1 a:1 len:1 lt:1 gt:0 eq:1 data:600
TCP flags:
  e:0 a:0 len:0 not:0 m:1 data:0x21
  e:1 a:1 len:0 not:1 m:0 data:0x1e
DSCP:
  e:1 a:0 len:0 lt:0 gt:0 eq:1 data:0x21

```

FlowSpec Actions:

traffic_rate: 500000 bps
traffic marking DSCP: 1e

```
*>i flowspec/152      3.3.3.3              0          100         0          i
```

FlowSpec:

destination ip address: 1.1.1.1/32
source ip address: 3.3.3.3/32
TCP/UDP destination port:
e:0 a:0 len:1 lt:0 gt:1 eq:1 data:300
e:1 a:1 len:1 lt:1 gt:0 eq:1 data:399

FlowSpec Actions:

traffic_rate: 1111111 bps

```
* flowspec/152      10.1.1.1             0          100         0          100 i
```

FlowSpec:

destination ip address: 3.3.3.3/32
source ip address: 3.3.3.3/32
TCP/UDP destination port:
e:0 a:0 len:1 lt:0 gt:1 eq:1 data:44
e:1 a:1 len:1 lt:1 gt:0 eq:1 data:144

FlowSpec Actions:

traffic_rate: 4444444 bps

```
*> flowspec/48      0.0.0.0              0          100         32768      i
```

FlowSpec:

destination ip address: 4.4.4.4/32

FlowSpec Actions:

rt_redirect: as_type: as 100:10 vrf_id:0 fib_id:0

```
*>i flowspec/152      3.3.3.3              0          100         0          200 i
```

FlowSpec:

destination ip address: 5.5.5.5/32
source ip address: 5.5.5.5/32
TCP/UDP destination port:
e:0 a:0 len:1 lt:0 gt:1 eq:1 data:1300
e:1 a:1 len:1 lt:1 gt:0 eq:1 data:1400

FlowSpec Actions:

traffic_rate: 100000 bps

Total number of prefixes 6

PE1#

PE1#show ip bgp ipv4 flowspec vrf all

BGP table version is 1, local router ID is 66.1.1.2

Status codes: s suppressed, d damped, h history, a add-path, * valid, > best, i - internal,

l - labeled, S Stale

Origin codes: i - IGP, e - EGP, ? - incomplete

Network	Next Hop	Metric	LocPrf	Weight	Path
BGP Route Table for VRF vrf100					
*> flowspec/136	66.1.1.1	0	100	0	100 i
*>i flowspec/200	3.3.3.3	0	100	0	200 i
* flowspec/152	66.1.1.1	0	100	0	100 i
*>i flowspec/152	3.3.3.3	0	100	0	200 i

Total number of prefixes 4

*> flowspec/136	10.1.1.1	0	100	0	100 i
*>i flowspec/200	3.3.3.3	0	100	0	200 i
*>i flowspec/152	3.3.3.3	0	100	0	i
* flowspec/152	10.1.1.1	0	100	0	100 i
*> flowspec/48	0.0.0.0	0	100	32768	i
*>i flowspec/152	3.3.3.3	0	100	0	200 i

Total number of prefixes 6

PE1#

PE1#show ip bgp ipv4 flowspec vrf all detail

BGP table version is 1, local router ID is 66.1.1.2

Status codes: s suppressed, d damped, h history, a add-path, * valid, > best, i - internal,

l - labeled, S Stale

Origin codes: i - IGP, e - EGP, ? - incomplete

Network	Next Hop	Metric	LocPrf	Weight	Path
BGP Route Table for VRF vrf100					
*> flowspec/136	66.1.1.1	0	100	0	100 i

FlowSpec:

destination ip address: 10.1.1.0/24

source ip address: 10.1.1.0/24

TCP/UDP source port:

e:0 a:0 len:1 lt:0 gt:1 eq:1 data:22

e:1 a:1 len:1 lt:1 gt:0 eq:1 data:122

FlowSpec Actions:

traffic_rate: 21000 bps

*>i flowspec/200	3.3.3.3	0	100	0	200 i
------------------	---------	---	-----	---	-------

FlowSpec:

destination ip address: 30.1.1.0/24
source ip address: 30.1.1.0/24
TCP/UDP source port:
 e:0 a:0 len:1 lt:0 gt:1 eq:1 data:500
 e:1 a:1 len:1 lt:1 gt:0 eq:1 data:600
TCP flags:
 e:0 a:0 len:0 not:0 m:1 data:0x21
 e:1 a:1 len:0 not:1 m:0 data:0x1e
DSCP:
 e:1 a:0 len:0 lt:0 gt:0 eq:1 data:0x21

FlowSpec Actions:

traffic_rate: 500000 bps
traffic marking DSCP: 1e

* flowspec/152 66.1.1.1 0 100 0 100 i

FlowSpec:

destination ip address: 3.3.3.3/32
source ip address: 3.3.3.3/32
TCP/UDP destination port:
 e:0 a:0 len:1 lt:0 gt:1 eq:1 data:44
 e:1 a:1 len:1 lt:1 gt:0 eq:1 data:144

FlowSpec Actions:

traffic_rate: 44444444 bps

*>i flowspec/152 3.3.3.3 0 100 0 200 i

FlowSpec:

destination ip address: 5.5.5.5/32
source ip address: 5.5.5.5/32
TCP/UDP destination port:
 e:0 a:0 len:1 lt:0 gt:1 eq:1 data:1300
 e:1 a:1 len:1 lt:1 gt:0 eq:1 data:1400

FlowSpec Actions:

traffic_rate: 100000 bps

Total number of prefixes 4

*> flowspec/136 10.1.1.1 0 100 0 100 i

FlowSpec:

destination ip address: 10.1.1.0/24
source ip address: 10.1.1.0/24
TCP/UDP source port:
 e:0 a:0 len:1 lt:0 gt:1 eq:1 data:22

e:1 a:1 len:1 lt:1 gt:0 eq:1 data:122

FlowSpec Actions:

traffic_rate: 21000 bps

*>i flowspec/200 3.3.3.3 0 100 0 200 i

FlowSpec:

destination ip address: 30.1.1.0/24

source ip address: 30.1.1.0/24

TCP/UDP source port:

e:0 a:0 len:1 lt:0 gt:1 eq:1 data:500

e:1 a:1 len:1 lt:1 gt:0 eq:1 data:600

TCP flags:

e:0 a:0 len:0 not:0 m:1 data:0x21

e:1 a:1 len:0 not:1 m:0 data:0x1e

DSCP:

e:1 a:0 len:0 lt:0 gt:0 eq:1 data:0x21

FlowSpec Actions:

traffic_rate: 500000 bps

traffic marking DSCP: 1e

*>i flowspec/152 3.3.3.3 0 100 0 i

FlowSpec:

destination ip address: 1.1.1.1/32

source ip address: 3.3.3.3/32

TCP/UDP destination port:

e:0 a:0 len:1 lt:0 gt:1 eq:1 data:300

e:1 a:1 len:1 lt:1 gt:0 eq:1 data:399

FlowSpec Actions:

traffic_rate: 1111111 bps

* flowspec/152 10.1.1.1 0 100 0 100 i

FlowSpec:

destination ip address: 3.3.3.3/32

source ip address: 3.3.3.3/32

TCP/UDP destination port:

e:0 a:0 len:1 lt:0 gt:1 eq:1 data:44

e:1 a:1 len:1 lt:1 gt:0 eq:1 data:144

FlowSpec Actions:

traffic_rate: 4444444 bps

*> flowspec/48 0.0.0.0 0 100 32768 i

FlowSpec:

BGP Flowspec Support for IPv4

destination ip address: 4.4.4.4/32

FlowSpec Actions:

rt_redirect: as_type: as 100:10 vrf_id:0 fib_id:0

```
*>i flowspec/152      3.3.3.3              0          100         0    200 i
```

FlowSpec:

destination ip address: 5.5.5.5/32

source ip address: 5.5.5.5/32

TCP/UDP destination port:

e:0 a:0 len:1 lt:0 gt:1 eq:1 data:1300

e:1 a:1 len:1 lt:1 gt:0 eq:1 data:1400

FlowSpec Actions:

traffic_rate: 100000 bps

Total number of prefixes 6

PE1#

PE1#show ip bgp vpnv4 all

Status codes: s suppressed, d damped, h history, a add-path, * valid, > best, i - internal, l - labeled

S Stale

Origin codes: i - IGP, e - EGP, ? - incomplete

	Network	Next Hop	Metric	LocPrf	Weight	Path
Route Distinguisher: 100:1 (Default for VRF vrf100)						
*>	1 4.4.4.4/32	66.1.1.1	0	100	0	100 ?
*>i	5.5.5.5/32	3.3.3.3	0	100	0	200 ?
*>	1 10.1.1.0/24	66.1.1.1	0	100	0	100 ?
*>i	30.1.1.0/24	3.3.3.3	0	100	0	200 ?
*>i	55.1.1.0/24	3.3.3.3	0	100	0	? ?
*>	1 66.1.1.0/24	0.0.0.0	0	100	32768	? ?
*		66.1.1.1	0	100	0	100 ?
*>	1 100.1.1.0/24	66.1.1.1	0	100	0	100 ?
*>i	200.1.1.0	3.3.3.3	0	100	0	200 ?

Announced routes count = 5

Accepted routes count = 4

Route Distinguisher: 100:1

*>i	5.5.5.5/32	3.3.3.3	0	100	0	200 ?
*>i	30.1.1.0/24	3.3.3.3	0	100	0	200 ?
*>i	55.1.1.0/24	3.3.3.3	0	100	0	? ?
*>i	200.1.1.0	3.3.3.3	0	100	0	200 ?

Announced routes count = 0

Accepted routes count = 4

PE1#

PE1#show ip bgp vpnv4 flowspec summary

BGP router identifier 1.1.1.1, local AS number 65000

BGP table version is 5
 3 BGP AS-PATH entries
 0 BGP community entries

Neighbor PfxRcd	V	AS	MsgRcv	MsgSen	TblVer	InQ	OutQ	Up/Down	State/
3.3.3.3 2	4	65000	384	375	5	0	0	02:30:02	

Total number of neighbors 1

Total number of Established sessions 1

PE1#

PE1#show ip bgp vpnv4 flowspec vrf vrf100

Status codes: s suppressed, d damped, h history, a add-path, * valid, > best, i - internal, l - labeled

S Stale

Origin codes: i - IGP, e - EGP, ? - incomplete

Network	Next Hop	Metric	LocPrf	Weight	Path
Route Distinguisher: 100:1 (Default for VRF vrf100)					
*> flowspec/136	66.1.1.1	0	100	0	100 i
*>i flowspec/200	3.3.3.3	0	100	0	200 i
* flowspec/152	66.1.1.1	0	100	0	100 i
*>i flowspec/152	3.3.3.3	0	100	0	200 i

Announced routes count = 2

Accepted routes count = 2

PE1#

PE1#show ip bgp vpnv4 flowspec vrf vrf100 detail

Status codes: s suppressed, d damped, h history, a add-path, * valid, > best, i - internal, l - labeled

S Stale

Origin codes: i - IGP, e - EGP, ? - incomplete

Network	Next Hop	Metric	LocPrf	Weight	Path
Route Distinguisher: 100:1 (Default for VRF vrf100)					
*> flowspec/136	66.1.1.1	0	100	0	100 i

FlowSpec:

destination ip address: 10.1.1.0/24

source ip address: 10.1.1.0/24

TCP/UDP source port:

e:0 a:0 len:1 lt:0 gt:1 eq:1 data:22

e:1 a:1 len:1 lt:1 gt:0 eq:1 data:122

FlowSpec Actions:

traffic_rate: 21000 bps

*>i flowspec/200	3.3.3.3	0	100	0	200 i
------------------	---------	---	-----	---	-------

FlowSpec:

destination ip address: 30.1.1.0/24
source ip address: 30.1.1.0/24
TCP/UDP source port:
 e:0 a:0 len:1 lt:0 gt:1 eq:1 data:500
 e:1 a:1 len:1 lt:1 gt:0 eq:1 data:600
TCP flags:
 e:0 a:0 len:0 not:0 m:1 data:0x21
 e:1 a:1 len:0 not:1 m:0 data:0x1e
DSCP:
 e:1 a:0 len:0 lt:0 gt:0 eq:1 data:0x21

FlowSpec Actions:

traffic_rate: 500000 bps
traffic marking DSCP: 1e

* flowspec/152 66.1.1.1 0 100 0 100 i

FlowSpec:

destination ip address: 3.3.3.3/32
source ip address: 3.3.3.3/32
TCP/UDP destination port:
 e:0 a:0 len:1 lt:0 gt:1 eq:1 data:44
 e:1 a:1 len:1 lt:1 gt:0 eq:1 data:144

FlowSpec Actions:

traffic_rate: 4444444 bps

*>i flowspec/152 3.3.3.3 0 100 0 200 i

FlowSpec:

destination ip address: 5.5.5.5/32
source ip address: 5.5.5.5/32
TCP/UDP destination port:
 e:0 a:0 len:1 lt:0 gt:1 eq:1 data:1300
 e:1 a:1 len:1 lt:1 gt:0 eq:1 data:1400

FlowSpec Actions:

traffic_rate: 100000 bps

Announced routes count = 2

Accepted routes count = 2

PE1#

P1

P1#show clns neighbors

Total number of L1 adjacencies: 2

Total number of L2 adjacencies: 2

Total number of adjacencies: 4

Tag 1: VRF : default

System Id	Interface	SNPA	State	Holdtime	Type	Protocol
PE1	xe7	b86a.9725.a7c2	Up	5	L1	IS-IS
			Up	5	L2	IS-IS
PE2	ce43	5c07.5819.486b	Up	8	L1	IS-IS
			Up	8	L2	IS-IS

P1#

P1#show isis database verbose

Tag 1: VRF : default

IS-IS Level-1 Link State Database:

LSPID	LSP Seq Num	LSP Checksum	LSP Holdtime	ATT/P/OL
PE1.00-00	0x00000013	0x9F2C	680	0/0/0

Area Address: 49

NLPID: 0xCC

Hostname: PE1

IP Address: 20.1.1.1

Router ID: 1.1.1.1

Metric: 10 IS-Extended PE1.02

IPv4 Interface Address: 20.1.1.1

Neighbor IP Address: 20.1.1.1

Maximum Link Bandwidth : 10000000.00 kbits/sec

Reservable Bandwidth : 10000000.00 kbits/sec

Unreserved Bandwidth:

Unreserved Bandwidth at priority 0: 10000000.00 kbits/sec

Unreserved Bandwidth at priority 1: 10000000.00 kbits/sec

Unreserved Bandwidth at priority 2: 10000000.00 kbits/sec

Unreserved Bandwidth at priority 3: 10000000.00 kbits/sec

Unreserved Bandwidth at priority 4: 10000000.00 kbits/sec

Unreserved Bandwidth at priority 5: 10000000.00 kbits/sec

Unreserved Bandwidth at priority 6: 10000000.00 kbits/sec

Unreserved Bandwidth at priority 7: 10000000.00 kbits/sec

TE-Default Metric: 10

Metric: 10 IS-Extended PE1.03

IPv4 Interface Address: 40.1.1.1

Neighbor IP Address: 40.1.1.1

Maximum Link Bandwidth : 100000000.00 kbits/sec

Reservable Bandwidth : 100000000.00 kbits/sec

Unreserved Bandwidth:

Unreserved Bandwidth at priority 0: 100000000.00 kbits/sec

Unreserved Bandwidth at priority 1: 100000000.00 kbits/sec

Unreserved Bandwidth at priority 2: 100000000.00 kbits/sec

Unreserved Bandwidth at priority 3: 100000000.00 kbits/sec

Unreserved Bandwidth at priority 4: 100000000.00 kbits/sec

Unreserved Bandwidth at priority 5: 100000000.00 kbits/sec

Unreserved Bandwidth at priority 6: 100000000.00 kbits/sec

Unreserved Bandwidth at priority 7: 100000000.00 kbits/sec

TE-Default Metric: 10

Metric: 10 IP-Extended 20.1.1.0/24

BGP Flowspec Support for IPv4

```
Metric: 0          IP-Extended 1.1.1.1/32
Metric: 10         IP-Extended 40.1.1.0/24
PE1.02-00         0x0000000F  0x6E4D          1141          0/0/0
Metric: 0          IS-Extended PE1.00
Metric: 0          IS-Extended P1.00
PE1.03-00         0x00000003  0xCFF2          344           0/0/0
Metric: 0          IS-Extended PE1.00
Metric: 0          IS-Extended P2.00
P1.00-00          * 0x00000013  0x6CF5          762           0/0/0
Area Address: 49
NLPID:           0xCC
Hostname:        P1
IP Address:      2.2.2.2
Router ID:       2.2.2.2
Metric: 10       IS-Extended PE2.02
IPv4 Interface Address: 11.1.1.2
Neighbor IP Address: 11.1.1.1
Maximum Link Bandwidth : 100000000.00 kbits/sec
Reservable Bandwidth : 100000000.00 kbits/sec
Unreserved Bandwidth:
  Unreserved Bandwidth at priority 0: 100000000.00 kbits/sec
  Unreserved Bandwidth at priority 1: 100000000.00 kbits/sec
  Unreserved Bandwidth at priority 2: 100000000.00 kbits/sec
  Unreserved Bandwidth at priority 3: 100000000.00 kbits/sec
  Unreserved Bandwidth at priority 4: 100000000.00 kbits/sec
  Unreserved Bandwidth at priority 5: 100000000.00 kbits/sec
  Unreserved Bandwidth at priority 6: 100000000.00 kbits/sec
  Unreserved Bandwidth at priority 7: 100000000.00 kbits/sec
TE-Default Metric: 10
Metric: 10       IS-Extended PE1.02
IPv4 Interface Address: 20.1.1.2
Neighbor IP Address: 20.1.1.1
Maximum Link Bandwidth : 10000000.00 kbits/sec
Reservable Bandwidth : 10000000.00 kbits/sec
Unreserved Bandwidth:
  Unreserved Bandwidth at priority 0: 10000000.00 kbits/sec
  Unreserved Bandwidth at priority 1: 10000000.00 kbits/sec
  Unreserved Bandwidth at priority 2: 10000000.00 kbits/sec
  Unreserved Bandwidth at priority 3: 10000000.00 kbits/sec
  Unreserved Bandwidth at priority 4: 10000000.00 kbits/sec
  Unreserved Bandwidth at priority 5: 10000000.00 kbits/sec
  Unreserved Bandwidth at priority 6: 10000000.00 kbits/sec
  Unreserved Bandwidth at priority 7: 10000000.00 kbits/sec
TE-Default Metric: 10
Metric: 10       IP-Extended 20.1.1.0/24
Metric: 10       IP-Extended 2.2.2.2/32
Metric: 10       IP-Extended 11.1.1.0/24
PE2.00-00         0x00000013  0x2F15          769           0/0/0
Area Address: 49
NLPID:           0xCC
```

```

Hostname:      PE2
IP Address:    11.1.1.1
Router ID:     3.3.3.3
Metric:       10          IS-Extended PE2.02
  IPv4 Interface Address: 11.1.1.1
  Neighbor IP Address: 11.1.1.1
  Maximum Link Bandwidth : 100000000.00 kbits/sec
  Reservable Bandwidth : 100000000.00 kbits/sec
  Unreserved Bandwidth:
    Unreserved Bandwidth at priority 0: 100000000.00 kbits/sec
    Unreserved Bandwidth at priority 1: 100000000.00 kbits/sec
    Unreserved Bandwidth at priority 2: 100000000.00 kbits/sec
    Unreserved Bandwidth at priority 3: 100000000.00 kbits/sec
    Unreserved Bandwidth at priority 4: 100000000.00 kbits/sec
    Unreserved Bandwidth at priority 5: 100000000.00 kbits/sec
    Unreserved Bandwidth at priority 6: 100000000.00 kbits/sec
    Unreserved Bandwidth at priority 7: 100000000.00 kbits/sec
  TE-Default Metric: 10
Metric:       10          IS-Extended PE2.01
  IPv4 Interface Address: 50.1.1.1
  Neighbor IP Address: 50.1.1.1
  Maximum Link Bandwidth : 100000000.00 kbits/sec
  Reservable Bandwidth : 100000000.00 kbits/sec
  Unreserved Bandwidth:
    Unreserved Bandwidth at priority 0: 100000000.00 kbits/sec
    Unreserved Bandwidth at priority 1: 100000000.00 kbits/sec
    Unreserved Bandwidth at priority 2: 100000000.00 kbits/sec
    Unreserved Bandwidth at priority 3: 100000000.00 kbits/sec
    Unreserved Bandwidth at priority 4: 100000000.00 kbits/sec
    Unreserved Bandwidth at priority 5: 100000000.00 kbits/sec
    Unreserved Bandwidth at priority 6: 100000000.00 kbits/sec
    Unreserved Bandwidth at priority 7: 100000000.00 kbits/sec
  TE-Default Metric: 10
Metric:       10          IP-Extended 50.1.1.0/24
Metric:       0          IP-Extended 3.3.3.3/32
Metric:       10          IP-Extended 11.1.1.0/24
PE2.01-00      0x0000000E  0xC9EB          1044          0/0/0
  Metric:       0          IS-Extended PE2.00
  Metric:       0          IS-Extended P2.00
PE2.02-00      0x0000000F  0x7047          1005          0/0/0
  Metric:       0          IS-Extended PE2.00
  Metric:       0          IS-Extended P1.00
P2.00-00      0x00000011  0x788C          749           0/0/0
Area Address: 49
NLPID:        0xCC
Hostname:      P2
IP Address:    6.6.6.6
Router ID:     6.6.6.6
Metric:       10          IS-Extended PE2.01
  IPv4 Interface Address: 50.1.1.2

```

Neighbor IP Address: 50.1.1.1
Maximum Link Bandwidth : 100000000.00 kbits/sec
Reservable Bandwidth : 100000000.00 kbits/sec
Unreserved Bandwidth:
Unreserved Bandwidth at priority 0: 100000000.00 kbits/sec
Unreserved Bandwidth at priority 1: 100000000.00 kbits/sec
Unreserved Bandwidth at priority 2: 100000000.00 kbits/sec
Unreserved Bandwidth at priority 3: 100000000.00 kbits/sec
Unreserved Bandwidth at priority 4: 100000000.00 kbits/sec
Unreserved Bandwidth at priority 5: 100000000.00 kbits/sec
Unreserved Bandwidth at priority 6: 100000000.00 kbits/sec
Unreserved Bandwidth at priority 7: 100000000.00 kbits/sec

TE-Default Metric: 10

Metric: 10 IS-Extended PE1.03
IPv4 Interface Address: 40.1.1.2
Neighbor IP Address: 40.1.1.1
Maximum Link Bandwidth : 100000000.00 kbits/sec
Reservable Bandwidth : 100000000.00 kbits/sec

Unreserved Bandwidth:
Unreserved Bandwidth at priority 0: 100000000.00 kbits/sec
Unreserved Bandwidth at priority 1: 100000000.00 kbits/sec
Unreserved Bandwidth at priority 2: 100000000.00 kbits/sec
Unreserved Bandwidth at priority 3: 100000000.00 kbits/sec
Unreserved Bandwidth at priority 4: 100000000.00 kbits/sec
Unreserved Bandwidth at priority 5: 100000000.00 kbits/sec
Unreserved Bandwidth at priority 6: 100000000.00 kbits/sec
Unreserved Bandwidth at priority 7: 100000000.00 kbits/sec

TE-Default Metric: 10

Metric: 10 IP-Extended 6.6.6.6/32
Metric: 10 IP-Extended 40.1.1.0/24
Metric: 10 IP-Extended 50.1.1.0/24

IS-IS Level-2 Link State Database:

LSPID	LSP Seq Num	LSP Checksum	LSP Holdtime	ATT/P/OL
PE1.00-00	0x00000017	0x40F9	680	0/0/0

Area Address: 49
NLPID: 0xCC
Hostname: PE1
IP Address: 20.1.1.1
Router ID: 1.1.1.1

Metric: 10 IS-Extended PE1.02
IPv4 Interface Address: 20.1.1.1
Neighbor IP Address: 20.1.1.1
Maximum Link Bandwidth : 10000000.00 kbits/sec
Reservable Bandwidth : 10000000.00 kbits/sec

Unreserved Bandwidth:
Unreserved Bandwidth at priority 0: 10000000.00 kbits/sec
Unreserved Bandwidth at priority 1: 10000000.00 kbits/sec
Unreserved Bandwidth at priority 2: 10000000.00 kbits/sec
Unreserved Bandwidth at priority 3: 10000000.00 kbits/sec

```

Unreserved Bandwidth at priority 4: 10000000.00 kbits/sec
Unreserved Bandwidth at priority 5: 10000000.00 kbits/sec
Unreserved Bandwidth at priority 6: 10000000.00 kbits/sec
Unreserved Bandwidth at priority 7: 10000000.00 kbits/sec
TE-Default Metric: 10
Metric: 10          IS-Extended PE1.03
IPv4 Interface Address: 40.1.1.1
Neighbor IP Address: 40.1.1.1
Maximum Link Bandwidth : 100000000.00 kbits/sec
Reservable Bandwidth : 100000000.00 kbits/sec
Unreserved Bandwidth:
  Unreserved Bandwidth at priority 0: 100000000.00 kbits/sec
  Unreserved Bandwidth at priority 1: 100000000.00 kbits/sec
  Unreserved Bandwidth at priority 2: 100000000.00 kbits/sec
  Unreserved Bandwidth at priority 3: 100000000.00 kbits/sec
  Unreserved Bandwidth at priority 4: 100000000.00 kbits/sec
  Unreserved Bandwidth at priority 5: 100000000.00 kbits/sec
  Unreserved Bandwidth at priority 6: 100000000.00 kbits/sec
  Unreserved Bandwidth at priority 7: 100000000.00 kbits/sec
TE-Default Metric: 10
Metric: 10          IP-Extended 20.1.1.0/24
Metric: 0           IP-Extended 1.1.1.1/32
Metric: 20          IP-Extended 2.2.2.2/32
Metric: 20          IP-Extended 11.1.1.0/24
Metric: 20          IP-Extended 3.3.3.3/32
Metric: 20          IP-Extended 50.1.1.0/24
Metric: 20          IP-Extended 6.6.6.6/32
Metric: 10          IP-Extended 40.1.1.0/24
PE1.02-00           0x0000000F  0x6E4D          1141          0/0/0
  Metric: 0          IS-Extended PE1.00
  Metric: 0          IS-Extended P1.00
PE1.03-00           0x00000003  0xCFF2          344          0/0/0
  Metric: 0          IS-Extended PE1.00
  Metric: 0          IS-Extended P2.00
P1.00-00            * 0x00000019  0xCCF2          762          0/0/0
Area Address: 49
NLPID: 0xCC
Hostname: P1
IP Address: 2.2.2.2
Router ID: 2.2.2.2
Metric: 10          IS-Extended PE2.02
IPv4 Interface Address: 11.1.1.2
Neighbor IP Address: 11.1.1.1
Maximum Link Bandwidth : 100000000.00 kbits/sec
Reservable Bandwidth : 100000000.00 kbits/sec
Unreserved Bandwidth:
  Unreserved Bandwidth at priority 0: 100000000.00 kbits/sec
  Unreserved Bandwidth at priority 1: 100000000.00 kbits/sec
  Unreserved Bandwidth at priority 2: 100000000.00 kbits/sec
  Unreserved Bandwidth at priority 3: 100000000.00 kbits/sec

```

```
Unreserved Bandwidth at priority 4: 100000000.00 kbits/sec
Unreserved Bandwidth at priority 5: 100000000.00 kbits/sec
Unreserved Bandwidth at priority 6: 100000000.00 kbits/sec
Unreserved Bandwidth at priority 7: 100000000.00 kbits/sec
TE-Default Metric: 10
Metric: 10          IS-Extended PE1.02
IPv4 Interface Address: 20.1.1.2
Neighbor IP Address: 20.1.1.1
Maximum Link Bandwidth : 10000000.00 kbits/sec
Reservable Bandwidth : 10000000.00 kbits/sec
Unreserved Bandwidth:
Unreserved Bandwidth at priority 0: 10000000.00 kbits/sec
Unreserved Bandwidth at priority 1: 10000000.00 kbits/sec
Unreserved Bandwidth at priority 2: 10000000.00 kbits/sec
Unreserved Bandwidth at priority 3: 10000000.00 kbits/sec
Unreserved Bandwidth at priority 4: 10000000.00 kbits/sec
Unreserved Bandwidth at priority 5: 10000000.00 kbits/sec
Unreserved Bandwidth at priority 6: 10000000.00 kbits/sec
Unreserved Bandwidth at priority 7: 10000000.00 kbits/sec
TE-Default Metric: 10
Metric: 10          IP-Extended 20.1.1.0/24
Metric: 10          IP-Extended 2.2.2.2/32
Metric: 10          IP-Extended 11.1.1.0/24
Metric: 10          IP-Extended 3.3.3.3/32
Metric: 20          IP-Extended 50.1.1.0/24
Metric: 10          IP-Extended 1.1.1.1/32
Metric: 30          IP-Extended 6.6.6.6/32
Metric: 20          IP-Extended 40.1.1.0/24
PE2.00-00          0x00000016  0x1BA1          769          0/0/0
Area Address: 49
NLPID: 0xCC
Hostname: PE2
IP Address: 11.1.1.1
Router ID: 3.3.3.3
Metric: 10          IS-Extended PE2.02
IPv4 Interface Address: 11.1.1.1
Neighbor IP Address: 11.1.1.1
Maximum Link Bandwidth : 100000000.00 kbits/sec
Reservable Bandwidth : 100000000.00 kbits/sec
Unreserved Bandwidth:
Unreserved Bandwidth at priority 0: 100000000.00 kbits/sec
Unreserved Bandwidth at priority 1: 100000000.00 kbits/sec
Unreserved Bandwidth at priority 2: 100000000.00 kbits/sec
Unreserved Bandwidth at priority 3: 100000000.00 kbits/sec
Unreserved Bandwidth at priority 4: 100000000.00 kbits/sec
Unreserved Bandwidth at priority 5: 100000000.00 kbits/sec
Unreserved Bandwidth at priority 6: 100000000.00 kbits/sec
Unreserved Bandwidth at priority 7: 100000000.00 kbits/sec
TE-Default Metric: 10
Metric: 10          IS-Extended PE2.01
```

```

IPv4 Interface Address: 50.1.1.1
Neighbor IP Address: 50.1.1.1
Maximum Link Bandwidth : 100000000.00 kbits/sec
Reservable Bandwidth : 100000000.00 kbits/sec
Unreserved Bandwidth:
  Unreserved Bandwidth at priority 0: 100000000.00 kbits/sec
  Unreserved Bandwidth at priority 1: 100000000.00 kbits/sec
  Unreserved Bandwidth at priority 2: 100000000.00 kbits/sec
  Unreserved Bandwidth at priority 3: 100000000.00 kbits/sec
  Unreserved Bandwidth at priority 4: 100000000.00 kbits/sec
  Unreserved Bandwidth at priority 5: 100000000.00 kbits/sec
  Unreserved Bandwidth at priority 6: 100000000.00 kbits/sec
  Unreserved Bandwidth at priority 7: 100000000.00 kbits/sec
TE-Default Metric: 10
Metric: 10      IP-Extended 50.1.1.0/24
Metric: 0      IP-Extended 3.3.3.3/32
Metric: 10     IP-Extended 11.1.1.0/24
Metric: 20     IP-Extended 2.2.2.2/32
Metric: 20     IP-Extended 20.1.1.0/24
Metric: 20     IP-Extended 1.1.1.1/32
Metric: 20     IP-Extended 6.6.6.6/32
Metric: 20     IP-Extended 40.1.1.0/24
PE2.01-00      0x0000000E  0xC9EB          1044          0/0/0
  Metric: 0      IS-Extended PE2.00
  Metric: 0      IS-Extended P2.00
PE2.02-00      0x0000000F  0x7047          1004          0/0/0
  Metric: 0      IS-Extended PE2.00
  Metric: 0      IS-Extended P1.00
P2.00-00       0x00000014  0x3E72           749          0/0/0
Area Address: 49
NLPID:         0xCC
Hostname:      P2
IP Address:    6.6.6.6
Router ID:     6.6.6.6
Metric: 10     IS-Extended PE2.01
  IPv4 Interface Address: 50.1.1.2
  Neighbor IP Address: 50.1.1.1
  Maximum Link Bandwidth : 100000000.00 kbits/sec
  Reservable Bandwidth : 100000000.00 kbits/sec
  Unreserved Bandwidth:
    Unreserved Bandwidth at priority 0: 100000000.00 kbits/sec
    Unreserved Bandwidth at priority 1: 100000000.00 kbits/sec
    Unreserved Bandwidth at priority 2: 100000000.00 kbits/sec
    Unreserved Bandwidth at priority 3: 100000000.00 kbits/sec
    Unreserved Bandwidth at priority 4: 100000000.00 kbits/sec
    Unreserved Bandwidth at priority 5: 100000000.00 kbits/sec
    Unreserved Bandwidth at priority 6: 100000000.00 kbits/sec
    Unreserved Bandwidth at priority 7: 100000000.00 kbits/sec
  TE-Default Metric: 10
  Metric: 10     IS-Extended PE1.03

```

```
IPv4 Interface Address: 40.1.1.2
Neighbor IP Address: 40.1.1.1
Maximum Link Bandwidth : 100000000.00 kbits/sec
Reservable Bandwidth : 100000000.00 kbits/sec
Unreserved Bandwidth:
  Unreserved Bandwidth at priority 0: 100000000.00 kbits/sec
  Unreserved Bandwidth at priority 1: 100000000.00 kbits/sec
  Unreserved Bandwidth at priority 2: 100000000.00 kbits/sec
  Unreserved Bandwidth at priority 3: 100000000.00 kbits/sec
  Unreserved Bandwidth at priority 4: 100000000.00 kbits/sec
  Unreserved Bandwidth at priority 5: 100000000.00 kbits/sec
  Unreserved Bandwidth at priority 6: 100000000.00 kbits/sec
  Unreserved Bandwidth at priority 7: 100000000.00 kbits/sec
TE-Default Metric: 10
Metric: 10      IP-Extended 6.6.6.6/32
Metric: 10      IP-Extended 40.1.1.0/24
Metric: 10      IP-Extended 50.1.1.0/24
Metric: 10      IP-Extended 1.1.1.1/32
Metric: 30      IP-Extended 2.2.2.2/32
Metric: 10      IP-Extended 3.3.3.3/32
Metric: 20      IP-Extended 11.1.1.0/24
Metric: 20      IP-Extended 20.1.1.0/24
```

P1#

P2

P2#show clns neighbors

```
Total number of L1 adjacencies: 2
Total number of L2 adjacencies: 2
Total number of adjacencies: 4
Tag 1: VRF : default
System Id      Interface  SNPA                State  Holdtime  Type  Protocol
PE1            ce51      b86a.9725.a7ee      Up     7          L1   IS-IS
               ce51      b86a.9725.a7ee      Up     7          L2   IS-IS
PE2            ce53      5c07.5819.4878      Up     7          L1   IS-IS
               ce53      5c07.5819.4878      Up     7          L2   IS-IS
```

P2#

P2#show isis database verbose

```
Tag 1: VRF : default
IS-IS Level-1 Link State Database:
LSPID          LSP Seq Num  LSP Checksum  LSP Holdtime  ATT/P/OL
PE1.00-00      0x00000013  0x9F2C        620           0/0/0
  Area Address: 49
  NLPID:        0xCC
  Hostname:     PE1
  IP Address:   20.1.1.1
  Router ID:    1.1.1.1
  Metric:       10      IS-Extended PE1.02
  IPv4 Interface Address: 20.1.1.1
```

```

Neighbor IP Address: 20.1.1.1
Maximum Link Bandwidth : 10000000.00 kbits/sec
Reservable Bandwidth : 10000000.00 kbits/sec
Unreserved Bandwidth:
  Unreserved Bandwidth at priority 0: 10000000.00 kbits/sec
  Unreserved Bandwidth at priority 1: 10000000.00 kbits/sec
  Unreserved Bandwidth at priority 2: 10000000.00 kbits/sec
  Unreserved Bandwidth at priority 3: 10000000.00 kbits/sec
  Unreserved Bandwidth at priority 4: 10000000.00 kbits/sec
  Unreserved Bandwidth at priority 5: 10000000.00 kbits/sec
  Unreserved Bandwidth at priority 6: 10000000.00 kbits/sec
  Unreserved Bandwidth at priority 7: 10000000.00 kbits/sec
TE-Default Metric: 10
Metric: 10          IS-Extended PE1.03
IPv4 Interface Address: 40.1.1.1
Neighbor IP Address: 40.1.1.1
Maximum Link Bandwidth : 100000000.00 kbits/sec
Reservable Bandwidth : 100000000.00 kbits/sec
Unreserved Bandwidth:
  Unreserved Bandwidth at priority 0: 100000000.00 kbits/sec
  Unreserved Bandwidth at priority 1: 100000000.00 kbits/sec
  Unreserved Bandwidth at priority 2: 100000000.00 kbits/sec
  Unreserved Bandwidth at priority 3: 100000000.00 kbits/sec
  Unreserved Bandwidth at priority 4: 100000000.00 kbits/sec
  Unreserved Bandwidth at priority 5: 100000000.00 kbits/sec
  Unreserved Bandwidth at priority 6: 100000000.00 kbits/sec
  Unreserved Bandwidth at priority 7: 100000000.00 kbits/sec
TE-Default Metric: 10
Metric: 10          IP-Extended 20.1.1.0/24
Metric: 0           IP-Extended 1.1.1.1/32
Metric: 10          IP-Extended 40.1.1.0/24
PE1.02-00          0x0000000F  0x6E4D          1082          0/0/0
Metric: 0          IS-Extended PE1.00
Metric: 0          IS-Extended P1.00
PE1.03-00          0x00000004  0xCDF3          1185          0/0/0
Metric: 0          IS-Extended PE1.00
Metric: 0          IS-Extended P2.00
P1.00-00           0x00000013  0x6CF5          701           0/0/0
Area Address: 49
NLPID: 0xCC
Hostname: P1
IP Address: 2.2.2.2
Router ID: 2.2.2.2
Metric: 10          IS-Extended PE2.02
IPv4 Interface Address: 11.1.1.2
Neighbor IP Address: 11.1.1.1
Maximum Link Bandwidth : 100000000.00 kbits/sec
Reservable Bandwidth : 100000000.00 kbits/sec
Unreserved Bandwidth:
  Unreserved Bandwidth at priority 0: 100000000.00 kbits/sec

```

Unreserved Bandwidth at priority 1: 100000000.00 kbits/sec
Unreserved Bandwidth at priority 2: 100000000.00 kbits/sec
Unreserved Bandwidth at priority 3: 100000000.00 kbits/sec
Unreserved Bandwidth at priority 4: 100000000.00 kbits/sec
Unreserved Bandwidth at priority 5: 100000000.00 kbits/sec
Unreserved Bandwidth at priority 6: 100000000.00 kbits/sec
Unreserved Bandwidth at priority 7: 100000000.00 kbits/sec

TE-Default Metric: 10

Metric: 10 IS-Extended PE1.02

IPv4 Interface Address: 20.1.1.2

Neighbor IP Address: 20.1.1.1

Maximum Link Bandwidth : 10000000.00 kbits/sec

Reservable Bandwidth : 10000000.00 kbits/sec

Unreserved Bandwidth:

Unreserved Bandwidth at priority 0: 10000000.00 kbits/sec
Unreserved Bandwidth at priority 1: 10000000.00 kbits/sec
Unreserved Bandwidth at priority 2: 10000000.00 kbits/sec
Unreserved Bandwidth at priority 3: 10000000.00 kbits/sec
Unreserved Bandwidth at priority 4: 10000000.00 kbits/sec
Unreserved Bandwidth at priority 5: 10000000.00 kbits/sec
Unreserved Bandwidth at priority 6: 10000000.00 kbits/sec
Unreserved Bandwidth at priority 7: 10000000.00 kbits/sec

TE-Default Metric: 10

Metric: 10 IP-Extended 20.1.1.0/24

Metric: 10 IP-Extended 2.2.2.2/32

Metric: 10 IP-Extended 11.1.1.0/24

PE2.00-00 0x00000013 0x2F15 709 0/0/0

Area Address: 49

NLPID: 0xCC

Hostname: PE2

IP Address: 11.1.1.1

Router ID: 3.3.3.3

Metric: 10 IS-Extended PE2.02

IPv4 Interface Address: 11.1.1.1

Neighbor IP Address: 11.1.1.1

Maximum Link Bandwidth : 100000000.00 kbits/sec

Reservable Bandwidth : 100000000.00 kbits/sec

Unreserved Bandwidth:

Unreserved Bandwidth at priority 0: 100000000.00 kbits/sec
Unreserved Bandwidth at priority 1: 100000000.00 kbits/sec
Unreserved Bandwidth at priority 2: 100000000.00 kbits/sec
Unreserved Bandwidth at priority 3: 100000000.00 kbits/sec
Unreserved Bandwidth at priority 4: 100000000.00 kbits/sec
Unreserved Bandwidth at priority 5: 100000000.00 kbits/sec
Unreserved Bandwidth at priority 6: 100000000.00 kbits/sec
Unreserved Bandwidth at priority 7: 100000000.00 kbits/sec

TE-Default Metric: 10

Metric: 10 IS-Extended PE2.01

IPv4 Interface Address: 50.1.1.1

Neighbor IP Address: 50.1.1.1

```

Maximum Link Bandwidth : 100000000.00 kbits/sec
Reservable Bandwidth : 100000000.00 kbits/sec
Unreserved Bandwidth:
  Unreserved Bandwidth at priority 0: 100000000.00 kbits/sec
  Unreserved Bandwidth at priority 1: 100000000.00 kbits/sec
  Unreserved Bandwidth at priority 2: 100000000.00 kbits/sec
  Unreserved Bandwidth at priority 3: 100000000.00 kbits/sec
  Unreserved Bandwidth at priority 4: 100000000.00 kbits/sec
  Unreserved Bandwidth at priority 5: 100000000.00 kbits/sec
  Unreserved Bandwidth at priority 6: 100000000.00 kbits/sec
  Unreserved Bandwidth at priority 7: 100000000.00 kbits/sec
TE-Default Metric: 10
Metric: 10      IP-Extended 50.1.1.0/24
Metric: 0      IP-Extended 3.3.3.3/32
Metric: 10     IP-Extended 11.1.1.0/24
PE2.01-00      0x0000000E  0xC9EB          984          0/0/0
Metric: 0      IS-Extended PE2.00
Metric: 0      IS-Extended P2.00
PE2.02-00      0x0000000F  0x7047          945          0/0/0
Metric: 0      IS-Extended PE2.00
Metric: 0      IS-Extended P1.00
P2.00-00      * 0x00000011  0x788C          690          0/0/0
Area Address: 49
NLPID:        0xCC
Hostname:      P2
IP Address:    6.6.6.6
Router ID:    6.6.6.6
Metric: 10     IS-Extended PE2.01
IPv4 Interface Address: 50.1.1.2
Neighbor IP Address: 50.1.1.1
Maximum Link Bandwidth : 100000000.00 kbits/sec
Reservable Bandwidth : 100000000.00 kbits/sec
Unreserved Bandwidth:
  Unreserved Bandwidth at priority 0: 100000000.00 kbits/sec
  Unreserved Bandwidth at priority 1: 100000000.00 kbits/sec
  Unreserved Bandwidth at priority 2: 100000000.00 kbits/sec
  Unreserved Bandwidth at priority 3: 100000000.00 kbits/sec
  Unreserved Bandwidth at priority 4: 100000000.00 kbits/sec
  Unreserved Bandwidth at priority 5: 100000000.00 kbits/sec
  Unreserved Bandwidth at priority 6: 100000000.00 kbits/sec
  Unreserved Bandwidth at priority 7: 100000000.00 kbits/sec
TE-Default Metric: 10
Metric: 10     IS-Extended PE1.03
IPv4 Interface Address: 40.1.1.2
Neighbor IP Address: 40.1.1.1
Maximum Link Bandwidth : 100000000.00 kbits/sec
Reservable Bandwidth : 100000000.00 kbits/sec
Unreserved Bandwidth:
  Unreserved Bandwidth at priority 0: 100000000.00 kbits/sec
  Unreserved Bandwidth at priority 1: 100000000.00 kbits/sec

```

Unreserved Bandwidth at priority 2: 100000000.00 kbits/sec
Unreserved Bandwidth at priority 3: 100000000.00 kbits/sec
Unreserved Bandwidth at priority 4: 100000000.00 kbits/sec
Unreserved Bandwidth at priority 5: 100000000.00 kbits/sec
Unreserved Bandwidth at priority 6: 100000000.00 kbits/sec
Unreserved Bandwidth at priority 7: 100000000.00 kbits/sec

TE-Default Metric: 10

Metric: 10 IP-Extended 6.6.6.6/32
Metric: 10 IP-Extended 40.1.1.0/24
Metric: 10 IP-Extended 50.1.1.0/24

IS-IS Level-2 Link State Database:

LSPID	LSP Seq Num	LSP Checksum	LSP Holdtime	ATT/P/OL
PE1.00-00	0x00000017	0x40F9	620	0/0/0

Area Address: 49

NLPID: 0xCC

Hostname: PE1

IP Address: 20.1.1.1

Router ID: 1.1.1.1

Metric: 10 IS-Extended PE1.02

IPv4 Interface Address: 20.1.1.1

Neighbor IP Address: 20.1.1.1

Maximum Link Bandwidth : 10000000.00 kbits/sec

Reservable Bandwidth : 10000000.00 kbits/sec

Unreserved Bandwidth:

Unreserved Bandwidth at priority 0: 10000000.00 kbits/sec
Unreserved Bandwidth at priority 1: 10000000.00 kbits/sec
Unreserved Bandwidth at priority 2: 10000000.00 kbits/sec
Unreserved Bandwidth at priority 3: 10000000.00 kbits/sec
Unreserved Bandwidth at priority 4: 10000000.00 kbits/sec
Unreserved Bandwidth at priority 5: 10000000.00 kbits/sec
Unreserved Bandwidth at priority 6: 10000000.00 kbits/sec
Unreserved Bandwidth at priority 7: 10000000.00 kbits/sec

TE-Default Metric: 10

Metric: 10 IS-Extended PE1.03

IPv4 Interface Address: 40.1.1.1

Neighbor IP Address: 40.1.1.1

Maximum Link Bandwidth : 100000000.00 kbits/sec

Reservable Bandwidth : 100000000.00 kbits/sec

Unreserved Bandwidth:

Unreserved Bandwidth at priority 0: 100000000.00 kbits/sec
Unreserved Bandwidth at priority 1: 100000000.00 kbits/sec
Unreserved Bandwidth at priority 2: 100000000.00 kbits/sec
Unreserved Bandwidth at priority 3: 100000000.00 kbits/sec
Unreserved Bandwidth at priority 4: 100000000.00 kbits/sec
Unreserved Bandwidth at priority 5: 100000000.00 kbits/sec
Unreserved Bandwidth at priority 6: 100000000.00 kbits/sec
Unreserved Bandwidth at priority 7: 100000000.00 kbits/sec

TE-Default Metric: 10

Metric: 10 IP-Extended 20.1.1.0/24

```

Metric: 0          IP-Extended 1.1.1.1/32
Metric: 20         IP-Extended 2.2.2.2/32
Metric: 20         IP-Extended 11.1.1.0/24
Metric: 20         IP-Extended 3.3.3.3/32
Metric: 20         IP-Extended 50.1.1.0/24
Metric: 20         IP-Extended 6.6.6.6/32
Metric: 10         IP-Extended 40.1.1.0/24
PE1.02-00         0x0000000F  0x6E4D          1082          0/0/0
Metric: 0          IS-Extended PE1.00
Metric: 0          IS-Extended P1.00
PE1.03-00         0x00000004  0xCDF3          1185          0/0/0
Metric: 0          IS-Extended PE1.00
Metric: 0          IS-Extended P2.00
P1.00-00          0x00000019  0xCCF2          701           0/0/0
Area Address: 49
NLPID:           0xCC
Hostname:        P1
IP Address:      2.2.2.2
Router ID:       2.2.2.2
Metric: 10       IS-Extended PE2.02
  IPv4 Interface Address: 11.1.1.2
  Neighbor IP Address: 11.1.1.1
  Maximum Link Bandwidth : 100000000.00 kbits/sec
  Reservable Bandwidth : 100000000.00 kbits/sec
  Unreserved Bandwidth:
    Unreserved Bandwidth at priority 0: 100000000.00 kbits/sec
    Unreserved Bandwidth at priority 1: 100000000.00 kbits/sec
    Unreserved Bandwidth at priority 2: 100000000.00 kbits/sec
    Unreserved Bandwidth at priority 3: 100000000.00 kbits/sec
    Unreserved Bandwidth at priority 4: 100000000.00 kbits/sec
    Unreserved Bandwidth at priority 5: 100000000.00 kbits/sec
    Unreserved Bandwidth at priority 6: 100000000.00 kbits/sec
    Unreserved Bandwidth at priority 7: 100000000.00 kbits/sec
  TE-Default Metric: 10
Metric: 10       IS-Extended PE1.02
  IPv4 Interface Address: 20.1.1.2
  Neighbor IP Address: 20.1.1.1
  Maximum Link Bandwidth : 10000000.00 kbits/sec
  Reservable Bandwidth : 10000000.00 kbits/sec
  Unreserved Bandwidth:
    Unreserved Bandwidth at priority 0: 10000000.00 kbits/sec
    Unreserved Bandwidth at priority 1: 10000000.00 kbits/sec
    Unreserved Bandwidth at priority 2: 10000000.00 kbits/sec
    Unreserved Bandwidth at priority 3: 10000000.00 kbits/sec
    Unreserved Bandwidth at priority 4: 10000000.00 kbits/sec
    Unreserved Bandwidth at priority 5: 10000000.00 kbits/sec
    Unreserved Bandwidth at priority 6: 10000000.00 kbits/sec
    Unreserved Bandwidth at priority 7: 10000000.00 kbits/sec
  TE-Default Metric: 10
Metric: 10       IP-Extended 20.1.1.0/24

```

Metric: 10 IP-Extended 2.2.2.2/32
Metric: 10 IP-Extended 11.1.1.0/24
Metric: 10 IP-Extended 3.3.3.3/32
Metric: 20 IP-Extended 50.1.1.0/24
Metric: 10 IP-Extended 1.1.1.1/32
Metric: 30 IP-Extended 6.6.6.6/32
Metric: 20 IP-Extended 40.1.1.0/24
PE2.00-00 0x00000016 0x1BA1 710 0/0/0
Area Address: 49
NLPID: 0xCC
Hostname: PE2
IP Address: 11.1.1.1
Router ID: 3.3.3.3
Metric: 10 IS-Extended PE2.02
IPv4 Interface Address: 11.1.1.1
Neighbor IP Address: 11.1.1.1
Maximum Link Bandwidth : 100000000.00 kbits/sec
Reservable Bandwidth : 100000000.00 kbits/sec
Unreserved Bandwidth:
Unreserved Bandwidth at priority 0: 100000000.00 kbits/sec
Unreserved Bandwidth at priority 1: 100000000.00 kbits/sec
Unreserved Bandwidth at priority 2: 100000000.00 kbits/sec
Unreserved Bandwidth at priority 3: 100000000.00 kbits/sec
Unreserved Bandwidth at priority 4: 100000000.00 kbits/sec
Unreserved Bandwidth at priority 5: 100000000.00 kbits/sec
Unreserved Bandwidth at priority 6: 100000000.00 kbits/sec
Unreserved Bandwidth at priority 7: 100000000.00 kbits/sec
TE-Default Metric: 10
Metric: 10 IS-Extended PE2.01
IPv4 Interface Address: 50.1.1.1
Neighbor IP Address: 50.1.1.1
Maximum Link Bandwidth : 100000000.00 kbits/sec
Reservable Bandwidth : 100000000.00 kbits/sec
Unreserved Bandwidth:
Unreserved Bandwidth at priority 0: 100000000.00 kbits/sec
Unreserved Bandwidth at priority 1: 100000000.00 kbits/sec
Unreserved Bandwidth at priority 2: 100000000.00 kbits/sec
Unreserved Bandwidth at priority 3: 100000000.00 kbits/sec
Unreserved Bandwidth at priority 4: 100000000.00 kbits/sec
Unreserved Bandwidth at priority 5: 100000000.00 kbits/sec
Unreserved Bandwidth at priority 6: 100000000.00 kbits/sec
Unreserved Bandwidth at priority 7: 100000000.00 kbits/sec
TE-Default Metric: 10
Metric: 10 IP-Extended 50.1.1.0/24
Metric: 0 IP-Extended 3.3.3.3/32
Metric: 10 IP-Extended 11.1.1.0/24
Metric: 20 IP-Extended 2.2.2.2/32
Metric: 20 IP-Extended 20.1.1.0/24
Metric: 20 IP-Extended 1.1.1.1/32
Metric: 20 IP-Extended 6.6.6.6/32

```

Metric: 20          IP-Extended 40.1.1.0/24
PE2.01-00          0x0000000E  0xC9EB          984          0/0/0
Metric: 0          IS-Extended PE2.00
Metric: 0          IS-Extended P2.00
PE2.02-00          0x0000000F  0x7047          945          0/0/0
Metric: 0          IS-Extended PE2.00
Metric: 0          IS-Extended P1.00
P2.00-00          * 0x00000014  0x3E72          690          0/0/0
Area Address: 49
NLPID:           0xCC
Hostname:        P2
IP Address:      6.6.6.6
Router ID:       6.6.6.6
Metric: 10       IS-Extended PE2.01
IPv4 Interface Address: 50.1.1.2
Neighbor IP Address: 50.1.1.1
Maximum Link Bandwidth : 100000000.00 kbits/sec
Reservable Bandwidth : 100000000.00 kbits/sec
Unreserved Bandwidth:
  Unreserved Bandwidth at priority 0: 100000000.00 kbits/sec
  Unreserved Bandwidth at priority 1: 100000000.00 kbits/sec
  Unreserved Bandwidth at priority 2: 100000000.00 kbits/sec
  Unreserved Bandwidth at priority 3: 100000000.00 kbits/sec
  Unreserved Bandwidth at priority 4: 100000000.00 kbits/sec
  Unreserved Bandwidth at priority 5: 100000000.00 kbits/sec
  Unreserved Bandwidth at priority 6: 100000000.00 kbits/sec
  Unreserved Bandwidth at priority 7: 100000000.00 kbits/sec
TE-Default Metric: 10
Metric: 10       IS-Extended PE1.03
IPv4 Interface Address: 40.1.1.2
Neighbor IP Address: 40.1.1.1
Maximum Link Bandwidth : 100000000.00 kbits/sec
Reservable Bandwidth : 100000000.00 kbits/sec
Unreserved Bandwidth:
  Unreserved Bandwidth at priority 0: 100000000.00 kbits/sec
  Unreserved Bandwidth at priority 1: 100000000.00 kbits/sec
  Unreserved Bandwidth at priority 2: 100000000.00 kbits/sec
  Unreserved Bandwidth at priority 3: 100000000.00 kbits/sec
  Unreserved Bandwidth at priority 4: 100000000.00 kbits/sec
  Unreserved Bandwidth at priority 5: 100000000.00 kbits/sec
  Unreserved Bandwidth at priority 6: 100000000.00 kbits/sec
  Unreserved Bandwidth at priority 7: 100000000.00 kbits/sec
TE-Default Metric: 10
Metric: 10       IP-Extended 6.6.6.6/32
Metric: 10       IP-Extended 40.1.1.0/24
Metric: 10       IP-Extended 50.1.1.0/24
Metric: 10       IP-Extended 1.1.1.1/32
Metric: 30       IP-Extended 2.2.2.2/32
Metric: 10       IP-Extended 3.3.3.3/32
Metric: 20       IP-Extended 11.1.1.0/24

```

Metric: 20 IP-Extended 20.1.1.0/24

PE2#

PE2

PE2#show clns neighbors

Total number of L1 adjacencies: 2

Total number of L2 adjacencies: 2

Total number of adjacencies: 4

Tag 1: VRF : default

System Id	Interface	SNPA	State	Holdtime	Type	Protocol
P1	ce43	3417.ebe4.af2c	Up	22	L1	IS-IS
			Up	22	L2	IS-IS
P2	ce4	3c2c.99c7.07af	Up	21	L1	IS-IS
			Up	21	L2	IS-IS

PE2#

PE2#show isis database verbose

Tag 1: VRF : default

IS-IS Level-1 Link State Database:

LSPID	LSP Seq Num	LSP Checksum	LSP Holdtime	ATT/P/OL
PE1.00-00	0x00000013	0x9F2C	529	0/0/0

Area Address: 49

NLPID: 0xCC

Hostname: PE1

IP Address: 20.1.1.1

Router ID: 1.1.1.1

Metric: 10 IS-Extended PE1.02

IPv4 Interface Address: 20.1.1.1

Neighbor IP Address: 20.1.1.1

Maximum Link Bandwidth : 10000000.00 kbits/sec

Reservable Bandwidth : 10000000.00 kbits/sec

Unreserved Bandwidth:

Unreserved Bandwidth at priority 0: 10000000.00 kbits/sec

Unreserved Bandwidth at priority 1: 10000000.00 kbits/sec

Unreserved Bandwidth at priority 2: 10000000.00 kbits/sec

Unreserved Bandwidth at priority 3: 10000000.00 kbits/sec

Unreserved Bandwidth at priority 4: 10000000.00 kbits/sec

Unreserved Bandwidth at priority 5: 10000000.00 kbits/sec

Unreserved Bandwidth at priority 6: 10000000.00 kbits/sec

Unreserved Bandwidth at priority 7: 10000000.00 kbits/sec

TE-Default Metric: 10

Metric: 10 IS-Extended PE1.03

IPv4 Interface Address: 40.1.1.1

Neighbor IP Address: 40.1.1.1

Maximum Link Bandwidth : 100000000.00 kbits/sec

Reservable Bandwidth : 100000000.00 kbits/sec

Unreserved Bandwidth:

Unreserved Bandwidth at priority 0: 100000000.00 kbits/sec

Unreserved Bandwidth at priority 1: 100000000.00 kbits/sec

```

Unreserved Bandwidth at priority 2: 100000000.00 kbits/sec
Unreserved Bandwidth at priority 3: 100000000.00 kbits/sec
Unreserved Bandwidth at priority 4: 100000000.00 kbits/sec
Unreserved Bandwidth at priority 5: 100000000.00 kbits/sec
Unreserved Bandwidth at priority 6: 100000000.00 kbits/sec
Unreserved Bandwidth at priority 7: 100000000.00 kbits/sec
TE-Default Metric: 10
Metric: 10      IP-Extended 20.1.1.0/24
Metric: 0      IP-Extended 1.1.1.1/32
Metric: 10     IP-Extended 40.1.1.0/24
PE1.02-00     0x0000000F  0x6E4D      990      0/0/0
Metric: 0     IS-Extended PE1.00
Metric: 0     IS-Extended P1.00
PE1.03-00     0x00000004  0xCDF3     1093    0/0/0
Metric: 0     IS-Extended PE1.00
Metric: 0     IS-Extended P2.00
P1.00-00      0x00000013  0x6CF5     609     0/0/0
Area Address: 49
NLPID:       0xCC
Hostname:    P1
IP Address:  2.2.2.2
Router ID:   2.2.2.2
Metric: 10   IS-Extended PE2.02
IPv4 Interface Address: 11.1.1.2
Neighbor IP Address: 11.1.1.1
Maximum Link Bandwidth : 100000000.00 kbits/sec
Reservable Bandwidth : 100000000.00 kbits/sec
Unreserved Bandwidth:
Unreserved Bandwidth at priority 0: 100000000.00 kbits/sec
Unreserved Bandwidth at priority 1: 100000000.00 kbits/sec
Unreserved Bandwidth at priority 2: 100000000.00 kbits/sec
Unreserved Bandwidth at priority 3: 100000000.00 kbits/sec
Unreserved Bandwidth at priority 4: 100000000.00 kbits/sec
Unreserved Bandwidth at priority 5: 100000000.00 kbits/sec
Unreserved Bandwidth at priority 6: 100000000.00 kbits/sec
Unreserved Bandwidth at priority 7: 100000000.00 kbits/sec
TE-Default Metric: 10
Metric: 10   IS-Extended PE1.02
IPv4 Interface Address: 20.1.1.2
Neighbor IP Address: 20.1.1.1
Maximum Link Bandwidth : 10000000.00 kbits/sec
Reservable Bandwidth : 10000000.00 kbits/sec
Unreserved Bandwidth:
Unreserved Bandwidth at priority 0: 10000000.00 kbits/sec
Unreserved Bandwidth at priority 1: 10000000.00 kbits/sec
Unreserved Bandwidth at priority 2: 10000000.00 kbits/sec
Unreserved Bandwidth at priority 3: 10000000.00 kbits/sec
Unreserved Bandwidth at priority 4: 10000000.00 kbits/sec
Unreserved Bandwidth at priority 5: 10000000.00 kbits/sec
Unreserved Bandwidth at priority 6: 10000000.00 kbits/sec

```

```

    Unreserved Bandwidth at priority 7: 10000000.00 kbits/sec
    TE-Default Metric: 10
    Metric: 10          IP-Extended 20.1.1.0/24
    Metric: 10          IP-Extended 2.2.2.2/32
    Metric: 10          IP-Extended 11.1.1.0/24
PE2.00-00          * 0x00000013  0x2F15          619          0/0/0
    Area Address: 49
    NLPID:          0xCC
    Hostname:       PE2
    IP Address:     11.1.1.1
    Router ID:      3.3.3.3
    Metric: 10          IS-Extended PE2.02
    IPv4 Interface Address: 11.1.1.1
    Neighbor IP Address: 11.1.1.1
    Maximum Link Bandwidth : 100000000.00 kbits/sec
    Reservable Bandwidth : 100000000.00 kbits/sec
    Unreserved Bandwidth:
        Unreserved Bandwidth at priority 0: 100000000.00 kbits/sec
        Unreserved Bandwidth at priority 1: 100000000.00 kbits/sec
        Unreserved Bandwidth at priority 2: 100000000.00 kbits/sec
        Unreserved Bandwidth at priority 3: 100000000.00 kbits/sec
        Unreserved Bandwidth at priority 4: 100000000.00 kbits/sec
        Unreserved Bandwidth at priority 5: 100000000.00 kbits/sec
        Unreserved Bandwidth at priority 6: 100000000.00 kbits/sec
        Unreserved Bandwidth at priority 7: 100000000.00 kbits/sec
    TE-Default Metric: 10
    Metric: 10          IS-Extended PE2.01
    IPv4 Interface Address: 50.1.1.1
    Neighbor IP Address: 50.1.1.1
    Maximum Link Bandwidth : 100000000.00 kbits/sec
    Reservable Bandwidth : 100000000.00 kbits/sec
    Unreserved Bandwidth:
        Unreserved Bandwidth at priority 0: 100000000.00 kbits/sec
        Unreserved Bandwidth at priority 1: 100000000.00 kbits/sec
        Unreserved Bandwidth at priority 2: 100000000.00 kbits/sec
        Unreserved Bandwidth at priority 3: 100000000.00 kbits/sec
        Unreserved Bandwidth at priority 4: 100000000.00 kbits/sec
        Unreserved Bandwidth at priority 5: 100000000.00 kbits/sec
        Unreserved Bandwidth at priority 6: 100000000.00 kbits/sec
        Unreserved Bandwidth at priority 7: 100000000.00 kbits/sec
    TE-Default Metric: 10
    Metric: 10          IP-Extended 50.1.1.0/24
    Metric: 0          IP-Extended 3.3.3.3/32
    Metric: 10          IP-Extended 11.1.1.0/24
PE2.01-00          * 0x0000000E  0xC9EB          893          0/0/0
    Metric: 0          IS-Extended PE2.00
    Metric: 0          IS-Extended P2.00
PE2.02-00          * 0x0000000F  0x7047          854          0/0/0
    Metric: 0          IS-Extended PE2.00
    Metric: 0          IS-Extended P1.00

```

```
P2.00-00          0x00000011   0x788C          597          0/0/0
```

```
Area Address: 49
```

```
NLPID:         0xCC
```

```
Hostname:      P2
```

```
IP Address:    6.6.6.6
```

```
Router ID:     6.6.6.6
```

```
Metric: 10      IS-Extended PE2.01
```

```
IPv4 Interface Address: 50.1.1.2
```

```
Neighbor IP Address: 50.1.1.1
```

```
Maximum Link Bandwidth : 100000000.00 kbits/sec
```

```
Reservable Bandwidth : 100000000.00 kbits/sec
```

```
Unreserved Bandwidth:
```

```
Unreserved Bandwidth at priority 0: 100000000.00 kbits/sec
```

```
Unreserved Bandwidth at priority 1: 100000000.00 kbits/sec
```

```
Unreserved Bandwidth at priority 2: 100000000.00 kbits/sec
```

```
Unreserved Bandwidth at priority 3: 100000000.00 kbits/sec
```

```
Unreserved Bandwidth at priority 4: 100000000.00 kbits/sec
```

```
Unreserved Bandwidth at priority 5: 100000000.00 kbits/sec
```

```
Unreserved Bandwidth at priority 6: 100000000.00 kbits/sec
```

```
Unreserved Bandwidth at priority 7: 100000000.00 kbits/sec
```

```
TE-Default Metric: 10
```

```
Metric: 10      IS-Extended PE1.03
```

```
IPv4 Interface Address: 40.1.1.2
```

```
Neighbor IP Address: 40.1.1.1
```

```
Maximum Link Bandwidth : 100000000.00 kbits/sec
```

```
Reservable Bandwidth : 100000000.00 kbits/sec
```

```
Unreserved Bandwidth:
```

```
Unreserved Bandwidth at priority 0: 100000000.00 kbits/sec
```

```
Unreserved Bandwidth at priority 1: 100000000.00 kbits/sec
```

```
Unreserved Bandwidth at priority 2: 100000000.00 kbits/sec
```

```
Unreserved Bandwidth at priority 3: 100000000.00 kbits/sec
```

```
Unreserved Bandwidth at priority 4: 100000000.00 kbits/sec
```

```
Unreserved Bandwidth at priority 5: 100000000.00 kbits/sec
```

```
Unreserved Bandwidth at priority 6: 100000000.00 kbits/sec
```

```
Unreserved Bandwidth at priority 7: 100000000.00 kbits/sec
```

```
TE-Default Metric: 10
```

```
Metric: 10      IP-Extended 6.6.6.6/32
```

```
Metric: 10      IP-Extended 40.1.1.0/24
```

```
Metric: 10      IP-Extended 50.1.1.0/24
```

```
IS-IS Level-2 Link State Database:
```

```
LSPID          LSP Seq Num  LSP Checksum  LSP Holdtime  ATT/P/OL
```

```
PE1.00-00      0x00000017  0x40F9        529           0/0/0
```

```
Area Address: 49
```

```
NLPID:         0xCC
```

```
Hostname:      PE1
```

```
IP Address:    20.1.1.1
```

```
Router ID:     1.1.1.1
```

```
Metric: 10      IS-Extended PE1.02
```

```
IPv4 Interface Address: 20.1.1.1
```

Neighbor IP Address: 20.1.1.1
Maximum Link Bandwidth : 10000000.00 kbits/sec
Reservable Bandwidth : 10000000.00 kbits/sec
Unreserved Bandwidth:
Unreserved Bandwidth at priority 0: 10000000.00 kbits/sec
Unreserved Bandwidth at priority 1: 10000000.00 kbits/sec
Unreserved Bandwidth at priority 2: 10000000.00 kbits/sec
Unreserved Bandwidth at priority 3: 10000000.00 kbits/sec
Unreserved Bandwidth at priority 4: 10000000.00 kbits/sec
Unreserved Bandwidth at priority 5: 10000000.00 kbits/sec
Unreserved Bandwidth at priority 6: 10000000.00 kbits/sec
Unreserved Bandwidth at priority 7: 10000000.00 kbits/sec

TE-Default Metric: 10

Metric: 10 IS-Extended PE1.03
IPv4 Interface Address: 40.1.1.1
Neighbor IP Address: 40.1.1.1
Maximum Link Bandwidth : 100000000.00 kbits/sec
Reservable Bandwidth : 100000000.00 kbits/sec

Unreserved Bandwidth:
Unreserved Bandwidth at priority 0: 100000000.00 kbits/sec
Unreserved Bandwidth at priority 1: 100000000.00 kbits/sec
Unreserved Bandwidth at priority 2: 100000000.00 kbits/sec
Unreserved Bandwidth at priority 3: 100000000.00 kbits/sec
Unreserved Bandwidth at priority 4: 100000000.00 kbits/sec
Unreserved Bandwidth at priority 5: 100000000.00 kbits/sec
Unreserved Bandwidth at priority 6: 100000000.00 kbits/sec
Unreserved Bandwidth at priority 7: 100000000.00 kbits/sec

TE-Default Metric: 10

Metric: 10 IP-Extended 20.1.1.0/24
Metric: 0 IP-Extended 1.1.1.1/32
Metric: 20 IP-Extended 2.2.2.2/32
Metric: 20 IP-Extended 11.1.1.0/24
Metric: 20 IP-Extended 3.3.3.3/32
Metric: 20 IP-Extended 50.1.1.0/24
Metric: 20 IP-Extended 6.6.6.6/32
Metric: 10 IP-Extended 40.1.1.0/24

PE1.02-00	0x0000000F	0x6E4D	990	0/0/0
Metric: 0	IS-Extended	PE1.00		
Metric: 0	IS-Extended	P1.00		
PE1.03-00	0x00000004	0xCDF3	1093	0/0/0
Metric: 0	IS-Extended	PE1.00		
Metric: 0	IS-Extended	P2.00		
P1.00-00	0x00000019	0xCCF2	609	0/0/0

Area Address: 49
NLPID: 0xCC
Hostname: P1
IP Address: 2.2.2.2
Router ID: 2.2.2.2
Metric: 10 IS-Extended PE2.02
IPv4 Interface Address: 11.1.1.2

```

Neighbor IP Address: 11.1.1.1
Maximum Link Bandwidth : 100000000.00 kbits/sec
Reservable Bandwidth : 100000000.00 kbits/sec
Unreserved Bandwidth:
  Unreserved Bandwidth at priority 0: 100000000.00 kbits/sec
  Unreserved Bandwidth at priority 1: 100000000.00 kbits/sec
  Unreserved Bandwidth at priority 2: 100000000.00 kbits/sec
  Unreserved Bandwidth at priority 3: 100000000.00 kbits/sec
  Unreserved Bandwidth at priority 4: 100000000.00 kbits/sec
  Unreserved Bandwidth at priority 5: 100000000.00 kbits/sec
  Unreserved Bandwidth at priority 6: 100000000.00 kbits/sec
  Unreserved Bandwidth at priority 7: 100000000.00 kbits/sec
TE-Default Metric: 10
Metric: 10          IS-Extended PE1.02
IPv4 Interface Address: 20.1.1.2
Neighbor IP Address: 20.1.1.1
Maximum Link Bandwidth : 10000000.00 kbits/sec
Reservable Bandwidth : 10000000.00 kbits/sec
Unreserved Bandwidth:
  Unreserved Bandwidth at priority 0: 10000000.00 kbits/sec
  Unreserved Bandwidth at priority 1: 10000000.00 kbits/sec
  Unreserved Bandwidth at priority 2: 10000000.00 kbits/sec
  Unreserved Bandwidth at priority 3: 10000000.00 kbits/sec
  Unreserved Bandwidth at priority 4: 10000000.00 kbits/sec
  Unreserved Bandwidth at priority 5: 10000000.00 kbits/sec
  Unreserved Bandwidth at priority 6: 10000000.00 kbits/sec
  Unreserved Bandwidth at priority 7: 10000000.00 kbits/sec
TE-Default Metric: 10
Metric: 10          IP-Extended 20.1.1.0/24
Metric: 10          IP-Extended 2.2.2.2/32
Metric: 10          IP-Extended 11.1.1.0/24
Metric: 10          IP-Extended 3.3.3.3/32
Metric: 20          IP-Extended 50.1.1.0/24
Metric: 10          IP-Extended 1.1.1.1/32
Metric: 30          IP-Extended 6.6.6.6/32
Metric: 20          IP-Extended 40.1.1.0/24
PE2.00-00          * 0x00000016 0x1BA1          619          0/0/0
Area Address: 49
NLPID: 0xCC
Hostname: PE2
IP Address: 11.1.1.1
Router ID: 3.3.3.3
Metric: 10          IS-Extended PE2.02
IPv4 Interface Address: 11.1.1.1
Neighbor IP Address: 11.1.1.1
Maximum Link Bandwidth : 100000000.00 kbits/sec
Reservable Bandwidth : 100000000.00 kbits/sec
Unreserved Bandwidth:
  Unreserved Bandwidth at priority 0: 100000000.00 kbits/sec
  Unreserved Bandwidth at priority 1: 100000000.00 kbits/sec

```

```
Unreserved Bandwidth at priority 2: 100000000.00 kbits/sec
Unreserved Bandwidth at priority 3: 100000000.00 kbits/sec
Unreserved Bandwidth at priority 4: 100000000.00 kbits/sec
Unreserved Bandwidth at priority 5: 100000000.00 kbits/sec
Unreserved Bandwidth at priority 6: 100000000.00 kbits/sec
Unreserved Bandwidth at priority 7: 100000000.00 kbits/sec
TE-Default Metric: 10
Metric: 10          IS-Extended PE2.01
IPv4 Interface Address: 50.1.1.1
Neighbor IP Address: 50.1.1.1
Maximum Link Bandwidth : 100000000.00 kbits/sec
Reservable Bandwidth : 100000000.00 kbits/sec
Unreserved Bandwidth:
  Unreserved Bandwidth at priority 0: 100000000.00 kbits/sec
  Unreserved Bandwidth at priority 1: 100000000.00 kbits/sec
  Unreserved Bandwidth at priority 2: 100000000.00 kbits/sec
  Unreserved Bandwidth at priority 3: 100000000.00 kbits/sec
  Unreserved Bandwidth at priority 4: 100000000.00 kbits/sec
  Unreserved Bandwidth at priority 5: 100000000.00 kbits/sec
  Unreserved Bandwidth at priority 6: 100000000.00 kbits/sec
  Unreserved Bandwidth at priority 7: 100000000.00 kbits/sec
TE-Default Metric: 10
Metric: 10          IP-Extended 50.1.1.0/24
Metric: 0           IP-Extended 3.3.3.3/32
Metric: 10          IP-Extended 11.1.1.0/24
Metric: 20          IP-Extended 2.2.2.2/32
Metric: 20          IP-Extended 20.1.1.0/24
Metric: 20          IP-Extended 1.1.1.1/32
Metric: 20          IP-Extended 6.6.6.6/32
Metric: 20          IP-Extended 40.1.1.0/24
PE2.01-00          * 0x0000000E  0xC9EB          893          0/0/0
  Metric: 0          IS-Extended PE2.00
  Metric: 0          IS-Extended P2.00
PE2.02-00          * 0x0000000F  0x7047          854          0/0/0
  Metric: 0          IS-Extended PE2.00
  Metric: 0          IS-Extended P1.00
P2.00-00          0x00000014  0x3E72          598          0/0/0
Area Address: 49
NLPID:           0xCC
Hostname:        P2
IP Address:      6.6.6.6
Router ID:       6.6.6.6
Metric: 10          IS-Extended PE2.01
IPv4 Interface Address: 50.1.1.2
Neighbor IP Address: 50.1.1.1
Maximum Link Bandwidth : 100000000.00 kbits/sec
Reservable Bandwidth : 100000000.00 kbits/sec
Unreserved Bandwidth:
  Unreserved Bandwidth at priority 0: 100000000.00 kbits/sec
  Unreserved Bandwidth at priority 1: 100000000.00 kbits/sec
```

```

Unreserved Bandwidth at priority 2: 100000000.00 kbits/sec
Unreserved Bandwidth at priority 3: 100000000.00 kbits/sec
Unreserved Bandwidth at priority 4: 100000000.00 kbits/sec
Unreserved Bandwidth at priority 5: 100000000.00 kbits/sec
Unreserved Bandwidth at priority 6: 100000000.00 kbits/sec
Unreserved Bandwidth at priority 7: 100000000.00 kbits/sec
TE-Default Metric: 10
Metric: 10          IS-Extended PE1.03
IPv4 Interface Address: 40.1.1.2
Neighbor IP Address: 40.1.1.1
Maximum Link Bandwidth : 100000000.00 kbits/sec
Reservable Bandwidth : 100000000.00 kbits/sec
Unreserved Bandwidth:
  Unreserved Bandwidth at priority 0: 100000000.00 kbits/sec
  Unreserved Bandwidth at priority 1: 100000000.00 kbits/sec
  Unreserved Bandwidth at priority 2: 100000000.00 kbits/sec
  Unreserved Bandwidth at priority 3: 100000000.00 kbits/sec
  Unreserved Bandwidth at priority 4: 100000000.00 kbits/sec
  Unreserved Bandwidth at priority 5: 100000000.00 kbits/sec
  Unreserved Bandwidth at priority 6: 100000000.00 kbits/sec
  Unreserved Bandwidth at priority 7: 100000000.00 kbits/sec
TE-Default Metric: 10
Metric: 10          IP-Extended 6.6.6.6/32
Metric: 10          IP-Extended 40.1.1.0/24
Metric: 10          IP-Extended 50.1.1.0/24
Metric: 10          IP-Extended 1.1.1.1/32
Metric: 30          IP-Extended 2.2.2.2/32
Metric: 10          IP-Extended 3.3.3.3/32
Metric: 20          IP-Extended 11.1.1.0/24
Metric: 20          IP-Extended 20.1.1.0/24

PE2#
PE2#show ip bgp neighbors
BGP neighbor is 1.1.1.1, remote AS 65000, local AS 65000, internal link
  BGP version 4, local router ID 3.3.3.3, remote router ID 1.1.1.1
  BGP state = Established, up for 02:34:56
  Last read 00:00:05, hold time is 90, keepalive interval is 30 seconds
  Neighbor capabilities:
    Route refresh: advertised and received (old and new)
    Address family IPv4 Unicast: advertised and received
    Address family VPNv4 Unicast: advertised and received
    Address family IPv4 Flow Specification: advertised and received
    Address family VPNv4 Flow Specification: advertised and received
  Received 392 messages, 1 notifications, 0 in queue
  Sent 408 messages, 0 notifications, 0 in queue
  Route refresh request: received 0, sent 0
  Minimum time between advertisement runs is 5 seconds
  Update source is lo

For address family: IPv4 Unicast  BGP table version 7, neighbor version 7

```

Index 1, Offset 0, Mask 0x2
AIGP is enabled
Community attribute sent to this neighbor (both)
Large Community attribute sent to this neighbor
4 accepted prefixes
4 announced prefixes

For address family: VPNv4 Unicast BGP table version 3, neighbor version 3

Index 1, Offset 0, Mask 0x2
AIGP is enabled
Community attribute sent to this neighbor (both)
Large Community attribute sent to this neighbor
4 accepted prefixes
4 announced prefixes

For address family: IPv4 Flow Specification BGP table version 18, neighbor version 18

Index 1, Offset 0, Mask 0x2
Community attribute sent to this neighbor (both)
Large Community attribute sent to this neighbor
2 accepted prefixes
3 announced prefixes

For address family: VPNv4 Flow Specification BGP table version 5, neighbor version 5

Index 1, Offset 0, Mask 0x2
Community attribute sent to this neighbor (both)
Large Community attribute sent to this neighbor
1 accepted prefixes
2 announced prefixes

Connections established 2; dropped 1
Local host: 3.3.3.3, Local port: 179
Foreign host: 1.1.1.1, Foreign port: 44219
Nexthop: 3.3.3.3
Nexthop global: ::
Nexthop local: ::
BGP connection: non shared network
Last Reset: 02:34:58, due to BGP Notification received
Notification Error Message: (Cease/Peer Unconfigured.)

BGP neighbor is 30.1.1.1, remote AS 200, local AS 65000, external link
BGP version 4, local router ID 3.3.3.3, remote router ID 5.5.5.5
BGP state = Established, up for 02:21:35
Last read 00:00:04, hold time is 90, keepalive interval is 30 seconds
Neighbor capabilities:
Route refresh: advertised and received (old and new)
Address family IPv4 Unicast: advertised and received
Address family IPv4 Flow Specification: advertised and received

Received 381 messages, 0 notifications, 0 in queue
Sent 369 messages, 2 notifications, 0 in queue
Route refresh request: received 0, sent 0
Minimum time between advertisement runs is 30 seconds

For address family: IPv4 Unicast BGP table version 7, neighbor version 7
Index 2, Offset 0, Mask 0x4
Community attribute sent to this neighbor (both)
Large Community attribute sent to this neighbor
4 accepted prefixes
0 announced prefixes

For address family: IPv4 Flow Specification BGP table version 18, neighbor version 18
Index 2, Offset 0, Mask 0x4
Community attribute sent to this neighbor (both)
Large Community attribute sent to this neighbor
2 accepted prefixes
3 announced prefixes

Connections established 2; dropped 1
Local host: 30.1.1.2, Local port: 179
Foreign host: 30.1.1.1, Foreign port: 58782
Nexthop: 30.1.1.2
Nexthop global: ::
Nexthop local: ::
BGP connection: non shared network
Last Reset: 02:21:35, due to OPEN Message Error (Notification sent)
Notification Error Message: (OPEN Message Error/Bad BGP Identifier. Reason:)

BGP neighbor is 55.1.1.2, vrf vrf100, remote AS 200, local AS 65000, external link
BGP version 4, local router ID 55.1.1.1, remote router ID 5.5.5.5
BGP state = Established, up for 02:21:35
Last read 00:00:11, hold time is 90, keepalive interval is 30 seconds
Neighbor capabilities:
Route refresh: advertised and received (old and new)
Address family IPv4 Unicast: advertised and received
Address family IPv4 Flow Specification: advertised and received
Received 364 messages, 0 notifications, 0 in queue
Sent 370 messages, 2 notifications, 0 in queue
Route refresh request: received 0, sent 0
Minimum time between advertisement runs is 30 seconds

For address family: IPv4 Unicast BGP table version 3, neighbor version 3
Index 1, Offset 0, Mask 0x2
Community attribute sent to this neighbor (standard)
Large Community attribute sent to this neighbor
4 accepted prefixes
5 announced prefixes

BGP Flowspec Support for IPv4

For address family: IPv4 Flow Specification BGP table version 1, neighbor version 1
Index 1, Offset 0, Mask 0x2

Community attribute sent to this neighbor (both)
Large Community attribute sent to this neighbor
2 accepted prefixes
1 announced prefixes

Connections established 2; dropped 1
Local host: 55.1.1.1, Local port: 179
Foreign host: 55.1.1.2, Foreign port: 41566
Nexthop: 55.1.1.1
Nexthop global: ::
Nexthop local: ::
BGP connection: non shared network
Last Reset: 02:21:35, due to OPEN Message Error (Notification sent)
Notification Error Message: (OPEN Message Error/Bad BGP Identifier. Reason:)

PE2#
PE2#
PE2#sh ip bgp ipv4 flowspec summary
BGP router identifier 3.3.3.3, local AS number 65000
BGP table version is 18
3 BGP AS-PATH entries
0 BGP community entries

Neighbor PfxRcd	V	AS	MsgRcv	MsgSen	TblVer	InQ	OutQ	Up/Down	State/
1.1.1.1 2	4	65000	394	409	18	0	0	02:35:22	
30.1.1.1 2	4	200	382	372	18	0	0	02:22:01	

Total number of neighbors 2

Total number of Established sessions 2
BGP router identifier 55.1.1.1, local AS number 65000
BGP VRF vrf100 Route Distinguisher: 100:1
BGP table version is 1
3 BGP AS-PATH entries
0 BGP community entries

Neighbor PfxRcd	V	AS	MsgRcv	MsgSen	TblVer	InQ	OutQ	Up/Down	State/
55.1.1.2 2	4	200	365	373	1	0	0	02:22:01	

Total number of neighbors 1

Total number of Established sessions 1
PE2#

```

PE2#
PE2#show ip bgp ipv4 flowspec
BGP table version is 18, local router ID is 3.3.3.3
Status codes: s suppressed, d damped, h history, a add-path, * valid, > best, i -
internal,
                l - labeled, S Stale
Origin codes: i - IGP, e - EGP, ? - incomplete

```

Network	Next Hop	Metric	LocPrf	Weight	Path
*>i flowspec/136	1.1.1.1	0	100	0	100 i
*> flowspec/200	30.1.1.1	0	100	0	200 i
*> flowspec/152	0.0.0.0	0	100	32768	i
*>i flowspec/48	1.1.1.1	0	100	0	i
*> flowspec/152	30.1.1.1	0	100	0	200 i

Total number of prefixes 5

```

PE2#
PE2#show ip bgp ipv4 flowspec detail
BGP table version is 18, local router ID is 3.3.3.3
Status codes: s suppressed, d damped, h history, a add-path, * valid, > best, i -
internal,
                l - labeled, S Stale
Origin codes: i - IGP, e - EGP, ? - incomplete

```

Network	Next Hop	Metric	LocPrf	Weight	Path
*>i flowspec/136	1.1.1.1	0	100	0	100 i

FlowSpec:

```

destination ip address: 10.1.1.0/24
source ip address: 10.1.1.0/24
TCP/UDP source port:
  e:0 a:0 len:1 lt:0 gt:1 eq:1 data:22
  e:1 a:1 len:1 lt:1 gt:0 eq:1 data:122

```

FlowSpec Actions:

```

traffic_rate: 21000 bps

```

*> flowspec/200	30.1.1.1	0	100	0	200 i
-----------------	----------	---	-----	---	-------

FlowSpec:

```

destination ip address: 30.1.1.0/24
source ip address: 30.1.1.0/24
TCP/UDP source port:
  e:0 a:0 len:1 lt:0 gt:1 eq:1 data:500
  e:1 a:1 len:1 lt:1 gt:0 eq:1 data:600
TCP flags:
  e:0 a:0 len:0 not:0 m:1 data:0x21
  e:1 a:1 len:0 not:1 m:0 data:0x1e
DSCP:
  e:1 a:0 len:0 lt:0 gt:0 eq:1 data:0x21

```

BGP Flowspec Support for IPv4

FlowSpec Actions:

traffic_rate: 500000 bps
traffic marking DSCP: 1e

```
*>  flowspec/152      0.0.0.0                0          100        32768  i
```

FlowSpec:

destination ip address: 1.1.1.1/32
source ip address: 3.3.3.3/32
TCP/UDP destination port:
e:0 a:0 len:1 lt:0 gt:1 eq:1 data:300
e:1 a:1 len:1 lt:1 gt:0 eq:1 data:399

FlowSpec Actions:

traffic_rate: 1111111 bps

```
*>i  flowspec/48      1.1.1.1                0          100         0  i
```

FlowSpec:

destination ip address: 4.4.4.4/32

FlowSpec Actions:

rt_redirect: as_type: as 100:10 vrf_id:0 fib_id:0

```
*>  flowspec/152      30.1.1.1               0          100         0  200 i
```

FlowSpec:

destination ip address: 5.5.5.5/32
source ip address: 5.5.5.5/32
TCP/UDP destination port:
e:0 a:0 len:1 lt:0 gt:1 eq:1 data:1300
e:1 a:1 len:1 lt:1 gt:0 eq:1 data:1400

FlowSpec Actions:

traffic_rate: 100000 bps

Total number of prefixes 5

PE2#

PE2#

PE2#sh ip bgp ipv4 flowspec vrf all

BGP table version is 1, local router ID is 55.1.1.1

Status codes: s suppressed, d damped, h history, a add-path, * valid, > best, i - internal,

l - labeled, S Stale

Origin codes: i - IGP, e - EGP, ? - incomplete

Network	Next Hop	Metric	LocPrf	Weight	Path
---------	----------	--------	--------	--------	------

BGP Route Table for VRF vrf100

```
*>i  flowspec/136      1.1.1.1                0          100         0  100 i
```

```
*> flowspec/200 55.1.1.2 0 100 0 200 i
*> flowspec/152 55.1.1.2 0 100 0 200 i
```

Total number of prefixes 3

```
*>i flowspec/136 1.1.1.1 0 100 0 100 i
*> flowspec/200 30.1.1.1 0 100 0 200 i
*> flowspec/152 0.0.0.0 0 100 32768 i
*>i flowspec/48 1.1.1.1 0 100 0 i
*> flowspec/152 30.1.1.1 0 100 0 200 i
```

Total number of prefixes 5

PE2#

PE2#

PE2#sh ip bgp ipv4 flowspec vrf all detail

BGP table version is 1, local router ID is 55.1.1.1

Status codes: s suppressed, d damped, h history, a add-path, * valid, > best, i - internal,

l - labeled, S Stale

Origin codes: i - IGP, e - EGP, ? - incomplete

Network	Next Hop	Metric	LocPrf	Weight	Path
---------	----------	--------	--------	--------	------

BGP Route Table for VRF vrf100

```
*>i flowspec/136 1.1.1.1 0 100 0 100 i
```

FlowSpec:

destination ip address: 10.1.1.0/24

source ip address: 10.1.1.0/24

TCP/UDP source port:

e:0 a:0 len:1 lt:0 gt:1 eq:1 data:22

e:1 a:1 len:1 lt:1 gt:0 eq:1 data:122

FlowSpec Actions:

traffic_rate: 21000 bps

```
*> flowspec/200 55.1.1.2 0 100 0 200 i
```

FlowSpec:

destination ip address: 30.1.1.0/24

source ip address: 30.1.1.0/24

TCP/UDP source port:

e:0 a:0 len:1 lt:0 gt:1 eq:1 data:500

e:1 a:1 len:1 lt:1 gt:0 eq:1 data:600

TCP flags:

e:0 a:0 len:0 not:0 m:1 data:0x21

e:1 a:1 len:0 not:1 m:0 data:0x1e

DSCP:

e:1 a:0 len:0 lt:0 gt:0 eq:1 data:0x21

FlowSpec Actions:

traffic_rate: 500000 bps

BGP Flowspec Support for IPv4

traffic marking DSCP: 1e

```
*> flowspec/152      55.1.1.2          0          100         0   200 i
```

FlowSpec:

destination ip address: 5.5.5.5/32

source ip address: 5.5.5.5/32

TCP/UDP destination port:

e:0 a:0 len:1 lt:0 gt:1 eq:1 data:1300

e:1 a:1 len:1 lt:1 gt:0 eq:1 data:1400

FlowSpec Actions:

traffic_rate: 100000 bps

Total number of prefixes 3

```
*>i flowspec/136     1.1.1.1          0          100         0   100 i
```

FlowSpec:

destination ip address: 10.1.1.0/24

source ip address: 10.1.1.0/24

TCP/UDP source port:

e:0 a:0 len:1 lt:0 gt:1 eq:1 data:22

e:1 a:1 len:1 lt:1 gt:0 eq:1 data:122

FlowSpec Actions:

traffic_rate: 21000 bps

```
*> flowspec/200     30.1.1.1          0          100         0   200 i
```

FlowSpec:

destination ip address: 30.1.1.0/24

source ip address: 30.1.1.0/24

TCP/UDP source port:

e:0 a:0 len:1 lt:0 gt:1 eq:1 data:500

e:1 a:1 len:1 lt:1 gt:0 eq:1 data:600

TCP flags:

e:0 a:0 len:0 not:0 m:1 data:0x21

e:1 a:1 len:0 not:1 m:0 data:0x1e

DSCP:

e:1 a:0 len:0 lt:0 gt:0 eq:1 data:0x21

FlowSpec Actions:

traffic_rate: 500000 bps

traffic marking DSCP: 1e

```
*> flowspec/152     0.0.0.0          0          100        32768 i
```

FlowSpec:

destination ip address: 1.1.1.1/32

```

source ip address: 3.3.3.3/32
TCP/UDP destination port:
  e:0 a:0 len:1 lt:0 gt:1 eq:1 data:300
  e:1 a:1 len:1 lt:1 gt:0 eq:1 data:399

```

```

FlowSpec Actions:
  traffic_rate: 1111111 bps

```

```
*>i flowspec/48      1.1.1.1          0          100         0    i
```

```

FlowSpec:
  destination ip address: 4.4.4.4/32

```

```

FlowSpec Actions:
  rt_redirect: as_type: as 100:10 vrf_id:0 fib_id:0

```

```
*> flowspec/152     30.1.1.1         0          100         0   200 i
```

```

FlowSpec:
  destination ip address: 5.5.5.5/32
  source ip address: 5.5.5.5/32
  TCP/UDP destination port:
    e:0 a:0 len:1 lt:0 gt:1 eq:1 data:1300
    e:1 a:1 len:1 lt:1 gt:0 eq:1 data:1400

```

```

FlowSpec Actions:
  traffic_rate: 100000 bps

```

Total number of prefixes 5

PE2#

PE2#sh ip bgp vpnv4 all

Status codes: s suppressed, d damped, h history, a add-path, * valid, > best, i - internal, l - labeled

S Stale

Origin codes: i - IGP, e - EGP, ? - incomplete

Network	Next Hop	Metric	LocPrf	Weight	Path
Route Distinguisher: 100:1 (Default for VRF vrf100)					
*>i 4.4.4.4/32	1.1.1.1	0	100	0	100 ?
*> l 5.5.5.5/32	55.1.1.2	0	100	0	200 ?
*>i 10.1.1.0/24	1.1.1.1	0	100	0	100 ?
*> l 30.1.1.0/24	55.1.1.2	0	100	0	200 ?
*> l 55.1.1.0/24	0.0.0.0	0	100	32768	?
*	55.1.1.2	0	100	0	200 ?
*>i 66.1.1.0/24	1.1.1.1	0	100	0	?
*>i 100.1.1.0/24	1.1.1.1	0	100	0	100 ?
*> l 200.1.1.0	55.1.1.2	0	100	0	200 ?

Announced routes count = 5

Accepted routes count = 4

Route Distinguisher: 100:1

BGP Flowspec Support for IPv4

```
*>i 4.4.4.4/32      1.1.1.1      0      100      0 100 ?
*>i 10.1.1.0/24     1.1.1.1      0      100      0 100 ?
*>i 66.1.1.0/24     1.1.1.1      0      100      0  ?
*>i 100.1.1.0/24    1.1.1.1      0      100      0 100 ?
```

Announced routes count = 0

Accepted routes count = 4

PE2#

PE2#sh ip bgp vpnv4 flowspec summary

BGP router identifier 3.3.3.3, local AS number 65000

BGP table version is 5

3 BGP AS-PATH entries

0 BGP community entries

Neighbor PfxRcd	V	AS	MsgRcv	MsgSen	TblVer	InQ	OutQ	Up/Down	State/
1.1.1.1 1	4	65000	397	413	5	0	0	02:36:40	

Total number of neighbors 1

Total number of Established sessions 1

PE2#

PE2#

PE2#sh ip bgp vpnv4 flowspec vrf vrf100

Status codes: s suppressed, d damped, h history, a add-path, * valid, > best, i - internal, l - labeled

S Stale

Origin codes: i - IGP, e - EGP, ? - incomplete

Network	Next Hop	Metric	LocPrf	Weight	Path
Route Distinguisher: 100:1 (Default for VRF vrf100)					
*>i flowspec/136	1.1.1.1	0	100	0 100	i
*> flowspec/200	55.1.1.2	0	100	0 200	i
*> flowspec/152	55.1.1.2	0	100	0 200	i

Announced routes count = 2

Accepted routes count = 1

PE2#

PE2#sh ip bgp vpnv4 flowspec vrf vrf100 detail

Status codes: s suppressed, d damped, h history, a add-path, * valid, > best, i - internal, l - labeled

S Stale

Origin codes: i - IGP, e - EGP, ? - incomplete

Network	Next Hop	Metric	LocPrf	Weight	Path
Route Distinguisher: 100:1 (Default for VRF vrf100)					
*>i flowspec/136	1.1.1.1	0	100	0 100	i

FlowSpec:

destination ip address: 10.1.1.0/24

source ip address: 10.1.1.0/24

TCP/UDP source port:

```

e:0 a:0 len:1 lt:0 gt:1 eq:1 data:22
e:1 a:1 len:1 lt:1 gt:0 eq:1 data:122

```

FlowSpec Actions:

```
traffic_rate: 21000 bps
```

```
*> flowspec/200      55.1.1.2          0          100         0   200 i
```

FlowSpec:

```

destination ip address: 30.1.1.0/24
source ip address: 30.1.1.0/24
TCP/UDP source port:
  e:0 a:0 len:1 lt:0 gt:1 eq:1 data:500
  e:1 a:1 len:1 lt:1 gt:0 eq:1 data:600
TCP flags:
  e:0 a:0 len:0 not:0 m:1 data:0x21
  e:1 a:1 len:0 not:1 m:0 data:0x1e
DSCP:
  e:1 a:0 len:0 lt:0 gt:0 eq:1 data:0x21

```

FlowSpec Actions:

```

traffic_rate: 500000 bps
traffic marking DSCP: 1e

```

```
*> flowspec/152      55.1.1.2          0          100         0   200 i
```

FlowSpec:

```

destination ip address: 5.5.5.5/32
source ip address: 5.5.5.5/32
TCP/UDP destination port:
  e:0 a:0 len:1 lt:0 gt:1 eq:1 data:1300
  e:1 a:1 len:1 lt:1 gt:0 eq:1 data:1400

```

FlowSpec Actions:

```
traffic_rate: 100000 bps
```

```
Announced routes count = 2
```

```
Accepted routes count = 1
```

```
PE2#
```

CE2

```
CE2#show ip bgp
```

```
BGP table version is 2, local router ID is 5.5.5.5
```

```
Status codes: s suppressed, d damped, h history, a add-path, * valid, > best, i - internal,
```

```
l - labeled, S Stale
```

```
Origin codes: i - IGP, e - EGP, ? - incomplete
```

```

Network          Next Hop          Metric    LocPrf    Weight Path
*> 4.4.4.4/32     55.1.1.1          0         100       0   65000 100 ?

```

BGP Flowspec Support for IPv4

```
*> 5.5.5.5/32      0.0.0.0      0      100      32768  ?
*> 10.1.1.0/24     55.1.1.1     0      100      0  65000 100 ?
*> 30.1.1.0/24     0.0.0.0      0      100      32768  ?
*> 55.1.1.0/24     0.0.0.0      0      100      32768  ?
*      55.1.1.1     0      100      0  65000 ?
*> 66.1.1.0/24     55.1.1.1     0      100      0  65000 ?
*> 100.1.1.0/24    55.1.1.1     0      100      0  65000 100 ?
*> 200.1.1.0       0.0.0.0      0      100      32768  ?
```

Total number of prefixes 8

CE2#

CE2#

CE2#

CE2#sh ip bgp neighbors

```
BGP neighbor is 30.1.1.2, remote AS 65000, local AS 200, external link
  BGP version 4, local router ID 5.5.5.5, remote router ID 3.3.3.3
  BGP state = Established, up for 02:25:18
  Last read 00:00:15, hold time is 90, keepalive interval is 30 seconds
  Neighbor capabilities:
    Route refresh: advertised and received (old and new)
    Address family IPv4 Unicast: advertised and received
    Address family IPv4 Flow Specification: advertised and received
  Received 355 messages, 1 notifications, 0 in queue
  Sent 365 messages, 0 notifications, 0 in queue
  Route refresh request: received 0, sent 0
  Minimum time between advertisement runs is 30 seconds
```

For address family: IPv4 Unicast BGP table version 2, neighbor version 2

```
  Index 1, Offset 0, Mask 0x2
  Community attribute sent to this neighbor (both)
  Large Community attribute sent to this neighbor
  0 accepted prefixes
  8 announced prefixes
```

For address family: IPv4 Flow Specification BGP table version 7, neighbor version 7

```
  Index 1, Offset 0, Mask 0x2
  Community attribute sent to this neighbor (both)
  Large Community attribute sent to this neighbor
  3 accepted prefixes
  3 announced prefixes
```

```
Connections established 1; dropped 0
Local host: 30.1.1.1, Local port: 58782
Foreign host: 30.1.1.2, Foreign port: 179
Nexthop: 30.1.1.1
Nexthop global: ::
Nexthop local: ::
BGP connection: non shared network
Last Reset: 02:25:23, due to BGP Notification received
```

Notification Error Message: (OPEN Message Error/Bad BGP Identifier. Reason:)

BGP neighbor is 55.1.1.1, remote AS 65000, local AS 200, external link
 BGP version 4, local router ID 5.5.5.5, remote router ID 55.1.1.1
 BGP state = Established, up for 02:25:18
 Last read 00:00:03, hold time is 90, keepalive interval is 30 seconds
 Neighbor capabilities:
 Route refresh: advertised and received (old and new)
 Address family IPv4 Unicast: advertised and received
 Address family IPv4 Flow Specification: advertised and received
 Received 354 messages, 1 notifications, 0 in queue
 Sent 351 messages, 0 notifications, 0 in queue
 Route refresh request: received 0, sent 0
 Minimum time between advertisement runs is 30 seconds

For address family: IPv4 Unicast BGP table version 2, neighbor version 2
 Index 2, Offset 0, Mask 0x4
 Community attribute sent to this neighbor (both)
 Large Community attribute sent to this neighbor
 5 accepted prefixes
 4 announced prefixes

For address family: IPv4 Flow Specification BGP table version 7, neighbor version 7
 Index 2, Offset 0, Mask 0x4
 Community attribute sent to this neighbor (both)
 Large Community attribute sent to this neighbor
 1 accepted prefixes
 2 announced prefixes

Connections established 1; dropped 0
 Local host: 55.1.1.2, Local port: 41566
 Foreign host: 55.1.1.1, Foreign port: 179
 Nexthop: 55.1.1.2
 Nexthop global: ::
 Nexthop local: ::
 BGP connection: non shared network
 Last Reset: 02:25:23, due to BGP Notification received
 Notification Error Message: (OPEN Message Error/Bad BGP Identifier. Reason:)

CE2#
 CE2#
 CE2#sh ip bgp ipv4 flowspec summary
 BGP router identifier 5.5.5.5, local AS number 200
 BGP table version is 7
 3 BGP AS-PATH entries
 0 BGP community entries

Neighbor	V	AS	MsgRcv	MsgSen	TblVer	InQ	OutQ	Up/Down	State/
PfxRcd									

BGP Flowspec Support for IPv4

```
30.1.1.2          4 65000 356          365          7          0          0 02:25:26
3
55.1.1.1          4 65000 355          352          7          0          0 02:25:26
1
```

Total number of neighbors 2

Total number of Established sessions 2

CE2#sh ip bgp ipv4 flowspec

BGP table version is 7, local router ID is 5.5.5.5

Status codes: s suppressed, d damped, h history, a add-path, * valid, > best, i - internal,

l - labeled, S Stale

Origin codes: i - IGP, e - EGP, ? - incomplete

	Network	Next Hop	Metric	LocPrf	Weight	Path
*>	flowspec/136	55.1.1.1	0	100	0 65000	100 i
*		30.1.1.2	0	100	0 65000	100 i
*>	flowspec/200	0.0.0.0	0	100	32768	i
*	flowspec/152	30.1.1.2	0	100	0 65000	i
*	flowspec/48	30.1.1.2	0	100	0 65000	i
*>	flowspec/152	0.0.0.0	0	100	32768	i

Total number of prefixes 5

CE2#

CE2#sh ip bgp ipv4 flowspec detail

BGP table version is 7, local router ID is 5.5.5.5

Status codes: s suppressed, d damped, h history, a add-path, * valid, > best, i - internal,

l - labeled, S Stale

Origin codes: i - IGP, e - EGP, ? - incomplete

	Network	Next Hop	Metric	LocPrf	Weight	Path
*>	flowspec/136	55.1.1.1	0	100	0 65000	100 i

FlowSpec:

destination ip address: 10.1.1.0/24

source ip address: 10.1.1.0/24

TCP/UDP source port:

e:0 a:0 len:1 lt:0 gt:1 eq:1 data:22

e:1 a:1 len:1 lt:1 gt:0 eq:1 data:122

FlowSpec Actions:

traffic_rate: 21000 bps

*		30.1.1.2	0	100	0 65000	100 i
---	--	----------	---	-----	---------	-------

FlowSpec Actions:

traffic_rate: 21000 bps

*>	flowspec/200	0.0.0.0	0	100	32768	i
----	--------------	---------	---	-----	-------	---

FlowSpec:

```

destination ip address: 30.1.1.0/24
source ip address: 30.1.1.0/24
TCP/UDP source port:
  e:0 a:0 len:1 lt:0 gt:1 eq:1 data:500
  e:1 a:1 len:1 lt:1 gt:0 eq:1 data:600
TCP flags:
  e:0 a:0 len:0 not:0 m:1 data:0x21
  e:1 a:1 len:0 not:1 m:0 data:0x1e
DSCP:
  e:1 a:0 len:0 lt:0 gt:0 eq:1 data:0x21

```

FlowSpec Actions:

```

traffic_rate: 500000 bps
traffic marking DSCP: 1e

```

```
*   flowspec/152      30.1.1.2          0          100         0   65000 i
```

FlowSpec:

```

destination ip address: 1.1.1.1/32
source ip address: 3.3.3.3/32
TCP/UDP destination port:
  e:0 a:0 len:1 lt:0 gt:1 eq:1 data:300
  e:1 a:1 len:1 lt:1 gt:0 eq:1 data:399

```

FlowSpec Actions:

```

traffic_rate: 1111111 bps

```

```
*   flowspec/48      30.1.1.2          0          100         0   65000 i
```

FlowSpec:

```

destination ip address: 4.4.4.4/32

```

FlowSpec Actions:

```

rt_redirect: as_type: as 100:10 vrf_id:0 fib_id:0

```

```
*>  flowspec/152      0.0.0.0          0          100        32768 i
```

FlowSpec:

```

destination ip address: 5.5.5.5/32
source ip address: 5.5.5.5/32
TCP/UDP destination port:
  e:0 a:0 len:1 lt:0 gt:1 eq:1 data:1300
  e:1 a:1 len:1 lt:1 gt:0 eq:1 data:1400

```

FlowSpec Actions:

```

traffic_rate: 100000 bps

```

Total number of prefixes 5

BGP Flowspec Support for IPv4

```
CE2#
CE2#
CE2#sh ip bgp ipv4 flowspec vrf all
BGP table version is 7, local router ID is 5.5.5.5
Status codes: s suppressed, d damped, h history, a add-path, * valid, > best, i -
internal,
                l - labeled, S Stale
Origin codes: i - IGP, e - EGP, ? - incomplete
```

	Network	Next Hop	Metric	LocPrf	Weight	Path
*>	flowspec/136	55.1.1.1	0	100	0	65000 100 i
*		30.1.1.2	0	100	0	65000 100 i
*>	flowspec/200	0.0.0.0	0	100	32768	i
*	flowspec/152	30.1.1.2	0	100	0	65000 i
*	flowspec/48	30.1.1.2	0	100	0	65000 i
*>	flowspec/152	0.0.0.0	0	100	32768	i

Total number of prefixes 5

```
CE2#
CE2#
CE2#sh ip bgp ipv4 flowspec vrf all detail
BGP table version is 7, local router ID is 5.5.5.5
Status codes: s suppressed, d damped, h history, a add-path, * valid, > best, i -
internal,
                l - labeled, S Stale
Origin codes: i - IGP, e - EGP, ? - incomplete
```

	Network	Next Hop	Metric	LocPrf	Weight	Path
*>	flowspec/136	55.1.1.1	0	100	0	65000 100 i

FlowSpec:

```
destination ip address: 10.1.1.0/24
source ip address: 10.1.1.0/24
TCP/UDP source port:
  e:0 a:0 len:1 lt:0 gt:1 eq:1 data:22
  e:1 a:1 len:1 lt:1 gt:0 eq:1 data:122
```

FlowSpec Actions:

```
traffic_rate: 21000 bps
```

*		30.1.1.2	0	100	0	65000 100 i
---	--	----------	---	-----	---	-------------

FlowSpec Actions:

```
traffic_rate: 21000 bps
```

*>	flowspec/200	0.0.0.0	0	100	32768	i
----	--------------	---------	---	-----	-------	---

FlowSpec:

```
destination ip address: 30.1.1.0/24
source ip address: 30.1.1.0/24
TCP/UDP source port:
  e:0 a:0 len:1 lt:0 gt:1 eq:1 data:500
```

```

    e:1 a:1 len:1 lt:1 gt:0 eq:1 data:600
TCP flags:
    e:0 a:0 len:0 not:0 m:1 data:0x21
    e:1 a:1 len:0 not:1 m:0 data:0x1e
DSCP:
    e:1 a:0 len:0 lt:0 gt:0 eq:1 data:0x21

```

```

FlowSpec Actions:
    traffic_rate: 500000 bps
    traffic marking DSCP: 1e

```

```
*    flowspec/152      30.1.1.2          0          100         0    65000 i
```

```

FlowSpec:
    destination ip address: 1.1.1.1/32
    source ip address: 3.3.3.3/32
    TCP/UDP destination port:
        e:0 a:0 len:1 lt:0 gt:1 eq:1 data:300
        e:1 a:1 len:1 lt:1 gt:0 eq:1 data:399

```

```

FlowSpec Actions:
    traffic_rate: 1111111 bps

```

```
*    flowspec/48      30.1.1.2          0          100         0    65000 i
```

```

FlowSpec:
    destination ip address: 4.4.4.4/32

```

```

FlowSpec Actions:
    rt_redirect: as_type: as 100:10 vrf_id:0 fib_id:0

```

```
*>  flowspec/152      0.0.0.0           0          100        32768 i
```

```

FlowSpec:
    destination ip address: 5.5.5.5/32
    source ip address: 5.5.5.5/32
    TCP/UDP destination port:
        e:0 a:0 len:1 lt:0 gt:1 eq:1 data:1300
        e:1 a:1 len:1 lt:1 gt:0 eq:1 data:1400

```

```

FlowSpec Actions:
    traffic_rate: 100000 bps

```

```

Total number of prefixes 5
CE2#

```

With RR

Topology

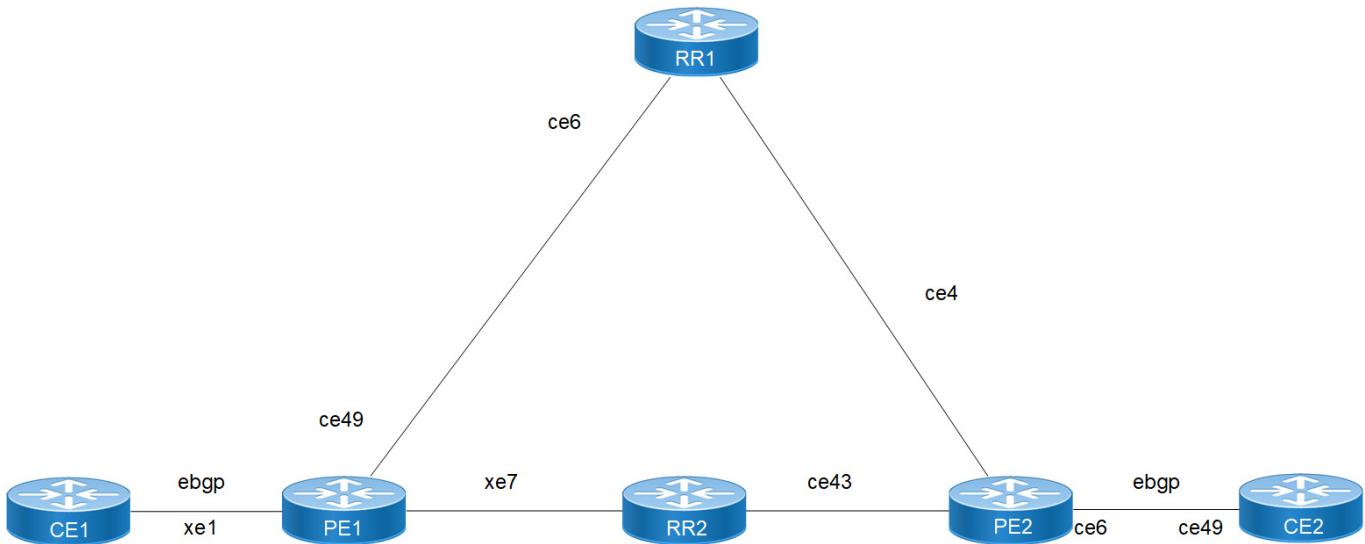

Figure 33-156: BGP Flowsec support for IPv4 with RR

Configuration

CE1

CE1#configure terminal	Enter configure mode.
CE1(config)# class-map type traffic match-all ocnos	Configure class map with class name
CE1(config-cmap-tr)#match destination-address ipv4 5.5.5.5/32	Configure match with destination ip address
CE1(config-cmap-tr)#match source-address ipv4 4.4.4.4/32	Enable match with source ip address
CE1(config-cmap-tr)#match protocol 12	Enable match with protocol
CE1(config-cmap-tr)#match port 333-444	Enable match with port
CE1(config-cmap-tr)#exit	Exit from class map traffic
CE1(config)#commit	Commits the configuration
CE1(config)#class-map type traffic match-all ocnos2	Configure class map with class name
CE1(config-cmap-tr)# match destination-address ipv4 10.1.1.0/24	Configure match with destination ip address
CE1(config-cmap-tr)# match source-address ipv4 10.1.1.0/24	Enable match with source ip address
CE1(config-cmap-tr)# match protocol 44	Enable match with protocol

CE1(config-cmap-tr)# match destination-port 44-144	Enable match with destination port
CE1(config-cmap-tr)# match source-port 22-122	Enter match with source port
CE1(config-cmap-tr)#exit	Exit from class map traffic
CE1(config)#commit	Commits the configuration
CE1(config)#policy-map type pbr CE1	Enable policy map type pbr policy name
CE1(config-pmap-pbr)# class type traffic ocnos2	Enable class type traffic class name
CE1(config-pmap-pbr-c)# police rate 21000 bps	Set the policy rate
CE1(config-pmap-pbr-c)#exit	Exit from class
CE1(config-pmap-pbr)#exit	Exit from policy map
CE1(config)#policy-map type pbr PE1	Enable policy map type pbr policy name
CE1(config-pmap-pbr)# class type traffic ocnos	Enable class type traffic class name
CE1(config-pmap-pbr-c)# police rate 4444444 bps	Set the policy rate
CE1(config-cmap-tr)#exit	Exit from class map traffic
CE1(config)#commit	Commits the configuration
CE1(config)#flowspec	Configure flowspec
CE1(config-flowspec)#address-family ipv4	Enter address family ipv4 mode
CE1(config-flowspec-af)#service-policy type pbr PE1	Enable service policy type pbr with policy name
CE1(config-flowspec-af)#service-policy type pbr CE1	Enable service policy type pbr with policy name
CE1(config-flowspec-af)#exit	Exit from address family
CE1(config-flowspec)#exit	Exit from flowspec mode
CE1(config)#commit	Commits the configuration
CE1(config)#interface lo	Enter the loopback onterface mode
CE1(config-if)# ip address 4.4.4.4/32 secondary	Assign the ip add as secondary
CE1(config-if)# ip router isis 1	Enable the router isis instance
CE1(config-if)#exit	Exit from interface mode
CE1(config)#commit	Commits the configuration
CE1(config)#interface xe1	Enter the interface mode
CE1(config-if)#ip address 10.1.1.1/24	Configure ip address
CE1(config)#interface xe1.10	Configure subinterface
CE1(config-if)# encapsulation dot1q 10	Enable encapsulate dot1q vlan id
CE1(config-if)# ip address 66.1.1.1/24	Configure ip address
CE1(config-if)#exit	Exit from interface mode
CE1(config)#commit	Commits the configuration
CE1(config)#router bgp 100	Configure bgp intstance

BGP Flowspec Support for IPv4

CE1(config-router)# neighbor 10.1.1.2 remote-as 65000	Enable neighbour ip address with remote-as 65000
CE1(config-router)# neighbor 66.1.1.2 remote-as 65000	Enable neighbour ip address with remote-as 65000
CE1(config-router)# address-family ipv4 unicast	Enter the address family ipv4 unicast
CE1(config-router-af)# redistribute connected	Enter redistribute connected
CE1(config-router-af)# neighbor 10.1.1.2 activate	Activate the neighbour
CE1(config-router-af)# neighbor 66.1.1.2 activate	Activate the neighbour
CE1(config-router-af)# exit-address-family	Exit from address family mode
CE1(config-router)# address-family ipv4 flowspec	Enter the address family ipv4 flowspec
CE1(config-router-af)# neighbor 10.1.1.2 activate	Activate the neighbour
CE1(config-router-af)# neighbor 66.1.1.2 activate	Activate the neighbour
CE1(config-router-af)# exit-address-family	Exit from address family mode
CE1(config-router)#exit	Exit from router mode
CE1(config)#commit	Commits the configuration

PE1

PE1#configure terminal	Enter configure mode.
PE1(config)#ip vrf vrf100	Enter vrf vrf name
PE1(config-vrf)# rd 100:1	Enter rd value
PE1(config-vrf)# route-target both 100:1	Enter router targeted as both
PE1(config-vrf)#exit	Exit from vrf mode
PE1(config)#commit	Commits the configuration
PE1(config)#ip vrf vrf101	Enter vrf vrf name
PE1(config-vrf)# rd 101:1	Enter rd value
PE1(config-vrf)# route-target both 101:1	Enter router targeted as both
PE1(config-vrf)#exit	Exit from vrf mode
PE1(config)#commit	Commits the configuration
PE1(config)#qos enable	Enable qos
PE1(config)#qos statistics	Enable qos statistics
PE1-7026(config)#class-map type traffic match-all class1	Configure class map with class name
PE1-7026(config-cmap-tr)# match destination-address ipv4 3.3.3.3/32	Configure match with destination ip address
PE1-7026(config-cmap-tr)# match source-address ipv4 1.1.1.1/32	Enable match with source ip address
PE1-7026(config-cmap-tr)# match protocol 78	Enable match with protocol
PE1-7026(config-cmap-tr)# match port 101-201	Enable match with port range

PE1-7026(config-cmap-tr)# match destination-port 400-499	Enable match with destination-port range
PE1-7026(config-cmap-tr)# match source-port 330-399	Enable match with source-port range
PE1-7026(config-cmap-tr)# match ipv4 icmp-code 10	Enable match with icmp code
PE1-7026(config-cmap-tr)# match packet-length 22-222	Enable match with packet length range
PE1-7026(config-cmap-tr)# match dscp 10	Enable match with dscp
PE1-7026(config-cmap-tr)#exit	Exit from class map traffic
PE1-7026(config)#commit	Commits the configuration
PE1-7026(config)#policy-map type pbr pol11	Configure policy map type pbr with policy name
PE1-7026(config-pmap-pbr)# class type traffic class1	Enable class type traffic with class map name
PE1-7026(config-pmap-pbr-c)# police rate 1000011 bps	Enable policy rate
PE1-7026(config-pmap-pbr-c)# set dscp 0e	Set the dscp value
PE1-7026(config-pmap-pbr-c)#exit	Exit from policy map traffic
PE1-7026(config-pmap-pbr)#exit	Exit from policy map
PE1-7026(config)#commit	Commits the configuration
PE1(config)#flowspec	Configure flowspec
PE1(config-flowspec)# address-family ipv4	Enter address-family mode with ipv4
PE1(config-flowspec-af)# service-policy type pbr pol11	Enable service policy type pbr with policy name
PE1(config-flowspec-af)#exit	Exit from address family mode
PE1(config-flowspec)#exit	Exit from flowspec mode
PE1(config)#commit	Commits the configuration
PE1(config)#router ldp	Enter router ldp mode
PE1(config-router)# targeted-peer ipv4 3.3.3.3	Enable targeted peer ipv4 address
PE1(config-router-targeted-peer)# exit-targeted-peer-mode	Exit from targeted peer mode
PE1(config-router)#exit	Exit from router ldp
PE1(config)#commit	Commits the configuration
PE1(config)#interface lo	Enter interface mode
PE1(config-if)# ip address 1.1.1.1/32 secondary	Assign the ip address secondary
PE1(config-if)# ip router isis 1	Enable router isis instance
PE1(config-if)#exit	Exit from interface mode
PE1(config)#commit	Commits the configuration
PE1(config)#interface ce49	Enter interface mode
PE1(config-if)# ip address 40.1.1.1/24	Assign the ip add
PE1(config-if)# label-switching	Enable label switching
PE1(config-if)# ip router isis 1	Enter router isis instance

BGP Flowspec Support for IPv4

PE1(config-if)# enable-ldp ipv4	Enable ldp ipv4
PE1(config-if)#exit	Exit from interface mode
PE1(config)#commit	Commits the configuration
PE1(config)#interface xe1	Enter the interface mode
PE1(config-if)# ip address 10.1.1.2/24	Assign the ip add
PE1(config-if)#exit	Exit from interface mode
PE1(config)#commit	Commits the configuration
PE1(config)#interface xe1.10	Enter the sub-interface mode
PE1(config-if)# encapsulation dot1q 10	Enable encapsulate dot1q with vlan id
PE1(config-if)# ip vrf forwarding vrf100	Enable ip vrf forwarding vrf name
PE1(config-if)# ip address 66.1.1.2/24	Assign the ip add
PE1(config-if)#exit	Exit from interface mode
PE1(config)#commit	Commits the configuration
PE1(config)#interface xe7	Enter interface mode
PE1(config-if)# ip address 20.1.1.1/24	Assign the ip add
PE1(config-if)# label-switching	Enable label switching
PE1(config-if)# ip router isis 1	Enter router isis instance
PE1(config-if)# enable-ldp ipv4	Enable ldp ipv4
PE1(config-if)#exit	Exit from interface mode
PE1(config)#commit	Commits the configuration
PE1(config)#router isis 1	Configure isis instance
PE1(config-router)# is-type level-1-2	Configure is-type-level-1-2
PE1(config-router)# metric-style wide	Configure metric style wide
PE1(config-router)# mpls traffic-eng router-id 1.1.1.1	Configure router id
PE1(config-router)# mpls traffic-eng level-1	Configure traffic engg level-1
PE1(config-router)# mpls traffic-eng level-2	Configure traffic engg level-2
PE1(config-router)# dynamic-hostname	Configure hostname
PE1(config-router)# bfd all-interfaces	Enable bfd all interfaces
PE1(config-router)# net 49.0000.0000.0001.00	Configure network id
PE1 (config-router)# passive-interface lo	Configure passive interface as loopback
PE1(config-router)#exit	Exit from isis instance mode
PE1(config)#commit	Commits the configuration
PE1(config)#router bgp 65000	Configure bgp instance
PE1(config-router)# neighbor 6.6.6.6 remote-as 65000	Enable neighbour address with remote-as 65000
PE1(config-router)# neighbor 10.1.1.1 remote-as 100	Enable neighbour address with remote-as 100
PE1(config-router)# neighbor 20.1.1.2 remote-as 65000	Enable neighbour address with remote-as 65000
PE1(config-router)# neighbor 6.6.6.6 update-source lo	Enable neighbour address with update loopback

PE1(config-router)# address-family ipv4 unicast	Enter address family ipv4 mode
PE1(config-router-af)# neighbor 6.6.6.6 activate	Activate the neighbour
PE1(config-router-af)# neighbor 6.6.6.6 next-hop-self	Enter neighbor ip add with next hop self
PE1(config-router-af)# neighbor 10.1.1.1 activate	Activate the neighbour
PE1(config-router-af)# neighbor 20.1.1.2 activate	Activate the neighbour
PE1(config-router-af)# neighbor 20.1.1.2 next-hop-self	Enter neighbor ip add with next hop self
PE1(config-router-af)# exit-address-family	Exit from address family
PE1(config-router)# address-family vpnv4 unicast	Enter address family vpnv4 unicast mode
PE1(config-router-af)# neighbor 6.6.6.6 activate	Activate the neighbour
PE1(config-router-af)# neighbor 6.6.6.6 next-hop-self	Enter neighbor ip add with next hop self
PE1(config-router-af)# neighbor 20.1.1.2 activate	Activate the neighbour
PE1(config-router-af)# neighbor 20.1.1.2 next-hop-self	Enter neighbor ip add with next hop self
PE1(config-router-af)# exit-address-family	Exit from address family
PE1(config-router)# address-family ipv4 flowspec	Enter address family ipv4 flowspec mode
PE1(config-router-af)# neighbor 6.6.6.6 activate	Activate the neighbour
PE1(config-router-af)# neighbor 10.1.1.1 activate	Activate the neighbour
PE1(config-router-af)# neighbor 20.1.1.2 activate	Activate the neighbour
PE1(config-router-af)# exit-address-family	Exit from address family
PE1(config-router)# address-family vpnv4 flowspec	Enter address family vpnv4 flowspec mode
PE1(config-router-af)# neighbor 6.6.6.6 activate	Activate the neighbour
PE1(config-router-af)# neighbor 20.1.1.2 activate	Activate the neighbour
PE1(config-router-af)# exit-address-family	Exit from address family
PE1(config-router)# address-family ipv4 vrf vrf100	Enter address family ipv4 vrf vrf name mode
PE1(config-router-af)# redistribute connected	Enter redistribute connected
PE1(config-router-af)# neighbor 66.1.1.1 remote-as 100	Enter neighbor ip add with remote-as 100
PE1(config-router-af)# neighbor 66.1.1.1 activate	Activate the neighbour
PE1(config-router-af)# exit-address-family	Exit from address family

BGP Flowspec Support for IPv4

PE1(config-router)# address-family ipv4 flowspec vrf vrf100	Enter address family ipv4 flowspec vrf vrf name mode
PE1(config-router-af)# neighbor 66.1.1.1 activate	Activate the neighbour
PE1(config-router-af)# exit-address-family	Exit from address family
PE1(config-router)#exit	Exit from router bgp instance
PE1(config)#commit	Commits the configuration

RR2

RR2#configure terminal	Enter configure mode.
RR2(config)#router ldp	Enter router ldp
RR2(config-router)#exit	Exit from ldp mode
RR2(config)#commit	Commits the configuration
RR2(config)#interface lo	Enter interface mode
RR2(config-if)#ip address 2.2.2.2/32 secondary	Assigned ip add as secondary
RR2(config-if)# ip router isis 1	Enter isis instance
RR2(config-if)#exit	Exit from interface mode
RR2(config)#commit	Commits the configuration
RR2(config)#interface ce43	Enter interface mode
RR2(config-if)# speed 40g	Set the speed
RR2(config-if)# ip address 11.1.1.2/24	Assign the ip add
RR2(config-if)# label-switching	Enable label switching
RR2(config-if)# ip router isis 1	Enter router isis instance
RR2(config-if)# enable-ldp ipv4	Enable ldp ipv4
RR2(config-if)#exit	Exit from interface mode
RR2(config)#commit	Commits the configuration
RR2(config)#interface xe7	Enter interface mode
RR2(config-if)# ip address 20.1.1.2/24	Assign the ip add
RR2(config-if)# label-switching	Enable label switching
RR2(config-if)# ip router isis 1	Enter router isis instance
RR2(config-if)# enable-ldp ipv4	Enable ldp ipv4
RR2(config-if)#exit	Exit from interface mode
RR2(config)#commit	Commits the configuration
RR2(config)#router isis 1	Configure isis instance
RR2(config-router)# is-type level-1-2	Configure is-type-level-1-2
RR2(config-router)# metric-style wide	Configure metric style wide
RR2(config-router)# mpls traffic-eng router-id 2.2.2.2	Configure router id
RR2(config-router)# mpls traffic-eng level-1	Configure traffic engg level-1
RR2(config-router)# mpls traffic-eng level-2	Configure traffic engg level-2
RR2(config-router)# dynamic-hostname	Configure hostname

RR2(config-router)# bfd all-interfaces	Enable bfd all interfaces
RR2(config-router)# net 49.0000.0000.0002.00	Configure network id
RR2(config-router)#exit	Exit from isis instance mode
RR2(config)#commit	Commits the configuration
RR2(config)#router bgp 65000	Configure router bgp instance
RR2(config-router)# no bgp inbound-route-filter	Configure no bgp inbound route filter
RR2(config-router)# neighbor 11.1.1.1 remote-as 65000	Configure neighbor ip address remote as 65000
RR2(config-router)# neighbor 20.1.1.1 remote-as 65000	Configure neighbor ip address remote as 65000
RR2(config-router)# address-family ipv4 unicast	Enter address family ipv4 unicast mode
RR2(config-router-af)# neighbor 11.1.1.1 activate	Activate the neighbour
RR2(config-router-af)# neighbor 11.1.1.1 route-reflector-client	Enable the neighbor ip add as route reflector client
RR2(config-router-af)# neighbor 20.1.1.1 activate	Activate the neighbour
RR2(config-router-af)# neighbor 20.1.1.1 route-reflector-client	Enable the neighbor ip add as route reflector client
RR2(config-router-af)# exit-address-family	Exit from address family
RR2(config-router)# address-family vpnv4 unicast	Enter address family vpnv4 unicast mode
RR2(config-router-af)# neighbor 11.1.1.1 activate	Activate the neighbour
RR2(config-router-af)# neighbor 11.1.1.1 route-reflector-client	Enable the neighbor ip add as route reflector client
RR2(config-router-af)# neighbor 20.1.1.1 activate	Activate the neighbour
RR2(config-router-af)# neighbor 20.1.1.1 route-reflector-client	Enable the neighbor ip add as route reflector client
RR2(config-router-af)# exit-address-family	Exit from address family
RR2(config-router)# address-family ipv4 flowspec	Enter the address family ipv4 flowspec mode
RR2(config-router-af)# neighbor 11.1.1.1 activate	Activate the neighbour
RR2(config-router-af)# neighbor 11.1.1.1 route-reflector-client	Enable the neighbor ip add as route reflector client
RR2(config-router-af)# neighbor 20.1.1.1 activate	Activate the neighbour
RR2(config-router-af)# neighbor 20.1.1.1 route-reflector-client	Enable the neighbor ip add as route reflector client
RR2(config-router-af)# exit-address-family	Exit from address family
RR2(config-router)# address-family vpnv4 flowspec	Enter address family vpnv4 flowspec mode
RR2(config-router-af)# neighbor 11.1.1.1 activate	Activate the neighbour

BGP Flowspec Support for IPv4

RR2 (config-router-af) # neighbor 11.1.1.1 route-reflector-client	Enable the neighbor ip add as route reflector client
RR2 (config-router-af) # neighbor 20.1.1.1 activate	Activate the neighbour
RR2 (config-router-af) # neighbor 20.1.1.1 route-reflector-client	Enable the neighbor ip add as route reflector client
RR2 (config-router-af) # exit-address-family	Exit from address family mode
RR2 (config-router) #exit	Exit from router bgp instance mode
RR2 (config) #commit	

RR1

RR1#configure terminal	Enter configure mode.
RR1 (config) #router ldp	Enter router ldp
RR1 (config-router) #exit	Exit from ldp mode
RR1 (config) #commit	Commits the configuration
RR1 (config) #interface lo	Enter the interface mode
RR1 (config-if) # ip address 6.6.6.6/32 secondary	Assign the ip address secondary
RR1 (config-if) # ip router isis 1	Enter router isis instance
RR1 (config-if) #exit	Exit from interface mode
RR1 (config) #commit	Commits the configuration
RR1 (config) #interface ce4	Enter the interface mode
RR1 (config-if) # ip address 50.1.1.2/24	Assign the ip add
RR1 (config-if) # label-switching	Enable label switching
RR1 (config-if) # ip router isis 1	Enter router isis instance
RR1 (config-if) # enable-ldp ipv4	Enable ldp ipv4
RR1 (config-if) #exit	Exit from interface mode
RR1 (config) #commit	Commits the configuration
RR1 (config) #interface ce6	Enter the interface mode
RR1 (config-if) # ip address 40.1.1.2/24	Assign the ip add
RR1 (config-if) # label-switching	Enable label switching
RR1 (config-if) # ip router isis 1	Enter router isis instance
RR1 (config-if) # enable-ldp ipv4	Enable ldp ipv4
RR1 (config-if) #exit	Exit from interface mode
RR1 (config) #commit	Commits the configuration
RR1 (config) #router isis 1	Configure isis instance
RR1 (config-router) # is-type level-1-2	Configure is-type-level-1-2
RR1 (config-router) # metric-style wide	Configure metric style wide
RR1 (config-router) # mpls traffic-eng router-id 6.6.6.6	Configure router id
RR1 (config-router) # mpls traffic-eng level-1	Configure traffic engg level-1
RR1 (config-router) # mpls traffic-eng level-2	Configure traffic engg level-2

RR1(config-router)# dynamic-hostname	Configure hostname
RR1(config-router)# bfd all-interfaces	Enable bfd all interfaces
RR1(config-router)# net 49.0000.0000.0006.00	Configure network id
RR1(config-router)#exit	Exit from isis instance mode
RR1(config)#commit	Commits the configuration
RR1(config)#router bgp 65000	Configure router bgp instance
RR1(config-router)# no bgp inbound-route-filter	Configure no bgp inbound route filter
RR1(config-router)# neighbor 1.1.1.1 remote-as 65000	Configure neighbor ip address remote as 65000
RR1(config-router)# neighbor 3.3.3.3 remote-as 65000	Configure neighbor ip address remote as 65000
RR1(config-router)# neighbor 1.1.1.1 update-source lo	Configure neighbor ip address with update loopback
RR1(config-router)# neighbor 3.3.3.3 update-source lo	Configure neighbor ip address with update loopback
RR1(config-router)# address-family ipv4 unicast	Enter address family ipv4 unicast mode
RR1(config-router-af)# neighbor 1.1.1.1 activate	Activate the neighbour
RR1(config-router-af)# neighbor 1.1.1.1 route-reflector-client	Enable the neighbor ip add as route reflector client
RR1(config-router-af)# neighbor 3.3.3.3 activate	Activate the neighbour
RR1(config-router-af)# neighbor 3.3.3.3 route-reflector-client	Enable the neighbor ip add as route reflector client
RR1(config-router-af)# exit-address-family	Exit from address family
RR1(config-router)# address-family vpnv4 unicast	Enter address family vpnv4 unicast mode
RR1(config-router-af)# neighbor 1.1.1.1 activate	Activate the neighbour
RR1(config-router-af)# neighbor 1.1.1.1 route-reflector-client	Enable the neighbor ip add as route reflector client
RR1(config-router-af)# neighbor 3.3.3.3 activate	Activate the neighbour
RR1(config-router-af)# neighbor 3.3.3.3 route-reflector-client	Enable the neighbor ip add as route reflector client
RR1(config-router-af)# exit-address-family	Exit from address family
RR1(config-router)# address-family ipv4 flowspec	Enter the address family ipv4 flowspec mode
RR1(config-router-af)# neighbor 1.1.1.1 activate	Activate the neighbour
RR1(config-router-af)# neighbor 1.1.1.1 route-reflector-client	Enable the neighbor ip add as route reflector client
RR1(config-router-af)# neighbor 3.3.3.3 activate	Activate the neighbour
RR1(config-router-af)# neighbor 3.3.3.3 route-reflector-client	Enable the neighbor ip add as route reflector client

BGP Flowspec Support for IPv4

RR1 (config-router-af) # exit-address-family	Exit from address family
RR1 (config-router) # address-family vpv4 flowspec	Enter address family vpv4 flowspec mode
RR1 (config-router-af) # neighbor 1.1.1.1 activate	Activate the neighbour
RR1 (config-router-af) # neighbor 1.1.1.1 route-reflector-client	Enable the neighbor ip add as route reflector client
RR1 (config-router-af) # neighbor 3.3.3.3 activate	Activate the neighbour
RR1 (config-router-af) # neighbor 3.3.3.3 route-reflector-client	Enable the neighbor ip add as route reflector client
RR1 (config-router-af) # exit-address-family	Exit from address family mode
RR1 (config-router) #exit	Exit from router bgp instance mode
RR1 (config) #commit	

PE2

PE2#configure terminal	Enter configure mode.
PE2 (config) #router ldp	Enter vrf vrf name
PE2 (config-router) # targeted-peer ipv4 1.1.1.1	Enter rd value
PE2 (config-router-targeted-peer) #exit-targeted-peer-mode	Enter router targeted as both
PE2 (config-router) #exit	Exit from vrf mode
PE2 (config) #commit	Commits the configuration
PE2 (config) #ip vrf vrf100	Enter vrf vrf name
PE2 (config-vrf) # rd 100:1	Enter rd value
PE2 (config-vrf) # route-target both 100:1	Enter router targeted as both
PE2 (config-vrf) #exit	Exit from vrf mode
PE2 (config) #commit	Commits the configuration
PE2 (config) #ip vrf vrf101	Enter vrf vrf name
PE2 (config-vrf) # rd 101:1	Enter rd value
PE2 (config-vrf) # route-target both 101:1	Enter router targeted as both
PE2 (config-vrf) #exit	Exit from vrf mode
PE2 (config) #commit	Commits the configuration
PE2 (config) #class-map type traffic match-all cl1	Configure class map with class name
PE2 (config-cmap-tr) # match destination-address ipv4 1.1.1.1/32	Configure match with destination ip address
PE2 (config-cmap-tr) # match source-address ipv4 3.3.3.3/32	Enable match with source ip address
PE2 (config-cmap-tr) # match port 111-222	Enable match with port range
PE2 (config-cmap-tr) # match destination-port 300-399	Enable match with destination-port range
PE2 (config-cmap-tr) # match source-port 230-299	Enable match with source-port range

PE2 (config-cmap-tr) #exit	Exit from class map traffic
PE2 (config) #commit	Commits the configuration
PE2 (config) #policy-map type pbr poll	Configure policy map type pbr with policy name
PE2 (config-pmap-pbr) # class type traffic cl1	Enable class type traffic with class map name
PE2 (config-pmap-pbr-c) # police rate 1111111 bps	Enable policy rate
PE2 (config-pmap-pbr-c) #exit	Exit from policy map traffic
PE2 (config-pmap-pbr) #exit	Exit from policy map
PE2 (config) #commit	Commits the configuration
PE2 (config) #flowspec	Configure flowspec
PE2 (config-flowspec) # address-family ipv4	Enter address-family mode with ipv4
PE2 (config-flowspec-af) # service-policy type pbr poll	Enable service policy type pbr with policy name
PE2 (config-flowspec-af) #exit	Exit from address family mode
PE2 (config-flowspec) #exit	Exit from flowspec mode
PE2 (config) #commit	Commits the configuration
PE2 (config) #interface lo	Enter the loopback interface
PE2 (config-if) # ip address 3.3.3.3/32 secondary	Assign the ip address secondary
PE2 (config-if) # ip router isis 1	Enable router isis instance
PE2 (config-if) #exit	Exit from interface mode
PE2 (config) #commit	Commits the configuration
PE2 (config) #interface ce4	Enter the interface mode
PE2 (config-if) # ip address 50.1.1.1/24	Assign the ip address
PE2 (config-if) # label-switching	Enable label switching
PE2 (config-if) # ip router isis 1	Enter router isis instance
PE2 (config-if) # enable-ldp ipv4	Enable ldp ipv4
PE2 (config-if) #exit	Exit from interface mode
PE2 (config) #commit	Commits the configuration
PE2 (config) #interface ce43	Enter the interface mode
PE2 (config-if) # speed 40g	Set the interface speed
PE2 (config-if) # ip address 11.1.1.1/24	Assign the ip address
PE2 (config-if) # label-switching	Enable label switching
PE2 (config-if) # ip router isis 1	Enter router isis instance
PE2 (config-if) #enable-ldp ipv4	Enable ldp ipv4
PE2 (config-if) #exit	Exit from interface mode
PE2 (config) #commit	Commits the configuration
PE2 (config) #interface ce6	Enter the interface mode
PE2 (config-if) # ip address 30.1.1.2/24	Assign the ip address
PE2 (config-if) #exit	Exit from interface mode
PE2 (config) #commit	Commits the configuration
PE2 (config) #interface ce6.10	Enter the sub-interface mode

BGP Flowspec Support for IPv4

PE2(config-if)# encapsulation dot1q 10	Enable encapsulate dot1q vlan id
PE2(config-if)# ip vrf forwarding vrf100	Enable brf forwarding vrf name
PE2(config-if)# ip address 55.1.1.1/24	Assign the ip add
PE2(config-if)#exit	Exit from interface mode
PE2(config)#commit	Commits the configuration
PE2(config)#router isis 1	Configure isis instance
PE2(config-router)# is-type level-1-2	Configure is-type-level-1-2
PE2(config-router)# metric-style wide	Configure metric style wide
PE2(config-router)# mpls traffic-eng router-id 3.3.3.3	Configure router id
PE2(config-router)# mpls traffic-eng level-1	Configure traffic engg level-1
PE2(config-router)# mpls traffic-eng level-2	Configure traffic engg level-2
PE2(config-router)# dynamic-hostname	Configure hostname
PE2(config-router)# bfd all-interfaces	Enable bfd all interfaces
PE2(config-router)# net 49.0000.0000.0003.00	Configure network id
PE2(config-router)# passive-interface lo	Configure passive interface as loopback
PE2(config-router)#exit	Exit from isis instance mode
PE2(config)#commit	Commits the configuration
PE2(config)#router bgp 65000	Configure bgp instance
PE2(config-router)# neighbor 6.6.6.6 remote-as 65000	Enable neighbour address with remote-as 65000
PE2(config-router)# neighbor 11.1.1.2 remote-as 65000	Enable neighbour address with remote-as 65000
PE2(config-router)# neighbor 30.1.1.1 remote-as 200	Enable neighbour address with remote-as 300
PE2(config-router)# neighbor 6.6.6.6 update-source lo	Enable neighbour address with update loopback
PE2(config-router)# address-family ipv4 unicast	Enter address family ipv4 mode
PE2(config-router-af)# neighbor 6.6.6.6 activate	Activate the neighbour
PE2(config-router-af)# neighbor 6.6.6.6 next-hop-self	Enter neighbor ip add with next hop self
PE2(config-router-af)# neighbor 11.1.1.2 activate	Activate the neighbour
PE2(config-router-af)# neighbor 11.1.1.2 next-hop-self	Activate the neighbour
PE2(config-router-af)# neighbor 30.1.1.1 activate	Enter neighbor ip add with next hop self
PE2(config-router-af)# exit-address-family	Exit from address family
PE2(config-router)# address-family vpnv4 unicast	Enter address family vpnv4 unicast mode
PE2(config-router-af)# neighbor 6.6.6.6 activate	Activate the neighbour
PE2(config-router-af)# neighbor 6.6.6.6 next-hop-self	Enter neighbor ip add with next hop self

PE2(config-router-af)# neighbor 11.1.1.2 activate	Activate the neighbour
PE2(config-router-af)# neighbor 11.1.1.2 next-hop-self	Enter neighbor ip add with next hop self
PE2(config-router-af)# exit-address-family	Exit from address family
PE2(config-router)# address-family ipv4 flowspec	Enter address family ipv4 flowspec mode
PE2(config-router-af)# neighbor 6.6.6.6 activate	Activate the neighbour
PE2(config-router-af)# neighbor 11.1.1.2 activate	Activate the neighbour
PE2(config-router-af)# neighbor 30.1.1.1 activate	Activate the neighbour
PE2(config-router-af)# exit-address-family	Exit from address family
PE2(config-router)# address-family vpv4 flowspec	Enter address family vpv4 flowspec mode
PE2(config-router-af)# neighbor 6.6.6.6 activate	Activate the neighbour
PE2(config-router-af)# neighbor 11.1.1.2 activate	Activate the neighbour
PE2(config-router-af)# exit-address-family	Exit from address family
PE2(config-router)# address-family ipv4 vrf vrf100	Enter address family ipv4 vrf vrf name mode
PE2(config-router-af)# redistribute connected	Enter redistribute connected
PE2(config-router-af)# neighbor 55.1.1.2 remote-as 200	Enter neighbor ip add with remote-as 200
PE2(config-router-af)# neighbor 55.1.1.2 activate	Activate the neighbour
PE2(config-router-af)# exit-address-family	Exit from address family
PE2(config-router)# address-family ipv4 flowspec vrf vrf100	Enter address family ipv4 flowspec vrf vrf name mode
PE2(config-router-af)# neighbor 55.1.1.2 activate	Activate the neighbour
PE2(config-router-af)# exit-address-family	Exit from address family
PE2(config-router)#exit	Exit from router bgp instance
PE2(config)#commit	Commits the configuration

CE2

CE2#configure terminal	Enter configure mode.
CE2(config)#class-map type traffic match-all clas1	Configure class map with class name
CE2(config-cmap-tr)# match destination-address ipv4 4.4.4.4/32	Configure match with destination ip address
CE2(config-cmap-tr)# match source-address ipv4 5.5.5.5/32	Enable match with source ip address
CE2(config-cmap-tr)# match protocol 121	Enable match with protocol

BGP Flowspec Support for IPv4

CE2(config-cmap-tr)# match port 777-888	Enable match with port
CE2(config-cmap-tr)# match destination-port 1300-1400	Enable match with destination-port
CE2(config-cmap-tr)# match source-port 1001-1200	Enable match with source-port
CE2(config-cmap-tr)#exit	Exit from class map traffic mode
CE2(config)#commit	Commits the configuration
CE2(config)#class-map type traffic match-all clas2	Configure class map with class name
CE2(config-cmap-tr)# match destination-address ipv4 30.1.1.0/24	Configure match with destination ip address
CE2(config-cmap-tr)# match source-address ipv4 30.1.1.0/24	Enable match with source ip address
CE2(config-cmap-tr)# match protocol 11	Enable match with protocol
CE2(config-cmap-tr)# match port 100-200	Enable match with port
CE2(config-cmap-tr)# match destination-port 300-400	Enable match with destination-port
CE2(config-cmap-tr)# match source-port 500-600	Enable match with source-port
CE2(config-cmap-tr)# match tcp-flag 21 bit-mask 3f	Enable match with tcp flag bit
CE2(config-cmap-tr)# match dscp 21	Enable match with dscp
CE2(config-cmap-tr)#exit	Exit from class map traffic mode
CE2(config)#commit	Commits the configuration
CE2(config)#policy-map type pbr pol1	Configure policy map type pbr with policy name
CE2(config-pmap-pbr)#class type traffic clas1	Enable class type traffic with class map name
CE2(config-pmap-pbr-c)#police rate 100000 bps	Enable policy rate
CE2(config-pmap-pbr-c)#exit	Exit from policy map traffic
CE2(config-pmap-pbr)#exit	Exit from policy map
CE2(config)#commit	Commits the configuration
CE2(config)#policy-map type pbr pol2	Configure policy map type pbr with policy name
CE2(config-pmap-pbr)# class type traffic clas2	Enable class type traffic with class map name
CE2(config-pmap-pbr-c)# police rate 500000 bps	Enable policy rate
CE2(config-pmap-pbr-c)# set dscp 1e	Set the dscp value
CE2(config-pmap-pbr-c)#exit	Exit from policy map traffic
CE2(config-pmap-pbr)#exit	Exit from policy map
CE2(config)#commit	Commits the configuration
CE2(config)#flowspec	Configure flowspec
CE2(config-flowspec)# address-family ipv4	Enter address-family mode with ipv4
CE2(config-flowspec-af)# service-policy type pbr pol1	Enable service policy type pbr with policy name

CE2(config-flowspec-af)# service-policy type pbr pol2	Enable service policy type pbr with policy name
CE2(config-flowspec-af)#exit	Exit from address family mode
CE2(config-flowspec)#exit	Exit from flowspec mode
CE2(config)#commit	Commits the configuration
CE2(config)#interface lo	
	Enter interface mode
CE2(config-if)# ip address 5.5.5.5/32 secondary	Assign the ip address secondary
CE2(config-if)# ip router isis 1	Enter router isis instance
CE2(config-if)#exit	Exit from interface mode
CE2(config)#commit	Commits the configuration
CE2(config)#interface ce49	Enter interface mode
CE2(config-if)# ip address 30.1.1.1/24	Assign the ip address
CE2(config-if)#exit	Exit from interface mode
CE2(config)#commit	Commits the configuration
CE2-7025(config)#interface ce49.10	Enter sub-interface mode
CE2-7025(config-if)# encapsulation dot1q 10	Enable encapsulate dot1q vlan id
CE2-7025(config-if)# ip address 55.1.1.2/24	Assign the ip address
CE2-7025(config-if)#exit	Exit from interface mode
CE2-7025(config)#commit	Commits the configuration
CE2(config)#router bgp 200	Configure bgp instance
CE2(config-router)# neighbor 30.1.1.2 remote-as 65000	Enable neighbour address with remote-as 65000
CE2(config-router)# neighbor 55.1.1.1 remote-as 65000	Enable neighbour address with remote-as 65000
CE2(config-router)# address-family ipv4 unicast	Enter address family ipv4 unicast mode
CE2(config-router-af)# redistribute connected	Enter redistribute connected
CE2(config-router-af)# neighbor 30.1.1.2 activate	Activate the neighbour
CE2(config-router-af)# neighbor 55.1.1.1 activate	Activate the neighbour
CE2(config-router-af)# exit-address-family	Exit from address family mode
CE2(config-router)# address-family ipv4 flowspec	Enter address family ipv4 flowspec mode
CE2(config-router-af)# neighbor 30.1.1.2 activate	Activate the neighbour
CE2(config-router-af)# neighbor 55.1.1.1 activate	Exit from address family
CE2(config-router-af)# exit-address-family	Exit from router bgp mode
CE2(config-router)#exit	Exit from router bgp instance
CE2(config)#commit	Commits the configuration

Validation

CE1

```
CE1#sh ip bgp
BGP table version is 3, local router ID is 4.4.4.4
Status codes: s suppressed, d damped, h history, a add-path, * valid, > best, i -
internal,
                l - labeled, S Stale
Origin codes: i - IGP, e - EGP, ? - incomplete
```

	Network	Next Hop	Metric	LocPrf	Weight	Path
*>	4.4.4.4/32	0.0.0.0	0	100	32768	?
*>	5.5.5.5/32	10.1.1.2	0	100	0	65000 200 ?
*		66.1.1.2	0	100	0	65000 200 ?
*>	10.1.1.0/24	0.0.0.0	0	100	32768	?
*>	30.1.1.0/24	10.1.1.2	0	100	0	65000 200 ?
*		66.1.1.2	0	100	0	65000 200 ?
*>	55.1.1.0/24	66.1.1.2	0	100	0	65000 ?
*		10.1.1.2	0	100	0	65000 200 ?
*>	66.1.1.0/24	0.0.0.0	0	100	32768	?
*		66.1.1.2	0	100	0	65000 ?
*>	100.1.1.0/24	0.0.0.0	0	100	32768	?
*>	200.1.1.0	10.1.1.2	0	100	0	65000 200 ?
*		66.1.1.2	0	100	0	65000 200 ?

```
Total number of prefixes 8
CE1#
```

```
CE1#sh ip bgp neighbors
BGP neighbor is 10.1.1.2, remote AS 65000, local AS 100, external link
  BGP version 4, local router ID 4.4.4.4, remote router ID 1.1.1.1
  BGP state = Established, up for 03:06:16
  Last read 00:00:05, hold time is 90, keepalive interval is 30 seconds
  Neighbor capabilities:
    Route refresh: advertised and received (old and new)
    Address family IPv4 Unicast: advertised and received
    Address family IPv4 Flow Specification: advertised and received
  Received 447 messages, 0 notifications, 0 in queue
  Sent 444 messages, 1 notifications, 0 in queue
  Route refresh request: received 0, sent 0
  Minimum time between advertisement runs is 30 seconds
```

```
For address family: IPv4 Unicast BGP table version 3, neighbor version 3
  Index 1, Offset 0, Mask 0x2
  Community attribute sent to this neighbor (both)
  Large Community attribute sent to this neighbor
  4 accepted prefixes
  5 announced prefixes
```

For address family: IPv4 Flow Specification BGP table version 2, neighbor version 2
Index 1, Offset 0, Mask 0x2
Community attribute sent to this neighbor (both)
Large Community attribute sent to this neighbor
4 accepted prefixes
2 announced prefixes

Connections established 1; dropped 0
Local host: 10.1.1.1, Local port: 179
Foreign host: 10.1.1.2, Foreign port: 37390
Next hop: 10.1.1.1
Next hop global: ::
Next hop local: ::
BGP connection: non shared network
Last Reset: 03:06:16, due to OPEN Message Error (Notification sent)
Notification Error Message: (OPEN Message Error/Bad BGP Identifier. Reason:)

BGP neighbor is 66.1.1.2, remote AS 65000, local AS 100, external link
BGP version 4, local router ID 4.4.4.4, remote router ID 66.1.1.2
BGP state = Established, up for 03:06:15
Last read 00:00:07, hold time is 90, keepalive interval is 30 seconds
Neighbor capabilities:
Route refresh: advertised and received (old and new)
Address family IPv4 Unicast: advertised and received
Address family IPv4 Flow Specification: advertised and received
Received 446 messages, 0 notifications, 0 in queue
Sent 446 messages, 1 notifications, 0 in queue
Route refresh request: received 0, sent 0
Minimum time between advertisement runs is 30 seconds

For address family: IPv4 Unicast BGP table version 3, neighbor version 3
Index 2, Offset 0, Mask 0x4
Community attribute sent to this neighbor (both)
Large Community attribute sent to this neighbor
5 accepted prefixes
7 announced prefixes

For address family: IPv4 Flow Specification BGP table version 2, neighbor version 2
Index 2, Offset 0, Mask 0x4
Community attribute sent to this neighbor (both)
Large Community attribute sent to this neighbor
2 accepted prefixes
2 announced prefixes

Connections established 1; dropped 0
Local host: 66.1.1.1, Local port: 53648
Foreign host: 66.1.1.2, Foreign port: 179
Next hop: 66.1.1.1

BGP Flowspec Support for IPv4

```
Nexthop global: ::
Nexthop local: ::
BGP connection: non shared network
Last Reset: 03:06:20, due to OPEN Message Error (Notification sent)
Notification Error Message: (OPEN Message Error/Bad BGP Identifier. Reason: )
```

```
CE1#
CE1#
CE1#sh ip bgp ipv4 flowspec summary
BGP router identifier 4.4.4.4, local AS number 100
BGP table version is 2
3 BGP AS-PATH entries
0 BGP community entries
```

Neighbor PfxRcd	V	AS	MsgRcv	MsgSen	TblVer	InQ	OutQ	Up/Down	State/
10.1.1.2 4	4	65000	447	445	2	0	0	03:06:20	
66.1.1.2 2	4	65000	446	448	2	0	0	03:06:19	

Total number of neighbors 2

Total number of Established sessions 2

```
CE1#
CE1#sh ip bgp ipv4 flowspec
BGP table version is 2, local router ID is 4.4.4.4
Status codes: s suppressed, d damped, h history, a add-path, * valid, > best, i -
internal,
                l - labeled, S Stale
Origin codes: i - IGP, e - EGP, ? - incomplete
```

	Network	Next Hop	Metric	LocPrf	Weight	Path
*>	flowspec/216	0.0.0.0	0	100	32768	i
*	flowspec/336	10.1.1.2	0	100	0	65000 200 i
*		66.1.1.2	0	100	0	65000 200 i
*	flowspec/264	10.1.1.2	0	100	0	65000 i
*	flowspec/392	10.1.1.2	0	100	0	65000 i
*>	flowspec/176	0.0.0.0	0	100	32768	i
*	flowspec/288	10.1.1.2	0	100	0	65000 200 i
*		66.1.1.2	0	100	0	65000 200 i

Total number of prefixes 6

```
CE1#
CE1#sh ip bgp ipv4 flowspec detail
BGP table version is 2, local router ID is 4.4.4.4
Status codes: s suppressed, d damped, h history, a add-path, * valid, > best, i -
internal,
                l - labeled, S Stale
Origin codes: i - IGP, e - EGP, ? - incomplete
```

```

Network          Next Hop          Metric    LocPrf    Weight Path
*>  flowspec/216    0.0.0.0          0         100      32768  i

FlowSpec:
destination ip address: 10.1.1.0/24
source ip address: 10.1.1.0/24
IP protocol:
  e:1 a:0 len:0 lt:0 gt:0 eq:1 data:44
TCP/UDP destination port:
  e:0 a:0 len:1 lt:0 gt:1 eq:1 data:44
  e:1 a:1 len:1 lt:1 gt:0 eq:1 data:144
TCP/UDP source port:
  e:0 a:0 len:1 lt:0 gt:1 eq:1 data:22
  e:1 a:1 len:1 lt:1 gt:0 eq:1 data:122

FlowSpec Actions:
  traffic_rate: 21000 bps

*    flowspec/336    10.1.1.2          0         100      0  65000 200 i

FlowSpec:
destination ip address: 30.1.1.0/24
source ip address: 30.1.1.0/24
IP protocol:
  e:1 a:0 len:0 lt:0 gt:0 eq:1 data:11
TCP/UDP port:
  e:0 a:0 len:1 lt:0 gt:1 eq:1 data:100
  e:1 a:1 len:1 lt:1 gt:0 eq:1 data:200
TCP/UDP destination port:
  e:0 a:0 len:1 lt:0 gt:1 eq:1 data:300
  e:1 a:1 len:1 lt:1 gt:0 eq:1 data:400
TCP/UDP source port:
  e:0 a:0 len:1 lt:0 gt:1 eq:1 data:500
  e:1 a:1 len:1 lt:1 gt:0 eq:1 data:600
TCP flags:
  e:0 a:0 len:0 not:0 m:1 data:0x21
  e:1 a:1 len:0 not:1 m:0 data:0x1e
DSCP:
  e:1 a:0 len:0 lt:0 gt:0 eq:1 data:0x21

FlowSpec Actions:
  traffic_rate: 500000 bps
  traffic marking DSCP: 1e

*          66.1.1.2          0         100      0  65000 200 i

FlowSpec Actions:
  traffic_rate: 500000 bps
  traffic marking DSCP: 1e

*    flowspec/264    10.1.1.2          0         100      0  65000  i

```

FlowSpec:

destination ip address: 1.1.1.1/32
source ip address: 3.3.3.3/32
TCP/UDP port:
 e:0 a:0 len:1 lt:0 gt:1 eq:1 data:111
 e:1 a:1 len:1 lt:1 gt:0 eq:1 data:222
TCP/UDP destination port:
 e:0 a:0 len:1 lt:0 gt:1 eq:1 data:300
 e:1 a:1 len:1 lt:1 gt:0 eq:1 data:399
TCP/UDP source port:
 e:0 a:0 len:1 lt:0 gt:1 eq:1 data:230
 e:1 a:1 len:1 lt:1 gt:0 eq:1 data:299

FlowSpec Actions:

traffic_rate: 11111111 bps

* flowspec/392 10.1.1.2 0 100 0 65000 i

FlowSpec:

destination ip address: 3.3.3.3/32
source ip address: 1.1.1.1/32
IP protocol:
 e:1 a:0 len:0 lt:0 gt:0 eq:1 data:78
TCP/UDP port:
 e:0 a:0 len:1 lt:0 gt:1 eq:1 data:101
 e:1 a:1 len:1 lt:1 gt:0 eq:1 data:201
TCP/UDP destination port:
 e:0 a:0 len:1 lt:0 gt:1 eq:1 data:400
 e:1 a:1 len:1 lt:1 gt:0 eq:1 data:499
TCP/UDP source port:
 e:0 a:0 len:1 lt:0 gt:1 eq:1 data:330
 e:1 a:1 len:1 lt:1 gt:0 eq:1 data:399
ICMP code:
 e:1 a:0 len:0 lt:0 gt:0 eq:1 data:10
Packet length:
 e:0 a:0 len:1 lt:0 gt:1 eq:1 data:22
 e:1 a:1 len:1 lt:1 gt:0 eq:1 data:222
DSCP:
 e:1 a:0 len:0 lt:0 gt:0 eq:1 data:0x10

FlowSpec Actions:

traffic_rate: 1000011 bps
traffic marking DSCP: e

*> flowspec/176 0.0.0.0 0 100 32768 i

FlowSpec:

destination ip address: 4.4.4.4/32
source ip address: 4.4.4.4/32

```
IP protocol:
  e:1 a:0 len:0 lt:0 gt:0 eq:1 data:12
TCP/UDP port:
  e:0 a:0 len:1 lt:0 gt:1 eq:1 data:333
  e:1 a:1 len:1 lt:1 gt:0 eq:1 data:444
```

```
FlowSpec Actions:
  traffic_rate: 4444444 bps
```

```
*   flowspec/288      10.1.1.2          0          100         0   65000 200 i
```

```
FlowSpec:
  destination ip address: 5.5.5.5/32
  source ip address: 5.5.5.5/32
  IP protocol:
    e:1 a:0 len:0 lt:0 gt:0 eq:1 data:121
  TCP/UDP port:
    e:0 a:0 len:1 lt:0 gt:1 eq:1 data:777
    e:1 a:1 len:1 lt:1 gt:0 eq:1 data:888
  TCP/UDP destination port:
    e:0 a:0 len:1 lt:0 gt:1 eq:1 data:1300
    e:1 a:1 len:1 lt:1 gt:0 eq:1 data:1400
  TCP/UDP source port:
    e:0 a:0 len:1 lt:0 gt:1 eq:1 data:1001
    e:1 a:1 len:1 lt:1 gt:0 eq:1 data:1200
```

```
FlowSpec Actions:
  traffic_rate: 100000 bps
```

```
*           66.1.1.2          0          100         0   65000 200 i
```

```
FlowSpec Actions:
  traffic_rate: 100000 bps
```

Total number of prefixes 6

CE1#

CE1#

CE1#sh ip bgp ipv4 flowspec vrf all

BGP table version is 2, local router ID is 4.4.4.4

Status codes: s suppressed, d damped, h history, a add-path, * valid, > best, i - internal,

l - labeled, S Stale

Origin codes: i - IGP, e - EGP, ? - incomplete

	Network	Next Hop	Metric	LocPrf	Weight	Path
*>	flowspec/216	0.0.0.0	0	100	32768	i
*	flowspec/336	10.1.1.2	0	100	0	65000 200 i
*		66.1.1.2	0	100	0	65000 200 i
*	flowspec/264	10.1.1.2	0	100	0	65000 i
*	flowspec/392	10.1.1.2	0	100	0	65000 i
*>	flowspec/176	0.0.0.0	0	100	32768	i

BGP Flowspec Support for IPv4

```
*   flowspec/288      10.1.1.2           0           100         0   65000 200 i
*                   66.1.1.2           0           100         0   65000 200 i
```

Total number of prefixes 6

CE1#sh ip bgp ipv4 flowspec vrf all detail

BGP table version is 2, local router ID is 4.4.4.4

Status codes: s suppressed, d damped, h history, a add-path, * valid, > best, i - internal,

l - labeled, S Stale

Origin codes: i - IGP, e - EGP, ? - incomplete

```
      Network          Next Hop           Metric      LocPrf   Weight Path
*>   flowspec/216      0.0.0.0            0           100      32768   i
```

FlowSpec:

destination ip address: 10.1.1.0/24

source ip address: 10.1.1.0/24

IP protocol:

e:1 a:0 len:0 lt:0 gt:0 eq:1 data:44

TCP/UDP destination port:

e:0 a:0 len:1 lt:0 gt:1 eq:1 data:44

e:1 a:1 len:1 lt:1 gt:0 eq:1 data:144

TCP/UDP source port:

e:0 a:0 len:1 lt:0 gt:1 eq:1 data:22

e:1 a:1 len:1 lt:1 gt:0 eq:1 data:122

FlowSpec Actions:

traffic_rate: 21000 bps

```
*   flowspec/336      10.1.1.2           0           100         0   65000 200 i
```

FlowSpec:

destination ip address: 30.1.1.0/24

source ip address: 30.1.1.0/24

IP protocol:

e:1 a:0 len:0 lt:0 gt:0 eq:1 data:11

TCP/UDP port:

e:0 a:0 len:1 lt:0 gt:1 eq:1 data:100

e:1 a:1 len:1 lt:1 gt:0 eq:1 data:200

TCP/UDP destination port:

e:0 a:0 len:1 lt:0 gt:1 eq:1 data:300

e:1 a:1 len:1 lt:1 gt:0 eq:1 data:400

TCP/UDP source port:

e:0 a:0 len:1 lt:0 gt:1 eq:1 data:500

e:1 a:1 len:1 lt:1 gt:0 eq:1 data:600

TCP flags:

e:0 a:0 len:0 not:0 m:1 data:0x21

e:1 a:1 len:0 not:1 m:0 data:0x1e

DSCP:

e:1 a:0 len:0 lt:0 gt:0 eq:1 data:0x21

FlowSpec Actions:

traffic_rate: 500000 bps
 traffic marking DSCP: 1e

* 66.1.1.2 0 100 0 65000 200 i

FlowSpec Actions:

traffic_rate: 500000 bps
 traffic marking DSCP: 1e

* flowspec/264 10.1.1.2 0 100 0 65000 i

FlowSpec:

destination ip address: 1.1.1.1/32
 source ip address: 3.3.3.3/32
 TCP/UDP port:
 e:0 a:0 len:1 lt:0 gt:1 eq:1 data:111
 e:1 a:1 len:1 lt:1 gt:0 eq:1 data:222
 TCP/UDP destination port:
 e:0 a:0 len:1 lt:0 gt:1 eq:1 data:300
 e:1 a:1 len:1 lt:1 gt:0 eq:1 data:399
 TCP/UDP source port:
 e:0 a:0 len:1 lt:0 gt:1 eq:1 data:230
 e:1 a:1 len:1 lt:1 gt:0 eq:1 data:299

FlowSpec Actions:

traffic_rate: 1111111 bps

* flowspec/392 10.1.1.2 0 100 0 65000 i

FlowSpec:

destination ip address: 3.3.3.3/32
 source ip address: 1.1.1.1/32
 IP protocol:
 e:1 a:0 len:0 lt:0 gt:0 eq:1 data:78
 TCP/UDP port:
 e:0 a:0 len:1 lt:0 gt:1 eq:1 data:101
 e:1 a:1 len:1 lt:1 gt:0 eq:1 data:201
 TCP/UDP destination port:
 e:0 a:0 len:1 lt:0 gt:1 eq:1 data:400
 e:1 a:1 len:1 lt:1 gt:0 eq:1 data:499
 TCP/UDP source port:
 e:0 a:0 len:1 lt:0 gt:1 eq:1 data:330
 e:1 a:1 len:1 lt:1 gt:0 eq:1 data:399
 ICMP code:
 e:1 a:0 len:0 lt:0 gt:0 eq:1 data:10
 Packet length:
 e:0 a:0 len:1 lt:0 gt:1 eq:1 data:22
 e:1 a:1 len:1 lt:1 gt:0 eq:1 data:222
 DSCP:
 e:1 a:0 len:0 lt:0 gt:0 eq:1 data:0x10

BGP Flowspec Support for IPv4

FlowSpec Actions:

traffic_rate: 1000011 bps
traffic marking DSCP: e

```
*>  flowspec/176      0.0.0.0                0          100          32768  i
```

FlowSpec:

destination ip address: 4.4.4.4/32
source ip address: 4.4.4.4/32
IP protocol:
 e:1 a:0 len:0 lt:0 gt:0 eq:1 data:12
TCP/UDP port:
 e:0 a:0 len:1 lt:0 gt:1 eq:1 data:333
 e:1 a:1 len:1 lt:1 gt:0 eq:1 data:444

FlowSpec Actions:

traffic_rate: 4444444 bps

```
*  flowspec/288      10.1.1.2                0          100          0  65000 200 i
```

FlowSpec:

destination ip address: 5.5.5.5/32
source ip address: 5.5.5.5/32
IP protocol:
 e:1 a:0 len:0 lt:0 gt:0 eq:1 data:121
TCP/UDP port:
 e:0 a:0 len:1 lt:0 gt:1 eq:1 data:777
 e:1 a:1 len:1 lt:1 gt:0 eq:1 data:888
TCP/UDP destination port:
 e:0 a:0 len:1 lt:0 gt:1 eq:1 data:1300
 e:1 a:1 len:1 lt:1 gt:0 eq:1 data:1400
TCP/UDP source port:
 e:0 a:0 len:1 lt:0 gt:1 eq:1 data:1001
 e:1 a:1 len:1 lt:1 gt:0 eq:1 data:1200

FlowSpec Actions:

traffic_rate: 100000 bps

```
*                66.1.1.2                0          100          0  65000 200 i
```

FlowSpec Actions:

traffic_rate: 100000 bps

Total number of prefixes 6

CE1#

PE1

PE1#sh ip bgp

BGP table version is 5, local router ID is 1.1.1.1

Status codes: s suppressed, d damped, h history, a add-path, * valid, > best, i - internal,

l - labeled, S Stale

Origin codes: i - IGP, e - EGP, ? - incomplete

	Network	Next Hop	Metric	LocPrf	Weight	Path
*>	4.4.4.4/32	10.1.1.1	0	100	0	100 ?
*>i	5.5.5.5/32	3.3.3.3	0	100	0	200 ?
* i		11.1.1.1	0	100	0	200 ?
*	9.9.9.9/32	0.0.0.0	0	100	32768	i
*>	10.1.1.0/24	10.1.1.1	0	100	0	100 ?
*>i	30.1.1.0/24	3.3.3.3	0	100	0	200 ?
* i		11.1.1.1	0	100	0	200 ?
*>i	55.1.1.0/24	3.3.3.3	0	100	0	200 ?
* i		11.1.1.1	0	100	0	200 ?
*>	66.1.1.0/24	10.1.1.1	0	100	0	100 ?
*>	100.1.1.0/24	10.1.1.1	0	100	0	100 ?
*>i	200.1.1.0	3.3.3.3	0	100	0	200 ?
* i		11.1.1.1	0	100	0	200 ?

Total number of prefixes 9

PE1#

PE1#sh ip bgp neighbors

BGP neighbor is 6.6.6.6, remote AS 65000, local AS 65000, internal link

BGP version 4, local router ID 1.1.1.1, remote router ID 6.6.6.6

BGP state = Established, up for 03:06:53

Last read 00:00:11, hold time is 90, keepalive interval is 30 seconds

Neighbor capabilities:

Route refresh: advertised and received (old and new)

Address family IPv4 Unicast: advertised and received

Address family VPNv4 Unicast: advertised and received

Address family IPv4 Flow Specification: advertised and received

Address family VPNv4 Flow Specification: advertised and received

Received 448 messages, 0 notifications, 0 in queue

Sent 445 messages, 1 notifications, 0 in queue

Route refresh request: received 0, sent 0

Minimum time between advertisement runs is 5 seconds

Update source is lo

For address family: IPv4 Unicast BGP table version 5, neighbor version 5

Index 1, Offset 0, Mask 0x2

AIGP is enabled

NEXT_HOP is always this router

Community attribute sent to this neighbor (both)

Large Community attribute sent to this neighbor

4 accepted prefixes

4 announced prefixes

For address family: VPNv4 Unicast BGP table version 3, neighbor version 3

Index 1, Offset 0, Mask 0x2

BGP Flowspec Support for IPv4

AIGP is enabled
NEXT_HOP is always this router
Community attribute sent to this neighbor (both)
Large Community attribute sent to this neighbor
4 accepted prefixes
4 announced prefixes

For address family: IPv4 Flow Specification BGP table version 7, neighbor version 7
Index 1, Offset 0, Mask 0x2
Community attribute sent to this neighbor (both)
Large Community attribute sent to this neighbor
3 accepted prefixes
3 announced prefixes

For address family: VPNv4 Flow Specification BGP table version 2, neighbor version 2
Index 1, Offset 0, Mask 0x2
Community attribute sent to this neighbor (both)
Large Community attribute sent to this neighbor
2 accepted prefixes
2 announced prefixes

Connections established 1; dropped 0
Local host: 1.1.1.1, Local port: 41307
Foreign host: 6.6.6.6, Foreign port: 179
Nexthop: 1.1.1.1
Nexthop global: ::
Nexthop local: ::
BGP connection: non shared network
Last Reset: 03:06:58, due to OPEN Message Error (Notification sent)
Notification Error Message: (OPEN Message Error/Bad BGP Identifier. Reason:)

BGP neighbor is 10.1.1.1, remote AS 100, local AS 65000, external link
BGP version 4, local router ID 1.1.1.1, remote router ID 4.4.4.4
BGP state = Established, up for 03:07:28
Last read 00:00:24, hold time is 90, keepalive interval is 30 seconds
Neighbor capabilities:
Route refresh: advertised and received (old and new)
Address family IPv4 Unicast: advertised and received
Address family IPv4 Flow Specification: advertised and received
Received 444 messages, 1 notifications, 0 in queue
Sent 450 messages, 0 notifications, 0 in queue
Route refresh request: received 0, sent 0
Minimum time between advertisement runs is 30 seconds

For address family: IPv4 Unicast BGP table version 5, neighbor version 5
Index 2, Offset 0, Mask 0x4
Community attribute sent to this neighbor (both)
Large Community attribute sent to this neighbor

4 accepted prefixes
4 announced prefixes

For address family: IPv4 Flow Specification BGP table version 7, neighbor version 7
Index 2, Offset 0, Mask 0x4
Community attribute sent to this neighbor (both)
Large Community attribute sent to this neighbor
2 accepted prefixes
4 announced prefixes

Connections established 1; dropped 0
Local host: 10.1.1.2, Local port: 37390
Foreign host: 10.1.1.1, Foreign port: 179
Nexthop: 10.1.1.2
Nexthop global: ::
Nexthop local: ::
BGP connection: non shared network
Last Reset: 03:07:33, due to BGP Notification received
Notification Error Message: (OPEN Message Error/Bad BGP Identifier. Reason:)

BGP neighbor is 20.1.1.2, remote AS 65000, local AS 65000, internal link
BGP version 4, local router ID 1.1.1.1, remote router ID 2.2.2.2
BGP state = Established, up for 03:06:26
Last read 00:00:12, hold time is 90, keepalive interval is 30 seconds
Neighbor capabilities:
Route refresh: advertised and received (old and new)
Address family IPv4 Unicast: advertised and received
Address family VPNv4 Unicast: advertised and received
Address family IPv4 Flow Specification: advertised and received
Address family VPNv4 Flow Specification: advertised and received
Received 446 messages, 0 notifications, 0 in queue
Sent 450 messages, 2 notifications, 0 in queue
Route refresh request: received 0, sent 0
Minimum time between advertisement runs is 5 seconds

For address family: IPv4 Unicast BGP table version 5, neighbor version 5
Index 3, Offset 0, Mask 0x8
AIGP is enabled
NEXT_HOP is always this router
Community attribute sent to this neighbor (both)
Large Community attribute sent to this neighbor
4 accepted prefixes
4 announced prefixes

For address family: VPNv4 Unicast BGP table version 3, neighbor version 3
Index 2, Offset 0, Mask 0x4
AIGP is enabled
NEXT_HOP is always this router

BGP Flowspec Support for IPv4

Community attribute sent to this neighbor (both)
Large Community attribute sent to this neighbor
4 accepted prefixes
4 announced prefixes

For address family: IPv4 Flow Specification BGP table version 7, neighbor version 7
Index 3, Offset 0, Mask 0x8
Community attribute sent to this neighbor (both)
Large Community attribute sent to this neighbor
3 accepted prefixes
3 announced prefixes

For address family: VPNv4 Flow Specification BGP table version 2, neighbor version 2
Index 2, Offset 0, Mask 0x4
Community attribute sent to this neighbor (both)
Large Community attribute sent to this neighbor
2 accepted prefixes
2 announced prefixes

Connections established 1; dropped 0
Local host: 20.1.1.1, Local port: 179
Foreign host: 20.1.1.2, Foreign port: 43160
Nexthop: 20.1.1.1
Nexthop global: ::
Nexthop local: ::
BGP connection: non shared network
Last Reset: 03:06:26, due to Administratively Reset (Cease Notification sent)
Notification Error Message: (Cease/Administratively Reset.)

BGP neighbor is 66.1.1.1, vrf vrf100, remote AS 100, local AS 65000, external link
BGP version 4, local router ID 66.1.1.2, remote router ID 4.4.4.4
BGP state = Established, up for 03:07:28
Last read 00:00:17, hold time is 90, keepalive interval is 30 seconds
Neighbor capabilities:
Route refresh: advertised and received (old and new)
Address family IPv4 Unicast: advertised and received
Address family IPv4 Flow Specification: advertised and received
Received 449 messages, 1 notifications, 0 in queue
Sent 451 messages, 0 notifications, 0 in queue
Route refresh request: received 0, sent 0
Minimum time between advertisement runs is 30 seconds

For address family: IPv4 Unicast BGP table version 1, neighbor version 1
Index 1, Offset 0, Mask 0x2
Community attribute sent to this neighbor (standard)
Large Community attribute sent to this neighbor
4 accepted prefixes
5 announced prefixes

For address family: IPv4 Flow Specification BGP table version 1, neighbor version 1
 Index 1, Offset 0, Mask 0x2
 Community attribute sent to this neighbor (both)
 Large Community attribute sent to this neighbor
 2 accepted prefixes
 2 announced prefixes

Connections established 1; dropped 0
 Local host: 66.1.1.2, Local port: 179
 Foreign host: 66.1.1.1, Foreign port: 53648
 Nexthop: 66.1.1.2
 Nexthop global: ::
 Nexthop local: ::
 BGP connection: non shared network
 Last Reset: 03:07:33, due to BGP Notification received
 Notification Error Message: (OPEN Message Error/Bad BGP Identifier. Reason:)

PE1#
 PE1#
 PE1#sh ip bgp ipv4 flowspec summary
 BGP router identifier 1.1.1.1, local AS number 65000
 BGP table version is 7
 3 BGP AS-PATH entries
 0 BGP community entries

Neighbor PfxRcd	V	AS	MsgRcv	MsgSen	TblVer	InQ	OutQ	Up/Down	State/
6.6.6.6 3	4	65000	448	446	7	0	0	03:07:01	
10.1.1.1 2	4	100	446	451	7	0	0	03:07:36	
20.1.1.2 3	4	65000	446	452	7	0	0	03:06:34	

Total number of neighbors 3

Total number of Established sessions 3
 BGP router identifier 66.1.1.2, local AS number 65000
 BGP VRF vrf100 Route Distinguisher: 100:1
 BGP table version is 1
 3 BGP AS-PATH entries
 0 BGP community entries

Neighbor PfxRcd	V	AS	MsgRcv	MsgSen	TblVer	InQ	OutQ	Up/Down	State/
66.1.1.1 2	4	100	451	451	1	0	0	03:07:36	

Total number of neighbors 1

BGP Flowspec Support for IPv4

Total number of Established sessions 1

```
PE1#
PE1#
PE1#sh ip bgp ipv4 flowspec
BGP table version is 7, local router ID is 1.1.1.1
Status codes: s suppressed, d damped, h history, a add-path, * valid, > best, i -
internal,
                l - labeled, S Stale
Origin codes: i - IGP, e - EGP, ? - incomplete
```

	Network	Next Hop	Metric	LocPrf	Weight	Path
*>	flowspec/216	10.1.1.1	0	100	0	100 i
*>i	flowspec/336	6.6.6.6	0	100	0	200 i
* i		20.1.1.2	0	100	0	200 i
*>i	flowspec/264	6.6.6.6	0	100	0	i
* i		20.1.1.2	0	100	0	i
*>	flowspec/392	0.0.0.0	0	100	32768	i
*>	flowspec/176	10.1.1.1	0	100	0	100 i
*>i	flowspec/288	6.6.6.6	0	100	0	200 i
* i		20.1.1.2	0	100	0	200 i

Total number of prefixes 6

```
PE1#
PE1#sh ip bgp ipv4 flowspec detail
BGP table version is 7, local router ID is 1.1.1.1
Status codes: s suppressed, d damped, h history, a add-path, * valid, > best, i -
internal,
                l - labeled, S Stale
Origin codes: i - IGP, e - EGP, ? - incomplete
```

	Network	Next Hop	Metric	LocPrf	Weight	Path
*>	flowspec/216	10.1.1.1	0	100	0	100 i

FlowSpec:

```
destination ip address: 10.1.1.0/24
source ip address: 10.1.1.0/24
IP protocol:
  e:1 a:0 len:0 lt:0 gt:0 eq:1 data:44
TCP/UDP destination port:
  e:0 a:0 len:1 lt:0 gt:1 eq:1 data:44
  e:1 a:1 len:1 lt:1 gt:0 eq:1 data:144
TCP/UDP source port:
  e:0 a:0 len:1 lt:0 gt:1 eq:1 data:22
  e:1 a:1 len:1 lt:1 gt:0 eq:1 data:122
```

FlowSpec Actions:

```
traffic_rate: 21000 bps
```

*>i	flowspec/336	6.6.6.6	0	100	0	200 i
-----	--------------	---------	---	-----	---	-------

FlowSpec:

```

destination ip address: 30.1.1.0/24
source ip address: 30.1.1.0/24
IP protocol:
  e:1 a:0 len:0 lt:0 gt:0 eq:1 data:11
TCP/UDP port:
  e:0 a:0 len:1 lt:0 gt:1 eq:1 data:100
  e:1 a:1 len:1 lt:1 gt:0 eq:1 data:200
TCP/UDP destination port:
  e:0 a:0 len:1 lt:0 gt:1 eq:1 data:300
  e:1 a:1 len:1 lt:1 gt:0 eq:1 data:400
TCP/UDP source port:
  e:0 a:0 len:1 lt:0 gt:1 eq:1 data:500
  e:1 a:1 len:1 lt:1 gt:0 eq:1 data:600
TCP flags:
  e:0 a:0 len:0 not:0 m:1 data:0x21
  e:1 a:1 len:0 not:1 m:0 data:0x1e
DSCP:
  e:1 a:0 len:0 lt:0 gt:0 eq:1 data:0x21

```

FlowSpec Actions:

```

traffic_rate: 500000 bps
traffic marking DSCP: 1e

```

```
* i          20.1.1.2          0          100          0  200 i
```

FlowSpec Actions:

```

traffic_rate: 500000 bps
traffic marking DSCP: 1e

```

```
*>i flowspec/264      6.6.6.6          0          100          0  i
```

FlowSpec:

```

destination ip address: 1.1.1.1/32
source ip address: 3.3.3.3/32
TCP/UDP port:
  e:0 a:0 len:1 lt:0 gt:1 eq:1 data:111
  e:1 a:1 len:1 lt:1 gt:0 eq:1 data:222
TCP/UDP destination port:
  e:0 a:0 len:1 lt:0 gt:1 eq:1 data:300
  e:1 a:1 len:1 lt:1 gt:0 eq:1 data:399
TCP/UDP source port:
  e:0 a:0 len:1 lt:0 gt:1 eq:1 data:230
  e:1 a:1 len:1 lt:1 gt:0 eq:1 data:299

```

FlowSpec Actions:

```

traffic_rate: 1111111 bps

```

```
* i          20.1.1.2          0          100          0  i
```

FlowSpec Actions:

```

traffic_rate: 1111111 bps

```

BGP Flowspec Support for IPv4

```
*>  flowspec/392      0.0.0.0              0          100          32768  i
```

FlowSpec:

```
destination ip address: 3.3.3.3/32
```

```
source ip address: 1.1.1.1/32
```

IP protocol:

```
  e:1 a:0 len:0 lt:0 gt:0 eq:1 data:78
```

TCP/UDP port:

```
  e:0 a:0 len:1 lt:0 gt:1 eq:1 data:101
```

```
  e:1 a:1 len:1 lt:1 gt:0 eq:1 data:201
```

TCP/UDP destination port:

```
  e:0 a:0 len:1 lt:0 gt:1 eq:1 data:400
```

```
  e:1 a:1 len:1 lt:1 gt:0 eq:1 data:499
```

TCP/UDP source port:

```
  e:0 a:0 len:1 lt:0 gt:1 eq:1 data:330
```

```
  e:1 a:1 len:1 lt:1 gt:0 eq:1 data:399
```

ICMP code:

```
  e:1 a:0 len:0 lt:0 gt:0 eq:1 data:10
```

Packet length:

```
  e:0 a:0 len:1 lt:0 gt:1 eq:1 data:22
```

```
  e:1 a:1 len:1 lt:1 gt:0 eq:1 data:222
```

DSCP:

```
  e:1 a:0 len:0 lt:0 gt:0 eq:1 data:0x10
```

FlowSpec Actions:

```
traffic_rate: 1000011 bps
```

```
traffic marking DSCP: e
```

```
*>  flowspec/176      10.1.1.1             0          100          0  100  i
```

FlowSpec:

```
destination ip address: 4.4.4.4/32
```

```
source ip address: 4.4.4.4/32
```

IP protocol:

```
  e:1 a:0 len:0 lt:0 gt:0 eq:1 data:12
```

TCP/UDP port:

```
  e:0 a:0 len:1 lt:0 gt:1 eq:1 data:333
```

```
  e:1 a:1 len:1 lt:1 gt:0 eq:1 data:444
```

FlowSpec Actions:

```
traffic_rate: 4444444 bps
```

```
*>i  flowspec/288      6.6.6.6              0          100          0  200  i
```

FlowSpec:

```
destination ip address: 5.5.5.5/32
```

```
source ip address: 5.5.5.5/32
```

IP protocol:

```
  e:1 a:0 len:0 lt:0 gt:0 eq:1 data:121
```

TCP/UDP port:

```

    e:0 a:0 len:1 lt:0 gt:1 eq:1 data:777
    e:1 a:1 len:1 lt:1 gt:0 eq:1 data:888
TCP/UDP destination port:
    e:0 a:0 len:1 lt:0 gt:1 eq:1 data:1300
    e:1 a:1 len:1 lt:1 gt:0 eq:1 data:1400
TCP/UDP source port:
    e:0 a:0 len:1 lt:0 gt:1 eq:1 data:1001
    e:1 a:1 len:1 lt:1 gt:0 eq:1 data:1200

```

FlowSpec Actions:

```
traffic_rate: 100000 bps
```

```
* i          20.1.1.2          0          100          0  200 i
```

FlowSpec Actions:

```
traffic_rate: 100000 bps
```

Total number of prefixes 6

PE1#

PE1#

PE1#sh ip bgp ipv4 flowspec vrf all

BGP table version is 1, local router ID is 66.1.1.2

Status codes: s suppressed, d damped, h history, a add-path, * valid, > best, i - internal,

l - labeled, S Stale

Origin codes: i - IGP, e - EGP, ? - incomplete

Network	Next Hop	Metric	LocPrf	Weight	Path
BGP Route Table for VRF vrf100					
*> flowspec/216	66.1.1.1	0	100	0	100 i
*>i flowspec/336	6.6.6.6	0	100	0	200 i
*> flowspec/176	66.1.1.1	0	100	0	100 i
*>i flowspec/288	6.6.6.6	0	100	0	200 i

Total number of prefixes 4

*> flowspec/216	10.1.1.1	0	100	0	100 i
*>i flowspec/336	6.6.6.6	0	100	0	200 i
* i	20.1.1.2	0	100	0	200 i
*>i flowspec/264	6.6.6.6	0	100	0	i
* i	20.1.1.2	0	100	0	i
*> flowspec/392	0.0.0.0	0	100	32768	i
*> flowspec/176	10.1.1.1	0	100	0	100 i
*>i flowspec/288	6.6.6.6	0	100	0	200 i
* i	20.1.1.2	0	100	0	200 i

Total number of prefixes 6

PE1#

PE1#

PE1#sh ip bgp ipv4 flowspec vrf all detail

BGP table version is 1, local router ID is 66.1.1.2

BGP Flowspec Support for IPv4

Status codes: s suppressed, d damped, h history, a add-path, * valid, > best, i - internal,

l - labeled, S Stale

Origin codes: i - IGP, e - EGP, ? - incomplete

Network	Next Hop	Metric	LocPrf	Weight	Path
BGP Route Table for VRF vrf100					
*> flowspec/216	66.1.1.1	0	100	0	100 i

FlowSpec:

destination ip address: 10.1.1.0/24

source ip address: 10.1.1.0/24

IP protocol:

e:1 a:0 len:0 lt:0 gt:0 eq:1 data:44

TCP/UDP destination port:

e:0 a:0 len:1 lt:0 gt:1 eq:1 data:44

e:1 a:1 len:1 lt:1 gt:0 eq:1 data:144

TCP/UDP source port:

e:0 a:0 len:1 lt:0 gt:1 eq:1 data:22

e:1 a:1 len:1 lt:1 gt:0 eq:1 data:122

FlowSpec Actions:

traffic_rate: 21000 bps

*>i flowspec/336	6.6.6.6	0	100	0	200 i
------------------	---------	---	-----	---	-------

FlowSpec:

destination ip address: 30.1.1.0/24

source ip address: 30.1.1.0/24

IP protocol:

e:1 a:0 len:0 lt:0 gt:0 eq:1 data:11

TCP/UDP port:

e:0 a:0 len:1 lt:0 gt:1 eq:1 data:100

e:1 a:1 len:1 lt:1 gt:0 eq:1 data:200

TCP/UDP destination port:

e:0 a:0 len:1 lt:0 gt:1 eq:1 data:300

e:1 a:1 len:1 lt:1 gt:0 eq:1 data:400

TCP/UDP source port:

e:0 a:0 len:1 lt:0 gt:1 eq:1 data:500

e:1 a:1 len:1 lt:1 gt:0 eq:1 data:600

TCP flags:

e:0 a:0 len:0 not:0 m:1 data:0x21

e:1 a:1 len:0 not:1 m:0 data:0x1e

DSCP:

e:1 a:0 len:0 lt:0 gt:0 eq:1 data:0x21

FlowSpec Actions:

traffic_rate: 500000 bps

traffic marking DSCP: 1e

```
*> flowspec/176      66.1.1.1          0          100         0   100 i
```

FlowSpec:

```
destination ip address: 4.4.4.4/32
source ip address: 4.4.4.4/32
IP protocol:
  e:1 a:0 len:0 lt:0 gt:0 eq:1 data:12
TCP/UDP port:
  e:0 a:0 len:1 lt:0 gt:1 eq:1 data:333
  e:1 a:1 len:1 lt:1 gt:0 eq:1 data:444
```

FlowSpec Actions:

```
traffic_rate: 4444444 bps
```

```
*>i flowspec/288     6.6.6.6          0          100         0   200 i
```

FlowSpec:

```
destination ip address: 5.5.5.5/32
source ip address: 5.5.5.5/32
IP protocol:
  e:1 a:0 len:0 lt:0 gt:0 eq:1 data:121
TCP/UDP port:
  e:0 a:0 len:1 lt:0 gt:1 eq:1 data:777
  e:1 a:1 len:1 lt:1 gt:0 eq:1 data:888
TCP/UDP destination port:
  e:0 a:0 len:1 lt:0 gt:1 eq:1 data:1300
  e:1 a:1 len:1 lt:1 gt:0 eq:1 data:1400
TCP/UDP source port:
  e:0 a:0 len:1 lt:0 gt:1 eq:1 data:1001
  e:1 a:1 len:1 lt:1 gt:0 eq:1 data:1200
```

FlowSpec Actions:

```
traffic_rate: 100000 bps
```

```
Total number of prefixes 4
```

```
*> flowspec/216     10.1.1.1         0          100         0   100 i
```

FlowSpec:

```
destination ip address: 10.1.1.0/24
source ip address: 10.1.1.0/24
IP protocol:
  e:1 a:0 len:0 lt:0 gt:0 eq:1 data:44
TCP/UDP destination port:
  e:0 a:0 len:1 lt:0 gt:1 eq:1 data:44
  e:1 a:1 len:1 lt:1 gt:0 eq:1 data:144
TCP/UDP source port:
  e:0 a:0 len:1 lt:0 gt:1 eq:1 data:22
  e:1 a:1 len:1 lt:1 gt:0 eq:1 data:122
```

BGP Flowspec Support for IPv4

FlowSpec Actions:

traffic_rate: 21000 bps

```
*>i flowspec/336      6.6.6.6              0          100         0   200 i
```

FlowSpec:

destination ip address: 30.1.1.0/24

source ip address: 30.1.1.0/24

IP protocol:

e:1 a:0 len:0 lt:0 gt:0 eq:1 data:11

TCP/UDP port:

e:0 a:0 len:1 lt:0 gt:1 eq:1 data:100

e:1 a:1 len:1 lt:1 gt:0 eq:1 data:200

TCP/UDP destination port:

e:0 a:0 len:1 lt:0 gt:1 eq:1 data:300

e:1 a:1 len:1 lt:1 gt:0 eq:1 data:400

TCP/UDP source port:

e:0 a:0 len:1 lt:0 gt:1 eq:1 data:500

e:1 a:1 len:1 lt:1 gt:0 eq:1 data:600

TCP flags:

e:0 a:0 len:0 not:0 m:1 data:0x21

e:1 a:1 len:0 not:1 m:0 data:0x1e

DSCP:

e:1 a:0 len:0 lt:0 gt:0 eq:1 data:0x21

FlowSpec Actions:

traffic_rate: 500000 bps

traffic marking DSCP: 1e

```
* i                20.1.1.2              0          100         0   200 i
```

FlowSpec Actions:

traffic_rate: 500000 bps

traffic marking DSCP: 1e

```
*>i flowspec/264      6.6.6.6              0          100         0    i
```

FlowSpec:

destination ip address: 1.1.1.1/32

source ip address: 3.3.3.3/32

TCP/UDP port:

e:0 a:0 len:1 lt:0 gt:1 eq:1 data:111

e:1 a:1 len:1 lt:1 gt:0 eq:1 data:222

TCP/UDP destination port:

e:0 a:0 len:1 lt:0 gt:1 eq:1 data:300

e:1 a:1 len:1 lt:1 gt:0 eq:1 data:399

TCP/UDP source port:

e:0 a:0 len:1 lt:0 gt:1 eq:1 data:230

e:1 a:1 len:1 lt:1 gt:0 eq:1 data:299

FlowSpec Actions:

```

traffic_rate: 1111111 bps
* i          20.1.1.2          0          100          0          i
FlowSpec Actions:
  traffic_rate: 1111111 bps
*>  flowspec/392      0.0.0.0          0          100          32768      i

FlowSpec:
  destination ip address: 3.3.3.3/32
  source ip address: 1.1.1.1/32
  IP protocol:
    e:1 a:0 len:0 lt:0 gt:0 eq:1 data:78
  TCP/UDP port:
    e:0 a:0 len:1 lt:0 gt:1 eq:1 data:101
    e:1 a:1 len:1 lt:1 gt:0 eq:1 data:201
  TCP/UDP destination port:
    e:0 a:0 len:1 lt:0 gt:1 eq:1 data:400
    e:1 a:1 len:1 lt:1 gt:0 eq:1 data:499
  TCP/UDP source port:
    e:0 a:0 len:1 lt:0 gt:1 eq:1 data:330
    e:1 a:1 len:1 lt:1 gt:0 eq:1 data:399
  ICMP code:
    e:1 a:0 len:0 lt:0 gt:0 eq:1 data:10
  Packet length:
    e:0 a:0 len:1 lt:0 gt:1 eq:1 data:22
    e:1 a:1 len:1 lt:1 gt:0 eq:1 data:222
  DSCP:
    e:1 a:0 len:0 lt:0 gt:0 eq:1 data:0x10

FlowSpec Actions:
  traffic_rate: 1000011 bps
  traffic marking DSCP: e
*>  flowspec/176      10.1.1.1          0          100          0          100      i

FlowSpec:
  destination ip address: 4.4.4.4/32
  source ip address: 4.4.4.4/32
  IP protocol:
    e:1 a:0 len:0 lt:0 gt:0 eq:1 data:12
  TCP/UDP port:
    e:0 a:0 len:1 lt:0 gt:1 eq:1 data:333
    e:1 a:1 len:1 lt:1 gt:0 eq:1 data:444

FlowSpec Actions:
  traffic_rate: 4444444 bps
*>i  flowspec/288      6.6.6.6          0          100          0          200      i

```

BGP Flowspec Support for IPv4

FlowSpec:

```
destination ip address: 5.5.5.5/32
source ip address: 5.5.5.5/32
IP protocol:
  e:1 a:0 len:0 lt:0 gt:0 eq:1 data:121
TCP/UDP port:
  e:0 a:0 len:1 lt:0 gt:1 eq:1 data:777
  e:1 a:1 len:1 lt:1 gt:0 eq:1 data:888
TCP/UDP destination port:
  e:0 a:0 len:1 lt:0 gt:1 eq:1 data:1300
  e:1 a:1 len:1 lt:1 gt:0 eq:1 data:1400
TCP/UDP source port:
  e:0 a:0 len:1 lt:0 gt:1 eq:1 data:1001
  e:1 a:1 len:1 lt:1 gt:0 eq:1 data:1200
```

FlowSpec Actions:

```
traffic_rate: 100000 bps
```

```
* i          20.1.1.2          0          100          0  200 i
```

FlowSpec Actions:

```
traffic_rate: 100000 bps
```

Total number of prefixes 6

PE1#

PE1#

PE1#sh ip bgp vpnv4 flowspec summary

BGP router identifier 1.1.1.1, local AS number 65000

BGP table version is 2

3 BGP AS-PATH entries

0 BGP community entries

Neighbor PfxRcd	V	AS	MsgRcv	MsgSen	TblVer	InQ	OutQ	Up/Down	State/
6.6.6.6 2	4	65000	450	448	2	0	0	03:07:39	
20.1.1.2 2	4	65000	448	453	2	0	0	03:07:12	

Total number of neighbors 2

Total number of Established sessions 2

PE1#

PE1#sh ip bgp vpnv4 flowspec vrf vrf100

Status codes: s suppressed, d damped, h history, a add-path, * valid, > best, i - internal, l - labeled

S Stale

Origin codes: i - IGP, e - EGP, ? - incomplete

Network	Next Hop	Metric	LocPrf	Weight	Path
Route Distinguisher: 100:1 (Default for VRF vrf100)					

```

*> flowspec/216      66.1.1.1          0          100         0  100 i
*>i flowspec/336     6.6.6.6           0          100         0  200 i
*> flowspec/176     66.1.1.1          0          100         0  100 i
*>i flowspec/288     6.6.6.6           0          100         0  200 i
Announced routes count = 2
Accepted routes count = 2
PE1#
PE1#sh ip bgp vpv4 flowspec vrf vrf100 detail
Status codes: s suppressed, d damped, h history, a add-path, * valid, > best, i -
internal, l - labeled
           S Stale
Origin codes: i - IGP, e - EGP, ? - incomplete

      Network          Next Hop          Metric      LocPrf      Weight Path
Route Distinguisher: 100:1 (Default for VRF vrf100)
*> flowspec/216      66.1.1.1          0          100         0  100 i

FlowSpec:
destination ip address: 10.1.1.0/24
source ip address: 10.1.1.0/24
IP protocol:
  e:1 a:0 len:0 lt:0 gt:0 eq:1 data:44
TCP/UDP destination port:
  e:0 a:0 len:1 lt:0 gt:1 eq:1 data:44
  e:1 a:1 len:1 lt:1 gt:0 eq:1 data:144
TCP/UDP source port:
  e:0 a:0 len:1 lt:0 gt:1 eq:1 data:22
  e:1 a:1 len:1 lt:1 gt:0 eq:1 data:122

FlowSpec Actions:
  traffic_rate: 21000 bps

*>i flowspec/336     6.6.6.6           0          100         0  200 i

FlowSpec:
destination ip address: 30.1.1.0/24
source ip address: 30.1.1.0/24
IP protocol:
  e:1 a:0 len:0 lt:0 gt:0 eq:1 data:11
TCP/UDP port:
  e:0 a:0 len:1 lt:0 gt:1 eq:1 data:100
  e:1 a:1 len:1 lt:1 gt:0 eq:1 data:200
TCP/UDP destination port:
  e:0 a:0 len:1 lt:0 gt:1 eq:1 data:300
  e:1 a:1 len:1 lt:1 gt:0 eq:1 data:400
TCP/UDP source port:
  e:0 a:0 len:1 lt:0 gt:1 eq:1 data:500
  e:1 a:1 len:1 lt:1 gt:0 eq:1 data:600
TCP flags:
  e:0 a:0 len:0 not:0 m:1 data:0x21
  e:1 a:1 len:0 not:1 m:0 data:0x1e

```

BGP Flowspec Support for IPv4

DSCP:

e:1 a:0 len:0 lt:0 gt:0 eq:1 data:0x21

FlowSpec Actions:

traffic_rate: 500000 bps

traffic marking DSCP: 1e

```
*> flowspec/176      66.1.1.1           0           100         0    100 i
```

FlowSpec:

destination ip address: 4.4.4.4/32

source ip address: 4.4.4.4/32

IP protocol:

e:1 a:0 len:0 lt:0 gt:0 eq:1 data:12

TCP/UDP port:

e:0 a:0 len:1 lt:0 gt:1 eq:1 data:333

e:1 a:1 len:1 lt:1 gt:0 eq:1 data:444

FlowSpec Actions:

traffic_rate: 4444444 bps

```
*>i flowspec/288     6.6.6.6           0           100         0    200 i
```

FlowSpec:

destination ip address: 5.5.5.5/32

source ip address: 5.5.5.5/32

IP protocol:

e:1 a:0 len:0 lt:0 gt:0 eq:1 data:121

TCP/UDP port:

e:0 a:0 len:1 lt:0 gt:1 eq:1 data:777

e:1 a:1 len:1 lt:1 gt:0 eq:1 data:888

TCP/UDP destination port:

e:0 a:0 len:1 lt:0 gt:1 eq:1 data:1300

e:1 a:1 len:1 lt:1 gt:0 eq:1 data:1400

TCP/UDP source port:

e:0 a:0 len:1 lt:0 gt:1 eq:1 data:1001

e:1 a:1 len:1 lt:1 gt:0 eq:1 data:1200

FlowSpec Actions:

traffic_rate: 100000 bps

Announced routes count = 2

Accepted routes count = 2

PE1#

RR1

RR1#sh clns neighbors

Total number of L1 adjacencies: 2

Total number of L2 adjacencies: 2

Total number of adjacencies: 4

Tag 1: VRF : default

System Id	Interface	SNPA	State	Holdtime	Type	Protocol
PE2	ce4	5c07.5819.4878	Up	27	L1	IS-IS
			Up	27	L2	IS-IS
PE1	ce6	b86a.9725.a7ec	Up	9	L1	IS-IS
			Up	9	L2	IS-IS

RR1#

RR1#sh ip bgp

BGP table version is 3, local router ID is 6.6.6.6

Status codes: s suppressed, d damped, h history, a add-path, * valid, > best, i - internal,

l - labeled, S Stale

Origin codes: i - IGP, e - EGP, ? - incomplete

Network	Next Hop	Metric	LocPrf	Weight	Path
*>i 4.4.4.4/32	1.1.1.1	0	100	0	100 ?
*>i 5.5.5.5/32	3.3.3.3	0	100	0	200 ?
*>i 10.1.1.0/24	1.1.1.1	0	100	0	100 ?
*>i 30.1.1.0/24	3.3.3.3	0	100	0	200 ?
*>i 55.1.1.0/24	3.3.3.3	0	100	0	200 ?
*>i 66.1.1.0/24	1.1.1.1	0	100	0	100 ?
*>i 100.1.1.0/24	1.1.1.1	0	100	0	100 ?
*>i 200.1.1.0	3.3.3.3	0	100	0	200 ?

Total number of prefixes 8

RR1#

RR1#

RR1#sh ip bgp neighbors

BGP neighbor is 1.1.1.1, remote AS 65000, local AS 65000, internal link

BGP version 4, local router ID 6.6.6.6, remote router ID 1.1.1.1

BGP state = Established, up for 03:08:38

Last read 00:00:13, hold time is 90, keepalive interval is 30 seconds

Neighbor capabilities:

Route refresh: advertised and received (old and new)

Address family IPv4 Unicast: advertised and received

Address family VPNv4 Unicast: advertised and received

Address family IPv4 Flow Specification: advertised and received

Address family VPNv4 Flow Specification: advertised and received

Received 449 messages, 1 notifications, 0 in queue

Sent 454 messages, 0 notifications, 0 in queue

Route refresh request: received 0, sent 0

Minimum time between advertisement runs is 5 seconds

Update source is lo

For address family: IPv4 Unicast BGP table version 3, neighbor version 3

Index 1, Offset 0, Mask 0x2

AIGP is enabled

Route-Reflector Client

Community attribute sent to this neighbor (both)

BGP Flowspec Support for IPv4

Large Community attribute sent to this neighbor
4 accepted prefixes
4 announced prefixes

For address family: VPNv4 Unicast BGP table version 3, neighbor version 3

Index 1, Offset 0, Mask 0x2
AIGP is enabled
Route-Reflector Client
Community attribute sent to this neighbor (both)
Large Community attribute sent to this neighbor
4 accepted prefixes
4 announced prefixes

For address family: IPv4 Flow Specification BGP table version 5, neighbor version 5

Index 1, Offset 0, Mask 0x2
Route-Reflector Client
Community attribute sent to this neighbor (both)
Large Community attribute sent to this neighbor
3 accepted prefixes
3 announced prefixes

For address family: VPNv4 Flow Specification BGP table version 3, neighbor version 3

Index 1, Offset 0, Mask 0x2
Route-Reflector Client
Community attribute sent to this neighbor (both)
Large Community attribute sent to this neighbor
2 accepted prefixes
2 announced prefixes

Connections established 1; dropped 0

Local host: 6.6.6.6, Local port: 179

Foreign host: 1.1.1.1, Foreign port: 41307

Nexthop: 6.6.6.6

Nexthop global: ::

Nexthop local: ::

BGP connection: non shared network

Last Reset: 03:08:43, due to BGP Notification received

Notification Error Message: (OPEN Message Error/Bad BGP Identifier. Reason:)

BGP neighbor is 3.3.3.3, remote AS 65000, local AS 65000, internal link

BGP version 4, local router ID 6.6.6.6, remote router ID 3.3.3.3

BGP state = Established, up for 03:06:51

Last read 00:00:19, hold time is 90, keepalive interval is 30 seconds

Neighbor capabilities:

Route refresh: advertised and received (old and new)

Address family IPv4 Unicast: advertised and received

Address family VPNv4 Unicast: advertised and received

Address family IPv4 Flow Specification: advertised and received
Address family VPNv4 Flow Specification: advertised and received
Received 446 messages, 0 notifications, 0 in queue
Sent 446 messages, 0 notifications, 0 in queue
Route refresh request: received 0, sent 0
Minimum time between advertisement runs is 5 seconds
Update source is lo

For address family: IPv4 Unicast BGP table version 3, neighbor version 3
Index 2, Offset 0, Mask 0x4
AIGP is enabled
Route-Reflector Client
Community attribute sent to this neighbor (both)
Large Community attribute sent to this neighbor
4 accepted prefixes
4 announced prefixes

For address family: VPNv4 Unicast BGP table version 3, neighbor version 3
Index 2, Offset 0, Mask 0x4
AIGP is enabled
Route-Reflector Client
Community attribute sent to this neighbor (both)
Large Community attribute sent to this neighbor
4 accepted prefixes
4 announced prefixes

For address family: IPv4 Flow Specification BGP table version 5, neighbor version 5
Index 2, Offset 0, Mask 0x4
Route-Reflector Client
Community attribute sent to this neighbor (both)
Large Community attribute sent to this neighbor
3 accepted prefixes
3 announced prefixes

For address family: VPNv4 Flow Specification BGP table version 3, neighbor version 3
Index 2, Offset 0, Mask 0x4
Route-Reflector Client
Community attribute sent to this neighbor (both)
Large Community attribute sent to this neighbor
2 accepted prefixes
2 announced prefixes

Connections established 1; dropped 0
Local host: 6.6.6.6, Local port: 35405
Foreign host: 3.3.3.3, Foreign port: 179
Next hop: 6.6.6.6
Next hop global: ::

BGP Flowspec Support for IPv4

Nexthop local: ::
BGP connection: non shared network

```
RR1#  
RR1#  
RR1#sh ip bgp ipv4 flowspec summary  
BGP router identifier 6.6.6.6, local AS number 65000  
BGP table version is 5  
3 BGP AS-PATH entries  
0 BGP community entries
```

Neighbor PfxRcd	V	AS	MsgRcv	MsgSen	TblVer	InQ	OutQ	Up/Down	State/
1.1.1.1 3	4	65000	450	454	5	0	0	03:08:46	
3.3.3.3 3	4	65000	447	447	5	0	0	03:06:59	

Total number of neighbors 2

Total number of Established sessions 2

```
RR1#  
RR1#  
RR1#sh ip bgp ipv4 flowspec  
BGP table version is 5, local router ID is 6.6.6.6  
Status codes: s suppressed, d damped, h history, a add-path, * valid, > best, i -  
internal,  
l - labeled, S Stale  
Origin codes: i - IGP, e - EGP, ? - incomplete
```

Network	Next Hop	Metric	LocPrf	Weight	Path
*>i flowspec/216	1.1.1.1	0	100	0	100 i
*>i flowspec/336	3.3.3.3	0	100	0	200 i
*>i flowspec/264	3.3.3.3	0	100	0	i
*>i flowspec/392	1.1.1.1	0	100	0	i
*>i flowspec/176	1.1.1.1	0	100	0	100 i
*>i flowspec/288	3.3.3.3	0	100	0	200 i

Total number of prefixes 6

```
RR1#  
RR1#  
RR1#sh ip bgp ipv4 flowspec detail  
BGP table version is 5, local router ID is 6.6.6.6  
Status codes: s suppressed, d damped, h history, a add-path, * valid, > best, i -  
internal,  
l - labeled, S Stale  
Origin codes: i - IGP, e - EGP, ? - incomplete
```

Network	Next Hop	Metric	LocPrf	Weight	Path
*>i flowspec/216	1.1.1.1	0	100	0	100 i

```

FlowSpec:
  destination ip address: 10.1.1.0/24
  source ip address: 10.1.1.0/24
  IP protocol:
    e:1 a:0 len:0 lt:0 gt:0 eq:1 data:44
  TCP/UDP destination port:
    e:0 a:0 len:1 lt:0 gt:1 eq:1 data:44
    e:1 a:1 len:1 lt:1 gt:0 eq:1 data:144
  TCP/UDP source port:
    e:0 a:0 len:1 lt:0 gt:1 eq:1 data:22
    e:1 a:1 len:1 lt:1 gt:0 eq:1 data:122

```

```

FlowSpec Actions:
  traffic_rate: 21000 bps

```

```
*>i flowspec/336      3.3.3.3          0          100         0    200 i
```

```

FlowSpec:
  destination ip address: 30.1.1.0/24
  source ip address: 30.1.1.0/24
  IP protocol:
    e:1 a:0 len:0 lt:0 gt:0 eq:1 data:11
  TCP/UDP port:
    e:0 a:0 len:1 lt:0 gt:1 eq:1 data:100
    e:1 a:1 len:1 lt:1 gt:0 eq:1 data:200
  TCP/UDP destination port:
    e:0 a:0 len:1 lt:0 gt:1 eq:1 data:300
    e:1 a:1 len:1 lt:1 gt:0 eq:1 data:400
  TCP/UDP source port:
    e:0 a:0 len:1 lt:0 gt:1 eq:1 data:500
    e:1 a:1 len:1 lt:1 gt:0 eq:1 data:600
  TCP flags:
    e:0 a:0 len:0 not:0 m:1 data:0x21
    e:1 a:1 len:0 not:1 m:0 data:0x1e
  DSCP:
    e:1 a:0 len:0 lt:0 gt:0 eq:1 data:0x21

```

```

FlowSpec Actions:
  traffic_rate: 500000 bps
  traffic marking DSCP: 1e

```

```
*>i flowspec/264      3.3.3.3          0          100         0     i
```

```

FlowSpec:
  destination ip address: 1.1.1.1/32
  source ip address: 3.3.3.3/32
  TCP/UDP port:
    e:0 a:0 len:1 lt:0 gt:1 eq:1 data:111
    e:1 a:1 len:1 lt:1 gt:0 eq:1 data:222
  TCP/UDP destination port:

```

BGP Flowspec Support for IPv4

```
e:0 a:0 len:1 lt:0 gt:1 eq:1 data:300
e:1 a:1 len:1 lt:1 gt:0 eq:1 data:399
TCP/UDP source port:
e:0 a:0 len:1 lt:0 gt:1 eq:1 data:230
e:1 a:1 len:1 lt:1 gt:0 eq:1 data:299
```

```
FlowSpec Actions:
traffic_rate: 1111111 bps
```

```
*>i flowspec/392      1.1.1.1          0          100         0          i
```

```
FlowSpec:
destination ip address: 3.3.3.3/32
source ip address: 1.1.1.1/32
IP protocol:
e:1 a:0 len:0 lt:0 gt:0 eq:1 data:78
TCP/UDP port:
e:0 a:0 len:1 lt:0 gt:1 eq:1 data:101
e:1 a:1 len:1 lt:1 gt:0 eq:1 data:201
TCP/UDP destination port:
e:0 a:0 len:1 lt:0 gt:1 eq:1 data:400
e:1 a:1 len:1 lt:1 gt:0 eq:1 data:499
TCP/UDP source port:
e:0 a:0 len:1 lt:0 gt:1 eq:1 data:330
e:1 a:1 len:1 lt:1 gt:0 eq:1 data:399
ICMP code:
e:1 a:0 len:0 lt:0 gt:0 eq:1 data:10
Packet length:
e:0 a:0 len:1 lt:0 gt:1 eq:1 data:22
e:1 a:1 len:1 lt:1 gt:0 eq:1 data:222
DSCP:
e:1 a:0 len:0 lt:0 gt:0 eq:1 data:0x10
```

```
FlowSpec Actions:
traffic_rate: 1000011 bps
traffic marking DSCP: e
```

```
*>i flowspec/176     1.1.1.1          0          100         0          100 i
```

```
FlowSpec:
destination ip address: 4.4.4.4/32
source ip address: 4.4.4.4/32
IP protocol:
e:1 a:0 len:0 lt:0 gt:0 eq:1 data:12
TCP/UDP port:
e:0 a:0 len:1 lt:0 gt:1 eq:1 data:333
e:1 a:1 len:1 lt:1 gt:0 eq:1 data:444
```

```
FlowSpec Actions:
traffic_rate: 4444444 bps
```

```
*>i flowspec/288      3.3.3.3          0          100        0    200 i
```

FlowSpec:

```
destination ip address: 5.5.5.5/32
source ip address: 5.5.5.5/32
IP protocol:
  e:1 a:0 len:0 lt:0 gt:0 eq:1 data:121
TCP/UDP port:
  e:0 a:0 len:1 lt:0 gt:1 eq:1 data:777
  e:1 a:1 len:1 lt:1 gt:0 eq:1 data:888
TCP/UDP destination port:
  e:0 a:0 len:1 lt:0 gt:1 eq:1 data:1300
  e:1 a:1 len:1 lt:1 gt:0 eq:1 data:1400
TCP/UDP source port:
  e:0 a:0 len:1 lt:0 gt:1 eq:1 data:1001
  e:1 a:1 len:1 lt:1 gt:0 eq:1 data:1200
```

FlowSpec Actions:

```
traffic_rate: 100000 bps
```

Total number of prefixes 6

RR1#

RR1#

RR1#sh ip bgp ipv4 flowspec vrf all

BGP table version is 5, local router ID is 6.6.6.6

Status codes: s suppressed, d damped, h history, a add-path, * valid, > best, i - internal,

l - labeled, S Stale

Origin codes: i - IGP, e - EGP, ? - incomplete

Network	Next Hop	Metric	LocPrf	Weight	Path
*>i flowspec/216	1.1.1.1	0	100	0	100 i
*>i flowspec/336	3.3.3.3	0	100	0	200 i
*>i flowspec/264	3.3.3.3	0	100	0	i
*>i flowspec/392	1.1.1.1	0	100	0	i
*>i flowspec/176	1.1.1.1	0	100	0	100 i
*>i flowspec/288	3.3.3.3	0	100	0	200 i

Total number of prefixes 6

RR1#

RR1#sh ip bgp ipv4 flowspec vrf all detail

BGP table version is 5, local router ID is 6.6.6.6

Status codes: s suppressed, d damped, h history, a add-path, * valid, > best, i - internal,

l - labeled, S Stale

Origin codes: i - IGP, e - EGP, ? - incomplete

Network	Next Hop	Metric	LocPrf	Weight	Path
*>i flowspec/216	1.1.1.1	0	100	0	100 i

FlowSpec:

destination ip address: 10.1.1.0/24
source ip address: 10.1.1.0/24
IP protocol:
 e:1 a:0 len:0 lt:0 gt:0 eq:1 data:44
TCP/UDP destination port:
 e:0 a:0 len:1 lt:0 gt:1 eq:1 data:44
 e:1 a:1 len:1 lt:1 gt:0 eq:1 data:144
TCP/UDP source port:
 e:0 a:0 len:1 lt:0 gt:1 eq:1 data:22
 e:1 a:1 len:1 lt:1 gt:0 eq:1 data:122

FlowSpec Actions:

traffic_rate: 21000 bps

*>i flowspec/336 3.3.3.3 0 100 0 200 i

FlowSpec:

destination ip address: 30.1.1.0/24
source ip address: 30.1.1.0/24
IP protocol:
 e:1 a:0 len:0 lt:0 gt:0 eq:1 data:11
TCP/UDP port:
 e:0 a:0 len:1 lt:0 gt:1 eq:1 data:100
 e:1 a:1 len:1 lt:1 gt:0 eq:1 data:200
TCP/UDP destination port:
 e:0 a:0 len:1 lt:0 gt:1 eq:1 data:300
 e:1 a:1 len:1 lt:1 gt:0 eq:1 data:400
TCP/UDP source port:
 e:0 a:0 len:1 lt:0 gt:1 eq:1 data:500
 e:1 a:1 len:1 lt:1 gt:0 eq:1 data:600
TCP flags:
 e:0 a:0 len:0 not:0 m:1 data:0x21
 e:1 a:1 len:0 not:1 m:0 data:0x1e
DSCP:
 e:1 a:0 len:0 lt:0 gt:0 eq:1 data:0x21

FlowSpec Actions:

traffic_rate: 500000 bps
traffic marking DSCP: 1e

*>i flowspec/264 3.3.3.3 0 100 0 i

FlowSpec:

destination ip address: 1.1.1.1/32
source ip address: 3.3.3.3/32
TCP/UDP port:
 e:0 a:0 len:1 lt:0 gt:1 eq:1 data:111
 e:1 a:1 len:1 lt:1 gt:0 eq:1 data:222

```
TCP/UDP destination port:
  e:0 a:0 len:1 lt:0 gt:1 eq:1 data:300
  e:1 a:1 len:1 lt:1 gt:0 eq:1 data:399
TCP/UDP source port:
  e:0 a:0 len:1 lt:0 gt:1 eq:1 data:230
  e:1 a:1 len:1 lt:1 gt:0 eq:1 data:299
```

```
FlowSpec Actions:
  traffic_rate: 1111111 bps
```

```
*>i flowspec/392      1.1.1.1          0          100         0         i
```

```
FlowSpec:
  destination ip address: 3.3.3.3/32
  source ip address: 1.1.1.1/32
  IP protocol:
    e:1 a:0 len:0 lt:0 gt:0 eq:1 data:78
  TCP/UDP port:
    e:0 a:0 len:1 lt:0 gt:1 eq:1 data:101
    e:1 a:1 len:1 lt:1 gt:0 eq:1 data:201
  TCP/UDP destination port:
    e:0 a:0 len:1 lt:0 gt:1 eq:1 data:400
    e:1 a:1 len:1 lt:1 gt:0 eq:1 data:499
  TCP/UDP source port:
    e:0 a:0 len:1 lt:0 gt:1 eq:1 data:330
    e:1 a:1 len:1 lt:1 gt:0 eq:1 data:399
  ICMP code:
    e:1 a:0 len:0 lt:0 gt:0 eq:1 data:10
  Packet length:
    e:0 a:0 len:1 lt:0 gt:1 eq:1 data:22
    e:1 a:1 len:1 lt:1 gt:0 eq:1 data:222
  DSCP:
    e:1 a:0 len:0 lt:0 gt:0 eq:1 data:0x10
```

```
FlowSpec Actions:
  traffic_rate: 1000011 bps
  traffic marking DSCP: e
```

```
*>i flowspec/176     1.1.1.1          0          100         0        100 i
```

```
FlowSpec:
  destination ip address: 4.4.4.4/32
  source ip address: 4.4.4.4/32
  IP protocol:
    e:1 a:0 len:0 lt:0 gt:0 eq:1 data:12
  TCP/UDP port:
    e:0 a:0 len:1 lt:0 gt:1 eq:1 data:333
    e:1 a:1 len:1 lt:1 gt:0 eq:1 data:444
```

```
FlowSpec Actions:
```

BGP Flowspec Support for IPv4

traffic_rate: 4444444 bps

```
*>i flowspec/288      3.3.3.3          0          100         0   200 i
```

FlowSpec:

destination ip address: 5.5.5.5/32

source ip address: 5.5.5.5/32

IP protocol:

e:1 a:0 len:0 lt:0 gt:0 eq:1 data:121

TCP/UDP port:

e:0 a:0 len:1 lt:0 gt:1 eq:1 data:777

e:1 a:1 len:1 lt:1 gt:0 eq:1 data:888

TCP/UDP destination port:

e:0 a:0 len:1 lt:0 gt:1 eq:1 data:1300

e:1 a:1 len:1 lt:1 gt:0 eq:1 data:1400

TCP/UDP source port:

e:0 a:0 len:1 lt:0 gt:1 eq:1 data:1001

e:1 a:1 len:1 lt:1 gt:0 eq:1 data:1200

FlowSpec Actions:

traffic_rate: 100000 bps

Total number of prefixes 6

RR1#

RR1#

RR1#sh ip bgp vpnv4 all

Status codes: s suppressed, d damped, h history, a add-path, * valid, > best, i - internal, l - labeled

S Stale

Origin codes: i - IGP, e - EGP, ? - incomplete

Network	Next Hop	Metric	LocPrf	Weight	Path
Route Distinguisher: 100:1					
*>i 4.4.4.4/32	1.1.1.1	0	100	0	100 ?
*>i 5.5.5.5/32	3.3.3.3	0	100	0	200 ?
*>i 10.1.1.0/24	1.1.1.1	0	100	0	100 ?
*>i 30.1.1.0/24	3.3.3.3	0	100	0	200 ?
*>i 55.1.1.0/24	3.3.3.3	0	100	0	?
*>i 66.1.1.0/24	1.1.1.1	0	100	0	?
*>i 100.1.1.0/24	1.1.1.1	0	100	0	100 ?
*>i 200.1.1.0	3.3.3.3	0	100	0	200 ?

Announced routes count = 0

Accepted routes count = 8

RR1#

RR1#

RR1#sh ip bgp vpnv4 flowspec summary

BGP router identifier 6.6.6.6, local AS number 65000

BGP table version is 3

3 BGP AS-PATH entries

0 BGP community entries

Neighbor PfxRcd	V	AS	MsgRcv	MsgSen	TblVer	InQ	OutQ	Up/Down	State/
1.1.1.1 2	4	65000	452	456	3	0	0	03:09:22	
3.3.3.3 2	4	65000	448	448	3	0	0	03:07:35	

Total number of neighbors 2

Total number of Established sessions 2

RR1#

RR2

RR2#sh clns neighbors

Total number of L1 adjacencies: 2

Total number of L2 adjacencies: 2

Total number of adjacencies: 4

Tag 1: VRF: default

System Id	Interface	SNPA	State	Holdtime	Type	Protocol
PE1	xe7	b86a.9725.a7c2	Up	6	L1	IS-IS
			Up	6	L2	IS-IS
PE2	ce43	5c07.5819.486b	Up	7	L1	IS-IS
			Up	7	L2	IS-IS

RR2#

RR2#sh ip bgp

BGP table version is 3, local router ID is 2.2.2.2

Status codes: s suppressed, d damped, h history, a add-path, * valid, > best, i - internal,

l - labeled, S Stale

Origin codes: i - IGP, e - EGP, ? - incomplete

Network	Next Hop	Metric	LocPrf	Weight	Path
*>i 4.4.4.4/32	20.1.1.1	0	100	0	100 ?
*>i 5.5.5.5/32	11.1.1.1	0	100	0	200 ?
*>i 10.1.1.0/24	20.1.1.1	0	100	0	100 ?
*>i 30.1.1.0/24	11.1.1.1	0	100	0	200 ?
*>i 55.1.1.0/24	11.1.1.1	0	100	0	200 ?
*>i 66.1.1.0/24	20.1.1.1	0	100	0	100 ?
*>i 100.1.1.0/24	20.1.1.1	0	100	0	100 ?
*>i 200.1.1.0	11.1.1.1	0	100	0	200 ?

Total number of prefixes 8

RR2#

RR2#

RR2#sh ip bgp neighbors

BGP neighbor is 11.1.1.1, remote AS 65000, local AS 65000, internal link

BGP version 4, local router ID 2.2.2.2, remote router ID 3.3.3.3

BGP state = Established, up for 03:09:46

BGP Flowspec Support for IPv4

Last read 00:00:05, hold time is 90, keepalive interval is 30 seconds

Neighbor capabilities:

Route refresh: advertised and received (old and new)

Address family IPv4 Unicast: advertised and received

Address family VPNv4 Unicast: advertised and received

Address family IPv4 Flow Specification: advertised and received

Address family VPNv4 Flow Specification: advertised and received

Received 458 messages, 0 notifications, 0 in queue

Sent 457 messages, 2 notifications, 0 in queue

Route refresh request: received 0, sent 0

Minimum time between advertisement runs is 5 seconds

For address family: IPv4 Unicast BGP table version 3, neighbor version 3

Index 1, Offset 0, Mask 0x2

AIGP is enabled

Route-Reflector Client

Community attribute sent to this neighbor (both)

Large Community attribute sent to this neighbor

4 accepted prefixes

4 announced prefixes

For address family: VPNv4 Unicast BGP table version 4, neighbor version 4

Index 1, Offset 0, Mask 0x2

AIGP is enabled

Route-Reflector Client

Community attribute sent to this neighbor (both)

Large Community attribute sent to this neighbor

4 accepted prefixes

4 announced prefixes

For address family: IPv4 Flow Specification BGP table version 5, neighbor version 5

Index 1, Offset 0, Mask 0x2

Route-Reflector Client

Community attribute sent to this neighbor (both)

Large Community attribute sent to this neighbor

3 accepted prefixes

3 announced prefixes

For address family: VPNv4 Flow Specification BGP table version 3, neighbor version 3

Index 1, Offset 0, Mask 0x2

Route-Reflector Client

Community attribute sent to this neighbor (both)

Large Community attribute sent to this neighbor

2 accepted prefixes

2 announced prefixes

Connections established 1; dropped 0

Local host: 11.1.1.2, Local port: 179
Foreign host: 11.1.1.1, Foreign port: 41446
Nexthop: 11.1.1.2
Nexthop global: ::
Nexthop local: ::
BGP connection: non shared network
Last Reset: 03:09:46, due to Administratively Reset (Cease Notification sent)
Notification Error Message: (Cease/Administratively Reset.)

BGP neighbor is 20.1.1.1, remote AS 65000, local AS 65000, internal link
BGP version 4, local router ID 2.2.2.2, remote router ID 1.1.1.1
BGP state = Established, up for 03:10:17
Last read 00:00:23, hold time is 90, keepalive interval is 30 seconds
Neighbor capabilities:
Route refresh: advertised and received (old and new)
Address family IPv4 Unicast: advertised and received
Address family VPNv4 Unicast: advertised and received
Address family IPv4 Flow Specification: advertised and received
Address family VPNv4 Flow Specification: advertised and received
Received 457 messages, 1 notifications, 0 in queue
Sent 457 messages, 0 notifications, 0 in queue
Route refresh request: received 0, sent 0
Minimum time between advertisement runs is 5 seconds

For address family: IPv4 Unicast BGP table version 3, neighbor version 3
Index 2, Offset 0, Mask 0x4
AIGP is enabled
Route-Reflector Client
Community attribute sent to this neighbor (both)
Large Community attribute sent to this neighbor
4 accepted prefixes
4 announced prefixes

For address family: VPNv4 Unicast BGP table version 4, neighbor version 4
Index 2, Offset 0, Mask 0x4
AIGP is enabled
Route-Reflector Client
Community attribute sent to this neighbor (both)
Large Community attribute sent to this neighbor
4 accepted prefixes
4 announced prefixes

For address family: IPv4 Flow Specification BGP table version 5, neighbor version 5
Index 2, Offset 0, Mask 0x4
Route-Reflector Client
Community attribute sent to this neighbor (both)
Large Community attribute sent to this neighbor
3 accepted prefixes

BGP Flowspec Support for IPv4

3 announced prefixes

For address family: VPNv4 Flow Specification BGP table version 3, neighbor version 3
Index 2, Offset 0, Mask 0x4
Route-Reflector Client
Community attribute sent to this neighbor (both)
Large Community attribute sent to this neighbor
2 accepted prefixes
2 announced prefixes

Connections established 1; dropped 0
Local host: 20.1.1.2, Local port: 43160
Foreign host: 20.1.1.1, Foreign port: 179
Nexthop: 20.1.1.2
Nexthop global: ::
Nexthop local: ::
BGP connection: non shared network
Last Reset: 03:10:22, due to BGP Notification received
Notification Error Message: (OPEN Message Error/Bad BGP Identifier. Reason:)

RR2#
RR2#
RR2#sh ip bgp ipv4 flowspec summary
BGP router identifier 2.2.2.2, local AS number 65000
BGP table version is 5
3 BGP AS-PATH entries
0 BGP community entries

Neighbor PfxRcd	V	AS	MsgRcv	MsgSen	TblVer	InQ	OutQ	Up/Down	State/
11.1.1.1 3	4	65000	458	459	5	0	0	03:09:54	
20.1.1.1 3	4	65000	459	457	5	0	0	03:10:25	

Total number of neighbors 2

Total number of Established sessions 2

RR2#
RR2#sh ip bgp ipv4 flowspec
BGP table version is 5, local router ID is 2.2.2.2
Status codes: s suppressed, d damped, h history, a add-path, * valid, > best, i -
internal,
l - labeled, S Stale
Origin codes: i - IGP, e - EGP, ? - incomplete

Network	Next Hop	Metric	LocPrf	Weight	Path
*>i flowspec/216	20.1.1.1	0	100	0	100 i
*>i flowspec/336	11.1.1.1	0	100	0	200 i
*>i flowspec/264	11.1.1.1	0	100	0	i

```
*>i flowspec/392      20.1.1.1      0      100      0      i
*>i flowspec/176      20.1.1.1      0      100      0      100 i
*>i flowspec/288      11.1.1.1      0      100      0      200 i
```

Total number of prefixes 6

RR2#

RR2#

RR2#sh ip bgp ipv4 flowspec detail

BGP table version is 5, local router ID is 2.2.2.2

Status codes: s suppressed, d damped, h history, a add-path, * valid, > best, i - internal,

l - labeled, S Stale

Origin codes: i - IGP, e - EGP, ? - incomplete

Network	Next Hop	Metric	LocPrf	Weight	Path
*>i flowspec/216	20.1.1.1	0	100	0	100 i

FlowSpec:

destination ip address: 10.1.1.0/24

source ip address: 10.1.1.0/24

IP protocol:

e:1 a:0 len:0 lt:0 gt:0 eq:1 data:44

TCP/UDP destination port:

e:0 a:0 len:1 lt:0 gt:1 eq:1 data:44

e:1 a:1 len:1 lt:1 gt:0 eq:1 data:144

TCP/UDP source port:

e:0 a:0 len:1 lt:0 gt:1 eq:1 data:22

e:1 a:1 len:1 lt:1 gt:0 eq:1 data:122

FlowSpec Actions:

traffic_rate: 21000 bps

```
*>i flowspec/336      11.1.1.1      0      100      0      200 i
```

FlowSpec:

destination ip address: 30.1.1.0/24

source ip address: 30.1.1.0/24

IP protocol:

e:1 a:0 len:0 lt:0 gt:0 eq:1 data:11

TCP/UDP port:

e:0 a:0 len:1 lt:0 gt:1 eq:1 data:100

e:1 a:1 len:1 lt:1 gt:0 eq:1 data:200

TCP/UDP destination port:

e:0 a:0 len:1 lt:0 gt:1 eq:1 data:300

e:1 a:1 len:1 lt:1 gt:0 eq:1 data:400

TCP/UDP source port:

e:0 a:0 len:1 lt:0 gt:1 eq:1 data:500

e:1 a:1 len:1 lt:1 gt:0 eq:1 data:600

TCP flags:

e:0 a:0 len:0 not:0 m:1 data:0x21

e:1 a:1 len:0 not:1 m:0 data:0x1e

BGP Flowspec Support for IPv4

DSCP:

e:1 a:0 len:0 lt:0 gt:0 eq:1 data:0x21

FlowSpec Actions:

traffic_rate: 500000 bps

traffic marking DSCP: 1e

*>i flowspec/264 11.1.1.1 0 100 0 i

FlowSpec:

destination ip address: 1.1.1.1/32

source ip address: 3.3.3.3/32

TCP/UDP port:

e:0 a:0 len:1 lt:0 gt:1 eq:1 data:111

e:1 a:1 len:1 lt:1 gt:0 eq:1 data:222

TCP/UDP destination port:

e:0 a:0 len:1 lt:0 gt:1 eq:1 data:300

e:1 a:1 len:1 lt:1 gt:0 eq:1 data:399

TCP/UDP source port:

e:0 a:0 len:1 lt:0 gt:1 eq:1 data:230

e:1 a:1 len:1 lt:1 gt:0 eq:1 data:299

FlowSpec Actions:

traffic_rate: 1111111 bps

*>i flowspec/392 20.1.1.1 0 100 0 i

FlowSpec:

destination ip address: 3.3.3.3/32

source ip address: 1.1.1.1/32

IP protocol:

e:1 a:0 len:0 lt:0 gt:0 eq:1 data:78

TCP/UDP port:

e:0 a:0 len:1 lt:0 gt:1 eq:1 data:101

e:1 a:1 len:1 lt:1 gt:0 eq:1 data:201

TCP/UDP destination port:

e:0 a:0 len:1 lt:0 gt:1 eq:1 data:400

e:1 a:1 len:1 lt:1 gt:0 eq:1 data:499

TCP/UDP source port:

e:0 a:0 len:1 lt:0 gt:1 eq:1 data:330

e:1 a:1 len:1 lt:1 gt:0 eq:1 data:399

ICMP code:

e:1 a:0 len:0 lt:0 gt:0 eq:1 data:10

Packet length:

e:0 a:0 len:1 lt:0 gt:1 eq:1 data:22

e:1 a:1 len:1 lt:1 gt:0 eq:1 data:222

DSCP:

e:1 a:0 len:0 lt:0 gt:0 eq:1 data:0x10

FlowSpec Actions:

```
traffic_rate: 1000011 bps
traffic marking DSCP: e
```

```
*>i flowspec/176      20.1.1.1          0          100         0    100 i
```

FlowSpec:

```
destination ip address: 4.4.4.4/32
source ip address: 4.4.4.4/32
IP protocol:
  e:1 a:0 len:0 lt:0 gt:0 eq:1 data:12
TCP/UDP port:
  e:0 a:0 len:1 lt:0 gt:1 eq:1 data:333
  e:1 a:1 len:1 lt:1 gt:0 eq:1 data:444
```

FlowSpec Actions:

```
traffic_rate: 4444444 bps
```

```
*>i flowspec/288      11.1.1.1          0          100         0    200 i
```

FlowSpec:

```
destination ip address: 5.5.5.5/32
source ip address: 5.5.5.5/32
IP protocol:
  e:1 a:0 len:0 lt:0 gt:0 eq:1 data:121
TCP/UDP port:
  e:0 a:0 len:1 lt:0 gt:1 eq:1 data:777
  e:1 a:1 len:1 lt:1 gt:0 eq:1 data:888
TCP/UDP destination port:
  e:0 a:0 len:1 lt:0 gt:1 eq:1 data:1300
  e:1 a:1 len:1 lt:1 gt:0 eq:1 data:1400
TCP/UDP source port:
  e:0 a:0 len:1 lt:0 gt:1 eq:1 data:1001
  e:1 a:1 len:1 lt:1 gt:0 eq:1 data:1200
```

FlowSpec Actions:

```
traffic_rate: 100000 bps
```

Total number of prefixes 6

RR2#

RR2#

RR2#sh ip bgp ipv4 flowspec vrf all

BGP table version is 5, local router ID is 2.2.2.2

Status codes: s suppressed, d damped, h history, a add-path, * valid, > best, i - internal,

l - labeled, S Stale

Origin codes: i - IGP, e - EGP, ? - incomplete

Network	Next Hop	Metric	LocPrf	Weight	Path
*>i flowspec/216	20.1.1.1	0	100	0	100 i
*>i flowspec/336	11.1.1.1	0	100	0	200 i

BGP Flowspec Support for IPv4

```
*>i flowspec/264      11.1.1.1          0          100         0          i
*>i flowspec/392      20.1.1.1          0          100         0          i
*>i flowspec/176      20.1.1.1          0          100         0          100 i
*>i flowspec/288      11.1.1.1          0          100         0          200 i
```

Total number of prefixes 6

RR2#

RR2#sh ip bgp ipv4 flowspec vrf all detail

BGP table version is 5, local router ID is 2.2.2.2

Status codes: s suppressed, d damped, h history, a add-path, * valid, > best, i - internal,

l - labeled, S Stale

Origin codes: i - IGP, e - EGP, ? - incomplete

Network	Next Hop	Metric	LocPrf	Weight	Path
*>i flowspec/216	20.1.1.1	0	100	0	100 i

FlowSpec:

destination ip address: 10.1.1.0/24

source ip address: 10.1.1.0/24

IP protocol:

e:1 a:0 len:0 lt:0 gt:0 eq:1 data:44

TCP/UDP destination port:

e:0 a:0 len:1 lt:0 gt:1 eq:1 data:44

e:1 a:1 len:1 lt:1 gt:0 eq:1 data:144

TCP/UDP source port:

e:0 a:0 len:1 lt:0 gt:1 eq:1 data:22

e:1 a:1 len:1 lt:1 gt:0 eq:1 data:122

FlowSpec Actions:

traffic_rate: 21000 bps

```
*>i flowspec/336      11.1.1.1          0          100         0          200 i
```

FlowSpec:

destination ip address: 30.1.1.0/24

source ip address: 30.1.1.0/24

IP protocol:

e:1 a:0 len:0 lt:0 gt:0 eq:1 data:11

TCP/UDP port:

e:0 a:0 len:1 lt:0 gt:1 eq:1 data:100

e:1 a:1 len:1 lt:1 gt:0 eq:1 data:200

TCP/UDP destination port:

e:0 a:0 len:1 lt:0 gt:1 eq:1 data:300

e:1 a:1 len:1 lt:1 gt:0 eq:1 data:400

TCP/UDP source port:

e:0 a:0 len:1 lt:0 gt:1 eq:1 data:500

e:1 a:1 len:1 lt:1 gt:0 eq:1 data:600

TCP flags:

e:0 a:0 len:0 not:0 m:1 data:0x21

e:1 a:1 len:0 not:1 m:0 data:0x1e

DSCP:
e:1 a:0 len:0 lt:0 gt:0 eq:1 data:0x21

FlowSpec Actions:
traffic_rate: 500000 bps
traffic marking DSCP: 1e

*>i flowspec/264 11.1.1.1 0 100 0 i

FlowSpec:
destination ip address: 1.1.1.1/32
source ip address: 3.3.3.3/32
TCP/UDP port:
e:0 a:0 len:1 lt:0 gt:1 eq:1 data:111
e:1 a:1 len:1 lt:1 gt:0 eq:1 data:222
TCP/UDP destination port:
e:0 a:0 len:1 lt:0 gt:1 eq:1 data:300
e:1 a:1 len:1 lt:1 gt:0 eq:1 data:399
TCP/UDP source port:
e:0 a:0 len:1 lt:0 gt:1 eq:1 data:230
e:1 a:1 len:1 lt:1 gt:0 eq:1 data:299

FlowSpec Actions:
traffic_rate: 1111111 bps

*>i flowspec/392 20.1.1.1 0 100 0 i

FlowSpec:
destination ip address: 3.3.3.3/32
source ip address: 1.1.1.1/32
IP protocol:
e:1 a:0 len:0 lt:0 gt:0 eq:1 data:78
TCP/UDP port:
e:0 a:0 len:1 lt:0 gt:1 eq:1 data:101
e:1 a:1 len:1 lt:1 gt:0 eq:1 data:201
TCP/UDP destination port:
e:0 a:0 len:1 lt:0 gt:1 eq:1 data:400
e:1 a:1 len:1 lt:1 gt:0 eq:1 data:499
TCP/UDP source port:
e:0 a:0 len:1 lt:0 gt:1 eq:1 data:330
e:1 a:1 len:1 lt:1 gt:0 eq:1 data:399
ICMP code:
e:1 a:0 len:0 lt:0 gt:0 eq:1 data:10
Packet length:
e:0 a:0 len:1 lt:0 gt:1 eq:1 data:22
e:1 a:1 len:1 lt:1 gt:0 eq:1 data:222
DSCP:
e:1 a:0 len:0 lt:0 gt:0 eq:1 data:0x10

FlowSpec Actions:

BGP Flowspec Support for IPv4

```
traffic_rate: 1000011 bps
traffic marking DSCP: e
```

```
*>i flowspec/176      20.1.1.1          0          100        0   100 i
```

FlowSpec:

```
destination ip address: 4.4.4.4/32
source ip address: 4.4.4.4/32
IP protocol:
  e:1 a:0 len:0 lt:0 gt:0 eq:1 data:12
TCP/UDP port:
  e:0 a:0 len:1 lt:0 gt:1 eq:1 data:333
  e:1 a:1 len:1 lt:1 gt:0 eq:1 data:444
```

FlowSpec Actions:

```
traffic_rate: 4444444 bps
```

```
*>i flowspec/288      11.1.1.1          0          100        0   200 i
```

FlowSpec:

```
destination ip address: 5.5.5.5/32
source ip address: 5.5.5.5/32
IP protocol:
  e:1 a:0 len:0 lt:0 gt:0 eq:1 data:121
TCP/UDP port:
  e:0 a:0 len:1 lt:0 gt:1 eq:1 data:777
  e:1 a:1 len:1 lt:1 gt:0 eq:1 data:888
TCP/UDP destination port:
  e:0 a:0 len:1 lt:0 gt:1 eq:1 data:1300
  e:1 a:1 len:1 lt:1 gt:0 eq:1 data:1400
TCP/UDP source port:
  e:0 a:0 len:1 lt:0 gt:1 eq:1 data:1001
  e:1 a:1 len:1 lt:1 gt:0 eq:1 data:1200
```

FlowSpec Actions:

```
traffic_rate: 100000 bps
```

Total number of prefixes 6

RR2#

RR2#

RR2#sh ip bgp vpnv4 all

Status codes: s suppressed, d damped, h history, a add-path, * valid, > best, i - internal, l - labeled

S Stale

Origin codes: i - IGP, e - EGP, ? - incomplete

Network	Next Hop	Metric	LocPrf	Weight	Path
Route Distinguisher: 100:1					
*>i 4.4.4.4/32	20.1.1.1	0	100	0	100 ?
*>i 5.5.5.5/32	11.1.1.1	0	100	0	200 ?

```
*>i 10.1.1.0/24      20.1.1.1      0      100      0 100 ?
*>i 30.1.1.0/24      11.1.1.1      0      100      0 200 ?
*>i 55.1.1.0/24      11.1.1.1      0      100      0  ?
*>i 66.1.1.0/24      20.1.1.1      0      100      0  ?
*>i 100.1.1.0/24     20.1.1.1      0      100      0 100 ?
*>i 200.1.1.0        11.1.1.1      0      100      0 200 ?
```

Announced routes count = 0
Accepted routes count = 8

RR2#

RR2#sh ip bgp vpnv4 flowspec summary

BGP router identifier 2.2.2.2, local AS number 65000

BGP table version is 3

3 BGP AS-PATH entries

0 BGP community entries

Neighbor PfxRcd	V	AS	MsgRcv	MsgSen	TblVer	InQ	OutQ	Up/Down	State/
11.1.1.1 2	4	65000	460	460	3	0	0	03:10:38	
20.1.1.1 2	4	65000	460	459	3	0	0	03:11:09	

Total number of neighbors 2

Total number of Established sessions 2

RR2#

PE2

PE2#sh clns neighbors

Total number of L1 adjacencies: 2

Total number of L2 adjacencies: 2

Total number of adjacencies: 4

Tag 1: VRF : default

System Id	Interface	SNPA	State	Holdtime	Type	Protocol
RR2	ce43	3417.ebe4.af2c	Up	27	L1	IS-IS
			Up	27	L2	IS-IS
RR1	ce4	5c07.5871.205c	Up	8	L1	IS-IS
			Up	8	L2	IS-IS

PE2#

PE2#sh ip bgp

BGP table version is 4, local router ID is 3.3.3.3

Status codes: s suppressed, d damped, h history, a add-path, * valid, > best, i - internal,

l - labeled, S Stale

Origin codes: i - IGP, e - EGP, ? - incomplete

Network	Next Hop	Metric	LocPrf	Weight	Path
*>i 4.4.4.4/32	1.1.1.1	0	100	0	100 ?
* i	20.1.1.1	0	100	0	100 ?

BGP Flowspec Support for IPv4

```
*> 5.5.5.5/32      30.1.1.1      0      100      0      200 ?
*>i 10.1.1.0/24    1.1.1.1      0      100      0      100 ?
* i                20.1.1.1      0      100      0      100 ?
*> 30.1.1.0/24    30.1.1.1      0      100      0      200 ?
*> 55.1.1.0/24    30.1.1.1      0      100      0      200 ?
*>i 66.1.1.0/24    1.1.1.1      0      100      0      100 ?
* i                20.1.1.1      0      100      0      100 ?
*>i 100.1.1.0/24  1.1.1.1      0      100      0      100 ?
* i                20.1.1.1      0      100      0      100 ?
*> 200.1.1.0      30.1.1.1      0      100      0      200 ?
```

Total number of prefixes 8

PE2#

PE2#sh ip bgp neighbors

BGP neighbor is 6.6.6.6, remote AS 65000, local AS 65000, internal link

BGP version 4, local router ID 3.3.3.3, remote router ID 6.6.6.6

BGP state = Established, up for 03:12:03

Last read 00:00:28, hold time is 90, keepalive interval is 30 seconds

Neighbor capabilities:

Route refresh: advertised and received (old and new)

Address family IPv4 Unicast: advertised and received

Address family VPNv4 Unicast: advertised and received

Address family IPv4 Flow Specification: advertised and received

Address family VPNv4 Flow Specification: advertised and received

Received 459 messages, 0 notifications, 0 in queue

Sent 459 messages, 0 notifications, 0 in queue

Route refresh request: received 0, sent 0

Minimum time between advertisement runs is 5 seconds

Update source is lo

For address family: IPv4 Unicast BGP table version 4, neighbor version 4

Index 1, Offset 0, Mask 0x2

AIGP is enabled

NEXT_HOP is always this router

Community attribute sent to this neighbor (both)

Large Community attribute sent to this neighbor

4 accepted prefixes

4 announced prefixes

For address family: VPNv4 Unicast BGP table version 3, neighbor version 3

Index 1, Offset 0, Mask 0x2

AIGP is enabled

NEXT_HOP is always this router

Community attribute sent to this neighbor (both)

Large Community attribute sent to this neighbor

4 accepted prefixes

4 announced prefixes

For address family: IPv4 Flow Specification BGP table version 6, neighbor version 6
Index 1, Offset 0, Mask 0x2
Community attribute sent to this neighbor (both)
Large Community attribute sent to this neighbor
3 accepted prefixes
3 announced prefixes

For address family: VPNv4 Flow Specification BGP table version 3, neighbor version 3
Index 1, Offset 0, Mask 0x2
Community attribute sent to this neighbor (both)
Large Community attribute sent to this neighbor
2 accepted prefixes
2 announced prefixes

Connections established 1; dropped 0
Local host: 3.3.3.3, Local port: 179
Foreign host: 6.6.6.6, Foreign port: 35405
Next hop: 3.3.3.3
Next hop global: ::
Next hop local: ::
BGP connection: non shared network

BGP neighbor is 11.1.1.2, remote AS 65000, local AS 65000, internal link
BGP version 4, local router ID 3.3.3.3, remote router ID 2.2.2.2
BGP state = Established, up for 03:12:52
Last read 00:00:26, hold time is 90, keepalive interval is 30 seconds
Neighbor capabilities:
Route refresh: advertised and received (old and new)
Address family IPv4 Unicast: advertised and received
Address family VPNv4 Unicast: advertised and received
Address family IPv4 Flow Specification: advertised and received
Address family VPNv4 Flow Specification: advertised and received
Received 462 messages, 1 notifications, 0 in queue
Sent 467 messages, 0 notifications, 0 in queue
Route refresh request: received 0, sent 0
Minimum time between advertisement runs is 5 seconds

For address family: IPv4 Unicast BGP table version 4, neighbor version 4
Index 2, Offset 0, Mask 0x4
AIGP is enabled
NEXT_HOP is always this router
Community attribute sent to this neighbor (both)
Large Community attribute sent to this neighbor
4 accepted prefixes
4 announced prefixes

For address family: VPNv4 Unicast BGP table version 3, neighbor version 3
Index 2, Offset 0, Mask 0x4

BGP Flowspec Support for IPv4

AIGP is enabled
NEXT_HOP is always this router
Community attribute sent to this neighbor (both)
Large Community attribute sent to this neighbor
4 accepted prefixes
4 announced prefixes

For address family: IPv4 Flow Specification BGP table version 6, neighbor version 6
Index 2, Offset 0, Mask 0x4
Community attribute sent to this neighbor (both)
Large Community attribute sent to this neighbor
3 accepted prefixes
3 announced prefixes

For address family: VPNv4 Flow Specification BGP table version 3, neighbor version 3
Index 2, Offset 0, Mask 0x4
Community attribute sent to this neighbor (both)
Large Community attribute sent to this neighbor
2 accepted prefixes
2 announced prefixes

Connections established 1; dropped 0
Local host: 11.1.1.1, Local port: 41446
Foreign host: 11.1.1.2, Foreign port: 179
Nexthop: 11.1.1.1
Nexthop global: ::
Nexthop local: ::
BGP connection: non shared network
Last Reset: 03:12:57, due to BGP Notification received
Notification Error Message: (OPEN Message Error/Bad BGP Identifier. Reason:)

BGP neighbor is 30.1.1.1, remote AS 200, local AS 65000, external link
BGP version 4, local router ID 3.3.3.3, remote router ID 5.5.5.5
BGP state = Established, up for 03:12:27
Last read 00:00:05, hold time is 90, keepalive interval is 30 seconds
Neighbor capabilities:
Route refresh: advertised and received (old and new)
Address family IPv4 Unicast: advertised and received
Address family IPv4 Flow Specification: advertised and received
Received 456 messages, 0 notifications, 0 in queue
Sent 463 messages, 1 notifications, 0 in queue
Route refresh request: received 0, sent 0
Minimum time between advertisement runs is 30 seconds

For address family: IPv4 Unicast BGP table version 4, neighbor version 4
Index 3, Offset 0, Mask 0x8
Community attribute sent to this neighbor (both)
Large Community attribute sent to this neighbor

4 accepted prefixes
4 announced prefixes

For address family: IPv4 Flow Specification BGP table version 6, neighbor version 6
Index 3, Offset 0, Mask 0x8
Community attribute sent to this neighbor (both)
Large Community attribute sent to this neighbor
2 accepted prefixes
4 announced prefixes

Connections established 1; dropped 0
Local host: 30.1.1.2, Local port: 179
Foreign host: 30.1.1.1, Foreign port: 41276
Nexthop: 30.1.1.2
Nexthop global: ::
Nexthop local: ::
BGP connection: non shared network
Last Reset: 03:12:27, due to OPEN Message Error (Notification sent)
Notification Error Message: (OPEN Message Error/Bad BGP Identifier. Reason:)

BGP neighbor is 55.1.1.2, vrf vrf100, remote AS 200, local AS 65000, external link
BGP version 4, local router ID 55.1.1.1, remote router ID 5.5.5.5
BGP state = Established, up for 03:12:27
Last read 00:00:05, hold time is 90, keepalive interval is 30 seconds
Neighbor capabilities:
Route refresh: advertised and received (old and new)
Address family IPv4 Unicast: advertised and received
Address family IPv4 Flow Specification: advertised and received
Received 460 messages, 0 notifications, 0 in queue
Sent 460 messages, 1 notifications, 0 in queue
Route refresh request: received 0, sent 0
Minimum time between advertisement runs is 30 seconds

For address family: IPv4 Unicast BGP table version 1, neighbor version 1
Index 1, Offset 0, Mask 0x2
Community attribute sent to this neighbor (standard)
Large Community attribute sent to this neighbor
4 accepted prefixes
5 announced prefixes

For address family: IPv4 Flow Specification BGP table version 1, neighbor version 1
Index 1, Offset 0, Mask 0x2
Community attribute sent to this neighbor (both)
Large Community attribute sent to this neighbor
2 accepted prefixes
2 announced prefixes

Connections established 1; dropped 0

BGP Flowspec Support for IPv4

Local host: 55.1.1.1, Local port: 40660
Foreign host: 55.1.1.2, Foreign port: 179
Nexthop: 55.1.1.1
Nexthop global: ::
Nexthop local: ::
BGP connection: non shared network
Last Reset: 03:12:32, due to OPEN Message Error (Notification sent)
Notification Error Message: (OPEN Message Error/Bad BGP Identifier. Reason:)

PE2#
PE2#sh ip bgp ipv4 flowspec summary
BGP router identifier 3.3.3.3, local AS number 65000
BGP table version is 6
3 BGP AS-PATH entries
0 BGP community entries

Neighbor PfxRcd	V	AS	MsgRcv	MsgSen	TblVer	InQ	OutQ	Up/Down	State/
6.6.6.6 3	4	65000	460	459	6	0	0	03:12:13	
11.1.1.2 3	4	65000	464	468	6	0	0	03:13:02	
30.1.1.1 2	4	200	456	464	6	0	0	03:12:37	

Total number of neighbors 3

Total number of Established sessions 3
BGP router identifier 55.1.1.1, local AS number 65000
BGP VRF vrf100 Route Distinguisher: 100:1
BGP table version is 1
3 BGP AS-PATH entries
0 BGP community entries

Neighbor PfxRcd	V	AS	MsgRcv	MsgSen	TblVer	InQ	OutQ	Up/Down	State/
55.1.1.2 2	4	200	460	461	1	0	0	03:12:37	

Total number of neighbors 1

Total number of Established sessions 1

PE2#
PE2#sh ip bgp ipv4 flowspec
BGP table version is 6, local router ID is 3.3.3.3
Status codes: s suppressed, d damped, h history, a add-path, * valid, > best, i -
internal,
 l - labeled, S Stale
Origin codes: i - IGP, e - EGP, ? - incomplete

Network	Next Hop	Metric	LocPrf	Weight	Path
*>i flowspec/216	6.6.6.6	0	100	0	100 i

```

* i          11.1.1.2          0          100          0 100 i
*>  flowspec/336  30.1.1.1          0          100          0 200 i
*>  flowspec/264  0.0.0.0            0          100          32768 i
*>i flowspec/392  6.6.6.6            0          100          0   i
* i          11.1.1.2          0          100          0   i
*>i flowspec/176  6.6.6.6            0          100          0 100 i
* i          11.1.1.2          0          100          0 100 i
*>  flowspec/288  30.1.1.1          0          100          0 200 i

```

Total number of prefixes 6

PE2#

PE2#sh ip bgp ipv4 flowspec detail

BGP table version is 6, local router ID is 3.3.3.3

Status codes: s suppressed, d damped, h history, a add-path, * valid, > best, i - internal,

l - labeled, S Stale

Origin codes: i - IGP, e - EGP, ? - incomplete

```

      Network          Next Hop          Metric      LocPrf      Weight Path
*>i  flowspec/216      6.6.6.6            0           100          0 100 i

```

FlowSpec:

destination ip address: 10.1.1.0/24

source ip address: 10.1.1.0/24

IP protocol:

e:1 a:0 len:0 lt:0 gt:0 eq:1 data:44

TCP/UDP destination port:

e:0 a:0 len:1 lt:0 gt:1 eq:1 data:44

e:1 a:1 len:1 lt:1 gt:0 eq:1 data:144

TCP/UDP source port:

e:0 a:0 len:1 lt:0 gt:1 eq:1 data:22

e:1 a:1 len:1 lt:1 gt:0 eq:1 data:122

FlowSpec Actions:

traffic_rate: 21000 bps

```

* i          11.1.1.2          0          100          0 100 i

```

FlowSpec Actions:

traffic_rate: 21000 bps

```

*>  flowspec/336  30.1.1.1          0          100          0 200 i

```

FlowSpec:

destination ip address: 30.1.1.0/24

source ip address: 30.1.1.0/24

IP protocol:

e:1 a:0 len:0 lt:0 gt:0 eq:1 data:11

TCP/UDP port:

e:0 a:0 len:1 lt:0 gt:1 eq:1 data:100

e:1 a:1 len:1 lt:1 gt:0 eq:1 data:200

TCP/UDP destination port:

BGP Flowspec Support for IPv4

```
e:0 a:0 len:1 lt:0 gt:1 eq:1 data:300
e:1 a:1 len:1 lt:1 gt:0 eq:1 data:400
TCP/UDP source port:
e:0 a:0 len:1 lt:0 gt:1 eq:1 data:500
e:1 a:1 len:1 lt:1 gt:0 eq:1 data:600
TCP flags:
e:0 a:0 len:0 not:0 m:1 data:0x21
e:1 a:1 len:0 not:1 m:0 data:0x1e
DSCP:
e:1 a:0 len:0 lt:0 gt:0 eq:1 data:0x21
```

FlowSpec Actions:

```
traffic_rate: 500000 bps
traffic marking DSCP: 1e
```

```
*> flowspec/264 0.0.0.0 0 100 32768 i
```

FlowSpec:

```
destination ip address: 1.1.1.1/32
source ip address: 3.3.3.3/32
TCP/UDP port:
e:0 a:0 len:1 lt:0 gt:1 eq:1 data:111
e:1 a:1 len:1 lt:1 gt:0 eq:1 data:222
TCP/UDP destination port:
e:0 a:0 len:1 lt:0 gt:1 eq:1 data:300
e:1 a:1 len:1 lt:1 gt:0 eq:1 data:399
TCP/UDP source port:
e:0 a:0 len:1 lt:0 gt:1 eq:1 data:230
e:1 a:1 len:1 lt:1 gt:0 eq:1 data:299
```

FlowSpec Actions:

```
traffic_rate: 1111111 bps
```

```
*>i flowspec/392 6.6.6.6 0 100 0 i
```

FlowSpec:

```
destination ip address: 3.3.3.3/32
source ip address: 1.1.1.1/32
IP protocol:
e:1 a:0 len:0 lt:0 gt:0 eq:1 data:78
TCP/UDP port:
e:0 a:0 len:1 lt:0 gt:1 eq:1 data:101
e:1 a:1 len:1 lt:1 gt:0 eq:1 data:201
TCP/UDP destination port:
e:0 a:0 len:1 lt:0 gt:1 eq:1 data:400
e:1 a:1 len:1 lt:1 gt:0 eq:1 data:499
TCP/UDP source port:
e:0 a:0 len:1 lt:0 gt:1 eq:1 data:330
e:1 a:1 len:1 lt:1 gt:0 eq:1 data:399
ICMP code:
```



```

    e:1 a:0 len:0 lt:0 gt:0 eq:1 data:10
Packet length:
    e:0 a:0 len:1 lt:0 gt:1 eq:1 data:22
    e:1 a:1 len:1 lt:1 gt:0 eq:1 data:222
DSCP:
    e:1 a:0 len:0 lt:0 gt:0 eq:1 data:0x10

```

```

FlowSpec Actions:
    traffic_rate: 1000011 bps
    traffic marking DSCP: e

```

```
* i          11.1.1.2          0          100          0          i
```

```

FlowSpec Actions:
    traffic_rate: 1000011 bps
    traffic marking DSCP: e

```

```
*>i flowspec/176      6.6.6.6          0          100          0          100 i
```

```

FlowSpec:
    destination ip address: 4.4.4.4/32
    source ip address: 4.4.4.4/32
    IP protocol:
        e:1 a:0 len:0 lt:0 gt:0 eq:1 data:12
    TCP/UDP port:
        e:0 a:0 len:1 lt:0 gt:1 eq:1 data:333
        e:1 a:1 len:1 lt:1 gt:0 eq:1 data:444

```

```

FlowSpec Actions:
    traffic_rate: 4444444 bps

```

```
* i          11.1.1.2          0          100          0          100 i
```

```

FlowSpec Actions:
    traffic_rate: 4444444 bps

```

```
*> flowspec/288      30.1.1.1          0          100          0          200 i
```

```

FlowSpec:
    destination ip address: 5.5.5.5/32
    source ip address: 5.5.5.5/32
    IP protocol:
        e:1 a:0 len:0 lt:0 gt:0 eq:1 data:121
    TCP/UDP port:
        e:0 a:0 len:1 lt:0 gt:1 eq:1 data:777
        e:1 a:1 len:1 lt:1 gt:0 eq:1 data:888
    TCP/UDP destination port:
        e:0 a:0 len:1 lt:0 gt:1 eq:1 data:1300
        e:1 a:1 len:1 lt:1 gt:0 eq:1 data:1400
    TCP/UDP source port:
        e:0 a:0 len:1 lt:0 gt:1 eq:1 data:1001
        e:1 a:1 len:1 lt:1 gt:0 eq:1 data:1200

```

BGP Flowspec Support for IPv4

FlowSpec Actions:

traffic_rate: 100000 bps

Total number of prefixes 6

PE2#

PE2#

PE2#sh ip bgp ipv4 flowspec vrf all

BGP table version is 1, local router ID is 55.1.1.1

Status codes: s suppressed, d damped, h history, a add-path, * valid, > best, i - internal,

l - labeled, S Stale

Origin codes: i - IGP, e - EGP, ? - incomplete

Network	Next Hop	Metric	LocPrf	Weight	Path
BGP Route Table for VRF vrf100					
*>i flowspec/216	6.6.6.6	0	100	0	100 i
*> flowspec/336	55.1.1.2	0	100	0	200 i
*>i flowspec/176	6.6.6.6	0	100	0	100 i
*> flowspec/288	55.1.1.2	0	100	0	200 i

Total number of prefixes 4

*>i flowspec/216	6.6.6.6	0	100	0	100 i
* i	11.1.1.2	0	100	0	100 i
*> flowspec/336	30.1.1.1	0	100	0	200 i
*> flowspec/264	0.0.0.0	0	100	32768	i
*>i flowspec/392	6.6.6.6	0	100	0	i
* i	11.1.1.2	0	100	0	i
*>i flowspec/176	6.6.6.6	0	100	0	100 i
* i	11.1.1.2	0	100	0	100 i
*> flowspec/288	30.1.1.1	0	100	0	200 i

Total number of prefixes 6

PE2#

PE2#sh ip bgp ipv4 flowspec vrf all detail

BGP table version is 1, local router ID is 55.1.1.1

Status codes: s suppressed, d damped, h history, a add-path, * valid, > best, i - internal,

l - labeled, S Stale

Origin codes: i - IGP, e - EGP, ? - incomplete

Network	Next Hop	Metric	LocPrf	Weight	Path
BGP Route Table for VRF vrf100					
*>i flowspec/216	6.6.6.6	0	100	0	100 i

FlowSpec:

destination ip address: 10.1.1.0/24

source ip address: 10.1.1.0/24

```

IP protocol:
  e:1 a:0 len:0 lt:0 gt:0 eq:1 data:44
TCP/UDP destination port:
  e:0 a:0 len:1 lt:0 gt:1 eq:1 data:44
  e:1 a:1 len:1 lt:1 gt:0 eq:1 data:144
TCP/UDP source port:
  e:0 a:0 len:1 lt:0 gt:1 eq:1 data:22
  e:1 a:1 len:1 lt:1 gt:0 eq:1 data:122

```

```

FlowSpec Actions:
  traffic_rate: 21000 bps

```

```
*> flowspec/336      55.1.1.2          0          100         0   200 i
```

```

FlowSpec:
  destination ip address: 30.1.1.0/24
  source ip address: 30.1.1.0/24
  IP protocol:
    e:1 a:0 len:0 lt:0 gt:0 eq:1 data:11
  TCP/UDP port:
    e:0 a:0 len:1 lt:0 gt:1 eq:1 data:100
    e:1 a:1 len:1 lt:1 gt:0 eq:1 data:200
  TCP/UDP destination port:
    e:0 a:0 len:1 lt:0 gt:1 eq:1 data:300
    e:1 a:1 len:1 lt:1 gt:0 eq:1 data:400
  TCP/UDP source port:
    e:0 a:0 len:1 lt:0 gt:1 eq:1 data:500
    e:1 a:1 len:1 lt:1 gt:0 eq:1 data:600
  TCP flags:
    e:0 a:0 len:0 not:0 m:1 data:0x21
    e:1 a:1 len:0 not:1 m:0 data:0x1e
  DSCP:
    e:1 a:0 len:0 lt:0 gt:0 eq:1 data:0x21

```

```

FlowSpec Actions:
  traffic_rate: 500000 bps
  traffic marking DSCP: 1e

```

```
*>i flowspec/176     6.6.6.6          0          100         0   100 i
```

```

FlowSpec:
  destination ip address: 4.4.4.4/32
  source ip address: 4.4.4.4/32
  IP protocol:
    e:1 a:0 len:0 lt:0 gt:0 eq:1 data:12
  TCP/UDP port:
    e:0 a:0 len:1 lt:0 gt:1 eq:1 data:333
    e:1 a:1 len:1 lt:1 gt:0 eq:1 data:444

```

```

FlowSpec Actions:

```

BGP Flowspec Support for IPv4

traffic_rate: 4444444 bps

*> flowspec/288 55.1.1.2 0 100 0 200 i

FlowSpec:

destination ip address: 5.5.5.5/32

source ip address: 5.5.5.5/32

IP protocol:

e:1 a:0 len:0 lt:0 gt:0 eq:1 data:121

TCP/UDP port:

e:0 a:0 len:1 lt:0 gt:1 eq:1 data:777

e:1 a:1 len:1 lt:1 gt:0 eq:1 data:888

TCP/UDP destination port:

e:0 a:0 len:1 lt:0 gt:1 eq:1 data:1300

e:1 a:1 len:1 lt:1 gt:0 eq:1 data:1400

TCP/UDP source port:

e:0 a:0 len:1 lt:0 gt:1 eq:1 data:1001

e:1 a:1 len:1 lt:1 gt:0 eq:1 data:1200

FlowSpec Actions:

traffic_rate: 100000 bps

Total number of prefixes 4

*>i flowspec/216 6.6.6.6 0 100 0 100 i

FlowSpec:

destination ip address: 10.1.1.0/24

source ip address: 10.1.1.0/24

IP protocol:

e:1 a:0 len:0 lt:0 gt:0 eq:1 data:44

TCP/UDP destination port:

e:0 a:0 len:1 lt:0 gt:1 eq:1 data:44

e:1 a:1 len:1 lt:1 gt:0 eq:1 data:144

TCP/UDP source port:

e:0 a:0 len:1 lt:0 gt:1 eq:1 data:22

e:1 a:1 len:1 lt:1 gt:0 eq:1 data:122

FlowSpec Actions:

traffic_rate: 21000 bps

* i 11.1.1.2 0 100 0 100 i

FlowSpec Actions:

traffic_rate: 21000 bps

*> flowspec/336 30.1.1.1 0 100 0 200 i

FlowSpec:

destination ip address: 30.1.1.0/24

source ip address: 30.1.1.0/24

```

IP protocol:
  e:1 a:0 len:0 lt:0 gt:0 eq:1 data:11
TCP/UDP port:
  e:0 a:0 len:1 lt:0 gt:1 eq:1 data:100
  e:1 a:1 len:1 lt:1 gt:0 eq:1 data:200
TCP/UDP destination port:
  e:0 a:0 len:1 lt:0 gt:1 eq:1 data:300
  e:1 a:1 len:1 lt:1 gt:0 eq:1 data:400
TCP/UDP source port:
  e:0 a:0 len:1 lt:0 gt:1 eq:1 data:500
  e:1 a:1 len:1 lt:1 gt:0 eq:1 data:600
TCP flags:
  e:0 a:0 len:0 not:0 m:1 data:0x21
  e:1 a:1 len:0 not:1 m:0 data:0x1e
DSCP:
  e:1 a:0 len:0 lt:0 gt:0 eq:1 data:0x21

```

FlowSpec Actions:

```

traffic_rate: 500000 bps
traffic marking DSCP: 1e

```

```
*> flowspec/264      0.0.0.0          0          100          32768 i
```

FlowSpec:

```

destination ip address: 1.1.1.1/32
source ip address: 3.3.3.3/32
TCP/UDP port:
  e:0 a:0 len:1 lt:0 gt:1 eq:1 data:111
  e:1 a:1 len:1 lt:1 gt:0 eq:1 data:222
TCP/UDP destination port:
  e:0 a:0 len:1 lt:0 gt:1 eq:1 data:300
  e:1 a:1 len:1 lt:1 gt:0 eq:1 data:399
TCP/UDP source port:
  e:0 a:0 len:1 lt:0 gt:1 eq:1 data:230
  e:1 a:1 len:1 lt:1 gt:0 eq:1 data:299

```

FlowSpec Actions:

```

traffic_rate: 1111111 bps

```

```
*>i flowspec/392      6.6.6.6          0          100          0          i
```

FlowSpec:

```

destination ip address: 3.3.3.3/32
source ip address: 1.1.1.1/32
IP protocol:
  e:1 a:0 len:0 lt:0 gt:0 eq:1 data:78
TCP/UDP port:
  e:0 a:0 len:1 lt:0 gt:1 eq:1 data:101
  e:1 a:1 len:1 lt:1 gt:0 eq:1 data:201
TCP/UDP destination port:

```

BGP Flowspec Support for IPv4

```
e:0 a:0 len:1 lt:0 gt:1 eq:1 data:400
e:1 a:1 len:1 lt:1 gt:0 eq:1 data:499
TCP/UDP source port:
e:0 a:0 len:1 lt:0 gt:1 eq:1 data:330
e:1 a:1 len:1 lt:1 gt:0 eq:1 data:399
ICMP code:
e:1 a:0 len:0 lt:0 gt:0 eq:1 data:10
Packet length:
e:0 a:0 len:1 lt:0 gt:1 eq:1 data:22
e:1 a:1 len:1 lt:1 gt:0 eq:1 data:222
DSCP:
e:1 a:0 len:0 lt:0 gt:0 eq:1 data:0x10
```

FlowSpec Actions:

```
traffic_rate: 1000011 bps
traffic marking DSCP: e
```

```
* i          11.1.1.2          0          100          0          i
```

FlowSpec Actions:

```
traffic_rate: 1000011 bps
traffic marking DSCP: e
```

```
*>i flowspec/176      6.6.6.6          0          100          0      100 i
```

FlowSpec:

```
destination ip address: 4.4.4.4/32
source ip address: 4.4.4.4/32
IP protocol:
e:1 a:0 len:0 lt:0 gt:0 eq:1 data:12
TCP/UDP port:
e:0 a:0 len:1 lt:0 gt:1 eq:1 data:333
e:1 a:1 len:1 lt:1 gt:0 eq:1 data:444
```

FlowSpec Actions:

```
traffic_rate: 4444444 bps
```

```
* i          11.1.1.2          0          100          0      100 i
```

FlowSpec Actions:

```
traffic_rate: 4444444 bps
```

```
*> flowspec/288      30.1.1.1          0          100          0      200 i
```

FlowSpec:

```
destination ip address: 5.5.5.5/32
source ip address: 5.5.5.5/32
IP protocol:
e:1 a:0 len:0 lt:0 gt:0 eq:1 data:121
TCP/UDP port:
e:0 a:0 len:1 lt:0 gt:1 eq:1 data:777
e:1 a:1 len:1 lt:1 gt:0 eq:1 data:888
```

```
TCP/UDP destination port:
  e:0 a:0 len:1 lt:0 gt:1 eq:1 data:1300
  e:1 a:1 len:1 lt:1 gt:0 eq:1 data:1400
TCP/UDP source port:
  e:0 a:0 len:1 lt:0 gt:1 eq:1 data:1001
  e:1 a:1 len:1 lt:1 gt:0 eq:1 data:1200
```

```
FlowSpec Actions:
  traffic_rate: 100000 bps
```

Total number of prefixes 6

PE2#

```
PE2#sh ip bgp vpnv4 flowspec summary
BGP router identifier 3.3.3.3, local AS number 65000
BGP table version is 3
3 BGP AS-PATH entries
0 BGP community entries
```

Neighbor PfxRcd	V	AS	MsgRcv	MsgSen	TblVer	InQ	OutQ	Up/Down	State/
6.6.6.6 2	4	65000	463	463	3	0	0	03:13:42	
11.1.1.2 2	4	65000	467	471	3	0	0	03:14:31	

Total number of neighbors 2

Total number of Established sessions 2

PE2#

```
PE2#sh ip bgp vpnv4 flowspec vrf vrf100
Status codes: s suppressed, d damped, h history, a add-path, * valid, > best, i -
internal, l - labeled
              S Stale
Origin codes: i - IGP, e - EGP, ? - incomplete
```

Network	Next Hop	Metric	LocPrf	Weight	Path
Route Distinguisher: 100:1 (Default for VRF vrf100)					
*>i flowspec/216	6.6.6.6	0	100	0	100 i
*> flowspec/336	55.1.1.2	0	100	0	200 i
*>i flowspec/176	6.6.6.6	0	100	0	100 i
*> flowspec/288	55.1.1.2	0	100	0	200 i

Announced routes count = 2

Accepted routes count = 2

PE2#

```
PE2#sh ip bgp vpnv4 flowspec vrf vrf100 detail
Status codes: s suppressed, d damped, h history, a add-path, * valid, > best, i -
internal, l - labeled
              S Stale
Origin codes: i - IGP, e - EGP, ? - incomplete
```

BGP Flowspec Support for IPv4

Network	Next Hop	Metric	LocPrf	Weight	Path
Route Distinguisher: 100:1 (Default for VRF vrf100)					
*>i flowspec/216	6.6.6.6	0	100	0	100 i

FlowSpec:

destination ip address: 10.1.1.0/24
source ip address: 10.1.1.0/24
IP protocol:
 e:1 a:0 len:0 lt:0 gt:0 eq:1 data:44
TCP/UDP destination port:
 e:0 a:0 len:1 lt:0 gt:1 eq:1 data:44
 e:1 a:1 len:1 lt:1 gt:0 eq:1 data:144
TCP/UDP source port:
 e:0 a:0 len:1 lt:0 gt:1 eq:1 data:22
 e:1 a:1 len:1 lt:1 gt:0 eq:1 data:122

FlowSpec Actions:

traffic_rate: 21000 bps

*>	flowspec/336	55.1.1.2	0	100	0	200 i
----	--------------	----------	---	-----	---	-------

FlowSpec:

destination ip address: 30.1.1.0/24
source ip address: 30.1.1.0/24
IP protocol:
 e:1 a:0 len:0 lt:0 gt:0 eq:1 data:11
TCP/UDP port:
 e:0 a:0 len:1 lt:0 gt:1 eq:1 data:100
 e:1 a:1 len:1 lt:1 gt:0 eq:1 data:200
TCP/UDP destination port:
 e:0 a:0 len:1 lt:0 gt:1 eq:1 data:300
 e:1 a:1 len:1 lt:1 gt:0 eq:1 data:400
TCP/UDP source port:
 e:0 a:0 len:1 lt:0 gt:1 eq:1 data:500
 e:1 a:1 len:1 lt:1 gt:0 eq:1 data:600
TCP flags:
 e:0 a:0 len:0 not:0 m:1 data:0x21
 e:1 a:1 len:0 not:1 m:0 data:0x1e
DSCP:
 e:1 a:0 len:0 lt:0 gt:0 eq:1 data:0x21

FlowSpec Actions:

traffic_rate: 500000 bps
traffic marking DSCP: 1e

*>i	flowspec/176	6.6.6.6	0	100	0	100 i
-----	--------------	---------	---	-----	---	-------

FlowSpec:

destination ip address: 4.4.4.4/32

```

source ip address: 4.4.4.4/32
IP protocol:
  e:1 a:0 len:0 lt:0 gt:0 eq:1 data:12
TCP/UDP port:
  e:0 a:0 len:1 lt:0 gt:1 eq:1 data:333
  e:1 a:1 len:1 lt:1 gt:0 eq:1 data:444

```

```

FlowSpec Actions:
  traffic_rate: 4444444 bps

```

```
*> flowspec/288      55.1.1.2          0          100         0    200 i
```

```

FlowSpec:
destination ip address: 5.5.5.5/32
source ip address: 5.5.5.5/32
IP protocol:
  e:1 a:0 len:0 lt:0 gt:0 eq:1 data:121
TCP/UDP port:
  e:0 a:0 len:1 lt:0 gt:1 eq:1 data:777
  e:1 a:1 len:1 lt:1 gt:0 eq:1 data:888
TCP/UDP destination port:
  e:0 a:0 len:1 lt:0 gt:1 eq:1 data:1300
  e:1 a:1 len:1 lt:1 gt:0 eq:1 data:1400
TCP/UDP source port:
  e:0 a:0 len:1 lt:0 gt:1 eq:1 data:1001
  e:1 a:1 len:1 lt:1 gt:0 eq:1 data:1200

```

```

FlowSpec Actions:
  traffic_rate: 100000 bps

```

Announced routes count = 2

Accepted routes count = 2

PE2#

CE2

CE2#sh ip bgp

BGP table version is 3, local router ID is 5.5.5.5

Status codes: s suppressed, d damped, h history, a add-path, * valid, > best, i - internal,

l - labeled, S Stale

Origin codes: i - IGP, e - EGP, ? - incomplete

	Network	Next Hop	Metric	LocPrf	Weight	Path
*>	4.4.4.4/32	30.1.1.2	0	100	0	65000 100 ?
*		55.1.1.1	0	100	0	65000 100 ?
*>	5.5.5.5/32	0.0.0.0	0	100	32768	?
*>	10.1.1.0/24	30.1.1.2	0	100	0	65000 100 ?
*		55.1.1.1	0	100	0	65000 100 ?
*>	30.1.1.0/24	0.0.0.0	0	100	32768	?
*>	55.1.1.0/24	0.0.0.0	0	100	32768	?

BGP Flowspec Support for IPv4

```
*          55.1.1.1          0          100          0 65000 ?
*> 66.1.1.0/24 55.1.1.1      0          100          0 65000 ?
*          30.1.1.2          0          100          0 65000 100 ?
*> 100.1.1.0/24 30.1.1.2      0          100          0 65000 100 ?
*          55.1.1.1          0          100          0 65000 100 ?
*> 200.1.1.0    0.0.0.0        0          100          32768 ?
```

Total number of prefixes 8

CE2#

CE2#

CE2#sh ip bgp neighbors

```
BGP neighbor is 30.1.1.2, remote AS 65000, local AS 200, external link
  BGP version 4, local router ID 5.5.5.5, remote router ID 3.3.3.3
  BGP state = Established, up for 03:15:13
  Last read 00:00:14, hold time is 90, keepalive interval is 30 seconds
  Neighbor capabilities:
    Route refresh: advertised and received (old and new)
    Address family IPv4 Unicast: advertised and received
    Address family IPv4 Flow Specification: advertised and received
  Received 467 messages, 1 notifications, 0 in queue
  Sent 463 messages, 0 notifications, 0 in queue
  Route refresh request: received 0, sent 0
  Minimum time between advertisement runs is 30 seconds
```

For address family: IPv4 Unicast BGP table version 3, neighbor version 3

```
  Index 1, Offset 0, Mask 0x2
  Community attribute sent to this neighbor (both)
  Large Community attribute sent to this neighbor
  4 accepted prefixes
  5 announced prefixes
```

For address family: IPv4 Flow Specification BGP table version 2, neighbor version 2

```
  Index 1, Offset 0, Mask 0x2
  Community attribute sent to this neighbor (both)
  Large Community attribute sent to this neighbor
  4 accepted prefixes
  2 announced prefixes
```

Connections established 1; dropped 0

Local host: 30.1.1.1, Local port: 41276

Foreign host: 30.1.1.2, Foreign port: 179

Next hop: 30.1.1.1

Next hop global: ::

Next hop local: ::

BGP connection: non shared network

Last Reset: 03:15:18, due to BGP Notification received

Notification Error Message: (OPEN Message Error/Bad BGP Identifier. Reason:)

BGP neighbor is 55.1.1.1, remote AS 65000, local AS 200, external link

```

BGP version 4, local router ID 5.5.5.5, remote router ID 55.1.1.1
BGP state = Established, up for 03:15:13
Last read 00:00:03, hold time is 90, keepalive interval is 30 seconds
Neighbor capabilities:
  Route refresh: advertised and received (old and new)
  Address family IPv4 Unicast: advertised and received
  Address family IPv4 Flow Specification: advertised and received
Received 466 messages, 1 notifications, 0 in queue
Sent 467 messages, 0 notifications, 0 in queue
Route refresh request: received 0, sent 0
Minimum time between advertisement runs is 30 seconds

```

```

For address family: IPv4 Unicast BGP table version 3, neighbor version 3
  Index 2, Offset 0, Mask 0x4
  Community attribute sent to this neighbor (both)
  Large Community attribute sent to this neighbor
  5 accepted prefixes
  7 announced prefixes

```

```

For address family: IPv4 Flow Specification BGP table version 2, neighbor version 2
  Index 2, Offset 0, Mask 0x4
  Community attribute sent to this neighbor (both)
  Large Community attribute sent to this neighbor
  2 accepted prefixes
  2 announced prefixes

```

```

Connections established 1; dropped 0
Local host: 55.1.1.2, Local port: 179
Foreign host: 55.1.1.1, Foreign port: 40660
Next hop: 55.1.1.2
Next hop global: ::
Next hop local: ::
BGP connection: non shared network
Last Reset: 03:15:18, due to BGP Notification received
Notification Error Message: (OPEN Message Error/Bad BGP Identifier. Reason: )

```

```

CE2#
CE2#
CE2#sh ip bgp ipv4 flowspec summary
BGP router identifier 5.5.5.5, local AS number 200
BGP table version is 2
3 BGP AS-PATH entries
0 BGP community entries

```

Neighbor PfxRcd	V	AS	MsgRcv	MsgSen	TblVer	InQ	OutQ	Up/Down	State/
30.1.1.2 4	4	65000	468	463	2	0	0	03:15:21	
55.1.1.1 2	4	65000	467	467	2	0	0	03:15:21	

BGP Flowspec Support for IPv4

Total number of neighbors 2

Total number of Established sessions 2

```
CE2#
CE2#
CE2#sh ip bgp ipv4 flowspec
BGP table version is 2, local router ID is 5.5.5.5
Status codes: s suppressed, d damped, h history, a add-path, * valid, > best, i -
internal,
                l - labeled, S Stale
Origin codes: i - IGP, e - EGP, ? - incomplete
```

	Network	Next Hop	Metric	LocPrf	Weight	Path
*	flowspec/216	30.1.1.2	0	100	0	65000 100 i
*		55.1.1.1	0	100	0	65000 100 i
*>	flowspec/336	0.0.0.0	0	100	32768	i
*	flowspec/264	30.1.1.2	0	100	0	65000 i
*	flowspec/392	30.1.1.2	0	100	0	65000 i
*	flowspec/176	30.1.1.2	0	100	0	65000 100 i
*		55.1.1.1	0	100	0	65000 100 i
*>	flowspec/288	0.0.0.0	0	100	32768	i

Total number of prefixes 6

```
CE2#
CE2#sh ip bgp ipv4 flowspec detail
BGP table version is 2, local router ID is 5.5.5.5
Status codes: s suppressed, d damped, h history, a add-path, * valid, > best, i -
internal,
                l - labeled, S Stale
Origin codes: i - IGP, e - EGP, ? - incomplete
```

	Network	Next Hop	Metric	LocPrf	Weight	Path
*	flowspec/216	30.1.1.2	0	100	0	65000 100 i

FlowSpec:

```
destination ip address: 10.1.1.0/24
source ip address: 10.1.1.0/24
IP protocol:
  e:1 a:0 len:0 lt:0 gt:0 eq:1 data:44
TCP/UDP destination port:
  e:0 a:0 len:1 lt:0 gt:1 eq:1 data:44
  e:1 a:1 len:1 lt:1 gt:0 eq:1 data:144
TCP/UDP source port:
  e:0 a:0 len:1 lt:0 gt:1 eq:1 data:22
  e:1 a:1 len:1 lt:1 gt:0 eq:1 data:122
```

FlowSpec Actions:

```
traffic_rate: 21000 bps
```

*		55.1.1.1	0	100	0	65000 100 i
---	--	----------	---	-----	---	-------------

FlowSpec Actions:

traffic_rate: 21000 bps

```
*>  flowspec/336      0.0.0.0          0          100          32768  i
```

FlowSpec:

destination ip address: 30.1.1.0/24

source ip address: 30.1.1.0/24

IP protocol:

e:1 a:0 len:0 lt:0 gt:0 eq:1 data:11

TCP/UDP port:

e:0 a:0 len:1 lt:0 gt:1 eq:1 data:100

e:1 a:1 len:1 lt:1 gt:0 eq:1 data:200

TCP/UDP destination port:

e:0 a:0 len:1 lt:0 gt:1 eq:1 data:300

e:1 a:1 len:1 lt:1 gt:0 eq:1 data:400

TCP/UDP source port:

e:0 a:0 len:1 lt:0 gt:1 eq:1 data:500

e:1 a:1 len:1 lt:1 gt:0 eq:1 data:600

TCP flags:

e:0 a:0 len:0 not:0 m:1 data:0x21

e:1 a:1 len:0 not:1 m:0 data:0x1e

DSCP:

e:1 a:0 len:0 lt:0 gt:0 eq:1 data:0x21

FlowSpec Actions:

traffic_rate: 500000 bps

traffic marking DSCP: 1e

```
*  flowspec/264      30.1.1.2          0          100          0  65000  i
```

FlowSpec:

destination ip address: 1.1.1.1/32

source ip address: 3.3.3.3/32

TCP/UDP port:

e:0 a:0 len:1 lt:0 gt:1 eq:1 data:111

e:1 a:1 len:1 lt:1 gt:0 eq:1 data:222

TCP/UDP destination port:

e:0 a:0 len:1 lt:0 gt:1 eq:1 data:300

e:1 a:1 len:1 lt:1 gt:0 eq:1 data:399

TCP/UDP source port:

e:0 a:0 len:1 lt:0 gt:1 eq:1 data:230

e:1 a:1 len:1 lt:1 gt:0 eq:1 data:299

FlowSpec Actions:

traffic_rate: 1111111 bps

```
*  flowspec/392      30.1.1.2          0          100          0  65000  i
```

FlowSpec:

BGP Flowspec Support for IPv4

destination ip address: 3.3.3.3/32
source ip address: 1.1.1.1/32
IP protocol:
 e:1 a:0 len:0 lt:0 gt:0 eq:1 data:78
TCP/UDP port:
 e:0 a:0 len:1 lt:0 gt:1 eq:1 data:101
 e:1 a:1 len:1 lt:1 gt:0 eq:1 data:201
TCP/UDP destination port:
 e:0 a:0 len:1 lt:0 gt:1 eq:1 data:400
 e:1 a:1 len:1 lt:1 gt:0 eq:1 data:499
TCP/UDP source port:
 e:0 a:0 len:1 lt:0 gt:1 eq:1 data:330
 e:1 a:1 len:1 lt:1 gt:0 eq:1 data:399
ICMP code:
 e:1 a:0 len:0 lt:0 gt:0 eq:1 data:10
Packet length:
 e:0 a:0 len:1 lt:0 gt:1 eq:1 data:22
 e:1 a:1 len:1 lt:1 gt:0 eq:1 data:222
DSCP:
 e:1 a:0 len:0 lt:0 gt:0 eq:1 data:0x10

FlowSpec Actions:

traffic_rate: 1000011 bps
traffic marking DSCP: e

* flowspec/176 30.1.1.2 0 100 0 65000 100 i

FlowSpec:

destination ip address: 4.4.4.4/32
source ip address: 4.4.4.4/32
IP protocol:
 e:1 a:0 len:0 lt:0 gt:0 eq:1 data:12
TCP/UDP port:
 e:0 a:0 len:1 lt:0 gt:1 eq:1 data:333
 e:1 a:1 len:1 lt:1 gt:0 eq:1 data:444

FlowSpec Actions:

traffic_rate: 4444444 bps

* 55.1.1.1 0 100 0 65000 100 i

FlowSpec Actions:

traffic_rate: 4444444 bps

*> flowspec/288 0.0.0.0 0 100 32768 i

FlowSpec:

destination ip address: 5.5.5.5/32
source ip address: 5.5.5.5/32
IP protocol:
 e:1 a:0 len:0 lt:0 gt:0 eq:1 data:121

```
TCP/UDP port:
  e:0 a:0 len:1 lt:0 gt:1 eq:1 data:777
  e:1 a:1 len:1 lt:1 gt:0 eq:1 data:888
TCP/UDP destination port:
  e:0 a:0 len:1 lt:0 gt:1 eq:1 data:1300
  e:1 a:1 len:1 lt:1 gt:0 eq:1 data:1400
TCP/UDP source port:
  e:0 a:0 len:1 lt:0 gt:1 eq:1 data:1001
  e:1 a:1 len:1 lt:1 gt:0 eq:1 data:1200
```

```
FlowSpec Actions:
  traffic_rate: 100000 bps
```

Total number of prefixes 6

CE2#

CE2#

CE2#sh ip bgp ipv4 flowspec vrf all

BGP table version is 2, local router ID is 5.5.5.5

Status codes: s suppressed, d damped, h history, a add-path, * valid, > best, i - internal,

l - labeled, S Stale

Origin codes: i - IGP, e - EGP, ? - incomplete

	Network	Next Hop	Metric	LocPrf	Weight	Path
*	flowspec/216	30.1.1.2	0	100	0	65000 100 i
*		55.1.1.1	0	100	0	65000 100 i
*>	flowspec/336	0.0.0.0	0	100	32768	i
*	flowspec/264	30.1.1.2	0	100	0	65000 i
*	flowspec/392	30.1.1.2	0	100	0	65000 i
*	flowspec/176	30.1.1.2	0	100	0	65000 100 i
*		55.1.1.1	0	100	0	65000 100 i
*>	flowspec/288	0.0.0.0	0	100	32768	i

Total number of prefixes 6

CE2#

CE2#sh ip bgp ipv4 flowspec vrf all detail

BGP table version is 2, local router ID is 5.5.5.5

Status codes: s suppressed, d damped, h history, a add-path, * valid, > best, i - internal,

l - labeled, S Stale

Origin codes: i - IGP, e - EGP, ? - incomplete

	Network	Next Hop	Metric	LocPrf	Weight	Path
*	flowspec/216	30.1.1.2	0	100	0	65000 100 i

FlowSpec:

destination ip address: 10.1.1.0/24

source ip address: 10.1.1.0/24

IP protocol:

e:1 a:0 len:0 lt:0 gt:0 eq:1 data:44

BGP Flowspec Support for IPv4

TCP/UDP destination port:

e:0 a:0 len:1 lt:0 gt:1 eq:1 data:44
e:1 a:1 len:1 lt:1 gt:0 eq:1 data:144

TCP/UDP source port:

e:0 a:0 len:1 lt:0 gt:1 eq:1 data:22
e:1 a:1 len:1 lt:1 gt:0 eq:1 data:122

FlowSpec Actions:

traffic_rate: 21000 bps

* 55.1.1.1 0 100 0 65000 100 i

FlowSpec Actions:

traffic_rate: 21000 bps

*> flowspec/336 0.0.0.0 0 100 32768 i

FlowSpec:

destination ip address: 30.1.1.0/24

source ip address: 30.1.1.0/24

IP protocol:

e:1 a:0 len:0 lt:0 gt:0 eq:1 data:11

TCP/UDP port:

e:0 a:0 len:1 lt:0 gt:1 eq:1 data:100
e:1 a:1 len:1 lt:1 gt:0 eq:1 data:200

TCP/UDP destination port:

e:0 a:0 len:1 lt:0 gt:1 eq:1 data:300
e:1 a:1 len:1 lt:1 gt:0 eq:1 data:400

TCP/UDP source port:

e:0 a:0 len:1 lt:0 gt:1 eq:1 data:500
e:1 a:1 len:1 lt:1 gt:0 eq:1 data:600

TCP flags:

e:0 a:0 len:0 not:0 m:1 data:0x21
e:1 a:1 len:0 not:1 m:0 data:0x1e

DSCP:

e:1 a:0 len:0 lt:0 gt:0 eq:1 data:0x21

FlowSpec Actions:

traffic_rate: 500000 bps

traffic marking DSCP: 1e

* flowspec/264 30.1.1.2 0 100 0 65000 i

FlowSpec:

destination ip address: 1.1.1.1/32

source ip address: 3.3.3.3/32

TCP/UDP port:

e:0 a:0 len:1 lt:0 gt:1 eq:1 data:111
e:1 a:1 len:1 lt:1 gt:0 eq:1 data:222

TCP/UDP destination port:

e:0 a:0 len:1 lt:0 gt:1 eq:1 data:300

```

    e:1 a:1 len:1 lt:1 gt:0 eq:1 data:399
TCP/UDP source port:
    e:0 a:0 len:1 lt:0 gt:1 eq:1 data:230
    e:1 a:1 len:1 lt:1 gt:0 eq:1 data:299

```

FlowSpec Actions:

```
traffic_rate: 1111111 bps
```

```
*    flowspec/392      30.1.1.2          0          100         0    65000 i
```

FlowSpec:

```

destination ip address: 3.3.3.3/32
source ip address: 1.1.1.1/32
IP protocol:
    e:1 a:0 len:0 lt:0 gt:0 eq:1 data:78
TCP/UDP port:
    e:0 a:0 len:1 lt:0 gt:1 eq:1 data:101
    e:1 a:1 len:1 lt:1 gt:0 eq:1 data:201
TCP/UDP destination port:
    e:0 a:0 len:1 lt:0 gt:1 eq:1 data:400
    e:1 a:1 len:1 lt:1 gt:0 eq:1 data:499
TCP/UDP source port:
    e:0 a:0 len:1 lt:0 gt:1 eq:1 data:330
    e:1 a:1 len:1 lt:1 gt:0 eq:1 data:399
ICMP code:
    e:1 a:0 len:0 lt:0 gt:0 eq:1 data:10
Packet length:
    e:0 a:0 len:1 lt:0 gt:1 eq:1 data:22
    e:1 a:1 len:1 lt:1 gt:0 eq:1 data:222
DSCP:
    e:1 a:0 len:0 lt:0 gt:0 eq:1 data:0x10

```

FlowSpec Actions:

```

traffic_rate: 1000011 bps
traffic marking DSCP: e

```

```
*    flowspec/176     30.1.1.2          0          100         0    65000 100 i
```

FlowSpec:

```

destination ip address: 4.4.4.4/32
source ip address: 4.4.4.4/32
IP protocol:
    e:1 a:0 len:0 lt:0 gt:0 eq:1 data:12
TCP/UDP port:
    e:0 a:0 len:1 lt:0 gt:1 eq:1 data:333
    e:1 a:1 len:1 lt:1 gt:0 eq:1 data:444

```

FlowSpec Actions:

```
traffic_rate: 4444444 bps
```

BGP Flowspec Support for IPv4

* 55.1.1.1 0 100 0 65000 100 i

FlowSpec Actions:

traffic_rate: 4444444 bps

*> flowspec/288 0.0.0.0 0 100 32768 i

FlowSpec:

destination ip address: 5.5.5.5/32

source ip address: 5.5.5.5/32

IP protocol:

e:1 a:0 len:0 lt:0 gt:0 eq:1 data:121

TCP/UDP port:

e:0 a:0 len:1 lt:0 gt:1 eq:1 data:777

e:1 a:1 len:1 lt:1 gt:0 eq:1 data:888

TCP/UDP destination port:

e:0 a:0 len:1 lt:0 gt:1 eq:1 data:1300

e:1 a:1 len:1 lt:1 gt:0 eq:1 data:1400

TCP/UDP source port:

e:0 a:0 len:1 lt:0 gt:1 eq:1 data:1001

e:1 a:1 len:1 lt:1 gt:0 eq:1 data:1200

FlowSpec Actions:

traffic_rate: 100000 bps

Total number of prefixes 6

CE2#

Fundamental Layer 3 Command Reference

CHAPTER 1 Fundamental Layer 3 Commands

This chapter describes the fundamental Layer 3 commands:

- `automatic-router-id-selection enable`
- `clear ip route kernel`
- `clear ip route`
- `clear ip route vrf NAME`
- `clear router-id`
- `debug rib`
- `description`
- `fib retain`
- `ip route`
- `ip route vrf <vrf-name>`
- `ip urpf enable`
- `ip urpf allow-default`
- `ip verify unicast source reachable-via`
- `ip vrf`
- `ipv6 route`
- `maximum-paths`
- `max-static-routes`
- `router-id`
- `show debugging rib`
- `show ip route track-table`
- `show ip rpf`
- `Show ipv6 route track-table`
- `show ipv6 rpf`
- `show router-id`
- `show running-config router`
- `show running-config router-id`
- `show running-config urpf`
- `show running-config vrf`
- `snmp restart rib`

automatic-router-id-selection enable

Use this command to assure that OcNOS selects the loopback IP address as the router-id each time the device is rebooted.

Use the `no` form of this command to remove this constraint.

Command Syntax

```
automatic-router-id-selection enable
no automatic-router-id-selection enable
```

Parameters

None

Default

No default value is specified

Command Mode

Configure mode

Applicability

This command was introduced before OcNOS version 1.3.

Examples

```
#configure terminal
(config)#automatic-router-id-selection enable
(config)#
```

clear ip route kernel

Use this command to clear stale IPv4 routes from the RIB (Routing Information Base) and FIB (Forwarding Information Base).

Command Syntax

```
clear ip route kernel
clear ip kernel route
```

Parameters

None

Command Mode

Exec mode

Applicability

This command was introduced before OcnOS version 1.3.

Example

```
#clear ip route kernel
```

clear ip route

Use this command to clear an all IPv4 routes or any specific prefix routes.

Command Syntax

```
clear ip route (*|A.B.C.D/M)
```

Parameters

*	Clears all routes
A.B.C.D/M	Prefix to be cleared

Command Mode

Exec mode

Applicability

This command was introduced before OcNOS version 1.3.

Example

```
#clear ip route *  
#clear ip route 1.1.1.0/24
```

clear ip route vrf NAME

Use this command to clear all IPv4 VRF route or any specific prefix VRF route of any particular VRF name.

Command Syntax

```
clear ip route vrf NAME (*|A.B.C.D/M)
```

Parameters

NAME	VPN Routing or Forwarding instance name
*	Clears all routes
A.B.C.D/M	Prefix to be cleared

Command Mode

Exec mode

Applicability

This command was introduced before OcnOS version 1.3.

Example

```
#clear ip route vrf myVRF *
```

clear router-id

Use this command to clear the current Router-Id and trigger the Router-Id calculation again. The new Router-id is sent to all protocol modules.

- To clear only the router-id for the default VRF, enter `clear router-id`.
- To clear the router-id for a particular VRF, enter `clear router-id vrf VRFNAME`.
- To clear the router-id for all VRFs, enter `clear router-id vrf`.

Command Syntax

```
clear router-id (vrf (VRFNAME|))
```

Parameters

`VRFNAME` VPN routing/forwarding instance name.

Command Mode

Exec mode

Applicability

This command was introduced before OcNOS version 1.3.

Examples

```
#clear router-id
#clear router-id vrf
```

debug rib

Use this command to debug the `ribd` process.

Use the `no` form of this command or the `undebug` command to stop debugging.

Command Syntax

```
debug rib (all|)
debug rib events
debug rib packet (recv|send|) (detail|)
debug rib nsm
debug rib bfd
debug rib kernel
debug rib monitor
debug ip routing (add-route|delete-route|mod-route|)
no debug all
no debug rib (all|)
no debug all rib
no debug rib events
no debug rib packet (recv|send|) (detail|)
no debug rib nsm
no debug rib bfd
no debug rib kernel
no debug rib monitor
no debug ip routing (add-route|delete-route|mod-route|)
undebug all
undebug rib (all|)
undebug all rib
undebug rib events
undebug rib packet (recv|send|) (detail|)
undebug rib nsm
undebug rib bfd
undebug rib kernel
```

Parameters

<code>all</code>	All debugging functions
<code>events</code>	Events
<code>packet</code>	Packet events
<code>recv</code>	Received packets
<code>send</code>	Sent packets

detail	Detailed information
nsm	NSM events
kernel	RIB kernel
monitor	Enable Monitor route netlink
bfd	BFD (Bidirectional Forwarding Detection) events
ip routing	IPv4 routing events
add-route	Add route events
delete-route	Delete route events
mod-route	Modify route events

Disabled

By default, debug command is disabled.

Command Mode

Privileged Exec mod

Applicability

This command was introduced before OcNOS version 1.3.

Example

```
#debug rib all
```

description

Use this command to assign a description to a Virtual Router instance.

Use the `no` parameter to remove a description.

Command Syntax

```
description LINE
no description
```

Parameters

LINE Virtual Router description maximum 80 characters

Disabled

By default, description command is disabled

Command Mode

VR mode

Applicability

This command was introduced before OcNOS version 1.3.

Examples

```
#configure terminal
(config)#virtual-router VR1
(config-vr)#description VR1 has been created for CLI testing
(config-vr)#exit

(config)#virtual-router VR1
(config-vr)#no description
(config-vr)#exit
```

fib retain

Use this command to set the retention time for stale routes in the Forwarding Information Base (FIB) when `ribd` restarts. The `ribd` process reads the FIB and treats previously self-installed routes as stale.

You can display stale routes by running the `show ip route database` command. All routes preceded by the symbol `p` are stale routes. When protocol modules restart, `ribd` overrides these stale routes with routes updated by the protocol modules.

Table 1-1 show the behavior of routes when `ribd` stops.

Table 1-1: FIB retention

Command	Behavior
<code>fib retain</code>	Does not clear routes from the FIB and retains stale routes for 60 seconds when restarted.
<code>fib retain forever</code>	Does not clear routes and retains stale routes forever.
<code>fib retain time <1-65535></code>	Does not clear routes and retains stale routes for the specified seconds.
<code>no fib retain</code> (default)	Cleans up routes in the FIB, but retains stale routes for 60 seconds when restarted.

You can remove stale routes at any time with the `clear ip route kernel` command.

Use the `no` form of this command to revert to default; that is, do not retain routes in the FIB when `ribd` stops.

Command Syntax

```
fib retain (forever|time <1-65535>|)
no fib retain (forever|time <1-65535>|)
```

Parameters

<code>forever</code>	Retain FIB forever
<code>time</code>	Retain FIB for a time after <code>ribd</code> restarts
<code><1-65535></code>	Retention time in seconds; if you omit this value, the default is 60 seconds

Default

Routes are cleared from the FIB when `ribd` stops. However, when `ribd` restarts, stale routes are retained for 60 seconds.

Command Mode

Configure mode

Applicability

This command was introduced before OcnOS version 1.3.

Examples

```
#configure terminal
(config)#fib retain time 180
```

ip route

Use this command to create an IPv4 static route.

Use the `no` form of this command to delete a static route.

Note: ECMP static route with one nexthop in local vrf and the other nexthop in inter vrf is not supported and IVRF static ECMP is not supported.

Command Syntax

```
ip route A.B.C.D/M (A.B.C.D|IFNAME)
ip route A.B.C.D A.B.C.D (A.B.C.D|IFNAME)
ip route A.B.C.D/M (A.B.C.D|IFNAME) {<1-255>|tag <0-4294967295>|description WORD}{<track <1-500>}
ip route A.B.C.D A.B.C.D (A.B.C.D|IFNAME) {<1-255>|tag <0-4294967295>|description WORD}{<track <1-500>}
ip route vrf NAME A.B.C.D/M IFNAME
ip route vrf NAME A.B.C.D/M A.B.C.D IFNAME
ip route vrf NAME A.B.C.D/M (A.B.C.D|IFNAME) global {<track <1-500>}
ip route vrf NAME A.B.C.D/M IFNAME {<1-255>|tag <0-4294967295>|description WORD}{<track <1-500>}
ip route vrf NAME A.B.C.D/M A.B.C.D IFNAME {<1-255>|tag <0-4294967295>|description WORD}{<track <1-500>}
no ip route A.B.C.D/M (A.B.C.D|IFNAME|)
no ip route A.B.C.D A.B.C.D (A.B.C.D|IFNAME)
no ip route A.B.C.D/M (A.B.C.D|IFNAME) {<1-255>|tag <0-4294967295>|description WORD}{<track <1-500>}
no ip route A.B.C.D A.B.C.D (A.B.C.D|IFNAME) {<1-255>|tag <0-4294967295>|description WORD}{<track <1-500>}
no ip route vrf NAME A.B.C.D/M IFNAME
no ip route vrf NAME A.B.C.D/M A.B.C.D IFNAME
no ip route vrf NAME A.B.C.D/M IFNAME {<1-225>|tag <0-4294967295>|description WORD}{<track <1-500>}
no ip route vrf NAME A.B.C.D/M A.B.C.D IFNAME {<1-255>|tag <0-4294967295>|description WORD}{<track <1-500>}
```

Parameters

A.B.C.D/M	Subnet: IP destination prefix and a mask length
A.B.C.D A.B.C.D	Subnet: IP destination address and mask
A.B.C.D	Gateway nexthop IPv4 address
global	Global table lookup (to support inter-VRF static route leaking)
<1-255>	Administrative distance
IFNAME	Gateway nexthop interface name

<code>track</code>	Tracking-id to ipv4 static route
<1-500>	Identifier for the tracked object
<code>description</code>	Description of the static route maximum 80 character
<code>tag</code>	Tag used as a "match" value to control redistribution via route maps
<0-4294967295>	Tag value
<code>vrf</code>	VRF (Virtual Routing and Forwarding) instance
NAME	VRF name

Default

By default, no static IPv4 route configured

Command Mode

Configure mode

Applicability

This command was introduced before OcnOS version 1.3 and was updated in OcnOS version 1.3.4.

The Track command is introduced in OcnOS version 5.1.

Examples

```
#configure terminal
(config)#ip route 192.168.3.0 255.255.255.0 2.2.2.2 128
(config)#ip route 1.1.1.0/24 eth0 32
(config)#ip route vrf new 1.1.1.1/1 1.1.1.1 eth1 description new tag 1
(config)# ip route 40.1.1.0/24 eth1 track 10
(config-object-track)#commit
```

```
(config)#no ip route 40.1.1.0/24 eth1 track 10
(config)#commit
```

This example creates VRF static routes with the nexthops belonging to the default VRF. The nexthop gateway address can be the IFNAME network address or any other IP address reachable via IFNAME.

```
#show ip route vrf
Codes: K - kernel, C - connected, S - static, R - RIP, B - BGP
       O - OSPF, IA - OSPF inter area
       N1 - OSPF NSSA external type 1, N2 - OSPF NSSA external type 2
       E1 - OSPF external type 1, E2 - OSPF external type 2
       i - IS-IS, L1 - IS-IS level-1, L2 - IS-IS level-2, ia - IS-IS inter area,
       v - vrf leaked
       * - candidate default
```

```
IP Route Table for VRF "default"
C      10.12.19.0/24 is directly connected, eth0, 4d23h06m
C      11.1.1.0/24 is directly connected, eth4, 4d23h01m
C      13.13.13.0/31 is directly connected, eth3, 4d23h06m
C      50.5.5.0/24 is directly connected, eth3, 4d23h06m
```



```
C    100.100.100.0/24 is directly connected, lo, 4d23h06m
O    101.1.1.1/32 [110/11] via 11.1.1.2, eth4, 19:20:39
C    127.0.0.0/8 is directly connected, lo, 4d23h06m
Gateway of last resort is not set

(config)#ip route vrf vrf1 201.201.201.201/32 11.1.1.11 eth4 global
(config)#ip route vrf vrf1 202.202.202.202/32 101.1.1.1 eth4 global

#show ip route vrf vrf1 static
IP Route Table for VRF "vrf1"
S    v201.201.201.201/32 [1/0] via 11.1.1.11, eth4, 00:00:44
S    v202.202.202.202/32 [1/0] via 101.1.1.1, eth4 (recursive via 11.1.1.2), 00:00:17
Gateway of last resort is not set

#configure terminal
(config)#ip route vrf vrf1 20.2.2.0/24 xe1 global
(config)#commit

(config)#no ip route vrf vrf1 20.2.2.0/24 xe1 global track 10
(config)#commit
```

Ip route vrf <vrf-name>

Use this command to configure a tracking-id to ipv4 static route in non-default vrf.

Use the `no` form of this command to delete the tracking id

Command Syntax

```
ip route vrf <vrf-name> A.B.C.D/M (A.B.C.D|IFNAME) {<track <1-500>}
```

Parameters

<code>vrf-name</code>	Vrf name
<code>A.B.C.D/M</code>	Destination prefix with subnet in ipv4 format
<code>A.B.C.D</code>	Gateway address in ipv4 format
<code>IFNAME</code>	Gateway address in interface name format
<code><1-500></code>	Identifier for the tracked object

Command Mode

Configuration mode

Applicability

This command was introduced in OcnOS version 5.1.

Example

```
#configure terminal
(config)# ip route vrf vrf1 40.1.1.0/24 eth1 track 10
(config-object-track)#commit

(config)#no ip route vrf vrf1 40.1.1.0/24 eth1 track 10
(config)#commit
```

ip urpf enable

Use this command to enable uRPF mode on the system.

Use the `no` form of the command to disable uRPF mode on this system.

Note: The configuration is applied only after a reboot.

Command Syntax

```
ip urpf enable
no ip urpf enable
```

Parameter

None

Default

By default, uRPF mode on the system is disabled.

Command Mode

Configure mode

Applicability

This command was introduced before OcNOS version 1.3.

Examples

```
#configure terminal
(config)#ip urpf enable
% System Reboot is required for new URPF configurations to take effect

(config)#no ip urpf enable
% System Reboot is required for new URPF configurations to take effect
```

ip urpf allow-default

Use this command to enable default route check for uRPF mode.

Use `no` form of this command to disable default route check for uRPF mode.

Command Syntax

This command applies only to Qumran platforms.

```
ip urpf allow-default
no ip urpf allow-default
```

Parameter

None

Default

By default, uRPF mode on the system is disabled.

Command Mode

Configure mode

Applicability

This command was introduced before OcNOS version 1.3.

Examples

```
#configure terminal
(config)#ip urpf allow-default

(config)#no ip urpf allow-default
```

ip verify unicast source reachable-via

Use this command to configure Unicast Reverse Path Forwarding with source-specific reachability on the interface level.

Use the `no` form of the command to disable Unicast Reverse Path Forwarding with source-specific reachability on the interface level.

Command Syntax

```
ip verify unicast source reachable-via (any | rx )
no ip verify unicast source reachable-via
```

Parameters

<code>any</code>	Source is reachable via any interface
<code>rx</code>	Source is reachable via an interface on which packet was received

Default

N/A

Command Mode

Interface mode

Applicability

This command was introduced in OcNOS SP Version 6.0

Examples

```
#configure terminal
(config)#interface xe1
(config-if)#ip verify unicast source reachable-via any
(config-if)#ip verify unicast source reachable-via rx
(config-if)#no ip verify unicast source reachable-via
```

ip vrf

This command creates a user-defined VRF (Virtual Routing and Forwarding) RIB (Routing Information Base), assigns a VRF identifier, and switches to VRF mode.

Use the `no` parameter with command to remove a VRF RIB.

Note: On configuration of user-defined VRF with `ip vrf WORD CLI`, `lo.WORD` interface configuration will not be displayed in `show running-config` even though `lo.WORD` interface, default IPv4 address and default IPv6 address are present in system. To display the `interface lo.WORD`, `ip address 127.0.0.1/8` and `ipv6 address ::1/128` configurations in `show running configuration` user needs to explicitly configure the same from CLI. This is due to a restriction with scaled VRF configurations in a single commit.

Command Syntax

```
ip vrf WORD
no ip vrf WORD
```

Parameter

WORD VRF identifier

Default

By default, no user-defined VRFs exist, only the default VRF.

Command Mode

Configure mode

Applicability

This command was introduced before OcnOS version 1.3.

Example

```
#configure terminal
(config)#ip vrf myVRF
(config-vrf)#
```

IPv6 route

Use this command to create an IPv6 static route.

Use the no form of this command to delete a static route

Note: IPv6 static route with Interface name alone as gateway next-hop is not supported.

Command Syntax

```
ipv6 route X:X::X:X/M (X:X::X:X|IFNAME) (<1-255>|) (track <1-500>|) (description
  LINE|)
```

```
ipv6 route X:X::X:X/M X:X::X:X IFNAME (<1-255>|) (track <1-500>|) (description
  LINE|)
```

```
ipv6 route vrf NAME X:X::X:X/M IFNAME (track <1-500>|) (description LINE|)
```

```
ipv6 route vrf NAME X:X::X:X/M X:X::X:X IFNAME (track <1-500>|) (description LINE|)
```

```
ipv6 route vrf NAME X:X::X:X/M IFNAME global {track <1-500>}
```

```
ipv6 route vrf NAME X:X::X:X/M X:X::X:X IFNAME global {track <1-500>}
```

```
no ipv6 route X:X::X:X/M X:X::X:X
```

```
no ipv6 route X:X::X:X/M IFNAME
```

```
no ipv6 route X:X::X:X/M X:X::X:X <1-255>
```

```
no ipv6 route X:X::X:X/M X:X::X:X track <1-500>
```

```
no ipv6 route X:X::X:X/M X:X::X:X description
```

```
no ipv6 route X:X::X:X/M X:X::X:X
```

```
no ipv6 route X:X::X:X/M IFNAME <1-255>
```

```
no ipv6 route X:X::X:X/M IFNAME track <1-500>
```

```
no ipv6 route X:X::X:X/M IFNAME description
```

```
no ipv6 route X:X::X:X/M IFNAME
```

```
no ipv6 route X:X::X:X/M X:X::X:X IFNAME <1-255>
```

```
no ipv6 route X:X::X:X/M X:X::X:X IFNAME track <1-500>
```

```
no ipv6 route X:X::X:X/M X:X::X:X IFNAME description
```

```
no ipv6 route X:X::X:X/M X:X::X:X IFNAME
```

```
no ipv6 route vrf NAME X:X::X:X/M X:X::X:X
```

```
no ipv6 route vrf NAME X:X::X:X/M IFNAME track <1-500>
```

```
no ipv6 route vrf NAME X:X::X:X/M IFNAME description
no ipv6 route vrf NAME X:X::X:X/M IFNAME

no ipv6 route vrf NAME X:X::X:X/M X:X::X:X IFNAME track <1-500>
no ipv6 route vrf NAME X:X::X:X/M X:X::X:X IFNAME description
no ipv6 route vrf NAME X:X::X:X/M X:X::X:X IFNAME

no ipv6 route vrf NAME X:X::X:X/M IFNAME global track <1-500>
no ipv6 route vrf NAME X:X::X:X/M IFNAME global

no ipv6 route vrf NAME X:X::X:X/M X:X::X:X IFNAME global track <1-500>
no ipv6 route vrf NAME X:X::X:X/M X:X::X:X IFNAME global
```

Parameters

X:X::X:X/M	Subnet: IPv6 destination prefix and a mask length
X:X::X:X	Gateway nexthop IPv6 address
IFNAME	Gateway nexthop interface name
<1-255>	Administrative distance
track	Object Tracking id
<1-500>	Object Tracking id
description	Description of the static route
LINE	Description
vrf	VRF (Virtual Routing and Forwarding) instance
NAME	VRF name
global	Global table lookup (to support inter-VRF static route leaking)

Default

By default, no static IPv6 route is configured

Command Mode

Configuration mode

Applicability

This command was introduced in OcnOS version 1.3.

Example

```
#configure terminal
(config)#ipv6 route 1234::/64 1000::1 128
(config)#ipv6 route 1235::/64 eth1 32
(config)#ipv6 route vrf vrf3 1236::/64 eth3
(config)#end
#show ipv6 route vrf all
IPv6 Routing Table
```

```
Codes: K - kernel route, C - connected, S - static, R - RIP, O - OSPF,
IA - OSPF inter area, E1 - OSPF external type 1,
E2 - OSPF external type 2, E - EVPN N1 - OSPF NSSA external type 1,
N2 - OSPF NSSA external type 2, i - IS-IS, B - BGP
Timers: Uptime
IP Route Table for VRF "default"
C ::1/128 via ::, lo, 23:35:55
C 2::2/128 via ::, lo, 23:35:55
C 1000::/64 via ::, eth1, 00:07:45
S 1234::/64 [128/0] via 1000::1, eth1, 00:07:04
S 1235::/64 [32/0] via ::, eth1, 00:06:38
C 6000::/64 via ::, eth1, 23:35:55
C 7000::/64 via ::, eth7, 23:35:55
C fe80::/64 via ::, eth7, 23:35:55
IP Route Table for VRF "management"
IP Route Table for VRF "vrf3"
S 1236::/64 [1/0] via ::, eth3, 00:00:13
C 3000::/64 via ::, eth3, 00:07:55
C fe80::/64 via ::, eth3, 00:08:05
#show ipv6 route vrf all static
IP Route Table for VRF "default"
S 1234::/64 [128/0] via 1000::1, eth1, 00:15:28
S 1235::/64 [32/0] via ::, eth1, 00:15:02
IP Route Table for VRF "management"
IP Route Table for VRF "vrf3"
S 1236::/64 [1/0] via ::, eth3, 00:08:37
```

maximum-paths

Use this command to set the maximum number of paths to install in the FIB (Forwarding Information Base) for the ECMP (Equal-Cost MultiPath) feature.

Use the `no` parameter with this command to revert to default.

Note: If you change the number of paths from the default (8), you must save the running configuration and perform a reboot.

Command Syntax

```
maximum-paths <1-64>  
no maximum-paths
```

Parameter

<1-64> Maximum number of paths to install in the FIB

Default

By default, the maximum number of paths is 8.

Command Mode

Configure mode

Applicability

This command was introduced before OcNOS version 1.3.

Example

```
#configure terminal  
(config)#maximum-paths 5
```

max-static-routes

Use this command to set the maximum number of static routes.

Use the `no` parameter to disable this command.

Command Syntax

```
max-static-routes <1-4294967294>  
no max-static-routes
```

Parameters

<1-4294967294> Maximum number of static routes

Default

By default, max static routes value is 4294967294

Command Mode

Configure mode

Applicability

This command was introduced before OcnOS version 1.3.

Examples

```
#configure terminal  
(config)#max-static-routes 123  
  
(config)#no max-static-routes
```

router-id

Use this command to add a router identifier for this system.

Use the `no` form of this command to disable this function.

Command Syntax

```
router-id A.B.C.D
no router-id (A.B.C.D)
```

Parameters

A.B.C.D Router identifier in IP address format for this system.

Default

None

Command Mode

Configure mode

Applicability

This command was introduced before OcNOS version 1.3.

Examples

```
#configure terminal
(config)#router-id 123.12.3.123
(config)#
```

show debugging rib

Use this command to display debug settings.

Command Syntax

```
show debugging rib
```

Parameters

None

Command Mode

Privileged Exec Mode and Exec Mode

Applicability

This command was introduced before OcNOS version 1.3.

Examples

```
#show debugging rib
```

show ip route track-table

Use this command to display ipv4 static routes that are associated to a tracking id across all vrfs.

Command Syntax

```
show ip route track-table
```

Parameters

None

Default

NA

Command Mode

Privileged Exec mode and Exec mode

Applicability

This command is introduced in OcNOS version 5.1.

Examples

```
#show ip rou track-table
ip route 40.1.1.0 255.255.255.0 eth1 track 10 state is [up]
ip route 50.1.1.0 255.255.255.0 20.1.1.4 track 10 state is [up]
```

show ip rpf

Use this command to display reverse path forwarding (RPF) information for the specified source address.

Command Syntax

```
show ip rpf A.B.C.D
show ip rpf (vrf NAME|) A.B.C.D
```

Parameters

A.B.C.D	IP address of multicast source.
NAME	Virtual Routing and Forwarding name.

Default

None

Command Mode

Exec and Privileged Exec mode

Applicability

This command was introduced before OcnOS version 1.3.

Example

```
#show ip rpf 10.10.10.50

RPF information for 10.10.10.50
RPF interface: eth0
RPF neighbor: 10.1.2.1
RPF route: 0.0.0.0/0
RPF type: unicast (kernel)
RPF recursion count: 0
Doing distance-preferred lookups across tables
Distance: 0
Metric: 0
#
```

[Table 1-2](#) explains the output fields.

Table 1-2: show ip rpf output fields

Field	Description
RPF Interface	Name of the RPF interface.
RPF neighbor	Upstream RPF neighbor.
RPF route	Route table in which the logical interface address is located.
RPF type	Different type of RPF like multicast, unicast, MBGP, DVMRP, or static mroutes.

Table 1-2: show ip rpf output fields

Field	Description
RPF recursion count	Number of times that the router lookups its routing table more than once to find out the immediate next-hop and exiting interface.
Distance	IP address of the remote side of the connection. Doing distance-preferred lookups across tables.
Metric	Metrics are informational units that can be measured and compared.

Show ipv6 route track-table

Use this command to display ipv4 static routes that are associated to a tracking id across all vrfs.

Command Syntax

```
Show ipv6 route track-table
```

Parameters

None

Default

NA

Command Mode

Privileged Exec mode and Exec mode

Applicability

This command was introduced in OcNOS version 5.1.

Examples

```
#show ipv6 route track-table  
ipv6 route 5000::/64 eth1 track 10 state is [up]
```

show ipv6 rpf

Use this command to display reverse path forwarding (RPF) information for the specified source address.

Command Syntax

```
show ipv6 rpf X:X::X:X
show ipv6 rpf (vrf NAME|) X:X::X:X
```

Parameters

X:X::X:X	IP address of multicast source.
NAME	Virtual Routing and Forwarding name.

Default

None

Command Mode

Exec and privileged exec mode

Applicability

This command was introduced before OcnOS version 1.3.

Example

```
#show ipv6 rpf 10:10::10:50

RPF information for 10.10.10.50
RPF interface: eth0
RPF neighbor: 10.1.2.1
RPF route: 0.0.0.0/0
RPF type: unicast (kernel)
RPF recursion count: 0
Doing distance-preferred lookups across tables
Distance: 0
Metric: 0
#
```

[Table 1-3](#) explains the output fields.

Table 1-3: show ipv6 rpf output fields

Field	Description
RPF Interface	Name of the RPF interface.
RPF neighbor	Upstream RPF neighbor.
RPF route	Route table in which the logical interface address is located.
RPF type	Different type of RPF like multicast, unicast, MBGP, DVMRP, or static mroutes.

Table 1-3: show ipv6 rpf output fields

Field	Description
RPF recursion count	Number of times that the router lookups its routing table more than once to find out the immediate next-hop and exiting interface.
Distance	IPv6 address of the remote side of the connection. Doing distance-preferred lookups across tables.
Metric	Metrics are informational units that can be measured and compared.

show router-id

Use this command to display the Router ID of the current system.

Command Syntax

```
show router-id
```

Parameters

None

Default

None

Command Mode

Privileged Exec mode and Exec mode

Applicability

This command was introduced before OcNOS version 1.3.

Example

```
#show router-id  
Router ID: 10.55.0.2 (automatic)
```

show running-config router

Use this command to display the running system router configuration.

Command Syntax

```
show running-config router bgp
show running-config router isis
show running-config router ldp
show running-config router ospf
show running-config router rip
show running-config router rsvp
show running-config router vrrp
```

Parameters

bgp	Display Border Gateway Protocol (BGP) information.
isis	Display Intermediate System to Intermediate System (IS-IS) information.
ldp	Display Label Distribution Protocol (LDP) information.
ospf	Display Open Shortest Path First (OSPF) information.
rip	Display Routing Information Protocol (RIP) information.
rsvp	Display Resource Reservation Protocol (RSVP) information.
vrrp	Display Virtual Router Redundancy Protocol (VRRP) information.

Default

None

Command Mode

Privileged exec mode, configure mode, router-map mode

Applicability

This command was introduced before OcNOS version 1.3.

Example

```
>enable
#show running-config router vrrp
!
router-id 3.3.3.3
!
```

show running-config router-id

Use this command to show the running system global router ID configuration.

Command Syntax

```
show running-config router-id
```

Parameters

None

Default

None

Command Mode

Privileged Exec mode

Applicability

This command was introduced before OcNOS version 1.3.

Example

```
>enable
#show running-config router-id
!
router-id 3.3.3.3
!
```

show running-config urpf

Use this command to check uRPF status for this system.

Command Syntax

```
show running-config urpf
```

Parameters

None

Default

None

Command Mode

Exec mode and Privileged exec mode

Applicability

This command was introduced before OcNOS version 1.3.

Example

```
#show running-config urpf  
ip urpf enable
```

```
(config)#show running-config urpf  
ip urpf enable
```

show running-config vrf

Use this command to show the running system status and configuration details for a specified VRF instance name.

Command Syntax

```
show running-config vrf WORD
```

Parameters

WORD Virtual Routing and Forwarding name

Command Mode

Privileged exec mode, configure mode, router mode

Applicability

This command was introduced before OcnOS version 1.3.

Example

```
>enable
#show running-config vrf xyz
!
ip vrf xyz
  description vrf
  router-id 11.11.11.11
```

snmp restart rib

Use this command to restart SNMP in Routing Information Base (RIB)

Command Syntax

```
snmp restart rib
```

Parameters

None

Default

By default, snmp restart command is disabled.

Command Mode

Configure mode

Applicability

This command was introduced before OcNOS version 1.3.

Examples

```
#config terminal  
(config)#snmp restart rib
```

CHAPTER 2 Route-Map Commands

This chapter describes route-map commands.

- [continue](#)
- [match as-path](#)
- [match community](#)
- [match extcommunity](#)
- [match interface](#)
- [match ip address](#)
- [match ip address prefix-list](#)
- [match ip next-hop](#)
- [match ip next-hop prefix-list](#)
- [match ip peer](#)
- [match ipv6 address](#)
- [match ipv6 address prefix-list](#)
- [match ipv6 next-hop](#)
- [match ipv6 next-hop prefix-list](#)
- [match ipv6 peer](#)
- [match metric](#)
- [match origin](#)
- [match route-type](#)
- [match tag](#)
- [route-map](#)
- [set aggregator](#)
- [set as-path](#)
- [set atomic-aggregate](#)
- [set comm-list](#)
- [set community](#)
- [set dampening](#)
- [set extcommunity](#)
- [set interface null0](#)
- [set ip next-hop](#)
- [set ipv6 next-hop](#)
- [set level](#)
- [set local-preference](#)
- [set metric](#)
- [set metric-type](#)
- [set origin](#)

- [set originator-id](#)
- [set tag](#)
- [set vpv4 next-hop](#)
- [set weight](#)
- [show route-map](#)
- [show running-config route-map](#)

continue

The `continue` clause provides the capability to execute additional entries in a route map after an entry is executed with a successful `match` and `set` clauses (i.e), the `continue` command allows multiple entries to be evaluated within a single route-map. Continue commands can be assigned optional `sequence numbers` that indicate the order in which clauses are to be evaluated.

Use the `no` form of the command (specifying a particular `sequence number` if desired), to remove individual or all `continue` clauses from a route-map.

Continue clause with match Clauses

When a `match` clause exists in a route map with `continue` clause, then the `continue` clause is executed only when a successful `match` occurs. If a `match` clause does not exist in the route-map and if a `continue` clause does exist, the `continue` clause will be evaluated and then go to the specified route-map entry. When a successful `match` occurs and we have a `continue` clause, the route-map executes the `set` clauses and then goes to the specified route-map entry. If `continue` clause does not exist in the next route map, then the route-map will behave normally. If a `continue` clause exists in the next route-map but a `match` is not successful, the route-map will not continue and will *fall through* to the next sequence number if one exists.

Continue clause with set Clauses

`Set` clauses are executed after the route-map evaluation is done. The `set` clauses are evaluated and executed in the order in which they were configured. `Set` clauses are only executed after a successful `match` occurs. The `continue` statement proceeds to the specified route-map entry only after configured `set` actions are performed. If a `set` action is configured in the first route-map and then the same `set` action occurs again, but with a different value in a subsequent route-map entry, then the last `set` action will override the previous `set` actions, which were configured with the same `set` command.

Command Syntax

```
continue <2-65535>|)
no continue <2-65535>|)
```

Parameter

<2-65535> Continue sequence number.

Default

No default value is specified

Command Mode

Route-map mode

Applicability

This command was introduced before OcNOS version 1.3.

Example

```
(config)#route-map Rmap1
(config-route-map)#continue ?
<2-65535> Route-map entry sequence number
<cr>
(config-route-map)#continue 10
```

```
(config-route-map)#continue 30
```

match as-path

Use this command to match an autonomous system path access list. This command specifies the autonomous system path to be matched. If there is a match for the specified AS path, and `permit` is specified, the route is redistributed or controlled, as specified by the set action. If the match criteria are met, and `deny` is specified, the route is not redistributed or controlled. If the match criteria are `not` met then the route is neither accepted nor forwarded, irrespective of `permit` or `deny` specifications.

The route specified by the policies might not be the same as specified by the routing protocols. Setting policies enable packets to take different routes, depending on their length or content. Packet forwarding based on configured policies overrides packet forwarding specified in routing tables.

Note: This command is valid only for BGP.

Use the `no` parameter with this command to remove a path list entry.

Command Syntax

```
match as-path WORD
no match as-path (WORD|)
```

Parameter

WORD Autonomous system path access list name.

Default

Enabled

Command Mode

Route-map mode

Applicability

This command was introduced before OcNOS version 1.3.

Example

```
#configure terminal
(config)#route-map myroute deny 34
(config-route-map)#match as-path myaccesslist
```

match community

Use this command to specify the community to be matched.

Communities are used to group and filter routes. They are designed to provide the ability to apply policies to large numbers of routes by using match and set commands. Community lists are used to identify and filter routes by their common attributes. This command allows the matching based on community lists.

The values set by the `match community` command overrides the global values. The route that does not match at least one match clause is ignored.

Note: This command is valid only for BGP.

Use the `no` parameter with this command to remove the community list entry.

Command Syntax

```
match community (<1-99>|<100-199>|WORD) (exact-match|)
no match community (<1-99>|<100-199>|WORD|) (exact-match|)
```

Parameters

<1-99>	Community-list number (standard).
<100-199>	Community-list number (expanded).
WORD	Community-list name.
exact-match	Do exact matching of communities.

Default

No default value is specified

Command Mode

Route-map mode

Applicability

This command was introduced before OcNOS version 1.3.

Examples

```
#configure terminal
(config)#route-map myroute permit 3
(config-route-map)#match community mylist
```

match extcommunity

Use this command to match BGP external community list

Communities are used to group and filter routes. They are designed to provide the ability to apply policies to large numbers of routes by using match and set commands. Community lists are used to identify and filter routes by their common attributes. This command allows the matching based on community lists.

The values set by this command overrides the global values. The route that does not match at least one match clause is ignored.

Note: This command is valid only for BGP.

Use the `no` parameter with this command to remove the community list entry.

Command Syntax

```
match extcommunity (<1-99>|<100-199>|WORD) (exact-match|)
no match extcommunity (<1-99>|<100-199>|WORD|) (exact-match|)
```

Parameters

<1-99>	Community-list number (standard).
<100-199>	Community-list number (expanded).
WORD	Name of the community-list.
exact-match	Do exact matching of communities.

Default

No default value is specified

Command Mode

Route-map mode

Applicability

This command was introduced before OcnOS version 1.3.

Example

```
#configure terminal
(config)#route-map myroute permit 3
(config-route-map)#match extcommunity mylist
```

match interface

Use this command to define the interface match criterion. This command specifies the next-hop interface name of a route to be matched.

Use the `no` parameter with this command to remove the specified match criterion.

Command Syntax

```
match interface IFNAME
no match interface (IFNAME|)
```

Parameter

IFNAME	Interface name.
--------	-----------------

Default

By default, match interface is disabled

Command Mode

Route-map mode

Applicability

This command was introduced before OcNOS version 1.3.

Example

```
#configure terminal
(config)#route-map mymap1 permit 10
(config-route-map)#match interface eth0
```

match ip address

Use this command to specify the match address of route. If there is a match for the specified IP address, and `permit` is specified, the route is redistributed or controlled, as specified by the set action. If the match criteria are met, and `deny` is specified then the route is not redistributed or controlled. If the match criteria are not met, the route is neither accepted nor forwarded, irrespective of `permit` or `deny` specifications.

The route specified by the policies might not be the same as specified by the routing protocols. Setting policies enable packets to take different routes, depending on their length or content. Packet forwarding based on configured policies overrides packet forwarding specified in routing tables.

Use the `no` parameter with this command to remove the `match ip address` entry.

Command Syntax

```
match ip address (<1-199>|<1300-2699>|WORD)
no match ip address (<1-199>|<1300-2699>|WORD|)
```

Parameters

WORD	IP access-list name.
<1-199>	IP access-list number (standard range).
<1300-2699>	IP access-list number (expanded range).

Default

No default value is specified

Command Mode

Route-map mode

Applicability

This command was introduced before OcnOS version 1.3.

Example

```
#configure terminal
(config)#route-map myroute permit 3
(config-route-map)#match ip address List1
```

match ip address prefix-list

Use this command to match entries of a prefix-list. The route specified by the policies might not be the same as specified by the routing protocols. Setting policies enable packets to take different routes depending on their length or content. Packet forwarding based on configured policies overrides packet forwarding specified in routing tables.

Use the `no` parameter with this command to disable this function

Command Syntax

```
match ip address prefix-list WORD
no match ip address prefix-list (WORD|)
```

Parameter

WORD IP prefix list name.

Default

No default value is specified

Command Mode

Route-map mode

Applicability

This command was introduced before OcnOS version 1.3.

Examples

```
#configure terminal
(config)#route-map rmap1 permit 3
(config-route-map)#match ip address prefix-list mylist
```

match ip next-hop

Use this command to specify a next-hop address to be matched in a route-map. The route specified by the policies might not be the same as specified by the routing protocols. Setting policies enable packets to take different routes depending on their length or content. Packet forwarding based on configured policies overrides packet forwarding specified in routing tables.

Use the `no` parameter with this command to disable this function.

Command Syntax

```
match ip next-hop (<1-199>|<1300-2699>|WORD)
no match ip next-hop (<1-199>|<1300-2699>|WORD|)
```

Parameters

WORD	Specify the IP access-list name.
<1-199>	Specify the IP access-list number (standard range).
<1300-2699>	Specify the IP access-list number (expanded range).

Default

No default value is specified

Command Mode

Route-map mode

Applicability

This command was introduced before OcnOS version 1.3.

Examples

```
#configure terminal
(config)#route-map rmap1 permit 3
(config-route-map)#match ip next-hop mylist
```

match ip next-hop prefix-list

Use this command to specify the next-hop IP address match criterion using the prefix-list. This command matches the next-hop IP address of a route.

Use the `no` parameter with this command to remove the specified match criterion.

Command Syntax

```
match ip next-hop prefix-list WORD
no match ip next-hop prefix-list (WORD|)
```

Parameter

WORD	Prefix-list name.
------	-------------------

Default

No default value is specified

Command Mode

Route-map mode

Applicability

This command was introduced before OcNOS version 1.3.

Examples

```
#configure terminal
(config)#route-map mymap permit 3
(config-route-map)#match ip next-hop prefix-list list1
```

match ip peer

Use this command to specify the match peer IPv4 address of a route.

Use the `no` parameter with this command to remove the specified match criterion.

Command Syntax

```
match ip peer (<1-199>|<1300-2699>|WORD)
no match ip peer (<1-199>|<1300-2699>|WORD|)
```

Parameter

WORD	IP access-list name.
<1-199>	IP access-list number (standard range).
<1300-2699>	IP access-list number (expanded range).

Default

No default value is specified

Command Mode

Route-map mode

Applicability

This command was introduced before OcnOS version 1.3.

Examples

```
#configure terminal
(config)#route-map mymap permit 3
(config-route-map)#match ip peer 123

(config-route-map)#no match ip peer 123
```

match ipv6 address

Use this command to specify the match address of route. The route specified by the policies might not be the same as specified by the routing protocols. Setting policies enable packets to take different routes depending on their length or content. Packet forwarding based on configured policies overrides packet forwarding specified in routing tables.

Use the `no` parameter with this command to remove the `match ip address` entry.

Note: This command is valid for BGP, OSPFv3, and RIPng only.

Command Syntax

```
match ipv6 address WORD
no match ipv6 address (WORD|)
```

Parameter

WORD IPv6 access list name.

Default

No default value is specified

Command Mode

Route-map mode

Applicability

This command was introduced before OcnOS version 1.3.

Examples

```
#configure terminal
(config)#route-map myRM deny 1
(config-route-map)#match ipv6 address myRM
```

match ipv6 address prefix-list

Use this command to match entries of a prefix-list. The route specified by the policies might not be the same as specified by the routing protocols. Setting policies enable packets to take different routes, depending on their length or content. Packet forwarding based on configured policies overrides packet forwarding specified in routing tables.

Note: This command is valid for BGP, OSPFv3, and RIPng only.

Use the `no` parameter with this command to disable this function

Command Syntax

```
match ipv6 address prefix-list WORD
no match ipv6 address prefix-list (WORD|)
```

Parameter

WORD IPv6 access list name.

Default

No default value is specified

Command Mode

Route-map mode

Applicability

This command was introduced before OcNOS version 1.3.

Examples

```
#configure terminal
(config)#route-map rmap1 permit 3
(config-route-map)#match ipv6 address prefix-list mylist
```

match ipv6 next-hop

Use this command to specify the next-hop address to be matched. The route specified by the policies might not be the same as specified by the routing protocols. Setting policies enable packets to take different routes depending on their length or content. Packet forwarding based on configured policies overrides packet forwarding specified in routing tables.

Note: This command is valid for BGP and IS-IS only.

Use the `no` parameter with this command to disable this function

Command Syntax

```
match ipv6 next-hop (X:X::X:X|WORD)
no match ipv6 next-hop (X:X::X:X|WORD|)
```

Parameters

X:X::X:X	IPv6 address of the next-hop.
WORD	IPv6 access list name.

Default

No default value is specified

Command Mode

Route-map mode

Applicability

This command was introduced before OcNOS version 1.3.

Examples

```
#configure terminal
(config)#route-map rmap1 permit 3
(config-route-map)#match ipv6 next-hop 3ffe::1
```

match ipv6 next-hop prefix-list

Use this command to match entries of a prefix-list. The route specified by the policies might not be the same as specified by the routing protocols. Setting policies enable packets to take different routes depending on their length or content. Packet forwarding based on configured policies overrides packet forwarding specified in routing tables.

Note: This command is valid for BGP and IS-IS only.

Use the `no` parameter with this command to disable this function

Command Syntax

```
match ipv6 next-hop prefix-list WORD
no match ipv6 next-hop prefix-list WORD
```

Parameters

WORD IPv6 access list name.

Default

No default value is specified

Command Mode

Route-map mode

Applicability

This command was introduced before OcNOS version 1.3.

Examples

```
#configure terminal
(config)#route-map rmap1 permit 3
(config-route-map)#match ipv6 next-hop prefix-list new
```

match ipv6 peer

Use this command to specify the match peer IPv6 address of a route.

Use the `no` parameter with this command to remove the specified match criterion.

Command Syntax

```
match ipv6 peer (<1-199>|<1300-2699>|WORD)
no match ipv6 peer (<1-199>|<1300-2699>|WORD|)
```

Parameter

WORD	IP access-list name.
<1-199>	IP access-list number (standard range).
<1300-2699>	IP access-list number (expanded range).

Default

No default value is specified

Command Mode

Route-map mode

Applicability

This command was introduced before OcnOS version 1.3.

Examples

```
#configure terminal
(config)#route-map mymap permit 3
(config-route-map)#match ipv6 peer 123

(config-route-map)#no match ipv6 peer 123
```

match metric

Use this command to match a metric of a route. The route specified by the policies might not be the same as specified by the routing protocols. Setting policies enable packets to take different routes depending on their length or content. Packet forwarding based on configured policies overrides packet forwarding specified in routing tables.

Note: This command is valid for BGP, OSPF, RIP, and IS-IS only.

Use the `no` parameter with this command to disable this function

Command Syntax

```
match metric <0-4294967295>
no match metric (<0-4294967295>|)
```

Parameters

<0-4261412864> Metric value.

Default

No default value is specified

Command Mode

Route-map mode

Applicability

This command was introduced before OcnOS version 1.3.

Examples

```
#configure terminal
(config)#route-map myroute permit 3
(config-route-map)#match metric 888999
```

match origin

Use this command to match origin code. The origin attribute defines the origin of the path information. The `egp` parameter is indicated as an `e` in the routing table, and it indicates that the origin of the information is learned via EGP (Exterior Gateway Protocol). The `igp` parameter is indicated as an `i` in the routing table, and it indicates the origin of the path information is interior to the originating AS. The `incomplete` parameter is indicated as a `?` in the routing table, and indicates that the origin of the path information is unknown or learned through other means. If a static route is redistributed into BGP, the origin of the route is incomplete.

This command specifies the origin to be matched. If there is a match for the specified origin, and `permit` is specified when you created the route-map, the route is redistributed or controlled as specified by the `set` action. If the match criteria are met, and `deny` is specified, the route is not redistributed or controlled. If the match criteria are not met, the route is neither accepted nor forwarded, irrespective of `permit` or `deny` specifications.

The route specified by the policies might not be the same as specified by the routing protocols. Setting policies enable packets to take different routes depending on their length or content. Packet forwarding based on configured policies overrides packet forwarding specified in routing tables.

Note: This command is valid only for BGP.

Use the `no` parameter with this command to disable this matching.

Command Syntax

```
match origin (egp|igp|incomplete)
no match origin (egp|igp|incomplete|)
```

Parameters

<code>egp</code>	Remote exterior gateway protocol.
<code>igp</code>	Local internal gateway protocol.
<code>incomplete</code>	Unknown heritage.

Default

No default value is specified

Command Mode

Route-map mode

Applicability

This command was introduced before OcNOS version 1.3.

Example

```
#configure terminal
(config)#route-map myroute deny 34
(config-route-map)#match origin egp
```

match route-type

Use this command to match an external route type. AS-external LSA is either Type-1 or Type-2. External type-1 matches only Type 1 external routes and external type-2 matches only Type 2 external routes.

Use the `no` parameter with this command to turn off the matching.

Command Syntax

```
match route-type external (type-1|type-2)
no match route-type external (type-1|type-2|)
```

Parameters

<code>type-1</code>	Match OSPF External Type 1 metric.
<code>type-2</code>	Match OSPF External Type 2 metric.

Default

By default, match route type external is disabled

Command Mode

Route-map mode

Applicability

This command was introduced before OcnOS version 1.3.

Examples

```
#configure terminal
(config)#route-map mymap1 permit 10
(config-route-map)#match route-type external type-1
```

match tag

Use this command to match the specified tag value.

Use the `no` parameter with this command to turn off the declaration.

Command Syntax

```
match tag <0-4294967295>
no match tag (<0-4294967295>|)
```

Parameters

<0-4294967295> Tag value.

Default

By default, match tag is disabled

Command Mode

Route-map mode

Applicability

This command was introduced before OcNOS version 1.3.

Examples

```
#configure terminal
(config)#route-map mymap1 permit 10
(config-route-map)#match tag 100
```

route-map

Use this command to enter route-map mode and to permit or deny match/set operations.

This command controls and modifies routing information to allow redistribution of routes. It has a list of `match` and `set` commands associated with it. The `match` commands specify the conditions under which redistribution is allowed, and the `set` commands specify the particular redistribution actions to be performed if the criteria enforced by `match` commands are met. Route maps are used for detailed control over route distribution between routing processes.

Route maps also allow policy routing, and might route packets to a different route than the obvious shortest path.

Use the `no` parameter with this command to turn off the declaration.

Command Syntax

```
route-map WORD (deny|permit) <1-65535>
no route-map WORD ((deny|permit) <1-65535>|)
```

Parameters

WORD	Route-map name (maximum size 63 characters).
deny	Route map deny set operations. If this parameter is specified, and the match criteria are met, the route is not redistributed, and any other route maps with the same map tag are not examined.
permit	Route map permit set operations. If this parameter is specified, and the match criteria are met, the route is redistributed as specified by the set actions. If the <code>match</code> criteria are not met, the next route map with the same tag is tested.
<1-65535>	Sequence to insert into or delete from an existing route-map.

Default

No default value is specified

Command Mode

Configure mode

Applicability

This command was introduced before OcNOS version 1.3.

Example

```
#configure terminal
(config)#route-map routel permit 1
(config-route-map)#
```

set aggregator

Use this command to set the AS number for the route map and router ID. An Autonomous System (AS) is a collection of networks under a common administration sharing a common routing strategy. It is subdivided by areas, and is assigned a unique 16-bit number. Use the `set aggregator` command to assign an AS number for the aggregator.

To use the `set aggregator` command, you must first have a match clause. `Match` and `set` commands set the conditions for redistributing routes from one routing protocol to another. The `match` command specifies the match criteria under which redistribution is allowed for the current route-map. The `set` command specifies the set redistribution actions to be performed, if the match criteria are met.

If the packets do not match any of the defined criteria, they are routed through the normal routing process.

Use the `no` parameter with this command to disable this function

Command Syntax

```
set aggregator as <1-65535> A.B.C.D
no set aggregator as (<1-65535> A.B.C.D|)
```

Parameters

<1-65535>	AS number of aggregator.
A.B.C.D	IP address of aggregator.

Default

No default value is specified

Command Mode

Route-map mode

Applicability

This command was introduced before OcNOS version 1.3.

Examples

```
#configure terminal
(config)#route-map myroute permit 3
(config-route-map)#set aggregator as 43 10.10.0.3
```

set as-path

Use this command to modify an autonomous system path for a route. By specifying the length of the AS-Path, the router influences the best path selection by a neighbor. Use this command to prepend an AS path string to routes increasing the AS path length.

To use this command, you must first give the `match` and `set` commands configure the conditions for redistributing routes from one routing protocol to another:

- The `match` command specifies the match criteria under which redistribution is allowed for the current route-map.
- The `set` command specifies the set redistribution actions to be performed if the match criteria are met.

If the packets do not match any of the defined criteria, they are routed through the normal routing process.

Use the `no` parameter with this command to disable this function.

Command Syntax

```
set as-path prepend .<1-65535>
set as-path prepend .<1-4294967295>
no set as-path prepend (.<1-65535>|)
no set as-path prepend (.<1-4294967295>|)
```

Parameters

<1-65535> OcNOS prepends this number to the AS path.

Default

No default value is specified

Command Mode

Route-map mode

Applicability

This command was introduced before OcNOS version 1.3.

Examples

```
#configure terminal
(config)#route-map myroute permit 3
(config-route-map)#set as-path prepend 8 24
```

set atomic-aggregate

Use this command to set an atomic aggregate attribute.

To use this command, you must first have a match clause. `match` and `set` commands set the conditions for redistributing routes from one routing protocol to another. The `match` command specifies the match criteria under which redistribution is allowed for the current route-map. The `set` command specifies the set redistribution actions to be performed, if the match criteria are met.

If the packets do not match any of the defined criteria, they are routed through the normal routing process.

Use the `no` parameter with this command to disable this function

Command Syntax

```
set atomic-aggregate
no set atomic-aggregate
```

Parameters

No default value is specified

Default

None

Command Mode

Route-map mode

Applicability

This command was introduced before OcNOS version 1.3.

Examples

```
#configure terminal
(config)#route-map rmap1 permit 3
(config-route-map)#set atomic-aggregate
```

set comm-list

Use this command to delete the matched communities from the community attribute of an inbound or outbound update when applying route-map.

Use the `no` parameter with this command to disable this feature.

Command Syntax

```
set comm-list (<1-99>|<100-199>|WORD) delete
no set comm-list (<1-99>|<100-199>|WORD) delete
```

Parameters

<1-99>	Standard community-list number.
<100-199>	Expanded community-list number.
WORD	Name of the community-list.

Default

No default value is specified

Command Mode

Route-map mode

Applicability

This command was introduced before OcnOS version 1.3.

Examples

```
#configure terminal
(config)#route-map myRM permit 3
(config-route-map)#set comm-list 34 delete
```

set community

Use this command to set the communities attribute. and group destinations in a certain community, as well as apply routing decisions according to those communities.

To use this command, you must first have a match clause. `Match` and `set` commands set the conditions for redistributing routes from one routing protocol to another. The `match` command specifies the match criteria under which redistribution is allowed for the current route-map. The `set` command specifies the set redistribution actions to be performed, if the match criteria are met.

If the packets do not match any of the defined criteria, they are routed through the normal routing process.

Use the `no` parameter with this command to delete the entry.

Command Syntax

```
set community [<65536-4294901759>|AA:NN|internet|local-AS|no-advertise|no-export|none] (additive|)
no set community [AA:NN|internet|local-AS|no-advertise|no-export|none] (additive|)
```

Parameters

<65536-4294901759>	Community number
AA:NN	The community number in aa:nn format.
internet	Internet.
local-AS	Do not send outside the local AS (well-known community).
no-advertise	Do not advertise this route to eBGP peers
no-export	Do not advertise this route to any peer.
none	Remove the community attribute from the prefixes that pass the route-map.
additive	Add to the existing community.

Default

No default value is specified

Command Mode

Route-map mode

Applicability

This command was introduced before OcNOS version 1.3.

Examples

The following examples show the use of the `set community` command with different parameters.

```
#configure terminal
(config)#route-map rmap1 permit 3
(config-route-map)#set community no-export no-advertise

#configure terminal
(config)#route-map rmap1 permit 3
(config-route-map)#set community no-advertise
```

```
#configure terminal
(config)#route-map rmap1 permit 3
(config-route-map)#set community 10:01 23:34 12:14 no-export
```

set dampening

Use this command to enable route-flap dampening and set parameters. Set the unreachable half-life time to be equal to, or greater than, reachability half-life time. The suppress-limit value must be greater than or equal to the reuse limit value.

Use the `no` parameter with this command to delete the entry.

Command Syntax

```
set dampening <1-45> <1-20000> <1-20000> <1-255> (<1-45>|)
no set dampening <1-45> <1-20000> <1-20000> <1-255> (<1-45>|)
```

Parameters

<1-45>	Reachability half-life time in minutes. The time for the penalty to decrease to one-half of its current value.
<1-20000>	Reuse-limit value. When the penalty for a suppressed route decays below the reuse value, the routes become unsuppressed.
<1-20000>	Suppress-limit value. When the penalty for a route exceeds the suppress value, the route is suppressed.
<1-255>	Max-suppress-time. Maximum time that a dampened route is suppressed.
<1-45>	Unreachability half-life time for penalty, in minutes.

Default

Default reachability half-life time: 15 minutes

Default reuse limit value: 750

Default suppress limit value: 2000

Default max-suppress value is 4 times the half-life time (60 minutes)

Default unreachable half-life time value: 15 minutes

Command Mode

Route-map mode

Applicability

This command was introduced before OcNOS version 1.3.

Example

```
#configure terminal
(config)#route-map R1 permit 24
(config-route-map)#set dampening 20 333 534 30
```

set extcommunity

Use this command to set an extended community attribute.

To use this command you must first have a match clause. The `match` and `set` commands define the conditions for redistributing routes from one routing protocol to another:

- The `match` command defines the match criteria under which redistribution is allowed for the current route-map.
- The `set` command defines the set redistribution actions to be performed, if the match criteria are met.

If the packets do not match any of the defined criteria, they are routed through the normal routing process.

Use the `no` parameter with this command to disable this function.

Command Syntax

```
set extcommunity rt .AA:NN (additive|)
set extcommunity soo .AA:NN
set extcommunity cost (igp|pre-bestpath|) <0-255> <0-4294967295>
set extcommunity color <1-4294967295>
no set extcommunity rt (.AA:NN|) (additive|)
no set extcommunity soo (.AA:NN|)
no set extcommunity cost (igp|pre-bestpath|) <0-255> <0-4294967295>
no set extcommunity color <1-4294967295>
```

Parameters

<code>rt</code>	Route target extended community.
<code>.AA:NN</code>	VPN extended community
<code>additive</code>	Add to the existing community.
<code>soo</code>	Site-of-origin extended community.
<code>cost</code>	Extended cost community.
<code>igp</code>	Compare following IGP cost comparison.
<code>pre-bestpath</code>	Compare following IGP cost comparison.
<code><0-255></code>	Community ID.
<code><0-4294967295></code>	Cost.
<code>color</code>	Color value extended community

Default

No default value is specified

Command Mode

Route-map mode

Applicability

This command was introduced before OcNOS version 1.3.

Examples

```
#configure terminal
(config)#route-map rmap1 permit 3
(config-route-map)#set extcommunity rt 06:01

#configure terminal
(config)#route-map rmap1 permit 3
(config-route-map)#set extcommunity rt 0.0.0.6:01

#configure terminal
(config)#route-map rmap1 permit 3
(config-route-map)#set extcommunity soo 06:01

#configure terminal
(config-route-map)#route-map rmap1 permit 3
(config-route-map)#set extcommunity soo 0.0.0.6:01

#configure terminal
(config-route-map)#route-map rmap1 permit 3
(config-route-map)#set extcommunity color 101
```

set interface null0

Use this command to discard routes based on policy/rules configured for a route map.

Route maps can be applied to BGP neighbors. When this command is given for a route map and that route map is applied to a BGP neighbor, the discard route entries are added by BGP for the prefix permitted by the route map.

Use the `no` form of this command to not discard routes based on policy/rules configured for a route map.

Command Syntax

```
set interface null0
no set interface null0
```

Parameters

None

Default

No default value is specified

Command Mode

Route-map mode

Applicability

This command was introduced before OcNOS version 1.3.

Example

To discard 1.1.1.1/24 from BGP neighbor 30.1.1.1:

```
#configure terminal
(config)#ip prefix-list myPrefixList seq 5 permit 1.1.1.1/24 eq 24
(config)#route-map myRM permit 1
(config-route-map)#match ip address prefix-list myPrefixList
(config-route-map)#set interface null0
(config-route-map)#exit
(config)#router bgp 200
(config-router)#neighbor 30.1.1.1 remote-as 200
(config-router)#neighbor 30.1.1.1 route-map myRM in
```

set ip next-hop

Use this command to set the specified next-hop value.

Use the `no` parameter with this command to turn off the setting.

Note: This command is valid for BGP, OSPF, and RIP only.

Command Syntax

```
set ip next-hop A.B.C.D
no set ip next-hop (A.B.C.D|)
```

Parameter

A.B.C.D IP address of the next-hop.

Default

By default, `set ip next hop A.B.C.D` is disabled

Command Mode

Route-map mode

Applicability

This command was introduced before OcnOS version 1.3.

Examples

```
#configure terminal
(config)#route-map mymap permit 3
(config-route-map)#set ip next-hop 10.10.0.67
```

set ipv6 next-hop

Use this command to set a next hop-address.

Use the `no` parameter with this command to delete an entry.

Note: This command is valid for BGP and OSPFv3 only.

Command Syntax

```
set ipv6 next-hop X:X::X:X
set ipv6 next-hop local X:X::X:X
no set ipv6 next-hop (X:X::X:X|)
no set ipv6 next-hop local (X:X::X:X|)
```

Parameters

X:X::X:X	Global IPv6 address of the nexthop.
local	Local IPv6 address of the nexthop.

Default

By default, set ipv6 next hop X:X::X:X is disabled

Command Mode

Route-map mode

Applicability

This command was introduced before OcNOS version 1.3.

Examples

```
#configure terminal
(config)#route-map rmap1 permit 3
(config-route-map)#set ipv6 next-hop local fe80::203:47ff:fe97:66dc
```

set level

Use this command to set the IS-IS level to export a route.

Use the `no` parameter with this command to disable this function.

Command Syntax

```
set level (level-1|level-2|level-1-2)
no set level (level-1|level-2|level-1-2|)
```

Parameters

<code>level-1</code>	Export into a level-1 area.
<code>level-2</code>	Export into a level-2 sub-domain.
<code>level-1-2</code>	Export into level-1 and level-2.

Default

By default, set level is disabled

Command Mode

Route-map mode

Applicability

This command was introduced before OcNOS version 1.3.

Examples

```
#configure terminal
(config)#route-map rmap1 permit 3
(config-route-map)#set level level-1
```

set local-preference

Use this command to set the BGP local preference path attribute.

Use the `no` parameter with this command to disable this function.

Command Syntax

```
set local-preference <0-4294967295>
no set local-preference (<0-4294967295>|)
```

Parameters

<0-4294967295> Tag value for destination routing protocol.

Default

By default, set local preference is disabled

Command Mode

Route-map mode

Applicability

This command was introduced before OcNOS version 1.3.

Example

```
#configure terminal
(config)#route-map rmap1 permit 3
(config-route-map)#set local-preference 12
```

set metric

Use this command to set a metric value for a route and influence external neighbors about the preferred path into an Autonomous System (AS). The preferred path is the one with a lower metric value. A router compares metrics for paths from neighbors in the same ASs. To compare metrics from neighbors coming from different ASs, use the `bgp always-compare-med` command.

To use this command, you must first have a match clause. `Match` and `set` commands set the conditions for redistributing routes from one routing protocol to another. The `match` command specifies the match criteria under which redistribution is allowed for the current route-map. The `set` command specifies the set redistribution actions to be performed, if the match criteria are met.

If the packets do not match any of the defined criteria, they are routed through the normal routing process.

Use the `no` parameter with this command to disable this function.

Command Syntax

```
set metric WORD
no set metric (WORD|)
```

Parameters

WORD Metric value [+/-] <1-4294967295>

Default

No default value is specified

Command Mode

Route-map mode

Applicability

This command was introduced before OcnOS version 1.3.

Examples

```
#configure terminal
(config)#route-map rmap1 permit 3
(config-route-map)#set metric 600
```

set metric-type

Use this command to set the metric type for the destination routing protocol. Select a type to be either Type-1 or Type-2 in the AS-external-LSA when the route-map matches the condition.

Note: This command is for OSPF, OSPFv3, or IS-IS only.

Use the `no` parameter with this command to return to the default.

Command Syntax

```
set metric-type (internal|external)
set metric-type (type-1|type-2)
no set metric-type (internal|external|)
no set metric-type (type-1|type-2|)
```

Parameters

<code>external</code>	IS-IS external metric type.
<code>internal</code>	IS-IS internal metric type.
<code>type-1</code>	OSPF external type 1 metric.
<code>type-2</code>	OSPF external type 2 metric.

Default

No default value is specified

Command Mode

Route-map mode

Applicability

This command was introduced before OcNOS version 1.3.

Example

In this example the metric type of the destination protocol is set to OSPF external Type 1.

```
#configure terminal
(config)#route-map rmap1 permit 3
(config-route-map)#set metric-type type-1
```

set origin

Use this command to set the BGP origin code. The origin attribute defines the origin of the path information.

To use this command, you must first have a match clause. `match` and `set` commands set the conditions for redistributing routes from one routing protocol to another. The `match` command specifies the match criteria under which redistribution is allowed for the current route-map. The `set` command specifies the set redistribution actions to be performed, if the match criteria are met.

If the packets do not match any of the defined criteria, they are routed through the normal routing process.

Use the `no` parameter with this command to delete an entry.

Command Syntax

```
set origin (egp|igp|incomplete)
no set origin (egp|igp|incomplete|)
```

Parameters

<code>egp</code>	Learned through an Exterior Gateway Protocol.
<code>igp</code>	Interior to the originating AS. This happens when an Internal Gateway Protocol is redistributed into BGP.
<code>incomplete</code>	Unknown or learned through some other means. This happens when a static route is redistributed in BGP and the origin of the route is incomplete.

Default

No default value is specified

Command Mode

Route-map mode

Applicability

This command was introduced before OcnOS version 1.3.

Example

```
#configure terminal
(config)#route-map rmap1 permit 3
(config-route-map)#set origin egp
```

set originator-id

Use this command to set the originator ID attribute.

To use this command, you must first have a match clause. `match` and `set` commands set the conditions for redistributing routes from one routing protocol to another. The `match` command specifies the match criteria under which redistribution is allowed for the current route-map. The `set` command specifies the set redistribution actions to be performed, if the match criteria are met.

If the packets do not match any of the defined criteria, they are routed through the normal routing process.

Use the `no` parameter with this command to disable this function

Command Syntax

```
set originator-id A.B.C.D
no set originator-id (A.B.C.D|)
```

Parameter

A.B.C.D IP address of originator.

Default

No default value is specified

Command Mode

Route-map mode

Applicability

This command was introduced before OcnOS version 1.3.

Example

```
#configure terminal
(config)#route-map rmap1 permit 3
(config-route-map)#set originator-id 1.1.1.1
```

set tag

Use this command to set a tag value. The parameter is the route tag that is labeled by another routing protocol (BGP or other IGP when redistributing), because AS-external-LSA has a route-tag field in its LSAs. In addition, when using route-map, OcNOS can tag the LSAs with the appropriate tag value. Sometimes the tag matches with using route-map, and sometimes, the value may be used by another application.

Use the `no` parameter with this command to unset a tag value.

Command Syntax

```
set tag <0-4294967295>
no set tag (<0-4294967295>|)
```

Parameter

<0-4294967295> Tag value for destination routing protocol.

Default

No default value is specified

Command Mode

Route-map mode

Applicability

This command was introduced before OcNOS version 1.3.

Example

In the following example the tag value of the destination routing protocol is set to 6:

```
#configure terminal
(config)#route-map rmap1 permit 3
(config-route-map)#set tag 6
```

set vpnv4 next-hop

Use this command to set a VPNv4 next-hop address.

To use this command, you must first have a match clause. `Match` and `set` commands set the conditions for redistributing routes from one routing protocol to another. The `match` command specifies the match criteria under which redistribution is allowed for the current route-map. The `set` command specifies the set redistribution actions to be performed, if the match criteria are met.

If the packets do not match any of the defined criteria, they are routed through the normal routing process.

Note: This command is valid for BGP only.

Use the `no` parameter with this command to disable this function

Command Syntax

```
set vpnv4 next-hop A.B.C.D
no set vpnv4 next-hop (A.B.C.D|)
```

Parameter

A.B.C.D IP address of originator.

Default

No default value is specified

Command Mode

Route-map mode

Applicability

This command was introduced before OcNOS version 1.3.

Example

```
#configure terminal
(config)#route-map rmap1 permit 3
(config-route-map)#set vpnv4 next-hop 6.6.6.6
```

set weight

Use this command to set weights for the routing table.

The weight value is used to assist in best path selection. It is assigned locally to a router. When there are several routes with a common destination, the routes with a higher weight value are preferred.

To use this command, you must first have a match clause. `match` and `set` commands set the conditions for redistributing routes from one routing protocol to another. The `match` command specifies the match criteria under which redistribution is allowed for the current route-map. The `set` command specifies the set redistribution actions to be performed, if the match criteria are met.

Note: This command is valid only for BGP.

Use the `no` parameter with this command to delete an entry.

Command Syntax

```
set weight <0-4294967295>
no set weight (<0-4294967295>|)
```

Parameter

<0-4294967295> Weight value.

Default

No default value is specified

Command Mode

Route-map mode

Applicability

This command was introduced before OcNOS version 1.3.

Examples

In the following configuration, all routes that apply to access-list 10 will have the weight set at 400. If the packets do not match any of the defined criteria, they are routed through the normal routing process.

```
#configure terminal
(config)#route-map rmap1 permit 3
(config-route-map)#match as-path 10
(config-route-map)#set weight 400
```

show route-map

Use this command to display route-map information.

Command Syntax

```
show route-map (|WORD)
```

Parameters

WORD Route-map name (maximum size 63 characters)

Command Mode

Exec mode and Privileged Exec mode

Applicability

This command was introduced before OcNOS version 1.3.

Example

The following is a sample output of the `show route-map` command.

```
#show route-map
route-map myRM, permit, sequence 1
  Match clauses:
    metric 200
  Set clauses:
    metric 60
#
```

[Table 2-4](#) explains the output fields.

Table 2-4: show route-map details

Field	Description
route-map	Name of a route map.
permit	Routes that match the match clauses are redistributed according to the conditions defined by the set clauses.
sequence	Position of this route map in sequence of route-maps with the same name.
Match clauses	Routes that match the conditions defined by the match clause are redistributed according to the conditions defined by the set clauses.
Set clauses	Routes that pass the match clause are redistributed according to the conditions defined by the set clauses.

show running-config route-map

Use this command to display the running system status and configuration details for route-maps.

Command Syntax

```
show running-config route-map
```

Parameters

None

Command Mode

Privileged Exec mode

Applicability

This command was introduced before OcNOS version 1.3.

Example

```
>enable
#show running-config route-map
!
route-map abc deny 2
  match community 2
!
route-map abc permit 3
  match route-type external type-2
  set metric-type type-1
!
```

VRF Lite Configuration Guide

CHAPTER 1 BGP Configuration

Overview

Border Gateway Protocol (BGP) makes core routing decisions on the Internet using a table of IP networks or “prefixes” which designate network reachability among autonomous systems (AS). BGP is a path vector protocol or a variant of a distance-vector routing protocol. BGP does not involve traditional Interior Gateway Protocol (IGP) metrics, but routing decisions are made based on path, network policies, and/or rule sets. For this reason, it is more appropriately termed a reachability protocol rather than routing protocol.

Note: Enabling dynamic capability on the specific BGP peer will prevent BGP session to reset.

Topology



Figure 1-157: BGP topology for VRF

Configuration

R1

#con t	Enter configuration mode.
(config)#ip vrf vrf1	Create vrf1
(config-vrf)#rd 800:1	Specify the route distinguisher in the VRF
(config-vrf)#route-target import 800:1	Specify the import route target
(config-vrf)#route-target export 800:1	Specify the export route target
(config-vrf)#exit	Exit VRF mode
(config)#router bgp 200	Enter the bgp configuration mode
(config-router)#address-family ipv4 vrf vrf1	Enter address family mode for vrf1
(config-router-af)#neighbor 2.2.2.2 remote-as 100	Specify the BGP neighbor and remote-AS.
(counter-router-af)#neighbor 2.2.2.2 activate	Activate neighbor in the address family
(config-router-af)#exit	Exit address family mode.
(config-router)#ex	Exit router mode
(config)#interface eth1	Enter interface mode
(config-if)#ip vrf forwarding vrf1	Associate the interface to vrf1
(config-if)#ip address 2.2.2.1/24	Configure the IP address 2.2.2.1 to eth1
(config-if)#commit	Commit the candidate configuration to the running configuration
(config-if)#exit	Exit interface mode

R2

#configure terminal	Enter configure mode.
(config)#ip vrf vrf1	Create vrf1
(config-vrf)#rd 800:1	Specify the route distinguisher in the VRF
(config-vrf)#route-target import 800:1	Specify the import route target
(config-vrf)#route-target export 800:1	Specify the export route target
(config-vrf)#exit	Exit vrf mode
(config)#router bgp 100	Enter router mode.
(config-router)#address-family ipv4 vrf vrf1	Enter address family mode for vrf1
(config-router-af)#neighbor 2.2.2.1 remote-as 200	Specify the BGP neighbor and remote-as.
(counter-router-af)# neighbor 2.2.2.1 activate activate neighbor	Specify the BGP neighbor and remote-AS.
(config-router-af)#exit	Exit address family mode.
(config-router)#ex	Exit router mode
(config)#interface eth1	Enter interface mode
(config-if)#ip vrf forwarding vrf1	Associate the interface to vrf1
(config-if)#ip address 2.2.2.2/24	Configure the IP address 2.2.2.1 to eth1
(config-if)#commit	Commit the candidate configuration to the running configuration
(config-if)#exit	Exit interface mode

Validation

Verify the routing table in R1:

```
R1#show ip bgp neighbors
BGP neighbor is 2.2.2.2, vrf vrf1, remote AS 100, local AS 200, external link
  BGP version 4, local router ID 2.2.2.1, remote router ID 2.2.2.2
  BGP state = Established, up for 00:00:07
  Last read 00:00:07, hold time is 90, keepalive interval is 30 seconds
  Neighbor capabilities:
    Route refresh: advertised and received (old and new)
  Received 4 messages, 1 notifications, 0 in queue
  Sent 5 messages, 0 notifications, 0 in queue
  Route refresh request: received 0, sent 0
  Minimum time between advertisement runs is 30 seconds
  Connections established 2; dropped 1
  Local host: 2.2.2.1, Local port: 49722
  Foreign host: 2.2.2.2, Foreign port: 179
  Nexthop: 2.2.2.1
  Nexthop global: ::
  Nexthop local: ::
  BGP connection: non shared network
  Last Reset: 00:00:12, due to BGP Notification received
  Notification Error Message: (Cease/Other Configuration Change.)
```

Verify the routing table in R2:

```
R2#show ip bgp neighbors
BGP neighbor is 2.2.2.1, vrf vrf1, remote AS 200, local AS 100, external link
  BGP version 4, local router ID 2.2.2.2, remote router ID 2.2.2.1
  BGP state = Established, up for 00:02:36
  Last read 00:00:08, hold time is 90, keepalive interval is 30 seconds
  Neighbor capabilities:
    Route refresh: advertised and received (old and new)
    Received 10 messages, 0 notifications, 0 in queue
    Sent 9 messages, 1 notifications, 0 in queue
    Route refresh request: received 0, sent 0
    Minimum time between advertisement runs is 30 seconds
  Connections established 2; dropped 1
Local host: 2.2.2.2, Local port: 179
Foreign host: 2.2.2.1, Foreign port: 49722
Nexthop: 2.2.2.2
Nexthop global: ::
Nexthop local: ::
BGP connection: non shared network
Last Reset: 00:02:41, due to Configuration Change (Cease Notification sent)
Notification Error Message: (Cease/Other Configuration Change.)
```

R1

```
R1#show ip route vrf vrf1
Codes: K - kernel, C - connected, S - static, R - RIP, B - BGP
       O - OSPF, IA - OSPF inter area
       N1 - OSPF NSSA external type 1, N2 - OSPF NSSA external type 2
       E1 - OSPF external type 1, E2 - OSPF external type 2
       i - IS-IS, L1 - IS-IS level-1, L2 - IS-IS level-2,
       ia - IS-IS inter area, E - EVPN,
       v - vrf leaked
       * - candidate default
```

IP Route Table for VRF "vrf1"

```
C          2.2.2.0/24 is directly connected, eth1, 00:04:03
```

Gateway of last resort is not set

R2

```
R2#show ip route vrf vrf1
Codes: K - kernel, C - connected, S - static, R - RIP, B - BGP
       O - OSPF, IA - OSPF inter area
       N1 - OSPF NSSA external type 1, N2 - OSPF NSSA external type 2
       E1 - OSPF external type 1, E2 - OSPF external type 2
       i - IS-IS, L1 - IS-IS level-1, L2 - IS-IS level-2,
       ia - IS-IS inter area, E - EVPN,
       v - vrf leaked
       * - candidate default
```

BGP Configuration

IP Route Table for VRF "vrf1"

```
C          2.2.2.0/24 is directly connected, eth1, 00:14:44
```

```
Gateway of last resort is not set
```

Verify BGP Adjacency

Use the following `show` commands to verify the BGP adjacency:

```
show ip bgp neighbor
```

CHAPTER 2 VRF Configuration

Overview

Virtual routing and forwarding (VRF) is a technology that allows multiple instances of a routing table to co-exist within the same router at the same time. Because the routing instances are independent, the same or overlapping IP addresses can be used without conflicting with each other. VRF may be implemented in a network device by distinct routing tables known as forwarding information bases – one per routing instance.

Topology



Figure 2-158: Device topology

Default VRF

#con t	Enter the router configuration mode
(config)#interface eth1	Switch to interface eth1
(config-if)#ip address 3.3.3.2/24	Configure the ip address 3.3.3.2 to eth1
(config-if)#commit	Commit the candidate configuration to the running configuration
(config-if)#exit	Exit interface mode.

Adding a Static Route

#con t	Enter the router configuration mode
(config)#ip route 20.20.20.0/24 eth1	Add static route with eth1 as exit interface
(config-if)#commit	Commit the candidate configuration to the running configuration

User-Defined VRF

#con t	Enter configuration mode.
(config)#ip vrf vrf1	Create vrf1. Use no ip vrf vrf1 to delete the created vrf
(config)#exit	Exit configure mode.

VRF Configuration

(config)#interface eth1	Enter interface mode
(config-if)#ip vrf forwarding vrf1	Associate eth1 to vrf1. Use no ip vrf forwarding vrf1 for un-configuration
(config-if)#ip address 3.3.3.2/24	Configure the IP address 3.3.3.2 to eth1
(config-if)#commit	Commit the candidate configuration to the running configuration
(config-if)#exit	Exit interface mode.

Adding a Static Route

#con t	Enter the router configuration mode
(config)# ip route vrf vrf1 20.20.20.0/24 eth1	Add static route in vrf1 with eth1 as exit interface
(config-if)#commit	Commit the candidate configuration to the running configuration

Validation

```
#show ip route vrf all
Codes: K - kernel, C - connected, S - static, R - RIP, B - BGP
       O - OSPF, IA - OSPF inter area
       N1 - OSPF NSSA external type 1, N2 - OSPF NSSA external type 2
       E1 - OSPF external type 1, E2 - OSPF external type 2
       i - IS-IS, L1 - IS-IS level-1, L2 - IS-IS level-2,
       ia - IS-IS inter area, E - EVPN,
       v - vrf leaked
       * - candidate default
```

```
IP Route Table for VRF "default"
C     127.0.0.0/8 is directly connected, lo, 00:14:59
C     192.168.52.0/24 is directly connected, eth0, 00:14:55
IP Route Table for VRF "management"
IP Route Table for VRF "vrf1"
C     3.3.3.0/24 is directly connected, eth1, 00:00:44
S     20.20.20.0/24 [1/0] is directly connected, eth1, 00:00:08
```

```
Gateway of last resort is not set
```

To display the IP routing table associated with a VRF, use the `show ip route vrf vrf-name` command

```
#sh ip route vrf vrf1
Codes: K - kernel, C - connected, S - static, R - RIP, B - BGP
       O - OSPF, IA - OSPF inter area
       N1 - OSPF NSSA external type 1, N2 - OSPF NSSA external type 2
       E1 - OSPF external type 1, E2 - OSPF external type 2
       i - IS-IS, L1 - IS-IS level-1, L2 - IS-IS level-2,
       ia - IS-IS inter area, E - EVPN,
       v - vrf leaked
       * - candidate default
```

IP Route Table for VRF "vrf1"

C 3.3.3.0/24 is directly connected, eth1, 00:01:22

S 20.20.20.0/24 [1/0] is directly connected, eth1, 00:00:13

Gateway of last resort is not set

Use this show command to display the static routes configured

```
#sh ip route vrf vrf1 static
```

IP Route Table for VRF "vrf1"

S 20.20.20.0/24 [1/0] is directly connected, eth1, 00:01:13

Gateway of last resort is not set

CHAPTER 3 Static Inter-VRF Route Leaking Configuration

Overview

Inter-VRF route leaking allows the leaking of routes from one VRF (the source VRF) to another VRF (the destination VRF) on the same router. Inter-VRF routes can exist in any VRF (including the default and management VRF) on the system. Route-Leaking between two non-default VRF is achieved using MP-BGP (RT and RD). This section covers leaking between the Default VRF and any Non-default VRF using Statically.

Topology



Figure 3-159: Device topology

Note: By default eth0 is in management VRF.

IPV4 Inter-VRF Route Leaking Configuration

R1

#con t	Enter the router configuration mode
(config)#ip vrf vrf1	Create vrf1
(config-vrf)#exit	Exit VRF mode
(config)#interface eth1	Switch to interface eth1
(config-if)#ip address 20.1.1.1/24	Assign the IP address 20.1.1.1 to eth1
(config-if)#exit	Exit interface mode.
(config)#interface eth2	Switch to interface eth2.
(config-if)#ip vrf forwarding vrf1	Associate eth1 to vrf1. Use no ip vrf forwarding vrf1 for un-configuration.
(config-if)#ip address 10.1.1.1/24	Assign the IP address 10.1.1.1 to eth2 in vrf1.
(config-if)#exit	Exit interface mode.
(config)#ip route 10.1.1.0/24 eth2	Leaking non-default VRF's connected route into default VRF.
(config)#ip route vrf management 30.1.1.0/24 20.1.1.2 eth1 global	Leaking a route from the Default VRF into the "management" VRF statically.
(config)#ip route vrf vrf1 20.1.1.0/24 20.1.1.2 eth1 global	Leaking a route from the Default VRF into VRF "vrf1" statically.
(config)#ip route vrf vrf1 30.1.1.0/24 20.1.1.2 eth1 global	Leaking a route from the Default VRF into VRF "vrf1" statically.

Static Inter-VRF Route Leaking Configuration

(config-if)#commit	Commit the candidate configuration to the running configuration
(config-if)#exit	Exit interface mode

R2

#con t	Enter the router configuration mode
(config)#interface eth1	Switch to interface eth1
(config-if)#ip address 20.1.1.2/24	Assign the IP address 20.1.1.2 to eth1 in vrf1
(config-if)#exit	Exit interface mode.
(config)#interface eth2	Switch to interface eth2
(config-if)#ip address 30.1.1.1/24	Assign the IP address 30.1.1.1 to eth2 in vrf1
(config-if)#exit	Exit interface mode.
(config)# ip route 10.1.1.0/24 20.1.1.1	Configuring static route to non-default VRF.
(config-if)#commit	Commit the candidate configuration to the running configuration
(config-if)#exit	Exit interface mode

Validation

R1

```
#show ip route vrf all
```

```
Codes: K - kernel, C - connected, S - static, R - RIP, B - BGP
```

```
       O - OSPF, IA - OSPF inter area
```

```
       N1 - OSPF NSSA external type 1, N2 - OSPF NSSA external type 2
```

```
       E1 - OSPF external type 1, E2 - OSPF external type 2
```

```
       i - IS-IS, L1 - IS-IS level-1, L2 - IS-IS level-2,
```

```
       ia - IS-IS inter area, E - EVPN,
```

```
       v - vrf leaked
```

```
       * - candidate default
```

```
IP Route Table for VRF "default"
```

```
S    v    10.1.1.0/24 [1/0] is directly connected, xe12, 00:37:31
```

```
C    20.1.1.0/24 is directly connected, xe14, 00:00:17
```

```
C    127.0.0.0/8 is directly connected, lo, 3d06h01m
```

```
IP Route Table for VRF "management"
```

```
C    10.12.87.0/24 is directly connected, eth0, 3d06h00m
```

```
S    v    30.1.1.0/24 [1/0] via 20.1.1.2, xe14, 00:00:17
```

```
C    127.0.0.0/8 is directly connected, lo.management, 3d06h01m
```

```
IP Route Table for VRF "vrf1"
```

```
C    10.1.1.0/24 is directly connected, xe12, 02:27:07
```

```
S    v    20.1.1.0/24 [1/0] via 20.1.1.2, xe14, 00:00:17
```

```
S    v    30.1.1.0/24 [1/0] via 20.1.1.2, xe14, 00:00:17
```

```
C    127.0.0.0/8 is directly connected, lo.vrf1, 02:41:58
```

To display the IP routing table associated with a VRF, use the `show ip route vrf vrf-name` command

```
#show ip route vrf all database
Codes: K - kernel, C - connected, S - static, R - RIP, B - BGP
       O - OSPF, IA - OSPF inter area
       N1 - OSPF NSSA external type 1, N2 - OSPF NSSA external type 2
       E1 - OSPF external type 1, E2 - OSPF external type 2
       i - IS-IS, L1 - IS-IS level-1, L2 - IS-IS level-2,
       ia - IS-IS inter area, E - EVPN,
       v - vrf leaked
       > - selected route, * - FIB route, p - stale info
```

```
IP Route Table for VRF "default"
S    *> v10.1.1.0/24 [1/0] is directly connected, xe12, 00:39:15
C    *> 20.1.1.0/24 is directly connected, xe14, 00:02:01
C    *> 127.0.0.0/8 is directly connected, lo, 3d06h02m
IP Route Table for VRF "management"
C    *> 10.12.87.0/24 is directly connected, eth0, 3d06h02m
S    *> v30.1.1.0/24 [1/0] via 20.1.1.2, xe14, 00:02:01
C    *> 127.0.0.0/8 is directly connected, lo.management, 3d06h02m
IP Route Table for VRF "vrf1"
C    *> 10.1.1.0/24 is directly connected, xe12, 02:28:51
S    *> v20.1.1.0/24 [1/0] via 20.1.1.2, xe14, 00:02:01
S    *> v30.1.1.0/24 [1/0] via 20.1.1.2, xe14, 00:02:01
C    *> 127.0.0.0/8 is directly connected, lo.vrf1, 02:43:42
```

Gateway of last resort is not set

IPv6 Inter-VRF Route Leaking Configuration

IPv6 Statically Routes can be leaked between the Default VRF and Private VRF and vice-versa.

Note: IPv6 Leaking between "management" VRF and the default VRF is not supported in this release.

R1

#con t	Enter the router configuration mode
(config)#ip vrf vrf1	Create vrf1
(config-vrf)#exit	Exit VRF mode
(config)#interface eth1	Switch to interface eth1
(config-if)#ipv6 address 2001::1/64	Assign the IPv6 address 2001::1 to eth1
(config-if)#exit	Exit interface mode.
(config)#interface eth2	Switch to interface eth2.
(config-if)#ip vrf forwarding vrf1	Associate eth1 to vrf1. Use no ip vrf forwarding vrf1 for un-configuration.
(config-if)#ipv6 address 3001::1/64	Assign the IPv6 address 3001::1 to eth2 in vrf1
(config-if)#exit	Exit interface mode.
(config)# ipv6 route 3001::/64 eth2	Leaking non-default VRF's connected route into default VRF.
OcNOS(config)#ipv6 route 3333::2/128 fe80::da9e:f3ff:fea2:6ce6 eth2	Leaking non-default VRF's non-connected route into default VRF

Static Inter-VRF Route Leaking Configuration

OcNOS(config)#ipv6 route vrf vrf1 2001::/64 eth1 global	Leaking a connected route from the Default VRF into VRF "vrf1" statically.
OcNOS(config)#ipv6 route vrf vrf1 2222::1/128 fe80::da9e:f3ff:fec9:65a4 eth1 global	Leaking a route from the Default VRF into the "vrf1" VRF statically
(config-if)#commit	Commit the candidate configuration to the running configuration
(config-if)#exit	Exit interface mode

Validation

R1

```
OcNOS#sh run ipv6 route
!
ipv6 route 3001::/64 eth2
ipv6 route 3333::/128 fe80::da9e:f3ff:fea2:6ce6 eth2
ipv6 route vrf vrf1 2001::/64 eth1 global
ipv6 route vrf vrf1 2222::1/128 fe80::da9e:f3ff:fec9:65a4 eth1 global
!
OcNOS#
```

```
OcNOS#sh ipv6 route vrf all
IPv6 Routing Table
Codes: K - kernel route, C - connected, S - static, R - RIP, O - OSPF,
      IA - OSPF inter area, E1 - OSPF external type 1,
      E2 - OSPF external type 2, E - EVPN, N1 - OSPF NSSA external type 1,
      N2 - OSPF NSSA external type 2, i - IS-IS, B - BGP
      v - vrf leaked
Timers: Uptime
```

```
IP Route Table for VRF "default"
C      ::1/128 via ::, lo, 01:14:24
C      2001::/64 via ::, eth1, 01:14:24
O      2222::1/128 [110/1] via fe80::da9e:f3ff:fec9:65a4, eth1, 01:13:30
S v    3001::/64 [1/0] via ::, eth2, 00:00:32
S v    3333::2/128 [1/0] via fe80::da9e:f3ff:fea2:6ce6, eth2, 00:01:22
C      fe80::/64 via ::, eth4, 01:14:24
IP Route Table for VRF "management"
C      ::1/128 via ::, lo.management, 01:14:24
C      fe80::/64 via ::, eth0, 01:14:24
IP Route Table for VRF "vrf1"
C      ::1/128 via ::, lo.vrf1, 01:14:24
S v    2001::/64 [1/0] via ::, eth1, 01:14:24
S v    2222::1/128 [1/0] via fe80::da9e:f3ff:fec9:65a4, eth1, 01:14:24
C      3001::/64 via ::, eth2, 01:14:24
i L1   3333::2/128 [115/20] via fe80::da9e:f3ff:fea2:6ce6, eth2, 01:14:17
C      fe80::/64 via ::, eth2, 01:14:24
```

CHAPTER 4 OSPF Configuration

Overview

Open Shortest Path First (OSPF) is an interior routing protocol operating within a single autonomous system (AS) that uses a link state routing algorithm. OSPF gathers link state information from available routers and constructs a topology map of the network. The topology determines the routing table presented to the Internet layer which makes routing decisions based solely on the destination IP address in IP packets.

This chapter covers OSPF configuration in non-default VRF.

Topology



Figure 4-160: OSPF topology for VRF

Configuration IPv4 VRF

R1

#con t	Enter the router config mode.
(config)#ip vrf vrf1	Create vrf1
(config-vrf)#exit	Exit VRF mode
(config)#router ospf 1 vrf1	Associate the ospf process with vrf1.
(config-router)#network 2.2.2.0/24 area 0	Specify the network type and area 0.
(config-router)#ex	Exit the OSPF configuration mode.
(config)#interface eth1	Enter interface mode.
(config-if)#ip vrf forwarding vrf1	Associate eth1 to vrf1.
(config-if)#ip address 2.2.2.1/24	Assign the IP address 2.2.2.1 to eth1 in vrf1
(config-if)#commit	Commit the candidate configuration to the running configuration

R2

#con t	Enter the router config mode
(config)#ip vrf vrf1	Create vrf1
(config-vrf)#exit	Exit VRF mode
(config)#router ospf 1 vrf1	Associate the ospf process with vrf1

OSPF Configuration

(config-router)#network 2.2.2.0/24 area 0	Specify the network type and area 0.
(config-router)#ex	Exit router mode.
(config)#interface eth1	Enter interface mode.
(config-if)#ip vrf forwarding vrf1	Associate eth1 to vrf1.
(config-if)#ip address 2.2.2.2/24	Assign the IP address 2.2.2.1 to eth1 in vrf1
(config-if)#commit	Commit the candidate configuration to the running configuration

Validation

R1

```
#show ip route vrf vrf1
```

```
Codes: K - kernel, C - connected, S - static, R - RIP, B - BGP
```

```
       O - OSPF, IA - OSPF inter area
```

```
       N1 - OSPF NSSA external type 1, N2 - OSPF NSSA external type 2
```

```
       E1 - OSPF external type 1, E2 - OSPF external type 2
```

```
       i - IS-IS, L1 - IS-IS level-1, L2 - IS-IS level-2,
```

```
       ia - IS-IS inter area, E - EVPN,
```

```
       v - vrf leaked
```

```
       * candidate default
```

```
IP Route Table for VRF "vrf1"
```

```
C           2.2.2.0/24 is directly connected, eth1, 00:02:27
```

```
Gateway of last resort is not set
```

R2

```
#show ip route vrf vrf1
```

```
Codes: K - kernel, C - connected, S - static, R - RIP, B - BGP
```

```
       O - OSPF, IA - OSPF inter area
```

```
       N1 - OSPF NSSA external type 1, N2 - OSPF NSSA external type 2
```

```
       E1 - OSPF external type 1, E2 - OSPF external type 2
```

```
       i - IS-IS, L1 - IS-IS level-1, L2 - IS-IS level-2,
```

```
       ia - IS-IS inter area, E - EVPN,
```

```
       v - vrf leaked
```

```
       * candidate default
```

```
IP Route Table for VRF "vrf1"
```

```
C           2.2.2.0/24 is directly connected, eth1, 00:01:49
```

```
Gateway of last resort is not set
```

CHAPTER 5 ISIS Configuration

Overview

Intermediate System to Intermediate System (IS-IS) is an interior routing protocol operating within a single administrative domain. It is a link-state routing protocol, operating by reliably flooding link state information throughout a network of routers. Each IS-IS router independently builds a database of the network's topology, aggregating the flooded network information. IS-IS uses Dijkstra's algorithm for computing the best path through the network. Packets (datagrams) are then forwarded, based on the computed ideal path, through the network to the destination.

Topology



Figure 5-161: ISIS Topology for VRF

Configuration IPv4 VRF

R1

#configure terminal	Enter configuration mode.
(config)#ip vrf vrf1	Create vrf1
(config-vrf)#exit	Exit VRF mode
(config)#router isis 1 vrf1	Associate the ISIS process to vrf1
(config-router)#net 49.0001.0000.0000.0001.00	Establish a network entity title for this instance, specifying the area address and the system ID.
(config-router)#is-type level-1	Configure instance 1 as level-1 routing
(config-router)#exit	Exit router mode
(config)#interface eth1	Enter interface mode
(config-if)#ip vrf forwarding vrf1	Associate the interface to vrf1
(config-if)#ip address 2.2.2.1/24	Configure the IP address 2.2.2.1 to eth1
(config-if)#ip router isis 1	Enable ISIS routing on an instance for area 49
(config-if)#isis circuit-type level-1	Configure interface as level-1
(config-if)#commit	Commit the candidate configuration to the running configuration
(config-if)#exit	Exit interface mode
(config)#exit	Exit config mode

R2

#con t	Enter configuration mode.
(config)#ip vrf vrf1	Create vrf1
(config-vrf)#exit	Exit VRF mode
(config)#router isis 1 vrf1	Associate the ISIS process to vrf1
(config-router)#net 49.0001.0000.0000.0002.00	Establish a network entity title for this instance, specifying the area address and the system ID.
(config-router)#is-type level-1	Configure instance 1 as level-1 routing
(config-router)#exit	Exit router mode
(config)#interface eth1	Enter interface mode
(config-if)#ip vrf forwarding vrf1	Associate the interface to vrf1
(config-if)#ip address 2.2.2.2/24	Configure the IP address 2.2.2.1 to eth1
(config-if)#ip router isis 1	Enable ISIS routing on an instance for area 49
(config-if)#isis circuit-type level-1	Configure interface as level-1
(config-if)#commit	Commit the candidate configuration to the running configuration
(config-if)#exit	Exit interface mode
(config)#exit	Exit config mode

Validation

R1

```
#show clns neighbors
```

```
Total number of L1 adjacencies: 1
Total number of L2 adjacencies: 0
Total number of adjacencies: 1
```

```
Tag 1: VRF : vrf1
```

System Id	Interface	SNPA	State	Holdtime	Type	Protocol
0000.0000.0002	eth1	5254.0047.dc01	Up	24	L1	IS-IS

R2

```
#show clns neighbors
```

```
Total number of L1 adjacencies: 1
Total number of L2 adjacencies: 0
Total number of adjacencies: 1
```

```
Tag 1: VRF : vrf1
```

System Id	Interface	SNPA	State	Holdtime	Type	Protocol
0000.0000.0001	eth1	5254.0060.d535	Up	5	L1	IS-IS

R1

```
#show ip isis route
```

```
Codes: C - connected, E - external, L1 - IS-IS level-1, L2 - IS-IS level-2
```

ia - IS-IS inter area, D - discard, e - external metric
 ** invalid

Tag 1: VRF : vrf1

	Destination	Metric	Next-Hop	Interface	Tag
C	2.2.2.0/24	10	-	eth1	0

R2

#show ip isis route

Codes: C - connected, E - external, L1 - IS-IS level-1, L2 - IS-IS level-2
 ia - IS-IS inter area, D - discard, e - external metric
 ** invalid

Tag 1: VRF : vrf1

	Destination	Metric	Next-Hop	Interface	Tag
C	2.2.2.0/24	10	-	eth1	0

CHAPTER 6 ISIS IPv6 VRF Configuration

Overview

Intermediate System to Intermediate System (IS-IS) is an interior routing protocol operating within a single administrative domain. It is a link-state routing protocol, operating by reliably flooding link state information throughout a network of routers. Each IS-IS router independently builds a database of the network's topology, aggregating the flooded network information. IS-IS uses Dijkstra's algorithm for computing the best path through the network. Packets (datagrams) are then forwarded, based on the computed ideal path, through the network to the destination.

Topology



Figure 6-162: ISISv6 Topology for VRF

R1

#configure terminal	Enter configuration mode.
(config)#ip vrf vrf1	Create vrf1
(config-vrf)#exit	Exit VRF mode
(config)#router isis 1 vrf1	Associate the ISIS process to vrf1
(config-router)#net 49.0001.0000.0000.0001.00	Establish a network entity title for this instance, specifying the area address and the system ID.
(config-router)#is-type level-1	Configure instance 1 as level-1 routing
(config-router)#exit	Exit router mode
(config)#interface eth1	Enter interface mode
(config-if)#ip vrf forwarding vrf1	Associate the interface to vrf1
(config-if)#ipv6 address 1000::1/64	Configure ipv6 address on eth1
(config-if)#ipv6 router isis 1	Enable ISISv6 routing on an instance for area 49
(config-if)#isis circuit-type level-1	Configure interface as level-1
(config-if)#commit	Commit the candidate configuration to the running configuration
(config-if)#exit	Exit interface mode
(config)#exit	Exit config mode

R2

#con t	Enter configuration mode.
(config)#ip vrf vrf1	Create vrf1
(config-vrf)#exit	Exit VRF mode
(config)#router isis 1 vrf1	Associate the ISIS process to vrf1
(config-router)#net 49.0001.0000.0000.0002.00	Establish a network entity title for this instance, specifying the area address and the system ID.
(config-router)#is-type level-1	Configure instance 1 as level-1 routing
(config-router)#exit	Exit router mode
(config)#interface eth1	Enter interface mode
(config-if)#ip vrf forwarding vrf1	Associate the interface to vrf1
(config-if)#ipv6 address 1000::2/64	Configure ipv6 address on eth1
(config-if)#ipv6 router isis 1	Enable ISISv6 routing on an instance for area 49
(config-if)#isis circuit-type level-1	Configure interface as level-1
(config-if)#commit	Commit the candidate configuration to the running configuration
(config-if)#exit	Exit interface mode
(config)#exit	Exit config mode

Validation

R1#show clns neighbors

Total number of L1 adjacencies: 1
 Total number of L2 adjacencies: 0
 Total number of adjacencies: 1

Tag 1: VRF : vrf1

System Id	Interface	SNPA	State	Holdtime	Type	Protocol
0000.0000.0002	eth1	b86a.97c4.31c5	Up	27	L1	IS-IS

R1#

R1#show ipv6 isis route

Codes: C - connected, E - external, L1 - IS-IS level-1, L2 - IS-IS level-2
 ia - IS-IS inter area, D - discard, e - external metric

Tag 1: VRF : vrf1

C 1000::/64 [10]
 via ::, eth1

R1#

#

R2#show clns neighbors

Total number of L1 adjacencies: 1

Total number of L2 adjacencies: 0

Total number of adjacencies: 1

Tag 1: VRF : vrf1

System Id	Interface	SNPA	State	Holdtime	Type	Protocol
0000.0000.0001	eth1	b86a.97cb.3ec5	Up	8	L1	IS-IS

R2#

R2#show ipv6 isis route

Codes: C - connected, E - external, L1 - IS-IS level-1, L2 - IS-IS level-2
 ia - IS-IS inter area, D - discard, e - external metric

Tag 1: VRF : vrf1

C 1000::/64 [10]
 via ::, eth1

R2#

Border Gateway Protocol Command Reference

CHAPTER 1 BGP Commands

This chapter describes the BGP configuration commands.

- [address-family](#)
- [aggregate-address](#)
- [auto-summary](#)
- [bgp aggregate-next-hop-check](#)
- [bgp always-compare-med](#)
- [bgp as-local-count](#)
- [bgp bestpath as-path ignore](#)
- [bgp bestpath as-path multipath-relax](#)
- [bgp bestpath compare-confed-aspath](#)
- [bgp bestpath compare-routerid](#)
- [bgp bestpath dont-compare-originator-id](#)
- [bgp bestpath med](#)
- [bgp bestpath tie-break-on-age](#)
- [bgp client-to-client reflection](#)
- [bgp cluster-id](#)
- [bgp confederation identifier](#)
- [bgp confederation peers](#)
- [bgp config-type](#)
- [bgp dampening](#)
- [bgp default local-preference](#)
- [bgp deterministic-med](#)
- [bgp enforce-first-as](#)
- [bgp extended-asn-cap](#)
- [bgp fast-external-failover](#)
- [bgp graceful-restart](#)
- [bgp g-shut](#)
- [bgp g-shut-capable](#)
- [bgp g-shut-local-preference](#)
- [bgp log-neighbor-changes](#)
- [mpls-next-hop-tracking](#)
- [bgp next-hop-trigger delay](#)
- [bgp next-hop-trigger enable](#)
- [bgp rfc1771-path-select](#)
- [bgp rfc1771-strict](#)
- [bgp router-id](#)

- `bgp scan-time`
- `bgp table-map`
- `bgp update-delay`
- `clear bgp (A.B.C.D|X:X::X:X)`
- `clear bgp *`
- `clear bgp * l2vpn evpn`
- `clear bgp <1-4294967295>`
- `clear bgp <1-4294967295> l2vpn evpn`
- `clear bgp A.B.C.D l2vpn evpn`
- `clear bgp dampening`
- `clear bgp external`
- `clear bgp flap-statistics`
- `clear bgp peer-group`
- `clear bgp peer-group WORD l2vpn evpn`
- `clear bgp statistics`
- `clear ip bgp * (description LINE|)*`
- `clear ip bgp (A.B.C.D|X:X::X:X|WORD) (description LINE|)`
- `clear ip bgp A.B.C.D`
- `clear ip bgp A.B.C.D vrf`
- `clear ip bgp all vrf (VRFNAME|all|default) (description LINE|)`
- `clear ip bgp table-map`
- `clear ip bgp vrf WORD (A.B.C.D|X:X::X:X|WORD) (description LINE|)`
- `debug bgp`
- `distance bgp`
- `exit-address-family`
- `ip as-path access-list`
- `ip community-list <1-99>`
- `ip community-list <100-500>`
- `ip community-list expanded`
- `ip community-list standard`
- `ip community-list WORD`
- `ip extcommunity-list <1-99>`
- `ip extcommunity-list <100-500>`
- `ip extcommunity-list expanded`
- `ip extcommunity-list standard`
- `l2vpn-unnumbered-mode`
- `match ip peer`
- `match large-community`
- `max-paths`

-
- `max-paths eigrp`
 - `neighbor activate`
 - `neighbor advertisement-interval`
 - `neighbor allowas-in`
 - `neighbor as-origination-interval`
 - `neighbor attribute-unchanged`
 - `neighbor authentication-key`
 - `neighbor capability dynamic`
 - `neighbor capability graceful-restart`
 - `neighbor capability orf prefix-list`
 - `neighbor collide-established`
 - `neighbor de-activate`
 - `neighbor default-originate`
 - `neighbor description`
 - `neighbor disallow-infinite-holdtime`
 - `neighbor distribute-list`
 - `neighbor dont-capability-negotiate`
 - `neighbor ebgp-multihop`
 - `neighbor enforce-multihop`
 - `neighbor extended-optional-param`
 - `neighbor fall-over bfd`
 - `neighbor filter-list`
 - `neighbor g-shut`
 - `neighbor g-shut-timer`
 - `neighbor limit`
 - `neighbor local-as`
 - `neighbor maximum-prefix`
 - `neighbor next-hop-self`
 - `neighbor optional-as`
 - `neighbor override-capability`
 - `neighbor passive`
 - `neighbor peer-group`
 - `neighbor WORD peer-group range`
 - `neighbor port`
 - `neighbor prefix-list`
 - `neighbor remote-as`
 - `neighbor remove-private-AS`
 - `neighbor restart-time`
 - `neighbor route-map`

- `neighbor route-reflector-client`
- `neighbor route-server-client`
- `neighbor send-community`
- `neighbor send-community large`
- `neighbor shutdown`
- `neighbor strict-capability-match`
- `neighbor timers`
- `neighbor unsuppress-map`
- `neighbor update-source`
- `neighbor version`
- `neighbor weight`
- `neighbor WORD peer-group`
- `network`
- `network synchronization`
- `redistribute`
- `restart bgp gracefull`
- `router bgp`
- `set large-community`
- `snmp restart bgp`
- `synchronization`
- `timers bgp`
- `v4-unnumbered-mode`
- `undebg bgp`
- `bgp unnumbered-mode`

address-family

Use the address family command to enter the IPv4 or VPNv4 address family mode allowing configuration of address-family specific parameters. To leave the address family mode and return to the Configure mode use the `exit-address-family` command.

This command configures the routing exchange between Provider Edge (PE) and Customer Edge (CE) devices. The BGP sessions between PE routers can carry different types of routes (VPN-IPv4 and IPv4 routes). Address families are used to control the type of BGP session. Configure a BGP address family for each VRF configured on the PE router and a separate address family to carry VPN-IPv4 routes between PE routers. All non VPN BGP neighbors are defined using router mode. All VPN BGP neighbors are defined under its associated address family mode. The BGP process with no address-family specified is the default address-family, where any sessions are configured that either are not associated with a VRF or are used to carry IPv4 routes.

Use the `no` parameter with this command to disable the address-family configurations.

Command Syntax

```
address-family ipv4
address-family ipv4 (unicast|multicast)
address-family ipv4 vrf NAME
address-family l2vpn evpn
address-family rtfilter unicast
address-family vpn4
address-family vpn4 unicast
no address-family ipv4 vrf NAME
no address-family ipv4 (unicast|multicast)
no address-family l2vpn evpn
no address-family rtfilter unicast
no address-family vpnv4
no address-family vpnv4 unicast
```

Parameters

<code>ipv4</code>	IPv4 address family
<code>unicast</code>	Unicast address prefixes
<code>multicast</code>	Multicast address prefixes
<code>vrf</code>	Virtual Private Network (VPN) routing/forwarding instance
<code>NAME</code>	VPN routing/forwarding instance name
<code>unicast</code>	Unicast address prefixes
<code>l2vpn evpn</code>	Layer 2 VPN routing sessions with EVPN endpoint information distributed to BGP peers
<code>rtfilter</code>	Route target filter: on an iBGP peer or Route Reflector (RR), only send IPv4 and IPv6 prefixes to PE routers when a PE has a VRF that imports those specific prefixes.
<code>unicast</code>	Unicast address prefixes
<code>vpnv4</code>	VPN version 4 address family
<code>unicast</code>	Unicast address prefixes

Applicability

No default value is specified

Command Mode

Router mode

Applicability

This command was introduced before OcNOS version 1.3.

Examples

```
#configure terminal
(config)#router bgp 7657
(config-router)#neighbor 3ffe:506::1 remote-as 7657
(config-router)#neighbor 3ffe:506::1 interface eth1
```

```
#configure terminal
(config)#router bgp 7657
(config-router)#address-family ipv4 unicast
(config-router-af)#neighbor 3ffe:506::1 activate
(config-router-af)#exit-address-family
```

aggregate-address

Use this command to configure BGP aggregate entries.

Aggregates are used to minimize the size of routing tables. Aggregation combines the characteristics of several different routes and advertises a single route. The `aggregate-address` command creates an aggregate entry in the BGP routing table if any more-specific BGP routes are available in the specified range. Using the `summary-only` parameter advertises the prefix only, suppressing the more-specific routes to all neighbors. In the following example Router1 will propagate network 172.0.0.0 and suppresses the more specific route 172.10.0.0.

The `as-set` parameter creates an aggregate entry advertising the path for this route, consisting of all elements contained in all paths being summarized. Use this parameter to reduce the size of path information by listing the AS number only once, even if it was included in multiple paths that were aggregated. The `as-set` parameter is useful when aggregation of information results in an incomplete path information.

Use the `no` parameter with this command to disable this function.

Command Syntax

```
aggregate-address A.B.C.D/M
aggregate-address A.B.C.D/M as-set
aggregate-address A.B.C.D/M as-set summary-only
aggregate-address A.B.C.D/M summary only
aggregate-address A.B.C.D/M summary-only as-set
no aggregate-address A.B.C.D/M
```

Parameters

A.B.C.D/M	Aggregate prefix
as-set	Generate AS set path information
summary-only	Filter more specific routes from updates

Default

By default, aggregate address A.B.C.D/M is disabled

Command Mode

Address Family mode

Applicability

This command was introduced before OcNOS version 1.3.

Examples

```
#configure terminal
(config)#router bgp 100
(config-router)#address-family ipv4 unicast
(config-router-af)#aggregate-address 10.0.0.0/8 as-set summary-only

(config)#router bgp 100
(config-router)#address-family ipv4 unicast
(config-router-af)#no aggregate-address 10.0.0.0/8
```

auto-summary

Use this command to enable sending summarized routes by a BGP speaker to its peers in the router configuration mode or in the address-family configuration mode. Auto-summary is used by a BGP router to advertise summarized routes to its peers. Auto-summary can be enabled if certain routes have already been advertised: in this case, configuring auto-summary advertises the summarized routes first, then corresponding non-summarized routes are withdrawn. If certain routes have already been advertised, and auto-summary is disabled, non-summarized routes are first advertised, then the corresponding summarized routes are withdrawn from all the connected peers.

Use the `no` parameter with this command to disable this function.

Command Syntax

```
auto-summary
no auto-summary
```

Parameters

None

Default

By default, auto-summary is disabled

Command Mode

Address Family mode

Applicability

This command was introduced before OcNOS version 1.3.

Examples

```
#configure terminal
(config)#router bgp 11
(config-router)#address-family ipv4 unicast
(config-router-af)#auto-summary
```

bgp aggregate-next-hop-check

Use this command to set the BGP option to perform aggregation only when next-hop matches the specified IP address. Use the `no` parameter with this command to disable this functionality.

Command Syntax

```
bgp aggregate-next-hop-check
no bgp aggregate-next-hop-check
```

Parameters

None

Default

By default, `bgp aggregate next-hop check` is disabled

Command Mode

Configure mode

Applicability

This command was introduced before OcNOS version 1.3.

Examples

```
#configure terminal
(config)#bgp aggregate-next-hop-check
```

bgp always-compare-med

Use this command to compare the Multi Exit Discriminator (MED) for paths from neighbors in different autonomous systems. Multi Exit Discriminator (MED) is used in best path selection by BGP. MED is compared after BGP attributes weight, local preference, AS-path and origin have been compared and are equal. MED comparison is done only among paths from the same autonomous system (AS). Use `bgp always-compare-med` command to allow comparison of MEDs from different ASs. The MED parameter is used to select the best path. A path with lower MED is preferred. If the `bgp` table shows the following and the `always-compare-med` is enabled:

```
Route1: as-path 400, med 300
Route2: as-path 200, med 200
Route3: as-path 400, med 250
```

Route1 is compared to Route2. Route2 is best of the two (lower MED). Next, Route2 is compared to Route3 and Route2 is chosen best path again (lower MED). If `always-compare-med` was disabled, MED is not taken into account when Route1 and Route2 are compared, because of different ASs and MED is compared for only Route1 and Route3. In this case, Route3 would be the best path. The selected route is also affected by the `bgp deterministic-med` command. Please see `bgp deterministic-med` command for details. If this command is used to compare MEDs for all paths, it should be configured on every BGP router in the AS.

Use the `no` parameter with this command to disallow the comparison.

Command Syntax

```
bgp always-compare-med
no bgp always-compare-med
```

Parameters

None

Default

By default, `bgp always compare med` is disabled

Command Mode

Router mode

Applicability

This command was introduced before OcNOS version 1.3.

Examples

```
#configure terminal
(config)#router bgp 100
(config-router)#bgp always-compare-med
```

bgp as-local-count

Use this command to set the number of times the local-AS (Autonomous System) is to be prepended.

Use the `no` parameter with this command to stop prepending the local AS count.

Command Syntax

```
bgp as-local-count <2-64>
no bgp as-local-count <2-64>
```

Parameter

<2-64> The number of times the local-AS is to be prepended

Default

By default, bgp as local count is disabled

Command Mode

Router mode

Applicability

This command was introduced before OcnOS version 1.3.

Examples

```
#configure terminal
(config)#router bgp 100
(config-router)#bgp as-local-count 55

(config)#router bgp 100
(config-router)#no bgp as-local-count 55
```

bgp bestpath as-path ignore

Use this command to prevent the router from considering the autonomous system (AS) path length as a factor in the algorithm for choosing a best path route.

Use the `no` parameter with this command to allow the router to consider the AS path length in choosing a best path route.

Command Syntax

```
bgp bestpath as-path ignore
no bgp bestpath as-path ignore
```

Parameters

None

Default

By default, `bgp bestpath as-path ignore` is disabled

Command Mode

Router mode

Applicability

This command was introduced before OcNOS version 1.3.

Examples

```
#configure terminal
(config)#router bgp 100
(config-router)#bgp bestpath as-path ignore

(config)#router bgp 100
(config-router)#no bgp bestpath as-path ignore
```

bgp bestpath as-path multipath-relax

Use this command to relax the “same AS-Path” requirement so any candidate eBGP AS-Path with the same AS-path length might be used for eBGP load-balancing.

Note: This feature does not load-balance between eBGP and iBGP paths.

Normally eBGP load-balancing requires the candidate routes to be equal-cost paths with identical BGP attributes having the same weight, Local-Pref, AS-Path (both the AS numbers and the AS path length), origin, MED, and different next-hop.

Use the `no` parameter with this command to return to normal operation.

Command Syntax

```
bgp bestpath as-path multipath-relax
no bgp bestpath as-path multipath-relax
```

Parameters

None

Default

By default, `as-path multipath-relax` is disabled

Command Mode

Router mode

Applicability

This command was introduced before OcNOS version 1.3.

Examples

```
#configure terminal
(config)#router bgp 100
(config-router)#bgp bestpath as-path multipath-relax

(config)#router bgp 100
(config-router)#no bgp bestpath as-path multipath-relax
```

bgp bestpath compare-confed-aspath

Use this command to allow comparing of the confederation AS path length. This command specifies that the AS confederation path length must be used when available in the BGP best path decision process. It is effective only when [bgp bestpath as-path ignore](#) command has not been used.

Use the `no` parameter with this command to ignore consideration of AS confederation path length in BGP best path selection.

Command Syntax

```
bgp bestpath compare-confed-aspath
no bgp bestpath compare-confed-aspath
```

Parameters

None

Default

BGP receives routes with identical eBGP paths from eBGP peers and selects the first route received as the best path.

Command Mode

Router mode

Applicability

This command was introduced before OcNOS version 1.3.

Examples

```
#configure terminal
(config)#router bgp 100
(config-router)#bgp bestpath compare-confed-aspath

(config)#router bgp 100
(config-router)#no bgp bestpath compare-confed-aspath
```

bgp bestpath compare-routerid

Use this command to compare router IDs for identical eBGP paths. When comparing similar routes from peers, the BGP router does not consider the router ID of the routes. By default, it selects the first received route. Use this command to include router ID in the selection process; similar routes are compared and the route with the lowest router ID is selected. The router ID is the highest IP address on the router, with preference given to loopback addresses. Router ID can be manually set by using the [bgp router-id](#) command.

Use the `no` parameter with this command to disable this functionality.

Command Syntax

```
bgp bestpath compare-routerid
no bgp bestpath compare-routerid
```

Parameters

None

Default

BGP receives routes with identical eBGP paths from eBGP peers and selects the first route received as the best path.

Command Mode

Router mode

Applicability

This command was introduced before OcNOS version 1.3.

Examples

```
#configure terminal
(config)#router bgp 100
(config-router)#bgp bestpath compare-routerid

(config)#router bgp 100
(config-router)#no bgp bestpath compare-routerid
```

bgp bestpath dont-compare-originator-id

Use this command to change the default bestpath selection by not comparing an originator-ID for an identical EBGP path.

Use the `no` parameter with this command to disable this functionality.

Command Syntax

```
bgp bestpath dont-compare-originator-id
no bgp bestpath dont-compare-originator-id
```

Parameters

None

Default

BGP receives routes with identical eBGP paths from eBGP peers and selects the first route received as the best path.

Command Mode

Router mode

Applicability

This command was introduced before OcNOS version 1.3.

Examples

```
#configure terminal
(config)#router bgp 100
(config-router)#bgp bestpath dont-compare-originator-id

(config)#router bgp 100
(config-router)#no bgp bestpath dont-compare-originator-id
```

bgp bestpath med

Use this command to specify two MED (Multi Exit Discriminator) attributes, `confed` and `missing-as-worst`.

The `confed` attribute enables MED comparison along paths learned from confederation peers. The MEDs are compared only if there is no external Autonomous System (an AS not within the confederation) in the path. If there is an external autonomous system in the path, the MED comparison is not made. For example in the following paths, the MED is not compared with Route3 as it is not in the confederation. MED is compared for Route1 and Route2 only.

```
Path1 = 32000 32004, med=4
```

```
Path2 = 32001 32004, med=2
```

```
Path3 = 32003 1, med=1
```

The `missing-as-worst` attribute to consider a missing MED attribute in a path as having a value of infinity, making the path without a MED value the least desirable path. If `missing-as-worst` is disabled, the missing MED is assigned the value of 0, making the path with the missing MED attribute the best path.

Use the `no` parameter with this command to prevent BGP from considering the MED attribute in comparing paths.

Command Syntax

```
bgp bestpath med confed missing-as-worst
bgp bestpath med (confed|missing-as-worst|remove-recv-med|remove-send-med)
bgp bestpath med missing-as-worst confed
no bgp bestpath med confed missing-as-worst
no bgp bestpath med (confed|missing-as-worst|remove-recv-med|remove-send-med)
no bgp bestpath med missing-as-worst confed
```

Parameters

<code>confed</code>	Compare MED along confederation paths
<code>missing-as-worst</code>	Treat missing MED as the least preferred one
<code>remove-recv-med</code>	Remove received MED attribute
<code>remove-send-med</code>	Remove sent MED attribute

Command Mode

Router mode

Default

By default, MED value is zero.

Applicability

This command was introduced before OcNOS version 1.3.

Examples

```
#configure terminal
```

BGP Commands

```
(config)#router bgp 100
(config-router)#bgp bestpath med missing-as-worst

(config)#router bgp 100
(config-router)#bgp bestpath med remove-recv-med
(config-router)#no bgp bestpath med remove-recv-med

(config)#router bgp 100
(config-router)#bgp bestpath med remove-send-med
(config-router)#no bgp bestpath med remove-send-med
```

bgp bestpath tie-break-on-age

Use this command to always select a preferred older route even when the `bgp bestpath compare-routerid` command is configured.

Use the `no` parameter with this command to disable this functionality.

Command Syntax

```
bgp bestpath tie-break-on-age
no bgp bestpath tie-break-on-age
```

Parameters

None

Default

By default, tie-break-on-age is disabled

Command Mode

Router mode

Applicability

This command was introduced before OcNOS version 1.3.

Examples

```
#configure terminal
(config)#router bgp 100
(config-router)#bgp bestpath tie-break-on-age

(config)#router bgp 100
(config-router)#no bgp bestpath tie-break-on-age
```

bgp client-to-client reflection

Use this command to configure routers as route reflectors. Route reflectors are used when all Interior Border Gateway Protocol (iBGP) speakers are not fully meshed. If the clients are fully meshed the route reflector is not required, use `no bgp client-to-client reflection` command to disable the client-to-client route reflection.

Use the `no` parameter with this command to turn off client-to-client reflection.

Command Syntax

```
bgp client-to-client reflection
no bgp client-to-client reflection
```

Parameters

None

Default

When a router is configured as a route reflector, client-to-client reflection is enabled by default.

Command Mode

Router mode

Applicability

This command was introduced before OcNOS version 1.3.

Examples

```
#configure terminal
(config)#router bgp 100
(config-router)#bgp client-to-client reflection

(config)#router bgp 100
(config-router)#no bgp client-to-client reflection
```

bgp cluster-id

Use this command to configure the cluster ID if the BGP cluster has more than one route reflector. A cluster includes route reflectors and its clients. Usually, each cluster is identified by the router ID of its single route reflector but to increase redundancy sometimes a cluster may have more than one route reflector. All route reflectors in such a cluster are then identified by a cluster ID. The `bgp cluster-id` command is used to configure the 4 byte cluster ID for clusters with more than one route reflectors.

Use the `no` parameter with this command (without any arguments) to remove a previously configured route reflector cluster ID.

Command Syntax

```
bgp cluster-id <1-4294967295>
bgp cluster-id A.B.C.D
no bgp cluster-id
```

Parameters

<1-4294967295> Route reflector ID as a 32-bit quantity
A.B.C.D Route reflector ID in an IPv4 address format

Default

By default, cluster id is set `bgp cluster id`

Command Mode

Router mode

Applicability

This command was introduced before OcnOS version 1.3.

Examples

The following configuration creates a cluster-id 5 including two route-reflector-clients.

```
#configure terminal
(config)#router bgp 100
(config-router)#neighbor 2.2.2.2 remote-as 200
(config-router)#neighbor 3.3.3.3 remote-as 200
(config-router)#neighbor 5.5.5.5 remote-as 200
(config-router)#neighbor 6.6.6.6 remote-as 200
(config-router)#bgp cluster-id 5
(config-router)#address-family ipv4 unicast
(config-router-af)#neighbor 3.3.3.3 route-reflector-client
(config-router-af)#neighbor 5.5.5.5 route-reflector-client
```

bgp confederation identifier

Use this command to specify a BGP confederation identifier.

Use the `no` parameter with this command to remove a BGP confederation identifier.

Command Syntax

```
bgp confederation identifier <1-65535>
no bgp confederation identifier
```

Parameter

<1-65535>	Routing domain confederation AS number
-----------	--

Default

No default value is specified

Command Mode

Router mode

Applicability

This command was introduced before OcNOS version 1.3.

Examples

```
#configure terminal
(config)#router bgp 100
(config-router)#bgp confederation identifier 1
```

bgp confederation peers

Use this command to configure the Autonomous Systems (AS) that belong to a confederation. A confederation allows an AS to be divided into several ASs. The AS is given a confederation identifier. External BGP (eBGP) routers view only the whole confederation as one AS. Each AS is fully meshed within itself and is visible internally to the confederation.

Use the `no` parameter with this command to remove an autonomous system from the confederation.

Command Syntax

```
bgp confederation peers <1-65535>
no bgp confederation peers <1-65535>
```

Parameter

<1-65535> AS numbers of eBGP peers that are in the same confederation

Default

No default value is specified

Command Mode

Router mode

Applicability

This command was introduced before OcNOS version 1.3.

Examples

In the following configuration example, the neighbor 172.210.30.2 and 172.210.20.1 have iBGP connection within AS 100, neighbor 173.213.30.1 is a BGP connection with a confederation peer 200 and neighbor 6.6.6.6 has an eBGP connection to external AS 300.

```
#configure terminal
(config)#router bgp 100
(config-router)#bgp confederation identifier 300
(config-router)#bgp confederation peers 200
(config-router)#neighbor 172.210.30.2 remote-as 100
(config-router)#neighbor 172.210.20.1 remote-as 100
(config-router)#neighbor 173.213.30.1 remote-as 200
(config-router)#neighbor 6.6.6.6 remote-as 300
```

In this configuration, the neighbor 5.5.5.4 has an eBGP connection to confederation 300.

```
#configure terminal
(config)#router bgp 500
(config-router)#neighbor 5.5.5.4 remote-as 300
```

bgp config-type

Use this command to set the BGP configuration to the `standard` type. After setting the configuration to the `standard` type, use the [neighbor send-community](#) command to send out BGP community attributes. The `zebos` configuration type is the default and requires no specific configuration for sending out BGP standard community and extended community attributes.

For the `standard` type, the `no synchronization` command is always shown in the configuration, whereas for the `zebos` type, this command is the default.

Use the `no` parameter with this command to remove this configuration.

Command Syntax

```
bgp config-type (standard|zebos)
no bgp config-type
```

Parameters

<code>standard</code>	Standard style configuration
<code>zebos</code>	OcNOS style configuration

Default

The default configuration type is: `bgp config-type zebos`

Command Mode

Configure mode

Applicability

This command was introduced before OcNOS version 1.3.

Examples

```
#configure terminal
(config)#bgp config-type standard
```

bgp dampening

Use this command to enable BGP route dampening and set various parameters. Route dampening minimizes the instability caused by route flapping. A penalty is added for every flap in a flapping route. As soon as the total penalty reaches the `suppress` limit the advertisement of the route is suppressed. This penalty is decayed according to the configured `half time` value. Once the penalty is lower than the `reuse` limit, the route advertisement is un-suppressed. The dampening information is purged from the router once the penalty becomes less than half of the `reuse` limit.

Use the `no` parameter with this command to unset BGP dampening parameters.

Command Syntax

```
bgp dampening
bgp dampening <1-45>
bgp dampening <1-45> <1-20000> <1-20000> <1-255>
bgp dampening <1-45> <1-20000> <1-20000> <1-255> <1-45>
bgp dampening route-map WORD
no bgp dampening
```

Parameters

<1-45>	Reachability half-life time for the penalty in minutes. The time for the penalty to decrease to one-half of its current value.
<1-20000>	Value to start reusing a route. When the penalty for a suppressed route decays below the reuse value, the routes become unsuppressed.
<1-20000>	Value to start suppressing a route. When the penalty for a route exceeds the suppress value, the route is suppressed
<1-255>	Maximum duration to suppress a stable route in minutes.
<1-45>	Un-reachability half-life time for the penalty in minutes.
route-map	Route map to specify criteria for dampening.
WORD	Route-map name.

Defaults

The default reachability half-life is 15 minutes.

The default reuse limit is 750.

The default suppress limit is 2000.

The default max-suppress value is 4 times the half-life time, or 60 minutes.

Command Mode

Address Family mode

Applicability

This command was introduced before OcNOS version 1.3.

Examples

```
#configure terminal
(config)#router bgp 11
(config-router)#address-family ipv4 unicast
(config-router-af)#bgp dampening 20 800 2500 80 25
```

bgp default local-preference

Use this command to change the default local preference value. Local preference indicates the preferred path when there are multiple paths to the same destination. The path having a higher preference is preferred. The preference is sent to all routers and access servers in the local autonomous system.

Use the `no` parameter with this command to revert to the default value for local preference.

Command Syntax

```
bgp default local-preference <0-4294967295>
no bgp default local-preference
no bgp default local-preference <0-4294967295>
```

Parameter

<0-4294967295> Local preference value

Default

By default, local preference value is 100

Command Mode

Router mode

Applicability

This command was introduced before OcnOS version 1.3.

Examples

```
#configure terminal
(config)#router bgp 100
(config-router)#bgp default local-preference 2345555
```

bgp deterministic-med

Use this command to compare the Multi Exit Discriminator (MED) variable when choosing among routes advertised by different peers in the same autonomous system. MED is compared after BGP attributes weight, local preference, AS-path and origin have been compared and are equal.

For a correct comparison result, enable this command on all routers in a local AS. After enabling this command, all paths for the same prefix are grouped together and arranged according to their MED value. Based on this comparison, the best path is then chosen. This command compares MED variable when choosing routes advertised by different peers in the same AS, to compare MED, when choosing routes from neighbors in different ASs use the `bgp always-compare-med` command.

When the `bgp deterministic-med` command is enabled, routes from the same AS are grouped together, and the best routes of each group are compared. If the BGP table showed:

```
Route1: as-path 200, med 300, internal
Route2: as-path 400, med 200, internal
Route3: as-path 400, med 250, external
```

BGP would have a group of Route1 and a second group of Route2 and Route3 (the same ASs). The best of each group is compared. Route1 is the best of its group because it is the only route from AS 200. Route1 is compared to the Route2, the best of group AS 400 (the lower MED). Since the two routes are not from the same AS, the MED is not considered in the comparison. The external BGP route is preferred over the internal BGP route, making Route3 the best route; the preferred route would be different if `always-compare-med` command is enabled (See `always-compare-med` command).

Use the `no` parameter with this command to disallow this setting.

Command Syntax

```
bgp deterministic-med
no bgp deterministic-med
```

Parameters

None

Default

By default, `bgp deterministic med` is disabled

Command Mode

Router mode

Applicability

This command was introduced before OcNOS version 1.3.

Examples

```
#configure terminal
(config)#router bgp 100
(config-router)#bgp deterministic-med

(config)#router bgp 100
(config-router)#no bgp deterministic-med
```

bgp enforce-first-as

Use this command to enforce the first AS for eBGP routes. This command specifies that any updates received from an external neighbor that do not have the neighbor's configured Autonomous System (AS) at the beginning of the AS_PATH in the received update must be denied. Enabling this feature adds to the security of the BGP network by not allowing traffic from unauthorized systems.

Using the `no` parameter with this command to disable this feature.

Command Syntax

```
bgp enforce-first-as
no bgp enforce-first-as
```

Parameters

None

Default

By default, `enforce-first-as` is disabled

Command Mode

Router mode

Applicability

This command was introduced before OcNOS version 1.3.

Examples

```
#configure terminal
(config)#router bgp 100
(config-router)#bgp enforce-first-as

(config)#router bgp 100
(config-router)#no bgp enforce-first-as
```

bgp extended-asn-cap

Use this command to configure a BGP router to send 4-octet ASN capabilities. If attempting to change the AS capability from 2 to 4 or 4 to 2, a prompt occurs to remove the VRF configuration (if it exists), and reconfiguration is required, because the route distinguisher (RD) configuration would have been created with the current (2 octet or 4 octet) capability, and must be reconfigured before attempting to change the capability.

While loading from a saved configuration with AS4 capability and BGP VRF configuration, the capability will not be changed because of the above described reason.

Use the `no` parameter with this command to prevent a BGP router from sending 4-octet ASN capabilities.

Command Syntax

```
bgp extended-asn-cap
no bgp extended-asn-cap
```

Parameters

None

Default

By default, the bgp extended ASN capability and Four-octet capabilities are disabled.

Command Mode

Configure mode

Applicability

This command was introduced before OcNOS version 1.3.

Examples

```
#configure terminal
(config)#bgp extended-asn-cap
```

bgp fast-external-failover

Use this command to reset a BGP session immediately, if the interface used for BGP connection goes down.

Use the `no` parameter with this command to disable this feature.

Command Syntax

```
bgp fast-external-failover
no bgp fast-external-failover
```

Parameters

None

Default

By default, fast-external failover is enabled

Command Mode

Router mode

Applicability

This command was introduced before OcNOS version 1.3.

Example

```
#configure terminal
(config)#router bgp 100
(config-router)#bgp fast-external-failover
```

bgp graceful-restart

Use this command to enable BGP graceful-restart capabilities. The restart-time parameter is used for setting the maximum time that a graceful-restart neighbor waits to come back up after a restart. This value is applied to all neighbors unless you explicitly override it by configuring the corresponding value on the neighbor. The stalepath-time parameter is used to set the maximum time to preserve stale paths from a gracefully restarted neighbor. All stalepaths, unless reinstated by the neighbor after a re-establishment, will be deleted at the expiration of this timer.

Use the `no` parameter with this command to restore the router to its default state.

Command Syntax

```
bgp graceful-restart
bgp graceful-restart graceful-reset
bgp graceful-restart restart-time <1-3600>
bgp graceful-restart stalepath-time <1-3600>
no bgp graceful-restart
no bgp graceful-restart graceful-reset
no bgp graceful-restart restart-time
no bgp graceful-restart stalepath-time
```

Parameters

<code>graceful-reset</code>	The BGP daemon is not restarted, so that any changes in network configurations that cause BGP reset do not affect packet forwarding.
<code>restart-time</code>	Maximum time needed for neighbors to restart. Default is 90 seconds.
<code><1-3600></code>	Delay value in seconds.
<code>stalepath-time</code>	Maximum time to retain stale paths from restarting neighbors. Default is 360 seconds.
<code><1-3600></code>	Delay value in seconds.

Default

By default, the maximum time for neighbors to restart is 90 seconds.

By default, the maximum time to retain stale paths from restarting neighbors is 360 seconds.

Command Mode

Router mode

Applicability

This command was introduced before OcNOS version 1.3.

Examples

```
#configure terminal
(config)#router bgp 10
(config-router)#bgp graceful-restart

#configure terminal
(config)#router bgp 10
```

```
(config-router)#no bgp graceful-restart
```

bgp g-shut

Use this command to gracefully shut down all BGP IPv4 sessions under this router. The BGP graceful shutdown feature reduces packet loss during maintenance activity.

Use the `no` parameter with this command to bring up all the sessions under this router after completion of maintenance activity using the `bgp g-shut` command.

Command Syntax

```
bgp g-shut
no bgp g-shut
```

Parameters

None

Default

By default, `bgp g-shut` is disabled

Command Mode

Router mode

Applicability

This command was introduced before OcNOS version 1.3.

Examples

```
#configure terminal
(config)#router bgp 100
(config-router)#bgp g-shut
```

```
#configure terminal
(config)#router bgp 100
(config-router)#no bgp g-shut
```

bgp g-shut-capable

Use this command to enable the graceful shutdown capability at the router level and make available the graceful-shutdown related commands at the router and BGP neighbor levels.

Use the `no` parameter with this command to disable the graceful shutdown capability on a router.

Note: The graceful shutdown capability cannot be disabled on a router that is in a graceful shutdown state until it comes out this state--after the graceful shutdown has been initiated and the impacted BGP sessions are up again.

Command Syntax

```
bgp g-shut-capable
no bgp g-shut-capable
```

Parameters

None

Default

By default, the graceful shutdown capability is disabled at the router level

Command Mode

Router mode

Applicability

This command was introduced before OcNOS version 1.3.

Examples

```
#configure terminal
(config)#router bgp 100
(config-router)#bgp g-shut-capable

#configure terminal
(config)#router bgp 100
(config-router)#no bgp g-shut-capable
```

bgp g-shut-local-preference

Use this command to sets the local preference of the router to use during graceful shutdown. The local preference value indicates the preferred path when there are multiple paths to the same destination in a single routing database. The path with a higher preference value is the preferred one. The preferred path is sent to all routers and access servers in the local autonomous system.

Use the `no` parameter with this command to revert to the default setting.

Command Syntax

```
bgp g-shut-local-preference <0-4294967295>
no bgp g-shut-local-preference
```

Parameters

<0-4294967295> Local preference value

Default

By default, the local preference value is set to 0

Command Mode

Router mode

Applicability

This command was introduced before OcNOS version 1.3.

Examples

```
#configure terminal
(config)#router bgp 100
(config-router)#bgp g-shut-local-preference 22
```

bgp log-neighbor-changes

Use this command to enable logging of status change messages without turning on debug bgp commands. OcNOS has many logging services for neighbor status, including `debug bgp fsm` and `debug bgp events`. However, these commands cause system performance degradation. If you need to log neighbor status changes only, IP Infusion Inc. recommends turning off all debug commands and using the `bgp log-neighbor-changes` command instead. A sample output of the log is:

```
%Protocol-Severity-Events: Message-text
```

A sample output of the log for an interface down event is:

```
%BGP-5-ADJCHANGE: neighbor 10.10.0.24 Down Interface flap
```

This command logs the following events:

- BGP Notification Received
- Erroneous BGP Update Received
- User reset request
- Peer time-out
- Peer Closing down the session
- Interface flap
- Router ID changed
- Neighbor deleted
- Member added to peer group
- Administrative shutdown
- Remote AS changed
- RR client configuration modification
- Soft reconfiguration modification

Use the `no` parameter with this command to disable this feature.

Command Syntax

```
bgp log-neighbor-changes
no bgp log-neighbor-changes
```

Parameters

None

Default

By default, bgp log neighbor changes is disabled

Command Mode

Router mode

Applicability

This command was introduced before OcNOS version 1.3.

Example

```
(config)#router bgp 100
(config-router)#bgp log-neighbor-changes
```

mpls-nexthop-tracking

Use this command to activate MPLS nexthop tracking feature for IPv4 Labeled-unicast routes.

Use `no` form of this command to deactivate MPLS nexthop tracking feature for IPv4 Labeled-unicast routes.

Note: `bgp nexthop-trigger enable` must be configured to enable `mpls-nexthop-tracking`

Command Syntax

```
mpls-nexthop-tracking
no mpls-nexthop-tracking
```

Parameters

None

Command Mode

BGP mode

Applicability

This command was introduced in OcNOS version 5.0.

Examples

```
#configure terminal
(config)#bgp nexthop-trigger enable
(config)#router bgp 100
(config-router)#mpls-nexthop-tracking
```

bgp nexthop-trigger delay

Use this command to set the delay time for nexthop address tracking. This command configures the delay interval between routing table walks for nexthop delay tracking, after which BGP does a routing table scan on receiving a nexthop change trigger from NSM. The time period determines how long BGP waits before it walks the full BGP table to determine which prefixes are affected by the nexthop changes, after it receives the trigger from NSM about one or more nexthop changes.

Use the `no` parameter with this command to reset the timer value to the default value.

Command Syntax

```
bgp nexthop-trigger delay <1-100>
no bgp nexthop-trigger delay
```

Parameter

<1-100> Nexthop trigger delay interval in seconds

Default

By default, nexthop-trigger delay time is 5 seconds

Command Mode

Configure mode

Applicability

This command was introduced before OcNOS version 1.3.

Examples

```
#configure terminal
(config)#bgp nexthop-trigger delay 6

#configure terminal
(config)#no bgp nexthop-trigger delay
```

bgp nexthop-trigger enable

Use this command to enable nexthop address tracking. Nexthop address tracking is an event-driven notification system that monitors the status of routes installed in the Routing Information Base (RIB) and reports nexthop changes that affect internal BGP (iBGP) or external BGP (eBGP) prefixes directly to the BGP process. This improves the overall BGP convergence time, by allowing BGP to respond rapidly to nexthop changes for routes installed in the RIB.

If nexthop tracking is enabled after certain routes are learned, the registration of all nexthops for selected BGP routes is done after the nexthop tracking feature is enabled. If nexthop tracking is disabled, and if there are still some selected BGP routes, BGP de-registers the nexthops of all selected BGP routes from NSM.

Use the `no` parameter with this command to disable this feature. If the `no` command is given when nexthop tracking is in the process of execution, an error appears and nexthop tracking is not disabled. However, if the nexthop tracking timer is running at the time of negation, the nexthop tracking timer is stopped, and nexthop tracking is disabled.

Command Syntax

```
bgp nexthop-trigger enable
no bgp nexthop-trigger enable
```

Parameters

None

Default

By default, nexthop address tracking is disabled

Command Mode

Configure mode

Applicability

This command was introduced before OcNOS version 1.3.

Examples

```
#configure terminal
(config)#bgp nexthop-trigger enable
```

bgp rfc1771-path-select

Use this command to set RFC 1771 compatible path selection.

Use the `no` parameter with this command to revert this setting.

Command Syntax

```
bgp rfc1771-path-select
no bgp rfc1771-path-select
```

Parameters

None

Default

Standard compatible path selection mechanism.

Command Mode

Configure mode

Applicability

This command was introduced before OcNOS version 1.3.

Examples

```
#configure terminal
(config)#bgp rfc1771-path-select
```

bgp rfc1771-strict

Use this command to set the origin path attribute to “IGP” when the origin is a protocol such as RIP, OSPF, or ISIS as specified in RFC 1771. Otherwise, the origin is always set to “incomplete” which is the industry standard.

Use the `no` parameter with this command to revert this setting.

Command Syntax

```
bgp rfc1771-strict
no bgp rfc1771-strict
```

Parameters

None

Default

By default, `bgp rfc1771 strict` is disabled

Command Mode

Configure mode

Applicability

This command was introduced before OcNOS version 1.3.

Examples

```
#configure terminal
(config)#bgp rfc1771-strict
```

bgp router-id

Use this command to manually configure a fixed router ID as a BGP router identifier. When this command is used to configure a fixed router ID, the current router identifier is overridden and the peers are reset.

Use the `no` parameter with this command to remove a manually configured fixed router ID.

Command Syntax

```
bgp router-id A.B.C.D
no bgp router-id
no bgp router-id A.B.C.D
```

Parameter

A.B.C.D Router ID in an IPv4 address format

Default

Once the BGP router-id is elected, it may be re-elected in the following cases:

- When an explicit BGP router-id is configured/un-configured
- When the router's (global) router-id is set/unset (holds true when (a) is not applicable),
- When the BGP process is cleared (holds true when both (a) & (b) are not applicable and the IP address(es) on the active interfaces are updated, which may result in a change in the router's router-id).

If no loopback interface is configured, the highest IP address is the BGP router-id.

When a loopback interface is configured, the BGP router-id is set to the IP address of the loopback interface.

Note: IP Infusion Inc. recommends that you always configure a router identifier to avoid unpredictable behavior if the address of a loopback interface changes.

Command Mode

Router mode

Applicability

This command was introduced before OcNOS version 1.3.

Examples

```
#configure terminal
(config)#router bgp 100
(config-router)#bgp router-id 10.1.2.7

(config)#router bgp 100
(config-router)#no bgp router-id 10.1.2.7
```

bgp scan-time

Use this command to configure scanning intervals of BGP routers. This interval is the period after which router checks the validity of the routes in its database. To disable BGP scanning, set the scan-time interval to 0 seconds.

Use the `no` parameter with this command to disable this function.

Command Syntax

```
bgp scan-time <0-60>
no bgp scan-time
no bgp scan-time <0-60>
```

Parameter

<0-60> Scanning interval in seconds

Default

By default, scan-time interval is 60 seconds.

Command Mode

Router mode

Applicability

This command was introduced before OcnOS version 1.3.

Examples

```
#configure terminal
(config)#router bgp 100
(config-router)#bgp scan-time 10
```

bgp table-map

Use this command to enable or disable suppression/modification of incoming BGP updates to IP RIB/FIB table installation.

In a dedicated route reflector, all the routes it receives may not be required to be stored or only few selected routes need to be stored, because it may not lie in the data path.

Table maps are particularly useful to attain this restriction. Table-map command can be used in two ways:

- When a simple table-map command is given, the route map referenced in the table-map command shall be used to set certain properties (such as the traffic index) of the routes for installation into the RIB. The route is always downloaded, regardless of whether it is permitted or denied by the route map.
- When the option 'filter' is given in the table map command, the route map referenced is used to control whether a BGP route is to be downloaded to the IP RIB (hence the filter). A BGP route is not downloaded to the RIB if it is denied by the route map.

Use this command in Address Family mode to set the table map rule per an IPv4 or IPv6 family.

Use the `no` parameter with this command to remove the table-map rule.

Command Syntax

```
table-map WORD [|filter]
```

Parameter

<code>WORD</code>	Specify the route-map name to apply.
<code>filter</code>	Filter the routes. If present, the incoming routes are pruned as per the rule specified in route-map-name. If not, it is used to alter the incoming packet information.

Default

All BGP routes will be downloaded to IP RIB

Command Mode

Address Family IPv4 mode, and Address Family IPv6 mode

Applicability

This command was introduced before OcNOS version 1.3.

Examples

The following example shows how to set the table-map command without filter for BGP for all address families.

```
#configure terminal
(config)#router bgp 100
(config-router)#address-family ipv4 unicast
(config-router-af)#table-map abc
```

The following example shows how to set the table-map command with filter for BGP for all address families.

```
#configure terminal
(config)#router bgp 100
(config-router)#address-family ipv4 unicast
(config-router-af)#table-map abc filter
```

The following example shows how to set the table-map command without filter for BGP for an IPv6 address family.

```
(config)#router bgp 100
(config-router)#address-family ipv6
(config-router-af)#table-map abc
```

The following example shows how to set the table-map command with filter for BGP for an IPv6 address family.

```
(config)#router bgp 100
(config-router)#address-family ipv6
(config-router-af)#table-map abc filter
```

bgp update-delay

Use this command to set the update delay for a graceful-restart capable router. The update-delay value is the maximum time a graceful-restart capable router, which is restarting, will defer route-selection and advertisements to all its graceful-restart capable neighbors. This maximum time starts from the instance the first neighbor attains established state after restart. The restarting router prematurely terminates this timer when end-of-RIB markers are received from all its graceful-restart capable neighbors.

Use the `no` form of this command to set to the update delay to its default value.

Command Syntax

```
bgp update-delay <1-3600>
no bgp update-delay
no bgp update-delay <1-3600>
```

Parameters

`<1-3600>` Delay interval in seconds

Default

By default, update-delay value is 120 seconds

Command Mode

Router mode

Applicability

This command was introduced before OcNOS version 1.3.

Example

```
#configure terminal
(config)#router bgp 10
(config-router)#bgp update-delay 345
```

clear bgp (A.B.C.D|X:X::X:X)

Use this command to reset a BGP neighbor address.

Command Syntax

```
clear bgp (A.B.C.D|X:X::X:X|WORD)
clear bgp (A.B.C.D|X:X::X:X) in
clear bgp (A.B.C.D|X:X::X:X) in prefix-filter
clear bgp (A.B.C.D|X:X::X:X) out
```

Parameters

A.B.C.D	IPv4 neighbor address.
X:X::X:X	IPv6 neighbor address.
WORD	Interface name
in	Clear incoming advertised routes.
prefix-filter	Push out prefix-list ORF and do inbound soft reconfig.
out	Clear outgoing advertised routes.

Command Mode

Privileged Exec mode

Applicability

This command was introduced before OcNOS version 1.3.

Example

```
#clear bgp 3.3.3.3
```

clear bgp *

Use this command to reset the BGP connection for all peers.

Command Syntax

```
clear bgp *
clear bgp * in
clear bgp * in prefix-filter
clear bgp * out
clear bgp * soft
clear bgp * soft in
clear bgp * soft out
clear ip bgp *
clear ip bgp * in
clear ip bgp * in prefix-filter
clear ip bgp * out
clear ip bgp * soft
clear ip bgp * soft in
clear ip bgp * soft out
clear ip bgp * ipv4 (unicast|multicast) in
clear ip bgp * ipv4 (unicast|multicast) in prefix-filter
clear ip bgp * ipv4 (unicast|multicast) out
clear ip bgp * ipv4 (unicast|multicast) soft
clear ip bgp * ipv4 (unicast|multicast) soft in
clear ip bgp * ipv4 (unicast|multicast) soft out
```

Parameters

in	Incoming advertised routes should be cleared.
prefix-filter	Push out prefix-list ORF and do inbound soft reconfig.
out	Clear outgoing advertised routes.
soft	Clear both incoming and outgoing routes.
in	Soft reconfig inbound update.
out	Soft reconfig outbound update.
ipv4	Clear incoming advertised routes.
multicast	Multicast prefixes.
unicast	Unicast prefixes.
in	Clear incoming advertised routes.
prefix-filter	

	Push out prefix-list ORF and do inbound soft reconfig.
out	Clear outgoing advertised routes.
soft	Clear both incoming and outgoing routes.
in	Soft reconfig inbound update.
out	Soft reconfig outbound update.

Command Mode

Privileged Exec mode

Applicability

This command was introduced before OcNOS version 1.3.

Examples

```
#clear bgp *  
#clear ip bgp * ipv4 unicast in prefix-filter
```

clear bgp * l2vpn evpn

Use this command to reset the BGP L2VPN EVPN connection for all the BGP peers.

Command Syntax

```
clear bgp * l2vpn evpn soft (in | out | )
```

Parameters

soft	Clear both incoming and outgoing routes.
in	Soft reconfig inbound update.
out	Soft reconfig outbound update.

Default

None.

Command Mode

Privileged Exec mode.

Applicability

This command was introduced in OcNOS version 6.3.4.

Examples

```
OcNOS#clear bgp * l2vpn evpn soft
OcNOS#clear bgp * l2vpn evpn soft in
```

clear bgp <1-4294967295>

Use this command to reset a BGP connection for all peers in a specified Autonomous System.

Command Syntax

```
clear bgp <1-4294967295>
clear bgp <1-4294967295> in
clear bgp <1-4294967295> in prefix-filter
clear bgp <1-4294967295> out
clear bgp <1-4294967295> soft
clear bgp <1-4294967295> soft in
clear bgp <1-4294967295> soft out
clear ip bgp <1-4294967295>
clear ip bgp <1-4294967295> in
clear ip bgp <1-4294967295> in prefix-filter
clear ip bgp <1-4294967295> out
clear ip bgp <1-4294967295> soft
clear ip bgp <1-4294967295> soft in
clear ip bgp <1-4294967295> soft out
clear ip bgp <1-4294967295> ipv4 (unicast|multicast) in
clear ip bgp <1-4294967295> ipv4 (unicast|multicast) in prefix-filter
clear ip bgp <1-4294967295> ipv4 (unicast|multicast) out
clear ip bgp <1-4294967295> ipv4 (unicast|multicast) soft
clear ip bgp <1-4294967295> ipv4 (unicast|multicast) soft in
clear ip bgp <1-4294967295> ipv4 (unicast|multicast) soft out
```

Parameters

in	Clear incoming advertised routes.
prefix-filter	Push out prefix-list ORF and do inbound soft reconfig.
out	Clear outgoing advertised routes.
soft	Clear both incoming and outgoing routes.
in	Soft reconfig inbound update.
out	Soft reconfig outbound update.
ipv4	Clear incoming advertised routes.
multicast	Multicast prefixes.
unicast	Unicast prefixes.
	Clear incoming advertised routes.
in	Clear incoming advertised routes.

prefix-filter	
	Push out prefix-list ORF and do inbound soft reconfig.
out	Clear outgoing advertised routes.
soft	Clear both incoming and outgoing routes.
in	Soft reconfig inbound update.
out	Soft reconfig outbound update.

Command Mode

Privileged Exec mode

Applicability

This command was introduced before OcNOS version 1.3.

Examples

```
#clear bgp 4294967277
#clear ip bgp 4294967277
```

clear bgp <1-4294967295> l2vpn evpn

Use this command to reset the session for neighbors with a specific Autonomous System Number (ASN) for L2VPN EVPN.

Command Syntax

```
clear bgp <1-4294967295> l2vpn evpn soft (in | out | )
```

Parameters

bgp <1-4294967295>	Clears the particular BGP peer with the specified Autonomous System Number (ASN). The BGP peer ASN ranges from 1 to 4294967295.
soft	Clear both incoming and outgoing routes.
in	Soft reconfig inbound update.
out	Soft reconfig outbound update.

Default

None.

Command Mode

Privileged Exec mode.

Applicability

This command was introduced in OcNOS version 6.3.4.

Examples

```
OcNOS#clear bgp 100 l2vpn evpn soft
OcNOS#clear bgp 100 l2vpn evpn soft in
```

clear bgp A.B.C.D l2vpn evpn

Use this command to reset the BGP session for neighbor with IPv4 address for L2VPN EVPN.

Command Syntax

```
clear bgp A.B.C.D l2vpn evpn soft (in | out | )
```

Parameters

<code>bgp A.B.C.D</code>	Clears the particular BGP neighbor with the specified IPv4 address.
<code>soft</code>	Clear both incoming and outgoing routes.
<code>in</code>	Soft reconfig inbound update.
<code>out</code>	Soft reconfig outbound update.

Default

None.

Command Mode

Privileged Exec mode.

Applicability

This command was introduced in OcNOS version 6.3.4.

Examples

```
OcNOS#clear bgp 3.3.3.3 l2vpn evpn soft
OcNOS#clear bgp 3.3.3.3 l2vpn evpn soft in
```

clear bgp dampening

Use this command to reset BGP route flap dampening information.

Command Syntax

```
clear bgp ipv4 (unicast|multicast) dampening
clear bgp ipv4 (unicast|multicast) dampening A.B.C.D/M
clear ip bgp dampening
clear ip bgp dampening A.B.C.D/M
clear ip bgp ipv4 (unicast|multicast) dampening
clear ip bgp ipv4 (unicast|multicast) dampening A.B.C.D/M
```

Parameters

ipv4	IPv4 address family.
multicast	Multicast prefixes
unicast	Unicast prefixes
A.B.C.D/M	IP prefix (network/length), for example, 35.0.0.0/8

Command Mode

Privileged Exec mode

Applicability

This command was introduced before OcNOS version 1.3.

Examples

```
#clear ip bgp dampening 10.10.0.121/24
#clear ip bgp ipv4 unicast dampening
```

clear bgp external

Use this command to reset the BGP connection for all external peers.

Command Syntax

```
clear bgp external
clear bgp external in
clear bgp external in prefix-filter
clear bgp external out
clear bgp external soft
clear bgp external soft in
clear bgp external soft out
clear ip bgp external
clear ip bgp external in
clear ip bgp external in prefix-filter
clear ip bgp external out
clear ip bgp external soft
clear ip bgp external soft in
clear ip bgp external soft out
clear ip bgp external ipv4 (unicast|multicast) in
clear ip bgp external ipv4 (unicast|multicast) in prefix-filter
clear ip bgp external ipv4 (unicast|multicast) out
clear ip bgp external ipv4 (unicast|multicast) soft
clear ip bgp external ipv4 (unicast|multicast) soft in
clear ip bgp external ipv4 (unicast|multicast) soft out
```

Parameters

in	Clear incoming advertised routes.
prefix-filter	Push out prefix-list ORF and do inbound soft reconfig.
out	Clear outgoing advertised routes.
soft	Clear both incoming and outgoing routes.
in	Soft reconfig inbound update.
out	Soft reconfig outbound update.
ipv4	Clear incoming advertised routes.
multicast	Multicast prefixes.
unicast	Unicast prefixes.
in	Clear incoming advertised routes.
prefix-filter	

	Push out prefix-list ORF and do inbound soft reconfig.
out	Clear outgoing advertised routes.
soft	Clear both incoming and outgoing routes.
in	Soft reconfig inbound update.
out	Soft reconfig outbound update.

Command Mode

Privileged Exec mode

Applicability

This command was introduced before OcNOS version 1.3.

Example

```
#clear ip bgp external
```

clear bgp flap-statistics

Use this command to reset BGP flap statistics.

Command Syntax

```
clear bgp ipv4 (unicast|multicast) flap-statistics
clear bgp ipv4 (unicast|multicast) flap-statistics A.B.C.D/M vrf (all | default |
  VRFNAME )
clear bgp ipv4 (unicast|multicast) flap-statistics A.B.C.D/M
clear ip bgp flap-statistics
clear ip bgp flap-statistics A.B.C.D/M
clear ip bgp ipv4 (unicast|multicast) flap-statistics
clear ip bgp ipv4 (unicast|multicast) flap-statistics A.B.C.D/M vrf (all | default
  | VRFNAME )
clear ip bgp ipv4 (unicast|multicast) flap-statistics A.B.C.D/M
```

Parameters

ipv4	IPv4 address family.
multicast	Multicast prefixes.
unicast	Unicast prefixes.
A.B.C.D/M	IP prefix (network/length), for example, 35.0.0.0/8
VRFNAME	VPN routing or forwarding instance name
all	All VRF's
default	Default VRF

Command Mode

Privileged Exec mode

Applicability

This command was introduced before OcNOS version 1.3.

Examples

```
#clear ip bgp flap-statistics
#clear ip bgp ipv4 unicast flap-statistics
```

clear bgp peer-group

Use this command to reset the BGP connection for all members of a peer group.

Command Syntax

```
clear bgp peer-group WORD
clear bgp peer-group WORD in
clear bgp peer-group WORD in prefix-filter
clear bgp peer-group WORD out
clear bgp peer-group WORD soft
clear bgp peer-group WORD soft in
clear bgp peer-group WORD soft out
clear ip bgp peer-group WORD
clear ip bgp peer-group WORD in
clear ip bgp peer-group WORD in prefix-filter
clear ip bgp peer-group WORD out
clear ip bgp peer-group WORD soft
clear ip bgp peer-group WORD soft in
clear ip bgp peer-group WORD soft out
clear ip bgp peer-group WORD ipv4 (unicast|multicast) in
clear ip bgp peer-group WORD ipv4 (unicast|multicast) in prefix-filter
clear ip bgp peer-group WORD ipv4 (unicast|multicast) out
clear ip bgp peer-group WORD ipv4 (unicast|multicast) soft
clear ip bgp peer-group WORD ipv4 (unicast|multicast) soft in
clear ip bgp peer-group WORD ipv4 (unicast|multicast) soft out
```

Parameters

WORD	BGP peer-group name.
in	Clear incoming advertised routes.
prefix-filter	Push out prefix-list ORF and do inbound soft reconfig.
out	Clear outgoing advertised routes.
soft	Clear both incoming and outgoing routes.
in	Soft reconfig inbound update.
out	Soft reconfig outbound update.
ipv4	Clear incoming advertised routes.
multicast	Multicast prefixes.
unicast	Unicast prefixes.
	Clear incoming advertised routes.

<code>in</code>	Clear incoming advertised routes.
<code>prefix-filter</code>	Push out prefix-list ORF and do inbound soft reconfig.
<code>out</code>	Clear outgoing advertised routes.
<code>soft</code>	Clear both incoming and outgoing routes.
<code>in</code>	Soft reconfig inbound update.
<code>out</code>	Soft reconfig outbound update.

Command Mode

Privileged Exec mode

Applicability

This command was introduced before OcNOS version 1.3.

Examples

```
#clear ip bgp peer-group P1
```

clear bgp peer-group WORD l2vpn evpn

Use this command to reset the BGP L2VPN EVPN connection for all members of a BGP peer group.

Command Syntax

```
clear bgp peer-group WORD l2vpn evpn soft (in | out | )
```

Parameters

bgp peer-group	Clears all the members of the specified peer group.
WORD	
soft	Clear both incoming and outgoing routes.
in	Soft reconfig inbound update.
out	Soft reconfig outbound update.

Default

None.

Command Mode

Privileged Exec mode.

Applicability

This command was introduced before OcnOS version 6.3.4.

Examples

```
OcnOS#clear bgp peer-group GRP1 l2vpn evpn soft  
OcnOS#clear bgp peer-group GRP1 l2vpn evpn soft in
```

clear bgp statistics

Use this command to reset all BGP statistics.

Command Syntax

```
clear bgp statistics
```

Parameters

None

Command Mode

Privileged Exec mode

Applicability

This command was introduced before OcNOS version 1.3.

Examples

```
#clear bgp statistics
```

clear ip bgp * (description LINE|)*

Use this command to reset the BGP connection for all peers.

Command Syntax

```
clear ip bgp * (description LINE|)
```

Parameters

description Administratively reset communication msg to neighbor

Command Mode

Privileged Exec mode

Applicability

This command is introduced in OcNOS version 6.0.0.

Examples

```
#clear bgp *  
#clear bgp * description peer reset done for refresh
```

clear ip bgp (A.B.C.D|X:X::X:X|WORD) (description LINE|)

Use this command to reset the BGP connection for peer.

Command Syntax

```
clear ip bgp (A.B.C.D|X:X::X:X|WORD) (description LINE|)
```

Parameters

A.B.C.D	Address of the BGP neighbor in an IPv4 format
X:X::X:X	Address of the BGP neighbor in an IPv6 format
WORD	Name of a BGP peer group created with the neighbor WORD peer-group command. When you specify this parameter, the command applies to all peers in the group.
description	Administratively reset communication msg to neighbor

Command Mode

Privileged Exec mode

Applicability

This command is introduced in OcNOS version 6.0.0.

Examples

```
#clear ip bgp 40.1.1.2
#clear ip bgp 40.1.1.2 description peer reset is done
```

clear ip bgp A.B.C.D

Use this command to reset an IPv4 BGP neighbor address.

Command Syntax

```
clear ip bgp (A.B.C.D|WORD) in
clear ip bgp A.B.C.D in prefix-filter
clear ip bgp (A.B.C.D|WORD) out
clear ip bgp (A.B.C.D|WORD) soft
clear ip bgp (A.B.C.D|WORD) soft in
clear ip bgp (A.B.C.D|WORD) soft out
clear ip bgp A.B.C.D ipv4 (unicast|multicast) in
clear ip bgp A.B.C.D ipv4 (unicast|multicast) in prefix-filter
clear ip bgp A.B.C.D ipv4 (unicast|multicast) out
clear ip bgp A.B.C.D ipv4 (unicast|multicast) soft
clear ip bgp A.B.C.D ipv4 (unicast|multicast) soft in
clear ip bgp A.B.C.D ipv4 (unicast|multicast) soft out
```

Parameters

A.B.C.D	IPv4 address
WORD	Interface name
in	Clear incoming advertised routes.
prefix-filter	Push out prefix-list ORF and do inbound soft reconfig.
out	Clear outgoing advertised routes.
soft	Clear both incoming and outgoing routes.
in	Soft reconfig inbound update.
out	Soft reconfig outbound update.
ipv4	Clear incoming advertised routes.
multicast	Multicast prefixes.
unicast	Unicast prefixes.
in	Clear incoming advertised routes.
prefix-filter	Push out prefix-list ORF and do inbound soft reconfig.
out	Clear outgoing advertised routes.
soft	Clear both incoming and outgoing routes.
in	Soft reconfig inbound update.
out	Soft reconfig outbound update.

Command Mode

Privileged Exec mode

Applicability

This command was introduced before OcNOS version 1.3.

Examples

```
#clear ip bgp 35.0.0.1 in
```

clear ip bgp A.B.C.D vrf

Use this command to reset the VPN Routing/Forwarding (VRF) instance for a peer address.

Command Syntax

```
clear ip bgp A.B.C.D vrf WORD
clear ip bgp A.B.C.D vrf WORD in
clear ip bgp A.B.C.D vrf WORD out
clear ip bgp A.B.C.D vrf WORD soft
clear ip bgp A.B.C.D vrf WORD soft in
clear ip bgp A.B.C.D vrf WORD soft out
```

Parameters

A.B.C.D	IPv4 address
WORD	VPN routing/forwarding instance name
in	Clear incoming advertised routes
out	Clear outgoing advertised routes
soft	Clear both incoming and outgoing routes
in	Soft reconfig inbound update
out	Soft reconfig outbound update

Command Mode

Privileged Exec mode

Applicability

This command was introduced before OcNOS version 1.3.

Examples

```
#clear ip bgp 35.0.0.1 vrf
```

clear ip bgp all vrf (VRFNAME|all|default) (description LINE|)

Use this command to reset the BGP connection for vrf peer.

Command Syntax

```
clear ip bgp all vrf (VRFNAME|all|default) (description LINE|)
```

Parameters

VRFNAME	VPN routing/forwarding instance name
all	All VRFs
default	Default VRF
description	Administratively reset communication msg to neighbor

Command Mode

Privileged Exec mode

Applicability

This command is introduced in OcNOS version 6.0.0

Examples

```
#clear ip bgp all vrf vrf1  
#clear ip bgp all vrf all description all peer refresh is done
```

clear ip bgp table-map

Use this command to apply the modified table map or route map rules to the BGP routes in the existing IP routing table.

Command Syntax

```
clear ip bgp table-map (vrf (VRFNAME|all|default))
clear ip bgp ipv4 (unicast | multicast) table-map(vrf (VRFNAME|all|default))
```

Parameters

vrf	Select a VPN Routing/Forwarding Instance.
VRFNAME	Specify a VPN Routing/Forwarding instance name.
all	Select all VRFs.
default	Select default VRFs.
unicast	Unicast prefixes.
multicast	Multicast prefixes.

Command Mode

Privileged Exec mode

Applicability

This command was introduced before OcnOS version 1.3.

Examples

```
#clear ip bgp table-map vrf all
```

clear ip bgp vrf WORD (A.B.C.D|X:X::X:X|WORD) (description LINE|)

Use this command to reset the BGP connection for vrf peer.

Command Syntax

```
clear ip bgp vrf WORD (A.B.C.D|X:X::X:X|WORD) (description LINE|)
```

Parameters

WORD	VPN routing/forwarding instance name
A.B.C.D	Address of the BGP neighbor in an IPv4 format
X:X::X:X	Address of the BGP neighbor in an IPv6 format
WORD	Name of a BGP peer group created with the neighbor WORD peer-group command. When you specify this parameter, the command applies to all peers in the group.
description	Administratively reset communication msg to neighbor

Command Mode

Privileged Exec mode

Applicability

This command is introduced in OcNOS version 6.0.0

Examples

```
#clear ip bgp vrf vrf1 10.1.1.2  
#clear ip bgp vrf vrf1 10.1.1.2 description peer reset is done
```

debug bgp

Use this command to enable all BGP troubleshooting functions. Use this command without any parameters to turn on normal bgp debug information.

Use the `no` parameter with this command to disable this function.

Command Syntax

```
debug bgp (all|)
debug bgp bfd
debug bgp dampening
debug bgp events
debug bgp filters
debug bgp fsm
debug bgp keepalives
debug bgp mpls
debug bgp nht
debug bgp nsm
debug bgp updates
debug bgp updates (in|out)
debug bgp vpls
no debug bgp (all|)
no debug bgp bfd
no debug bgp dampening
no debug bgp events
no debug bgp filters
no debug bgp fsm
no debug bgp keepalives
no debug bgp mpls
no debug bgp nht
no debug bgp nsm
no debug bgp updates
no debug bgp vpls
undebug bgp (all|)
undebug bgp bfd
undebug bgp dampening
undebug bgp events
undebug bgp filters
undebug bgp fsm
undebug bgp keepalives
```

BGP Commands

```
undebg bgp mpls
undebg bgp nht
undebg bgp nsm
undebg bgp updates
undebg bgp vpls
```

Parameters

all	Used only with the <code>no</code> form; turns off all debugging for BGP
bfd	Enable debugging for BGP Bidirectional Forwarding Detection
dampening	Enable debugging for BGP dampening
events	Enable debugging for BGP events
filters	Enable debugging for BGP filters
fsm	Enable debugging for BGP Finite State Machine (FSM)
keepalives	Enable debugging for BGP keepalives
mpls	Enable debugging for BGP Multiprotocol Label Switching (MPLS)
nht	Enable debugging for BGP NHT
nsm	Enable debugging for NSM messages
updates	Enable debugging for BGP updates
in	Debug inbound updates
out	Debug outbound updates
vpls	Enable debugging for BGP Virtual Private LAN Service (VPLS)

Command Mode

Privileged Exec mode and Configure Mode

Applicability

This command was introduced before OcnOS version 1.3.

Examples

```
#debug bgp
#debug bgp events
```

distance bgp

Use this command to set BGP administrative distances. The administrative distance rates the trustworthiness of a routing information source. A higher distance value means a lower trust rating. For example, an administrative distance of 255 means that the routing information source cannot be trusted and should be ignored.

Use the no form of this command to restore the default value (110).

Command Syntax

```
distance <1-255>
distance <1-255> A.B.C.D/M (WORD|)
no distance <1-255>
no distance <1-255> A.B.C.D/M (WORD|)
```

Parameters

<1-255>	Distance for BGP routes
A.B.C.D/M	Distance for routes to prefixes whose nexthop matches this address.
WORD	Name of access list to apply to route updates.

Command Mode

Router BGP mode

Defaults

None

Applicability

This command was introduced in OcNOS version 6.0.0.

Examples

```
#configure terminal
(config)#router bgp 100
(config-router)#distance 100 10.10.10.10/30
```

exit-address-family

Use this command to exit Address-Family-vrf, Address-Family-vpnv4 mode.

For information on how to enter the address family mode (IPv4, VPNv4), see [address-family](#).

Command Syntax

```
exit-address-family
```

Parameters

None

Default

No default value is specified

Command Mode

Address Family-vrf and Address Family-vpnv4 mode.

Applicability

This command was introduced before OcNOS version 1.3.

Examples

The following examples shows the change in the prompt after using this command.

```
#configure terminal
(config)#router bgp 100
(config-router)#address-family ipv4 multicast
(config-router-af)#exit-address-family
(config-router)#
```

ip as-path access-list

Use this command to define a BGP Autonomous System (AS) path access list. A named community list is a filter based on regular expressions. If the regular expression matches the specified string representing the AS path of the route, then the permit or deny condition applies. Use this command to define the BGP access list globally; use the neighbor router configuration command to apply a specific access list.

Use the no parameter with this command to disable use of the access list.

Command Syntax

```
ip as-path access-list WORD (deny|permit) LINE
no ip as-path access-list WORD (deny|permit) LINE
```

Parameters

WORD	Access list name
deny	Reject packets
permit	Forward packets
LINE	An ordered list as a regular expression

Default

No default value is specified

Command Mode

Configure mode

Applicability

This command was introduced before OcNOS version 1.3.

Examples

```
#configure terminal
(config)#ip as-path access-list mylist deny ^65535$
```

ip community-list <1-99>

Use this command to specify a standard community list (1 to 99) that specifies BGP community attributes.

Use the `no` parameter with this command to delete the community list entry.

Command Syntax

```
ip community-list <1-99> (deny|permit)
ip community-list <1-99> (deny|permit) [AA:NN|internet|local-AS|no-advertise|no-export]
no ip community-list <1-99> (deny|permit)
no ip community-list <1-99> (deny|permit) [AA:NN|internet|local-AS|no-advertise|no-export]
```

Parameters

<code>deny</code>	Reject the community
<code>permit</code>	Accept the community
<code>AA:NN</code>	Community number
<code>internet</code>	Advertise routes to the internet community
<code>local-AS</code>	Do not advertise routes to external BGP peers
<code>no-advertise</code>	Do not advertise routes to other BGP peers
<code>no-export</code>	Do not advertise routes outside of Autonomous System boundary

Default

By default, ip community list is disabled

Command Mode

Configure mode

Applicability

This command was introduced before OcnOS version 1.3.

Examples

```
#configure terminal
(config)#ip community-list 55 permit 7675:80 7675:90

(config)#no ip community-list 55 permit 7675:80 7675:90
```

ip community-list <100-500>

Use this command to specify an expanded community list (100 to 500) that specifies BGP community attributes.

Use the `no` parameter with this command to delete the community list entry.

Command Syntax

```
ip community-list <100-500> (deny|permit)
ip community-list <100-500> (deny|permit) LINE
no ip community-list <100-500>
no ip community-list <100-500> (deny|permit) LINE
```

Parameters

<code>deny</code>	Reject community
<code>permit</code>	Accept community
<code>LINE</code>	An ordered list as a regular expression

Default

By default, ip community list is disabled

Command Mode

Configure mode

Applicability

This command was introduced before OcNOS version 1.3.

Examples

```
#configure terminal
(config)#ip community-list 225 permit 6789906
(config)#ip community-list expanded CLIST permit .*
```

ip community-list expanded

Use the community-lists to specify BGP community attributes. The community attribute is used for implementing policy routing. It is an optional, transitive attribute and facilitates transfer of local policies through different autonomous systems. It includes community values that are 32-bits long.

There are two kinds of community-lists: expanded and standard. The standard community-list defines the community attributes in a specified format and not with regular expressions. The expanded community-list defines the community attributes with regular expressions. Use the `no` parameter with this command to delete the community list entry.

Command Syntax

```
ip community-list expanded WORD (deny|permit) LINE
no ip community-list expanded WORD
no ip community-list expanded WORD (deny|permit) LINE
```

Parameters

WORD	Community list name
deny	Reject community
permit	Accept community
LINE	An ordered list as a regular expression

Default

By default, ip community list is disabled

Command Mode

Configure mode

Applicability

This command was introduced before OcNOS version 1.3.

Examples

```
#configure terminal
(config)#ip community-list 125 permit 6789906
(config)#ip community-list expanded CLIST permit .*
```

ip community-list standard

Use the community-lists to specify BGP community attributes. The community attribute is used for implementing policy routing. It is an optional, transitive attribute and facilitates transfer of local policies through different autonomous systems. It includes community values that are 32-bits long. There are two kinds of community-lists: expanded and standard. The standard community-list defines the community attributes in a specified format without regular expressions. The expanded community-list defines the community attributes with regular expressions.

Use this command to add a standard community-list entry. The standard community-list is compiled into binary format and is directly compared with the BGP communities attribute in the BGP updates. The comparison is faster than the expanded community-list. Any community value that does not match the standard community value is automatically treated as expanded.

Use the `no` parameter with this command to delete the standard community-list entry.

Command Syntax

```
ip community-list standard WORD (deny|permit)
ip community-list standard WORD (deny|permit) [AA:NN|internet|local-AS|no-
advertise|no-export]
no ip community-list standard WORD (deny|permit) [AA:NN|internet|local-AS|no-
advertise|no-export]
```

Parameters

WORD	Community list name
deny	Reject the community
permit	Accept the community
AA:NN	Community number
internet	Advertise routes to the internet community
local-AS	Do not advertise routes to external BGP peers
no-advertise	Do not advertise routes to other BGP peers
no-export	Do not advertise routes outside of Autonomous System boundary

Default

By default, ip community list is disabled

Command Mode

Configure mode

Applicability

This command was introduced before OcNOS version 1.3.

Examples

```
#configure terminal
(config)#ip community-list standard CLIST permit 7675:80 7675:90 no-export
(config)#ip community-list 34 permit 5675:50 no-advertise
```

ip community-list WORD

Use the community-list commands to specify BGP community attributes. The community attribute is used for implementing policy routing. It is an optional, transitive attribute and facilitates transfer of local policies through different autonomous systems. There are two kinds of community-lists: the expanded and standard. The `standard community-list` defines the community attributes in a specified format and not with regular expressions. The `expanded community-list` defines the community attributes with regular expressions.

Use the `no` parameter with this command to delete the community list entry.

Command Syntax

```
ip community-list WORD (deny|permit)
ip community-list WORD (deny|permit) [AA:NN|internet|local-AS|no-advertise|no-export]
no ip community-list WORD
no ip community-list WORD (deny|permit) [AA:NN|internet|local-AS|no-advertise|no-export]
```

Parameters

WORD	Community list name
deny	Reject the community
permit	Accept the community
AA:NN	Community number
internet	Advertise routes to the internet community
local-AS	Do not advertise routes to external BGP peers
no-advertise	Do not advertise routes to other BGP peers
no-export	Do not advertise routes outside of Autonomous System boundary

Default

By default, ip community list is disabled

Command Mode

Configure mode

Applicability

This command was introduced before OcnOS version 1.3.

Examples

```
#configure terminal
(config)#ip community-list mylist permit 7675:80 7675:90

(config)#no ip community-list mylist permit 7675:80 7675:90
```

ip extcommunity-list <1-99>

Use this command to create an entry for a standard extended community list.

Use the `no` parameter with this command to delete the community-list entry.

Command Syntax

```
ip extcommunity-list <1-99> (deny|permit) LINE (rt|soo)
no ip extcommunity-list <1-99> (deny|permit) LINE (rt|soo)
```

Parameters

<code>deny</code>	Reject community
<code>permit</code>	Accept community
<code>LINE</code>	One of the following:
<code>rt</code>	Route target extended community in aa:nn or IPaddr:nn format
<code>soo</code>	Site-of-origin extended community in aa:nn or IPaddr:nn format

Default

By default, `ip extcommunity list` is disabled

Command Mode

Configure mode

Applicability

This command was introduced before OcNOS version 1.3.

Examples

```
#configure terminal
(config)#ip extcommunity-list 3 permit rt 10.10.23.123:67

(config)#ip extcommunity-list 25 deny soo 1465:22
```

ip extcommunity-list <100-500>

Use this command to create an extended community list.

Use the `no` parameter with this command to delete the community-list entry.

Command Syntax

```
ip extcommunity-list <100-500> (deny|permit) LINE
no ip extcommunity-list <100-500> (deny|permit) LINE
```

Parameters

<100-500>	Extended community list number (expanded)
deny	Reject the community
permit	Accept the community
LINE	Any regular expression:

Default

By default, ip extcommunity list is disabled

Command Mode

Configure mode

Applicability

This command was introduced before OcNOS version 1.3.

Examples

```
#configure terminal
(config)#ip extcommunity-list 125 permit 4567:335

(config)#ip extcommunity-list 231 deny *.
```

ip extcommunity-list expanded

Use this command to create an expanded community list. The expanded community-list defines the community attributes with regular expressions. The expanded community-list match will happen based on input given for regular expressions.

Use the `no` parameter with this command to delete the expanded community-list entry.

Command Syntax

```
ip extcommunity-list expanded WORD
ip extcommunity-list expanded WORD (deny|permit) LINE
no ip extcommunity-list expanded WORD
no ip extcommunity-list expanded WORD (deny|permit) LINE
```

Parameters

WORD	Expanded community list name
deny	Reject the community
permit	Accept the community
LINE	One of the following:
rt	Route target extended community in aa:nn or IPaddr:nn format
soo	Site-of-origin extended community in aa:nn or IPaddr:nn format

Default

By default, ip extcommunity list is disabled

Command Mode

Configure mode

Applicability

This command was introduced before OcNOS version 1.3.

Examples

```
#configure terminal
(config)#ip extcommunity-list e1 permit 2001:1 300:1
(config)#ip extcommunity-list expanded CLIST permit ^[2001:1 300:1]$
```

ip extcommunity-list standard

Use this command to create and delete a standard extended-community list. The extended community attribute is 8 bytes in 2 formats. The sub-type can be route target (`rt`) or site of origin (`soo`). Thus, the sub-type of each community must be specified when creating the extended community list. Regarding the formats, an extended community is based on a 6-byte value. These 6-bytes are represented in 4-byte:2-byte format, and may be entered in one of the following forms:

- Format 1, `aa.nn`: The 16-bit value of the AS (`aa`) number is represented in the higher-order 4-bytes. If the extended ASN capability is enabled, the AS number is represented using higher-order 4-bytes. The `nn` assigned value is represented in the low-order 2-bytes in both cases.
- Format 2, `IPaddr:nn`: In this format, the higher-order 4-bytes are used to represent the IP address, and the low-order 2-bytes are used to represent the assigned value.

Use the `no` parameter with this command to delete the extended-community-list entry.

Command Syntax

```
ip extcommunity-list standard WORD (deny|permit) (rt|soo) (aa:nn)
no ip extcommunity-list standard WORD (deny|permit) (rt|soo) (aa:nn)
```

Parameters

<code>WORD</code>	Extended community list name
<code>deny</code>	Reject the community
<code>permit</code>	Accept the community
<code>rt</code>	Route target extended community in <code>aa:nn</code> or <code>IPaddr:nn</code> format
<code>soo</code>	Site-of-origin extended community in <code>aa:nn</code> or <code>IPaddr:nn</code> format

Default

By default, ip extcommunity list is disabled

Command Mode

Configure mode

Applicability

This command was introduced before OcNOS version 1.3.

Examples

```
#configure terminal
(config)#ip extcommunity-list standard 36 permit rt 5675:50
(config)#ip extcommunity-list standard CLIST permit soo 10.10.32.15:70
```

l2vpn-unnumbered-mode

Use this command to configure the unnumbered peer with all the neighbor configs applicable in L2VPN EVPN address family.

Use the `exit` parameter with this command to leave L2VPN unnumbered mode.

Command Syntax

```
bgp l2vpn-unnumbered-mode
exit-l2vpn-unnumbered-mode
```

Parameters

None

Applicability

No default value is specified

Command Mode

Address-family IPv4 Unicast Mode

Applicability

This command was introduced in OcNOS-OTN version 4.2.

Examples

```
#configure terminal
(config)#router bgp 100
(config-router)#address-family l2vpn evpn
(config-router-af)#bgp l2vpn-unnumbered-mode
(config-router-l2vpn-unnum) #
```

match ip peer

Use this command to apply policies based on the route source of which the BGP TCP/IP session formed using an IPv4 address in the update message.

Use the `no` parameter with this command to disable this function.

Command Syntax

```
match ip peer (<1-199>|<1300-2699>|WORD)
no match ip peer (<1-199>|<1300-2699>|WORD)
```

Parameters

<1-199>	IP access-list number
<1300-2699>	IP access-list number (expanded range)
WORD	Access-list name

Default

By default, `import bgp route` is disabled

Command Mode

Route-map mode

Applicability

This command was introduced before OcNOS version 1.3.

Examples

```
#configure terminal
(config)#route-map in-A permit 10
(route-map)#match ip peer 1
```

match large-community

Use this command to match the large community.

Command Syntax

```
match large-community XXX:YYYY:ZZZ
no match large-community XXX:YYYY:ZZZ
```

Parameters

XXX:YYYY:ZZZ Large community number

Default

By default send-community large is enabled for peer

Command Mode

Route-map mode

Applicability

This command was introduced in OcNOS version 6.1.0.

Examples

```
(config)#route-map R1 permit 10
(config-route-map)#match large-community 1111:2222:33333
(config-route-map)#
```

max-paths

Use this command to set the number of equal-cost multi-path (ECMP) routes for eBGP or iBGP. You can install multiple BGP paths to the same destination to balance the load on the forwarding path.

Use the `no` parameter with this command to disable this feature.

Command Syntax

```
max-paths (ebgp|ibgp|) <2-64>
no max-paths ebgp (<2-64>|)
no max-paths ibgp (<2-64>|)
```

Parameters

<code>ebgp</code>	eBGP ECMP session
<code>ibgp</code>	iBGP ECMP session
<code><2-64></code>	Number of routes

Default

Available for the IPv4 and IPv6 unicast addresses.

Command Mode

Address Family mode

Applicability

This command was introduced before OcnOS version 1.3.

Examples

The following example configures 7 routes for ECMP for iBGP.

```
#configure terminal
(config)#router bgp 11
(config-router)#address-family ipv4 unicast
(config-router-af)#max-paths ibgp 7
```

max-paths eibgp

Use this command to set the number of equal-cost multi-path (ECMP) routes for both eBGP and iBGP. This feature allows you to configure multipath load balancing with both external BGP (eBGP) and internal BGP (iBGP) paths in BGP networks.

Use the `no` parameter with this command to disable this feature and set the BGP path selection to the default single best path.

Command Syntax

```
max-paths eibgp <2-64>
no max-paths eibgp (<2-64>|)
```

Parameters

<2-64> Number of routes

Default

Not applicable

Command Mode

IPv4 and IPv6 unicast address-family mode

Applicability

This command was introduced in OcNOS version 5.0.

Exception with Administrative Distance

Administrative distance (AD) is the feature that routers use to select the best path when there are two or more different routes to the same destination from two different routing protocols.

In OcNOS, AD is per route. With `max-paths eibgp`, BGP programs the AD(200)/AD20 for eiBGP routes. If there is a route from IGP with a lower AD, it will be preferred and get installed in the FIB.

A BGP route cannot have a different AD for each path. Multipath candidates of `eibgp max-paths` can be programmed either with AD20 or AD200.

Currently AD20/AD200 will be programmed for all eiBGP routes as per best path selected by BGP. For example, if the best path is learned via iBGP peering, then AD200 is programmed for all the installed multipaths (including paths from eBGP peering) or If the best path is learned via eBGP peering, then AD20 is programmed for all the installed multipaths (including paths from iBGP peering).

Example

This example configures the number of parallel iBGP and eBGP routes that can be installed into a routing table.

```
(config)#router bgp 100
(config-router)#neighbor 11.0.0.2 remote-as 100
(config-router)#neighbor 12.0.0.1 remote-as 200
(config-router)#neighbor 1101::2 remote-as 200
(config-router)#neighbor 1201::1 remote-as 100
(config-router)#address-family ipv4 unicast
(config-router-af)#max-paths eibgp 2
```

BGP Commands

```
(config-router-af)#network 11.0.0.2 activate
(config-router-af)#network 12.0.0.1 activate
(config-router-af)#exit-address-family
(config-router)#address-family ipv6 unicast
(config-router-af)#max-paths eibgp 3
(config-router-af)#network 1101::2 activate
(config-router-af)#network 1201::1 activate
(config-router-af)#exit-address-family
```

neighbor activate

Use this command to enable the exchange of specific address family routes with a neighboring router. After a TCP connection is opened with a neighboring router, use this command to enable or disable the exchange of address family information. To enable the exchange of multicast and VPNv4 address prefix types, activate neighbors using this command in address family mode.

Use the `no` parameter with this command to disable exchange of information with a neighbor.

Command Syntax

```
neighbor (A.B.C.D|X:X::X:X|WORD) activate
no neighbor (A.B.C.D|X:X::X:X|WORD) activate
```

For L2VPN-unnumbered mode:

```
neighbor WORD activate
no neighbor WORD activate
```

Parameters

A.B.C.D	Address of the BGP neighbor in an IPv4 format
X:X::X:X	Address of the BGP neighbor in an IPv6 format
WORD	Name of a BGP peer group created with the neighbor WORD peer-group command. When you specify this parameter, the command applies to all peers in the group.

Default

By default activate is disabled. For all address-families, use this command to enable a neighbor to exchange routing information of a specific address-family with a neighbor.

Command Mode

Address Family mode and l2vpn-unnumbered mode

Applicability

This command was introduced before OcNOS version 1.3.

Examples

```
#configure terminal
(config)#router bgp 100
(config-router)#address-family vpnv4 unicast
(config-router-af)#neighbor 10.10.20.1 activate

(config)#router bgp 100
(config-router)#address-family l2vpn evpn
(config-router-af)#bgp l2vpn-unnumbered-mode
(config-router-l2vpn-unnum)#neighbor eth1 activate
```

neighbor advertisement-interval

Use this command to set a minimum interval between the sending of BGP routing updates. To reduce the flapping of routes, set a minimum advertisement interval so that the BGP routing updates are sent only per interval seconds. BGP dampening can also be used to control the effects of flapping routes.

Use the `no` parameter with this command to set the interval time to default.

Command Syntax

```
neighbor (A.B.C.D|X:X::X:X|WORD) advertisement-interval <0-65535>
no neighbor (A.B.C.D|X:X::X:X|WORD) advertisement-interval
no neighbor (A.B.C.D|X:X::X:X|WORD) advertisement-interval <0-65535>
```

For BGP unnumbered mode:

```
neighbor WORD advertisement-interval <0-65535>
no neighbor WORD advertisement-interval
```

Parameters

A.B.C.D	Address of the BGP neighbor in an IPv4 format
X:X::X:X	Address of the BGP neighbor in an IPv6 format
WORD	Name of a BGP peer group created with the neighbor WORD peer-group command. When you specify this parameter, the command applies to all peers in the group.
<0-65535>	Advertisement interval value in seconds

Default

By default, neighbor value for ebgp peer is 30 seconds and IBGP peer is 5 seconds

Command Mode

Router mode and BGP unnumbered mode

Applicability

This command was introduced before OcNOS version 1.3.

Example

```
#configure terminal
(config)#router bgp 10
(config-router)#neighbor 10.10.0.3 advertisement-interval 45
```

For unnumbered peer this configuration is given in BGP unnumbered-mode.

```
(config)#router bgp 100
(config-router)#bgp unnumbered-mode
(config-router-unnum)#neighbor eth1 advertisement-interval 20
```

neighbor allowas-in

Use this command to advertise prefixes (routes) even when the source of the prefixes is from the same Autonomous System (AS) number.

Use this command in a scenario where two routers at different locations use the same Autonomous System number and are connected via an ISP. Once prefixes arrive from one branch at the ISP, they are tagged with the customer's AS number. By default, when the ISP passes the prefixes to the other router, the prefixes are dropped if the other router uses the same AS number. Use this command to advertise the prefixes at the other side. Control the number of times an AS number is advertised by specifying a number.

In a hub and spoke configuration in a VPN, a PE (Provider Edge) router advertises all prefixes containing duplicate AS numbers. Use this command to configure two VRFs on each PE router to receive and advertise prefixes. One of the VRFs receives prefixes with AS numbers from all PE routers and then advertises them to neighboring PE routers. The other VRF receives prefixes with AS numbers from the CE (Customer Edge) router and advertises them to all PE routers in the hub and spoke configuration.

Use the `no` parameter with this command to remove the configuration.

For unnumbered peer IPv4 unicast mode commands are configured under `v4-unnumbered-mode`.

Command Syntax

```
neighbor (A.B.C.D|X:X::X:X|WORD) allowas-in <1-10>
no neighbor (A.B.C.D|X:X::X:X|WORD) allowas-in
```

For `v4-unnumbered mode`:

```
neighbor WORD allowas-in
neighbor WORD allowas-in <1-10>
no neighbor WORD allowas-in
```

Parameters

A.B.C.D	IPv4 neighbor address.
X:X::X:X	IPv6 neighbor address.
WORD	Name of peer group.

Note: For information on how to create peer groups, refer to the `neighbor peer-group` and `neighbor remote-as` commands. When this parameter is used with a command, the command applies on all peers in the specified group.

<1-10>	Number of times to allow the advertisement of an AS number
--------	--

Default

No default value is specified.

Command Mode

This CLI command is available to configure in all Address-family modes (`v4-unnumbered mode`, IPv4 unicast, IPv6 unicast, IPv4 labeled-unicast, IPv6 labeled-unicast, VPNv4 unicast, VPNv6 unicast, IPv4/IPv6 VRF, L2VPN EVPN)

Applicability

This command was introduced before OcNOS version 1.3.

Example

```
#configure terminal
(config)#router bgp 7657
(config-router)#address-family ipv4 vrf VRF_A
(config-router-af)#neighbor 10.10.0.1 allowas-in 3

#configure terminal
(config)#router bgp 7657
(config-router)#address-family ipv6 vrf VRF_A
(config-router-af)#neighbor 3ffe:15:15:15:15::0 allowas-in 3

#con terminal
(config)#router bgp 100
(config-router)#address-family ipv4 unicast
(config-router-af)#bgp v4-unnumbered-mode
(config-router-v4-unnum)#neighbor eth1 allowas-in 6
```

For unnumbered peer configs in L2vpn evpn mode are configured under l2vpn-unnumbered-mode.

```
(config)#router bgp 100
(config-router)#address-family l2vpn evpn
(config-router-af)#neighbor eth1 allowas-in 7
```

neighbor as-origination-interval

Use this command to set the minimum interval between sending of AS-origination routing updates.

Use the `no` parameter with this command to disable this function.

Command Syntax

```
neighbor (A.B.C.D|X:X::X:X|WORD) as-origination-interval <1-65535>
no neighbor (A.B.C.D|X:X::X:X|WORD) as-origination-interval
no neighbor (A.B.C.D|X:X::X:X|WORD) as-origination-interval <1-65535>
```

For BGP unnumbered mode:

```
neighbor WORD as-origination-interval interval <0-65535>
no neighbor WORD as-origination-interval
```

Parameters

A.B.C.D	Address of the BGP neighbor in an IPv4 format
X:X::X:X	Address of the BGP neighbor in an IPv6 format
WORD	Name of a BGP peer group created with the neighbor WORD peer-group command. When you specify this parameter, the command applies to all peers in the group.
<1-65535>	AS origination interval in seconds

Default

By default, neighbor as origination interval is 15 seconds

Command Mode

Router mode and BGP unnumbered mode

Applicability

This command was introduced before OcnOS version 1.3.

Example

```
#configure terminal
(config)#router bgp 10
(config-router)#neighbor 10.10.0.75 as-origination-interval 555
```

For unnumbered peer this configuration is given in BGP unnumbered-mode.

```
(config)#router bgp 100
(config-router)#bgp unnumbered-mode
(config-router-unnum)#neighbor eth1 as-origination-interval 50
```

neighbor attribute-unchanged

Use this command to advertise unchanged BGP attributes to the specified neighbor.

Use the `no` parameter with this command to disable this function.

For unnumbered peer IPv4 unicast mode commands are configured under `v4-unnumbered-mode`.

Command Syntax

```
neighbor (A.B.C.D|X:X::X:X|WORD) attribute-unchanged ({ as-path|next-hop|med }|)
no neighbor (A.B.C.D|X:X::X:X|WORD) attribute-unchanged (({ as-path|next-hop|
med }|))
```

For `v4-unnumbered mode`:

```
neighbor WORD attribute-unchanged ({ as-path|next-hop|med }|)
no neighbor WORD attribute-unchanged (({ as-path|next-hop|med }|))
```

Parameters

A.B.C.D	Address of the BGP neighbor in an IPv4 format
X:X::X:X	Address of the BGP neighbor in an IPv6 format
WORD	Name of a BGP peer group created with the neighbor WORD peer-group command. When you specify this parameter, the command applies to all peers in the group.
as-path	AS path attribute
next-hop	Nexthop attribute
med	Multi-exit discriminator attribute

Default

By default, the `neighbor attribute-unchanged` is disabled

Command Mode

Address Family mode and `v4-unnumbered mode`

Applicability

This command was introduced before OcnOS version 1.3.

Example

```
#configure terminal
(config)#router bgp 10
(config-router)#address-family ipv4 unicast
(config-router-af)#neighbor 10.10.0.75 attribute-unchanged as-path med

(config)#router bgp 100
(config-router)#address-family ipv4 unicast
(config-router-af)#bgp v4-unnumbered-mode
(config-router-v4-unnum)#OcnOS (config-router-v4-unnum)#neighbor eth1
attribute-unchanged as-path
```

neighbor authentication-key

Use this command to enable message digest5 (MD5) authentication on a TCP connection between two BGP peers. Configuring MD5 authentication between two BGP peers, means that each segment sent on the TCP connection between the peers is verified. MD5 authentication must be configured with the same password on both BGP peers; otherwise, the connection between them will not be established.

Use the `no` parameter with this command to delete the MD5 authentication.

Command Syntax

```
neighbor (A.B.C.D|X:X::X:X|WORD) authentication-key (0 | 1 |) <WORD>
<WORD> plain text password
neighbor (A.B.C.D|X:X::X:X|WORD) authentication-key <WORD>
<WORD> encrypted password
no neighbor (A.B.C.D|X:X::X:X|WORD) authentication-key <WORD>
<WORD> encrypted password
```

Parameters

A.B.C.D	Address of the BGP neighbor in an IPv4 format
X:X::X:X	Address of the BGP neighbor in an IPv6 format
WORD	Name of the BGP peer group
0	Unencrypted password
WORD	Unencrypted password (maximum length 80 characters)
1	Encrypted password (default)
WORD	Encrypted password (maximum length 162 characters)

Default

Not applicable

Command Mode

Router mode

Applicability

This command was introduced before OcNOS version 1.3.

Example

```
#configure terminal
(config)#router bgp 11
(config-router)#neighbor 10.10.0.73 authentication-key 0 myPass
(config-router)#no neighbor 10.10.0.73 authentication-key 0xba76ef302e2f20af
```

For unnumbered peer below configuration is given in BGP unnumbered-mode.

```
(config)#router bgp 100
(config-router)#bgp unnumbered-mode
(config-router-unnun)#neighbor eth1 authentication-key 0 key1
```

neighbor capability dynamic

Use this command to enable the dynamic capability for a specific peer. This command allows a BGP speaker to advertise or withdraw an address family capability to a peer in a non-disruptive manner.

Use the `no` parameter with this command to disable the dynamic capability.

For unnumbered peer, IPv4 unicast mode commands are configured under `v4-unnumbered-mode`.

Command Syntax

```
neighbor (A.B.C.D|X:X::X:X|WORD) capability dynamic
no neighbor (A.B.C.D|X:X::X:X|WORD) capability dynamic
```

For `v4-unnumbered mode`:

```
neighbor WORD capability dynamic
no neighbor WORD capability dynamic
```

Parameters

A.B.C.D	Address of the BGP neighbor in an IPv4 format
X:X::X:X	Address of the BGP neighbor in an IPv6 format
WORD	Name of a BGP peer group created with the neighbor WORD peer-group command. When you specify this parameter, the command applies to all peers in the group.

Default

By default, `neighbor capability dynamic` is disabled

Command Mode

Router mode and Address Family `v4-unnumbered mode`

Applicability

This command was introduced before OcNOS version 1.3.

Examples

```
#configure terminal
(config)#router bgp 10
(config-router)#neighbor 10.10.10.1 capability dynamic

(config)#router bgp 100
(config-router)#address-family ipv4 unicast
(config-router-af)#bgp v4-unnumbered-mode
(config-router-v4-unnum)#neighbor eth1 activate
(config-router-v4-unnum)#neighbor eth1 capability dynamic
```

neighbor capability graceful-restart

Use this command to advertise the graceful restart capability to its neighbor. This configuration indicates that the BGP speaker has the ability to preserve its forwarding state for the address family when BGP restarts.

You must first specify a neighbor's `remote-as` identification number assigned by the neighbor router.

Note: The graceful restart capability is advertised only when the graceful restart capability has been enabled using the [bgp graceful-restart](#) command.

Use the `no` parameter with this command to not advertise the graceful restart capability to its neighbor.

Command Syntax

```
neighbor (A.B.C.D|X:X::X:X|WORD) capability graceful-restart
no neighbor (A.B.C.D|X:X::X:X|WORD) capability graceful-restart
```

Parameters

A.B.C.D	Address of the BGP neighbor in an IPv4 format
X:X::X:X	Address of the BGP neighbor in an IPv6 format
WORD	Name of a BGP peer group created with the neighbor WORD peer-group command. When you specify this parameter, the command applies to all peers in the group.

Default

By default, the graceful-restart is disabled

Command Mode

Address Family mode

Applicability

This command was introduced before OcnOS version 1.3.

Examples

```
#configure terminal
(config)#router bgp 10
(config-router)#address-family ipv4 unicast
(config-router-af)#neighbor 10.10.10.50 capability graceful-restart
```

neighbor capability orf prefix-list

Use this command to enable Outbound Router Filtering (ORF) and advertise the ORF capability to its neighbors. The ORFs send and receive capabilities to lessen the number of updates exchanged between neighbors. By filtering updates, this option minimizes generating and processing of updates.

The two routers exchange updates to maintain the ORF for each router:

- The local router advertises the ORF capability in `send` mode.
- The remote router receives the ORF capability in `receive` mode, applying the filter as outbound policy.

Only an individual router or a peer group can be configured to be in `receive` or `send` mode. A peer-group member cannot be configured to be in `receive` or `send` mode.

Use the `no` parameter with this command to disable this function.

For unnumbered peer, IPv4 unicast mode commands are configured under `v4-unnumbered-mode`.

Command Syntax

```
neighbor (A.B.C.D|X:X::X:X|WORD) capability orf prefix-list (both|receive|send)
no neighbor (A.B.C.D|X:X::X:X|WORD) capability orf prefix-list (both|receive|send)
```

For `v4-unnumbered mode`:

```
neighbor WORD capability orf prefix-list (both|receive|send)
no neighbor WORD capability orf prefix-list (both|receive|send)
```

Parameters

<code>A.B.C.D</code>	Address of the BGP neighbor in an IPv4 format
<code>X:X::X:X</code>	Address of the BGP neighbor in an IPv6 format
<code>WORD</code>	Name of a BGP peer group created with the neighbor WORD peer-group command. When you specify this parameter, the command applies to all peers in the group.
<code>both</code>	The local router can send ORF entries to its peer, as well as receive ORF entries from its peer.
<code>receive</code>	The local router is willing to receive ORF entries from its peer
<code>send</code>	The local router is willing to send ORF entries to its peer

Default

By default, the `orf prefix-list` is disabled

Command Mode

Router Address Family (IPv4 unicast, IPv4 multicast, IPv6, v4-unnumbered) mode

Applicability

This command was introduced before OcNOS version 1.3.

Examples

```
#configure terminal
(config)#router bgp 10
(config-router)#address-family ipv4 unicast
```

```
(config-router-af)#neighbor 10.10.0.5 capability orf prefix-list both  
(config-router-af)#neighbor effe:2897::0003:3ed5 capability orf prefix-list  
receive
```

```
(config)#router bgp 100  
(config-router)#address-family ipv4 unicast  
(config-router-af)#bgp v4-unnumbered-mode  
(config-router-v4-unnum)#neighbor eth1 capability orf prefix-list both
```

neighbor collide-established

Use this command to include a neighbor already in an established state for conflict resolution when a TCP connection collision is detected. This command is not required for most network deployments, so users should only use this command when required.

Note: The associated functionality of including an “established” neighbor into TCP connection collision conflict resolution is automatically enabled when a neighbor is configured for BGP graceful-restart.

Use the `no` option with this command to turn this feature off.

Command Syntax

```
neighbor (A.B.C.D|X:X::X:X|WORD) collide-established
no neighbor (A.B.C.D|X:X::X:X|WORD) collide-established
```

For BGP unnumbered mode:

```
neighbor WORD collide-established
no neighbor WORD collide-established
```

Parameters

A.B.C.D	Address of the BGP neighbor in an IPv4 format
X:X::X:X	Address of the BGP neighbor in an IPv6 format
WORD	Name of a BGP peer group created with the neighbor WORD peer-group command. When you specify this parameter, the command applies to all peers in the group.

Default

By default, neighbor collide is disabled

Command Mode

Router mode and BGP unnumbered mode

Applicability

This command was introduced before OcnOS version 1.3.

Example

```
#configure terminal
(config)#router bgp 10
(config-router)#neighbor 3.3.3.3 collide-established
```

For unnumbered peer below configuration is given in BGP unnumbered-mode.

```
(config)#router bgp 100
(config-router)#bgp unnumbered-mode
(config-router-unnum)#neighbor eth1 collide-established
```

neighbor de-activate

Use this command to disable the exchange of specific address family routes with a neighboring router for peer-group member. After a TCP connection is opened with a neighboring router, use this command to enable or disable the exchange of address family information for peer-group member.

Use the `no` parameter with this command to inherit the properties of peer-group. i.e., If peer-group is activated in the given address-family, `no` of this command will activate the peer member as peer-group is activated in address-family..

Command Syntax

```
neighbor (A.B.C.D|X:X::X:X) de-activate
no neighbor (A.B.C.D|X:X::X:X) de-activate
```

Parameters

A.B.C.D	Address of the BGP neighbor in an IPv4 format
X:X::X:X	Address of the BGP neighbor in an IPv6 format

Default

By default `de-activate` is disabled **for all peer-group members**. For all address-families, Use this command to disable a neighbor to exchange routing information of a specific address-family with a neighbor.

Command Mode

Address Family mode

Applicability

This command is introduced in OcNOS version 6.0.0. This command is applicable only to neighbor which is a member of peer-group.

Examples

```
#configure terminal
router bgp 100
neighbor pgl peer-group
neighbor pgl remote-as 100
neighbor 10.1.1.2 peer-group pgl
neighbor 20.1.1.2 peer-group pgl
neighbor 30.1.1.2 remote-as 100
!
address-family ipv4 unicast
neighbor pgl activate
neighbor 30.1.1.2 activate
exit-address-family
!
(config-router-af)#neighbor 10.1.1.2 de-activate
(config-router-af)#show running-config bgp
!
router bgp 100
neighbor pgl peer-group
neighbor pgl remote-as 100
neighbor 10.1.1.2 peer-group pgl
neighbor 20.1.1.2 peer-group pgl
```

```
neighbor 30.1.1.2 remote-as 100
!
address-family ipv4 unicast
neighbor pgl activate
neighbor 10.1.1.2 de-activate
neighbor 30.1.1.2 activate
exit-address-family
!
(config-router-af)#no neighbor 10.1.1.2 de-activate
(config-router-af)#commit
(config-router-af)#
(config-router-af)#show running-config bgp
!
router bgp 100
neighbor pgl peer-group
neighbor pgl remote-as 100
neighbor 10.1.1.2 peer-group pgl
neighbor 20.1.1.2 peer-group pgl
neighbor 30.1.1.2 remote-as 100
!
address-family ipv4 unicast
neighbor pgl activate
neighbor 30.1.1.2 activate
exit-address-family
!
```

neighbor default-originate

Use this command to allow a BGP local router to send the default route 0.0.0.0 to a neighbor to use as a default route. This command can be used with standard or extended access lists.

Use the `no` parameter with this command to send no route as a default.

Command Syntax

```
neighbor (A.B.C.D|X:X::X:X|WORD) default-originate
neighbor (A.B.C.D|X:X::X:X|WORD) default-originate route-map WORD
no neighbor (A.B.C.D|X:X::X:X|WORD) default-originate
no neighbor (A.B.C.D|X:X::X:X|WORD) default-originate route-map WORD
```

For v4-unnumbered mode:

```
neighbor WORD default-originate
neighbor WORD default-originate route-map WORD
no neighbor WORD default-originate
no neighbor WORD default-originate route-map WORD
```

Parameters

A.B.C.D	Address of the BGP neighbor in an IPv4 format
X:X::X:X	Address of the BGP neighbor in an IPv6 format
WORD	Name of a BGP peer group created with the neighbor WORD peer-group command. When you specify this parameter, the command applies to all peers in the group.
WORD	Route map name

Default

By default, `neighbor default-originate` is disabled

Command Mode

Route Address Family mode and v4-unnumbered mode

Applicability

This command was introduced before OcnOS version 1.3.

Examples

```
#configure terminal
(config)#router bgp 10
(config-router)#address-family ipv4 unicast
(config-router-af)#neighbor 10.10.10.1 default-originate route-map myroute
```

For unnumbered peer, IPv4 unicast mode commands are configured under v4-unnumbered-mode.

```
#con terminal
(config)#router bgp 100
(config-router)#address-family ipv4 unicast
(config-router-af)#bgp v4-unnumbered-mode
(config-router-v4-unnum)#neighbor eth1 default-originate
```

neighbor description

Use this command to associate a description with a neighbor. This command helps to identify a neighbor quickly. This command is useful for an ISP that has multiple neighbor relationships.

Use the `no` parameter with this command to remove the description.

Command Syntax

```
neighbor (A.B.C.D|X:X::X:X|WORD) description LINE
no neighbor (A.B.C.D|X:X::X:X|WORD) description
no neighbor (A.B.C.D|X:X::X:X|WORD) description LINE
```

For BGP unnumbered mode:

```
neighbor WORD description LINE
no neighbor WORD description
```

Parameters

A.B.C.D	Address of the BGP neighbor in an IPv4 format
X:X::X:X	Address of the BGP neighbor in an IPv6 format
WORD	Name of a BGP peer group created with the neighbor WORD peer-group command. When you specify this parameter, the command applies to all peers in the group.
LINE	Neighbor description (up to 80 characters)

Default

By default, the neighbor description is disabled

Command Mode

Router mode and Address Family and BGP unnumbered mode

Applicability

This command was introduced before OcNOS version 1.3.

Examples

```
#configure terminal
(config)#router bgp 10
(config-router)#neighbor 1.2.3.4 description Backup router for sales

(config)#router bgp 100
(config-router)#address-family ipv6 vrf VRF_A
(config-router-af)#neighbor 3ffe:15:15:15:15::0 description Bank of America
```

For unnumbered peer below configuration is given in BGP unnumbered-mode.

```
(config)#router bgp 100
(config-router)#bgp unnumbered-mode
(config-router-unnum)#neighbor eth1 description unnumbered-peer1
```

neighbor disallow-infinite-holdtime

Use this command to disallow configuration of infinite hold-time. This command enables the local BGP speaker to reject a hold-time of "0" seconds from a peer (during exchange of open messages) or a user (during configuration).

The `no` form of this command allows the BGP speaker to accept a hold-time of "0" from a peer or during configuration.

Command Syntax

```
neighbor (A.B.C.D|X:X::X:X|WORD) disallow-infinite-holdtime
no neighbor (A.B.C.D|X:X::X:X|WORD) disallow-infinite-holdtime
```

For BGP unnumbered mode:

```
neighbor WORD disallow-infinite-holdtime
no neighbor WORD disallow-infinite-holdtime
```

Parameters

A.B.C.D	Address of the BGP neighbor in an IPv4 format
X:X::X:X	Address of the BGP neighbor in an IPv6 format
WORD	Name of a BGP peer group created with the neighbor WORD peer-group command. When you specify this parameter, the command applies to all peers in the group.

Default

By default, `neighbor disallow infinite holdtime` is disabled

Command Mode

Router mode and BGP unnumbered mode

Applicability

This command was introduced before OcnOS version 1.3.

Examples

```
(config-router)#neighbor 10.11.4.26 disallow-infinite-holdtime
(config-router)#neighbor 3ffe::45 disallow-infinite-holdtime
```

For unnumbered peer below configuration is given in BGP unnumbered-mode.

```
(config)#router bgp 100
(config-router)#bgp unnumbered-mode
(config-router-annum)#neighbor eth1 disallow-infinite-holdtime
```

neighbor distribute-list

Use this command to filter route updates from a particular BGP neighbor. Use only one distribute list per BGP neighbor. Use the `no` parameter with this command to remove an entry.

Command Syntax

```
neighbor (A.B.C.D|X:X::X:X|WORD) distribute-list (<1-199>|<1300-2699>|WORD)
(in|out)
no neighbor (A.B.C.D|X:X::X:X|WORD) distribute-list (<1-199>|<1300-2699>|WORD)
(in|out)
```

For v4-unnumbered mode:

```
neighbor WORD distribute-list (<1-199>|<1300-2699>|WORD) (in|out)
no neighbor WORD distribute-list (<1-199>|<1300-2699>|WORD) (in|out)
```

Parameters

A.B.C.D	Address of the BGP neighbor in an IPv4 format
X:X::X:X	Address of the BGP neighbor in an IPv6 format
WORD	Name of a BGP peer group created with the neighbor WORD peer-group command. When you specify this parameter, the command applies to all peers in the group.
<1-199>	IP access-list number
<1300-2699>	IP access-list number (expanded-range)
WORD	Access-list name
in	Filter incoming advertised routes
out	Filter outgoing advertised routes

Default

By default, neighbor distribute list is disabled

Command Mode

Address Family mode and v4-unnumbered mode

Applicability

This command was introduced before OcNOS version 1.3.

Examples

```
#configure terminal
(config)#router bgp 10
(config-router)#address-family ipv4 unicast
(config-router-af)#neighbor 1.2.3.4 distribute-list mylist out
```

For unnumbered peer, IPv4 unicast mode commands are configured under v4-unnumbered-mode.

```
(config)#router bgp 100
(config-router)#address-family ipv4 unicast
(config-router-af)#bgp v4-unnumbered-mode
(config-router-v4-unnum)#neighbor eth1 distribute-list list1 in
```

neighbor dont-capability-negotiate

Use this command to disable capability negotiation. This command is used to allow compatibility with older BGP versions that have no capability parameters used in open messages between peers.

Use the `no` parameter with this command to enable capability negotiation.

Command Syntax

```
neighbor (A.B.C.D|X:X::X:X|WORD) dont-capability-negotiate
no neighbor (A.B.C.D|X:X::X:X|WORD) dont-capability-negotiate
```

For BGP unnumbered mode:

```
neighbor WORD dont-capability-negotiate
no neighbor WORD dont-capability-negotiate
```

Parameters

A.B.C.D	Address of the BGP neighbor in an IPv4 format
X:X::X:X	Address of the BGP neighbor in an IPv6 format
WORD	Name of a BGP peer group created with the neighbor WORD peer-group command. When you specify this parameter, the command applies to all peers in the group.

Default

By default, capability negotiation is disabled

Command Mode

Router mode and BGP unnumbered mode

Applicability

This command was introduced before OcNOS version 1.3.

Examples

```
#configure terminal
(config)#router bgp 10
(config-router)#neighbor 10.10.0.34 dont-capability-negotiate
```

For unnumbered peer below configuration is given in BGP unnumbered-mode.

```
(config)#router bgp 100
(config-router)#bgp unnumbered-mode
(config-router-unnun)#neighbor eth1 dont-capability-negotiate
```

neighbor ebgp-multihop

Use this command to accept and try BGP connections to external peers on indirectly connected networks. Multihop is not established if the only route to the multihop peer is a default route. This avoids loop formation.

Use the `no` parameter with this command to return to the default.

Command Syntax

```
neighbor (A.B.C.D|X:X::X:X|WORD) ebgp-multihop
neighbor (A.B.C.D|X:X::X:X|WORD) ebgp-multihop <1-255>
no neighbor (A.B.C.D|X:X::X:X|WORD) ebgp-multihop
no neighbor (A.B.C.D|X:X::X:X|WORD) ebgp-multihop <1-255>
```

For BGP unnumbered mode:

```
neighbor WORD ebgp-multihop
neighbor WORD ebgp-multihop <1-255>
no neighbor WORD ebgp-multihop
no neighbor WORD ebgp-multihop <1-255>
```

Parameters

A.B.C.D	Address of the BGP neighbor in an IPv4 format
X:X::X:X	Address of the BGP neighbor in an IPv6 format
WORD	Name of a BGP peer group created with the neighbor WORD peer-group command. When you specify this parameter, the command applies to all peers in the group.
<1-255>	Maximum hop count

Default

By default, maximum hop count is 255

Command Mode

Router mode and BGP unnumbered mode

Applicability

This command was introduced before OcnOS version 1.3.

Examples

```
#configure terminal
(config)#router bgp 10
(config-router)#neighbor 10.10.10.34 remote-as 20
(config-router)#neighbor 10.10.10.34 ebgp-multihop 5
```

For unnumbered peer below configuration is given in BGP unnumbered-mode.

```
(config)#router bgp 100
(config-router)#bgp unnumbered-mode
(config-router-unnum)#neighbor eth1 ebgp-multihop
```

neighbor enforce-multihop

Use this command to enforce BGP neighbors to perform multihop.

Use the `no` parameter with this command to turn off this feature.

Command Syntax

```
neighbor (A.B.C.D|X:X::X:X|WORD) enforce-multihop
no neighbor (A.B.C.D|X:X::X:X|WORD) enforce-multihop
```

For BGP unnumbered mode:

```
neighbor WORD enforce-multihop
no neighbor WORD enforce-multihop
```

Parameters

A.B.C.D	Address of the BGP neighbor in an IPv4 format
X:X::X:X	Address of the BGP neighbor in an IPv6 format
WORD	Name of a BGP peer group created with the neighbor WORD peer-group command. When you specify this parameter, the command applies to all peers in the group.

Default

By default, the maximum hop count is 255

Command Mode

Router mode and BGP unnumbered mode

Applicability

This command was introduced before OcnOS version 1.3.

Examples

```
#configure terminal
(config)#router bgp 10
(config-router)#neighbor 10.10.0.34 remote-as 20
(config-router)#neighbor 10.10.0.34 enforce-multihop
```

For unnumbered peer below configuration is given in BGP unnumbered-mode.

```
(config)#router bgp 100
(config-router)#bgp unnumbered-mode
(config-router-unnum)#neighbor eth1 enforce-multihop
```

neighbor extended-optional-param

Use this command enable extended optional parameter length for BGP OPEN messages as specified in RFC 9072.

Use the `no` form of this command to disable extended optional parameter length.

Command Syntax

```
neighbor A.B.C.D|X:X::X:X|WORD extended-optional-param
no neighbor A.B.C.D|X:X::X:X|WORD extended-optional-param
```

Parameters

A.B.C.D	Address of the BGP neighbor in an IPv4 format
X:X::X:X	Address of the BGP neighbor in an IPv6 format
WORD	Name of a BGP peer group created with the neighbor WORD peer-group command. When you specify this parameter, the command applies to all peers in the group.

Default

Extended optional parameter length is disabled by default.

Command Mode

BGP router mode

Applicability

This command was introduced in OcnOS version 6.0.0.

Example

```
(config)#router bgp 100
(config-router)#neighbor 1.1.1.1 extended-optional-param
(config-router)#commit
(config-router)#show run bgp
!
router bgp 100
  bgp router-id 11.11.11.11
  neighbor 1.1.1.1 remote-as 100
  neighbor 1.1.1.1 extended-optional-param
```

neighbor fall-over bfd

Use this command to enable the BFD for BGP peers.

Use the `no` form of the command to disable the BFD option for BGP peers.

Command Syntax

```
neighbor (A.B.C.D|X:X::X:X|WORD) fall-over bfd (multihop|)
no neighbor (A.B.C.D|X:X::X:X|WORD) fall-over bfd (multihop|)
```

Parameters

A.B.C.D	Address of the BGP neighbor in an IPv4 format.
X:X::X:X	Address of the BGP neighbor in an IPv6 format
WORD	Name of a BGP peer group created with the neighbor WORD peer-group command. When you specify this parameter, the command applies to all peers in the group.
multihop	Enable multihop

Default

Bidirectional Forwarding Detection for BGP peers is disabled by default.

Command Mode

Router mode

Applicability

This command was introduced before OcNOS version 1.3.

Example

```
#configure terminal
Enter configuration commands, one per line. End with CNTL/Z.
(config)#router bgp 100
(config-router)#neighbor 10.2.3.4 fall-over bfd
(config-router)#
(config-router)#neighbor 10.2.3.4 fall-over bfd multihop
```

neighbor filter-list

Use this command to set up a BGP filter. This command specifies an access list filter on updates based on the BGP autonomous system paths. Each filter is an access list based on regular expressions.

Use the `no` parameter with this command to disable this function.

Command Syntax

```
neighbor (A.B.C.D|X:X::X:X|WORD) filter-list WORD (in|out)
no neighbor (A.B.C.D|X:X::X:X|WORD) filter-list WORD (in|out)
```

For v4-unnumbered mode:

```
neighbor WORD filter-list WORD (in|out)
no neighbor WORD filter-list WORD (in|out)
```

Parameters

A.B.C.D	Address of the BGP neighbor in an IPv4 format
X:X::X:X	Address of the BGP neighbor in an IPv6 format
WORD	Name of a BGP peer group created with the neighbor WORD peer-group command. When you specify this parameter, the command applies to all peers in the group.
WORD	Name of an autonomous system path access list
in	Filter incoming advertised routes
out	Filter outgoing advertised route

Default

By default, filter list is disabled

Command Mode

Address Family mode and v4-unnumbered mode

Applicability

This command was introduced before OcnOS version 1.3.

Examples

```
#configure terminal
(config)#router bgp 10
(config-router)#neighbor 10.10.0.34 remote-as 20
(config-router)#address-family ipv4 unicast
(config-router-af)#neighbor 10.10.0.34 filter-list out in
```

For unnumbered peer, IPv4 unicast mode commands are configured under v4-unnumbered-mode.

```
(config)#router bgp 100
(config-router)#address-family ipv4 unicast
(config-router-af)#bgp v4-unnumbered-mode
(config-router-v4-unnum)#neighbor eth1 filter-list list2 in
```

neighbor g-shut

Use this command to start a graceful shutdown for the BGP session of the specified BGP neighbor. The BGP session for this neighbor is shut down after the graceful shutdown timer expires.

If there is no alternate path available for traffic to flow prior the actual shutdown of the BGP session, this path is made available for 60 seconds or for configured time after which the path is no longer available and traffic is dropped.

Use the `no` parameter with this command to bring up the session again for the specified BGP neighbor whose BGP session had been shut down using the `neighbor g-shut` command.

Note: The graceful shutdown capability is not supported on iBGP sessions.

Command Syntax

```
neighbor (A.B.C.D|X:X::X:X|WORD) g-shut
no neighbor (A.B.C.D|X:X::X:X|WORD) g-shut
```

Parameters

A.B.C.D	Neighbor IPv4 address
X:X::X:X	Neighbor IPv6 address
WORD	Neighbor tag

Default

By default, `neighbor g-shut` is disabled

Command Mode

Router mode

Applicability

This command was introduced before OcnOS version 1.3.

Examples

```
#configure terminal
(config)#router bgp 100
(config-router)#neighbor 1.1.1.2 g-shut

#configure terminal
(config)#router bgp 100
(config-router)#no neighbor 1.1.1.2 g-shut
```

neighbor g-shut-timer

Use this command to configure the value of the graceful shutdown timer. After the timer expires, the BGP session initiated for graceful shutdown is shut down.

Use the `no` parameter with this command to revert to the default setting.

Command Syntax

```
neighbor (A.B.C.D|X:X::X:X|WORD) g-shut-timer <10-65535>
no neighbor (A.B.C.D|X:X::X:X|WORD) g-shut-timer <10-65535>
```

Parameters

A.B.C.D	Neighbor IPv4 address
X:X::X:X	Neighbor IPv6 address
WORD	Neighbor tag
<10-65535>	Graceful shutdown timer in seconds

Default

By default, the timer value is set to 60 seconds

Command Mode

Router mode

Applicability

This command was introduced before OcNOS version 1.3.

Examples

```
#configure terminal
(config)#router bgp 100
(config-router)#neighbor 1.1.1.2 g-shut-timer 120
```

neighbor limit

Use this command to specify the maximum number of peers that can be configured in the BGP dynamic peer-group. Use the `no` parameter with this command to disable this function.

Command Syntax

```
neighbor WORD limit <1-200>
no neighbor WORD (limit <1-200>|)
```

Parameters

WORD	Name of a BGP peer group created with the neighbor WORD peer-group command.
<1-200>	The maximum number of peers that can be configured in a BGP dynamic peer-group.

Default

By default, neighbor word limit is disabled

Command Mode

Router mode and Address Family VRF mode

Applicability

This command was introduced before OcnOS version 1.3.

Example

```
#configure terminal
(config)#router bgp 11
(config-router)#neighbor group1 limit 120
```

neighbor local-as

Use this command to specify an AS (autonomous system) number to use with BGP neighbor.

Use the `no` parameter with this command to disable this command.

Command Syntax

```
neighbor (A.B.C.D|X:X::X:X|WORD) local-as <1-4294967295>
no neighbor (A.B.C.D|X:X::X:X|WORD) local-as <1-4294967295>
```

For BGP unnumbered mode:

```
neighbor WORD local-as <1-4294967295>
no neighbor WORD local-as <1-4294967295>
```

Parameters

A.B.C.D	Address of the BGP neighbor in an IPv4 format
X:X::X:X	Address of the BGP neighbor in an IPv6 format
WORD	Name of a BGP peer group created with the neighbor WORD peer-group command. When you specify this parameter, the command applies to all peers in the group.
<1-4294967295>	Neighbor's AS number when extended capabilities are configured

Note: The AS number 23456 is a reserved 2-byte AS number. An old BGP speaker (2-byte implementation) should be configured with 23456 as its remote AS number while peering with a non-mappable new BGP speaker (4-byte implementation).

Default

By default, local as is disabled

Command Mode

Router mode and BGP unnumbered mode

Applicability

This command was introduced before OcNOS version 1.3.

Example

```
#configure terminal
(config)#router bgp 11
(config-router)#neighbor 10.10.0.34 local-as 12345
```

For unnumbered peer below configuration is given in BGP unnumbered-mode.

```
(config)#router bgp 100
(config-router)#bgp unnumbered-mode
(config-router-unnum)#neighbor eth1 local-as 300
```

neighbor maximum-prefix

Use this command to set the number of prefixes that can be received from a neighbor.

Use the `no` parameter with this command to disable this function.

Note: For unnumbered peer, IPv4 unicast mode commands are configured under `v4-unnumbered-mode`.

Command Syntax

```
neighbor (A.B.C.D|X:X::X:X|WORD) maximum-prefix <1-4294967295> <1-100|>
neighbor (A.B.C.D|X:X::X:X|WORD) maximum-prefix <1-4294967295> stop-update
neighbor (A.B.C.D|X:X::X:X|WORD) maximum-prefix <1-4294967295> warning-only
neighbor (A.B.C.D|X:X::X:X|WORD) maximum-prefix <1-4294967295> <1-100> warning-only
no neighbor (A.B.C.D|X:X::X:X) maximum-prefix <1-4294967295>
```

Parameters

A.B.C.D	Address of the BGP neighbor in an IPv4 format
X:X::X:X	Address of the BGP neighbor in an IPv6 format
WORD	Name of a BGP peer group created with the neighbor WORD peer-group command. When you specify this parameter, the command applies to all peers in the group.
<1-4294967295>	Maximum number of prefixes accepted from this peer
stop-update	Stop installing routes when the maximum number of prefixes is exceeded.
<1-100>	Threshold value percent <1-100>
warning-only	Only give a warning message when the limit is exceeded. When this parameter is not specified and extra prefixes are received, the router ends the peering. A terminated peer remains down until the clear ip bgp A.B.C.D command is given.

Default

By default, neighbor maximum prefix is disabled

Command Mode

Address Family mode ad v4-unnumbered mode

Applicability

This command was introduced before OcNOS version 1.3.

Examples

```
#configure terminal
(config)#router bgp 10
(config-router)#address-family ipv4 unicast
(config-router-af)#neighbor 10.10.0.72 maximum-prefix 1244 warning-only

(config)#router bgp 100
(config-router)#address-family ipv4 unicast
(config-router-af)#bgp v4-unnumbered-mode
(config-router-v4-unnum)#neighbor eth1 maximum-prefix 3
```

neighbor next-hop-self

Use this command to make the router the next hop for a BGP-speaking neighbor or peer group. This command allows a BGP router to change the nexthop information that is sent to the iBGP peer. The nexthop information is set to the IP address of the interface used to communicate with the neighbor.

Use the `no` parameter with this command to disable this feature.

For unnumbered peer, IPv4 unicast mode commands are configured under `v4-unnumbered-mode`.

Command Syntax

```
neighbor (A.B.C.D|X:X::X:X|WORD) next-hop-self
no neighbor (A.B.C.D|X:X::X:X|WORD) next-hop-self
```

Parameters

A.B.C.D	Address of the BGP neighbor in an IPv4 format
X:X::X:X	Address of the BGP neighbor in an IPv6 format
WORD	Name of a BGP peer group created with the neighbor WORD peer-group command. When you specify this parameter, the command applies to all peers in the group.

Default

By default, next hop self is disabled

Command Mode

Address Family mode and v4-unnumbered mode

Applicability

This command was introduced before OcnOS version 1.3.

Examples

```
#configure terminal
(config)#router bgp 10
(config-router)#neighbor 10.10.0.72 remote-as 100
(config-router)#address-family ipv4 unicast
(config-router-af)#neighbor 10.10.0.72 next-hop-self

(config)#router bgp 100
(config-router)#address-family ipv4 unicast
(config-router-af)#bgp v4-unnumbered-mode
(config-router-v4-unnum)#neighbor eth1 next-hop-self
```

neighbor optional-as

Use this command to specify an AS (autonomous system) number to use with BGP dynamic peer-group.

Use the `no` parameter with this command to disable this function.

Command Syntax

```
neighbor WORD optional-as <1-4294967295>
no neighbor WORD optional-as <1-4294967295>
```

Parameters

WORD	Name of a BGP peer group created with the neighbor WORD peer-group command. When you specify this parameter, the command applies to all peers in the group.
<1-4294967295>	The range from which the optional AS number must be configured.

Default

By default, `neighbor optional as` is disabled

Command Mode

Router mode and Address Family VRF mode

Applicability

This command was introduced before OcnOS version 1.3.

Examples

```
#configure terminal
(config)#router bgp 12
(config-router)#neighbor group1 optional-as 400
```

neighbor override-capability

Use this command to ignore received capabilities and use locally configured values.

Use the `no` parameter with this command to disable this function.

Command Syntax

```
neighbor (A.B.C.D|X:X::X:X|WORD) override-capability
no neighbor (A.B.C.D|X:X::X:X|WORD) override-capability
```

For BGP unnumbered mode:

```
neighbor WORD override-capability
no neighbor WORD override-capability
```

Parameters

A.B.C.D	Address of the BGP neighbor in an IPv4 format
X:X::X:X	Address of the BGP neighbor in an IPv6 format
WORD	Name of a BGP peer group created with the neighbor WORD peer-group command. When you specify this parameter, the command applies to all peers in the group.

Default

By default, `override-capability` is disabled

Command Mode

Router mode and BGP unnumbered mode

Applicability

This command was introduced before OcNOS version 1.3.

Examples

```
#configure terminal
(config)#router bgp 12
(config-router)#neighbor 10.10.10.10 override-capability
```

For unnumbered peer below configuration is given in BGP unnumbered-mode.

```
(config)#router bgp 100
(config-router)#bgp unnumbered-mode
(config-router-unnum)#neighbor eth1 override-capability
```

neighbor passive

Use this command to make a BGP neighbor passive.

Use the `no` parameter with this command to disable this function.

Command Syntax

```
neighbor (A.B.C.D|X:X::X:X|WORD) passive
no neighbor (A.B.C.D|X:X::X:X|WORD) passive
```

For BGP unnumbered mode:

```
neighbor WORD passive
no neighbor WORD passive
```

Parameters

A.B.C.D	Address of the BGP neighbor in an IPv4 format
X:X::X:X	Address of the BGP neighbor in an IPv6 format
WORD	Name of a BGP peer group created with the neighbor WORD peer-group command. When you specify this parameter, the command applies to all peers in the group.

Default

By default, `neighbor passive` is disabled

Command Mode

Router mode and BGP unnumbered mode

Applicability

This command was introduced before OcnOS version 1.3.

Examples

```
#configure terminal
(config)#router bgp 12
(config-router)#neighbor 10.10.10.10 passive
```

For unnumbered peer below configuration is given in BGP unnumbered-mode.

```
(config)#router bgp 100
(config-router)#bgp unnumbered-mode
(config-router-unnum)#neighbor eth1 passive
```

neighbor peer-group

Use this command to add a neighbor to an existing peer group. Neighbors with the same update policies are grouped into peer groups. This facilitates the updates of various policies, such as distribute and filter lists. The peer group is then configured easily with any of the neighbor commands. Any changes made to the peer group affect all members.

See [Usage](#) below for when a peer group and a neighbor have conflicting attribute configurations.

To create a peer group, use the [neighbor WORD peer-group](#) command, and then use this command to add neighbors to the group.

Use the no parameter with this command to remove a neighbor from a named peer group.

Command Syntax

```
neighbor (A.B.C.D|X:X::X:X) peer-group WORD
no neighbor (A.B.C.D|X:X::X:X) peer-group WORD
```

For BGP unnumbered mode:

```
neighbor WORD peer-group WORD
no neighbor WORD peer-group WORD
```

Parameters

A.B.C.D	Address of the BGP neighbor in IPv4 format
X:X::X:X	Address of the BGP neighbor in IPv6 format
WORD	Peer group name

Default

No default value is specified

Command Mode

Router mode and BGP unnumbered mode

Applicability

This command was introduced before OcnOS version 1.3.

Example

```
#configure terminal
(config)#router bgp 10
(config-router)#neighbor group1 peer-group
```

For unnumbered peer below configuration is given in BGP unnumbered-mode.

Note: For unnumbered peer we use peergroup key word to bind the unnumbered peer in group.

```
(config)#router bgp 100
(config-router)#bgp unnumbered-mode
(config-router-unnum)#neighbor eth1 peergroup ipi
```

Usage

When a *peer group* and a *peer* (neighbor) have conflicting attribute configurations the following rules apply:

- Outbound attribute configurations of a peer group *replace* peer member configurations of the same attributes when a peer becomes member of that peer group. Outbound attribute modifications to group members are not allowed.
- A peer group member's inbound attribute configurations take precedence over the peer group configuration.

These commands control outbound attribute updates:

- `neighbor activate`
- `neighbor advertisement-interval`
- `neighbor as-origination-interval`
- `neighbor attribute-unchanged`
- `neighbor capability orf prefix-list`
- `neighbor distribute-list` with an access-list number and the `out` parameter
- `neighbor dont-capability-negotiate`
- `neighbor filter-list` with the `out` parameter
- `neighbor next-hop-self`
- `neighbor prefix-list` with an access-list name and the `out` parameter
- `neighbor remove-private-AS`
- `neighbor route-map` with the `out` parameter
- `neighbor route-reflector-client`
- `neighbor route-server-client`
- `neighbor send-community`
- `neighbor unsuppress-map`

These commands control inbound attribute updates:

- `neighbor allowas-in`
- `neighbor collide-established`
- `neighbor description`
- `neighbor distribute-list` with an access-list number and the `in` parameter
- `neighbor ebgp-multihop`
- `neighbor enforce-multihop`
- `neighbor filter-list` with the `in` parameter
- `neighbor g-shut`
- `neighbor g-shut-timer`
- `neighbor local-as`
- `neighbor maximum-prefix`
- `neighbor override-capability`
- `neighbor passive`
- `neighbor authentication-key`
- `neighbor port`

- `neighbor prefix-list` with an access-list name and the `in` parameter
- `neighbor remote-as`
- `neighbor restart-time`
- `neighbor route-map` with the `in` parameter
- `neighbor shutdown`
- `neighbor strict-capability-match`
- `neighbor update-source`
- `neighbor weight`

neighbor WORD peer-group range

Use this command to create a dynamic peer group.

Use the no parameter with this command to remove a peer group.

Command Syntax

```
neighbor WORD peer-group range (A.B.C.D/M|X:X::X:X/M)
no neighbor WORD peer-group range (A.B.C.D/M|X:X::X:X/M)
```

Parameters

A.B.C.D/M	IP Prefix
X:X::X:X/M	IPv6 Prefix
WORD	Peer group name

Default

No default value is specified

Command Mode

Router mode and Address Family VRF mode.

Applicability

This command was introduced before OcnOS version 1.3.

Example

```
#configure terminal
(config)#router bgp 10
(config-router)#neighbor group1 peer-group range 10.10.10.0/24
```

neighbor port

Use this command to set the BGP port number of a neighbor.

Use the `no` parameter with this command to remove a port number from a BGP neighbor.

Command Syntax

```
neighbor (A.B.C.D|X:X::X:X|WORD) port <0-65535>
no neighbor (A.B.C.D|X:X::X:X|WORD) port
no neighbor (A.B.C.D|X:X::X:X|WORD) port <0-65535>
```

For BGP unnumbered mode:

```
neighbor WORD port <0-65535>
no neighbor WORD port
no neighbor WORD port <0-65535>
```

Parameters

A.B.C.D	Address of the BGP neighbor in an IPv4 format
X:X::X:X	Address of the BGP neighbor in an IPv6 format
WORD	Name of a BGP peer group created with the neighbor WORD peer-group command. When you specify this parameter, the command applies to all peers in the group.
<0-65535>	Port number

Default

By default, neighbor port is disabled

Command Mode

Router mode and BGP unnumbered mode

Applicability

This command was introduced before OcnOS version 1.3.

Examples

```
#configure terminal
(config)#router bgp 12
(config-router)#neighbor 10.10.10.10 port 643
```

For unnumbered peer below configuration is given in BGP unnumbered-mode.

```
(config)#router bgp 100
(config-router)#bgp unnumbered-mode
(config-router-unnum)#neighbor eth1 port 500
```

neighbor prefix-list

Use this command to specify a prefix list for filtering BGP advertisements.

Filtering by prefix list matches the prefixes of routes with those listed in the prefix list. If there is a match, the route is used. An empty prefix list permits all prefixes. If a given prefix does not match any entries of a prefix list, the route is denied access. When multiple entries of a prefix list match a prefix, the entry with the smallest sequence number is considered to be a real match.

The router begins the search at the top of the prefix list, with the sequence number 1. Once a match or deny occurs, the router does not need to go through the rest of the prefix list. For efficiency the most common matches or denies are listed at the top. The [neighbor distribute-list](#) command is an alternative to this command and only one of them can be used to filter the same neighbor in any direction.

Use the `no` parameter with this command to remove an entry.

Command Syntax

```
neighbor (A.B.C.D|X:X::X:X|WORD) prefix-list WORD (in|out)
no neighbor (A.B.C.D|X:X::X:X|WORD) prefix-list WORD (in|out)
```

For v4-unnumbered mode:

```
neighbor WORD prefix-list WORD (in|out)
no neighbor WORD prefix-list WORD (in|out)
```

Parameters

A.B.C.D	Address of the BGP neighbor in an IPv4 format
X:X::X:X	Address of the BGP neighbor in an IPv6 format
WORD	Name of a BGP peer group created with the neighbor WORD peer-group command. When you specify this parameter, the command applies to all peers in the group.
WORD	Name of an access list
in	Apply access list to incoming advertisements
out	Apply access list to outgoing advertisements

Default

By default, neighbor prefix list is disabled

Command Mode

Address Family mode and v4-unnumbered mode

Applicability

This command was introduced before OcnOS version 1.3.

Examples

```
#configure terminal
(config)#ip prefix-list list1 deny 30.0.0.0/24
(config)#router bgp 12
(config-router)#address-family ipv4 unicast
(config-router-af)#neighbor 10.10.10.10 prefix-list list1 in
```

For unnumbered peer, IPv4 unicast mode commands are configured under v4-unnumbered-mode.

```
(config)#router bgp 100
(config-router)#address-family ipv4 unicast
(config-router-af)#bgp v4-unnumbered-mode
(config-router-v4-unnum)#neighbor eth1 prefix-list list2 out
```

neighbor remote-as

Use this command to establish a BGP peering relationship with a customer edge router.

The specified neighbor only exchanges unicast address prefixes, unless the neighbor is also activated using the [neighbor activate](#) command, which allows the exchange of other routing information.

Use the `no` parameter with this command to delete this peering.

Command Syntax

```
neighbor (A.B.C.D|X:X::X:X|WORD) remote-as (<1-4294967295>|internal|external)
no neighbor (A.B.C.D|X:X::X:X|WORD) remote-as (<1-4294967295>|internal|external)
```

For BGP unnumbered mode:

```
neighbor WORD remote-as (internal|external)
no neighbor WORD remote-as (internal|external)
```

Parameters

A.B.C.D	Address of the BGP neighbor in an IPv4 format
X:X::X:X	Address of the BGP neighbor in an IPv6 format
WORD	Name of a BGP peer group created with the neighbor WORD peer-group command. When you specify this parameter, the command applies to all peers in the group. For an unnumbered interface (RFC 5549), specify an interface name configured with neighbor discovery or an IPv4 address with /31 or /30.
<1-4294967295>	Neighbor's autonomous system number (ASN) when extended capabilities are configured. If the specified ASN matches the ASN number specified in the router BGP global configuration, the neighbor is identified as internal. If the ASN does no match, the neighbor is identified as external to the local AS.
internal	iBGP peer.
external	eBGP peer.

Default

By default, neighbor remote is disabled

Command Mode

Router mode and Address Family-vrf mode and BGP unnumbered mode

Applicability

This command was introduced before OcNOS version 1.3 and updated in OcNOS version 1.3.6.

Example

```
#configure terminal
(config)#router bgp 11
(config-router)#neighbor 10.10.0.73 remote-as 345
(config-router)#neighbor 11.11.0.74 remote-as 23456
```

Note: The last command in the example above should be used when the local speaker is OBGP and the neighbor is NBGP with a 4-octet ASN.

```
(config)#router bgp 100
(config-router)#address-family ipv4 vrf VRF_A
(config-router-af)#neighbor 10.10.0.1 remote-as 65000

(config)#router bgp 100
(config-router)#address-family ipv6 vrf VRF_A
(config-router-af)#neighbor 3ffe:15:15:15:15::0 remote-as 65000

(config-router)#bgp unnumbered-mode
(config-router-unnum)#neighbor eth1 remote-as internal
(config-router-unnum)#show running bgp

router bgp 100
!
  bgp unnumbered-mode
  neighbor eth1 remote-as internal
  neighbor eth2 remote-as external
  exit-unnumbered-mode
!
```

neighbor remove-private-AS

Use this command to remove the private autonomous system number (ASN) from outbound updates. Private ASNs are not advertised to the Internet. This command is used with external BGP peers only. The router removes the ASNs only if the update includes private ASNs. If the update includes both private and public ASNs, the system treats it as an error.

Use the `no` parameter with this command to revert to default.

Command Syntax

```
neighbor (A.B.C.D|X:X::X:X|WORD) remove-private-AS
no neighbor (A.B.C.D|X:X::X:X|WORD) remove-private-AS
```

For v4-unnumbered mode:

```
neighbor WORD remove-private-AS
no neighbor WORD remove-private-AS
```

Parameters

A.B.C.D	Address of the BGP neighbor in an IPv4 format
X:X::X:X	Address of the BGP neighbor in an IPv6 format
WORD	Name of a BGP peer group created with the neighbor WORD peer-group command. When you specify this parameter, the command applies to all peers in the group.

Default

By default, `neighbor remove private AS` is disabled

Command Mode

Address Family mode and v4-unnumbered mode

Applicability

This command was introduced before OcnOS version 1.3.

Example

```
#configure terminal
(config)#router bgp 10
(config-router)#address-family ipv4 unicast
(config-router-af)#neighbor 10.10.0.63 remove-private-AS
```

For unnumbered peer, IPv4 unicast mode commands are configured under v4-unnumbered-mode.

```
(config)#router bgp 100
(config-router)#address-family ipv4 unicast
(config-router-af)#bgp v4-unnumbered-mode
(config-router-v4-unnum)#neighbor eth1 remove-private-AS
```

neighbor restart-time

Use this command to set a different restart-time than the global restart-time configured using the [bgp graceful-restart](#) command.

Use the `no` parameter with this command to restore the router to its default state.

Command Syntax

```
neighbor (A.B.C.D|X:X::X:X|WORD) restart-time <1-3600>
no neighbor (A.B.C.D|X:X::X:X|WORD) restart-time <1-3600>
```

Parameters

A.B.C.D	Address of the BGP neighbor in an IPv4 format
X:X::X:X	Address of the BGP neighbor in an IPv6 format
WORD	Name of a BGP peer group created with the neighbor WORD peer-group command. When you specify this parameter, the command applies to all peers in the group.
<1-3600>	The maximum time that a graceful-restart neighbor waits to come back up after a restart. Make sure that this value does not exceed the stalepath-time specified in router mode.

Default

By default, restart time is 90 seconds

Command Mode

Router mode

Applicability

This command was introduced before OcNOS version 1.3.

Example

```
#configure terminal
(config)#router bgp 10
(config-router)#neighbor 3.3.3.3 restart-time 45
```

neighbor route-map

Use this command to apply a route map to incoming or outgoing routes. This command filters updates and modifies attributes. A route map is applied to inbound or outbound updates. Only the routes that pass the route map are sent or accepted in updates.

Use the `no` parameter with this command to a route map.

Command Syntax

```
neighbor (A.B.C.D|X:X::X:X|WORD) route-map WORD (in|out)
no neighbor (A.B.C.D|X:X::X:X|WORD) route-map WORD (in|out)
```

For v4-unnumbered mode:

```
neighbor WORD route-map WORD (in|out)
no neighbor WORD route-map WORD (in|out)
```

Parameters

A.B.C.D	Address of the BGP neighbor in an IPv4 format
X:X::X:X	Address of the BGP neighbor in an IPv6 format
WORD	Name of a BGP peer group created with the neighbor WORD peer-group command. When you specify this parameter, the command applies to all peers in the group.
WORD	Name of the route map
in	Apply access list to incoming advertisements
out	Apply access list to outgoing advertisements

Default

No default value is specified

Command Mode

Address Family mode and v4-unnumbered mode

Applicability

This command was introduced before OcNOS version 1.3.

Examples

The following example shows the configuration of the route map named `rmap2` and then the use of this map name in the `neighbor route-map` command.

```
#configure terminal
(config)#route-map rmap2 permit 6
(config-route-map)#match origin incomplete
(config-route-map)#set metric 100
(config-route-map)#exit
(config)#router bgp 12
(config-router)#address-family ipv4 unicast
(config-router-af)#neighbor 10.10.10.10 route-map rmap2 in
```

For unnumbered peer, IPv4 unicast mode commands are configured under `v4-unnumbered-mode`.

BGP Commands

```
(config)#router bgp 100
(config-router)#address-family ipv4 unicast
(config-router-af)#bgp v4-unnumbered-mode
(config-router-v4-unnum)#neighbor eth1 route-map rmap1 in
```

neighbor route-reflector-client

Use this command to make the router a BGP route reflector and set a specified neighbor as its client.

Using route reflectors reduces the number of iBGP peers within an AS. An AS can have more than one route reflector. A route reflector treats other route reflectors as other iBGP speakers.

Use the `no` parameter with this command to indicate that the neighbor is not a client.

Command Syntax

```
neighbor (A.B.C.D|X:X::X:X|WORD) route-reflector-client
no neighbor (A.B.C.D|X:X::X:X|WORD) route-reflector-client
```

Parameters

A.B.C.D	Address of the BGP neighbor in an IPv4 format
X:X::X:X	Address of the BGP neighbor in an IPv6 format
WORD	Name of a BGP peer group created with the <code>neighbor WORD peer-group</code> command. When you specify this parameter, the command applies to all peers in the group.

Default

No default value is specified

Command Mode

This command is supported in all Address Family modes.

Applicability

This command was introduced before OcnOS version 1.3.

Examples

In the following configuration, Router1 is the route reflector for clients 3.3.3.3 and 2.2.2.2; it also has a non-client peer 6.6.6.6.

```
#configure terminal
(config)#router bgp 200
(config-router)#neighbor 3.3.3.3 remote-as 200
(config-router)#neighbor 2.2.2.2 remote-as 200
(config-router)#neighbor 6.6.6.6 remote-as 200
(config-router)#address-family ipv4 unicast
(config-router-af)#neighbor 3.3.3.3 route-reflector-client
(config-router-af)#neighbor 2.2.2.2 route-reflector-client
```

For unnumbered peer, IPv4 unicast mode commands are configured under `v4-unnumbered-mode`.

```
(config)#router bgp 100
(config-router)#address-family ipv4 unicast
(config-router-af)#bgp v4-unnumbered-mode
(config-router-v4-unnum)#neighbor eth1 route-reflector-client
```

For unnumbered peer, configs in L2vpn EVPN mode are configured under `l2vpn-unnumbered-mode`.

```
(config)#router bgp 100
(config-router)#address-family l2vpn evpn
(config-router-af)#neighbor eth1 route-reflector-client
```

neighbor route-server-client

Use this command to make a neighbor a route server client.

Use the `no` parameter with this command to remove the configuration of a neighbor as route server client.

Command Syntax

```
neighbor (A.B.C.D|X:X::X:X|WORD) route-server-client
no neighbor (A.B.C.D|X:X::X:X|WORD) route-server-client
```

For v4-unnumbered mode:

```
neighbor WORD route-server-client
no neighbor WORD route-server-client
```

Parameters

A.B.C.D	Address of the BGP neighbor in an IPv4 format
X:X::X:X	Address of the BGP neighbor in an IPv6 format
WORD	Name of a BGP peer group created with the neighbor WORD peer-group command. When you specify this parameter, the command applies to all peers in the group.

Default

No default value is specified

Command Mode

Address Family mode and v4-unnumbered mode

Applicability

This command was introduced before OcNOS version 1.3.

Example

```
#configure terminal
(config)#router bgp 10
(config-router)#address-family ipv4 unicast
(config-router-af)#neighbor 10.10.0.72 route-server-client

#configure terminal
(config)#router bgp 10
(config-router)#address-family ipv4 unicast
(config-router-af)#no neighbor 10.10.0.72 route-server-client
```

For unnumbered peer, IPv4 unicast mode commands are configured under v4-unnumbered-mode.

```
(config)#router bgp 100
(config-router)#address-family ipv4 unicast
(config-router-af)#bgp v4-unnumbered-mode
(config-router-v4-unnum)#neighbor eth1 route-server-client
```

neighbor send-community

Use this command to send that a community attribute to a BGP neighbor.

The community attribute groups destinations in a certain community and applies routing decisions according to those communities. On receiving community attributes, the router reannounces them to the neighbor.

By default, both `standard` and `extended` community attributes are sent to a neighbor. To explicitly send only the `standard` or `extended` community attribute, run the `bgp config-type` command with the `standard` parameter before running this command.

Use the `no` parameter with this command to not announce community attributes to the neighbor. Use the `extended` and `no` parameters to remove extended communities. Specifying no other parameter with `no` removes standard communities only.

See also [neighbor send-community](#) in [Chapter 6, BGP Virtual Private Network Commands](#).

Command Syntax

```
no neighbor (A.B.C.D|X:X::X:X|WORD) send-community
no neighbor (A.B.C.D|X:X::X:X|WORD) send-community (both|extended|standard)
neighbor (A.B.C.D|X:X::X:X|WORD) send-community
neighbor (A.B.C.D|X:X::X:X|WORD) send-community (both|extended|standard)
```

Parameters

A.B.C.D	Address of the BGP neighbor in an IPv4 format
X:X::X:X	Address of the BGP neighbor in an IPv6 format
WORD	Name of a BGP peer group created with the neighbor WORD peer-group command. When you specify this parameter, the command applies to all peers in the group.
both	Send Standard and Extended Community attributes
extended	Send Extended Community attributes
standard	Send Standard Community attributes

Default

By default, both communities (standard and extended) are sent to every BGP neighbor.

Command Mode

Address Family mode

Applicability

This command was introduced before OcNOS version 1.3.

Examples

```
(config)#router bgp 100
(config-router)#address-family ipv4 vrf VRF_A
(config-router-af)#neighbor 10.10.10.1 remote-as 200
(config-router-af)#no neighbor 10.10.0.1 send-community extended
```

neighbor send-community large

Use this command to send that a community attribute to a BGP neighbor.

Use the `no` parameter with this command to not announce community attributes to the neighbor.

Command Syntax

```
neighbor A.B.C.D send-community large
no neighbor A.B.C.D send-community large
```

Parameters

A.B.C.D Address of the BGP neighbor in an IPv4 format

Default

By default `send-community large` is enabled for peer

Command Mode

Address Family mode

Applicability

This command was introduced before OcNOS version 6.1.0.

Examples

```
(config)#router bgp 100
(config-router)#address-family ipv4 unicast
(config-router-af)#neighbor 1.1.1.1 activate
(config-router-af)#neighbor 1.1.1.1 send-community large
```

neighbor shutdown

Use this command to terminate active sessions for a specified neighbor and clear all related routing information.

If a peer group is specified, a large number of peering sessions might be terminated. The `show ip bgp summary` command displays a summary of BGP neighbors and their connections.

Use `description` option for operators to transmit a short free-form message to describe why a BGP session was shut down.

Use the `no` parameter with this command to re-enable a neighbor.

Command Syntax

```
neighbor (A.B.C.D|X:X::X:X|WORD) shutdown (description LINE|)
no neighbor (A.B.C.D|X:X::X:X|WORD) shutdown
```

Foe BGP unnumbered mode:

```
neighbor WORD shutdown (description LINE|)
no neighbor WORD shutdown
```

Parameters

A.B.C.D	Address of the BGP neighbor in an IPv4 format
X:X::X:X	Address of the BGP neighbor in an IPv6 format
WORD	Name of a BGP peer group created with the neighbor WORD peer-group command. When you specify this parameter, the command applies to all peers in the group.
description	Administratively shutdown communication msg to neighbor.

Default

By default, neighbor shutdown is disabled

Command Mode

Router mode and Address Family-vrf mode and BGP unnumbered mode

Applicability

This command was introduced before OcNOS version 1.3. The new version of the command with “description” option is introduced in OcNOS version 6.0.0.

Examples

```
#configure terminal
(config)#router bgp 10
(config-router)#neighbor 10.10.0.72 shutdown

(config)#router bgp 100
(config-router)#address-family ipv6 vrf VRF_A
(config-router-af)#neighbor 3ffe:15:15:15:15::0 shutdown description software
upgrade; back in 2 hours
```

For unnumbered peer below configuration is given in BGP unnumbered-mode.

```
(config)#router bgp 100
```

BGP Commands

```
(config-router)#bgp unnumbered-mode  
(config-router-unnum)#neighbor eth1 shutdown
```

neighbor strict-capability-match

Use this command to close the BGP connection if a capability value does not match the remote peer.

Use the `no` parameter with this command to disable this function.

Command Syntax

```
neighbor (A.B.C.D|X:X::X:X|WORD) strict-capability-match
no neighbor (A.B.C.D|X:X::X:X|WORD) strict-capability-match
```

For BGP unnumbered mode:

```
neighbor WORD strict-capability-match
no neighbor WORD strict-capability-match
```

Parameters

A.B.C.D	Address of the BGP neighbor in an IPv4 format
X:X::X:X	Address of the BGP neighbor in an IPv6 format
WORD	Name of a BGP peer group created with the neighbor WORD peer-group command. When you specify this parameter, the command applies to all peers in the group.

Default

By default, strict capability match is disabled

Command Mode

Router mode and BGP unnumbered mode

Applicability

This command was introduced before OcnOS version 1.3.

Examples

```
#configure terminal
(config)#router bgp 12
(config-router)#neighbor 10.10.10.10 strict-capability-match
```

For unnumbered peer below configuration is given in BGP unnumbered-mode.

```
(config)#router bgp 100
(config-router)#bgp unnumbered-mode
(config-router-unnum)#neighbor eth1 strict-capability-match
```

neighbor timers

Use this command to set the timers for a specific BGP neighbor.

Use the `no` parameter with this command to clear the timers for a BGP neighbor.

Command Syntax

```
neighbor (A.B.C.D|X:X::X:X|WORD) timers <0-65535> <0-65535>
neighbor (A.B.C.D|X:X::X:X|WORD) timers connect <1-65535>
no neighbor (A.B.C.D|X:X::X:X|WORD) timers
no neighbor (A.B.C.D|X:X::X:X|WORD) timers connect
```

For BGP unnumbered mode:

```
neighbor WORD timers <0-65535> <0-65535>
neighbor WORD timers connect <1-65535>
no neighbor WORD timers
no neighbor WORD timers connect
```

Parameters

A.B.C.D	Address of the BGP neighbor in an IPv4 format
X:X::X:X	Address of the BGP neighbor in an IPv6 format
WORD	Name of a BGP peer group created with the neighbor WORD peer-group command. When you specify this parameter, the command applies to all peers in the group.
<0-65535>	Keepalive interval. Keepalive messages are sent by a router to inform another router that the BGP connection between the two is still active. The keepalive interval is the period of time between each keepalive message sent by the router.
<0-65535>	Holdtime interval which is the time the router waits to receive a keepalive message. If the router does not receive a message in this period, the router declares the neighbor dead. The holdtime value should be at least 3 times the keepalive time.
connect	BGP connect timer
<1-65535>	Connect timer

Defaults

By default, keepalive timer value is 30 seconds

Command Mode

Router mode and BGP unnumbered mode

Applicability

This command was introduced before OcNOS version 1.3.

Examples

```
#configure terminal
(config)#router bgp 12
(config-router)#neighbor 10.10.10.10 timers 60 230
```

```
(config-router)#neighbor 10.10.10.10 timers connect 10
```

```
(config-router)#no neighbor 10.10.10.10 timers
```

For unnumbered peer below configuration is given in BGP unnumbered-mode.

```
(config)#router bgp 100
```

```
(config-router)#bgp unnumbered-mode
```

```
(config-router-annum)#neighbor eth1 timers 40 120
```

```
(config)#router bgp 100
```

```
(config-router)#bgp unnumbered-mode
```

```
(config-router-annum)#neighbor eth1 timers connect 50
```

neighbor unsuppress-map

Use this command to selectively leak more-specific routes to a particular neighbor.

When the [aggregate-address](#) command is used with the `summary-only` option, the more-specific routes of the aggregate are suppressed to all neighbors. Use the `neighbor unsuppress-map` command to selectively leak more-specific routes to a particular neighbor.

Use the `no` parameter with this command to restore the setting to the default level.

Command Syntax

```
neighbor (A.B.C.D|X:X::X:X|WORD) unsuppress-map WORD
no neighbor (A.B.C.D|X:X::X:X|WORD) unsuppress-map WORD
```

For v4-unnumbered mode:

```
neighbor WORD unsuppress-map WORD
no neighbor WORD unsuppress-map WORD
```

Parameters

A.B.C.D	Address of the BGP neighbor in an IPv4 format
X:X::X:X	Address of the BGP neighbor in an IPv6 format
WORD	Name of a BGP peer group created with the neighbor WORD peer-group command. When you specify this parameter, the command applies to all peers in the group.
WORD	Name of the route map used to select routes to unsuppress

Default

By default, neighbor unsuppress map is disabled

Command Mode

Address Family mode and v4-unnumbered mode

Applicability

This command was introduced before OcNOS version 1.3.

Example

```
#configure terminal
(config)#router bgp 10
(config-router)#address-family ipv4 unicast
(config-router-af)#neighbor 10.10.0.70 unsuppress-map mymap
```

For unnumbered peer, IPv4 unicast mode commands are configured under v4-unnumbered-mode.

```
(config)#router bgp 100
(config-router)#address-family ipv4 unicast
(config-router-af)#bgp v4-unnumbered-mode
(config-router-v4-unnum)#neighbor eth1 unsuppress-map map2
```

neighbor update-source

Use this command to allow internal BGP sessions to use any operating interface for TCP connections.

A loopback interface is most commonly used with this command. The use of loopback interface eliminates a dependency and BGP does not have to rely on the availability of a particular interface for making TCP connections.

Use the `no` parameter with this command to restore the interface assignment to the closest interface.

Command Syntax

```
neighbor (A.B.C.D|X:X::X:X|WORD) update-source WORD
no neighbor (A.B.C.D|X:X::X:X|WORD) update-source
```

For BGP unnumbered mode:

```
neighbor WORD update-source WORD
no neighbor WORD update-source
```

Parameters

A.B.C.D	Address of the BGP neighbor in an IPv4 format
X:X::X:X	Address of the BGP neighbor in an IPv6 format
WORD	Name of a BGP peer group created with the neighbor WORD peer-group command. When you specify this parameter, the command applies to all peers in the group.
WORD	Interface name

Default

By default, neighbor update source is disabled

Command Mode

Router mode and BGP unnumbered mode

Applicability

This command was introduced before OcNOS version 1.3.

Examples

```
#configure terminal
(config)#router bgp 10
(config-router)#neighbor 10.10.0.72 update-source myif
```

For unnumbered peer below configuration is given in BGP unnumbered-mode.

```
(config)#router bgp 100
(config-router)#bgp unnumbered-mode
(config-router-unnun)#neighbor eth1 update-source myif
```

neighbor version

Use this command to accept only a particular BGP version.

By default, the system uses BGP version 4 and on request dynamically negotiates down to version 2. Using this command disables the router's version-negotiation capability and forces the router to use only a specified version with the neighbor.

Use the `no` parameter with this command to use the default version level of a neighbor.

Command Syntax

```
neighbor (A.B.C.D|X:X::X:X|WORD) version 4
no neighbor (A.B.C.D|X:X::X:X|WORD) version
```

For BGP unnumbered mode:

```
neighbor WORD version 4
no neighbor WORD version
```

Parameters

A.B.C.D	Address of the BGP neighbor in an IPv4 format
X:X::X:X	Address of the BGP neighbor in an IPv6 format
WORD	Name of a BGP peer group created with the neighbor WORD peer-group command. When you specify this parameter, the command applies to all peers in the group.
4	BGP version number

Default

By default, the system uses BGP version 4 and on request dynamically negotiates down to version 2

Command Mode

Router mode and BGP unnumbered mode

Applicability

This command was introduced before OcNOS version 1.3.

Examples

```
#configure terminal
(config)#router bgp 12
(config-router)#neighbor 10.10.10.10 version 4
```

```
(config)#router bgp 12
(config-router)#no neighbor 10.10.10.10 version
```

For unnumbered peer below configuration is given in BGP unnumbered-mode.

```
(config)#router bgp 100
(config-router)#bgp unnumbered-mode
(config-router-unnum)#neighbor eth1 version 4
```

neighbor weight

Use this command to specify a weight value, per address-family, for all routes learned from a neighbor.

The route with the highest weight gets preference when the same prefix is learned from more than one peer. Unlike the local-preference attribute, the weight attribute is relevant only to the local router. The weights assigned using the `set weight` command override the weights assigned using this command.

Use this command in router mode to specify a weight value for all address families. Use this command in address family mode to specify a weight value per IPv4/IPv6/VPNv4/6PE address family,

When the weight is set for a peer group, all members of the peer group get the same weight. This command can also be used to assign a different weight to an individual peer-group member. When an individually-configured weight of a peer-group member is removed, its weight is reset to its peer group's weight.

Use the `no` parameter with this command to remove a weight assignment.

Command Syntax

```
neighbor (A.B.C.D|X:X::X:X|WORD) weight <0-65535>
no neighbor (A.B.C.D|X:X::X:X|WORD) weight
no neighbor (A.B.C.D|X:X::X:X|WORD) weight <0-65535>
```

For v4-unnumbered mode:

```
neighbor WORD weight <0-65535>
no neighbor WORD weight
no neighbor WORD weight <0-65535>
```

Parameters

A.B.C.D	Address of the BGP neighbor in an IPv4 format
X:X::X:X	Address of the BGP neighbor in an IPv6 format
WORD	Name of a BGP peer group created with the neighbor WORD peer-group command. When you specify this parameter, the command applies to all peers in the group.
<0-65535>	Weight value

Default

By default, neighbor weight value is 0

Command Mode

Router Address-Family mode and v4-unnumbered mode

Applicability

This command was introduced before OcNOS version 1.3.

Examples

```
#configure terminal
(config)#router bgp 12
(config-router)#address-family ipv4 unicast
(config-router-af)#neighbor 10.10.10.10 weight 60
```

BGP Commands

```
(config-router-af)#no neighbor 10.10.10.10 weight 60
```

For unnumbered peer, IPv4 unicast mode commands are configured under v4-unnumbered-mode.

```
(config)#router bgp 100
(config-router)#address-family ipv4 unicast
(config-router-af)#bgp v4-unnumbered-mode
(config-router-v4-unnum)#neighbor eth1 weight 44
```

neighbor WORD peer-group

Use this command to create a peer group.

Use the `no` parameter with this command to remove a peer group.

Command Syntax

```
neighbor WORD peer-group
no neighbor WORD peer-group
```

Parameters

WORD	Name of BGP peer group
------	------------------------

Default

No default value is specified

Command Mode

Router mode

Applicability

This command was introduced before OcNOS version 1.3.

Example

This example shows how to create a peer group named `group1`.

```
#configure terminal
(config)#router bgp 10
(config-router)#neighbor group1 peer-group
```

network

Use this command to specify the networks to be advertised by the BGP routing process. A unicast network address without a mask is accepted if it falls into the natural boundary of its class. A class-boundary mask is derived if the address matches its natural class-boundary.

Use the `backdoor` parameter to specify a backdoor route to a BGP border router that will provide better information about the network. For data to be advertised by BGP, its routing table must include a route to the specified network. This command specifies the networks to be advertised. The network command works if the network being advertised is known to the router.

The `backdoor` parameter enables a route to be the preferred route even if it has a greater distance. A network that is specified as a backdoor network is dynamically assigned an administrative distance of 200 ensuring that IGP learned routes are preferred. If a backdoor network is not sourced by the local router, the network is learned from the external routers. If the route is learned from eBGP for a backdoor network, the distance is set to 20 or 200.

Use the `no` form of this command to remove a network route entry.

Command Syntax

```
network A.B.C.D (backdoor|)
network A.B.C.D/M (backdoor|)
network A.B.C.D mask A.B.C.D (backdoor|)
network A.B.C.D mask A.B.C.D route-map WORD (backdoor|)
network A.B.C.D route-map WORD (backdoor|)
network A.B.C.D/M route-map WORD (backdoor|)
no network A.B.C.D
no network A.B.C.D/M
```

Parameters

A.B.C.D	IP prefix <network>, for example, 35.0.0.0
A.B.C.D/M	IP prefix <network>/<length>, for example., 35.0.0.0/8
backdoor	BGP backdoor route
routemap	Route map used to modify the attributes
WORD	Name of the route map
mask	Network mask, for example, 255.255.0.0
A.B.C.D	Network mask, e.g., 255.255.0.0

Default

No default value is specified

Command Mode

Router Address-family mode

Applicability

This command was introduced before OcNOS version 1.3.

Examples

The following example illustrates a Class-A address configured as a network route. The natural Class-A network prefix mask length of 8 is internally derived, that is, 2.0.0.0/8.

```
(config)#router bgp 1
(config-router)#address-family ipv4 unicast
(config-router-af)#network 2.0.0.0
```

network synchronization

Use this command to enable IGP synchronization for BGP static network routes.

Use this no parameter with this command to disable synchronization of BGP static routes.

Command Syntax

```
network synchronization
no network synchronization
```

Parameters

None

Default

By default, network synchronization is disabled

Command Mode

Address Family mode

Applicability

This command was introduced before OcNOS version 1.3.

Examples

The following example enables IGP synchronization of BGP static network routes in the router configuration mode.

```
#configure terminal
(config)#router bgp 11
(config-router)#address-family ipv4 unicast
(config-router-af)#network synchronization
```

The following example enables IGP synchronization of BGP static network routes in the IPv6 unicast address-family mode.

```
#configure terminal
(config)#router bgp 11
(config)#address-family ipv6 unicast
(config-router-af)#network synchronization
```

redistribute

Use this command to inject routes from one routing process into another. Redistribution is used by routing protocols to advertise routes that are learned by some other means, such as by another routing protocol or by static routes. Since all internal routes are dumped into BGP, careful filtering is applied to make sure that only routes to be advertised reach the internet, not everything. This command allows redistribution by injecting prefixes from one routing protocol into another routing protocol.

Use the `no` parameter with this command to disable this function.

Command Syntax

```
redistribute [connected|isis|kernel|ospf|rip|static]
redistribute [connected|isis|kernel|ospf|rip|static] route-map WORD
no redistribute [connected|isis|kernel|ospf|rip|static]
no redistribute [connected|isis|kernel|ospf|rip|static] route-map
no redistribute [connected|isis|kernel|ospf|rip|static] route-map WORD
```

Parameters

<code>connected</code>	Redistribute connected routes
<code>isis</code>	Redistribute connected ISO IS-IS routes
<code>kernel</code>	Redistribute connected kernel routes
<code>ospf</code>	Redistribute OSPFv2 routes
<code>rip</code>	Redistribute RIP routes
<code>static</code>	Redistribute static routes
<code>route-map</code>	Route map reference
<code>WORD</code>	Route map entries

Default

By default, `redistribute` is disabled

Command Mode

Address Family mode and Address Family-vrf mode

Applicability

This command was introduced before OcNOS version 1.3.

Examples

The following example shows the configuration of the route-map name `rmap1` and then the use of this map name in the `redistribute route-map` command.

```
#configure terminal
(config)#route-map rmap1 permit 1
(config-route-map)#match origin incomplete
(config-route-map)#set metric 100
(config-route-map)#exit
(config)#router bgp 12
```

```
(config-router)#address-family ipv4 unicast  
(config-router-af)#redistribute ospf route-map rmap1
```

```
(config)#router bgp 100  
(config-router)#address-family ipv4 vrf VRF_A  
(config-router-af)#redistribute static
```

```
(config)#router bgp 100  
(config-router)#address-family ipv6 vrf VRF_A  
(config-router-af)#redistribute static
```

restart bgp graceful

Use this command to enable a BGP-speaker router for graceful restart. This command stops the whole BGP process and makes OcnOS retain the BGP routes and mark them as stale. Receiving BGP speakers, retain and mark as stale all BGP routes received from the restarting speaker for all address families received in the Graceful Restart Capability exchange.

Command Syntax

```
restart bgp graceful
```

Parameters

None

Default

By default, bgp graceful is disabled

Command Mode

Privileged Exec mode

Applicability

This command was introduced before OcnOS version 1.3.

Examples

```
#restart bgp graceful
```

router bgp

Use this command to start a BGP process.

Use the `no` parameter with this command to disable an existing routing process.

Command Syntax

```
router bgp <1-4294967295>
no router bgp <1-4294967295>
```

Parameters

```
<1-4294967295>
```

Associate the routing process with this autonomous system number

Default

No default value is specified

Command Mode

Configure mode

Applicability

This command was introduced before OcNOS version 1.3.

Examples

```
#configure terminal
(config)#router bgp 12
(config-router)#
```

set large-community

Use this command to set the large community.

Command Syntax

```
set large-community XXX:YYYY:ZZZ
no set large-community XXX:YYYY:ZZZ
```

Parameters

XXX:YYYY:ZZZ Large community number

Default

By default send-community large is enabled for peer

Command Mode

Route-map mode

Applicability

This command was introduced in OcNOS version 6.1.0.

Examples

```
(config)#route-map R1 permit 10
(config-route-map)#set large-community 1111:2222:33333
(config-route-map)#
```

snmp restart bgp

Use this command to restart SNMP in Border Gateway Protocol (BGP)

Command Syntax

```
snmp restart bgp
```

Parameters

None

Default

No default value is specified

Command Mode

Configure mode

Applicability

This command was introduced before OcNOS version 1.3.

Examples

```
#configure terminal  
(config)#snmp restart bgp
```

synchronization

Use this command to enable IGP synchronization of Internal BGP (iBGP) learned routes with the Internal Gateway Protocol (IGP) system in the router configuration mode or in the address-family configuration mode.

Synchronization is used when a BGP router should not advertise routes learned from iBGP neighbors, unless those routes are also present in an IGP (for example, OSPF). Synchronization may be enabled when all the routers in an autonomous system do not speak BGP, and the autonomous system is a transit for other autonomous systems.

The `no synchronization` command is used when BGP router can advertise routes learned from its iBGP neighbors without waiting for the IGP reachability to be present.

Command Syntax

```
synchronization
no synchronization
```

Parameters

None

Default

No default value is specified

Command Mode

Address Family modes

Applicability

This command was introduced before OcNOS version 1.3.

Examples

The following example enables IGP synchronization of iBGP routes in Router mode.

```
#configure terminal
(config)#router bgp 11
(config-router)#address-family ipv4 unicast
(config-router-af)#synchronization
```

The following example enables IGP synchronization of iBGP routes in the IPv6-Unicast address family.

```
#configure terminal
(config)#router bgp 11
(config-router)#address-family ipv6 unicast
(config-router-af)#synchronization
```

timers bgp

Use this command to globally set or reset the keepalive and holdtime values for all the neighbors.

Use the `no` parameter with this command to reset timers to default value.

Command Syntax

```
timers bgp <0-65535> <0-65535>
no timers bgp
```

Parameters

<0-65535>	Frequency with which keepalive messages are sent to the neighbors
<0-65535>	Interval after which a neighbor is considered dead if keepalive messages are not received

Default

By default, keepalive timer value is 30 seconds

By default, holdtime value is 90 seconds

Command Mode

Router mode

Applicability

This command was introduced before OcNOS version 1.3.

Examples

```
#configure terminal
(config)#router bgp 10
(config-router)#timers bgp 40 120
```

v4-unnumbered-mode

Use this command to configure the unnumbered peer with all the neighbor configs applicable in IPv4 unicast address family.

Use the `exit` parameter with this command to leave IPv4 BGP unnumbered mode.

Command Syntax

```
bgp v4-unnumbered-mode
exit-v4-unnumbered-mode
```

Parameters

None

Applicability

No default value is specified

Command Mode

Address-family IPv4 Unicast Mode

Applicability

This command was introduced in OcNOS-OTN version 4.2.

Examples

```
#configure terminal
(config)#router bgp 100
(config-router)#address-family ipv4 unicast
(config-router-af)#bgp v4-unnumbered-mode
(config-router-v4-unnum)#
```

undebg bgp

Use this command to disable BGP debugging options.

Command Syntax

```
undebg bgp (all|bfd|dampening|events|filters|fsm|keepalives|mpls|nht|nsm|updates)
```

Parameters

<code>all</code>	Disable all debugging for BGP
<code>bfd</code>	Disable debugging for BGP Bidirectional Forwarding Detection (BFD)
<code>dampening</code>	Disable debugging for BGP dampening
<code>events</code>	Disable debugging for BGP events
<code>filters</code>	Disable debugging for BGP filters
<code>fsm</code>	Disable debugging for BGP Finite State Machine (FSM)
<code>keepalives</code>	Disable debugging for BGP keepalives
<code>mpls</code>	Disable debugging for BGP MPLS
<code>nht</code>	Disable debugging for BGP NHT messages
<code>nsm</code>	Disable debugging for NSM messages
<code>updates</code>	Disable debugging for BGP updates

Command Mode

Privileged Exec mode

Applicability

This command was introduced before OcNOS version 1.3.

Examples

```
#undebg bgp events
```

bgp unnumbered-mode

Use this command to enter the unnumbered mode in router BGP mode allowing configuration of neighbor specific parameters. In this mode we allow creation of unnumbered peer and allow all the neighbor configuration applicable in router BGP mode.

Use no form of this command to exit unnumbered-mode and return to previous mode.

Note: ECMP with BGP unnumbered and numbered together is not supported.

Command Syntax

```
bgp unnumbered-mode
exit-unnumbered-mode
```

Parameters

None

Command Mode

Router BGP mode

Applicability

This command was introduced in OcNOS-OTN version 4.2.

Examples

```
(config)#router bgp 100
(config-router)#bgp unnumbered-mode
(config-router-unnum)#
```

CHAPTER 2 BGP Additional Paths Commands

The chapter describes the BGP additional paths commands:

- [bgp additional-paths](#)
- [bgp additional-paths install](#)
- [neighbor additional-paths](#)
- [neighbor advertise additional-paths](#)

bgp additional-paths

Use this command to enable BGP additional paths.

Use the `no` parameter with this command to disable BGP add-path.

Command Syntax

```
bgp additional-paths (send|receive|send-receive|select (all | best<2-3>))
no bgp additional-paths (send|receive|send-receive|select (all | best))
```

Parameters

<code>send</code>	Send additional paths to neighbors
<code>receive</code>	Receive additional paths from neighbors
<code>send-receive</code>	Send and receive additional paths from neighbors
<code>select</code>	Selection criteria to pick the paths
<code>all</code>	Select all available paths
<code>best</code>	Select best N paths
<code><2-3></code>	Number of best paths in additional paths to be selected

Default

By default, BGP additional paths is disabled

Command Mode

Address Family mode

Applicability

This command was introduced before OcnOS version 1.3.

Examples

```
#configure terminal
(config)#router bgp 2
(config-router)#address-family ipv4 unicast
(config-router-af)#bgp additional-paths send
(config-router-af)#no bgp additional-paths send
```

bgp additional-paths install

Use this command to install the back-up path. BGP selects only one best path in the multiple next-hop network, the additional-path install (or) bgp prefix independent convergence enables BGP to select and install the back-up path.

Use the no parameter with this command to delete the installed back-up paths.

Command Syntax

```
bgp additional-paths install
no bgp additional-paths install
```

Parameters

None

Default

By default, additional-paths install is disabled.

Command Mode

```
address-family vpv4 unicast
address-family vpv6 unicast
address-family ipv6 labeled-unicast
```

Applicability

This command was introduced before OcNOS version 4.1 and new modes were introduced before OcNOS version 6.2.0

Examples

```
OCNOS(config)#router bgp 100
OCNOS(config-router)#address-family vpv4 unicast
OCNOS(config-router)#bgp additional-paths install
OCNOS(config-router-af)#exit-address-family

OCNOS(config-router)#address-family vpv6 unicast
OCNOS(config-router)#bgp additional-paths install
OCNOS(config-router-af)#exit-address-family

OCNOS(config-router)#address-family ipv6 labeled-unicast
OCNOS(config-router)#bgp additional-paths install
OCNOS(config-router-af)#exit-address-family
```

CLI "bgp additional-paths select best" requires to be configured.

neighbor additional-paths

Use this command to enable neighbour BGP add-path.

Use the `no` parameter with this command to disable neighbour BGP add-path.

Command Syntax

```
neighbor A.B.C.D additional-paths (send|receive|send-receive|disable)
no neighbor A.B.C.D additional-paths (send|receive|send-receive|disable)
```

Parameters

<code>send</code>	Send additional paths to neighbors
<code>receive</code>	Receive additional paths from neighbors
<code>send-receive</code>	Send and Receive additional paths from neighbors
<code>disable</code>	Disable additional paths

Default

By default additional-path is disabled

Command Mode

Address Family mode

Applicability

This command was introduced before OcNOS version 1.3.

Examples

```
#configure terminal
(config)#router bgp 2
(config-router)#address-family ipv4 unicast
(config-router-af)#neighbor 1.1.1.2 additional-paths send
(config-router-af)#no neighbor 1.1.1.2 additional-paths send
```

neighbor advertise additional-paths

Use this command to enable BGP add-path at neighbor level.

Use the `no` parameter with this command to disable BGP add-path at neighbor level.

Command Syntax

```
neighbor A.B.C.D advertise additional-paths (all|best <2-3>)
no neighbor A.B.C.D advertise additional-paths (all|best <2-3>)
```

Parameters

<code>all</code>	Select all available paths
<code>best</code>	Select best N paths
<code><2-3></code>	Number of best paths in additional paths to be selected

Default

By default, neighbor advertise additional path is disabled

Command Mode

Address Family mode

Applicability

This command was introduced before OcNOS version 1.3.

Examples

```
#configure terminal
(config)#router bgp 2
(config-router)#address-family ipv4 unicast
(config-router-af)#neighbor 1.1.1.2 advertise additional-paths all
(config-router-af)#no neighbor 1.1.1.2 advertise additional-paths all
```

CHAPTER 3 BGP Graceful Restart Commands

This chapter describes the BGP graceful restart commands.

- `bgp graceful-restart`
- `bgp g-shut`
- `bgp g-shut-capable`
- `bgp g-shut-local-preference`
- `bgp update-delay`
- `neighbor capability graceful-restart`
- `neighbor g-shut`
- `neighbor g-shut-timer`
- `neighbor restart-time`

bgp graceful-restart

Use this command to enable BGP graceful-restart capabilities. The restart-time parameter is used for setting the maximum time that a graceful-restart neighbor waits to come back up after a restart. This value is applied to all neighbors unless you explicitly override it by configuring the corresponding value on the neighbor. The stalepath-time parameter is used to set the maximum time to preserve stale paths from a gracefully restarted neighbor. All stalepaths, unless reinstated by the neighbor after a re-establishment, will be deleted at the expiration of this timer.

Use the `no` parameter with this command to restore the router to its default state.

Command Syntax

```
bgp graceful-restart
bgp graceful-restart graceful-reset
bgp graceful-restart restart-time <1-3600>
bgp graceful-restart stalepath-time <1-3600>
no bgp graceful-restart
no bgp graceful-restart graceful-reset
no bgp graceful-restart restart-time
no bgp graceful-restart stalepath-time
```

Parameters

<code>graceful-reset</code>	The BGP daemon is not restarted, so that any changes in network configurations that cause BGP reset do not affect packet forwarding.
<code>restart-time</code>	Maximum time needed for neighbors to restart. Default is 90 seconds.
<code><1-3600></code>	Delay value in seconds.
<code>stalepath-time</code>	Maximum time to retain stale paths from restarting neighbors. Default is 360 seconds.
<code><1-3600></code>	Delay value in seconds.

Default

By default, the maximum time for neighbors to restart is 90 seconds.

By default, the maximum time to retain stale paths from restarting neighbors is 360 seconds.

Command Mode

Router mode

Applicability

This command was introduced before OcNOS version 1.3.

Examples

```
#configure terminal
(config)#router bgp 10
(config-router)#bgp graceful-restart

#configure terminal
(config)#router bgp 10
```

```
(config-router)#no bgp graceful-restart
```

bgp g-shut

Use this command to gracefully shut down all BGP IPv4 sessions under this router. The BGP graceful shutdown feature reduces packet loss during maintenance activity.

Use the `no` parameter with this command to bring up all the sessions under this router after completion of maintenance activity using the `bgp g-shut` command.

Command Syntax

```
bgp g-shut
no bgp g-shut
```

Parameters

None

Default

By default, `bgp g-shut` is disabled

Command Mode

Router mode

Applicability

This command was introduced before OcNOS version 1.3.

Examples

```
#configure terminal
(config)#router bgp 100
(config-router)#bgp g-shut
```

```
#configure terminal
(config)#router bgp 100
(config-router)#no bgp g-shut
```

bgp g-shut-capable

Use this command to enable the graceful shutdown capability at the router level and make available the graceful-shutdown related commands at the router and BGP neighbor levels.

Use the `no` parameter with this command to disable the graceful shutdown capability on a router.

Note: The graceful shutdown capability cannot be disabled on a router that is in a graceful shutdown state until it comes out this state--after the graceful shutdown has been initiated and the impacted BGP sessions are up again.

Command Syntax

```
bgp g-shut-capable
no bgp g-shut-capable
```

Parameters

None

Default

By default, the graceful shutdown capability is disabled at the router level

Command Mode

Router mode

Applicability

This command was introduced before OcNOS version 1.3.

Examples

```
#configure terminal
(config)#router bgp 100
(config-router)#bgp g-shut-capable

#configure terminal
(config)#router bgp 100
(config-router)#no bgp g-shut-capable
```

bgp g-shut-local-preference

Use this command to sets the local preference of the router to use during graceful shutdown. The local preference value indicates the preferred path when there are multiple paths to the same destination in a single routing database. The path with a higher preference value is the preferred one. The preferred path is sent to all routers and access servers in the local autonomous system.

Use the `no` parameter with this command to revert to the default setting.

Command Syntax

```
bgp g-shut-local-preference <0-4294967295>
no bgp g-shut-local-preference
```

Parameters

<0-4294967295> Local preference value

Default

By default, the local preference value is set to 0

Command Mode

Router mode

Applicability

This command was introduced before OcNOS version 1.3.

Examples

```
#configure terminal
(config)#router bgp 100
(config-router)#bgp g-shut-local-preference 22
```

bgp update-delay

Use this command to set the update delay for a graceful-restart capable router. The update-delay value is the maximum time a graceful-restart capable router, which is restarting, will defer route-selection and advertisements to all its graceful-restart capable neighbors. This maximum time starts from the instance the first neighbor attains established state after restart. The restarting router prematurely terminates this timer when end-of-RIB markers are received from all its graceful-restart capable neighbors.

Use the `no` form of this command to set to the update delay to its default value.

Command Syntax

```
bgp update-delay <1-3600>
no bgp update-delay
no bgp update-delay <1-3600>
```

Parameters

`<1-3600>` Delay interval in seconds

Default

By default, update-delay value is 120 seconds

Command Mode

Router mode

Applicability

This command was introduced before OcnOS version 1.3.

Example

```
#configure terminal
(config)#router bgp 10
(config-router)#bgp update-delay 345
```

neighbor capability graceful-restart

Use this command to advertise the graceful restart capability to its neighbor. This configuration indicates that the BGP speaker has the ability to preserve its forwarding state for the address family when BGP restarts.

You must first specify a neighbor's `remote-as` identification number assigned by the neighbor router.

Note: The graceful restart capability is advertised only when the graceful restart capability has been enabled using the [bgp graceful-restart](#) command.

Use the `no` parameter with this command to not advertise the graceful restart capability to its neighbor.

Command Syntax

```
neighbor (A.B.C.D|X:X::X:X|WORD) capability graceful-restart
no neighbor (A.B.C.D|X:X::X:X|WORD) capability graceful-restart
```

Parameters

A.B.C.D	Address of the BGP neighbor in an IPv4 format
X:X::X:X	Address of the BGP neighbor in an IPv6 format
WORD	Name of a BGP peer group created with the neighbor WORD peer-group command. When you specify this parameter, the command applies to all peers in the group.

Default

By default, the graceful-restart is disabled

Command Mode

Address family mode - Applicable for ipv4, ipv6 and vpnv4

Applicability

This command was introduced before OcNOS version 1.3.

Examples

```
#configure terminal
(config)#router bgp 10
(config-router)#address-family ipv4 unicast
(config-router-af)#neighbor 10.10.10.50 capability graceful-restart

(config-router)#address-family vpnv4 unicast
(config-router-af)#neighbor 2.2.2.2 activate
(config-router-af)#neighbor 2.2.2.2 capability graceful-restart
(config-router-af)#neighbor 3.3.3.3 activate
(config-router-af)#neighbor 3.3.3.3 capability graceful-restart
(config-router-af)#exit-address-family
```

neighbor g-shut

Use this command to start a graceful shutdown for the BGP session of the specified BGP neighbor. The BGP session for this neighbor is shut down after the graceful shutdown timer expires.

If there is no alternate path available for traffic to flow prior the actual shutdown of the BGP session, this path is made available for 60 seconds or for configured time after which the path is no longer available and traffic is dropped.

Use the `no` parameter with this command to bring up the session again for the specified BGP neighbor whose BGP session had been shut down using the `neighbor g-shut` command.

Note: The graceful shutdown capability is not supported on iBGP sessions.

Command Syntax

```
neighbor (A.B.C.D|X:X::X:X|WORD) g-shut
no neighbor (A.B.C.D|X:X::X:X|WORD) g-shut
```

Parameters

A.B.C.D	Neighbor IPv4 address
X:X::X:X	Neighbor IPv6 address
WORD	Neighbor tag

Default

By default, `neighbor g-shut` is disabled

Command Mode

Router mode

Applicability

This command was introduced before OcnOS version 1.3.

Examples

```
#configure terminal
(config)#router bgp 100
(config-router)#neighbor 1.1.1.2 g-shut

#configure terminal
(config)#router bgp 100
(config-router)#no neighbor 1.1.1.2 g-shut
```

neighbor g-shut-timer

Use this command to configure the value of the graceful shutdown timer. After the timer expires, the BGP session initiated for graceful shutdown is shut down.

Use the `no` parameter with this command to revert to the default setting.

Command Syntax

```
neighbor (A.B.C.D|X:X::X:X|WORD) g-shut-timer <10-65535>
no neighbor (A.B.C.D|X:X::X:X|WORD) g-shut-timer <10-65535>
```

Parameters

A.B.C.D	Neighbor IPv4 address
X:X::X:X	Neighbor IPv6 address
WORD	Neighbor tag
<10-65535>	Graceful shutdown timer in seconds

Default

By default, the timer value is set to 60 seconds

Command Mode

Router mode

Applicability

This command was introduced before OcNOS version 1.3.

Examples

```
#configure terminal
(config)#router bgp 100
(config-router)#neighbor 1.1.1.2 g-shut-timer 120
```

neighbor restart-time

Use this command to set a different restart-time than the global restart-time configured using the [bgp graceful-restart](#) command.

Use the `no` parameter with this command to restore the router to its default state.

Command Syntax

```
neighbor (A.B.C.D|X:X::X:X|WORD) restart-time <1-3600>
no neighbor (A.B.C.D|X:X::X:X|WORD) restart-time <1-3600>
```

Parameters

A.B.C.D	Address of the BGP neighbor in an IPv4 format
X:X::X:X	Address of the BGP neighbor in an IPv6 format
WORD	Name of a BGP peer group created with the neighbor WORD peer-group command. When you specify this parameter, the command applies to all peers in the group.
<1-3600>	The maximum time that a graceful-restart neighbor waits to come back up after a restart. Make sure that this value does not exceed the stalepath-time specified in router mode.

Default

By default, restart time is 90 seconds

Command Mode

Router mode

Applicability

This command was introduced before OcnOS version 1.3.

Example

```
#configure terminal
(config)#router bgp 10
(config-router)#neighbor 3.3.3.3 restart-time 45
```

CHAPTER 4 BGP Labeled Unicast Commands

This chapter describes the BGP labeled unicast commands.

- `address-family labeled-unicast`
- `allocate-label`
- `clear ip bgp A.B.C.D ipv4 labeled-unicast`
- `clear ip bgp peer-group WORD ipv4 labeled-unicast`
- `clear ip bgp * ipv4 labeled-unicast`

address-family labeled-unicast

Use the address family command to enter the IPv4 or VPNv4 address family mode allowing configuration of address-family specific parameters. To leave address family mode and return to configure mode, give the [exit-address-family](#) command.

This command configures the routing exchange between Provider Edge (PE) and Customer Edge (CE) devices. The BGP sessions between PE routers can carry different types of routes (VPN-IPv4 and IPv4 routes). Address families are used to control the type of BGP session.

Use the `no` parameter with this command to disable the address-family configurations.

As in OcNOS, IPv4 Unicast and IPv4 Labeled-Unicast share the same BGP RIB [AFI=1][SAFI=1].

Paths learned from IPv4 unicast capable peer and routes learned from IPv4 labeled-unicast capable peer both the paths will be imported to IPv4 Unicast RIB. For a BGP route A.B.C.D, paths learned via IPv4 Labeled-Unicast are preferred over paths learned via IPv4 Unicast.

When max-paths ECMP is enabled for IPv4 Unicast address-family routes:

For a BGP route having the paths learned via IPv4 Labeled-Unicast and also via IPv4 Unicast OcNOS will not select these paths as multipath candidates as load-balancing the traffic to ip path and mpls path is not achievable in OcNOS and paths from LU are preferred and are marked best path.

Command Syntax

```
address-family ipv4 labeled-unicast
address-family ipv6 labeled-unicast
```

Parameters

```
ipv4          IPv4 address family
  labeled-unicast
```

Enter IPv4 labeled-unicast address-family mode to advertise labeled unicast routes. When a [neighbor activate](#) command is given in this mode, the BGP speaker advertises the BGP-LU capability.

```
ipv6          IPv6 address family
  labeled-unicast
```

Enter IPv6 labeled-unicast address-family mode to:

Activate an IPv4 neighbor to exchange labeled routes data among ISP PE devices. When a IPv4 [neighbor activate](#) command is given in this mode, the device becomes 6PE capable.

OR:

Activate an IPv6 neighbor to advertise labeled unicast routes. When a IPv6 [neighbor activate](#) command is given in this mode, the BGP speaker advertises the BGP-LU capability.

Default

Not applicable

Command Mode

Router mode

Applicability

This command was introduced before OcNOS version 1.3 and updated in OcNOS version 3.0.

Example

```
(config)#router bgp 100
(config-router)#address-family ipv4 labeled unicast
(config-router-af)#neighbor 172.4.5.52 activate
(config-router-af)#exit-address-family
```

allocate-label

Use this command to allocate MPLS labels to all/route-map permitted IPv4 prefixes present in the BGP RIB. This command enables the label allocation to IPv4 prefixes, where labeled unicast (LU) routes can be exchanged with IPv4 Peers having BGP labeled-unicast capability. This command allocates labels for all IPv4 unicast prefixes (afi:1, safi:1) and IPv4 labeled-unicast prefixes (afi:1, safi:4).

Once configured, BGP will allocate labels to IPv4 unicast prefixes after the expiry of current BGP RIB scan time (default: 60 seconds).

Use the `no` form of this command to release the labels and disable BGP from allocating label to IPv4 prefixes.

Command Syntax

```
allocate-label (all|route-map WORD)
no allocate-label (all|route-map)
```

Parameters

<code>all</code>	All the advertised routes
<code>route-map</code>	Only those routes that match route-map
<code>WORD</code>	Route-map name

Default

Not applicable

Command Mode

Router mode

Applicability

This command was introduced before OcnOS version 1.3 and updated in OcnOS version 3.0.

Example

To allocate an MPLS label to IPv4 unicast prefix 1.1.1.1/32

```
(config)#router bgp 100
(config-router)#neighbor 11.0.0.2 remote-as 100
(config-router)#allocate-label all
(config-router)#address-family ipv4 unicast
(config-router-af)#network 1.1.1.1/32
(config-router-af)#exit-address-family
(config-router)#address-family ipv4 labeled-unicast
(config-router-af)#network 11.0.0.2 activate
(config-router-af)#exit-address-family

(config-router)#no allocate-label all
(config-router)#allocate-label route-map bgp
(config-router)#no allocate-label route-map
(config-router)#
```

clear ip bgp A.B.C.D ipv4 labeled-unicast

Use this command to soft reset an IPv4 Labeled-unicast BGP neighbor.

Command Syntax

```
clear ip bgp A.B.C.D ipv4 labeled-unicast soft
clear ip bgp A.B.C.D ipv4 labeled-unicast soft in
clear ip bgp A.B.C.D ipv4 labeled-unicast soft out
```

Parameters

A.B.C.D	BGP neighbor address
soft	Soft clear both incoming and outgoing routes
in	Soft reconfig inbound update
out	Soft reconfig outbound update

Command Mode

Privileged Exec mode

Applicability

This command was introduced in OcNOS version 3.0.

Examples

```
#clear ip bgp A.B.C.D ipv4 labeled-unicast soft in
```

clear ip bgp peer-group WORD ipv4 labeled-unicast

Use this command to soft reset an peer-group of ipv4 labeled-unicast peer members.

Command Syntax

```
clear ip bgp peer-group WORD ipv4 labeled-unicast soft
clear ip bgp peer-group WORD ipv4 labeled-unicast soft in
clear ip bgp peer-group WORD ipv4 labeled-unicast soft out
```

Parameters

WORD	Peer-group name
soft	Soft clear both incoming and outgoing routes
in	Soft reconfig inbound update
out	Soft reconfig outbound update

Command Mode

Privileged Exec mode

Applicability

This command was introduced in OcNOS version 3.0.

Examples

```
#clear ip bgp peer-group LU_GROUP ipv4 labeled-unicast soft in
```

clear ip bgp * ipv4 labeled-unicast

Use this command to soft reset all IPv4 Labeled-unicast BGP neighbors.

Command Syntax

```
clear ip bgp * ipv4 labeled-unicast soft
clear ip bgp * ipv4 labeled-unicast soft in
clear ip bgp * ipv4 labeled-unicast soft out
```

Parameters

soft	Soft clear both incoming and outgoing routes
in	Soft reconfig inbound update
out	Soft reconfig outbound update

Command Mode

Privileged Exec mode

Applicability

This command was introduced in OcNOS version 3.0.

Examples

```
#clear ip bgp * ipv4 labeled-unicast soft in
```

CHAPTER 5 BGP4+ Commands

This chapter describes the BGP4+ configuration commands.

- `address-family ipv6` (see [address-family](#) in Chapter 1, *BGP Commands*)
- `aggregate-address X:X::X:X/M`
- `bgp g-shut` (see [bgp g-shut](#) in Chapter 1, *BGP Commands*)
- `clear bgp * ipv6`
- `clear bgp ipv6 (A.B.C.D|X:X::X:X)`
- `clear bgp ipv6 <1-4294967295>`
- `clear bgp ipv6 external`
- `clear bgp ipv6 peer-group`
- `clear bgp ipv6 unicast flap-statistics`
- `clear bgp ipv6 unicast flap-statistics`
- `clear ipv6 bgp * vrf`
- `clear ipv6 bgp X:X::X:X vrf`
- `clear ip bgp * (description LINE|)*`
- `clear ip bgp (A.B.C.D|X:X::X:X|WORD) (description LINE|)`
- `clear ip bgp all vrf (VRFNAME|all|default) (description LINE|)`
- `clear ip bgp ipv6 unicast table-map`
- `bgp table-map`
- `neighbor activate` (see [neighbor activate](#) in Chapter 1, *BGP Commands*)
- `neighbor attribute-unchanged` (see [neighbor attribute-unchanged](#) in Chapter 1, *BGP Commands*)
- `neighbor capability dynamic` (see [neighbor capability dynamic](#) in Chapter 1, *BGP Commands*)
- `neighbor capability route-refresh` (see [neighbor collide-established](#) in Chapter 1, *BGP Commands*)
- `neighbor de-activate` (see [neighbor de-activate](#) in Chapter 1, *BGP Commands*)
- `neighbor default-originate` (see [neighbor de-activate](#) in Chapter 1, *BGP Commands*)
- `neighbor distribute-list` (see [neighbor distribute-list](#) in Chapter 1, *BGP Commands*)
- `neighbor filter-list` (see [neighbor filter-list](#) in Chapter 1, *BGP Commands*)
- `neighbor maximum-prefix` (see [neighbor maximum-prefix](#) in Chapter 1, *BGP Commands*)
- `neighbor next-hop-self` (see [neighbor next-hop-self](#) in Chapter 1, *BGP Commands*)
- `neighbor peer-group` (see [neighbor peer-group](#) in Chapter 1, *BGP Commands*)
- `neighbor prefix-list` (see [neighbor prefix-list](#) in Chapter 1, *BGP Commands*)
- `neighbor remove-private-AS` (see [neighbor remove-private-AS](#) in Chapter 1, *BGP Commands*)
- `neighbor route-map` (see [neighbor route-map](#) in Chapter 1, *BGP Commands*)
- `neighbor route-reflector-client` (see [neighbor route-reflector-client](#) in Chapter 1, *BGP Commands*)
- `neighbor send-community` (see [neighbor send-community](#) in Chapter 1, *BGP Commands*)
- `neighbor unsuppress-map` (see [neighbor unsuppress-map](#) in Chapter 1, *BGP Commands*)
- `network X:X::X:X`

- redistribute (see [redistribute](#) in [Chapter 1, BGP Commands](#))

aggregate-address X:X::X:X/M

Use this command to configure BGP aggregate entries.

Aggregates are used to minimize the size of routing tables. Aggregation combines the characteristics of several different routes and advertises a single route. This command creates an aggregate entry in the BGP routing table if any more-specific BGP routes are available in the specified range. Using the `summary-only` parameter advertises the prefix only, suppressing more-specific routes to neighbors.

The `as-set` parameter creates an aggregate entry advertising the path for this route, consisting of all elements contained in all paths being summarized. Use the `as-set` parameter to reduce the size of path information by listing the AS number only once, even if it was included in multiple paths that were aggregated. The `as-set` parameter is useful when aggregation of information results in an incomplete path information.

Use the `no` parameter with this command to disable this function.

Command Syntax

```
aggregate-address X:X::X:X/M
aggregate-address X:X::X:X/M as-set
aggregate-address X:X::X:X/M as-set summary-only
aggregate-address X:X::X:X/M summary-only
aggregate-address X:X::X:X/M summary-only as-set
no aggregate-address X:X::X:X/M
no aggregate-address X:X::X:X/M as-set
no aggregate-address X:X::X:X/M as-set summary-only
no aggregate-address X:X::X:X/M summary-only
no aggregate-address X:X::X:X/M summary-only as-set
```

Parameters

<code>X:X::X:X/M</code>	Aggregate IPv6 prefix
<code>as-set</code>	Generate AS set path information
<code>summary-only</code>	Filter more specific routes from updates

Command Mode

Address Family mode

Default

By default, aggregate address is disabled

Applicability

This command was introduced before OcNOS version 1.3.

Examples

```
#configure terminal
(config)#router bgp 100
(config-router)#neighbor 2.2.2.2 remote-as 100
(config-router)#neighbor 3.3.3.3 remote-as 200
```

```
(config-router)#address-family ipv6  
(config-router-af)#aggregate-address 3ffe::/32 as-set summary-only
```

clear bgp * ipv6

Use this command to reset the BGP IPv6 connection for all peers.

Note: The `soft in` or `in` and `soft out` or `out` in the BGP commands performs the same functionality. User can use any of the commands to soft reset.

Command Syntax

```
clear bgp ipv6 *
clear bgp ipv6 * in
clear bgp ipv6 * in prefix-filter
clear bgp ipv6 * out
clear bgp ipv6 * soft
clear bgp ipv6 * soft in
clear bgp ipv6 * soft out
clear ip bgp * ipv6 unicast in
clear ip bgp * ipv6 unicast out
clear ip bgp * ipv6 unicast soft
clear ip bgp * ipv6 unicast soft in
clear ip bgp * ipv6 unicast soft out
```

Parameters

<code>in</code>	Clear incoming advertised routes.
<code>prefix-filter</code>	Push out prefix-list ORF and do inbound soft reconfig.
<code>out</code>	Clear outgoing advertised routes.
<code>soft</code>	Clear both incoming and outgoing routes.
<code>in</code>	Soft reconfig inbound update.
<code>out</code>	Soft reconfig outbound update.
<code>unicast</code>	Unicast prefixes
<code>in</code>	Clear incoming advertised routes.
<code>out</code>	Soft reconfig outbound update
<code>soft</code>	Clear both incoming and outgoing routes
<code>in</code>	Soft reconfig inbound update
<code>out</code>	Clear outgoing advertised routes

Command Mode

Privileged Exec mode

Applicability

This command was introduced before OcNOS version 1.3.

Examples

```
#clear ip bgp * ipv6 unicast soft out
```

clear bgp ipv6 (A.B.C.D|X:X::X:X)

Use this command to reset the BGP neighbor addresses (IPv4 or IPv6) for IPv6 peers.

Note: The `soft in` or `in` and `soft out` or `out` in the BGP commands performs the same functionality. User can use any of the commands to soft reset.

Command Syntax

```
clear bgp ipv6 (A.B.C.D|X:X::X:X)
clear bgp ipv6 (A.B.C.D|X:X::X:X) in
clear bgp ipv6 (A.B.C.D|X:X::X:X) in prefix-filter
clear bgp ipv6 (A.B.C.D|X:X::X:X) out
clear bgp ipv6 (A.B.C.D|X:X::X:X) soft
clear bgp ipv6 (A.B.C.D|X:X::X:X) soft in
clear bgp ipv6 (A.B.C.D|X:X::X:X) soft out
```

Parameters

<code>in</code>	Clear incoming advertised routes
<code>prefix-filter</code>	Push out prefix-list ORF and do inbound soft reconfig
<code>out</code>	Clear outgoing advertised routes
<code>soft</code>	Clear both incoming and outgoing routes
<code>in</code>	Soft reconfig inbound update
<code>out</code>	Soft reconfig outbound update

Command Mode

Privileged Exec mode

Applicability

This command was introduced before OcNOS version 1.3.

Example

```
#clear bgp ipv6 10.5.2.7
```

clear bgp ipv6 <1-4294967295>

Use this command to reset the BGP connection with a specified AS (Autonomous System) number for IPv6 peers.

Command Syntax

```
clear bgp ipv6 <1-4294967295>
clear bgp ipv6 <1-4294967295> in
clear bgp ipv6 <1-4294967295> in prefix-filter
clear bgp ipv6 <1-4294967295> out
clear bgp ipv6 <1-4294967295> soft
clear bgp ipv6 <1-4294967295> soft in
clear bgp ipv6 <1-4294967295> soft out
```

Parameters

in	Clear incoming advertised routes.
prefix-filter	Push out prefix-list ORF and do inbound soft reconfig.
out	Clear outgoing advertised routes.
soft	Clear both incoming and outgoing routes.
in	Soft reconfig inbound update.
out	Soft reconfig outbound update.

Command Mode

Privileged Exec mode

Applicability

This command was introduced before OcnOS version 1.3.

Example

```
#clear bgp ipv6 12345
```

clear bgp ipv6 external

Use this command to reset the BGP connection for all external IPv6 peers or for a specified external IPv6 peer.

Command Syntax

```
clear bgp ipv6 external
clear bgp ipv6 external in prefix-filter
clear bgp ipv6 external soft
clear bgp ipv6 external soft in
clear bgp ipv6 external soft out
clear bgp ipv6 external WORD in
clear bgp ipv6 external WORD out
```

Parameters

in	Clear incoming advertised routes
prefix-filter	Push out prefix-list ORF and do inbound soft reconfig
soft	Clear both incoming and outgoing routes
in	Soft reconfig inbound update
out	Soft reconfig outbound update
WORD	Name of external IPv6 peer
in	Soft reconfig inbound update
out	Soft reconfig outbound update

Command Mode

Privileged Exec mode

Applicability

This command was introduced before OcnOS version 1.3.

Example

```
#clear bgp ipv6 external soft in
```

clear bgp ipv6 peer-group

Use this command to reset the BGP connection for all members of a peer group.

Note: The `soft in` or `in` and `soft out` or `out` in the BGP commands performs the same functionality. User can use any of the commands to soft reset.

Command Syntax

```
clear bgp ipv6 peer-group WORD
clear bgp ipv6 peer-group WORD in
clear bgp ipv6 peer-group WORD in prefix-filter
clear bgp ipv6 peer-group WORD out
clear bgp ipv6 peer-group WORD soft
clear bgp ipv6 peer-group WORD soft in
clear bgp ipv6 peer-group WORD soft out
```

Parameters

<code>in</code>	Clear incoming advertised routes
<code>prefix-filter</code>	Push out prefix-list ORF and do inbound soft reconfig
<code>out</code>	Clear outgoing advertised routes
<code>soft</code>	Clear both incoming and outgoing routes
<code>in</code>	Soft reconfig inbound update
<code>out</code>	Soft reconfig outbound update
<code>WORD</code>	BGP peer-group name

Command Mode

Privileged Exec mode

Applicability

This command was introduced before OcNOS version 1.3.

Examples

```
#clear ip bgp peer-group P1
```

clear bgp ipv6 unicast flap-statistics

Use this command to reset IPv6 BGP route flap statistics.

Command Syntax

```
clear bgp ipv6 unicast flap-statistics
clear bgp ipv6 unicast flap-statistics X:X::X:X
clear bgp ipv6 unicast flap-statistics X:X::X:X/M
clear ip bgp ipv6 unicast flap-statistics
clear ip bgp ipv6 unicast flap-statistics X:X::X:X
clear ip bgp ipv6 unicast flap-statistics X:X::X:X/M
```

Parameters

X:X::X:X	IP prefix (network) for example, 35.0.0.0
X:X::X:X/M	IP prefix (network and length) for example, 35.0.0.0/8

Command Mode

Privileged Exec mode

Applicability

This command was introduced before OcnOS version 1.3.

Examples

```
#clear ip bgp ipv6 unicast flap-statistics 1:2::3:4/7
```

clear ipv6 bgp * vrf

Use this command to reset an IPv6 BGP connection for all virtual routing forwarding addresses.

Note: The `soft in` or `in` and `soft out` or `out` in the BGP commands performs the same functionality. User can use any of the commands to soft reset.

Command Syntax

```
clear ipv6 bgp * vrf WORD
clear ipv6 bgp * vrf WORD in
clear ipv6 bgp * vrf WORD out
clear ipv6 bgp * vrf WORD soft
clear ipv6 bgp * vrf WORD soft in
clear ipv6 bgp * vrf WORD soft out
```

Parameters

<code>in</code>	Clear incoming advertised routes
<code>out</code>	Clear outgoing advertised routes
<code>soft</code>	Clear both incoming and outgoing routes
<code>in</code>	Soft reconfig inbound update
<code>out</code>	Soft reconfig outbound update
<code>WORD</code>	BGP peer-group name

Command Mode

Privileged Exec mode

Applicability

This command was introduced before OcNOS version 1.3.

Examples

```
#clear ipv6 bgp * vrf BGPpeer7
```

clear ipv6 bgp X:X::X:X vrf

Use this command to reset the specified VPNv6 Routing/Forwarding (VRF) instance for BGP connections. If the neighbor address is specified with this command, it clears the specified connection. If no address is specified, this command clears all the BGP routes.

Note: The `soft in` or `in` and `soft out` or `out` in the BGP commands performs the same functionality. User can use any of the commands to soft reset.

Command Syntax

```
clear ipv6 bgp (X:X::X:X) vrf WORD
clear ipv6 bgp X:X::X:X vrf WORD in
clear ipv6 bgp X:X::X:X vrf WORD out
clear ipv6 bgp X:X::X:X vrf WORD soft in
clear ipv6 bgp X:X::X:X vrf WORD soft out
```

Parameters

vrf	Specify a VPN routing/forwarding instance for IPv6
WORD	VPN routing/forwarding instance name
in	Clear incoming advertised routes
out	Clear outgoing advertised routes
soft	Clear both incoming and outgoing routes
in	Soft reconfig inbound update
out	Soft reconfig outbound update

Command Mode

Privileged Exec mode

Applicability

This command was introduced before OcNOS version 1.3.

Examples

```
#clear ipv6 bgp vrf 10:10::0:12 vrf vrfname
```

clear ip bpg ipv6 unicast table-map

Use this command to apply the modified table map or route map rules to the BGP routes in the existing IP routing table.

Command Syntax

```
clear ip bpg ipv6 unicast table-map (vrf (VRFNAME|all|default))
```

Parameters

vrf	Select a VPN Routing/Forwarding Instance.
VRFNAME	Specify a VPN Routing/Forwarding instance name.
all	Select all VRFs.
default	Select default VRFs.

Command Mode

Privileged Exec mode

Applicability

This command was introduced before OcnOS version 1.3.

Examples

```
#clear ip bpg ipv6 unicast table-map vrf all
```

network X:X::X:X

Use this command to specify the networks to be advertised by the BGP routing process. A unicast network address without a mask is accepted if it falls into the natural boundary of its class. A class-boundary mask is derived if the address matches its natural class-boundary.

Use the `backdoor` parameter to specify a backdoor route to a BGP border router that will provide better information about the network. For data to be advertised by BGP, its routing table must include a route to the specified network. This command specifies the networks to be advertised. The network command works if the network being advertised is known to the router.

The `backdoor` parameter enables a route to be the preferred route even if it has a greater distance. A network that is specified as a backdoor network is dynamically assigned an administrative distance of 200 ensuring that IGP learned routes are preferred. If a backdoor network is not sourced by the local router, the network is learned from the external routers. If the route is learned from eBGP for a backdoor network, the distance is set to 20 or 200.

Use the `no` parameter with this command to remove an entry.

Command Syntax

```
network X:X::X:X/M
network X:X::X:X/M backdoor
network X:X::X:X/M route-map WORD (backdoor|)
no network X:X::X:X/M
no network X:X::X:X/M backdoor
no network X:X::X:X/M route-map WORD (backdoor|)
```

Parameters

X:X::X:X	IPv6 prefix <network>, for example, 3ffe::
backdoor	Specify a BGP backdoor route
WORD	Name of the route map

Default

No default value is specified

Command Mode

IPv6 Address Family mode, IPv6 VRF Address Family mode

Applicability

This command was introduced before OcnOS version 1.3.

Examples

```
(config)#router bgp 10
(config-router)#network 172.26.0.0/16
```

If Router1 receives updates from 172.10.0.0 via two routing protocols RIP (distance 120) and eBGP (distance 20), router1 chooses the shorter route. Use the `backdoor` parameter to allow Router1 to learn about 172.10.0.0 via RIP.

```
(config)#router rip
(config)#network 172.10.0.0
(config)#router bgp 65001
```

```
(config)#neighbor 5ffe:507::2 remote-as 65001
(config-af)#address-family ipv6 unicast
(config-af)#network 8ffe:507::/64
(config-af)#neighbor 5ffe:507::2 activate
(config-af)#exit-address-family
```

CHAPTER 6 BGP Virtual Private Network Commands

This chapter describes the BGP Virtual Private Network (VPN) configuration commands.

- [address-family](#) (see [address-family](#) in [Chapter 1, BGP Commands](#))
- [bgp inbound-route-filter](#)
- [clear bgp * I2vpn vpls](#)
- [clear ip bgp * vpv4](#)
- [clear bgp <1-4294967295> I2vpn vpls](#)
- [clear ip bgp <1-4294967295> vpv4](#)
- [clear bgp A.B.C.D I2vpn vpls](#)
- [clear ip bgp A.B.C.D vpv4](#)
- [debug bgp mpls](#)
- [exit-address-family](#) (see [exit-address-family](#) in [Chapter 1, BGP Commands](#))
- [export map](#)
- [import map](#)
- [ip vrf](#)
- [neighbor activate](#) (see [neighbor activate](#) in [Chapter 1, BGP Commands](#))
- [neighbor allow-ebgp-vpn](#)
- [neighbor allowas-in](#) (see [neighbor allowas-in](#) in [Chapter 1, BGP Commands](#))
- [neighbor as-origination-interval](#) (see [neighbor as-origination-interval](#) in [Chapter 1, BGP Commands](#))
- [neighbor as-override](#)
- [neighbor description](#) (see [neighbor description](#) in [Chapter 1, BGP Commands](#))
- [neighbor remote-as](#) (see [neighbor remote-as](#) in [Chapter 1, BGP Commands](#))
- [neighbor send-community](#) (see [neighbor send-community](#) in [Chapter 1, BGP Commands](#))
- [neighbor shutdown](#) (see [neighbor shutdown](#) in [Chapter 1, BGP Commands](#))
- [neighbor soo](#)
- [redistribute](#) (see [redistribute](#) in [Chapter 1, BGP Commands](#))
- [rd \(route distinguisher\)](#)
- [route-target](#)

bgp inbound-route-filter

Use this command to control the filtering of received VPN routes with route-target extended community attributes. The inbound route filtering is applicable for both `bgp inbound-route-filter` and `route-target import` commands.

When a router is configured as VPNv4/EVPN Route-Reflector, it exchanges VRF routing information with a route distinguisher and route-target extended communities.

By default, OcnOS discards the received routes that does not match the local IP/MAC VRF's route-target import value. We can use command `no bgp inbound-route-filter` to override this behavior.

When the local box is acting as a VPNv4/EVPN route-reflector and not in the forwarding path, it may not be configured with an IP/MAC VRF terminations. In such case, `no bgp inbound-route-filter` is required to be configured to keep all the routes into RD (route-distinguisher) table.

Command Syntax

```
bgp inbound-route-filter
no bgp inbound-route-filter
```

Parameter

None

Default

By default, OcnOS does not import routing information that does not match the local IP or MAC VRF's route-target import value.

Command Mode

Router mode

Applicability

This command was introduced before OcnOS version 1.3. Inbound-route-filter support for L2VPN EVPN introduced from OcnOS Version 6.3.0.

Examples

```
#configure terminal
(config)#router bgp 100
(config-router)#bgp inbound-route-filter
```

clear bgp * l2vpn vpls

Use this command to reset the session with all neighbors for VPLS address family

Command Syntax

```
clear bgp * l2vpn vpls
```

Parameters

None

Command Mode

Privileged Exec Modes

Applicability

This command was introduced before OcNOS version 1.3.

Example

```
#clear bgp * l2vpn vpls
```

clear ip bgp * vpnv4

Use this command to reset a VPNv4 BGP connection for all peers. This command clears the BGP connection and dynamically resets the outbound routing table. This frees up additional memory required for storing updates to generate new updates.

Note: The `soft in` or `in` and `soft out` or `out` in the BGP commands performs the same functionality. User can use any of the commands to soft reset.

Command Syntax

```
clear ip bgp * vpnv4 unicast in
clear ip bgp * vpnv4 unicast out
clear ip bgp * vpnv4 unicast soft
clear ip bgp * vpnv4 unicast soft in
clear ip bgp * vpnv4 unicast soft out
```

Parameters

<code>in</code>	Clear incoming advertised routes
<code>out</code>	Clear outgoing advertised routes
<code>soft</code>	Clear both incoming and outgoing routes
<code>in</code>	Soft reconfig inbound update
<code>out</code>	Soft reconfig outbound update

Command Mode

Privileged Exec mode

Applicability

This command was introduced before OcnOS version 1.3.

Examples

```
#clear ip bgp *
#clear ip bgp * vpnv4 unicast out
```

clear bgp <1-4294967295> l2vpn vpls

Use this command to reset the session for the neighbors with a specific ASN number for L2VPN VPLS.

Command Syntax

```
clear bgp <1-4294967295> l2vpn vpls
```

Parameters

<1-4294967295> Autonomous System number of the BGP neighbor.

Command Mode

Privileged Exec Modes

Applicability

This command was introduced before OcnOS version 1.3.

Example

```
#clear bgp 100 l2vpn vpls
```

clear ip bgp <1-4294967295> vpnv4

Use this command to reset a BGP connection for all VPN peers in a specified Autonomous System.

Note: The `soft in` or `in` and `soft out` or `out` in the BGP commands performs the same functionality. User can use any of the commands to soft reset.

Command Syntax

```
clear ip bgp <1-4294967295> vpnv4 unicast in
clear ip bgp <1-4294967295> vpnv4 unicast out
clear ip bgp <1-4294967295> vpnv4 unicast soft
clear ip bgp <1-4294967295> vpnv4 unicast soft in
clear ip bgp <1-4294967295> vpnv4 unicast soft out
```

Parameters

<1-4294967295>	Clear peers with this AS number
in	Clear incoming advertised routes
out	Clear outgoing advertised routes
soft	Clear both incoming and outgoing routes
in	Soft reconfig inbound update
out	Soft reconfig outbound update

Command Mode

Privileged Exec mode

Applicability

This command was introduced before OcNOS version 1.3.

Examples

```
#clear ip bgp 500 vpnv4 unicast soft out
```

clear bgp A.B.C.D l2vpn vpls

Use this command to reset the session for neighbor with address A.B.C.D.

Command Syntax

```
clear bgp A.B.C.D l2vpn vpls
```

Parameters

A.B.C.D BGP neighbor address.

Command Mode

Privileged Exec Modes

Applicability

This command was introduced before OcnOS version 1.3.

Example

```
#clear bgp 192.168.0.3 l2vpn vpls
```

clear ip bgp A.B.C.D vpnv4

Use this command to reset an VPNv4 BGP connection for a specific IPv4 address.

Note: The `soft in` or `in` and `soft out` or `out` in the BGP commands performs the same functionality. User can use any of the commands to soft reset.

Command Syntax

```
clear ip bgp A.B.C.D vpnv4 unicast in
clear ip bgp A.B.C.D vpnv4 unicast out
clear ip bgp A.B.C.D vpnv4 unicast soft
clear ip bgp A.B.C.D vpnv4 unicast soft in
clear ip bgp A.B.C.D vpnv4 unicast soft out
```

Parameters

<code>in</code>	Clear incoming advertised routes
<code>out</code>	Clear outgoing advertised routes
<code>soft</code>	Clear both incoming and outgoing routes
<code>in</code>	Soft reconfig inbound update
<code>out</code>	Soft reconfig outbound update

Command Mode

Privileged Exec mode

Applicability

This command was introduced before OcnOS version 1.3.

Examples

```
#clear ip bgp 10.10.0.12 vpnv4 unicast soft
#clear ip bgp 10.10.0.10 vpnv4 unicast out
```

debug bgp mpls

Use this command to enable the display of MPLS related information.

Use the `no` parameter with this command to disable this function.

Note: This command is available only when `vrf` option is enabled.

Command Syntax

```
debug bgp mpls
no debug bgp mpls
```

Parameters

None

Command Mode

Privileged Exec mode

Applicability

This command was introduced before OcnOS version 1.3.

Examples

```
debug bgp mpls
```

export map

This command assigns a route map to the VRF. This map is applied for routing information exported to another PE or VRF.

Use this command when an application requires finer control over the routes exported to another VRF or PE than provided by the import and export extended communities. You can filter routes that are eligible for export to another VRF or PE through the use of a route map. The route map can deny access to selected routes from a community that is on the export list.

Note: Only match rules (deny/permit) are applied for exported routes, set rules will not apply.

Use the `no` command to remove the map.

Command Syntax

```
export map WORD
no export map
```

Parameters

WORD Route map

Default

No default value is specified

Command Mode

VRF mode

Applicability

This command was introduced in OcNOS version 4.1.

Examples

```
(config)#ip vrf myVRF
(config-vrf)#export map set-pref
(config-vrf)#
```

import map

This command assigns a route map to the VRF. This map is applied for routing information imported from another PE or VRF.

Use this command when an application requires finer control over the routes imported into a VRF than provided by the import and export extended communities. You can filter routes that are eligible for import into a VRF through the use of a route map. The route map can deny access to selected routes from a community that is on the import list.

Use the `no` command to remove the map.

Command Syntax

```
import map WORD
no import map
```

Parameters

WORD	Route map
------	-----------

Default

No default value is specified

Command Mode

VRF mode

Applicability

This command was introduced in OcNOS version 4.1.

Examples

```
(config)#ip vrf myVRF
(config-vrf)#import map set-pref
(config-vrf)#
```

ip vrf

Use this command to assign a VPN Routing Forwarding (VRF) instance.

Use the `no` option with this command to remove the VRF from the instance.

Command Syntax

```
ip vrf WORD
no ip vrf WORD
```

Parameter

WORD	Name of the VRF instance
------	--------------------------

Default

No default value is specified

Command Mode

Configure mode

Applicability

This command was introduced before OcNOS version 1.3.

Command Example

```
(config)#ip vrf myVRF
(config-vrf)#
```

neighbor allow-ebgp-vpn

Use this command to allow an eBGP neighbor to be a VPN peer. By default, BGP VPN functionality is allowed only for iBGP peers.

Use the `no` parameter with this command to remove the configuration.

Command Syntax

```
neighbor (A.B.C.D|X:X::X:X|WORD) allow-ebgp-vpn
no neighbor (A.B.C.D|X:X::X:X|WORD) allow-ebgp-vpn
```

Parameters

A.B.C.D	Address of the BGP neighbor in IPv4 format
X:X::X:X	Address of the BGP neighbor in IPv6 format
WORD	Name of a BGP peer group created with the neighbor WORD peer-group command. When you specify this parameter, the command applies to all peers in the group.

Default

By default, BGP VPN functionality is allowed only for iBGP peers

Command Mode

Address Family-vpnv4 mode and Address Family-vpnv6 mode

Applicability

This command was introduced before OcnOS version 1.3.

Examples

```
(config)#router bgp 200
(config-router)#neighbor 66.66.66.66 remote-as 100
(config-router)#neighbor 66.66.66.66 update-source lo
(config-router)#address-family vpnv4 unicast
(config-router-af)#neighbor 66.66.66.66 allow-ebgp-vpn
(config-router-af)#neighbor 66.66.66.66 activate
(config-router-af)#exit-address-family
```

neighbor as-override

Use this command to configure a provider edge (PE) router to override the autonomous system number (ASN) of a site with the ASN of a provider. BGP normally ignores routes from the same autonomous system. However, this command is used so that the Customer Edge (CE) routers accept and install routes from the same autonomous system.

Typically, this command is used when CE routers have the same ASN in some or all sites. As per BGP requirement, a BGP speaker rejects a route that has the same ASN as itself in the `AS_PATH` attribute. Thus the CE routers having the same ASN do not accept routes from each other. Giving this command on the PE router removes the CE neighbor's ASN from the `AS_PATH` attribute allowing CE routers with the same ASN to accept routes from each other.

Use the `no` parameter with this command to remove VPN IPv4 prefixes from a specified router.

Command Syntax

```
neighbor (A.B.C.D|X:X::X:X|WORD) as-override
no neighbor (A.B.C.D|X:X::X:X|WORD) as-override
```

Parameters

A.B.C.D	Address of the BGP neighbor in IPv4 format
X:X::X:X	Address of the BGP neighbor in IPv6 format
WORD	Name of a BGP peer group created with the neighbor WORD peer-group command. When you specify this parameter, the command applies to all peers in the group.

Default

By default, neighbor as override is disabled

Command Mode

Address Family-vrf mode

Applicability

This command was introduced before OcnOS version 1.3.

Examples

```
#configure terminal
(config)#router bgp 7657
(config-router)#address-family ipv4 vrf VRF_A
(config-router-af)#neighbor 10.10.0.1 as-override

#configure terminal
(config)#router bgp 7657
(config-router)#address-family ipv6 vrf VRF_A
(config-router-af)#neighbor 3ffe:15:15:15:15::0 as-override
```

neighbor send-community

Use this command to send the extended-community attribute to a customer edge router. In VPN, the route-distinguisher and route-target are encoded in BGP extended-community.

See also [neighbor send-community](#) in [Chapter 1, BGP Commands](#).

Command Syntax

```
no neighbor (A.B.C.D|X:X::X:X|WORD) send-community
no neighbor (A.B.C.D|X:X::X:X|WORD) send-community (both|extended|standard)
neighbor (A.B.C.D|X:X::X:X|WORD) send-community
neighbor (A.B.C.D|X:X::X:X|WORD) send-community (both|extended|standard)
```

Parameters

A.B.C.D	Address of the BGP neighbor in an IPv4 format
X:X::X:X	Address of the BGP neighbor in an IPv6 format
WORD	Name of a BGP peer group created with the neighbor WORD peer-group command. When you specify this parameter, the command applies to all peers in the group.
both	Send standard and extended community attributes
extended	Send extended community attributes
standard	Send standard community attributes

Default

By default, both communities (standard and extended) are sent to every BGP neighbor.

Command Mode

Address Family Unicast mode and Address Family VRF mode.

Applicability

This command was introduced before OcNOS version 1.3.

Examples

```
(config)#router bgp 100
(config-router)#address-family ipv4 vrf VRF_A
(config-router-af)#neighbor 10.10.10.1 remote-as 200
(config-router-af)#no neighbor 10.10.0.1 send-community extended
```

neighbor soo

Use this command to enable the site-of-origin (SOO) feature. If the customer AS is multi-homed to the ISP, this command ensures that the PE does not advertise the routes back to the same AS.

Use the `no` parameter with this command to disable this feature.

Command Syntax

```
neighbor (A.B.C.D|X:X::X:X|WORD) soo AS:nn_or_IP:nn
no neighbor (A.B.C.D|X:X::X:X|WORD) soo
```

Parameters

A.B.C.D	Address of the BGP neighbor in IPv4 format
X:X::X:X	Address of the BGP neighbor in IPv6 format
WORD	Name of a BGP peer group created with the neighbor WORD peer-group command. When you specify this parameter, the command applies to all peers in the group.
ASN:nn_or_IP-address:nn	An AS number and an arbitrary number (for example, 100:1), or a 32-bit IP address and an arbitrary number (for example, 192.16.10.1:1).

Default

By default, the site-of-origin (SOO) feature is disabled.

Command Mode

Address Family VRF mode

Applicability

This command was introduced before OcNOS version 1.3.

Examples

```
(config)#router bgp 100
(config-router)#address-family ipv4 vrf VRF_A
(config-router-af)#neighbor 1.1.1.1 remote-as 200
(config-router-af)#neighbor 10.10.0.1 soo 100:1
```

rd (route distinguisher)

Use this command to assign a route distinguisher (RD) for the VRF. The route distinguisher value must be a unique value on the router.

This command creates routing and forwarding tables and specifies the default RD for a VPN. The RD is added to the customer's IPv4 prefixes, changing them into globally unique VPN-IPv4 prefixes.

Use `no` form command to remove the RD configuration.

Note: RD configuration cannot be changed, it needs to be removed and added back with new value. When RD configuration is removed the RT configuration is also lost and needs to be reconfigured.

Command Syntax

```
rd ASN:nn_or_IP-address:nn
no rd ASN:nn_or_IP-address:nn
```

Parameters

ASN:nn_or_IP-address:nn

AS number and an arbitrary number (for example, 100:1). Otherwise, specify a 32-bit IP address and an arbitrary number (for example, 192.16.10.1:1).

Default

No default value is specified

Command Mode

VRF mode

Applicability

This command was introduced before OcnOS version 1.3.

Examples

```
(config)#ip vrf VRF_A
(config-vrf)#rd 100:1
```

route-target

Use this command to add a list of import and export route-target extended communities to the VRF.

This command creates lists of import and export route-target extended communities for the VRF. It specifies a target VPN extended community. Execute the command once for each community. All routes with the specific route-target extended community are imported into all VRFs with the same extended community as an import route-target.

Use the `no` parameter with this command to delete a route target.

Route-target values on a MAC-VRF can be manually configured or auto derived from BGP.

Note: Auto-RT is supported only with ASN of 2bytes.

Command Syntax

```
route-target (import|export|both) (ASN:nn_or_IP-address:nn|evpn-auto-rt)
no route-target (import|export|both) (ASN:nn_or_IP-address:nn|evpn-auto-rt)
```

Parameters

<code>import</code>	Import routing information
<code>export</code>	Export routing information
<code>both</code>	Import and export routing information
<code>ASN:nn_or_IP-address:nn</code>	AS number and an arbitrary number (for example, 100:1). Otherwise, specify a 32-bit IP address and an arbitrary number (for example, 192.16.10.1:1).
<code>evpn-auto-rt</code>	route-target auto-derived from BGP

Default

No default value is specified

Command Mode

VRF mode

Applicability

This command was introduced before OcNOS version 1.3 and `evpn-auto-rt` option for `mac-vrf` is introduced from in OcNOS version 6.0.0.

Examples

```
(config)#ip vrf VRF_A
(config-vrf)#route-target both 100:10

(config)#ip vrf VRF_A
(config-vrf)#route-target import 100:20

(config)#mac vrf l2vrf1
(config-vrf)#route-target both evpn-auto-rt
```

CHAPTER 7 BGP Show Commands

This chapter describes the BGP show commands.

- `show bgp`
- `show bgp A.B.C.D`
- `show bgp A.B.C.D/M`
- `show bgp client`
- `show bgp community`
- `show bgp community-list`
- `show bgp dampening dampened-paths`
- `show bgp dampening flap-statistics`
- `show bgp dampening parameters`
- `show bgp filter-list`
- `show bgp inconsistent-as`
- `show bgp ipv6`
- `show bgp ipv6 peer-group`
- `show bgp l2vpn vpls`
- `show bgp neighbors`
- `show bgp neighbors advertised-routes`
- `show bgp neighbors received prefix-filter`
- `show bgp neighbors received-routes`
- `show bgp neighbors routes`
- `show bgp nexthop-tracking`
- `show bgp nexthop-tree-details`
- `show bgp paths`
- `show bgp prefix-list`
- `show bgp quote-regexp`
- `show bgp regexp`
- `show bgp route-map`
- `show bgp statistics`
- `show bgp summary`
- `show bgp X:X::X:X`
- `show bgp X:X::X:X/M longer prefixes`
- `show debugging bgp`
- `show ip bgp`
- `show ip bgp cidr-only`
- `show ip bgp community-info`
- `show ip bgp peer-group`

- `show ip bgp peer-group vrf all`
- `show ip bgp rtfiler all`
- `show ip bgp scan`
- `show ip bgp vpnv4`
- `show ip bgp vpnv6 all neighbors`
- `show ip bgp vpnv6 rd neighbors`
- `show ip extcommunity-list`
- `show ip protocols`
- `show ip vrf`
- `show running-config as-path access-list`
- `show running-config community-list`

show bgp

Use this command to display the status of BGP routes.

Command Syntax

```
show bgp ipv4
show bgp (ipv6)
show bgp (ipv4|ipv6) (unicast|multicast)
show ip bgp
show ip bgp ipv4 (unicast|multicast)
show bgp (vrf (VRFNAME|all|default))
show ip bgp (vrf (VRFNAME|all|default))
```

Parameters

ipv4	IPv4 routes
ipv6	IPv6 routes
unicast	Unicast prefixes
multicast	Multicast prefixes
VRFNAME	VPN routing/forwarding instance name
all	All VRFs
default	Default VRF

Command Mode

Privileged Exec mode and Exec mode

Applicability

This command was introduced before OcnOS version 1.3.

Examples

```
#show ip bgp
BGP table version is 1, local router ID is 12.0.0.1
Status codes: s suppressed, d damped, h history, * valid, > best, i -
internal,
                l - labeled, S Stale
Origin codes: i - IGP, e - EGP, ? - incomplete

Network          Next Hop        Metric      LocPrf   Weight    Path
*> 1.1.1.1/32    0.0.0.0         0           100      32768     i

Total number of prefixes 1
```

show bgp A.B.C.D

Use this command to display BGP route information for a network.

Command Syntax

```
show bgp (ipv4) (unicast|multicast) A.B.C.D
show ip bgp A.B.C.D
show ip bgp ipv4 (unicast|multicast) A.B.C.D
```

Parameters

ipv4	IPv4 routes
unicast	Unicast prefixes
multicast	Multicast prefixes
A.B.C.D	IP prefix (network), for example, 35.0.0.0

Command Mode

Privileged Exec and Exec mode

Applicability

This command was introduced before OcNOS version 1.3.

Examples

```
#show ip bgp 80.80.80.0

BGP routing table entry for 80.80.80.0/24
Paths: (1 available, no best path)
Not advertised to any peer
300
 15.15.15.1 (inaccessible) from 11.11.11.2 (15.15.15.2)
  Origin incomplete, metric 0, localpref 100, valid, internal
  rx path id: 0      tx path id: -1
  Last update: Wed May 11 15:22:36 2016
```

[Table 7-5](#) explains the output fields.

Table 7-5: show ip bgp output details

Field	Description
Paths	The paths listed in the routing table, along with path information, and whether the path are being advertised.
Metric	If shown, the value of the inter-autonomous system metric.
LocalPref	Local preference value as set with the set local-preference route-map configuration command.
rx path_id	Autonomous system receive path to the source network. There can be one entry in this field for each autonomous system in the path.

Table 7-5: show ip bgp output details

Field	Description
tx path_id	Autonomous system transmit path to the destination network. There can be one entry in this field for each autonomous system in the path.
Last update	Last time since the neighbor transitioned to or from the established state.

show bgp A.B.C.D/M

Use this command to display BGP route information for a network prefix.

Command Syntax

```
show bgp ipv4 (unicast|multicast) A.B.C.D/M
show ip bgp A.B.C.D/M
show ip bgp ipv4 (unicast|multicast) A.B.C.D/M
show ip bgp A.B.C.D/M (vrf (VRFNAME|all|default))
show ip bgp A.B.C.D/M longer-prefixes
show ip bgp ipv4 (unicast|multicast) A.B.C.D/M longer-prefixes
show ip bgp A.B.C.D/M longer-prefixes (vrf (VRFNAME|all|default))
```

Parameters

ipv4	IPv4 routes
unicast	Unicast prefixes
multicast	Multicast prefixes
A.B.C.D/M	IP prefix (network/length), for example, 35.0.0.0/8
longer-prefixes	Display route and more specific routes
VRFNAME	VPN routing/forwarding instance name
all	All VRFs
default	Default VRF

Command Mode

Privileged Exec and Exec mode

Applicability

This command was introduced before OcnOS version 1.3.

Examples

```
#show bgp ipv4 unicast 22.22.22.22/32
BGP routing table entry for 22.22.22.22/32
Paths: (2 available, best #1, table Default-IP-Routing)
  Not advertised to any peer
  Local
    11.11.11.2 from 11.11.11.2 (2.2.2.2)
      Origin IGP, metric 0, localpref 100, valid, internal, best
      Last update: Fri Feb 16 09:46:54 2001

  Local
    11.11.12.2 from 11.11.12.2 (2.2.2.2)
      Origin IGP, metric 0, localpref 100, valid, internal
      Last update: Fri Feb 16 09:46:52 2001
```

show bgp client

Use this command to display BGP client information.

Command Syntax

```
show bgp client
```

Parameters

None

Command Mode

Privileged Exec and Exec mode

Applicability

This command was introduced before OcNOS version 1.3.

Examples

```
R1#sh bgp client
BGP client ID: 11
PIM, socket 10
  Service: AS number service, Route Service
  Message received 1, sent 1
  Connection time: Tue May 14 03:11:01 2019
  Last message read: Service Request
  Last message write: Service Reply
R1#
```

show bgp community

Use this command to display BGP routes that match a community.

Command Syntax

```
show bgp ip (unicast|multicast) community
show bgp ip (unicast|multicast) community (vrf (VRFNAME|all|default))
show bgp ip (unicast|multicast) community [AA:NN|local-AS|no-advertise|no-export]
    (exact-match|)
show ip bgp community
show ip bgp community [AA:NN|local-AS|no-advertise|no-export|internet] (exact-
    match|)
show ip bgp community (vrf (VRFNAME|all|default))
show ip bgp community [AA:NN|local-AS|no-advertise|no-export|internet] (exact-
    match|)
show ip bgp community-list WORD (exact-match|) (vrf (VRFNAME|all|default))
show ip bgp ipv4 (unicast|multicast) community
show ip bgp ipv4 (unicast|multicast) community (vrf (VRFNAME|all|default))
```

Parameters

ipv4	IPv4 routes
ipv6	IPv6 routes
unicast	Unicast prefixes
multicast	Multicast prefixes
VRFNAME	VPN routing/forwarding instance name
all	All VRFs
default	Default VRF
AA:NN	Community number
local-AS	Do not send outside local AS (well-known community)
no-advertise	Do not advertise to any peer (well-known community)
no-export	Do not export to next AS (well-known community)
internet	Internet community (well-known community)
exact-match	Exact match of the communities

Command Mode

Privileged Exec mode and Exec mode

Applicability

This command was introduced before OcNOS version 1.3.

Example

```
#show bgp community
```

```
BGP table version is 1, local router ID is 102.67.98.95
Status codes: s suppressed, d damped, h history, * valid, > best, i -
internal,
                l - labeled, S Stale
Origin codes: i - IGP, e - EGP, ? - incomplete

Network          Next H      Metric    LocPrf    Weight    Path
*> 2001:43f8:bb1::/64  ::          0         100       32768     ?

Total number of prefixes 1
```

show bgp community-list

Use this command to display BGP routes that match a community list.

Command Syntax

```
show bgp community-list WORD (exact-match|)
show bgp ip (unicast|multicast) community-list WORD (exact-match|)
show bgp ip (unicast|multicast) community-list WORD (exact-match|)
show bgp (ipv4|ipv6) (unicast|multicast) community-list WORD (exact-match|)
show bgp (ipv6) community-list WORD (exact-match|)
show ip bgp community-list WORD (exact-match|)
show ip bgp ipv4 (unicast|multicast) community-list WORD (exact-match|)
```

Parameters

WORD	Community list name
ipv4	IPv4 routes
ipv6	IPv6 routes
unicast	Unicast prefixes
multicast	Multicast prefixes
exact-match	Only routes that exactly match the community

Command Mode

Privileged Exec mode and Exec mode

Applicability

This command was introduced before OcNOS version 1.3.

Example

```
#show bgp community-list Originate
Named Community expanded list Originate
  permit 37721:1[0-2]0[05]$
  permit 37721:1[0-2]0[05]
```

show bgp dampening dampened-paths

Use this command to display detailed information about paths suppressed due to dampening.

Command Syntax

```
show bgp dampening dampened-paths
show bgp (ipv4|ipv6) (unicast|multicast) dampening dampened-paths
show bgp (ipv6) dampening dampened-paths
show ip bgp dampening dampened-paths
show ip bgp dampening dampened-paths (vrf (VRFNAME|all|default))
show ip bgp ipv4 (unicast|multicast) dampening dampened-paths
```

Parameters

ipv4	IPv4 routes
ipv6	IPv6 routes
unicast	Unicast prefixes
multicast	Multicast prefixes
VRFNAME	VPN routing/forwarding instance name
all	All VRFs
default	Default VRF

Command Mode

Privileged Exec mode and Exec mode

Applicability

This command was introduced before OcNOS version 1.3.

Example

```
#show ip bgp dampening dampened-paths
BGP table version is 32, local router ID is 3.3.3.3
Status codes: s suppressed, d damped, h history, * valid, > best, i -
internal, l - labeled, S Stale
Origin codes: i - IGP, e - EGP, ? - incomplete
```

```
Network          From           Reuse   Path
d  11.11.11.0/24  90.90.90.1    00:27:20 200 i
```

[Table 7-6](#) shows the status codes displayed at the start of a route entry.

Table 7-6: Status details

Status Code	Description	Comments
s	suppressed	Whether the route is suppressed and is not advertised to neighbors.
d	damped	When the penalty of a flapping route exceeds the suppress limit, the route is damped and remains in a withdrawn state until its penalty decreases below the reuse limit.
h	history	When the penalty of a flapping route does not exceed the suppress limit, the route is not damped and BGP maintains a history of the flapping route.
p	stale	When the BGP neighbor from which a route is learned is in graceful restart, the route is retained in the BGP routing table, but marked as stale .
*	valid	Whether the route is valid. When a route is not suppressed, damped, or present in the history, it is valid.
>	best	The selected route to be installed in the kernel routing table.
i	internal	The prefix was learned from an iBGP peer.

Table 7-7 shows the codes at the end of each route entry that indicate where the route originated.

Table 7-7: origin details

Origin Code	Description	Comments
i	IGP	The route is from an Interior Gateway Protocol.
e	EGP	The route is from an Exterior Gateway Protocol.
?	incomplete	Origin not known. Typically, these are routes redistributed from an IGP.

Table 7-8 explains the output fields.

Table 7-8: show bgp dampening dampened-paths output details

Field	Description
Network	Internet address of a network.
From	IP address of the advertising peer.
Reuse	The amount of time remaining until this route will be un-suppressed and can be used again.
Path	Autonomous system path to the destination network.

show bgp dampening flap-statistics

Use this command to display BGP dampening flap statistics.

Command Syntax

```
show bgp dampening flap-statistics
show bgp (ipv4|ipv6) (unicast|multicast) dampening flap-statistics
show bgp (ipv6) dampening flap-statistics
show ip bgp dampening flap-statistics
show ip bgp dampening flap-statistics (vrf (VRFNAME|all|default))
show ip bgp ipv4 (unicast|multicast) dampening flap-statistics
```

Parameters

ipv4	IPv4 routes
ipv6	IPv6 routes
unicast	Unicast prefixes
multicast	Multicast prefixes
VRFNAME	VPN routing/forwarding instance name
all	All VRFs
default	Default VRF

Command Mode

Privileged Exec mode and Exec mode

Applicability

This command was introduced before OcNOS version 1.3.

Examples

This sample output shows that the internal route (i), has flapped 3 times and is now categorized as history (h).

```
#show ip bgp dampening flap-statistics
BGP table version is 1, local router ID is 30.30.30.77
Status codes: s suppressed, d damped, h history, * valid, > best, i -
internal, S Stale
Origin codes: i - IGP, e - EGP, ? - incomplete
   Network          From          Flaps  Duration  Reuse    Path
hi1.1.1.0/24    10.100.0.62      3 00:01:20    i
```

[Table 7-9](#) shows the status codes displayed at the start of a route entry.

Table 7-9: status details

Status Code	Description	Comments
s	suppressed	Whether the route is suppressed and is not advertised to neighbors.
d	damped	When the penalty of a flapping route exceeds the suppress limit, the route is damped and remains in a withdrawn state until its penalty decreases below the reuse limit.
h	history	When the penalty of a flapping route does not exceed the suppress limit, the route is not damped and BGP maintains a history of the flapping route.
p	stale	When the BGP neighbor from which a route is learned is in graceful restart, the route is retained in the BGP routing table, but marked as stale .
*	valid	Whether the route is valid. When a route is not suppressed, damped, or present in the history, it is valid.
>	best	The selected route to be installed in the kernel routing table.
i	internal	The prefix was learned from an iBGP peer.

Table 7-10 shows the codes at the end of each route entry that indicate where the route originated.

Table 7-10: origin details

Origin Code	Description	Comments
i	IGP	The route is from an Interior Gateway Protocol.
e	EGP	The route is from an Exterior Gateway Protocol.
?	incomplete	Origin not known. Typically, these are routes redistributed from an IGP.

Table 7-11 explains the output fields.

Table 7-11: show bgp dampening flap-statistics output details

Field	Description
Network	Internet address of a network.
From	IP address of the advertising peer.
Flaps	Number of times this route has failed and returned (flapped).
Duration	Elapsed time since the first penalty points were assessed.
Reuse	The amount of time remaining until this route will be un-suppressed and can be used again.
Path	Autonomous system path to the destination network.

show bgp dampening parameters

Use this command to display the BGP dampening parameters.

Command Syntax

```
show bgp dampening parameters
show bgp (ipv4|ipv6) (unicast|multicast) dampening parameters
show bgp (ipv6) dampening parameters
show ip bgp dampening parameters
show ip bgp ipv4 (unicast|multicast) dampening parameters (vrf
  (VRFNAME|all|default))
show ip bgp dampening parameters (vrf (VRFNAME|all|default))
```

Parameters

ipv4	IPv4 routes
ipv6	IPv6 routes
unicast	Unicast prefixes
multicast	Multicast prefixes
VRFNAME	VPN routing/forwarding instance name
all	All VRFs
default	Default VRF

Command Mode

Privileged Exec mode and Exec mode

Applicability

This command was introduced before OcNOS version 1.3.

Examples

```
#show ip bgp dampening parameters
dampening 5 750 2000 60 15
Dampening Control Block(s):
  Reachability Half-Life time      : 5 min
  Reuse penalty                    : 750
  Suppress penalty                 : 2000
  Max suppress time                : 60 min
  Un-reachability Half-Life time   : 15 min
  Max penalty (ceil)               : 11999
  Min penalty (floor)              : 375
#
```

[Table 7-12](#) explains the output fields.

Table 7-12: show ip bgp dampening parameters output details

Field	Description
Dampening Control Block(s)	Flap damping reduces the number of update messages by marking routes as ineligible for selection as the active or preferable route.
Reachability Half-Life time	Number of minutes after which an arbitrary value is halved if a route stays stable.
Reuse penalty	Reuse threshold—Arbitrary value below which a suppressed route can be used again.
Suppress penalty	Cutoff (suppression) threshold—Arbitrary value above which a route can no longer be used or included in advertisements.
Max suppress time	Maximum hold-down time for a route, in minutes.
Un-reachability Half-Life time	Number of minutes after which an arbitrary value is not halved if a route stays stable.
Max penalty (ceil)	Maximum penalty corresponds to the time it would take max-suppress to decay and reach the reuse level (ceil).
Min penalty (floor)	Maximum penalty corresponds to the time it would take max-suppress to decay and reach the reuse level (floor).

show bgp filter-list

Use this command to display routes that match a regular expression filter list.

Command Syntax

```
show bgp filter-list WORD
show bgp (ipv4|ipv6) (unicast|multicast) filter-list WORD
show bgp (ipv6) filter-list WORD
show ip bgp filter-list WORD
show ip bgp ipv4 (unicast|multicast) filter-list WORD
show ip bgp filter-list WORD (exact-match)
show ip bgp filter-list WORD (exact-match) (vrf (VRFNAME|all|default))
show ip bgp filter-list WORD (vrf (VRFNAME|all|default))
show ip bgp ipv4 (unicast|multicast) filter-list WORD (exact-match) (vrf
(VRFNAME|all|default))
```

Parameters

WORD	Regular-expression filter list
ipv4	IPv4 routes
ipv6	IPv6 routes
unicast	Unicast prefixes
multicast	Multicast prefixes
exact-match	Exact match of the filter list
VRFNAME	VPN routing/forwarding instance name
all	All VRFs
default	Default VRF
vrf	VPN Routing/Forwarding instance name

Command Mode

Privileged Exec mode and Exec mode

Applicability

This command was introduced before OcNOS version 1.3.

Example

```
#show bgp filter-list bgp-local-only
BGP table version is 1, local router ID is 102.67.98.95
Status codes: s suppressed, d damped, h history, * valid, > best, i - internal,
               l - labeled, S Stale
Origin codes: i - IGP, e - EGP, ? - incomplete

Network          Next Hop          Metric      LocPrf      Weight      Path
*> 2001:43f8:bb1::/6      ::              0           100         32768       ?
```

Total number of prefixes 1

show bgp inconsistent-as

Use this command to display routes with inconsistent AS paths.

Command Syntax

```
show bgp inconsistent-as
show bgp (ipv4|ipv6) (unicast|multicast) inconsistent-as
show bgp (ipv6) inconsistent-as
show ip bgp inconsistent-as
show ip bgp ipv4 inconsistent-as
show ip bgp ipv4 (unicast|multicast) inconsistent-as
```

Parameters

ipv4	IPv4 routes
ipv6	IPv6 routes
unicast	Unicast prefixes
multicast	Multicast prefixes

Command Mode

Privileged Exec mode and Exec mode

Applicability

This command was introduced before OcnOS version 1.3.

Examples

```
#show bgp inconsistent-as

BGP table version is 3, local router ID is 2.2.2.2
Status codes: s suppressed, d damped, h history, * valid, > best, i - internal
Origin codes: i - IGP, e - EGP, ? - incomplete

Network      Next Hop          Metric      LocPrf   Weight   Path
*> 10.1.0.0  172.29.232.55    0           0        100     ?
```

show bgp ipv6

Use this command to display the BGP routing table.

Command Syntax

```
show bgp ipv6 (unicast|multicast|labeled|)
show bgp ipv6 (unicast|multicast|labeled|) X:X::X:X/M
```

Parameters

multicast	IPv6 multicast address prefixes
unicast	IPv6 unicast address prefixes
labeled	Labeled IPv6 routes
X:X::X:X/M	IPv6 prefix network/length, such as 3ffe:a::/64

Command Mode

Privileged Exec mode and Exec mode

Applicability

This command was introduced before OcNOS version 1.3.

Example: iBGP and eBGP Routes

This example shows routes learned from both iBGP and eBGP.

```
#show bgp ipv6
BGP table version is 0, local router ID is 10.100.0.77
Status codes: s suppressed, d damped, h history, * valid, > best, i - internal S stale,
Origin codes: i - IGP, e - EGP, ? - incomplete
   Network                               Metric LocPrf Weight  Path
*> 2001:58::/32                           0    20  ?
    fe80::202:b3ff:fec8:9fdb
*> 2002:58::/32                           0    20  i
    fe80::202:b3ff:fec8:9fdb
*>i2003:58::/32                           100   0   i
    fe80::208:a1ff:fe16:797d
```

Header

BGP table version is 0, local router ID is 10.100.0.77

- BGP table version
- BGP router ID is 10.100.0.77

Status codes: s suppressed, d damped, h history, p stale, * valid, > best, i - internal

[Table 7-13](#) shows the status codes displayed at the start of a route entry.

Table 7-13: status details

Status Code	Description	Comments
s	suppressed	Whether the route is suppressed and is not advertised to neighbors.
d	damped	When the penalty of a flapping route exceeds the suppress limit, the route is damped and remains in a withdrawn state until its penalty decreases below the reuse limit.
h	history	When the penalty of a flapping route does not exceed the suppress limit, the route is not damped and BGP maintains a history of the flapping route.
p	stale	When the BGP neighbor from which a route is learned is in graceful restart, the route is retained in the BGP routing table, but marked as stale .
*	valid	Whether the route is valid. When a route is not suppressed, damped, or present in the history, it is valid.
>	best	The selected route to be installed in the kernel routing table.
i	internal	The prefix was learned from an iBGP peer.

Origin codes: i - IGP, e - EGP, ? - incomplete

Table 7-14 shows the codes at the end of each route entry that indicate where the route originated.

Table 7-14: origin codes

Origin Code	Description	Comments
i	IGP	The route is from an Interior Gateway Protocol.
e	EGP	The route is from an Exterior Gateway Protocol.
?	incomplete	Origin not known. Typically, these are routes redistributed from an IGP.

Route Entry Examples

```
*> 2002:58::/32    fe80::202:b3ff:fec8:9fdb          0 20 i
```

- This route entry shows that this route is learned from eBGP.
- The origin code “i” means that the prefix is added by the network statement at originating AS.
- The path 20 indicates that the prefix advertisement originated from AS20.
- The administrative weight parameter applies only to routes within an individual router.
- Since this route was learned from a peer, it has a default weight of 0. All routes generated by the local router have a weight of 32,768.

```
*> 2001:58::/32    fe80::202:b3ff:fec8:9fdb          0 20 ?
```

- This route entry shows that the prefix is learnt from eBGP. The origin code i indicates that the prefix is added by network statement at originating AS. The path attribute 20 indicates that the route advertisement originated from AS20. The administrative weight parameter applies only to routes within an individual router. Since this route was learned from a peer, it has a default weight of 0. All routes generated by the local router have a weight of 32,768. The origin code “?” means the route was learned through redistribution.

```
*>i2003:58::/32    fe80::208:a1ff:fe16:797d          100 0 i
```

- The status code “i” means that the route was learned through iBGP. The Local Preference attribute of the route, which is used only with the local AS, is set to 100 (the default value).

Example: IPv6 Prefix Routes

This example shows labeled routes for a given IPv6 prefix:

```
#show bgp ipv6 labeled 3ffe:a::/64
  BGP routing table entry for 3ffe:a::/64
  Paths: (1 available, best #1, table Default-IP-Routing-Table)
  Not advertised to any peer
  Local
  ::ffff:114:1414 from 20.20.20.1 (92.92.92.92)
  Origin incomplete metric 0, localpref 100, label    5420,
  valid, internal, best
  Last update: Mon May 26 17:48:18 2008
```

Table 7-15 explains the output fields.

Table 7-15: show bgp ipv6 output details

Field	Description
Paths	The paths listed in the routing table, along with path information, and whether the path are being advertised.
Metric	If shown, the value of the inter-autonomous system metric.
LocalPref	Local preference value as set with the set local-preference route-map configuration command.
rx path_id	Autonomous system receive path to the source network. There can be one entry in this field for each autonomous system in the path.
tx path_id	Autonomous system transmit path to the destination network. There can be one entry in this field for each autonomous system in the path.
Last update	Last time since the neighbor transitioned to or from the established state.

show bgp ipv6 peer-group

Use this command to list the BGP peer group information in ipv6 unicast.

Command Syntax

```
show bgp ipv6 peer-group (WORD|)
```

Parameters

WORD	Name of the peer group
------	------------------------

Command Mode

Privileged Exec mode and Exec mode

Applicability

This command was introduced in OcNOS version 4.2.

Example

```
#show bgp ipv6 peer-group p2
BGP dynamic peer-group is p2, IBGP, remote AS 42949672
  BGP dynamic peer-group p2 listen range group members:
  5ffe:3::/64
  BGP version 4
Minimum time between advertisement runs is 5 seconds
For address family: IPv6 Unicast
Peer-group member:
*5ffe:3::1
Index 2, Offset 0, Mask 0x4
0 accepted prefixes, 0 announced prefixes
#
```

show bgp l2vpn vpls

Command Syntax

```
show bgp l2vpn vpls (rr|) (detail|)
```

Parameters

rr	Display the information of auto-discovered peers at Route reflector node.
detail	Display the detailed information of auto-discovered peers.

Command Mode

Exec and Privileged Exec Modes

Applicability

This command was introduced in version OcnOS version 1.3.

Example

```
#show bgp l2vpn vpls
VPLS-ID  VE-ID    Discovered-Peers  Route-Target
10       3         1                 10:100

#show bgp l2vpn vpls detail

VPLS ID: 10
VE-ID: 3
Discovered Peers: 1
Route-Target: 10:100
Local RD: 10:100
Mesh Peers:
  Address:3.3.3.3, RD:10:100, VE-ID:4
  VC Details: VC-ID:34
  Remote (LB:52480,VBO:1,VBS:64)  Local (LB:52480,VBO:1,VBS:64)
  LB sent on known VEID:Yes
  In Label:52483, Out Label:52482
  PW Status:Established
```

[Table 7-16](#) explains the output fields.

Table 7-16: show bgp l2vpn vpls output details

Field	Description
VPLS-ID	L2VPN address family database information for the Virtual Private LAN Service (VPLS).
VE-ID	L2VPN address family database information for the Virtual Expansion.
Discovered Peers	Peer discovery is used to find peers that are available for data using LLDP.
Route-Target	An identifier prepended to IP addresses to assure the uniqueness of the address.

Table 7-16: show bgp l2vpn vpls output details

Field	Description
Local RD	The Local Route Descriptor – the first two numbers of the Route-Target.
Mesh Peers	Internal BGP peers – devices that do not re-advertise routes to other IBGP devices.
Address	Mesh session information for the peer specified with the ip-address argument.
RD	Mesh peer's Route-Descriptor.
VC Details	The virtual circuit session information with the ip-address for the Provider Edge (PE) routers.
Remote	LB (Label Base) – the first label value of a free set of labels that can be reserved by the PE router to be used for this VPLS domain. VBO (VE Block Offset) – the offset value to be used when multiple label blocks must be created by a PE router. VBS (VE Block Size) – the size of the label block.
Local	LB (Label Base) – the first label value of a free set of labels that can be reserved by the PE router to be used for this VPLS domain. VBO (VE Block Offset) – the offset value to be used when multiple label blocks must be created by a PE router. VBS (VE Block Size) – the size of the label block.
LB sent on known VEID	Whether the Label Base came on a known Virtual Expansion Identifier – yes or no.
In Label	The ingress (incoming interface) label for this segment.
Out Label	Label received from downstream neighbor for route.
PW Status	The status of the VPLS Pseudo-Wire. Values can be: Idle, Active, Open, or Established.

```
#show bgp l2vpn vpls rr
RD      RR-Clients  Non-Clients  Route-Target
10:100  2           0           10:100
10:100  2           0           10:100
```

```
#show bgp l2vpn vpls rr detail

Route-Target: 10:100
Peer:1.1.1.1
RR Client   : Yes
VE-ID:3    LB:52480  VBO:1    VBS:64

Route-Target: 10:100
Peer:3.3.3.3
RR Client   : Yes
VE-ID:4    LB:52480  VBO:1    VBS:64
```

Table 7-17 explains the output fields.

Table 7-17: show bgp l2vpn vpls rr output details

Field	Description
Route-Target	An identifier prepended to IP addresses to assure the uniqueness of the address.
Peer	Internal BGP peers – devices that do not re-advertise routes to other IBGP devices.
RR Client	Device is a client of the Route Reflector – yes or no.
VE-ID	L2VPN address family database information for the Virtual Expansion.
LB	LB (Label Base) – the first label value of a free set of labels that can be reserved by the PE router to be used for this VPLS domain.
VBO	VBO (VE Block Offset) – the offset value to be used when multiple label blocks must be created by a PE router.
VBS	VBS (VE Block Size) – the size of the label block.

show bgp neighbors

Use this command to display information about BGP neighbor connections.

Command Syntax

```
show bgp neighbors
show bgp ipv6 neighbors
show ip bgp ipv4 (unicast|multicast) neighbors
show ip bgp neighbors
show ip bgp neighbors (A.B.C.D|X:X::X:X) (advertise-routes|)
show ip bgp ipv4 (unicast|multicast) neighbors (A.B.C.D|X:X::X:X)
show ip bgp neighbors (A.B.C.D|X:X::X:X) (hold-time|keepalive-interval|connection-
  retrytime)
show ip bgp neighbors (A.B.C.D|X:X::X:X) (sent-msgs|rcvd-
  msgs|notification|update|open|keepalive)
```

Parameters

ipv4	IPv4 neighbors
ipv6	IPv6 neighbors
unicast	Unicast prefixes
multicast	Multicast prefixes
A.B.C.D	IPv4 neighbor
X:X::X:X	IPv6 neighbor
advertised-routes	Routes advertised to a BGP neighbor
hold-time	Hold time
keepalive-interval	Keepalive interval
connection-retrytime	Connection retry time
sent-msgs	Sent packets
rcvd-msgs	Received packets
notification	Notification messages
update	Update messages
open	Open messages
keepalive	Keepalive messages

Command Mode

Privileged Exec and Exec modes

Applicability

This command was introduced before OcnOS version 1.3.

Examples

```
#show bgp neighbors
BGP neighbor is 2.2.2.2, remote AS 200, local AS 200, internal link
Member of peer-group myPeer for session parameters
  BGP version 4, remote router ID 10.12.7.155
  BGP state = Established, up for 00:04:55
  Last read 00:04:55, hold time is 90, keepalive interval is 30 seconds
Neighbor capabilities:
  Route refresh: advertised and received (old and new)
  Address family IPv4 Unicast: advertised and received
Received 11 messages, 0 notifications, 0 in queue
Sent 11 messages, 0 notifications, 0 in queue
Route refresh request: received 0, sent 0
Minimum time between advertisement runs is 5 seconds
For address family: IPv4 IPv4
  BGP table version 1, neighbor version 1
  Index 1, Offset 0, Mask 0x2
  myPeer peer-group member
  Community attribute sent to this neighbor (both)
  0 accepted prefixes
  0 announced prefixes

Connections established 1; dropped 0
Local host: 2.2.2.1, Local port: 33865
Foreign host: 2.2.2.2, Foreign port: 179
Nexthop: 2.2.2.1
Nexthop global: 1111::1
Nexthop local: fe80::a00:27ff:fecc:47a6
BGP connection: non shared network
Last Reset: 00:32:48, due to BGP Notification sent
Notification Error Message: (OPEN Message Error/Bad Peer AS.)
```

BGP Neighbor Fields

[Table 7-18](#) explains the output fields.

Table 7-18: show bgp neighbor output details

Field	Description
BGP neighbor	BGP session information for the neighbor with the ip-address argument.
remote AS	Remote Autonomous system used to exchange exterior routing information between neighboring ASs.
local AS	Local Autonomous system used to exchange internal routing information within AS.

Table 7-18: show bgp neighbor output details

Field	Description
internal link external link	Internal link is used to forward route advertisements received from an external BGP router through the internal network (in the same AS). External link is used for exchanging routing information between Autonomous Systems (AS) and routing traffic across the Internet (eBGP neighbor).
member of peer-group	Peer group information for the peer group specified with the peer-group argument.
BGP version	Negotiated BGP version for this session.
remote router ID	IP address of the neighbor. BGP uses the highest loopback address as the Router ID. If no loopback interface is configured, BGP uses the highest configured IP address on a system.
BGP state	Session state as explained in Table 7-23 . The exchange of routing information begins between peers only after the neighbor session is in an Established state.
up for	Time that the underlying TCP connection has been up.
last read	Time since BGP last received a message from this neighbor.
hold time	Time, in seconds, that BGP will maintain the session with this neighbor without receiving messages. The maximum time that can elapse between successive messages from this neighbor is 180 seconds. If no message is received for 180 seconds, this neighbor will be declared dead.
last write	Time since BGP last sent a message to this neighbor.
keepalive interval	Time interval, in seconds, at which keepalive messages are transmitted to this neighbor. The time interval between successive keepalive messages is 60 seconds. Typically, the hold time value is set to three times the keepalive interval.
neighbor capabilities	BGP capabilities advertised and received from this neighbor. "Advertised and received" is displayed when a capability is successfully exchanged between two routers.
received	Total number of received messages. notifications: Number of notification (error) messages received. in queue: Number of messages in the input queue
sent	Total number of sent messages. notifications: Number of notification (error) messages sent. in queue: Number of messages in the output queue
route refresh request	Number of route refresh request messages sent and received.
minimum time between advertisement runs.	The minimum time gap, in seconds, between successive route updates sent to the neighbor. Generally, a jitter (of 25%) is applied to this time interval, which means that if the time between advertisements is configured as 30, successive advertisements can have a time gap of as low as 22.5 (after applying a 25% jitter to the 30 seconds, which is 7.5 seconds).
for address family	The peers have exchanged address family capability.
BGP table version	For each of the address families agreed upon, BGP maintains a separate table.
neighbor version	Tracks prefixes that have been sent and those that need to be sent.
connections established	The number of times the router has established a TCP connection and the two peers have agreed to speak BGP with each other. "Dropped" means the number of time the connection has failed or gone down.

Table 7-18: show bgp neighbor output details

Field	Description
local host foreign host	Local host is the IP address and the port number of the local system used for the peering session. Foreign host is the IP address and the port of the neighbor. BGP always uses the TCP port number 179 for the peer originating the session.
nexthop	The IP address of the next hop used to reach the neighbor. eBGP or iBGP peers do not need to be directly connected. Peering sessions can be set up across multiple hops. If the neighbors are directly connected, the IP address of the local system is listed as the next hop.
nexthop global	The global IPv6 address of the next hop
nexthop local	The link-local IPv6 address of the next hop
non shared network	The peering session is running on a non shared network.
last reset	Time since this peering session was last reset. The reason for the reset is displayed on this line.
notification error message	Last error message sent.

show bgp neighbors advertised-routes

Use this command to display the routes advertised to a BGP neighbor.

Command Syntax

```
show bgp neighbors (A.B.C.D|X:X::X:X) advertised-routes
show ip bgp neighbors (A.B.C.D|X:X::X:X) advertised-routes (vrf
(VRFNAME|all|default))
show ip bgp neighbors (A.B.C.D|X:X::X:X) advertised-routes
show ip bgp ipv4 (unicast|multicast) neighbors (A.B.C.D|X:X::X:X) advertised-routes
```

Parameters

A.B.C.D	IPv4 neighbor
X:X::X:X	IPv6 neighbor
ipv4	IPv4 addresses
multicast	Multicast prefixes
unicast	Unicast prefixes
vrf	VPN Routing/Forwarding instance name

Command Mode

Privileged Exec mode and Exec mode

Applicability

This command was introduced before OcnOS version 1.3.

Example

```
#show bgp neighbors 11.11.11.2 advertised-routes
BGP table version is 3, local router ID is 1.1.1.1
Status codes: s suppressed, d damped, h history, * valid, > best, i - internal
Origin codes: i - IGP, e - EGP, ? - incomplete

Network          Next Hop          Metric      LocPrf      Weight      Path
*>i 33.33.33.33/32 11.11.11.1        0           100         32768       i

Total number of prefixes 1
```

show bgp neighbors received prefix-filter

Use this command to display the prefix list filter.

Command Syntax

```
show bgp neighbors (A.B.C.D|X:X::X:X) received prefix-filter
show ip bgp neighbors (A.B.C.D|X:X::X:X) received prefix-filter
show ip bgp ipv4 (unicast|multicast) neighbors (A.B.C.D|X:X::X:X) received prefix-
filter
```

Parameters

A.B.C.D	IPv4 address
X:X::X:X	IPv6 address
ipv4	IPv4 addresses
unicast	Unicast prefixes
multicast	Multicast prefixes

Command Mode

Privileged Exec mode and Exec mode

Applicability

This command was introduced before OcNOS version 1.3.

Example

```
#show bgp neighbors 100.1.1.1 received prefix-filter
Address family: IPv4 Unicast
ip prefix-list 100.1.1.1.1: 1 entries
  seq 5 permit 1.1.1.1/32
```

show bgp neighbors received-routes

Use this command to view all the received routes, including all AFI/SAFI routes, from a BGP neighbour. Executing this CLI displays the received routes from accessing:

- BGP local RIB or
- BGP ADJ_IN RIB only if the 'soft-reconfiguration inbound' feature is supported.

Command Syntax

```
show ip bgp neighbors (A.B.C.D|X:X::X:X) received-routes (vrf
(VRFNAME|all|default)|)
```

```
show ip bgp ipv4 (unicast|multicast) neighbors (A.B.C.D|X:X::X:X) received-routes
```

Parameters

A.B.C.D	IPv4 address
X:X::X:X	IPv6 address
ipv4	IPv4 addresses
unicast	Unicast prefixes
multicast	Multicast prefixes
VRFNAME	VPN Routing/Forwarding instance name
all	All VRFs
deault	Default VRF (Global routing)

Command Mode

Privileged Exec mode and Exec mode

Applicability

This command was introduced before OcNOS version 1.3. and updated in OcNOS version 6.3.1.

Example

```
DUT3 show bgp neighbors 77.242.226.32 received-routes
% Inbound soft reconfiguration is not supported, displaying the received routes from
accessing BGP local RIB
For address family: IPv4 Unicast
BGP table version is 610, local router ID is 14.14.14.14
Status codes: s suppressed, d damped, h history, a add-path, * valid, > best, i -
internal,
l - labeled, S Stale
Origin codes: i - IGP, e - EGP, ? - incomplete
Network Next Hop Metric LocPrf Weight Path
* i 20.20.20.0/24 77.242.226.32 0 100 0 ?
*>i 77.242.226.32/32 77.242.226.32 0 100 0 ?
*>i 200.10.1.0 77.242.226.32 0 100 0 ?
Total number of prefixes 3
For address family: VPNv4 Unicast
```

BGP Show Commands

Status codes: s suppressed, d damped, h history, a add-path, * valid, > best, i - internal, l - labeled

S Stale

Origin codes: i - IGP, e - EGP, ? - incomplete

Network Next Hop Metric LocPrf Weight Path

Route Distinguisher: 77.242.226.32:100

*>i 200.10.1.0 77.242.226.32 0 100 0 ?

Accepted routes count = 1

Route Distinguisher: 65535:22

*>i 10.50.100.160/30 10.10.40.133 0 100 0 ?

*>i 10.202.167.0/24 10.10.40.133 0 100 0 ?

Accepted routes count = 2

DUT#

DUT#sh bgp neighbors 10.10.40.133 received-routes | begin VPNv4

...skipping

For address family: VPNv4 Unicast

Status codes: s suppressed, d damped, h history, a add-path, * valid, > best, i - internal, l - labeled

S Stale

Origin codes: i - IGP, e - EGP, ? - incomplete

Network Next Hop Metric LocPrf Weight Path

Route Distinguisher: 65535:22

*>i 10.50.100.160/30 10.10.40.133 0 100 0 ?

*>i 10.202.167.0/24 10.10.40.133 0 100 0 ?

Accepted routes count = 2

To view the received-routes of particular address-family, use below filter.

"sh bgp neighbors 10.10.40.133 received-routes | begin LINE"

LINE can be of { IPv4 Unicast or

IPv4 Labeled-Unicast or

VPNv4 Unicast or

IPv6 Unicast or

6PE Labeled Unicast or

VPNv6 Unicast

}

show bgp neighbors routes

Use this command to display all accepted routes learned from neighbors.

Command Syntax

```
show bgp neighbors (A.B.C.D|X:X::X:X) routes
show ip bgp neighbors (A.B.C.D|X:X::X:X) routes
show ip bgp ipv4 (unicast|multicast) neighbors (A.B.C.D|X:X::X:X) routes
```

Parameters

A.B.C.D	IPv4 address
X:X::X:X	IPv6 address
ipv4	IPv4 addresses
unicast	Unicast prefixes
multicast	Multicast prefixes

Command Mode

Privileged Exec mode and Exec mode

Applicability

This command was introduced before OcnOS version 1.3.

Example

The following output displays detailed information about the neighbor.

```
#show bgp neighbors 10.10.10.2 routes
BGP neighbor is fe80::203:47ff:feb0:d72b, remote AS 10, local AS 10, internal
link
  BGP version 4, remote router ID 10.10.10.50
  BGP state = Established, up for 00:02:01
  Last read 00:00:01, hold time is 180, keepalive interval is 60 seconds
  Neighbor capabilities:
    Route refresh: advertised and received (old and new)
    Address family IPv4 Unicast: advertised and received
    Address family IPv6 Unicast: advertised and received
  Received 3 messages, 0 notifications, 0 in queue
  Sent 5 messages, 0 notifications, 0 in queue
  Route refresh request: received 0, sent 0
  Minimum time between advertisement runs is 5 seconds
For address family: IPv4 Unicast
  Community attribute sent to this neighbor (both)
  0 accepted prefixes
  0 announced prefixes
```

Table 7-19 explains the output fields.

Table 7-19: show bgp neighbors routes output details

Field	Description
BGP neighbor	Neighbor identifier along with the local and remote Autonomous System numbers.
BGP version	The version of BGP being used by the neighbor device, along with the remote router ID number.
BGP state	The current state of the neighbor connection and length of time within the current state. Possible states are: Idle, Connect, Active, and Established.
Last read	The amount of time in Hours: Minutes: Seconds since this device last checked the Hold Time parameters.
hold time	The amount of time this device waits for a Keepalive or Update message before the BGP connection is closed.
Keepalive interval	KEEPALIVE messages are sent periodically to ensure that the connection is live.
Neighbor capabilities	<p>New or optional parameters called "Capabilities." Provides a graceful way to advertise new or unique options without causing peering to terminate. The capabilities are communicated in TLV fields. (see RFC 3392).</p> <p>In the example output above, the following capabilities were advertised by the neighbor and were received and understood by this device:</p> <ol style="list-style-type: none"> 1. Route refresh 2. Address family IPv4 Unicast 3. Address family IPv6 Unicast
Route refresh	This helps to identify that and synchronize the peers without a hard reset.
For address family	Address Family Identifier (AFI) IPv4 Unicast.
Received messages	Information received from the neighbors.
notifications	Passes information to a router about sessions.
in que	Number of messages currently residing in the queue awaiting action.
Route refresh request	Information received and sent.
Minimum time between advertisement runs	Interval between exchange of messages.
For address family: IPv4 Unicast	The following three values are subordinate to the IPv4 Unicast Address Family.
Community attributes sent to this neighbor	Both the standard and the extended community information has been sent to the neighbor.
accepted prefixes	Configure a limit to the number of prefixes that can be accepted in a BGP peer session.
announced prefixes	A prefix announced in BGP consists of the IPV4 or IPV6 address block being announced.

show bgp nexthop-tracking

Use this command to display BGP nexthop-tracking status.

Command Syntax

```
show bgp nexthop-tracking
```

Parameters

None

Command Mode

Privileged Exec mode and Exec mode

Applicability

This command was introduced before OcnOS version 1.3.

Example

```
#show bgp nexthop-tracking

Configured NHT: ENABLED
NHT Delay time-interval : 6
BGP VRF: (Default) VRF_ID 0
BGP Instance: (Default), AS: 100, router-id 4.4.4.40
NHT is Enabled
Rcvd Msg count from RIB: 0
NHT delay-timer remaining seconds: 0
BGP nexthop(s):
Total number of IPV4 nexthops : 0
Total number of IPV6 nexthops : 0

BGP VRF: VRF_A VRF_ID 2
BGP Instance: (Default), AS: 100, router-id 4.4.4.40
NHT is Enabled
Rcvd Msg count from RIB: 0
NHT delay-timer remaining seconds: 0
BGP nexthop(s):
Total number of IPV4 nexthops : 0
Total number of IPV6 nexthops : 0
```

[Table 7-20](#) explains the output fields.

Table 7-20: show bgp nexthop-tracking output details

Field	Description
Configured NHT	Whether Next Hop Tracking (NHT) is enabled or disabled.
NHT Delay time-interval	A delay timer that indicates how long this device waits before checking its RIB for changes.

Table 7-20: show bgp nexthop-tracking output details

Field	Description
BGP VRF	Name and ID number of this BGP VRF.
BGP Instance	Autonomous System number and router ID.
NHT is Enabled	NHT Network enables the measurement and comparison of performance.
Recvd Msg count from RIB	Number of received change-messages from the RIB.
NHT delay-timer remaining seconds	Time remaining until the next decision cycle.
BGP nexthop(s)	Nexthop in the BGP to reach a certain destination.
Total number of IPV4 nexthops	Number of nexthops in the IPv4 Address Family.
Total number of IPV6 nexthops	Number of nexthops in the IPv6 Address Family.

show bgp nexthop-tree-details

Use this command to display BGP nexthop-tree details.

Command Syntax

```
show bgp nexthop-tree-details
```

Parameters

None

Command Mode

Privileged Exec mode and Exec mode

Applicability

This command was introduced before OcNOS version 1.3.

Example

```
#show bgp nexthop-tree-details
BGP Instance: (Default), AS: 65534, router-id 51.1.1.3
AFI_IP Nexthop count : 0
AFI_IP6 Nexthop count : 0

BGP Instance: (Default), AS: 0, router-id 51.1.1.3
AFI_IP Nexthop count : 0
AFI_IP6 Nexthop count : 0
```

[Table 7-21](#) explains the output fields.

Table 7-21: show bgp nexthop-tree-details output details

Field	Description
Bgp Instance	The Autonomous System number and router ID.
AFI_IP Nexthop count	Nexthop count for the IPv4 Address Family
AFI_IP6 Nexthop count	Nexthop count for the IPv6 Address Family

show bgp paths

Use this command to display BGP path information.

Command Syntax

```
show bgp paths
show bgp (ipv6) paths
show ip bgp paths
show ip bgp ipv4 (unicast|multicast) paths
```

Parameters

ipv4	IPv4 routes
ipv6	IPv6 routes
unicast	Unicast prefixes
multicast	Multicast prefixes

Command Mode

Privileged Exec mode and Exec mode

Applicability

This command was introduced before OcNOS version 1.3.

Example

```
#show bgp paths

Address          Refcnt    Path
[0x1af8ee0:0]    (21)
[0x1b3ceb0:345] (14)      64602
[0x1c71d40:821] (12008)  64602 65500
[0x1d03fb0:822] (12008)  64602 65501
```

[Table 7-22](#) explains the output fields.

Table 7-22: show bgp paths output details

Field	Description
Address	Hash and hash key separated by the colon character.
Refcnt	Number of routed using that path.
Path	Autonomous System Number (ASN) for the route.

show bgp prefix-list

Use this command to display routes matching the prefix-list.

Command Syntax

```
show bgp prefix-list WORD
show bgp (ipv4|ipv6) (unicast|multicast|) prefix-list WORD (vrf
(VRFNAME|all|default|))
show ip bgp prefix-list WORD
show ip bgp prefix-list WORD (exact-match)
show ip bgp prefix-list WORD (exact-match) (vrf (VRFNAME|all|default))
show ip bgp ipv4 (unicast|multicast) prefix-list WORD
show ip bgp ipv4 (unicast|multicast) prefix-list WORD (exact-match)
```

Parameters

WORD	Name of the IP prefix list
ipv4	IPv4 routes
ipv6	IPv6 routes
unicast	Unicast prefixes
multicast	Multicast prefixes
exact-match	Exact match of the prefix list
vrf	VPN Routing/Forwarding instance
VRFNAME	VPN routing/forwarding instance name
all	All VRFs
default	Default VRF

Command Mode

Privileged Exec mode and Exec mode

Applicability

This command was introduced before OcnOS version 1.3.

Example

```
#show ip bgp prefix-list Routel
BGP table version is 1, local router ID is 12.0.0.1
Status codes: s suppressed, d damped, h history, * valid, > best, i -
internal,
                l - labeled, S Stale
Origin codes: i - IGP, e - EGP, ? - incomplete

Network          Next Hop          Metric      LocPrf      Weight      Path
*>1.1.1.1/32     0.0.0.0           0           100         32768       i

Total number of prefixes 1
```

show bgp quote-regexp

Use this command to display route matching an AS path quoted regular expression.

Command Syntax

```
show bgp quote-regexp WORD
show bgp (ipv4|ipv6) (unicast|multicast|) quote-regexp WORD
show ip bgp quote-regexp WORD
show ip bgp ipv4 (unicast|multicast) quote-regexp WORD
```

Parameters

WORD	A regular expression to match the AS paths. Use quotes to enclose the regular expression.
ipv4	IPv4 route information
ipv6	IPv6 route information
unicast	Unicast prefixes
multicast	Multicast prefixes

Command Mode

Privileged Exec mode and Exec mode

Applicability

This command was introduced before OcnOS version 1.3.

Example

```
#show bgp quote-regexp ^$
BGP table version is 1, local router ID is 102.67.98.95
Status codes: s suppressed, d damped, h history, * valid, > best, i -
internal,
                l - labeled, S Stale
Origin codes: i - IGP, e - EGP, ? - incomplete

Network          Next Hop      Metric    LocPrf     Weight    Path
*> 2001:43f8:bb1::/64      :              0         100       32768     ?

Total number of prefixes 1
```

show bgp regexp

Use this command to display routes matching the AS path regular expression.

Command Syntax

```
show bgp regexp LINE
show bgp (ipv4|ipv6) (unicast|multicast) regexp LINE
show bgp (ipv6) regexp LINE
show ip bgp regexp LINE
show ip bgp vrf (VRFNAME|all|default) regexp LINE
show ip bgp ipv4 (unicast|multicast) regexp LINE
```

Parameters

ipv4	IPv4 routes
ipv6	IPv6 routes
unicast	Unicast prefixes
multicast	Multicast prefixes
LINE	A regular expression to match the AS paths
VRFNAME	VPN routing/forwarding instance name
all	All VRFs
default	Default VRF

Command Mode

Privileged Exec mode and Exec mode

Applicability

This command was introduced before OcnOS version 1.3.

Example

```
#show bgp regexp ^$
BGP table version is 1, local router ID is 102.67.98.95
Status codes: s suppressed, d damped, h history, * valid, > best, i -
internal,
                l - labeled, S Stale
Origin codes: i - IGP, e - EGP, ? - incomplete

Network          Next Hop      Metric      LocPrf      Weight      Path
*> 2001:43f8:bb1::/64    ::          0           100         32768       ?

Total number of prefixes 1
```

show bgp route-map

Use this command to display routes that match the specified route map.

Command Syntax

```
show bgp route-map WORD
show bgp (ipv4|ipv6) (unicast|multicast) route-map WORD
show bgp (ipv6) route-map WORD
show ip bgp route-map WORD
show ip bgp route-map WORD (vrf (VRFNAME|all|default))
show ip bgp ipv4 (unicast|multicast) route-map WORD
```

Parameters

WORD	Routes matching the route-map
ipv4	IPv4 routes
ipv6	IPv6 routes
unicast	Unicast prefixes
multicast	Multicast prefixes
vrf	VPN routing/forwarding instance
VRFNAME	VPN routing/forwarding instance name
all	All VRFs
default	Default VRF

Command Mode

Privileged Exec mode and Exec mode

Applicability

This command was introduced before OcNOS version 1.3.

Example

```
#show ip bgp prefix-list Route1
BGP table version is 1, local router ID is 12.0.0.1
Status codes: s suppressed, d damped, h history, * valid, > best, i -
internal,
                l - labeled, S Stale
Origin codes: i - IGP, e - EGP, ? - incomplete

Network        Next Hop          Metric    LocPrf      Weight    Path
*>1.1.1.1/32    0.0.0.0           0         100         32768     i
```

show bgp statistics

Use this command to display BGP statistics.

Command Syntax

```
show bgp statistics
```

Parameters

None

Command Mode

Privileged Exec and Exec mode

Applicability

This command was introduced before OcNOS version 1.3.

Examples

```
#show bgp statistics
```

```
=====
BGP VRF default statistics
=====
Neighbor aggregated statistics (sent/received)
Msgs          Bytes          Opens          Updates
16/17         394/0          1/2            0/0
Keepalives    Notifications  Route-refresh  Capabilities
15/15         0/0            0/0            0/0
BGP I/O Information
Active Open attempts      : 0
Passive Open attempts     : 0
BGP I/O Open loops        : 0
BGP I/O Open calls        : 0
BGP I/O Open rcv calls    : 0
BGP I/O Send calls        : 0
BGP I/O Recv calls        : 0
BGP I/O Write calls       : 0
BGP I/O Write loops       : 0
BGP I/O Write loop yields : 0
BGP I/O Read calls        : 0
BGP I/O Read loops        : 0
BGP I/O Read loop yields  : 0
BGP I/O process nlri yields : 0
BGP I/O process withdraw yields : 0
BGP Read time exceeded    : 0
BGP Update send pending   : 0
BGP Update buffer not available : 0
BGP Update walk suspended : 0
BGP Yielded in updates    : 0
BGP Yielded in packing    : 0
BGP No sendbuf for peer   : 0
BGP No withdraw buf for peer : 0
BGP Yields in update peer loop : 0
```

BGP Show Commands

```
No updates pending or no buffers: 0
No data to write                   : 0
Msg queue recv errors              : 0
Sockets create/accept/close       : 2/1/2
Sockets create retries/failures   : 1/0
Socket fd-close session            : 0
MemPool - Advertise                : | Total (0/0) blk_size:64
MemPool - AdjOut                   : | Total (0/0) blk_size:12
MemPool - Advertise Attr           : | Total (0/0) blk_size:24
MemPool - BGP Info                 : | Total (0/0) blk_size:216
MemPool - BGP Attr                 : | Total (0/0) blk_size:224
MemPool - BGP Node IPv4            : | Total (0/0) blk_size:128
MemPool - BGP Node IPv6           : | Total (0/0) blk_size:136
MemPool - BGP Node EVPN           : | Total (0/0) blk_size:160
MemPool - BGP Node Max KeyLen     : | Total (0/0) blk_size:176
MemPool - BGP RIB msg4             : | Total (0/0) blk_size:4440
MemPool - BGP RIB msg6            : | Total (0/0) blk_size:424
MemPool - BGP MPLS REQ             : | Total (0/0) blk_size:32
#
```

show bgp summary

Use this command to display a summary of BGP neighbor status.

Command Syntax

```
show bgp summary
show bgp (ipv4|ipv6) (unicast|multicast|) summary
show ip bgp summary
show ip bgp summary (vrf (VRFNAME|all|default))
show ip bgp ipv4 (unicast|multicast) summary
```

Parameters

ipv4	IPv4 routes
ipv6	IPv6 routes
unicast	Unicast prefixes
multicast	Multicast prefixes
VRFNAME	VPN routing/forwarding instance name
all	All VRFs
default	Default VRF

Command Mode

Privileged Exec mode and Exec mode

Applicability

This command was introduced before OcNOS version 1.3.

Example

```
#show bgp summary
```

```
BGP router identifier 6.6.6.6, local AS number 64601
```

```
BGP table version is 1
```

```
1 BGP AS-PATH entries
```

```
0 BGP community entries
```

Neighbor	V	AS	MsgRcv	MsgSen	TblVer	InQ	OutQ	Up/Down	State/PfxRcd
*12.1.1.24		64902	7	7	1	0	0	00:02:54	0

```
* Dynamically created based on a listen range command
```

```
BGP dynamic peer-group: group1
```

BGP Show Commands

```
listen range: 12.1.0.0/16
Total number of dynamically created neighbors/limit: 1/(200)
Total number of dynamically created neighbors: 1
Total number of activated dynamic peer-groups for IPv4 Unicast address-family:
Total number of neighbors 1
Total number of Established sessions 1

BGP dynamic peer-group: group2
listen range: 12.2.0.0/16
Total number of dynamically created neighbors/limit: 0/(200)
Total number of dynamically created neighbors: 0
Total number of activated dynamic peer-groups for IPv4 Unicast address-family: 1
```

Header

```
BGP router identifier 10.10.15.50, local AS number 65000
1 BGP AS-PATH entries
0 BGP community entries
```

- The BGP router identifier is 10.10.15.50 and the local router AS number is 65000.
- The BGP table version tracks the local BGP table version. Any time the BGP best path algorithm executes, the table version increments.
- There is one BGP AS-PATH entry and no community entries.

Neighbor Entry Fields

[Table 7-23](#) explains the fields for each neighbor entry.

Table 7-23: neighbor entry fields

Field	Description
Neighbor	IP address of peer.
V	BGP version of peer.
AS	Autonomous system number of peer.
MsgRcvd	Messages received since the BGP connection was established.
MsgSent	Messages sent since the BGP connection was established.
TblVer	Last version of the local router's BGP database advertised to the peer.
InQ	Received messages waiting in the input queue for further processing.
OutQ	Messages waiting in the output queue to be sent.

Table 7-23: neighbor entry fields (Continued)

Field	Description
Up/Down	Connection up time and down time.
State/PfxRcd	<p>If the TCP session is up and the BGP peers have formed an adjacency, this field shows how many prefixes have been received from the remote neighbor.</p> <p>Other states:</p> <p>Idle: The local router has not allocated resources for the peer connection, so incoming connection requests are refused</p> <p>Idle (Admin): The peer has shut down</p> <p>Idle (PfxCt): Prefix overflow</p> <p>Idle (G-shut): Graceful shutdown</p> <p>Connect: BGP is waiting for the TCP connection to complete</p> <p>Active: the local router is trying to establish a TCP connection to the remote peer. You might see this if the local peer has been configured, but the remote peer is unreachable or has not been configured.</p> <p>OpenSent: BGP is waiting for an open message from its peer</p> <p>OpenConfirm: BGP received an open message from the peer and is now waiting for a keepalive or notification message. If BGP receives a keepalive message from the peer, the state changes to established. If the message is a notification, the state changes to idle.</p> <p>Established: BGP is ready to exchange update, notification, and keepalive messages with its peer</p> <p>Invalid: The session state is invalid</p>

Neighbor Entry Example

```
10.10.14.51 4 100 93 120 0 0 0 00:42:16 0
```

- The neighbor has the IP address 10.10.14.51 and AS number 100.
- The neighbor uses BGP version 4.
- 93 messages have been received.
- 120 messages have been sent.
- The BGP routing table version is 0.
- There are no received messages waiting in the input queue for further processing.
- There are no messages waiting in the output queue to be sent.
- The connection has been up for 0 hours, 42 minutes and 53 seconds.
- The local router has received no prefixes from this neighbor.

show bgp X:X::X:X

Use this command to display BGP network information in an IPv6 environment.

Command Syntax

```
show bgp X:X::X:X
show bgp (ipv6) X:X::X:X
show bgp (ipv6) (unicast|multicast) X:X::X:X
```

Parameters

ipv6	IPv6 routes
unicast	Unicast prefixes
multicast	Multicast prefixes
X:X::X:X	IPv6 prefix (network), for example, 2003::

Command Mode

Privileged Exec mode and Exec mode

Applicability

This command was introduced before OcNOS version 1.3.

Example

```
#show bgp ipv6 6666::/64
BGP routing table entry for 6666::/64
Paths: (1 available, best #1, table Default-IP-Routing-Table)
  Advertised to peer-groups:
    Book-v6
    Local
      :: from :: (102.67.98.95)
        Origin incomplete,metric 0, localpref 100, weight 32768      valid,
sourced, best, source safi: 0
        Community: 37721:2000
        Last update: Thu Feb  4 09:00:50 2021
```

show bgp X:X::X:X/M longer prefixes

Use this command to display BGP network information along with mask information.

Command Syntax

```
show bgp X:X::X:X/M longer-prefixes
```

Parameters

X:X::X:X/M IPv6 prefix (network/length), for example, 2003::/16

Command Mode

Privileged Exec mode and Exec mode

Applicability

This command was introduced before OcnOS version 1.3.

Examples

```
#show bgp 2001:43f8:bb1::/64 longer-prefixes
BGP table version is 1, local router ID is 102.67.98.95
Status codes: s suppressed, d damped, h history, * valid, > best, i -
internal,
                l - labeled, S Stale
Origin codes: i - IGP, e - EGP, ? - incomplete

Network          Next Hop      Metric      LocPrf      Weight      Path
*>2001:43f8:bb1::/64    ::          0           100         32768       ?

Total number of prefixes 1
```

show debugging bgp

Use this command to display BGP debugging options.

Command Syntax

```
show debugging bgp
```

Parameters

None

Command Mode

Privileged Exec mode and Exec mode

Applicability

This command was introduced before OcNOS version 1.3.

Example

This is a sample output from the show debugging bgp command.

```
#show debugging bgp
BGP debugging status:
  BGP debugging is on
  BGP events debugging is on
  BGP updates debugging is on
  BGP fsm debugging is on
```

show ip bgp

Use this command to display BGP routes.

Command Syntax

```
show ip bgp
show ip bgp ipv4 (unicast|multicast) (vrf (VRFNAME|all|default))
```

Parameters

ipv4	IPv4 routes
unicast	Unicast prefixes
multicast	Multicast prefixes
VRFNAME	VPN routing/forwarding instance name
all	All VRFs
default	Default VRF

Command Mode

Privileged Exec mode and Exec mode

Applicability

This command was introduced before OcnOS version 1.3.

Examples

This example shows routes learned from both iBGP and eBGP peers.

```
#show ip bgp
BGP table version is 0, local router ID is 10.100.0.77
Status codes: s suppressed, d damped, h history, * valid, > best, i - internal, S stale,
Origin codes: i - IGP, e - EGP, ? - incomplete
   Network          Next Hop          Metric LocPrf   Weight   Path
  *> 172.16.1.0/24   10.10.10.78              0         1 4 i
  *> 192.16.1.0     10.10.10.78          200         1 4 ?
  *                 10.100.0.62          100         3 4 ?
  *>i 192.17.1.0    10.100.0.62              100        0     i
```

Total number of prefixes 2

Header

BGP table version is 0, local router ID is 10.100.0.77

- The BGP table version tracks the local BGP table version. Any time the BGP best path algorithm executes, the table version increments.
- The Router ID of the local router is 10.100.0.77.

Status codes: s suppressed, d damped, h history, p stale, * valid, > best, i - internal

[Table 7-24](#) explains the status codes in the header.

Table 7-24: status codes

Status code	Description	Comments
s	suppressed	Whether the route is suppressed and will not be advertised to the neighbors.
d	damped	When the penalty of a flapping route exceeds the suppress limit, the route is damped and remains in a withdrawn state until its penalty decreases below the reuse limit.
h	history	When the penalty of a flapping route does not exceed the suppress limit, the route is not damped and BGP maintains a history of the flapping route.
p	stale	When the BGP neighbor from which a route is learned is in graceful restart, the route is retained in the BGP routing table, but marked as stale.
*	valid	Whether the route is valid. When a route is not suppressed, damped, or present in the history, it is valid.
>	best	The route selected as the best path and installed in the kernel routing table.
i	internal	Whether the route is learned from an iBGP peer. If this symbol is not present, the route was learned from an eBGP peer.

Origin codes: i - IGP, e - EGP, ? - incomplete

[Table 7-25](#) explains the codes are at the end of each routing entry that show where the route originated.

Table 7-25: origin codes

Origin code	Description	Comments
i	IGP	The route originated from an Interior Gateway Protocol.
e	EGP	The route originated from an Exterior Gateway Protocol.
?	incomplete	Origin not known. Typically, these are routes redistributed from an Interior Gateway Protocol.

Route Entry Fields

[Table 7-26](#) explains the fields shows for each route.

Table 7-26: route entry fields

Field	Description
Network	Network prefix installed in BGP. If multiple routes exist for the same prefix, only the first prefix is identified and others have blank spaces. The status codes are explained in Table 7-24 .
Next Hop	IP address of the nexthop for this route.
Metric	Multiple-Exit Discriminator (MED). If there are multiple paths to the same destination from a single routing protocol, then the multiple paths have the same administrative distance and the best path is selected based on this metric. The path with the lowest metric is selected as the optimal path and installed in the routing table.

Table 7-26: route entry fields (Continued)

Field	Description
LocPrf	Local preference set with the <code>set local-preference</code> command. This value is used only with iBGP sessions within the local autonomous system to determine if a route towards a destination is the “best” one. The path with the highest local preference is preferred.
Weight	This field applies only to routes within an individual router. If a route was learned from a peer, it has a default weight of 0. All routes generated by the local router have a weight of 32,768.
Path and origin	The autonomous systems through which the prefix advertisement passed. The origin codes are explained in Table 7-25

Route Entry Examples

```
*> 172.16.1.0/24      10.10.10.78                0   1 4 i
```

- The absence of status code “i” means the route is external and was learned from an eBGP peer.
- The “>” means this route is selected to be installed in the kernel routing table. Its network address is 172.16.1.0/24.
- The IP address of the nexthop for this route is 10.10.10.78.
- This route was learned from a peer, so it has a default weight of 0.
- The path “1 4” means the prefix advertisement passed through AS1 and AS4.
- The origin code “i” means the prefix was added by a network statement at an originating AS.

```
*> 192.16.1.0        10.10.10.78                200   0 1 4 ?
```

```
*                   10.100.0.62                100   0 3 4 ?
```

- The same prefix was learned from two different ASs, AS1 and AS3.
- The route learned from AS1 is chosen as the best route because AS1 has a lower Router ID (10.10.10.78) than AS2 (10.100.0.62). Although the metric of the route learned from AS1 is higher (200) than the route learned from AS3 (100), this attribute is not used in the best path selection decision because the metrics are compared only if the first (neighboring) AS is the same in the two paths.
- The origin code “?” indicates that the routes were learned through redistribution.

```
*>i192.17.1.0        10.100.0.62                100   0   i
```

- The route is learned through an iBGP peer as indicated by the status code “i”.
- The preference of the route, used only with the local AS, is 100 (the default value).

show ip bgp cidr-only

Use this command to display routes with non-natural network masks.

Command Syntax

```
show ip bgp cidr-only
show ip bgp ipv4 (unicast|multicast) cidr-only
```

Parameters

ipv4	IPv4 routes
unicast	Unicast prefixes
multicast	Multicast prefixes

Command Mode

Privileged Exec mode and Exec mode

Applicability

This command was introduced before OcnOS version 1.3.

Example

This is a sample output from the `show ip bgp cidr-only` command.

```
#show ip bgp cidr-only
BGP table version is 0, local router ID is 10.10.10.50
Status codes: s suppressed, d damped, h history, p stale, * valid, > best, i -
internal
Origin codes: i - IGP, e - EGP, ? - incomplete
   Network          Next Hop           Metric LocPrf Weight Path
*> 3.3.3.0/24       10.10.10.10         0 11 i
Total number of prefixes 2
```

show ip bgp community-info

Use this command to list all BGP community information.

Command Syntax

```
show ip bgp community-info
```

Parameters

None

Command Mode

Privileged Exec mode and Exec mode

Applicability

This command was introduced before OcNOS version 1.3.

Example

```
#show ip bgp community-info
Address Refcnt Community
[0x262a4c0] (1) 1:1
```

show ip bgp peer-group

Use this command to list the BGP peer group information in ipv4 unicast.

Command Syntax

```
show ip bgp peer-group (WORD|)
```

Parameters

WORD	Name of the peer group
------	------------------------

Command Mode

Privileged Exec mode and Exec mode

Applicability

This command was introduced before OcnOS version 1.3.

Example

```
#show ip bgp peer-group group1
BGP dynamic peer-group is group1, EBGP, remote AS 64902
  BGP dynamic peer-group group1 listen range group members:
  12.1.0.0/16
  BGP version 4
Minimum time between advertisement runs is 30 seconds
For address family: IPv4 Unicast
Peer-group member:
*12.1.1.2
Index 0, Offset 0, Mask 0x1
0 accepted prefixes, 0 announced prefixes
```

show ip bgp peer-group vrf all

Use this command to list all BGP peer group VRF information.

Command Syntax

```
show ip bgp peer-group vrf all
```

Parameters

None

Command Mode

Privileged Exec mode and Exec mode

Applicability

This command was introduced before OcNOS version 1.3.

Example

```
#show ip bgp peer-group vrf all
% VRF: VRF1

BGP dynamic peer-group is group2, EBGP, remote AS 64902
  BGP dynamic peer-group group2 listen range group members:
  12.2.0.0/16
  BGP version 4
  Minimum time between advertisement runs is 30 seconds
% VRF: management
Peer-Group not found

% VRF: default

BGP dynamic peer-group is group1, EBGP, remote AS 64902
  BGP dynamic peer-group group1 listen range group members:
  12.1.0.0/16
  BGP version 4
  Minimum time between advertisement runs is 30 seconds
  For address family: IPv4 Unicast
  Peer-group member:
  *12.1.1.2
  Index 0, Offset 0, Mask 0x1
  0 accepted prefixes, 0 announced prefixes
```

show ip bgp rtfiler all

Use this command to display route target filters sent and received.

Command Syntax

```
show ip bgp rtfiler all
```

Parameters

None

Command Mode

Privileged Exec mode and Exec mode

Applicability

This command was introduced before OcNOS version 1.3.

Example

```
#show ip bgp community-info
Address Refcnt Community
[0x262a4c0] (1) 1:1
```

show ip bgp scan

Use this command to display BGP scan status.

Command Syntax

```
show ip bgp scan
```

Parameters

None

Command Mode

Privileged Exec mode and Exec mode

Applicability

This command was introduced before OcNOS version 1.3.

Example

```
#show ip bgp scan
BGP VRF: (Default) VRF_ID 0
BGP scan interval is 60 secs
scan remain-time: 3 secs
Current BGP nexthop cache:
BGP connected route:
 10.10.10.0/24
 10.10.11.0/24
```

show ip bgp vpnv4

Use this command to display information relating to VPNv4.

Command Syntax

```
show ip bgp vpnv4 all
show ip bgp vpnv4 all A.B.C.D
show ip bgp vpnv4 all neighbors
show ip bgp vpnv4 all neighbors A.B.C.D
show ip bgp vpnv4 all neighbors A.B.C.D routes
show ip bgp vpnv4 all summary
show ip bgp vpnv4 all tags
show ip bgp vpnv4 rd WORD
show ip bgp vpnv4 rd WORD A.B.C.D
show ip bgp vpnv4 rd WORD label
show ip bgp vpnv4 rd WORD neighbors
show ip bgp vpnv4 rd WORD neighbors A.B.C.D
show ip bgp vpnv4 rd WORD summary
show ip bgp vpnv4 view WORD all
show ip bgp vpnv4 vrf NAME
show ip bgp vpnv4 vrf NAME A.B.C.D
show ip bgp vpnv4 vrf NAME label
show ip bgp vpnv4 vrf NAME summary
```

Parameters

all	Displays information about all VPNv4 NLRIs
A.B.C.D	Network
neighbors	TCP and BGP neighbor connections
A.B.C.D	Network
routes	Display routes learned from neighbor
summary	Summary display
tags	BGP tags for prefixes
rd	Route distinguisher
WORD	BGP view name
A.B.C.D	Network
label	MPLS Labels for prefixes
neighbors	TCP and BGP neighbor connections
A.B.C.D	Network
summary	Summary display

view	VPNv4 NLRI-specific information
WORD	BGP view name
vrf	VRF VPNv4 NLRIs
NAME	VPN Routing/Forwarding instance name
A.B.C.D	Network
label	MPLS Labels for prefixes
summary	Summary display

Command Mode

Privileged Exec mode and Exec mode

Applicability

This command was introduced before OcNOS version 1.3.

Example

This is a sample output from the `show ip bgp vpnv4 all` command displaying VPNv4 specific information

```
#show ip bgp vpnv4 all
  Network                Next Hop                Metric LocPrf Weight Path
Route Distinguisher: 100:1 (VRF1)
* i 10.10.9.0/24          10.10.0.1                0     141         0 65000 ?
*> 10.10.9.0/24          10.10.14.50              0
*> 10.10.10.0/24         10.10.14.50              0
* i 10.10.15.0/24        10.10.0.1                0     141         0 65000 ?
*> 10.10.15.0/24        10.10.14.50              0
```

```
#show ip bgp vpnv4 all neighbors
```

```
BGP neighbor is 24.10.10.2, remote AS 65000, local AS 65000, internal link
  BGP version 4, remote router ID 179.112.0.1
  BGP state = Established, up for 10:04:14
  Last read 10:04:14, hold time is 90, keepalive interval is 30 seconds
  Neighbor capabilities:
    Route refresh: advertised and received (new)
    Address family IPv4 Unicast: advertised and received
    Address family IPv4 Multicast: received
    Address family IPv6 Unicast: received
  Received 1641 messages, 0 notifications, 0 in queue
  Sent 1280 messages, 0 notifications, 0 in queue
  Route refresh request: received 0, sent 0
  Minimum time between advertisement runs is 5 seconds
  For address family: IPv4 Unicast
    BGP table version 676, neighbor version 676
    Index 2, Offset 0, Mask 0x4
    Community attribute sent to this neighbor (both)
    60000 accepted prefixes
    0 announced prefixes

  Connections established 2; dropped 1
  Local host: 24.10.10.1, Local port: 179
  Foreign host: 24.10.10.2, Foreign port: 32959
  Nexthop: 24.10.10.1
```

```

Nexthop global: ::
Nexthop local: ::
BGP connection: non shared network

```

Table 7-27 explains the fields shows for each route.

Table 7-27: show ip bgp vpnv4 all neighbors output details

Field	Description
BGP neighbor	Router ID of the BGP neighbor.
remote AS	Autonomous system number of the neighbor.
local AS	Autonomous system number of the local system.
internal link	internal link: iBGP neighbor (in the same AS).
BGP version	The version of BGP being used by the neighbor device.
BGP state	The current state of the neighbor connection and length of time within the current state. Possible states are: Idle, Connect, Active, and Established.
Last read	The amount of time in Hours : Minutes : Seconds since this device last checked the Hold Time parameters.
hold time	The amount of time this device waits for a Keepalive or Update message before the BGP connection is closed.
Keepalive interval	KEEPALIVE messages are sent periodically to ensure that the connection is live.
Neighbor capabilities	<p>New or optional parameters called "Capabilities." Provides a graceful way to advertise new or unique options without causing peering to terminate. The capabilities are communicated in TLV fields. (see RFC 3392).</p> <p>In the example output above, the following capabilities were advertised by the neighbor and were received and understood by this device:</p> <ol style="list-style-type: none"> 1. Route refresh 2. Address family IPv4 Unicast 3. Address family IPv6 Unicast
Received	Message count, notification count, number of messages waiting in the queue.
Sent	Message count, notification count, number of messages waiting in the queue.
Route refresh request	Route requests sent and received.
For address family	As stated – in this case IPv4 Unicast.
BGP table version	For each of the address families agreed upon, BGP maintains a separate table.
neighbor version	Tracks prefixes that have been sent and those that need to be sent.
connections established	The number of times the router has established a TCP connection and the two peers have agreed to speak BGP with each other. "Dropped" means the number of time the connection has failed or gone down.

Table 7-27: show ip bgp vpnv4 all neighbors output details (Continued)

Field	Description
local host foreign host	Local host is the IP address and the port number of the local system used for the peering session. Foreign host is the IP address and the port of the neighbor. BGP always uses the TCP port number 179 for the peer originating the session.
nexthop	The IP address of the next hop used to reach the neighbor. eBGP or iBGP peers do not need to be directly connected. Peering sessions can be set up across multiple hops. If the neighbors are directly connected, the IP address of the local system is listed as the next hop.
nexthop global	The global IPv6 address of the next hop
nexthop local	The link-local IPv6 address of the next hop
non shared network	The peering session is running on a non shared network.
last reset	Time since this peering session was last reset. The reason for the reset is displayed on this line.
notification error message	Last error message sent.

show ip bgp vpnv6 all neighbors

Use this command to display VPNv6 NLRI information for all neighbors or for a given neighbor.

Command Syntax

```
show ip bgp vpnv6 all neighbors
show ip bgp vpnv6 all neighbors (A.B.C.D|X:X::X:X)
```

Parameters

A.B.C.D	IPv4 neighbor address
X:X::X:X	IPv6 neighbor address

Command Mode

Privileged Exec mode and Exec mode

Applicability

This command was introduced in OcNOS version 3.0.

Example

```
#show ip bgp vpnv6 all neighbors
BGP neighbor is 10.32.0.3, remote AS 1, local AS 1, internal link
  BGP version 4, local router ID 10.32.0.2, remote router ID 10.32.0.3
  BGP state = Established, up for 00:37:31
  Last read 00:00:09, hold time is 90, keepalive interval is 30 seconds
  Neighbor capabilities:
    Route refresh: advertised and received (old and new)
    Address family IPv4 Unicast: advertised and received
    Address family VPNv4 Unicast: advertised and received
    Address family VPNv6 Unicast: advertised and received
  Received 25711 messages, 0 notifications, 0 in queue
  Sent 25673 messages, 1 notifications, 0 in queue
  Route refresh request: received 0, sent 0
  Minimum time between advertisement runs is 5 seconds
  Update source is lo
For address family: IPv4 Unicast
  BGP table version 1, neighbor version 1
  Index 1, Offset 0, Mask 0x2
  Community attribute sent to this neighbor (both)
  0 accepted prefixes
  0 announced prefixes

For address family: VPNv4 Unicast
  BGP table version 837, neighbor version 837
  Index 1, Offset 0, Mask 0x2
  Community attribute sent to this neighbor (both)
  0 accepted prefixes
  0 announced prefixes
```

```
For address family: VPNv6 Unicast
  BGP table version 302, neighbor version 302
  Index 1, Offset 0, Mask 0x2
  Community attribute sent to this neighbor (both)
  0 accepted prefixes
  0 announced prefixes

Connections established 2; dropped 1
Local host: 10.32.0.2, Local port: 179
Foreign host: 10.32.0.3, Foreign port: 38416
Nexthop: 10.32.0.2
Nexthop global: ::
Nexthop local: ::
BGP connection: non shared network
Last Reset: 00:37:34, due to Hold Timer Expired (Notification sent)
Notification Error Message: (Hold Timer Expired/No sub-error code)

BGP neighbor is 101.101.1.2, vrf 1, remote AS 101, local AS 1, external link
  BGP version 4, local router ID 101.101.1.1, remote router ID 0.0.0.0
  BGP state = Idle
  Last read          , hold time is 90, keepalive interval is 30 seconds
  Received 512 messages, 0 notifications, 0 in queue
  Sent 450 messages, 0 notifications, 0 in queue
  Route refresh request: received 0, sent 0
  Minimum time between advertisement runs is 30 seconds
For address family: IPv4 Unicast
  BGP table version 27, neighbor version 0
  Index 1, Offset 0, Mask 0x2
  Community attribute sent to this neighbor (standard)
  0 accepted prefixes
  0 announced prefixes

Connections established 1; dropped 1

BGP neighbor is 101.102.1.2, vrf 2, remote AS 102, local AS 1, external link
  BGP version 4, local router ID 101.102.1.1, remote router ID 0.0.0.0
  BGP state = Idle
  Last read          , hold time is 90, keepalive interval is 30 seconds
  Received 511 messages, 0 notifications, 0 in queue
  Sent 449 messages, 0 notifications, 0 in queue
  Route refresh request: received 0, sent 0
  Minimum time between advertisement runs is 30 seconds
For address family: IPv4 Unicast
  BGP table version 26, neighbor version 0
  Index 1, Offset 0, Mask 0x2
  Community attribute sent to this neighbor (standard)
  0 accepted prefixes
  0 announced prefixes
```

BGP Show Commands

Connections established 1; dropped 1

BGP neighbor is 101.103.1.2, vrf 3, remote AS 103, local AS 1, external link
BGP version 4, local router ID 101.103.1.1, remote router ID 0.0.0.0
BGP state = Idle
Last read , hold time is 90, keepalive interval is 30 seconds
Received 511 messages, 0 notifications, 0 in queue
Sent 452 messages, 0 notifications, 0 in queue
Route refresh request: received 0, sent 0
Minimum time between advertisement runs is 30 seconds
For address family: IPv4 Unicast
BGP table version 26, neighbor version 0
Index 1, Offset 0, Mask 0x2
Community attribute sent to this neighbor (standard)
0 accepted prefixes
0 announced prefixes

Connections established 1; dropped 1

BGP neighbor is 101.104.1.2, vrf 4, remote AS 104, local AS 1, external link
BGP version 4, local router ID 101.104.1.1, remote router ID 0.0.0.0
BGP state = Connect
Last read , hold time is 90, keepalive interval is 30 seconds
Received 511 messages, 0 notifications, 0 in queue
Sent 449 messages, 0 notifications, 0 in queue
Route refresh request: received 0, sent 0
Minimum time between advertisement runs is 30 seconds
For address family: IPv4 Unicast
BGP table version 27, neighbor version 0
Index 1, Offset 0, Mask 0x2
Community attribute sent to this neighbor (standard)
0 accepted prefixes
0 announced prefixes

Connections established 1; dropped 1

Next connect timer due in 108 seconds

BGP neighbor is 101.105.1.2, vrf 5, remote AS 105, local AS 1, external link
BGP version 4, local router ID 101.105.1.1, remote router ID 0.0.0.0
BGP state = Idle
Last read , hold time is 90, keepalive interval is 30 seconds
Received 511 messages, 0 notifications, 0 in queue
Sent 454 messages, 0 notifications, 0 in queue
Route refresh request: received 0, sent 0
Minimum time between advertisement runs is 30 seconds
For address family: IPv4 Unicast
BGP table version 26, neighbor version 0
Index 1, Offset 0, Mask 0x2
Community attribute sent to this neighbor (standard)
0 accepted prefixes

0 announced prefixes

Connections established 1; dropped 1

show ip bgp vpnv6 rd neighbors

Use this command to display VPNv6 NLRI information for a given route distinguisher and optionally for a given neighbor.

Command Syntax

```
show ip bgp vpnv6 rd WORD neighbors
show ip bgp vpnv6 rd WORD neighbors (A.B.C.D|X:X::X:X)
```

Parameters

WORD	Route distinguisher
A.B.C.D	IPv4 neighbor address
X:X::X:X	IPv6 neighbor address

Command Mode

Privileged Exec mode and Exec mode

Applicability

This command was introduced in OcNOS version 3.0.

Example

```
#show ip bgp vpnv6 rd 1:1 neighbors
BGP neighbor is 10.32.0.3, remote AS 1, local AS 1, internal link
  BGP version 4, local router ID 10.32.0.2, remote router ID 10.32.0.3
  BGP state = Established, up for 00:43:57
  Last read 00:00:08, hold time is 90, keepalive interval is 30 seconds
  Neighbor capabilities:
    Route refresh: advertised and received (old and new)
    Address family IPv4 Unicast: advertised and received
    Address family VPNv4 Unicast: advertised and received
    Address family VPNv6 Unicast: advertised and received
  Received 25726 messages, 0 notifications, 0 in queue
  Sent 25689 messages, 1 notifications, 0 in queue
  Route refresh request: received 0, sent 0
  Minimum time between advertisement runs is 5 seconds
  Update source is lo
For address family: IPv4 Unicast
  BGP table version 1, neighbor version 1
  Index 1, Offset 0, Mask 0x2
  Community attribute sent to this neighbor (both)
  0 accepted prefixes
  0 announced prefixes

For address family: VPNv4 Unicast
  BGP table version 837, neighbor version 837
  Index 1, Offset 0, Mask 0x2
  Community attribute sent to this neighbor (both)
```

0 accepted prefixes
0 announced prefixes

For address family: VPNv6 Unicast
BGP table version 302, neighbor version 302
Index 1, Offset 0, Mask 0x2
Community attribute sent to this neighbor (both)
0 accepted prefixes
0 announced prefixes

Connections established 2; dropped 1

show ip extcommunity-list

Use this command to display BGP routes that match an extended community list.

Command Syntax

```
show ip extcommunity-list (WORD | )
show ip extcommunity-list (<1-199>|WORD)
show ip bgp extcommunity-list WORD (exact-match|)(vrf VRFNAME|)
```

Parameters

WORD	Name of extended community list
<1-199>	Number of extended community list
VRFNAME	VPN routing/forwarding instance name

Command Mode

Privileged Exec mode and Exec mode

Applicability

This command was introduced before OcNOS version 1.3.

Example

```
#show ip extcommunity-list test
Named extended community expanded list test
  permit rt 100:100
```

show ip protocols

Use this command to display information about the IP protocols such as IP routing process parameters and statistics.

Command Syntax

```
show ip protocols
show ip protocols bgp
```

Parameters

bgp BGP information

Command Mode

Privileged Exec mode and Exec mode

Applicability

This command was introduced before OcNOS version 1.3.

Example

```
#show ip protocols bgp
Routing Protocol is "bgp 100"
Sending updates every 30 seconds with +/-50%, next due in 12 seconds
Timeout after 180 seconds, garbage collect after 120 seconds
Outgoing update filter list for all interface is not set
Incoming update filter list for all interface is not set
Default redistribution metric is 1
Redistributing: connected static
Default version control: send version 2, receive version 2
Interface      Send  Recv  Key-chain
eth0           2     2
Routing for Networks:
 10.10.0.0/24
Routing Information Sources:
 Gateway      BadPackets BadRoutes  Distance Last Update
Distance: (default is 120)
```

[Table 7-28](#) explains the fields shows for each route.

Table 7-28: show ip protocols output details

Field	Description
Routing Protocol is "bgp 100"	Specifies the routing protocol used.
Sending updates every 30 seconds	Specifies the time between sending updates.
Next due in 12 seconds	Precisely when the next update is due to be sent.
Timeout after 180 seconds	Specifies the value of the timeout parameter.
Redistributing	Lists the protocol that is being redistributed.

Table 7-28: show ip protocols output details

Field	Description
Routing for Networks	Specifies the networks for which the routing process is currently injecting routes.
Routing Information Sources	Lists all the routing sources the IP Infusion software is using to build its routing table.

show ip vrf

Use this command to display the routing information of the VRF, such as interface, route distinguisher, route-target, and so on.

Command Syntax

```
show ip vrf
show ip vrf WORD
```

Parameter

WORD VRF name

Command Mode

Privileged Exec mode and Exec mode

Applicability

This command was introduced before OcNOS version 1.3.

Example

```
#show ip vrf VRF_A
VRF VRF_A; (table=1)
```

show running-config as-path access-list

Use this command to show the running system status and configuration details for access lists based on autonomous system paths.

Command Syntax

```
show running-config as-path access-list
```

Parameters

None

Command Mode

Privileged exec mode, configure mode, router-map mode

Applicability

This command was introduced before OcNOS version 1.3.

Example

```
(config)#show running-config as-path access-list
!  
ip as-path access-list wer permit knsmk  
!  
(config)#
```

show running-config community-list

Use this command to show the running system status and configuration details for community lists.

Command Syntax

```
show running-config community-list
```

Parameters

None

Command Mode

Privileged exec mode, configure mode, router-map mode

Applicability

This command was introduced before OcNOS version 1.3.

Example

```
>enable
(config)#show running-config community-list
!
ip community-list standard aspd permit internet
ip community-list expanded cspd deny ljj
ip community-list expanded cspd permit dcv
ip community-list expanded wde permit njhd
ip community-list expanded wer deny sde
(config)#
```

CHAPTER 8 BGP Flowspec Commands

This chapter contains the BGP Flowspec commands.

- `address-family`
- `address-family ipv4 flowspec vrf`
- `class-map type traffic match-all`
- `drop`
- `flowspec`
- `hardware filter ipv4-bgp-flowspec`
- `local-install`
- `match dscp`
- `match destination-address`
- `match destination-port`
- `match fragment-type`
- `match icmp-code`
- `match icmp-type`
- `match packet-length`
- `match port`
- `match protocol`
- `match source-address`
- `match source-port`
- `match tcp-flag`
- `neighbor flowspec-validation-disable`
- `policy-map`
- `police rate`
- `policy-map class type traffic`
- `redirect`
- `set dscp`
- `service-policy type pbr`
- `show ip bgp`
- `vrf`

address-family

Specify address-family type to attach a policy to a specific address-family. This command enters address family configuration mode.

Command Syntax

```
address-family ipv4
no address-family
```

Parameters

None

Command Mode

Flowspec mode.

Applicability

This command was introduced in OcNOS version 6.3.0.

Examples

```
(config)#flowspec
(config-flowspec)#address-family ipv4
```

address-family ipv4 flowspec vrf

This command is to enter address-family ipv4 flowspec vrf mode to configure IPv4 BGP Flowspec specific parameters in a VRF.

Command Syntax

```
address-family ipv4 flowspec vrf VRF_NAME
no address-famlily ipv4 flowspec vrf VRF_NAME
```

Parameters

VRF_NAME vrf name

Command Mode

Config router mode.

Applicability

This command was introduced in OcNOS version 6.3.0.

Examples

```
(config-router)#address-family ipv4 flowspec vrf VRF1
```

class-map type traffic match-all

Define a traffic class and associate rules by using match sub-commands, after the class-map type traffic command is typed in. The created class-map can be removed with the no form of this command. Only match-all criteria (match all match items configured in a class-map) is supported in BGP Flowspec.

Command Syntax

```
class-map type traffic match-all CLASS_MAP_NAME
no class-map type traffic CLASS_MAP_NAME
```

Parameters

CLASS_MAP_NAME a class-map-name to define.

Command Mode

Configure mode.

Applicability

This command was introduced in OcNOS version 6.3.0.

Examples

```
(config)#class-map type traffic match-all test1
```

drop

When an attached class-map is matched, the matched packet drops.

Command Syntax

```
drop
no drop
```

Parameters

None

Command Mode

policy-map class mode.

Applicability

This command was introduced in OcNOS version 6.3.0.

Examples

```
(config-pmap-pbr-c) #drop
```

flowspec

This command is executed in the global configuration, and enter default VRF mode.

Command Syntax

```
flowspec
no flowspec
```

Parameters

None

Command Mode

Configure mode.

Applicability

This command was introduced in OcNOS version 6.3.0.

Examples

```
(config) #flowspec
```

hardware filter ipv4-bgp-flowspec

Use this command to enable ipv4 BGP flowspec feature in hardware. Unless it is enabled, the all flowspec routes are not set to hardware, while the all BGP operations are done not related to this command.

Command Syntax

```
hardware filter ipv4-bgp-flowspec enable
hardware filter ipv4-bgp-flowspec disable
```

Parameters

None

Command Mode

Configure mode.

Applicability

This command was introduced in OcNOS version 6.3.0.

Examples

```
(config)#hardware-profile filter ipv4-bgp-flowspec enable
```

local-install

Specify whether or not, the attached service policy is installed to a local node. By default, not installed. This command can be taken effect for all address-families by specifying it before entering address-family configuration mode, or for a specific address-family when the mode is address-family configuration.

Command Syntax

```
local-install interface-all
no local-install
```

Parameters

None

Command Mode

Flowspec, flowspec address family and flowspec-vrfmode.

Applicability

This command was introduced in OcNOS version 6.3.0.

Examples

```
config)#flowspec
(config-flowspec)#local-install interface-all
(config-flowspec)#address-family ipv4
(config-flowspec-af)#local-install interface-all
(config-flowspec-af)#exit
(config-flowspec)#vrf VRF1
(config-flowspec-vrf)#local-install interface-all
```

match dscp

Use this command to match DSCP value.

Command Syntax

```
match dscp [DSCP_VALUE|DSCP_VALUE_RANGE] [, ..., [DSCP_VALUE|DSCP_VALUE_RANGE]]
no match dscp
```

Parameters

DSCP_CODE_VALUE

A class-map-name to define.

DSCP_CODE_VALUE_RANGE

A range in a form of range: MIN_VALU-MAX_VALUE. e.g. 10-3e

Command Mode

Class-map mode.

Applicability

This command was introduced in OcNOS version 6.3.0.

Examples

```
(config)#class-map type traffic match-all test1
(config-cmap-tr)#match dscp 1c
```

match destination-address

IP destination address to match. It can be specified with prefix and netmask bits.

Command Syntax

```
match destination-address ipv4 A.B.C.D/M
no match destination-address
```

Parameters

A.B.C.D/M A.B.C.D is prefix and M is netmask bits.

Command Mode

Class-map mode.

Applicability

This command was introduced in OcNOS version 6.3.0.

Examples

```
(config)#class-map type traffic match-all test1
(config-cmap-tr)#match destination-address ipv4 1.1.1.1/32
```

match destination-port

Use this command to match TCP/UDP destination port number(s).

Command Syntax

```
match destination_port [PORT_NUMBER|PORT_RANGE] [, ..., [PORT_NUMBER|PORT_RANGE]]
no match destination_port
```

Parameters

PORT_NUMBER A port number in 1-65535

PORT_NUMBER_RANGE

A range in a form of range: MIN_VALUE-MAX_VALUE. e.g. 10-100

Command Mode

Class-map mode.

Applicability

This command was introduced in OcNOS version 6.3.0.

Examples

match fragment-type

Use this command to match fragment type.

Command Syntax

```
match fragment-type FRAGMENT_TYPE
no match fragment-type
```

Parameters

`FRAGMENT_TYPE` lf: Last fragment
ff: First fragment
isf: Is s fragment other than the first
df: Don't fragment
lf-ff-isf: When one of lf, ff, and isf is true to match, it matches.

Command Mode

Class-map mode.

Applicability

This command was introduced in OcNOS version 6.3.0.

Examples

```
(config)#class-map type traffic match-all test1
(config-cmap-tr)#match fragment-type lf
```

match icmp-code

Use this command to match the ICMP code.

Command Syntax

```
match ipv4 icmp-code [ICMP_TYPE_VALUE|ICMP_TYPE_VALUE_RANGE]
[,..., [ICMP_TYPE_VALUE|ICMP_TYPE_VALUE_RANGE]]
no match ipv4 icmp-code
```

Parameters

ICMP_CODE_VALUE

ICMP code number in 0-255

ICMP_CODE_VALUE_RANGE

A range in a form of range: MIN_VALU-MAX_VALUE. e.g. 10-100

Command Mode

Class-map mode.

Applicability

This command was introduced in OcNOS version 6.3.0.

Examples

```
(config)#class-map type traffic match-all test1
(config-cmap-tr)#match ipv4 icmp-type 10
(config-cmap-tr)#match ipv4 icmp-code 20
```

match icmp-type

Use this command to match TCP/UDP destination port number(s).

Command Syntax

```
match ipv4 icmp-type [ICMP_TYPE_VALUE|ICMP_TYPE_VALUE_RANGE]
[,..., [ICMP_TYPE_VALUE|ICMP_TYPE_VALUE_RANGE]]
no match ipv4 icmp-type
```

Parameters

ICMP_TYPE_VALUE

ICMP code number in 0-255

ICMP_TYPE_VALUE_RANGE

A range in a form of range: MIN_VALUE-MAX_VALUE. e.g. 10-100

Command Mode

Class-map mode.

Applicability

This command was introduced in OcnOS version 6.3.0.

Examples

```
(config)#class-map type traffic match-all test1
(config-cmap-tr)#match ipv4 icmp-type 10
```

match packet-length

Use this command to match packet length.

Command Syntax

```
match packet-length [PACKET_LENGTH_VALUE|PACKET_LENGTH_VALUE_RANGE]
[, ..., [PACKET_LENGTH_VALUE|PACKET_LENGTH_VALUE_RANGE]]
no match packet-length
```

Parameters

PACKET_LENGTH_VALUE

ICMP code number in 0-255

PACKET_LENGTH_VALUE_RANGE

A range in a form of range: MIN_VALU-MAX_VALUE. e.g. 10-100

Command Mode

Class-map mode.

Applicability

This command was introduced in OcNOS version 6.3.0.

Examples

```
(config)#class-map type traffic match-all test1
(config-cmap-tr)#match packet-length 70-100
```

match port

Use this command to match TCP/UDP port number(s).

Command Syntax

```
match port [PORT_NUMBER|PORT_RANGE] [, ..., [PORT_NUMBER|PORT_RANGE]]
no match port
```

Parameters

PORT_NUMBER A port number in 1-65535

PORT_NUMBER_RANGE

A range in a form of range: MIN_VALUE-MAX_VALUE. e.g. 10-100

Command Mode

Class-map mode.

Applicability

This command was introduced in OcNOS version 6.3.0.

Examples

```
(config)#class-map type traffic match-all test1
(config-cmap-tr)#match port 1000-2000
```

match protocol

Use this command to match Protocol number(s).

Command Syntax

```
match protocol
 [IP_PROTOCOL_NUM|IP_PROTOCOL_NUMBER_RANGE] [, ..., [IP_PRTOCOL_NUMBER|IP_PROTOCOL_N
UMBER_RANGE]]
no match protocol
```

Parameters

IP_PRTOCOL_NUMBER

IP protocol number in 0-255

IP_PROTOCOL_NUMBER_RANGE

A range in a form of range: MIN_VALUE-MAX_VALUE. e.g. 10-100

Command Mode

Class-map mode.

Applicability

This command was introduced in OcNOS version 6.3.0.

Examples

```
(config)#class-map type traffic match-all test1
(config-cmap-tr)#match protocol 122
```

match source-address

IP source address to match. It can be specified with prefix and netmask bits.

Command Syntax

```
match source-address ipv4 A.B.C.D/M
no match source-address
```

Parameters

A.B.C.D/M A.B.C.D is prefix and M is netmask bits.

Command Mode

Class-map mode.

Applicability

This command was introduced in OcNOS version 6.3.0.

Examples

```
(config)#class-map type traffic match-all test1
(config-cmap-tr)#match source-address ipv4 2.2.2.2/32
```

match source-port

Use the command to match TCP/UDP source port number(s).

Command Syntax

```
match source_port [PORT_NUMBER|PORT_RANGE] [, ..., [PORT_NUMBER|PORT_RANGE]]  
no match source_port
```

Parameters

PORT_NUMBER A port number in 1-65535

PORT_NUMBER_RANGE

A range in a form of range: MIN_VALUE-MAX_VALUE. e.g. 10-100

Command Mode

Class-map mode.

Applicability

This command was introduced in OcNOS version 6.3.0.

Examples

match tcp-flag

Use the command to match TCP flag.

Command Syntax

```
match ipv4 tcp-flag TCP_FLAG_VALUE bitmask TCP_FLAG_BITMASK
no match ipv4 tcp-flag bitmask
```

Parameters

TCP_FLAG_VALUE
TCP flag value in hexadecimal (0-fff)

TCP_FLAG_BITMASK
TCP flag bitmask in hexadecimal (0-fff)

Command Mode

Class-map mode.

Applicability

This command was introduced in OcNOS version 6.3.0.

Examples

```
(config)#class-map type traffic match-all test1
(config-cmap-tr)#match tcp-flag 2e bit-mask 3f
```

neighbor flowspec-validation-disable

The following parameters can be configured with neighbor command in address-family for BGP Flowspec. The flowspec-validation-disable is a parameter for BGP Flowspec. When it is specified, BGP Flowspec validation is disabled. By default, this parameter is enabled.

Command Syntax

```
neighbor A.B.C.D flowspec-validation-disable
```

Parameters

A.B.C.D IPv4 address

Command Mode

Router address family mode.

Applicability

This command was introduced in OcNOS version 6.3.0.

Examples

```
(config-router)#address-family ipv4 flowspec  
(config-router-af)#neighbor 1.1.1.1 flowspec-validation-disable
```

policy-map

Create or modify a policy map with a pbr type that can be attached as a service policy, and proceed to a mode to enter class command after this command is typed in. Multiple class-map can be linked to a created policy-map. To delete a policy-map, use the no form of this command.

Command Syntax

```
policy-map type pbr POLICY_MAP_NAME  
no policy-map type pbr POLICY_MAP_NAME
```

Parameters

POLICY_MAP_NAME

A name for a creating modifying policy-map.

Command Mode

Configure mode.

Applicability

This command was introduced in OcNOS version 6.3.0.

Examples

```
(config)#policy-map type pbr  
(config)#policy-map type pbr test2
```

police rate

Use this command to set a rate applied for matched packets.

Command Syntax

```
police rate RATE_VALUE [pps|bps]
no police rate
```

Parameters

RATE_VALUE	rate value specified in 1-1000000000.
pps	A unit for RATE_VALUE: pps mean packets per second.
bps	A unit for RATE_VALUE: bps mean bit per second.

Command Mode

Policy-map class mode

Applicability

This command was introduced in OcNOS version 6.3.0.

Examples

```
7017(config-pmap-pbr-c)#police rate
7017(config-pmap-pbr-c)#police rate 100000000 bps
```

policy-map class type traffic

Attach a class to a policy-map created by policy-map command. This command enters policy-map mode.

Command Syntax

```
class type traffic CLASS_MAP_NAME
no class type traffic CLASS_MAP_NAME
```

Parameters

CLASS_MAP_NAME

A name for class-map already created with class-map command.

Command Mode

Policy-map mode.

Applicability

This command was introduced in OcNOS version 6.3.0.

Examples

```
(config)#policy-map type pbr test2
(config-pmap-pbr)#class type traffic test1
```

redirect

Set a VRF redirected to for matched packets.

Command Syntax

```
redirect ipv4 extcommunity rt ROUTE_TARGET
no redirect ipv4 extcommunity rt
```

Parameters

`ROUTE_TARGET` Specify a route target, Two formats can be used:
AS number:index, e.g. 100:10
IPv4 address: index, e.g. 2.2.2.2:10.

Command Mode

policy-map class mode.

Applicability

This command was introduced in OcNOS version 6.3.0.

Examples

```
(config-pmap-pbr-c)#redirect ipv4 extcommunity rt 100:10
```

set dscp

Set a DSCP value to a matched packet to mark with it.

Command Syntax

```
set dscp DSCP_VALUE  
no set dscp
```

Parameters

DSCP_VALUE DSCP value in hexadecimal (0-3f)

Command Mode

policy-map class mode.

Applicability

This command was introduced in OcNOS version 6.3.0.

Examples

```
(config-pmap-pbr-c)#set dscp 3f
```

service-policy type pbr

Attach/detach a service policy to BGP component. The attached policy is locally installed optionally by typing local-install command, as well as a BGP Flowspec route is injected to a BGP component.

Command Syntax

```
service-policy type pbr POLICY_MAP_NAME
no service-policy type pbr POLICY_MAP_NAME
```

Parameters

POLICY_MAP_NAME
Name of the policy map.

Command Mode

Flowspec address family mode.

Applicability

This command was introduced in OcNOS version 6.3.0.

Examples

```
(config)#flowspec
(config-flowspec)#local-install interface-all
(config-flowspec)#address-family ipv4
(config-flowspec-af)#service-policy type pbr test1
```

show ip bgp

Use these commands to show the output.

Command Syntax

```
show ip bgp flowspec
show ip bgp flowspec summary (vrf (VRFNAME|all|default))
show ip bgp (ipv4|vpn4) flowspec (detail|)
show ip bgp (ipv4|vpn4) flowspec (vrf (VRFNAME|all|default)) (detail|)
show ip bgp vpn4 flowspec rd WORD (detail|)
```

Parameters

None

Command Mode

Executive mode.

Applicability

This command was introduced in OcNOS version 6.3.0.

Examples

```
#show ip bgp flowspec
BGP router identifier 19.19.19.19, local AS number 100
BGP table version is 7
1 BGP AS-PATH entries
0 BGP community entries
```

Neighbor PfxRcd	V	AS	MsgRcv	MsgSen	TblVer	InQ	OutQ	Up/Down	State/
1.1.1.1	4	100	40	35	7	0	0	00:04:51	
1									

Total number of neighbors 1

```
Total number of Established sessions 1
BGP router identifier 4.4.4.4, local AS number 100
BGP VRF VRF1 Route Distinguisher: 100:10
BGP table version is 1
1 BGP AS-PATH entries
0 BGP community entries
```

Neighbor PfxRcd	V	AS	MsgRcv	MsgSen	TblVer	InQ	OutQ	Up/Down	State/
200.2.1.2	4	65530	0	0	0	0	0	never	Connect

Total number of neighbors 1

Total number of Established sessions 0

```
show ip bgp flowspec summary vrf VRF1
BGP router identifier 4.4.4.4, local AS number 100
BGP VRF VRF1 Route Distinguisher: 100:10
BGP table version is 1
1 BGP AS-PATH entries
0 BGP community entries
```

Neighbor PfxRcd	V	AS	MsgRcv	MsgSen	TblVer	InQ	OutQ	Up/Down	State/
200.2.1.2	4	65530	0	0	0	0	0	never	Idle

Total number of neighbors 1

Total number of Established sessions 0

```
#show ip bgp flowspec summary vrf all
BGP router identifier 4.4.4.4, local AS number 100
BGP VRF VRF1 Route Distinguisher: 100:10
BGP table version is 1
1 BGP AS-PATH entries
0 BGP community entries
```

Neighbor PfxRcd	V	AS	MsgRcv	MsgSen	TblVer	InQ	OutQ	Up/Down	State/
200.2.1.2	4	65530	0	0	0	0	0	never	Connect

Total number of neighbors 1

Total number of Established sessions 0

```
BGP router identifier 19.19.19.19, local AS number 100
BGP table version is 7
1 BGP AS-PATH entries
0 BGP community entries
```

Neighbor PfxRcd	V	AS	MsgRcv	MsgSen	TblVer	InQ	OutQ	Up/Down	State/
1.1.1.1	4	100	41	37	7	0	0	00:05:31	

Total number of neighbors 1

Total number of Established sessions 1

```
#show ip bgp flowspec summary vrf default
BGP router identifier 19.19.19.19, local AS number 100
BGP table version is 7
1 BGP AS-PATH entries
0 BGP community entries
```

BGP Flowspec Commands

Neighbor PfxRcd	V	AS	MsgRcv	MsgSen	TblVer	InQ	OutQ	Up/Down	State/
1.1.1.1	4	100	42	37	7	0	0	00:05:37	

Total number of neighbors 1

Total number of Established sessions 1

```
#show ip bgp ipv4 flowspec
```

```
detail summary vrf
```

```
#show ip bgp ipv4 flowspec vrf all
```

```
BGP table version is 1, local router ID is 4.4.4.4
```

```
Status codes: s suppressed, d damped, h history, a add-path, * valid, > best, i - internal,
```

```
l - labeled, S Stale
```

```
Origin codes: i - IGP, e - EGP, ? - incomplete
```

Network	Next Hop	Metric	LocPrf	Weight	Path
BGP Route Table for VRF VRF1					
*>i flowspec/368	1.1.1.1	0	100	0	i

Total number of prefixes 1

*>i flowspec/368	1.1.1.1	0	100	0	i
------------------	---------	---	-----	---	---

Total number of prefixes 1

```
#show ip bgp ipv4 flowspec vrf all detail
```

```
BGP table version is 1, local router ID is 4.4.4.4
```

```
Status codes: s suppressed, d damped, h history, a add-path, * valid, > best, i - internal,
```

```
l - labeled, S Stale
```

```
Origin codes: i - IGP, e - EGP, ? - incomplete
```

Network	Next Hop	Metric	LocPrf	Weight	Path
BGP Route Table for VRF VRF1					
*>i flowspec/368	1.1.1.1	0	100	0	i

```
FlowSpec:
```

```
destination ip address: 1.1.1.1/32
```

```
source ip address: 2.2.2.2/32
```

```
IP protocol:
```

```
e:1 a:0 len:0 lt:0 gt:0 eq:1 data:122
```

```
TCP/UDP port:
```

```
e:0 a:0 len:1 lt:0 gt:1 eq:1 data:1000
```

```
e:1 a:1 len:1 lt:1 gt:0 eq:1 data:2000
```

```
ICMP type:
```

```
e:1 a:0 len:0 lt:0 gt:0 eq:1 data:10
```

```
ICMP code:
```

```

    e:1 a:0 len:0 lt:0 gt:0 eq:1 data:20
TCP flags:
    e:0 a:0 len:0 not:0 m:1 data:0x2e
    e:1 a:1 len:0 not:1 m:0 data:0x11
Packet length:
    e:0 a:0 len:1 lt:0 gt:1 eq:1 data:70
    e:1 a:1 len:1 lt:1 gt:0 eq:1 data:100
DSCP:
    e:1 a:0 len:0 lt:0 gt:0 eq:1 data:0x1c
fragment:
    e:1 a:0 len:0 not:0 m:1 data:0x8

```

FlowSpec Actions:

```

traffic_rate: 100000000 bps
rt_redirect: as_type: as 100:10 vrf_id:2 fib_id:2

```

Total number of prefixes 1

```
*>i flowspec/368      1.1.1.1          0          100         0         i
```

FlowSpec:

```

destination ip address: 1.1.1.1/32
source ip address: 2.2.2.2/32
IP protocol:
    e:1 a:0 len:0 lt:0 gt:0 eq:1 data:122
TCP/UDP port:
    e:0 a:0 len:1 lt:0 gt:1 eq:1 data:1000
    e:1 a:1 len:1 lt:1 gt:0 eq:1 data:2000
ICMP type:
    e:1 a:0 len:0 lt:0 gt:0 eq:1 data:10
ICMP code:
    e:1 a:0 len:0 lt:0 gt:0 eq:1 data:20
TCP flags:
    e:0 a:0 len:0 not:0 m:1 data:0x2e
    e:1 a:1 len:0 not:1 m:0 data:0x11
Packet length:
    e:0 a:0 len:1 lt:0 gt:1 eq:1 data:70
    e:1 a:1 len:1 lt:1 gt:0 eq:1 data:100
DSCP:
    e:1 a:0 len:0 lt:0 gt:0 eq:1 data:0x1c
fragment:
    e:1 a:0 len:0 not:0 m:1 data:0x8

```

FlowSpec Actions:

```

traffic_rate: 0 pps

```

Total number of prefixes 1

```
#show ip bgp vpnv4 flowspec vrf VRF1
```

BGP Flowspec Commands

Status codes: s suppressed, d damped, h history, a add-path, * valid, > best, i - internal, l - labeled

S Stale

Origin codes: i - IGP, e - EGP, ? - incomplete

Network	Next Hop	Metric	LocPrf	Weight	Path
Route Distinguisher: 100:10 (Default for VRF VRF1)					
*>i flowspec/368	1.1.1.1	0	100	0	i

Announced routes count = 0

Accepted routes count = 1

#show ip bgp vpnv4 flowspec vrf VRF1 detail

Status codes: s suppressed, d damped, h history, a add-path, * valid, > best, i - internal, l - labeled

S Stale

Origin codes: i - IGP, e - EGP, ? - incomplete

Network	Next Hop	Metric	LocPrf	Weight	Path
Route Distinguisher: 100:10 (Default for VRF VRF1)					
*>i flowspec/368	1.1.1.1	0	100	0	i

FlowSpec:

destination ip address: 1.1.1.1/32

source ip address: 2.2.2.2/32

IP protocol:

e:1 a:0 len:0 lt:0 gt:0 eq:1 data:122

TCP/UDP port:

e:0 a:0 len:1 lt:0 gt:1 eq:1 data:1000

e:1 a:1 len:1 lt:1 gt:0 eq:1 data:2000

ICMP type:

e:1 a:0 len:0 lt:0 gt:0 eq:1 data:10

ICMP code:

e:1 a:0 len:0 lt:0 gt:0 eq:1 data:20

TCP flags:

e:0 a:0 len:0 not:0 m:1 data:0x2e

e:1 a:1 len:0 not:1 m:0 data:0x11

Packet length:

e:0 a:0 len:1 lt:0 gt:1 eq:1 data:70

e:1 a:1 len:1 lt:1 gt:0 eq:1 data:100

DSCP:

e:1 a:0 len:0 lt:0 gt:0 eq:1 data:0x1c

fragment:

e:1 a:0 len:0 not:0 m:1 data:0x8

FlowSpec Actions:

traffic_rate: 100000000 bps

rt_redirect: as_type: as 100:10 vrf_id:2 fib_id:2

Announced routes count = 0

Accepted routes count = 1

#show ip bgp vpnv4 flowspec rd 100:10

Status codes: s suppressed, d damped, h history, a add-path, * valid, > best, i - internal, l - labeled

S Stale

Origin codes: i - IGP, e - EGP, ? - incomplete

Network	Next Hop	Metric	LocPrf	Weight	Path
Route Distinguisher: 100:10 (Default for VRF VRF1)					
*>i flowspec/368	1.1.1.1	0	100	0	i

Announced routes count = 0

Accepted routes count = 1

Status codes: s suppressed, d damped, h history, a add-path, * valid, > best, i - internal, l - labeled

S Stale

Origin codes: i - IGP, e - EGP, ? - incomplete

Network	Next Hop	Metric	LocPrf	Weight	Path
Route Distinguisher: 100:10					
*>i flowspec/368	1.1.1.1	0	100	0	i

Announced routes count = 0

Accepted routes count = 1

#show ip bgp vpnv4 flowspec rd 100:10 detail

Status codes: s suppressed, d damped, h history, a add-path, * valid, > best, i - internal, l - labeled

S Stale

Origin codes: i - IGP, e - EGP, ? - incomplete

Network	Next Hop	Metric	LocPrf	Weight	Path
Route Distinguisher: 100:10 (Default for VRF VRF1)					
*>i flowspec/368	1.1.1.1	0	100	0	i

FlowSpec:

destination ip address: 1.1.1.1/32

source ip address: 2.2.2.2/32

IP protocol:

e:1 a:0 len:0 lt:0 gt:0 eq:1 data:122

TCP/UDP port:

e:0 a:0 len:1 lt:0 gt:1 eq:1 data:1000

e:1 a:1 len:1 lt:1 gt:0 eq:1 data:2000

ICMP type:

e:1 a:0 len:0 lt:0 gt:0 eq:1 data:10

ICMP code:

e:1 a:0 len:0 lt:0 gt:0 eq:1 data:20

TCP flags:

e:0 a:0 len:0 not:0 m:1 data:0x2e

e:1 a:1 len:0 not:1 m:0 data:0x11

Packet length:

e:0 a:0 len:1 lt:0 gt:1 eq:1 data:70

e:1 a:1 len:1 lt:1 gt:0 eq:1 data:100

DSCP:

e:1 a:0 len:0 lt:0 gt:0 eq:1 data:0x1c

BGP Flowspec Commands

```
fragment:
  e:1 a:0 len:0 not:0 m:1 data:0x8
```

```
FlowSpec Actions:
  traffic_rate: 100000000 bps
  rt_redirect: as_type: as 100:10 vrf_id:2 fib_id:2
```

Announced routes count = 0

Accepted routes count = 1

Status codes: s suppressed, d damped, h history, a add-path, * valid, > best, i - internal, l - labeled

S Stale

Origin codes: i - IGP, e - EGP, ? - incomplete

Network	Next Hop	Metric	LocPrf	Weight	Path
Route Distinguisher: 100:10					
*>i flowspec/368	1.1.1.1	0	100	0	i

```
FlowSpec:
  destination ip address: 1.1.1.1/32
  source ip address: 2.2.2.2/32
  IP protocol:
    e:1 a:0 len:0 lt:0 gt:0 eq:1 data:122
  TCP/UDP port:
    e:0 a:0 len:1 lt:0 gt:1 eq:1 data:1000
    e:1 a:1 len:1 lt:1 gt:0 eq:1 data:2000
  ICMP type:
    e:1 a:0 len:0 lt:0 gt:0 eq:1 data:10
  ICMP code:
    e:1 a:0 len:0 lt:0 gt:0 eq:1 data:20
  TCP flags:
    e:0 a:0 len:0 not:0 m:1 data:0x2e
    e:1 a:1 len:0 not:1 m:0 data:0x11
  Packet length:
    e:0 a:0 len:1 lt:0 gt:1 eq:1 data:70
    e:1 a:1 len:1 lt:1 gt:0 eq:1 data:100
  DSCP:
    e:1 a:0 len:0 lt:0 gt:0 eq:1 data:0x1c
  fragment:
    e:1 a:0 len:0 not:0 m:1 data:0x8
```

```
FlowSpec Actions:
  traffic_rate: 100000000 bps
  rt_redirect: as_type: as 100:10 vrf_id:2 fib_id:2
```

Announced routes count = 0

Accepted routes count = 1

vrf

Specify a VRF to configure service policies. This command is executed in the default vrf mode, and enter vrf mode. address-family, local-install and service-policy commands can be executed in the same way (stated in address-family, local-install, and service-policy type pbr) executed in the default vrf mode.

Command Syntax

```
vrf VRF_NAME
no vrf VRF_NAME
```

Parameters

VRF_NAME	A vrf name already created
----------	----------------------------

Command Mode

Flowspec mode.

Applicability

This command was introduced in OcNOS version 6.3.0.

Examples

```
7017(config)#flowspec
7017(config-flowspec)#vrf VRF1
```

Appendix A Regular Expressions

Table A-29 shows the regular expression special characters used in BGP commands. You can use these characters in combination to build complex regular expressions.

Table A-29: Regular expression characters

Symbol	Character	Meaning
^	Caret	Matches the beginning of the input string. When used at the beginning of a string of characters, it negates a pattern match.
\$	Dollar sign	Matches the end of the input string.
.	Period	Matches a single character (including white spaces).
*	Asterisk	Matches none or more sequences of a pattern.
+	Plus sign	Matches one or more sequences of a pattern.
?	Question mark	Matches none or one occurrence of a pattern.
_	Underscore	Matches spaces, commas, braces, parenthesis, or the beginning and end of an input string.
[]	Brackets	A range of single-characters.
-	Hyphen	Separates the end points of a range.

Open Shortest Path First Command Reference

CHAPTER 1 OSPFv2 Commands

This chapter describes the OSPFv2 commands.

- [area authentication](#)
- [area default-cost](#)
- [area filter-list](#)
- [area interface](#)
- [area interface authentication](#)
- [area interface cost](#)
- [area interface database-filter](#)
- [area interface dead-interval](#)
- [area interface IFNAME bfd](#)
- [area interface IFNAME priority](#)
- [area interface hello-interval](#)
- [area interface mpls ldp-igp](#)
- [area interface mpls ldp-igp](#)
- [area interface mpls ldp-igp sync ospf holddown-timer](#)
- [area interface network-type](#)
- [area interface passive](#)
- [area interface retransmit-interval](#)
- [area interface te-metric](#)
- [area nssa](#)
- [area range](#)
- [area sham-link](#)
- [area shortcut](#)
- [area stub](#)
- [area virtual-link](#)
- [auto-cost reference bandwidth](#)
- [bfd all-interfaces](#)
- [capability cspf](#)
- [capability lls](#)
- [capability opaque](#)
- [capability traffic-engineering](#)
- [capability vrf-lite](#)
- [clear ip ospf](#)
- [compatible rfc1583](#)
- [debug ip ospf dist-ls](#)
- [debug ip ospf lfa](#)

- `debug ip ospf redist`
- `debug ip ospf retransmission`
- `debug ospf`
- `debug ospf database-timer rate-limit`
- `debug ospf events`
- `debug ospf ifsm`
- `debug ospf lsa`
- `debug ospf n fsm`
- `debug ospf nsm`
- `debug ospf packet`
- `debug ospf rib`
- `debug ospf route`
- `default-information originate`
- `default-metric`
- `distance`
- `distribute-list`
- `enable db-summary-opt`
- `enable ext-ospf-multi-inst`
- `fast-reroute keep-all-paths`
- `fast-reroute per-prefix remote-lfa area`
- `fast-reroute per-prefix route-map`
- `fast-reroute terminate-hold-on interval`
- `fast-reroute tie-break`
- `host area`
- `ip ospf authentication`
- `ip ospf authentication-key`
- `ip ospf bfd`
- `ip ospf cost`
- `ip ospf database-filter`
- `ip ospf dead-interval`
- `ip ospf demand-circuit`
- `ip ospf disable`
- `ip ospf fast-reroute per-prefix candidate disable`
- `ip ospf flood-reduction`
- `ip ospf hello-interval`
- `ip ospf multi-area`
- `ip ospf message-digest-key`
- `ip ospf mtu`
- `ip ospf mtu-ignore`

- `ip ospf network`
- `ip ospf priority`
- `ip ospf resync-timeout`
- `ip ospf retransmit-interval`
- `ip ospf transmit-delay`
- `log-adjacency-changes`
- `max-concurrent-dd`
- `maximum-area`
- `neighbor`
- `network`
- `ospf abr-type`
- `ospf area-interface-config-mode`
- `ospf flood-reduction`
- `ospf point-point rfc-incompatible`
- `ospf router-id`
- `overflow database`
- `overflow database external`
- `passive-interface`
- `redistribute`
- `router ospf`
- `show cspf rsvp forwarding-timer`
- `show debugging ospf`
- `show ip ospf`
- `show ip ospf border-routers`
- `show ip ospf database brief`
- `show ip ospf database detail`
- `show ip ospf igp-shortcut-lsp`
- `show ip ospf igp-shortcut-route`
- `show ip ospf interface`
- `show ip ospf multi-area-adjacencies`
- `show ip ospf neighbor`
- `show ip ospf route`
- `show ip ospf sham-links`
- `show ip ospf valid`
- `show ip ospf virtual-links`
- `show ip protocols`
- `show ip route fast-reroute`
- `shutdown`
- `snmp context-name`

- `snmp restart ospf`
- `summary-address`
- `te-metric`
- `timers lsa arrival`
- `timers spf exp`
- `timers throttle lsa`

area authentication

Use this command to enable authentication for an OSPF area. Specifying the area authentication sets the authentication to Type 1 authentication or simple text password authentication (details in RFC 2328). Setting up a Type 1 authentication configures a 64-bit field for that particular network. All packets sent on this network must have this configured value in their OSPF header. This allows only routers that have the same passwords to join the routing domain. Give all routers that are to communicate with each other through OSPF the same authentication password.

Use the `ip ospf authentication-key` command to specify a simple text password.

Use the `ip ospf message-digest-key` command to specify an MD5 password.

Use the `no` parameter to remove the authentication specification for an area.

Command Syntax

```
area (A.B.C.D|<0-4294967295>) authentication
area (A.B.C.D|<0-4294967295>) authentication message-digest
no area (A.B.C.D|<0-4294967295>) authentication
```

Parameters

A.B.C.D	OSPF Area ID in IPv4 address format.
<0-4294967295>	OSPF Area ID as 4-octet unsigned integer value.
message-digest	Enables MD5 authentication in the specified area ID.

Default

Null authentication

Command Mode

Router mode

Applicability

This command was introduced before OcNOS version 1.3.

Examples

```
#configure terminal
(config)#router ospf 100
(config-router)#area 1 authentication message-digest

(config)#router ospf 100
(config-router)#no area 1 authentication
```

area default-cost

Use this command to specify a cost for the default summary route sent into a stub or NSSA area. This command provides the metric for the summary default route, generated by the area border router, into the NSSA or stub area. Use this option only on an area border router that is attached to the NSSA or stub area. Refer to the RFC 3101 for information on NSSA.

Use the `no` form of this command to remove the assigned default-route cost.

Command Syntax

```
area (A.B.C.D|<0-4294967295>) default-cost <0-16777215>
no area (A.B.C.D|<0-4294967295>) default-cost
```

Parameters

A.B.C.D	OSPF Area ID in IPv4 address format.
<0-4294967295>	OSPF Area ID as a decimal value.
default-cost	Indicates the cost for the default summary route used for a stub or NSSA area.
<0-16777215>	Stub's advertised default summary cost. The default is 1.

Default

By default, route cost is 1

Command Mode

Router mode

Applicability

This command was introduced before OcNOS version 1.3.

Examples

This example sets the default-cost to 10 for area 1.

```
#configure terminal
(config)#router ospf 100
(config-router)#area 1 default-cost 10

(config)#router ospf 100
(config-router)#no area 1 default-cost
```

area filter-list

Use this command to configure a filter to advertise summary routes on an Area Border Router (ABR).

This command suppresses incoming and outgoing summary routes between this area and other areas. You use this command in conjunction with the `prefix-list` and `access-list` commands.

Use the `no` form of this command to remove a filter.

Command Syntax

```
area (A.B.C.D|<0-4294967295>) filter-list prefix WORD (in|out)
area (A.B.C.D|<0-4294967295>) filter-list access WORD (in|out)
no area (A.B.C.D|<0-4294967295>) filter-list prefix WORD (in|out)
no area (A.B.C.D|<0-4294967295>) filter-list access WORD (in|out)
```

Parameters

A.B.C.D	OSPF area ID as an IPv4 address.
<0-4294967295>	OSPF area ID as a decimal value.
prefix	Use prefix list to filter summary.
WORD	Name of the prefix list.
access	Use access list to filter summary.
WORD	Name of the access list.
in	Filter routes from other areas into this area.
out	Filter routes from this area into other areas.

Default

No default value is specified

Command Mode

Router mode

Applicability

This command was introduced before OcnOS version 1.3.

Examples

```
#configure terminal
(config)#ip access-list standard 1
(config)#deny host 172.22.0.0
(config)#router ospf 100
(config-router)#area 1 filter-list access 1 in
```

area interface

Use this command to enable OSPF routing on the current interface.

Use no form of this command to disable OSPF routing on the current interface.

Command Syntax

```
area (A.B.C.D|<0-4294967295>) interface IFNAME
no area (A.B.C.D|<0-4294967295>) interface IFNAME
```

Parameters

A.B.C.D	OSPF area ID as an IPv4 address.
<0-4294967295>	OSPF area ID as a decimal value.
IFNAME	Specify the interface name.

Default

No default value is specified

Command Mode

Router mode

Applicability

This command was introduced in OcNOS version 4.2.

Examples

```
#configure terminal
(config)#router ospf 100
(config-router)#area 1 interface xe1
```

area interface authentication

Use this command to send and receive OSPF packets with the specified authentication method on the current interface.

Use no form of this command to stop sending and receiving OSPF packets with the specified authentication method on the current interface.

Command Syntax

```
area (A.B.C.D|<0-4294967295>) interface IFNAME authentication (null|message-  
digest|)  
no area (A.B.C.D|<0-4294967295>) interface IFNAME authentication
```

Parameters

A.B.C.D	OSPF area ID as an IPv4 address.
<0-4294967295>	OSPF area ID as a decimal value.
IFNAME	Specify the interface name.
null	Use no authentication.
message-digest	Use message digest authentication.

Default

No default value is specified

Command Mode

Router mode

Applicability

This command was introduced in OcNOS version 4.2.

Examples

```
#configure terminal  
(config)#router ospf 100  
(config-router)#area 1 interface xe1 authentication null
```

area interface cost

Use this command to explicitly specify the cost of the link-state metric in a router-LSA.

- The interface cost indicates the overhead required to send packets across an interface. This cost is stated in the Router-LSA's link. The cost is inversely proportional to the bandwidth of an interface. By default, the cost of an interface is calculated based on the bandwidth (108/ bandwidth). Use this command to set the cost manually.

Use the no parameter with this command to reset the cost to its default value.

Command Syntax

```
area (<0-4294967295> | A.B.C.D) interface <IFNAME> cost <1-65535>
no area (<0-4294967295> | A.B.C.D) interface <IFNAME> cost
```

Parameters

A.B.C.D	OSPF area ID as an IPv4 address
<0-4294967295>	OSPF area ID as a decimal value
IFNAME	Specify the interface name
<0-65535>	Link-state metric

Default

By default, cost is 10.

Command Mode

Router mode

Applicability

This command was introduced in OcNOS version 6.3.0.

Examples

```
#configure terminal
(config)#router ospf 100
(config-router)#area 1 interface xe1 cost 10
```

area interface database-filter

Use this command to turn on the LSA database-filter for a particular interface.

- OSPF floods new LSAs over all interfaces in an area, except the interface on which the LSA arrives. This redundancy ensures robust flooding. However, too much redundancy can waste bandwidth and might lead to excessive link and CPU usage in certain topologies, resulting in destabilizing the network. To avoid this, use this command to block flooding of LSAs over specified interfaces.

Use the no parameter with this command to turn off the filter.

Command Syntax

```
area (A.B.C.D|<0-4294967295>) interface <IFNAME> database-filter all out
no area (A.B.C.D|<0-4294967295>) interface <IFNAME> database-filter all out
```

Parameters

A.B.C.D	OSPF area ID as an IPv4 address
<0-4294967295>	OSPF area ID as a decimal value
IFNAME	Specify the interface name

Default

Disabled, all outgoing LSAs are flooded to the interface.

Command Mode

Router mode

Applicability

This command was introduced in OcNOS version 6.3.0.

Examples

```
#configure terminal
(config)#router ospf 100
(config-router)#area 1 interface xe1 database-filter all out
```

area interface dead-interval

Use this command to set the interval during which the router waits to receive an OSPF hello packet from the neighbor before declaring the neighbor down. This value is advertised in the router's hello packets. It must be a multiple of hello-interval and be the same for all routers on a specific network.

Use the no parameter with this command to return to the default time. If you have configured this command specifying the IP address of the interface and want to remove the configuration, use the no parameter with the specified IP address (no ip ospf dead-interval A.B.C.D).

Command Syntax

```
area (A.B.C.D|<0-4294967295>) interface <IFNAME> dead-interval <1-65535>
no area (A.B.C.D|<0-4294967295>) interface <IFNAME> dead-interval
```

Parameters

A.B.C.D	OSPF area ID as an IPv4 address
<0-4294967295>	OSPF area ID as a decimal value
IFNAME	Specify the interface name
dead-interval	Specify the interval
<1-65535>	Specify the interval in seconds

Default

No default value is specified.

Command Mode

Router mode

Applicability

This command was introduced in OcnOS version 6.3.0.

Examples

```
#configure terminal
(config)#router ospf 100
(config-router)#area 1 interface xe1 dead-interval 10
```

area interface IFNAME bfd

Use this command to enable the BFD option for OSPF neighbors on an interface. Use the no form of the command to disable the BFD option for OSPF neighbors on an interface.

Note: When BFD monitoring is enabled for ospf session, protocol admin events like clear/ shutdown will cause BFD session to go to admin down. Due to this, neighbourship/adjacency down detection on peer will be according to the protocol configured dead interval and is not based on BFD interval.

Command Syntax

```
area (A.B.C.D|<0-4294967295>) interface <IFNAME> bfd (disable|)
no area (A.B.C.D|<0-4294967295>) interface <IFNAME> bfd (disable|)
```

Parameters

A.B.C.D	OSPF area ID as an IPv4 address
<0-4294967295>	OSPF area ID as a decimal value
IFNAME	Specify the interface name
disable	Disable the BFD option for neighbors on an interface

Default

No default value is specified.

Command Mode

Router mode

Applicability

This command was introduced in OcNOS version 6.3.0.

Examples

```
#configure terminal
(config)#router ospf 100
(config-router)#area 1 interface xe1 bfd
```

area interface IFNAME priority

Use this command to set the router priority to determine the designated router (DR) for the network.

- A router with the higher router priority becomes the DR. If the priority is the same for two routers, the router with the higher router ID takes precedence.
- Only routers with a nonzero priority value are eligible to become the designated or backup designated router. Configure router priority for broadcast or NBMA networks only and not for point-to-point networks.

Use the no parameter with this command to return to the default value.

Command Syntax

```
area (<0-4294967295> | A.B.C.D) interface <IFNAME> priority <0-255>
no area (<0-4294967295> | A.B.C.D) interface <IFNAME> priority
```

Parameters

A.B.C.D	OSPF area ID as an IPv4 address
<0-4294967295>	OSPF area ID as a decimal value
IFNAME	Specify the interface name
priority	Specify the router priority of the interface
<0-255>	Specify the router priority of the interface. The default value is 1

Default

By default, priority is 1.

Command Mode

Router mode

Applicability

This command was introduced in OcNOS version 6.3.0.

Examples

```
#configure terminal
(config)#router ospf 100
(config-router)#area 1 interface xe1 priority 3
```

area interface hello-interval

Use this command to specify the interval between hello packets.

- The hello-interval is advertised in the hello packets. Configure the same hello-interval for all routers on a specific network. A shorter hello interval ensures faster detection of topological changes but results in more routing traffic.

Use the no parameter with this command to return to the default time.

Command Syntax

```
area (A.B.C.D|<0-4294967295>) interface <IFNAME> hello-interval <1-65535>
no area (A.B.C.D|<0-4294967295>) interface <IFNAME> hello-interval
```

Parameters

A.B.C.D	OSPF area ID as an IPv4 address
<0-4294967295>	OSPF area ID as a decimal value
IFNAME	Specify the interface name
hello-interval	Specify the interface name
<1-65535>	Specify the interval in seconds

Default

By default, hello interval is 10 seconds.

Command Mode

Router mode

Applicability

This command was introduced in OcNOS version 6.3.0.

Examples

```
#configure terminal
(config)#router ospf 100
(config-router)#area 1 interface xe1 hello-interval 3
```

area interface mpls ldp-igp

Use this attribute to enable the MPLS LDP IGP SYNC on OSPF.

Command Syntax

```
area (A.B.C.D|<0-4294967295>) interface <IFNAME> mpls ldp-igp sync ospf
no area (A.B.C.D|<0-4294967295>) interface <IFNAME> mpls ldp-igp sync ospf
```

Parameters

A.B.C.D	OSPF area ID as an IPv4 address
<0-4294967295>	OSPF area ID as a decimal value
IFNAME	Specify the interface name
sync	Enable MPLS LDP IGP SYNC on OSPF

Default

No default value is specified.

Command Mode

Router mode

Applicability

This command was introduced in OcNOS version 6.3.0.

Examples

```
#configure terminal
(config)#router ospf 100
(config-router)#area 1 interface xe1 mpls ldp-igp sync ospf
```

area interface mpls ldp-igp sync ospf holddown-timer

Use this attribute to configure the hold-down timer for which OSPF will wait for LDP to converge and advertises Max cost.

- When the configured time expires, OSPF starts advertising the actual cost in the Router-LSA.

Command Syntax

```
area (A.B.C.D|<0-4294967295>) interface <IFNAME> mpls ldp-igp sync ospf
  holddowntimer <1-2147483>
no area (A.B.C.D|<0-4294967295>) interface <IFNAME> mpls ldp-igp sync ospf
```

Parameters

A.B.C.D	OSPF area ID as an IPv4 address
<0-4294967295>	OSPF area ID as a decimal value
IFNAME	Specify the interface name
sync	Enable MPLS LDP IGP SYNC on OSPF
holddown-time	Holddown timer values in seconds.
<1-2147483>	OSPF area ID as a decimal value

Default

By default, holddown-timer is 70000 seconds.

Command Mode

Router mode

Applicability

This command was introduced in OcNOS version 6.3.0.

Examples

```
#configure terminal
(config)#router ospf 100
(config-router)#area 1 interface xe1 mpls ldp-igp sync ospf holddown-timer
140000
```

area interface network-type

Use this command to set the OSPF network type on the current interface.

Use no form of this command to unset the OSPF network type on the current interface.

Command Syntax

```
area (A.B.C.D|<0-4294967295>) interface IFNAME network-type (broadcast|non-  
broadcast|point-to-multipoint (non-broadcast|)|point-to-point)  
no area (A.B.C.D|<0-4294967295>) interface IFNAME network-type
```

Parameters

A.B.C.D	OSPF area ID as an IPv4 address.
<0-4294967295>	OSPF area ID as a decimal value.
IFNAME	Specify the interface name.
broadcast	Sets the network type to broadcast.
non-broadcast	Sets the network type to NBMA.
point-to-multipoint	Sets the network type to point-to-multipoint..
non-broadcast	Sets the network type to NBMA.
point-to-point	Sets the network type to point-to-point.

Default

No default value is specified

Command Mode

Router mode

Applicability

This command was introduced in OcNOS version 4.2.

Examples

```
#configure terminal  
(config)#router ospf 100  
(config-router)#area 1 interface xe1 network-type point-to-point
```

area interface passive

Use this command to suppress sending hello packets on the current interface.

Use no form of this command to unsuppress sending Hello packets on the current interface.

Command Syntax

```
area (A.B.C.D|<0-4294967295>) interface IFNAME passive
no area (A.B.C.D|<0-4294967295>) interface IFNAME passive
```

Parameters

A.B.C.D	OSPF area ID as an IPv4 address.
<0-4294967295>	OSPF area ID as a decimal value.
IFNAME	Specify the interface name.

Default

No default value is specified

Command Mode

Router mode

Applicability

This command was introduced in OcNOS version 4.2.

Examples

```
#configure terminal
(config)#router ospf 100
(config-router)#area 1 interface xe1 passive
```

area interface retransmit-interval

Use this command to specify the time between link-state advertisement (LSA) retransmissions for adjacencies belonging to the interface.

- After sending an LSA to a neighbor, the router keeps the LSA until it receives an acknowledgement. If the router does not receive an acknowledgement during the retransmit interval, it retransmits the LSA. Set the retransmission interval value conservatively to avoid needless retransmission. The interval should be greater than the expected round-trip delay between two routers.

Use the no parameter with this command to return to the default value.

Command Syntax

```
router ospf <0-65535> / area (A.B.C.D|<0-4294967295>) interface <IFNAME>
  retransmit-interval <1-3600>

router ospf <0-65535> / no area (A.B.C.D|<0-4294967295>) interface <IFNAME>
  retransmit-interval
```

Parameters

A.B.C.D	OSPF area ID as an IPv4 address
<0-4294967295>	OSPF area ID as a decimal value
IFNAME	Specify the interface name
retransmit-interval	Holddown timer values in seconds
<1-3600>	Specify the interval in seconds

Default

By default, retransmit interval is 5 seconds.

Command Mode

Router mode

Applicability

This command was introduced in OcNOS version 6.3.0.

Examples

```
#configure terminal
(config)#router ospf 100
(config-router)#area 1 interface xe1 retransmit-interval 6
```

area interface te-metric

This command sets the traffic engineering (TE) metric for an interface.

- The traffic engineering metric is used in OSPF-TE Link State Advertisements. If the traffic engineering metric is not set, the ip ospf cost value for an interface is used in OSPF-TE Link State Advertisements.

Use the no parameter with this command to set the traffic engineering metric to its default.

Command Syntax

```
area (A.B.C.D|<0-4294967295>) interface <IFNAME> te-metric <1-65535>
no area (A.B.C.D|<0-4294967295>) interface <IFNAME> te-metric <1-65535>
```

Parameters

A.B.C.D	OSPF area ID as an IPv4 address
<0-4294967295>	OSPF area ID as a decimal value
IFNAME	Specify the interface name
<1-65535>	Traffic engineering metric

Default

By default, the area interface cost value for an interface is used.

Command Mode

Router mode

Applicability

This command was introduced in OcNOS version 6.3.0.

Examples

```
#configure terminal
(config)#router ospf 100
(config-router)#area 1 interface xe1 te-metric 6
```

area nssa

Use this command to set an area as a Not-So-Stubby-Area (NSSA). There are no external routes in an OSPF stub area, so you cannot redistribute from another protocol into a stub area. An NSSA allows external routes to be flooded within the area. These routes are then leaked into other areas. However, the external routes from other areas still do not enter the NSSA. You can configure an area to be a stub area or an NSSA, but not both.

This command simplifies administration when connecting a central site using OSPF to a remote site that is using a different routing protocol. You can extend OSPF to cover the remote connection by defining the area between the central router and the remote router as a NSSA.

Use the `no` form of this command to remove this designation.

Command Syntax

```
area (A.B.C.D|<0-4294967295>) nssa {translator-role (candidate|always|never) |
  stability-interval < 0-2147483647>|no-redistribution|default-information-
  originate (metric < 0-16777214>|metric-type <1-2>|metric <0-16777214> metric-type
  <1-2>|metric-type< 1-2> metric <0-16777214>|) |no-summary}
no area (A.B.C.D|<0-4294967295>) nssa
no area (A.B.C.D|<0-4294967295>) nssa {translator-role|stability-interval|no-
  redistribution |default-information-originate (route-map |) |no-summary}
```

Parameters

A.B.C.D OSPF Area ID in IPv4 address format.

<0-4294967295> OSPF Area ID as a decimal value.

translator-role

NSSA-ABR translator role

candidate Translate NSSA-LSA to Type-5 LSA if router is elected.

never Do not translate NSSA-LSA to Type-5 LSA.

always Always translate NSSA-LSA to Type-5 LSA.

stability-interval

Stability timer for a NSSA area. If an elected translator determines its services are no longer required, it continues to perform its duties for this time interval. This minimizes excess flushing of translated Type-7 LSAs and provides a more stable translator transition.

<0-2147483647>

Stability interval in seconds.

no-redistribution

Do not redistribute into the NSSA.

default-information-originate

Originate Type-7 default LSA into the NSSA.

metric Specify metric for default routes.

<0-16777214>

Specify metric value.

metric-type Specify metric type (see RFC 3101).

<1-2>	Specify metric type:
	1: Type 1 external route
	2: Type 2 external route
route-map	OSPF default Route map reference.
WORD	Pointer to route-map entries.
no-summary	Do not inject inter-area routes into the NSSA.

Default

No default value is specified

Command Mode

Router mode

Applicability

This command was introduced before OcNOS version 1.3.

Examples

```
(config)#router ospf 100
(config-router)#area 3 nssa translator-role candidate no-redistribution
default-information-originate metric 34 metric-type 2
```

area range

Use this command to summarize OSPF routes at an area boundary. A single summary route is then advertised to other areas by the Area Border Routers (ABRs). Routing information is condensed at area boundaries and outside the area. If the network numbers in an area are assigned in a way such that they are contiguous, the ABRs can be configured to advertise a summary route that covers all the individual networks within the area that fall into the specified range.

Use the `no` parameter with this command to disable this function.

Command Syntax

```
area (A.B.C.D|<0-4294967295>) range (A.B.C.D/M | A.B.C.D A.B.C.D)
area (A.B.C.D|<0-4294967295>) range (A.B.C.D/M | A.B.C.D A.B.C.D) non-advertise
area (A.B.C.D|<0-4294967295>) range A.B.C.D A.B.C.D (advertise|non-advertise)
no area (A.B.C.D|<0-4294967295>) range (A.B.C.D/M | A.B.C.D A.B.C.D)
no area (A.B.C.D|<0-4294967295>) range (A.B.C.D/M | A.B.C.D A.B.C.D) not-advertise
```

Parameters

A.B.C.D	Area range prefix or length e.g. X.X.X.X/length
A.B.C.D	Area range prefix e.g. A.B.C.D
<0-4294967295>	OSPF Area ID as a decimal value.
A.B.C.D/M	The area range prefix and length.
advertise	Advertise this range.
not-advertise	Does not advertise this range.

Default

Range is advertised by default.

Command Mode

Router mode

Applicability

This command was introduced before OcnOS version 1.3.

Examples

```
#configure terminal
(config)#router ospf 100
(config-router)#area 1 range 192.16.0.0/24

(config)#router ospf 100
(config-router)#no area 1 range 192.16.0.0/24
```

area sham-link

Use this command to configure a sham link between two Provider Edge on MPLS backbone to make them appear as intra-area link.

If it is desired to have OSPF prefer the routes through the MPLS backbone over the routes through the backdoor link, then the routes through the MPLS backbone must be appear to be intra-area routes. To make a route through the backbone appear to be an intra-area route, it is necessary to make it appear as if there is an intra-area link connecting the two PE routers. This is what we refer to as a "sham link."

Use the no parameter with this command to remove a sham link.

Command Syntax

```
area (A.B.C.D|<0-4294967295>) sham-link A.B.C.D A.B.C.D
area (A.B.C.D|<0-4294967295>) sham-link A.B.C.D A.B.C.D {cost <1-65535>}
no area (A.B.C.D|<0-4294967295>) sham-link A.B.C.D A.B.C.D
no area (A.B.C.D|<0-4294967295>) sham-link A.B.C.D A.B.C.D cost
```

Parameters

A.B.C.D	OSPF Area ID in IPv4 address format.
<0-4294967295>	OSPF Area ID as a decimal value.
A.B.C.D	Specify IP address of source sham link.
A.B.C.D	Specify IP address of destination sham link.
<1-65535>	cost of sham link (cost preferably to be configured lower than the backdoor link cost).

Default

Cost: 1

Command Mode

Router mode

Note: sham-link is not supported on default VRF.

Applicability

This command was introduced in OcNOS version 5.0.

Examples

```
#configure terminal
Enter configuration commands, one per line. End with CNTL/Z.
(config)#router ospf 1 vrf1
(config-router)#area 1 sham-link 1.1.1.1 2.2.2.2 cost 10
(config-router)#
```

area shortcut

Use this command to configure the short-cutting mode of an area. An area shortcut enables traffic to go through the non-backbone area with a lower metric whether or not an ABR router is attached to the backbone area.

Use the `no` form of this command to disable this function.

Command Syntax

```
area (A.B.C.D|<0-4294967295>) shortcut (default|enable|disable)
no area (A.B.C.D|<0-4294967295>) shortcut
```

Parameters

A.B.C.D	OSPF Area ID in IPv4 address format.
<0-4294967295>	OSPF Area ID as a decimal value.
default	Sets default short-cutting behavior.
enable	Forces short-cutting through the area.
disable	Disables short-cutting through the area.

Command Mode

Router mode

Applicability

This command was introduced before OcNOS version 1.3.

Examples

```
#configure terminal
(config)#router ospf 100
(config-router)#area 1 shortcut default

(config)#router ospf 100
(config-router)#area 52 shortcut disable

(config)#router ospf 100
(config-router)#no area 42 shortcut enable
```

area stub

Use this command to define an area as a stub area. There are two stub area router configuration commands: the `stub` and `default-cost` commands. In all routers attached to the stub area, configure the area by using the `stub` option of the area command. For an area border router (ABR) attached to the stub area, use the `area default-cost` command.

Use the `no-summary` parameter with this command to define a totally stubby area. Define an area as a totally stubby area when routers in the area do not need to learn about summary LSAs from other areas.

Use the `no` form of this command to disable this function.

Command Syntax

```
area (A.B.C.D|<0-4294967295>) stub
area (A.B.C.D|<0-4294967295>) stub no-summary
no area (A.B.C.D|<0-4294967295>) stub
no area (A.B.C.D|<0-4294967295>) stub no-summary
```

Parameters

A.B.C.D	OSPF Area ID in IPv4 address format.
<0-4294967295>	OSPF Area ID as a decimal value.
no-summary	Stops an ABR from sending summary link advertisements into the stub area.

Default

By default, no stub area is defined.

Command Mode

Router mode

Applicability

This command was introduced before OcNOS version 1.3

Examples

```
#configure terminal
(config)#router ospf 100
(config-router)#area 1 stub no-summary
```

area virtual-link

Use this command to configure a link between two backbone areas that are physically separated through other non-backbone area.

In OSPF, all non-backbone areas must be connected to a backbone area. If the connection to the backbone is lost, the virtual link repairs the connection. Configure virtual links between any two backbone routers that have an interface to a common non-backbone area. The protocol treats these routers joined by a virtual link as if they were connected by an unnumbered point-to-point network.

Configure the hello-interval to be the same for all routers attached to a common network. A short hello-interval results in the router detecting topological changes faster but also an increase in the routing traffic. The retransmit-interval is the expected round-trip delay between any two routers in a network. Set the value to be greater than the expected round-trip delay to avoid needless retransmissions.

The transmit-delay is the time taken to transmit a link state update packet on the interface. Before transmission, the link state advertisements in the update packet, are incremented by this amount. Set the transmit-delay to be greater than zero. Also, take into account the transmission and propagation delays for the interface. Include the transit area ID and the corresponding virtual link neighbor's router ID in each virtual link neighbor to properly configure a virtual link.

Use the `no` parameter with this command to remove a virtual link.

Command Syntax

```
area (A.B.C.D|<0-4294967295>) virtual-link A.B.C.D
area (A.B.C.D|<0-4294967295>) virtual-link A.B.C.D {authentication (message-
  digest|null)|authentication-key LINE|message-digest-key <1-255> md5 LINE}
area (A.B.C.D|<0-4294967295>) virtual-link A.B.C.D {dead-interval <1-65535>|hello-
  interval <1-65535>|retransmit-interval <1-3600>|transmit-delay <1-3600>}
area (A.B.C.D|<0-4294967295>) virtual-link A.B.C.D fall-over bfd
no area (A.B.C.D|<0-4294967295>) virtual-link A.B.C.D
no area (A.B.C.D|<0-4294967295>) virtual-link A.B.C.D {authentication
  (messagedigest| null)|authentication-key LINE|message-digest-key <1-255> md5
  LINE}
no area (A.B.C.D|<0-4294967295>) virtual-link A.B.C.D {dead-interval <1-
  65535>|hello-interval <1-65535>|retransmit-interval <1-3600>|transmit-delay <1-
  3600>}
no area (A.B.C.D|<0-4294967295>) virtual-link A.B.C.D fall-over bfd
```

Parameters

A.B.C.D	OSPF Area ID in IPv4 address format.
<0-4294967295>	OSPF Area ID as a decimal value.
A.B.C.D	Specify IP address of the virtual link neighbor.
authentication	Enable authentication on this virtual link
message-digest	Cryptographic authentication.
null	Null authentication.
authentication-key	Set authentication key.

LINE	Authentication key ID of 8 characters.
message-digest-key	Set message digest key.
<1-255>	Set message digest key.
md5	Specify the MD5 key.
LINE	MD5 key.
dead-interval	The interval during which no packets are received and after which the router acknowledges a neighboring router as off-line.
<1-65535>	The interval in seconds. The default is 40 seconds.
hello-interval	The interval the router waits before it sends a hello packet.
<1-65535>	The interval in seconds. The default is 10 seconds.
retransmit-interval	The interval the router waits before it retransmits a packet.
<1-3600>	The interval in seconds. The default is 5 seconds.
transmit-delay	The interval the router waits before it transmits a packet.
<1-3600>	The interval in seconds. The default is 1 second
fall-over	Specify fall-over detection.
bfd	Bidirectional Forwarding Detection (BFD)

Default

Default intervals:

Dead interval : 40 seconds

Hello interval: 10 seconds

Retransmit interval: 5 seconds

Transmit delay: 1 second

Command Mode

Router mode

Applicability

This command was introduced before OcNOS version 1.3

Examples

```
#configure terminal
(config)#router ospf 100
(config-router)#area 1 virtual-link 10.10.11.50 hello 5 dead 10
```

The below example shows the differences between with and without encrypted passwords.

0x - Already encrypted password

WORD - Authentication key (without encryption, ie doesn't begin with 0x)

```
(config-router)#area 0.0.0.1 virtual-link 2.2.2.2 authentication
authentication-key 0x1234567891234567
```

```
(config-router)#area 0.0.0.1 virtual-link 2.2.2.2 authentication
authentication-key test
```

auto-cost reference bandwidth

Use this command to control how OSPF calculates the default metric for the interface.

Use the `no` form of this command to assign cost based only on the interface bandwidth.

Command Syntax

```
auto-cost reference-bandwidth <1-4294967>
no auto-cost reference-bandwidth
```

Parameters

<1-4294967> The reference bandwidth in Mbps. The default is 100 Mbps.

Default

By default, OSPF calculates the OSPF metric for an interface by dividing the reference bandwidth by the interface bandwidth. The default value for the reference bandwidth is 100Mbps. The auto-cost command is used to differentiate high bandwidth links. For multiple links with high bandwidth, specify a larger reference bandwidth value to differentiate cost on those links.

Command Mode

Router mode

Applicability

This command was introduced before OcnOS version 1.3.

Examples

```
#configure terminal
(config)#router ospf 100
(config-router)#auto-cost reference-bandwidth 50

(config)#router ospf 100
(config-router)#no auto-cost reference-bandwidth
```

bfd all-interfaces

Use this command to enable Bidirectional Forwarding Detection (BFD) on all interfaces.

Use the `no` form of this command to disable BFD.

Command Syntax

```
bfd all-interfaces
no bfd all-interfaces
```

Parameters

None

Default

No default value is specified

Command Mode

Router mode

Applicability

This command was introduced before OcNOS version 1.3.

Examples

```
#configure terminal
(config)#router ospf 100
(config-router)#bfd all-interfaces

(config)#router ospf 100
(config-router)#no bfd all-interfaces
```

capability cspf

Use this command to enable the CSPF (Constrained Shortest Path First) feature for an OSPFv2 or OSPFv3 instance.

Use the `no` parameter with this command to disable CSPF functionality for the OSPFv2 or OSPFv3 instance.

Command Syntax

```
capability cspf
no capability cspf
```

Parameters

None

Default

By default, CSPF functionality for the OSPFv2 or OSPFv3 instance is enabled.

When CSPF is enabled, `disable-better-protection` option is by default enabled for OSPFv2.

Command Mode

Router mode

Applicability

This command was introduced before OcnOS version 1.3.

Examples

```
#configure terminal
(config)#router ospf 100
(config-router)#capability cspf

(config)#router ospf 100
(config-router)#no capability cspf
```

capability lls

Use this command to enable link-local signaling feature on OSPF router.

Use no parameter to disable link-local signaling feature on OSPF router.

Command Syntax

```
capability lls
no capability lls
```

Parameters

None

Default

By default, capability lls is enabled

Command Mode

Router mode

Applicability

This command was introduced before OcNOS version 1.3.

Examples

```
#configure terminal
(config)#router ospf 100
(config-router)#capability lls

(config-router)#no capability lls
```

capability opaque

Use this command to enable opaque-LSAs which are Type 9, 10 and 11 LSAs that deliver information used by external applications.

Use the `no` form of this command to disable the feature.

Command Syntax

```
capability opaque
no capability opaque
```

Parameters

None

Default

By default, opaque-LSA is enabled.

Command Mode

Router mode

Applicability

This command was introduced before OcNOS version 1.3.

Examples

```
#configure terminal
(config)#router ospf 100
(config-router)#capability opaque

(config)#router ospf 100
(config-router)#no capability opaque
```

capability traffic-engineering

Use this command to enable traffic engineering feature on OSPF router.

Use `no` parameter to disable traffic engineering feature on OSPF router.

Command Syntax

```
capability traffic-engineering
no capability traffic-engineering
```

Parameters

None

Default

No default value is specified

Command Mode

Router mode

Applicability

This command was introduced before OcNOS version 1.3.

Examples

```
#configure terminal
(config)#router ospf
(config-router)#capability traffic-engineering

(config-router)#no capability traffic-engineering
```

capability vrf-lite

Use this command to apply multi-VRF capability to OSPF process or to decouple the PE router from the VPN backbone.

Use `no` parameter to deny multi-VRF capability to OSPF process or to avoid decoupling the PE router from the VPN backbone.

Command Syntax

```
capability vrf-lite
no capability vrf-lite
```

Parameters

None

Default

No default value is specified

Command Mode

Router mode

Applicability

This command was introduced before OcNOS version 1.3.

Examples

```
#configure terminal
(config)#router ospf
(config-router)#capability vrf-lite

(config-router)#no capability vrf-lite
```

clear ip ospf

Use this command to clear and restart all OSPF routing processes or a given OSPF routing process.

Command Syntax

```
clear ip ospf (<0-65535>|) process
```

Parameter

<0-65535> Specify the process ID.

Command Mode

Privileged Exec Mode

Applicability

This command was introduced before OcnOS version 1.3.

Examples

```
#clear ip ospf process  
#clear ip ospf 555 process
```

compatible rfc1583

Use this command to restore the method used to calculate summary route costs per RFC.

RFC 1583 specified a method for calculating the metrics for summary routes based on the minimum metric of the component paths available. RFC 2328 specifies a method for calculating metrics based on maximum cost. With this change, it is possible that all of the ABRs in an area might not be upgraded to the new code at the same time. This command addresses this issue and allows the selective disabling of RFC 2328 compatibility.

Use the `no` parameter with this command to disable RFC 1583 compatibility.

Command Syntax

```
compatible rfc1583
no compatible rfc1583
```

Parameters

None

Default

By default, OSPF is RFC 2328 compatible

Command Mode

Router mode

Applicability

This command was introduced before OcNOS version 1.3

Examples

```
#configure terminal
(config)#router ospf 100
(config-router)#compatible rfc1583

(config)#router ospf 100
(config-router)#no compatible rfc1583
```

debug ip ospf dist-ls

Use this command to display information about OSPF BGP link state distribution.

Use the `no` parameter with this command to disable this function.

Command Syntax

```
debug ip ospf dist-ls
no debug ip ospf dist-ls
```

Parameters

None

Command Mode

Privileged Exec mode and Configure mode

Applicability

This command was introduced in OcNOS version 4.0.

Examples

```
#debug ip ospf dist-ls
```

debug ip ospf lfa

Use this command to specify the debugging options for OSPFv2 Loop-free Alternate path

Use the `no` parameter with this command to disable this function.

Command Syntax

```
debug ip ospf lfa
no debug ip ospf lfa
```

Parameters

None

Command Mode

Privileged Exec mode and Configure mode

Applicability

This command was introduced before OcnOS version 1.3.

Examples

```
#debug ip ospf lfa
```

debug ip ospf redistrib

Use this command to display debugging option for OSPF redistribute information

Use the `no` parameter with this command to disable this function.

Command Syntax

```
debug ip ospf redistrib (detail|terse|)
no debug ip ospf redistrib (detail|terse|)
```

Parameters

<code>detail</code>	Debug OSPF redistribute detail information
<code>terse</code>	Debug OSPF redistribute summary information

Command Mode

Privileged Exec mode and Configure mode

Applicability

This command was introduced before OcNOS version 1.3.

Examples

```
#debug ip ospf redistribute detail
```

debug ip ospf retransmission

Use this command to display debug logs of OSPF retransmission information.

Use the `no` parameter with this command to disable this function.

Command Syntax

```
debug ip ospf retransmission
no debug ip ospf retransmission
```

Parameters

None

Command Mode

Privileged Exec mode and Configure mode

Applicability

This command was introduced before OcnOS version 1.3

Examples

```
#debug ip ospf retransmission
```

debug ospf

Use this command to specify debugging options for OSPF.

Use the `no` parameter with this command to disable this function.

Command Syntax

```
debug ospf (all|bfd|database-timer|events|ifsm|lsa|nfsn|nsm| packet|route|sr|)
debug ospf rib ({interface|redistribute|})
no debug ospf (all|bfd|database-timer|events|ifsm|lsa|nfsn|nsm| packet|route|sr|)
undebug ospf (all|bfd|database-timer|events|ifsm|lsa|nfsn|nsm| packet|route|)
no debug all ospf
undebug all ospf
no debug all
no debug ospf rib ({interface|redistribute|})
undebug all
```

Parameters

<code>all</code>	Enable or disable debugging for <code>ifsm</code> , <code>nfsn</code> , <code>lsa</code> , <code>nsm</code> , <code>events</code> , and <code>route</code> .
<code>bfd</code>	Debug Bidirectional Forwarding Detection (BFD)
<code>database-timer</code>	Debug OSPF rate-limiting values for LSA throttling (see debug ospf database-timer rate-limit)
<code>events</code>	Debug OSPF events information (see debug ospf events)
<code>ifsm</code>	Debug OSPF Interface State Machine (see debug ospf ifsm)
<code>lsa</code>	Debug OSPF Link State Advertisement (see debug ospf lsa)
<code>nfsn</code>	Debug OSPF Neighbor State Machine (see debug ospf nfsn)
<code>nsm</code>	Debug OSPF NSM information (see debug ospf nsm)
<code>packet</code>	Debug OSPF packets (see debug ospf packet)
<code>route</code>	Debug OSPF route information (see debug ospf route)
<code>rib</code>	Debug OSPF RIB information (see debug ospf rib)
<code>sr</code>	Debug OSPF segment routing information
<code>interface</code>	Debug OSPF RIB interface
<code>redistribute</code>	Debug OSPF RIB redistribute

Command Mode

Privileged Exec mode and Configure mode

Applicability

This command was introduced before OcNOS version 1.3.

Examples

```
#debug ospf all
```

```
#debug ospf bfd
```

```
#no debug ospf bfd
```

debug ospf database-timer rate-limit

Use this command to log when link-state advertisement (LSA) rate-limiting timers will expire. These messages are logged only when `debug ospf lsa generate` or `debug ospf lsa refresh` is enabled

Use the `no` parameter with this command to disable this function.

Command Syntax

```
debug ospf database-timer rate-limit

no debug ospf database-timer rate-limit

undebug ospf database-timer rate-limit
```

Parameters

None

Command Mode

Privileged Exec mode and Configure mode

Applicability

This command was introduced before OcnOS version 1.3.

Examples

```
#debug ospf database-timer rate-limit

#undebug ospf database-timer rate-limit
```

debug ospf events

Use this command to specify debugging options for OSPF event troubleshooting. Use this command without parameters to turn on all the options.

Use the `no` parameter with this command to disable this function.

Command Syntax

```
debug ospf events ({abr|asbr|lsa|nssa|os|router|vlink|})
```

```
no debug ospf events ({abr|asbr|lsa|nssa|os|router|vlink|})
```

```
undebug ospf events ({abr|asbr|lsa|nssa|os|router|vlink|})
```

Parameters

<code>abr</code>	Debug OSPF ABR events.
<code>asbr</code>	Debug ASBR events.
<code>lsa</code>	Debug LSA events.
<code>nssa</code>	Debug NSSA events.
<code>os</code>	Debug OS interaction events.
<code>router</code>	Debug other router events.
<code>vlink</code>	Debug virtual link events.

Command Mode

Privileged Exec mode and Configure mode

Applicability

This command was introduced before OcNOS version 1.3.

Examples

```
#no debug ospf event abr
#debug ospf event asbr
#debug ospf event lsa
#no debug ospf event nssa
#debug ospf event os
#debug ospf event router
#debug ospf event vl
```

debug ospf ifsm

Use this command to specify debugging options for OSPF Interface Finite State Machine (IFSM) troubleshooting.

Use the `no` parameter with this command to disable this function.

Command Syntax

```
debug ospf ifsm ({events|status|timers}|)
```

```
no debug ospf ifsm ({events|status|timers}|)
```

```
undebug ospf ifsm ({events|status|timers}|)
```

Parameters

<code>events</code>	Debug IFSM event information
<code>status</code>	Debug IFSM status information
<code>timers</code>	Debug IFSM timer information

Command Mode

Privileged Exec mode and Configure mode

Applicability

This command was introduced before OcNOS version 1.3.

Examples

```
#no debug ospf ifsm events  
#debug ospf ifsm status  
#debug ospf ifsm timers
```

debug ospf lsa

Use this command to specify debugging options for OSPF Link State Advertisements (LSA) troubleshooting.

Use the `no` parameter with this command to disable this function.

Command Syntax

```
debug ospf lsa ({flooding|generate|install|maxage|refresh}|)
```

```
no debug ospf lsa ({flooding|generate|install|maxage|refresh}|)
```

```
undebug ospf lsa ({flooding|generate|install|maxage|refresh}|)
```

Parameters

<code>flooding</code>	Debug LSA flooding.
<code>generate</code>	Debug LSA generation.
<code>install</code>	Debug LSA installation.
<code>maxage</code>	Debug the maximum age processing.
<code>refresh</code>	Debug LSA refresh.

Command Mode

Privileged Exec mode and Configure mode

Applicability

This command was introduced before OcNOS version 1.3.

Examples

```
#no debug ospf lsa refresh
#debug ospf lsa flooding
#debug ospf lsa install
#debug ospf lsa maxage
#debug ospf lsa generate
```

debug ospf nfsm

Use this command to specify debugging options for OSPF Neighbor Finite State Machines (NFSMs).

Use the `no` parameter with this command to disable this function.

Command Syntax

```
debug ospf nfsm ({events|status|timers}|)
```

```
no debug ospf nfsm ({events|status|timers}|)
```

```
undebug ospf nfsm ({events|status|timers}|)
```

Parameters

<code>events</code>	Debug NFSM event information
<code>status</code>	Debug NFSM status information
<code>timers</code>	Debug NFSM timer information

Command Mode

Privileged Exec mode Configure mode

Applicability

This command was introduced before OcNOS version 1.3.

Examples

```
#debug ospf nfsm events  
#no debug ospf nfsm timers
```

debug ospf nsm

Use this command to specify debugging options for OSPF NSM information.

Use the `no` parameter with this command to disable this function.

Command Syntax

```
debug ospf nsm ({interface|redistribute|})  
  
no debug ospf nsm ({interface|redistribute|})  
undebug ospf nsm ({interface|redistribute|})
```

Parameters

<code>interface</code>	Debug NSM interface information.
<code>redistribute</code>	Debug NSM redistribute information.

Command Mode

Privileged Exec mode and Configure mode

Applicability

This command was introduced before OcNOS version 1.3.

Example

The `debug ospf nsm` command enables the display of debug information related to NSM.

```
#debug ospf nsm interface  
#no debug ospf nsm redistribute
```

debug ospf packet

Use this command to specify debugging options for OSPF packets.

Use the `no` parameter with this command to disable this function.

Command Syntax

```
debug ospf packet ({hello|dd|ls-request|ls-update|ls-ack|send|recv|detail}|)
```

```
no debug ospf packet ({hello|dd|ls-request|ls-update|ls-ack|send|recv|detail}|)
```

```
undebug ospf packet ({hello|dd|ls-request|ls-update|ls-ack|send|recv|detail}|)
```

Parameters

<code>hello</code>	Debug OSPF hello packets.
<code>dd</code>	Debug OSPF database.
<code>ls-request</code>	Debug OSPF link state requests.
<code>ls-update</code>	Debug OSPF link state updates.
<code>ls-ack</code>	Debug OSPF link state acknowledgments.
<code>send</code>	Debug OSPF sent packets.
<code>recv</code>	Debug OSPF received packets.
<code>detail</code>	Debug OSPF detailed information.

Command Mode

Privileged Exec mode and Configure mode

Applicability

This command was introduced before OcNOS version 1.3.

Examples

```
#debug ospf packet detail
#debug ospf packet dd send detail
#no debug ospf packet ls-request recv detail
```

debug ospf rib

Use this command to display debug information about the interaction between the OSPF process and the Routing Information Base (RIB).

Use `no` parameter of this command to disable debugging output.

Command Syntax

```
debug ospf rib ({interface|redistribute}|)
no debug ospf rib ({interface|redistribute}|)
debug ip ospf redistribute
no debug ip ospf redistribute
```

Parameters

<code>interface</code>	Debug RIB interface information.
<code>redistribute</code>	Debug RIB redistribute information.

Command Mode

Privileged Exec mode and Configure mode

Applicability

This command was introduced before OcNOS version 1.3.

Example

```
#debug ospf rib interface
#no debug ospf rib redistribute
```

debug ospf route

Use this command to debug route calculation. Use this command without parameters to turn on all the options.

Use the `no` parameter with this command to disable this function.

Command Syntax

```
debug ospf route ({ase|ia|install|spf|})
no debug ospf route ({ase|ia|install|spf|})
undebug ospf route ({ase|ia|install|spf|})
```

Parameters

<code>ase</code>	Debug OSPF external route calculation.
<code>ia</code>	Debug OSPF Inter-Area route calculation.
<code>install</code>	Debug OSPF route installation.
<code>spf</code>	Debug OSPF SPF calculation.

Command Mode

Privileged Exec mode and Configure mode

Applicability

This command was introduced before OcNOS version 1.3.

Examples

```
#debug ospf route
#no debug ospf route ia
#debug ospf route install
```

default-information originate

Use this command to create a default external route into an OSPF routing domain.

Use the `no` parameter with this command to disable this feature.

The system acts like an Autonomous System Boundary Router (ASBR) when you use the `default-information originate` command to redistribute routes into an OSPF routing domain. An ASBR does not by default generate a default route into the OSPF routing domain.

When you give the `default-information originate` command, also specify a `route-map` to avoid a dependency on the default network in the routing table.

Command Syntax

```
default-information originate
default-information originate {metric <0-16777214>|metric-type (1|2)|route-map
WORD|always}
no default-information originate
no default-information originate {metric|metric-type|route-map|always}
```

Parameters

<code>always</code>	Used to advertise the default route regardless of whether there is a default route.
<code>metric</code>	Sets the OSPF metric used in creating the default route.
<code><0-16777214></code>	Sets the OSPF metric used in creating the default route. The default metric value is 10. The value used is specific to the protocol.
<code>metric-type</code>	The external link type associated with the default route advertised into the OSPF routing domain (see RFC 3101).
<code>1</code>	Sets OSPF External Type 1 metric.
<code>2</code>	Sets OSPF External Type 2 metric (default).
<code>route-map</code>	Route map.
<code>WORD</code>	Specify the name of route map.

Default

Sets the OSPF metric used in creating the default route. The default metric value is 10.

The value used is specific to the protocol. `metric-type` The external link type associated with the default route advertised into the OSPF routing domain (see RFC 3101).

By default, 2 Sets OSPF External Type 2 metric.

Command Mode

Router mode

Applicability

This command was introduced before OcNOS version 1.3.

Examples

```
#configure terminal
(config)#router ospf 100
(config-router)#default-information originate always metric 23 metric-type 2
route-map myinfo

(config)#router ospf 100
(config-router)#no default-information originate metric metric-type route-map
```

default-metric

Use this command to set a default metric for OSPF.

A default metric facilitates redistributing routes with incompatible metrics. If the metrics do not convert, the default metric provides an alternative. Use this command to use the same metric value for all redistributed routes. Use this command in conjunction with the [redistribute](#) command.

Use the `no` parameter with this command to return to the default state.

Command Syntax

```
default-metric <1-16777214>
no default-metric
```

Parameters

<1-16777214> Default metric value.

Default

Built-in, automatic metric translations, as appropriate for each routing protocol.

Command Mode

Router mode

Applicability

This command was introduced before OcnOS version 1.3.

Examples

```
#configure terminal
(config)#router ospf 100
(config-router)#default-metric 100
```

distance

Use this command to set OSPF administrative distances.

The administrative distance rates the trustworthiness of a routing information source. A higher distance value means a lower trust rating. For example, an administrative distance of 255 means that the routing information source cannot be trusted and should be ignored.

Use the `no` form of this command to restore the default value (110).

Command Syntax

```
distance <1-255>
distance <1-255> A.B.C.D/M (WORD|)
distance ospf {intra-area <1-255>|inter-area <1-255>|external <1-255>}
no distance <1-255>
no distance <1-255> A.B.C.D/M (WORD|)
no distance ospf {intra-area |inter-area |external}
```

Parameters

<code><1-255></code>	Used alone, this parameter specifies a default administrative distance used when no other specification exists for a routing information source.
<code>intra-area</code>	Routes within an area.
<code><1-255></code>	Distance for all routes within an area
<code>inter-area</code>	Routes from one area to another area.
<code><1-255></code>	Distance for all routes from one area to another area.
<code>external</code>	Routes from other routing domains learned by redistribution.
<code><1-255></code>	Distance for routes from other routing domains learned by redistribution.
<code>A.B.C.D/M</code>	Distance for routes to prefixes whose nexthop matches this address.
<code>WORD</code>	Name of access list to apply to route updates.

Default

By default, distance for each type of route (intra-, inter-, or external) is 110

Command Mode

Router mode

Applicability

This command was introduced before OcnOS version 1.3.

Examples

```
#configure terminal
(config)#router ospf 100
(config-router)#distance ospf inter-area 20 intra-area 10 external 40
```

distribute-list

Use this command to filter networks in routing updates. This command redistributes other routing protocols into the OSPF routing table.

Use the `no` parameter with this command to disable this function.

Command Syntax

```
distribute-list WORD out (kernel|connected|static|rip|bgp|isis|ospf (<0-65535>|))
distribute-list WORD in
no distribute-list WORD out (kernel|connected|static|rip|bgp|isis|ospf (<0-65535>|))
no distribute-list WORD in
```

Parameters

<code>WORD</code>	Specify the name of the access list.
<code>in</code>	Filter incoming routing updates.
<code>out</code>	Filter outgoing routing updates.
<code>kernel</code>	Specify kernel routes.
<code>connected</code>	Specify connected routes.
<code>static</code>	Specify static routes.
<code>rip</code>	Specify RIP routes.
<code>bgp</code>	Specify BGP routes.
<code>isis</code>	Specify IS-IS routes.
<code>ospf</code>	Specify OSPF process.
<code><1-65535></code>	Specify OSPF process ID <code><1-65535></code> . If not specified, this command redistribute OSPF instance with process ID 0.

Default

No default value is specified

Command Mode

Router mode

Applicability

This command was introduced before OcNOS version 1.3.

Examples

The following example shows the distribution of BGP routing updates based on the access list `list1` (network 172.10.0.0).

```
#configure terminal
(config)#access-list list1 permit 172.10.0.0
(config)#router ospf 100
(config-router)#distribute-list list1 out bgp
```

```
(config-router)#redistribute bgp
```

enable db-summary-opt

Use this command to enable the database summary list optimization for OSPFv2.

When this feature is enabled, the database exchange process is optimized by removing the LSA from the database summary list for the neighbor, if the LSA instance in database summary list is the same as or less recent than the listed LSA in the database description packet received from the neighbor.

Use the `no` form of this command to disable database summary list optimization.

Command Syntax

```
enable db-summary-opt
no enable db-summary-opt
```

Parameters

None

Default

By default, database summary list optimization for OSPFv2 is disabled

Command Mode

Router mode

Applicability

This command was introduced before OcNOS version 1.3.

Examples

```
#configure terminal
(config)#router ospf
(config-router)#enable db-summary-opt
(config-router)#no enable db-summary-opt
```

enable ext-ospf-multi-inst

Use this command to run multiple OSPF instances on a subnet.

Use the `no` parameter with this command to disable OSPF multiple-instance support and reset all OSPF instances to the default instance ID.

Command Syntax

```
enable ext-ospf-multi-inst
no enable ext-ospf-multi-inst
```

Parameters

None

Default

Multiple-instance support is disabled. The default instance ID is 0.

Command Mode

Configure mode

Applicability

This command was introduced before OcNOS version 1.3.

Examples

```
#configure terminal
(config)#enable ext-ospf-multi-inst
```

fast-reroute keep-all-paths

Use this command to enable fast rerouting on all OSPF interfaces.

Use the `no` parameter with this command to disable fast rerouting.

Command Syntax

```
fast-reroute keep-all-paths
no fast-reroute keep-all-paths
```

Parameters

None

Defaults

By default, fast rerouting is disabled

Command Mode

Router mode

Applicability

This command was introduced before OcnOS version 1.3.

Examples

```
#configure terminal
(config)#router ospf 200
(config-router)#fast-reroute keep-all-paths
```

fast-reroute per-prefix remote-lfa area

Use this command to configure remote-lfa on an area in OSPF.

Use the `no` form of this command remove the remote-lfa configuration.

Command Syntax

```
fast-reroute per-prefix remote-lfa area (A.B.C.D|<0-4294967295>) tunnel mpls-ldp
no fast-reroute per-prefix remote-lfa area (A.B.C.D|<0-4294967295>) tunnel mpls-ldp
```

Parameters

A.B.C.D	Area-id in ip address notation.
0-4294967295	Area-id in integer notation.

Command Mode

Router OSPF mode.

Applicability

This command was introduced before OcNOS version 6.0.0.

Examples

```
(config)#router ospf 1
(config-router)#fast-reroute per-prefix remote-lfa area 0 tunnel mpls-ldp
(config-router)#

(config-router)#no fast-reroute per-prefix remote-lfa area 0 tunnel mpls-ldp
(config-router)#commit
```

fast-reroute per-prefix route-map

Use this command to configure route-map in OSPF for fast-reroute calculation.

Use the `no` form of this command remove the route-map applied on fast-reroute calculation.

Command Syntax

```
fast-reroute per-prefix route-map WORD
no fast-reroute per-prefix route-map
```

Parameters

WORD Route-map name.

Command Mode

Router ospf mode.

Applicability

This command was introduced before OcNOS version 6.0.0.

Examples

```
(config)#router ospf 1
(config-router)#fast-reroute per-prefix route-map rmap1
(config-router)#

(config-router)#no fast-reroute per-prefix route-map
(config-router)#commit
```

fast-reroute terminate-hold-on interval

Use this command to set the delay of primary route installation (to avoid micro loop) after a failover.

Use the no form of this command to set the termination hold-on timer to its default value (600 milliseconds).

Command Syntax

```
fast-reroute terminate-hold-on interval <100-100000>
no fast-reroute terminate-hold-on interval
```

Parameters

<100-100000>Hold on interval in milliseconds

Defaults

600 milliseconds

Command Mode

Router mode

Applicability

This command was introduced before OcNOS version 1.3.

Examples

```
#configure terminal
(config)#router ospf 1
(config-router)#fast-reroute terminate-hold-on interval 7000
(config-router)#no fast-reroute terminate-hold-on interval
```

fast-reroute tie-break

Use this command to set the tie-breaking policy for selecting a fast reroute repair path. You assign a priority to each type of repair path. The tie-breaker value is used to select an LFA FRR route when multiple LFA FRR routes are available for the same primary route.

Use the `no` form of this command to set the tie-break preference value for a protection type to its default value as shown in [Table 1-30](#).

To set all types of repair paths to their default priorities, do not specify a repair path with the `no` form of this command.

Command Syntax

```
fast-reroute tie-break (primary-path|interface-disjoint|node-protecting|broadcast-
  interface-disjoint|downstream-path|secondary-path) index <1-255>
no fast-reroute tie-break
no fast-reroute tie-break (primary-path|interface-disjoint|node-
  protecting|broadcast-interface-disjoint|downstream-path|secondary-path)
```

Parameters

<code>primary-path</code>	Use a path from the Equal-Cost Multipath Path (ECMP) set. An ECMP found during the primary shortest path first (SPF) repair might not be desirable in networks where traffic exceeds the capacity of any single link.
<code>interface-disjoint</code>	Prefer a backup path that uses a different interface than the interface used to reach destination via the primary path.
<code>node-protecting</code>	Bypass the <code>primary-path</code> gateway router which might not protect the router that is the next hop in the primary path. This ensures complete traffic protection even if the primary next-hop router fails.
<code>broadcast-interface-disjoint</code>	Do not use the interface if connected to a broadcast network. Repair paths protect links when a repair path and a protected primary path use <i>different</i> next-hop interfaces. However, on broadcast interfaces, if the repair path is computed via the same interface as the primary path, but their next-hop gateways are different, the router is protected but the link might not be.
<code>downstream-path</code>	Prefer a backup path to the destination which satisfies the downstream condition where the path cost to reach the destination from the LFA next hop is less than the path cost to the destination from the self node via primary next hop: $\text{Distance_opt}(N, D) < \text{Distance_opt}(S, D)$ This might result in lost traffic, but prevents looping.
<code>secondary-path</code>	Prefer a non-ECMP backup path.
<code>index</code>	Tie break priority. A lower value has higher preference.
<code><1-255></code>	Range of priority values.

Defaults

primary-path	20
interface-disjoint	60
node-protecting	30
broadcast-interface-disjoint	70
secondary-path	255
downstream-path	90

Command Mode

Router mode

Applicability

This command was introduced before OcNOS version 1.3.

Examples

```
#configure terminal
(config)#router ospf 200
(config-router)#fast-reroute tie-break interface-disjoint index 1
```

host area

Use this command to configure a stub host entry belonging to a particular area.

Using this command, you can advertise specific host routes in the router-LSA as stub link. Since stub host belongs to the specified router, specifying cost is not important.

Use the `no` form of this command to remove the host area configuration.

Command Syntax

```
host A.B.C.D area (A.B.C.D|<0-4294967295>)
host A.B.C.D area (A.B.C.D|<0-4294967295>) cost <0-65535>
no host A.B.C.D area (A.B.C.D|<0-4294967295>)
no host A.B.C.D area (A.B.C.D|<0-4294967295>) cost
```

Parameters

A.B.C.D	Specify IP address of the host.
area	Set the OSPF area ID
A.B.C.D	OSPF Area ID in IPv4 address format.
<0-4294967295>	OSPF Area ID as a decimal value.
cost	Specify cost for stub host entry.
<0-65535>	Specify cost for stub host entry.

Default

No host entry is configured

Command Mode

Router mode

Applicability

This command was introduced before OcnOS version 1.3.

Examples

```
#configure terminal
(config)#router ospf 100
(config-router)#host 172.16.10.100 area 1
(config-router)#host 172.16.10.101 area 2 cost 10
```

ip ospf authentication

Use this command to send and receive OSPF packets with the specified authentication method on the current interface.

Use the `no` parameter with this command to disable the authentication.

Command Syntax

```
ip ospf authentication (null|message-digest|)
ip ospf A.B.C.D authentication (null|message-digest|)
no ip ospf (A.B.C.D|) authentication
```

Parameters

A.B.C.D	The IP address of the interface.
null	Use no authentication.
message-digest	Use message digest authentication.

Default

No default value is specified

Command Mode

Interface mode

Applicability

This command was introduced before OcnOS version 1.3.

Examples

In this example, interface `eth0` is configured to have no authentication. This will override any `text` or `MD5` authentication configured on this interface.

```
#configure terminal
(config)#interface eth0
(config-if)#ip ospf authentication null
```

ip ospf authentication-key

Use this command to specify an OSPF authentication password for neighboring routers.

This command creates a password (key) that is inserted into the OSPF header when OcnOS originates packets. Assign a separate password to each network for different interfaces. All neighboring routers on the same network with the same password exchange OSPF routing data.

The key can be used only when authentication is enabled for an area with the `area authentication` command.

Simple password authentication allows a password to be configured for each area. Configure the routers in the same routing domain with the same password.

Use the `no` parameter with this command to remove an OSPF authentication password.

Command Syntax

```
ip ospf (A.B.C.D|) authentication-key WORD
no ip ospf (A.B.C.D|) authentication-key
```

Parameters

A.B.C.D	The IP address of the interface.
authentication-key	
	Specify the authentication password.
WORD	Specify the OSPF Encrypted password (key) of 8 bytes.

Default

By default, no password used when exchanging OSPF routing data

Command Mode

Interface mode

Applicability

This command was introduced before OcnOS version 1.3.

Examples

In the following example, an authentication key `test` is created on interface `eth0` in area 0. Note that first authentication is enabled for area 0.

```
#configure terminal
(config)#router ospf 100
(config-router)#network 10.10.10.0/24 area 0
(config-router)#area 0 authentication
(config-router)#exit
(config)#interface eth0
(config-if)#ip ospf 3.3.3.3 authentication-key test

#sh run int xel
!
interface xel
ip ospf authentication
ip ospf authentication-key 0x94eebee8c349a4b0
```

```
!  
(config)#int xe1  
(config-if)#ip ospf authentication-key 0x94eebee8c349a4b0 - encrypted password of 16  
characters which can be obtained from sh run <int>
```

ip ospf bfd

Use this command to enable Bidirectional Forwarding Detection (BFD).

Use this command with either the `no` or `disable` parameter to disable BFD.

Command Syntax

```
ip ospf bfd (disable|)
no ip ospf bfd (disable|)
```

Parameters

`disable` Specify to disable BFD.

Default

By default, `ip ospf bfd` is disabled

Command Mode

Interface mode

Applicability

This command was introduced before OcnOS version 1.3.

Examples

```
#configure terminal
(config)#interface eth0
(config-if)#ip ospf bfd
```

ip ospf cost

Use this command to explicitly specify the cost of the link-state metric in a router-LSA.

The interface cost indicates the overhead required to send packets across an interface. This cost is stated in the Router-LSA's link. The cost is inversely proportional to the bandwidth of an interface. By default, the cost of an interface is calculated based on the bandwidth ($10^8 / \text{bandwidth}$). Use this command to set the cost manually.

Use the `no` parameter with this command to reset the cost to its default value.

Command Syntax

```
ip ospf (A.B.C.D|) cost <1-65535>
no ip ospf (A.B.C.D|) cost
```

Parameters

A.B.C.D	The IP address of the interface.
<1-65535>	Link-state metric.

Default

By default, the cost of an interface is calculated based on the bandwidth ($10^8 / \text{bandwidth}$). The default cost value is 10.

Command Mode

Interface mode

Applicability

This command was introduced before OcnOS version 1.3.

Examples

The following example shows setting the cost as 10 on interface `eth0` for IP address 10.10.10.50.

```
#configure terminal
(config)#interface eth0
(config-if)#ip ospf 10.10.10.50 cost 10
```

ip ospf database-filter

Use this command to turn on the LSA database-filter for a particular interface.

OSPF floods new LSAs over all interfaces in an area, except the interface on which the LSA arrives. This redundancy ensures robust flooding. However, too much redundancy can waste bandwidth and might lead to excessive link and CPU usage in certain topologies, resulting in destabilizing the network. To avoid this, use this command to block flooding of LSAs over specified interfaces.

Use the `no` parameter with this command to turn off the filter.

Command Syntax

```
ip ospf (A.B.C.D|) database-filter all out
no ip ospf (A.B.C.D|) database-filter
```

Parameters

A.B.C.D The IP address of the interface.

Default

Disabled, all outgoing LSAs are flooded to the interface.

Command Mode

Interface mode

Applicability

This command was introduced before OcnOS version 1.3.

Examples

```
#configure terminal
(config)#interface eth0
(config-if)#ip ospf database-filter all out
```

ip ospf dead-interval

Use this command to set the interval during which the router waits to receive an OSPF hello packet from the neighbor before declaring the neighbor down. This value is advertised in the router's hello packets. It must be a multiple of hello-interval and be the same for all routers on a specific network.

Use the `no` parameter with this command to return to the default time. If you have configured this command specifying the IP address of the interface and want to remove the configuration, use the `no` parameter with the specified IP address (`no ip ospf dead-interval A.B.C.D`).

Command Syntax

```
ip ospf (A.B.C.D|) dead-interval <1-65535>
no ip ospf (A.B.C.D|) dead-interval
```

Parameters

A.B.C.D	The IP address of the interface.
dead-interval	Specify the interval.
<1-65535>	Specify the interval in seconds.

Default

By default, dead interval is 40 seconds

Command Mode

Interface mode

Applicability

This command was introduced before OcnOS version 1.3.

Examples

The following example shows configuring dead-interval for 10 seconds on eth0 interface.

```
#configure terminal
(config)#interface eth0
(config-if)#ip ospf dead-interval 10
```

ip ospf demand-circuit

Use this command to enable Hello Suppression and LSA Suppression sent on OSPF interface. Enabling demand circuit on one interface enables hello suppression only for that particular interface.

Note: Hellos and LSAs are suppressed on Point-to-point and Point-to-multipoint links and only LSAs are suppressed for a broadcast link.

Use the no parameter with this command to disable Hello Suppression and LSA Suppression

Command Syntax

```
ip ospf demand-circuit
no ip ospf demand-circuit
```

Parameters

None

Command Mode

Interface mode

Applicability

This command was introduced before OcNOS version 1.3.

Examples

The following example shows configuring demand-circuit on eth1 interface.

```
#configure terminal
(config)#interface eth1
(config-if)#ip ospf demand-circuit

(config-if)#no ip ospf demand-circuit
```

ip ospf disable

Use this command to completely disable OSPF packet processing on an interface.

This command overrides the [network](#) command.

Use the `no` option with this command to return to the default setting.

Command Syntax

```
ip ospf disable all
no ip ospf disable all
```

Parameters

None

Default

By default, this feature is disabled

Command Mode

Interface mode

Applicability

This command was introduced before OcNOS version 1.3.

Example

```
#configure terminal
(config)#interface eth0
(config-if)#ip ospf disable all
```

ip ospf fast-reroute per-prefix candidate disable

Use this command to prohibit the interface from being used as the next hop in a repair path.

Use the `no` option with this command to use the interface as the next hop in a repair path.

Command Syntax

```
ip ospf fast-reroute per-prefix candidate disable
no ip ospf fast-reroute per-prefix candidate disable
```

Parameters

None

Default

No default value is specified

Command Mode

Interface mode

Applicability

This command was introduced before OcnOS version 1.3.

Example

```
#configure terminal
(config)#interface eth0
(config-if)#ip ospf fast-reroute per-prefix candidate disable
```

ip ospf flood-reduction

Use this command to enable flood reduction on an interface. When this command is configured, an LSA sent out on the interface is set with the DNA bit in the LSA age field. The LSA is not refreshed every refresh interval if there is no change in LSA. Only changed LSAs are sent out on the interface

Use the `no` option with this command to disable flood reduction on an interface.

Command Syntax

```
ip ospf flood-reduction
no ip ospf flood-reduction
```

Parameters

None

Default

By default, flood reduction on an interface is disabled

Command Mode

Interface mode

Applicability

This command was introduced before OcNOS version 1.3.

Example

```
#configure terminal
(config)#interface eth1
(config-if)#ip ospf flood-reduction

(config-if)#no ip ospf flood-reduction
```

ip ospf hello-interval

Use this command to specify the interval between hello packets.

The hello-interval is advertised in the hello packets. Configure the same hello-interval for all routers on a specific network. A shorter hello interval ensures faster detection of topological changes but results in more routing traffic.

Use the `no` parameter with this command to return to the default time.

Command Syntax

```
ip ospf (A.B.C.D|) hello-interval <1-65535>
no ip ospf (A.B.C.D|) hello-interval
```

Parameters

A.B.C.D	The IP address of the interface.
hello-interval	Specify the interval.
<1-65535>	Specify the interval in seconds.

Default

By default, hello interval is 10 seconds

Command Mode

Interface mode

Applicability

This command was introduced before OcnOS version 1.3.

Examples

The following example shows setting the hello-interval for 3 seconds on interface eth0.

```
#configure terminal
(config)#interface eth0
(config-if)#ip ospf hello-interval 3
```

ip ospf multi-area

Use this command to enable multi-area adjacency on point-to-point network and other network types. Multi-area adjacency establishes adjacency between the Area Border Routers (ABRs). The interface of the ABR where this command is configured, shall be associated with multiple areas.

Use the `no` parameter to disable multi-area adjacency on the given interface on point-to-point network.

Command Syntax

```
ip ospf <0-65535> multi-area (A.B.C.D|<0-4294967295>) (neighbor A.B.C.D |)
no ip ospf <0-65535> multi-area (A.B.C.D|<0-4294967295>) (neighbor|)
```

Parameters

<0-65535>	OSPF process ID.
A.B.C.D	OSPF area ID in IP address format.
<0-4294967295>	OSPF area ID as a decimal value.
A.B.C.D	Neighbor IP address.

Default

By default, multi-area adjacency is disabled

Command Mode

Interface mode

Applicability

This command was introduced before OcnOS version 1.3.

Examples

```
#configure terminal
(config)#interface eth1
(config-if)#ip ospf 0 multi-area 1

(config-if)# no ip ospf 0 multi-area 1
```

ip ospf message-digest-key

Use this command to register an MD5 key for OSPF authentication.

Use the `no` parameter with this command to remove an MD5 key.

Message Digest Authentication is cryptographic authentication. A key (password) and key-id are configured on each router. The router uses an algorithm based on the OSPF packet, the key, and the key-id to generate a message digest that is appended to the packet.

Use this command for uninterrupted transitions between passwords. This is helpful for administrators who want to change the OSPF password without disrupting communication. The system begins a rollover process until all the neighbors have adopted the new password. This allows neighboring routers to continue communication while the network administrator is updating them with a new password. The router will stop sending duplicate packets once it detects that all of its neighbors have adopted the new password.

Maintain only one password per interface, removing the old password whenever you add a new one. This prevents the local system from continuing to communicate with the system that is using the old password. Removing the old password also reduces overhead during rollover. All neighboring routers on the same network must have the same password value to enable exchange of OSPF routing data.

Command Syntax

```
ip ospf (A.B.C.D|) message-digest-key <1-255> md5 WORD
no ip ospf (A.B.C.D|) message-digest-key <1-255>
```

Parameters

A.B.C.D	IPv4 address of the interface.
message-digest-key	
<1-255>	Message digest authentication password (key). Specify a key ID.
md5	Specify a key (password) (1-16 characters).
WORD	Specify an encrypted password (key).

Default

By default, MD5 key for OSPF authentication is disabled.

Command Mode

Interface mode

Applicability

This command was introduced before OcNOS version 1.3.

Examples

The following example shows OSPF authentication on the interface eth0 when IP address has not been specified.

```
#configure terminal
(config)#interface eth0
(config-if)#ip ospf authentication message-digest
(config-if)#ip ospf message-digest-key 1 md5 yourpass
```

```
(config-if)#sh run int xe1
```

```
!
```

```
interface xe1
```

```
ip ospf authentication
```

```
ip ospf authentication-key 0x94eebee8c349a4b0
```

```
ip ospf message-digest-key 1 md5 0x94eebee8c349a4b0
```

```
!
```

```
(config-if)#ip ospf message-digest-key 1 md5 0x94eebee8c349a4b0 - encrypted  
password of 16 characters which can be obtained from sh run <int>
```

The following example shows OSPF authentication on the interface eth0 for the IP address 1.1.1.1. (If the interface has two IP addresses assigned-- 1.1.1.1 & 2.2.2.2, OSPF authentication will be enabled only for the IP address 1.1.1.1)

```
(config)#interface eth0
```

```
(config-if)#ip ospf 1.1.1.1 authentication message-digest
```

```
(config-if)#ip ospf 1.1.1.1 message-digest-key 2 md5 yourpass
```

ip ospf mtu

Use this command to set MTU size for OSPF to construct packets based on this value. Whenever OSPF constructs packets, it uses interface MTU size as Maximum IP packet size. This command forces OSPF to use the specified value overriding the actual interface MTU size.

This command does not configure the MTU settings in the kernel. OSPF does not recognize MTU size changes made in the kernel until the MTU size is updated through this command.

Use the `no` parameter with this command to return to the default value.

Command Syntax

```
ip ospf mtu <576-65535>
no ip ospf mtu
```

Parameters

<code>mtu</code>	Specify an MTU size.
<code><576-65535></code>	Specify an MTU size.

Default

By default, OSPF uses interface MTU derived from the kernel.

Command Mode

Interface mode

Applicability

This command was introduced before OcnOS version 1.3.

Examples

```
#configure terminal
(config)#interface eth0
(config-if)#ip ospf mtu 1480
```

ip ospf mtu-ignore

Use this command to configure OSPF so that it does not check the MTU size during DD (Database Description) exchange.

Use the `no` form of this command to make OSPF check the MTU size during DD exchange.

Command syntax

```
ip ospf (A.B.C.D|) mtu-ignore
no ip ospf (A.B.C.D|) mtu-ignore
```

Parameters

A.B.C.D IP address of the interface.

Default

By default, during the DD exchange process, OSPF checks the MTU size described in DD packets received from its neighbor. If the MTU size does not match the interface MTU, the neighbor adjacency is not established. Using this command makes OSPF ignore this check and allows establishing of adjacency regardless of MTU size in the DD packet.

Command Mode

Interface mode

Applicability

This command was introduced before OcNOS version 1.3.

Examples

```
#configure terminal
(config)#interface eth0
(config-router)#ip ospf mtu-ignore
```

ip ospf network

Use this command to set the OSPF network type.

Use the `no` parameter with this command to return to the default value.

Command Syntax

```
ip ospf network (broadcast|non-broadcast|point-to-multipoint|point-to-point)
ip ospf network point-to-multipoint non-broadcast
no ip ospf network
```

Parameters

<code>broadcast</code>	Sets the network type to broadcast.
<code>non-broadcast</code>	Sets the network type to NBMA.
<code>point-to-multipoint</code>	Sets the network type to point-to-multipoint.
<code>non-broadcast</code>	Sets the network type to NBMA.
<code>point-to-point</code>	Sets the network type to point-to-point.

Default

By default, OSPF network type is broadcast

Command Mode

interface mode

Applicability

This command was introduced before OcnOS version 1.3.

Examples

The following example shows setting the network to `point-to-point` type on the `eth0` interface.

```
#configure terminal
(config)#interface eth0
(config-if)#ip ospf network point-to-point
```

ip ospf priority

Use this command to set the router priority to determine the designated router (DR) for the network.

A router with the higher router priority becomes the DR. If the priority is the same for two routers, the router with the higher router ID takes precedence.

Only routers with a nonzero priority value are eligible to become the designated or backup designated router. Configure router priority for broadcast or NBMA networks only and not for point-to-point networks.

Use the `no` parameter with this command to return to the default value.

Command Syntax

```
ip ospf (A.B.C.D|) priority <0-255>
no ip ospf (A.B.C.D|) priority
```

Parameters

A.B.C.D	The IP address of the interface.
priority	Specify the router priority of the interface.
<0-255>	Specify the router priority of the interface. The default value is 1.

Default

By default, `ip ospf priority` is 1

Command Mode

Interface mode

Applicability

This command was introduced before OcnOS version 1.3.

Examples

The following example shows setting the OSPF priority value to 3 on the `eth0` interface.

```
#configure terminal
(config)#interface eth0
(config-if)#ip ospf priority 3
```

ip ospf resync-timeout

Use this command to set the interval after which adjacency is reset if out-of-band re-synchronization has not occurred. The interval period starts from the time a restart signal is received from a neighbor.

Use the `no` parameter with this command to set the default value (40 seconds).

Command Syntax

```
ip ospf (A.B.C.D|) resync-timeout <1-65535>
no ip ospf (A.B.C.D|) resync-timeout
```

Parameters

A.B.C.D	IP address of the interface.
<1-65535>	Re-synchronization timeout of the interface in seconds.

Default

By default, the re-synchronization timeout is 40 seconds.

Command Mode

Interface mode

Applicability

This command was introduced before OcnOS version 1.3.

Examples

The following example shows setting the OSPF re-synchronization timeout value to 65 seconds on the `eth0` interface.

```
#configure terminal
(config)#interface eth0
(config-if)#ip ospf resync-timeout 65
```

ip ospf retransmit-interval

Use this command to specify the time between link-state advertisement (LSA) retransmissions for adjacencies belonging to the interface.

After sending an LSA to a neighbor, the router keeps the LSA until it receives an acknowledgement. If the router does not receive an acknowledgement during the retransmit interval, it retransmits the LSA. Set the retransmission interval value conservatively to avoid needless retransmission. The interval should be greater than the expected round-trip delay between two routers.

Use the `no` parameter with this command to return to the default value.

Command Syntax

```
ip ospf (A.B.C.D|) retransmit-interval <1-3600>
no ip ospf (A.B.C.D|) retransmit-interval
```

Parameters

A.B.C.D	The IPv4 address of the interface.
retransmit-interval	
	Specify the interval.
<1-3600>	Specify the interval in seconds.

Default

By default, retransmit interval is 5 seconds

Command Mode

Interface mode

Applicability

This command was introduced before OcnOS version 1.3.

Examples

The following example shows setting the `ospf retransmit interval` to 6 seconds on the `eth0` interface.

```
#configure terminal
(config)#interface eth0
(config-if)#ip ospf retransmit-interval 6
```

ip ospf transmit-delay

Use this command to set the estimated time it takes to transmit a link-state-update packet on the interface.

The transmit delay value adds a specified time to the age field of an update. If the delay is not added, the time in which the LSA transmits over the link is not considered. This command is especially useful for low speed links. Add transmission and propagation delays when setting the transmit delay value.

Use the `no` parameter with this command to return to the default value (1 second).

Command Syntax

```
ip ospf (A.B.C.D|) transmit-delay <1-3600>
no ip ospf (A.B.C.D|) transmit-delay
```

Parameters

A.B.C.D	IPv4 address of the interface.
<1-3600>	Time in seconds to transmit a link-state update.

Default

By default, the transmit delay is 1 second

Command Mode

Interface mode

Applicability

This command was introduced before OcnOS version 1.3.

Examples

The following example shows setting the OSPF transmit delay time to 3 seconds on the `eth0` interface.

```
#configure terminal
(config)#interface eth0
(config-if)#ip ospf transmit-delay 3
```

log-adjacency-changes

Use this command for the router to send a SYSLOG message when an OSPF neighbor goes up or down.

Use `no` parameter of this command to stop sending SYSLOG message.

Command Syntax

```
log-adjacency-changes (brief|detail|)
no log-adjacency-changes
```

Parameters

<code>brief</code>	Sends a SYSLOG message for each state change, not just when a neighbor goes up or down.
<code>detail</code>	Sends a SYSLOG message for each state change, not just when a neighbor goes up or down.

Default

If not specified, `brief` is the default option.

Command Mode

Router mode

Applicability

This command was introduced before OcnOS version 1.3.

Examples

```
#configure terminal
(config)#router ospf 100
(config-router)#log-adjacency-changes
(config-router)#log-adjacency-changes detail

(config-router)#no log-adjacency-changes
(config-router)#no log-adjacency-changes detail
```

max-concurrent-dd

Use this command to limit the number of Database Descriptors (DD) that can be processed concurrently.

This command is useful when a router's performance is affected from simultaneously bringing up several OSPF adjacencies. This command limits the maximum number of DD exchanges that can occur concurrently per OSPF instance, thus allowing for all of the adjacencies to come up.

Use the `no` option with this command to remove the limit.

Command Syntax

```
max-concurrent-dd <1-65535>
no max-concurrent-dd
```

Parameters

<1-65535> Specify the number of DD processes.

Default

By default, max concurrent dd value is 64

Command Mode

Router mode

Applicability

This command was introduced before OcnOS version 1.3.

Examples

The following example set the `max-concurrent-dd` value to 4.

```
#configure terminal
(config)#router ospf 100
(config-router)#max-concurrent-dd 4
```

maximum-area

Use this command to configure the maximum number of OSPF areas.

Use the `no` parameter with this command to disable the limit.

Command Syntax

```
maximum-area <1-4294967294>  
no maximum-area
```

Parameters

<1-4294967294> Specify the maximum number of OSPF areas.

Default

By default, ospf maximum area is 4294967294

Command Mode

Router mode

Applicability

This command was introduced before OcNOS version 1.3.

Examples

```
#configure terminal  
(config)#router ospf 100  
(config-router)#maximum-area 5
```

neighbor

Use this command to configure OSPF routers interconnecting to NBMA (Non-Broadcast Multi-Access) networks. Include one neighbor entry for each known non-broadcast network neighbor. Configure the neighbor address on the primary address of the interface.

Use the `no` parameter with this command to remove a configuration.

Command Syntax

```
neighbor A.B.C.D {cost <1-65535> | priority <0-255>| poll-interval <1-2147483647>}
no neighbor A.B.C.D { cost | priority | poll-interval}
no neighbor A.B.C.D
```

Parameters

A.B.C.D	Interface IP address of the neighbor.
priority	Router priority of the non-broadcast neighbor associated with the specified IP address. This parameter does not apply to point-to-multipoint interfaces.
<0-255>	Router priority value of the non-broadcast neighbor associated with the specified IP address.
poll-interval	Reduced rate at which routers continue to send hello packets when a neighboring router has become inactive.
<1-2147483647>	Dead neighbor polling interval in seconds. Set this value much larger than hello interval.
cost	OSPF cost for point-to-multipoint neighbor.
<1-65535>	Metric.

Default

The default priority is 0 and polling interval is 120 seconds.

Command Mode

Router mode

Applicability

This command was introduced before OcnOS version 1.3.

Examples

This example shows neighbor configured with a priority value and poll interval time.

```
#configure terminal
(config)#router ospf 100
(config-router)#neighbor 1.2.3.4 priority 1 poll-interval 90
```

network

Use this command to enable OSPF routing with a specified area ID (and optionally an instance ID) on interfaces with IP addresses that match the specified network address.

OSPF routing is enabled per IPv4 subnet basis. You define the network address using the prefix length or a subnet mask.

Use the `no` parameter with this command to disable OSPF routing on the interfaces.

Command Syntax

Network address defined using the prefix length:

```
network A.B.C.D/M area (A.B.C.D|<0-4294967295>) (instance-id <0-255>|)
no network A.B.C.D/M area (A.B.C.D|<0-4294967295>) (instance-id)
```

Network address defined using subnet mask:

```
network A.B.C.D A.B.C.D area (A.B.C.D|<0-4294967295>) (instance-id <0-255>|)
no network A.B.C.D A.B.C.D area (A.B.C.D|<0-4294967295>) (instance-id)
```

Parameters

A.B.C.D/M	IPv4 network address with prefix length.
A.B.C.D	IPv4 network address.
A.B.C.D	Subnet mask where the bits on left side are set to 1 to represent the network part and the bits on the right side are set to 0 to represent the host part.
area	OSPF area ID
A.B.C.D	OSPF area ID in IPv4 address format.
<0-4294967295>	OSPF area ID as a decimal value.
instance-id	Instance ID
<0-255>	Instance ID value.

Default

No network area is configured

Command Mode

Router mode

Applicability

This command was introduced before OcnOS version 1.3.

Examples

The following the use of the `network` command with OSPF multiple-instance support disabled.

```
#configure terminal
(config-router)#network 10.0.0.0/8 area 3
(config-router)#network 10.0.0.0/8 area 1.1.1.1
```

The following shows the use of the network command with OSPF multiple-instance support enabled.

```
(config)#router ospf 100  
(config-router)#network 10.0.0.0/8 area 3 instance-id 4
```

ospf abr-type

Use this command to set an OSPF Area Border Router (ABR) type.

Use the `no` parameter with this command to revert the ABR type to the default setting (`cisco`).

Specifying the ABR type allows better functioning in a multi-vendor environment. The ABR types are:

- **Cisco (RFC 3509):** A router is considered an ABR if it has more than one area actively attached and one of them is the backbone area.
- **IBM (RFC 3509):** A router is considered an ABR if it has more than one area actively attached and the backbone area is configured. In this case the configured backbone need not be actively connected.
- **Standard (RFC 2328):** A router is considered an ABR if it has more than one area actively attached to it.

Command Syntax

```
ospf abr-type (cisco|ibm|standard|shortcut|)
no ospf abr-type
```

Parameters

<code>cisco</code>	Specify an alternative ABR using Cisco implementation. This is the default ABR type.
<code>ibm</code>	Specify an alternative ABR using IBM implementation.
<code>standard</code>	Specify a standard ABR.
<code>shortcut</code>	Shortcut ABR.

Default

By default, ABR type is Cisco

Command Mode

Router mode

Applicability

This command was introduced before OcNOS version 1.3.

Examples

```
#configure terminal
(config)#router ospf 100
(config-router)#ospf abr-type ibm
```

ospf area-interface-config-mode

Use this command to attach the interface to the router OSPF area. When this is enabled, any existing configuration of `router ospf` attached to the interface is erased.

Use no form of this command to disable. When this is disabled, any existing configuration of interface attached to the `router ospf` is erased.

Command Syntax

```
ospf area-interface-config-mode
no ospf area-interface-config-mode
```

Parameters

None

Default

None

Command Mode

Configure mode

Applicability

This command was introduced before OcNOS version 4.2.

Examples

```
#configure terminal
(config)#ospf area-interface-config-mode
```

ospf flood-reduction

Use this command to Enable flood reduction on all OSPF interface. When this command is configured, an LSA sent out on the OSPF interface is set with the DNA bit in the LSA age field. If there is no change in LSA, it is not refreshed every refresh interval. LSAs are sent out on the interface only if there is a change in an LSA

Use the `no` option with this command to disable flood reduction on all OSPF interfaces.

Command Syntax

```
ospf flood-reduction
no ospf flood-reduction
```

Parameters

None

Default

By default, flood reduction on all OSPF interfaces is disabled

Command Mode

Router mode

Applicability

This command was introduced before OcNOS version 1.3.

Examples

```
#configure terminal
(config)#router ospf 100
(config-router)#ospf flood-reduction

(config-router)#no ospf flood-reduction
```

ospf point-point rfc-incompatible

Use this command to disable RFC 2328 compatibility on point-to-point interfaces.

By default, in a point-to-point network OSPF packets are transmitted using multicast addresses. By disabling point-to-point RFC 2328 compatibility, packets are transmitted using the unicast address of the neighbor.

Use the `no` parameter with this command to enable RFC 2328 compatibility on point-to-point interfaces.

Command Syntax

```
ospf point-point rfc-incompatible
no ospf point-point rfc-incompatible
```

Parameters

None

Default

By default, RFC 2328 compatibility is enabled (packets transmitted using multicast addresses).

Command Mode

Router mode

Applicability

This command was introduced before OcNOS version 1.3.

Examples

```
#configure terminal
(config)#router ospf 100
(config-router)#ospf point-point rfc-incompatible
```

ospf router-id

Use this command to specify a router ID for the OSPF process.

Configure each router with a unique router ID. In an OSPF router process which has active neighbors, a new router ID is used at the next reload or when you start the OSPF manually.

Use the `no` parameter with this command to force OSPF to use the previous router ID.

Command Syntax

```
ospf router-id A.B.C.D
```

```
router-id A.B.C.D
```

```
no ospf router-id
```

```
no router-id (A.B.C.D|)
```

Parameters

A.B.C.D Specify the router ID in IPv4 address format.

Default

No default value is specified

Command Mode

Router mode

Applicability

This command was introduced before OcnOS version 1.3.

Examples

The following example shows a specified router ID 2.3.4.5.

```
#configure terminal
(config)#router ospf 100
(config-router)#ospf router-id 2.3.4.5
```

overflow database

Use this command to limit the maximum number of LSAs that can be supported by the OSPF instance.

Use the `no` parameter with this command to have an unlimited number of LSAs.

Command Syntax

```
overflow database <0-4294967294> (hard|soft|)
no overflow database
```

Parameters

<0-4294967294>	The maximum number of LSAs
hard	Shutdown occurs if the number of LSAs exceeds the specified value.
soft	Warning message appears if the number of LSAs exceeds the specified value.

Default

No default value is specified. unlimited number of LSAs.

Command Mode

Router mode

Applicability

This command was introduced before OcnOS version 1.3.

Examples

The following example shows setting the database overflow to 5 and shutting down in that event.

```
#configure terminal
(config)#router ospf 100
(config-router)#overflow database 5 hard
```

overflow database external

Use this command to limits the number of AS-external-LSAs a router can receive once it is in the wait state.

Use the `no` parameter with this command to revert to default.

Command Syntax

```
overflow database external <0-2147483647> <0-65535>
no overflow database external
```

Parameters

- <0-2147483647> The maximum number of LSAs. This value should be the same on all routers in the AS.
- <0-65535> The number of seconds the router waits before trying to exit the database overflow state. If this parameter is 0, the router exits the overflow state only after an explicit administrator command.

Default

The default OSPF exit overflow interval is 0 second and number of external LSDB limit is unlimited.

Command Mode

Router mode

Applicability

This command was introduced before OcnOS version 1.3.

Examples

The following example shows setting the maximum number of LSAs to 5 and the time to recover from overflow state to be 3.

```
#configure terminal
(config)#router ospf 100
(config-router)#overflow database external 5 3
```

passive-interface

Use this command to suppress sending Hello packets on all interfaces or on a specified interface.

This command configures OSPF on simplex Ethernet interfaces. Since a simplex interface represents only one network segment between two devices, configure the transmitting interface as a passive interface. This ensures that OSPF does not send hello packets for the transmitting interface. Both the devices can see each other via the hello packet generated for the receiving interface.

Use the `no` form with this command to resume sending `hello` packets on all interfaces, or on a specified interface.

Note: The command `passive-interface` configures all interfaces as passive. If it is re-applied, the other passive configurations will be removed and all interfaces will become passive again.

Command Syntax

```
passive-interface
passive-interface IFNAME ( ( disable | enable) |)
passive-interface IFNAME A.B.C.D (enable|)
no passive-interface
no passive-interface IFNAME
no passive-interface IFNAME A.B.C.D
```

Parameters

<code>enable</code>	Enable passive interface
<code>disable</code>	Disable passive interface
<code>IFNAME</code>	The name of the interface
<code>A.B.C.D</code>	IPv4 address of the interface

Default

The default OSPF exit overflow interval is 0 second and number of external LSDB limit is 100000.

Command Mode

Router mode

Applicability

This command was introduced before OcnOS version 1.3.

Examples

```
(config)#router ospf 100
(config-router)#passive-interface
(config-router)#passive-interface eth0 enable
(config-router)#passive-interface eth1 10.1.2.3 enable
```

redistribute

This command redistributes routes from routing protocols, static routes, and kernel routes into an OSPF routing table.

Use the `no` form of this command to disable redistribution.

Command Syntax

```
redistribute (kernel|connected|static|rip|bgp|isis (WORD|)|ospf (<1-65535>|))
  {metric <0-16777214>|metric-type (1|2)|route-map WORD|tag <0-4294967295>}
no redistribute (kernel|connected|static|rip|bgp|isis (WORD|)|ospf (<1-65535>|))
  metric|metric-type|route-map|tag}
```

Parameters

<code>kernel</code>	Redistribute kernel routes.
<code>connected</code>	Redistribute connected routes.
<code>static</code>	Redistribute static routes.
<code>rip</code>	Redistribute RIP routes.
<code>bgp</code>	Redistribute BGP routes.
<code>isis</code>	Redistribute IS-IS routes.
<code>WORD</code>	IS-IS instance identifier.
<code>ospf</code>	Redistribute OSPF routes.
<1-65535>	OSPF process ID to redistribute a particular OSPF instance into another OSPF instance. If not specified, this command redistributes into the OSPF instance with process ID 0.
<code>metric</code>	External metric.
<0-16777214>	External metric value.
<code>metric-type</code>	External metric-type (see RFC 3101):
1	OSPF External Type 1 metrics.
2	OSPF External Type 2 metrics.
<code>route-map</code>	Route map reference.
<code>WORD</code>	Route map name.
<code>tag</code>	Tag value to use as a “match” value for controlling redistribution via route maps.
<0-4294967295>	Route tag value.

Default

By default, redistribution is disabled.

Command Mode

Router mode

Applicability

This command was introduced before OcnOS version 1.3.

Examples

```
(config)#router ospf 100
(config-router)#redistribute bgp metric 12
```

The following example shows redistributing OSPF instance 2 into OSPF instance 1.

```
(config)#router ospf 1
(config-router)#redistribute ospf 2
```

The following example shows redistributing OSPF instance 2 into OSPF instance 1, with an external metric of 10, metric type 1, a route-map named `rmp1`, and an external route tag of 3.

```
(config)#router ospf 1
(config-router)#redistribute ospf 2 metric 10 metric-type 1 route-map rmp1 tag
3
```

router ospf

Use this command to enter router mode and to configure an OSPF routing process.

Specify the process ID to configure multiple instances of OSPF. When running a single instance of OSPF, you do not need to specify a process ID.

Use the `no` parameter with this command to terminate an OSPF routing process.

Command Syntax

```
router ospf
router ospf <0-65535>

no router ospf
no router ospf <0-65535>
```

Parameters

`<0-65535>` Process ID; should be unique for each routing process.

Default

No routing process defined

Command Mode

Configure mode

Applicability

This command was introduced before OcnOS version 1.3.

Examples

This example shows the use of the `router ospf` command to enter router mode. Note the change in the prompt.

```
#configure terminal
(config)#router ospf 100
(config-router)#
```

show cspf rsvp forwarding-timer

This command displays the information of Graceful Restart capable RSVP client to ISIS or OSPF, CSPF that are currently shutdown.

Command Syntax

```
show cspf rsvp forwarding-timer
```

Parameters

None

Command Mode

Privileged Exec modes

Applicability

This command was introduced before OcNOS version 5.0.

Example

```
#show cspf rsvp forwarding-timer
CSPF Server      Protocol-Name  GR-State      Time Remaining (sec)
Disconnected-time
OSPF             RSVP          ACTIVE        88             2021/
08/18 04:49:23
#
```

show debugging ospf

Use this command to display the set OSPF debugging option.

Command Syntax

```
show debugging ospf
```

Parameters

None

Command Mode

Privileged Exec mode

Applicability

This command was introduced before OcNOS version 1.3.

Example

This is a sample output from the `show debugging ospf` command. Some lines in this output wrap around, they might not wrap around in the actual display.

```
#show debugging ospf
OSPF debugging status:
  OSPF packet Link State Update debugging is on
  OSPF all events debugging is on
```

show ip ospf

Use this command to display general information about all OSPF routing processes.

Command Syntax

```
show ip ospf (<0-65535>|)
```

Parameters

<0-65535> The ID of the router process for which information will be displayed. If this parameter is specified, only the information for the specified routing process is displayed.

Command Mode

Privileged Exec mode

Applicability

This command was introduced before OcnOS version 1.3.

Examples

```
#show ip ospf 1
Routing Process "ospf 1" with ID 4.1.1.1
Process uptime is 1 minute
Process bound to VRF default
Conforms to RFC2328, and RFC1583 Compatibility flag is disabled
Supports only single TOS(TOS0) routes
Supports opaque LSA
Supports Graceful Restart
This router is an ASBR (injecting external routing information)
SPF schedule delay min 0 secs 500 msec
SPF schedule delay max 50 secs 0 msec
Refresh timer 10 secs
Number of incoming current DD exchange neighbors 0/5
Number of outgoing current DD exchange neighbors 0/5
Initial LSA throttle delay 10 secs 0 msec
Minimum hold time for LSA throttle 20 secs 0 msec
Maximum wait time for LSA throttle 45 secs 0 msec
Minimum LSA arrival 1 secs 0 msec
Number of external LSA 5. Checksum 0x010632
Number of opaque AS LSA 0. Checksum 0x000000
Number of non-default external LSA 5
External LSA database is unlimited.
Number of LSA originated 6
Number of LSA received 0
Number of areas attached to this router: 1
  Area 0 (BACKBONE)
    Number of interfaces in this area is 1(1)
    Number of fully adjacent neighbors in this area is 0
    Area has no authentication
    SPF algorithm last executed 00:00:47.558 ago
```

```
SPF algorithm executed 2 times
Number of LSA 1. Checksum 0x0041e0
```

OSPF Routing Process Fields

Table 1-30 explains the routing process fields.

Table 1-30: show ip ospf output details

Field	Description
Routing Process with ID	OSPF process identifier and router identifier.
Process is not up	OSPF process is not running.
Process uptime is	OSPF process running time.
Process bound to VRF	VRF name
Router is in Graceful Restart	When in graceful restart.
Router is in Restart Signaling	When in restart signalling.
Bidirectional Forwarding Detection is configured	When BFD is enabled.
Conforms to RFC2328, and RFC1583 Compatibility flag is enabled	RFC compatibility.
Supports only single TOS (TOS0) routes	OSPF TOS-based routing was never deployed.
Supports opaque LSA	When opaque LSAs are supported.
Do not support Restarting	When restart is not supported.
Supports Graceful Restart	Method of restart in process.
Supports Restart Signaling	Method of restart in signaling process.
Connected to MPLS VPN Super backbone	VRF is enabled and the process is connected to the MPLS VPN backbone.
This router is an ABR, ABR Type is	Type of ABR: Standard (RFC2328) Alternative Cisco (RFC3509) Alternative IBM (RFC3509) Alternative Shortcut
This router is an ASBR (injecting external routing information)	Type of router function in the process.
SPF schedule delay initial	Initial SPF schedule delay.
SPF schedule delay min	Minimum delay between receiving a change to SPF calculation.
SPF schedule delay max	Maximum delay between receiving a change to SPF calculation.
Refresh timer	LSA refresh interval.
Number of incoming current DD exchange neighbors	Incoming neighbor Database Descriptors and maximum concurrent DDs.

Table 1-30: show ip ospf output details (Continued)

Field	Description
Number of outgoing current DD exchange neighbors	Outgoing neighbor Database Descriptors and maximum concurrent DDs.
Initial LSA throttle delay	Initial delay for the generation of LSAs.
Minimum hold time for LSA throttle	Minimum hold time between generation of the same LSA.
Maximum wait time for LSA throttle	Maximum wait time between generation of the same LSA.
Minimum LSA arrival	Minimum time between reception of new LSAs during flooding.
Number of external LSA	Number of AS external LSAs and checksum.
Number of opaque AS LSA	Number of AS opaque LSAs and checksum.
Number of non-default external LSA	For database overflow, number of non-default external LSAs.
External LSA database is unlimited	When the external LSA database is unlimited.
External LSA database limit	Maximum number of LSAs in database.
Exit database overflow state interval is	Exit database overflow state interval.
Exit database overflow state interval is not configured	When the exit database overflow state interval is not set.
OSPF is [not] in database overflow state now	Whether OSPF is in database overflow state now.
Next attempt to exit database overflow state in	How long until OSPF tries to exit the database overflow state.
LSDB database overflow limit	Maximum number of LSAs that can be supported by the OSPF instance.
LSDB exceed overflow limit	Whether OSPF is exceeding the maximum number of LSAs.
Number of LSA originated	LSAs originated by the OSPF instance.
Number of LSA received	LSAs received by the OSPF instance.
Number of areas attached to this router	As stated
Next fields are repeated for each area	As stated
Area	Area identifier.
(BACKBONE)	Area is a backbone.
no-summary	Area is a stub and does no import summaries.
(Inactive)	Area is not active.
Number of interfaces in this area is	Number of interfaces in this area.
Number of fully adjacent neighbors in this area	As stated.
Number of fully adjacent virtual neighbors through this area	As stated.

Table 1-30: show ip ospf output details (Continued)

Field	Description
Area has no authentication	Area does not use authentication.
Area has simple password authentication	Area uses password authentication.
Area has message digest authentication	Area uses MD5 authentication.
SPF algorithm last executed	As stated.
SPF algorithm executed	As stated.
Number of LSA	Number of LSAs in area link-state database and checksum.
End of area field	As stated.
NSSA Translator Role is	candidate: Translate Type-7 LSAs to Type-5 if router is elected. never: Do not translate Type-7 LSAs to Type-5. always: Always translate Type-7 LSAs to Type-5.
NSSA Translator State is	disabled: Router is not a border router. enabled: Router is a border router. elected: Router has been elected to be an NSSA translator.
Stability Interval	If an elected translator determines its services are no longer required, how long it continues to perform its services.
Number of NSSA Translator Events	As stated.
Shortcutting mode	Shortcut ABR that installs inter-area routes through non-backbone areas if non-backbone paths are really better: Default Enabled Disabled
S-bit consensus	Whether other ABR agrees on S-bit: ok no
Dste Status	Whether DSTE is enabled or disabled.

show ip ospf border-routers

Use this command to display the ABRs and ASBRs for OSPF instances.

Command Syntax

```
show ip ospf (<0-65535>|) border-routers
```

Parameters

<0-65535> The ID of the router process for which information will be displayed.

Command Mode

Privileged Exec mode

Applicability

This command was introduced before OcnOS version 1.3.

Example

This is a sample output from the `show ip ospf border-routers` command.

```
#show ip ospf border-routers
OSPF process 1 internal Routing Table
Codes: i - Intra-area route, I - Inter-area route
i 10.15.0.1 [10] via 10.10.0.1, eth0, ASBR, Area 0.0.0.0
i 172.16.10.1 [10] via 10.10.11.50, eth1, ABR, ASBR, Area 0.0.0.0
```

Border Router Fields

[Table 1-31](#) explains the border router fields.

Table 1-31: border router output details

Field	Description
Code	i: Intra-area route I: Inter-area route
Router ID	Router identifier of the destination
Cost	Cost of using this route.
via	Next hop IP address toward the destination.
is directly connected	Destination is directly connected.
Interface	Outgoing interface name.
Type	Router type of the destination: ABR or ASBR.
through Transit Area	Next hop is an area that carries traffic that neither originates nor terminates in the area itself.
Area	Area identifier from which this route was learned.
Transit	Area is a transit area.

show ip ospf database brief

Use this command to display a summary of the OSPF database.

Command Syntax

```
show ip ospf database (self-originate|max-age|adv-router A.B.C.D|)
show ip ospf <0-65535> database(self-originate|max-age|adv-router A.B.C.D|)
```

Parameters

`self-originate` Self-originated link states.
`max-age` LSAs which have reached the maximum age (3600 seconds).
`A.B.C.D` IPv4 address of the advertising router.
`<0-65535>` ID of the router process

Command Mode

Privileged Exec mode

Applicability

This command was introduced before OcNOS version 1.3.

Examples

```
#show ip ospf database
  OSPF Router process 100 with ID (100.100.100.72)
    Router Link States (Area 0.0.0.0)
Link ID      ADV Router    Age   Seq#         CkSum  Link count
10.100.12.57 10.100.12.57  930  0x80000003  0x90de  2
100.100.100.72 100.100.100.72 933  0x80000004  0x7592  2

    Net Link States (Area 0.0.0.0)
Link ID      ADV Router    Age   Seq#         CkSum
10.100.10.72 100.100.100.72 933  0x80000001  0x0bef

    Summary Link States (Area 0.0.0.0)
Link ID      ADV Router    Age   Seq#         CkSum  Route
10.60.0.0   10.100.12.57  928  0x80000001  0x5108  10.60.0.0/24
71.87.120.0 10.100.12.57  928  0x80000001  0xc2c5  71.87.120.0/24
127.0.0.1   10.100.12.57  928  0x80000001  0x23fb  127.0.0.1/32
```

OSPF Database Fields

[Table 1-32](#) explains the fields for each database entry.

Table 1-32: ospf database output details

Field	Description
Link ID	<p>The meaning of this field depends on the type of Link-State Advertisement (LSA).</p> <p>Type 1: Router LSA (depends on the type of network to which the router connects): Point-to-point network: neighbor's router ID. Transit network: IP address of the designated router's interface. Stub network: IP network or subnet address Virtual link: Neighbor's Router ID.</p> <p>Type 2: Network LSA: The IP address of the designated router's interface. Type 3: Summary LSA: The IP address of the network or subnet being advertised.</p>
ADV Router	The ID of the router advertising the LSA.
Age	The age of the LSA.
Seq#	<p>The sequence number of the LSA. This number increments each time a new instance of the LSA originates. This update helps other routers identify the most recent instance of the LSA.</p>
CkSum	The fetch checksum of the complete LSA except the Age field.
Link count	Total number of links.
Route	Summary prefix address.

show ip ospf database detail

Use this command to display details of the OSPF database.

Command Syntax

```
show ip ospf database (asbr-summary|external|network|router|summary|nssa-external|opaque-link|opaque-area|opaque-as) (self-originate|adv-router A.B.C.D|)
show ip ospf <0-65535> database (asbr-summary|external|network|router|summary) (self-originate|adv-router A.B.C.D|)
show ip ospf database (asbr-summary|external|network|router|summary|nssa-external|opaque-link|opaque-area|opaque-as) A.B.C.D (self-originate|adv-router A.B.C.D|)
show ip ospf <0-65535> database (asbr-summary|external|network|router|summary|nssa-external|opaque-link|opaque-area|opaque-as) A.B.C.D (self-originate|adv-router A.B.C.D|)
```

Parameters

<0-65535>	The ID of the router process for which information should be displayed.
asbr-summary	Type 4 ASBR summary LSAs.
external	Type 5 external LSAs.
network	Type 2 network LSAs.
router	Type 1 router LSAs.
summary	Type 3 summary LSAs.
nssa-external	Type 7 NSSA external LSAs.
opaque-link	Type 9 LSAs which are not flooded beyond the local network.
opaque-area	Type 10 LSAs which are not flooded beyond the borders of their area.
opaque-as	Type 11 LSAs which are flooded throughout the AS.
A.B.C.D	Link state ID as an IP address.
self-originate	Display self-originated link states.
adv-router	Advertising router link states.
A.B.C.D	IPv4 address of advertising router.

Command Mode

Privileged Exec mode

Applicability

This command was introduced before OcNOS version 1.3.

Example: external and self-originate Parameters

This is sample output with the `external` and `self-originate` parameters.

```
#show ip ospf database external self-originate
OSPF Router process 100 with ID (10.10.11.50)
```

```

AS External Link States
LS age: 298
Options: 0x2 (*|---|---|E|)
LS Type: AS-external-LSA
Link State ID: 10.10.100.0 (External Network Number)
Advertising Router: 10.10.11.50
LS Seq Number: 80000001
Checksum: 0x7033
Length: 36
Network Mask: /24
Metric Type: 2 (Larger than any link state path)
TOS: 0
Metric: 20
Forward Address: 10.10.11.50
External Route Tag: 0

```

Example: opaque-as and self-originate Parameters

This is sample output with the `opaque-as` and `self-originate` parameters.

```

#show ip ospf database opaque-as self-originate
OSPF Router process 100 with ID (10.10.11.50)
AS-Global Opaque-LSA
LS age: 325
Options: 0x2 (*|---|---|E|)
LS Type: AS-external Opaque-LSA
Link State ID: 11.10.9.23 (AS-external Opaque-Type/ID)
Opaque Type: 11
Opaque ID: 657687
Advertising Router: 10.10.11.50
LS Seq Number: 80000001
Checksum: 0xb018
Length: 25

```

Example: adv-router Parameter

This is a sample output with the `adv-router` parameter.

```

#show ip ospf database nssa-external adv-router 10.10.11.50
OSPF Router process 100 with ID (10.10.11.50)
NSSA-external Link States (Area 0.0.0.0)
NSSA-external Link States (Area 0.0.0.1 [NSSA])
LS age: 78
Options: 0x0 (*|---|---|---|)
LS Type: AS-NSSA-LSA
Link State ID: 0.0.0.0 (External Network Number For NSSA)
Advertising Router: 10.10.11.50
LS Seq Number: 80000001
Checksum: 0xc9b6
Length: 36
Network Mask: /0
Metric Type: 2 (Larger than any link state path)
TOS: 0
Metric: 1
NSSA: Forward Address: 0.0.0.0
OSPF Router process 100 with ID (10.10.11.50)
NSSA-external Link States (Area 0.0.0.0)
NSSA-external Link States (Area 0.0.0.1 [NSSA])

```

```
LS age: 78
Options: 0x0 (*|---|---|---|)
LS Type: AS-NSSA-LSA
Link State ID: 0.0.0.0 (External Network Number For NSSA)
```

Example: router and Link State ID Parameters

This is sample output with the `router` and link state ID parameters.

```
#show ip ospf database router 10.10.11.50
OSPF Router process 100 with ID (10.10.11.50)
Router Link States (Area 0.0.0.0)
LS age: 878
Options: 0x2 (*|---|---|E|)
Flags: 0x3 : ABR ASBR
LS Type: router-LSA
Link State ID: 10.10.11.50
Advertising Router: 10.10.11.50
LS Seq Number: 80000004
Checksum: 0xe39e
Length: 36
Number of Links: 1
Link connected to: Stub Network
(Link ID) Network/subnet number: 10.10.10.0
(Link Data) Network Mask: 255.255.255.0
Number of TOS metrics: 0
TOS 0 Metric: 10
Router Link States (Area 0.0.0.1)
LS age: 877
Options: 0x2 (*|---|---|E|)
Flags: 0x3 : ABR ASBR
LS Type: router-LSA
Link State ID: 10.10.11.50
Advertising Router: 10.10.11.50
LS Seq Number: 80000003
```

Example: adv-router Parameter

This is sample output using the `adv-router` parameter for flood reduction.

```
#show ip ospf database summary adv-router 10.10.11.50

OSPF Router process 100 with ID (10.10.11.50)
Summary Link States (Area 0.0.0.0)
LS age: 1(DoNotAge)
Options: 0x2 (*|---|---|E|)
LS Type: summary-LSA
Link State ID: 10.10.11.0 (summary Network Number)
Advertising Router: 10.10.11.50
LS Seq Number: 80000001
Checksum: 0x36ac
Length: 28
Network Mask: /24
TOS: 0 Metric: 10
Summary Link States (Area 0.0.0.1)
LS age: 989
Options: 0x2 (*|---|---|E|)
LS Type: summary-LSA
Link State ID: 10.10.11.0 (summary Network Number)
```

```

Advertising Router: 10.10.11.50
LS Seq Number: 80000001
Checksum: 0x36ac
Length: 28
Network Mask: /24
TOS: 0 Metric: 10

#show ip ospf database external self-originate

OSPF Router process 100 with ID (10.10.11.50)

AS External Link States
LS age: 298
Options: 0x2 (*|-|-|-|-|E|-)
LS Type: AS-external-LSA
Link State ID: 10.10.100.0 (External Network Number)
Advertising Router: 10.10.11.50
LS Seq Number: 80000001
Checksum: 0x7033
Length: 36
Network Mask: /24
Metric Type: 2 (Larger than any link state path)
TOS: 0
Metric: 20
Forward Address: 10.10.11.50
External Route Tag: 0

```

Database Detail Header Fields

[Table 1-33](#) explains the fields for each database entry.

Table 1-33: ospf database detail header fields

Field	Description
LS age	Age of the LSA in seconds. "Do Not Age" is displayed if the DNA bit is set.
Options	LSA options as explained in Table 1-34 .
Flags	ABR: Area border router ASBR: AS boundary router VL-endpoint: Endpoint of an active virtual link that is using the described area as a transit area Shortcut: shortcut ABR NSSA-Translator: NSSA border router with NSSA Translate or State enabled
LS Type	Type of LSA: Router-LSA Network-LSA Summary-LSA ASBR-summary-LSA AS-external-LSA AS-NSSA-LSA Link-Local Opaque-LSA Area-Local Opaque-LSA AS-external Opaque-LSA

Table 1-33: ospf database detail header fields

Field	Description
Link State ID	Identifier of the router described by the LSA.
Opaque Type	Opaque type used to identify the application type of the LSA: 9: link-local scope 10: area-local scope 11: LSA flooded throughout the AS
Opaque ID	Identifier used to differentiate LSAs of the same type.
Advertising Router	Identifier of the router that originated the LSA.
LS Seq Number	Sequence number of the LSA. This number increments each time a new instance of the LSA originates. This update helps other routers identify the most recent instance of the LSA.
Checksum	Checksum of the entire LSA, except the LS age field.
Length	Length of the LSA
I LSA	Indication LSA: ASBR set the infinity metric to tell all routers in the backbone not to originate DNA LSAs.

OSPF LSA Option Bits

Table 1-34 explains the fields for each database entry.

Table 1-34: ospf LSA option bits output details

Bit	Description
DN	Used in MPLS-based L3 VPNs. When a route learned from a customer network via OSPF is advertised across a BGP/ MPLS VPN using Multiprotocol BGP and advertised back to a customer network via OSPF, a loop can happen where the OSPF route is redistributed back to the VPN service provider network via BGP. The DN-bit prevents this type of routing loop. When an OSPF router receives a Type 3, 5, or 7 LSA with the DN-bit set, it does not use that LSA for OSPF route calculations.
O	Originating router supports Type 9, 10, and 11 Opaque LSAs.
DC	Originating router supports OSPF over Demand Circuits.
L	Whether the OSPF packet contains a Link-Local Signaling (LLS) data block. This bit is set only in Hello and database description packets.
N/P	The N-bit is used only in Hello packets when the originating router supports Type-7 NSSA-External-LSAs. Neighboring routers with mismatched N-bit will not form a neighbor relationship. This restriction ensures that all OSPF routers within an area support NSSA capabilities. When the N-bit is set, the E-bit must be 0. The P-bit is used only in Type-7 NSSA-External-LSA headers. Due to this reason, the N- and P-bits share the same position in the options field. The P (Propagate) bit is set to inform an NSSA ABR to translate Type-7 LSAs into Type-5 LSAs.
MC	Originating router supports multicast extensions to OSPF (MOSPF)

Table 1-34: ospf LSA option bits output details (Continued)

Bit	Description
E	Originating router accepts AS External LSAs. The bit is set in all AS External LSAs and in all LSAs originated in the backbone and non-stub areas; and is be set to 0 in all Hellos and LSAs originated within a stub area. Additionally, this bit is used in Hello packets to indicate the capability of a router interface to send and receive Type-5 AS-External-LSAs. Neighboring routers with mismatched E-bit do not form a neighbor relationship. This restriction ensures that all OSPF routers within an area support the stub capabilities.
T	Originating router supports Multitopology OSPF (MT-OSPF.) Older OSPF specifications used this bit when the originating router support TOS-based routing. However, OSPF TOS-based routing was never deployed; therefore the T-bit was never used.

Type 1 Router LSAs (“router” Parameter)

Table 1-35 explains the fields for each database entry.

Table 1-35: router LSAs

Field	Description
Number of Links	Number of router links the LSA describes.
Link connected to	Description of the router link: another Router (point-to-point) a Transit Network Stub Network a Virtual Link
(Link ID)	Identifier of the router to which the link connects: Neighboring Router ID Designated Router address Network/subnet number Neighboring Router ID
(Link Data)	Extra information: Router Interface address Network Mask
Number of TOS metrics	Number of TOS (Type of Service) metrics for this link, not including the metric for TOS 0.
TOS 0 Metric	Cost of using this router link for TOS 0.

Type 2 Net Link States (“network” Parameter)

Table 1-36 explains the fields for each database entry.

Table 1-36: net LSAs

Field	Description
Network Mask	IP address mask for the network.
Attached Router	Identifiers of each router attached to the network.

Type 3 Summary LSAs (“summary” Parameter) and Type 4 ASBR Summary LSAs (“asbr-summary” Parameter)

[Table 1-37](#) explains the fields for each database entry.

Table 1-37: summary and ASBR summary link states

Field	Description
Network Mask	For Type 3 LSAs, the destination network's IP address mask. Not meaningful for Type 4 link state advertisements.
TOS: 0 Metric	Cost of using this router link for TOS 0.

Type 5 AS External LSAs (“external” Parameter)

[Table 1-38](#) explains the fields for each database entry.

Table 1-38: external LSAs

Field	Description
Network Mask	IP address mask for the advertised destination
Metric Type	1: Type 1 external metric that is comparable directly (without translation) to the link state metric 2: Type 2 external metric that is considered larger than any link state path
TOS	Always zero.
Metric	The cost of this route.
Forward Address	Data traffic for the advertised destination is forwarded to this address.
External Route Tag	Custom field attached to each external route whose use is defined by the application.

Type 7 NSSA External Link States (“nssa-external” Parameter)

[Table 1-39](#) explains the fields for each database entry.

Table 1-39: NSSA external LSAs

Field	Description
Network Mask	IP address mask for the advertised destination
Metric Type	1: Type 1 external metric that is comparable directly (without translation) to the link state metric 2: Type 2 external metric that is considered larger than any link state path
Metric	The cost of this route.
NSSA: Forward Address	Data traffic for the advertised destination is forwarded to this address.
External Route Tag	Custom field attached to each external route whose use is defined by the application.

show ip ospf igp-shortcut-lsp

Use this command to show the IGP shortcut LSP used by OSPF.

Command Syntax

```
show ip ospf igp-shortcut-lsp
```

Parameters

None

Command Mode

Exec mode

Applicability

This command was introduced before OcNOS version 1.3.

Example

```
#show ip ospf igp-shortcut-lsp
Tunnel-endpoint   Tunnel-id   Tunnel-metric
8.8.8.8           101        2           active
```

[Table 1-40](#) explains the fields in the output.

Table 1-40: show ip ospf igp-shortcut-lsp output details

Field	Description
Tunnel-endpoint	Tunnel endpoint address of ospf.
Tunnel-id	Tunnel address (destination port) for the session.
Tunnel-metric	Number of tunnel-metric.
active/inactive	Whether the tunnel is active or inactive.

show ip ospf igp-shortcut-route

Use this command to show the IGP shortcut route calculated by OSPF.

Command Syntax

```
show ip ospf (<0-65535>|) igp-shortcut-route
```

Parameters

<0-65535> ID of the router process.

Command Mode

Exec mode

Applicability

This command was introduced before OcnOS version 1.3.

Example

```
#show ip ospf igp-shortcut-route
OSPF process 0:
8.8.8.8/32 [2] tunnel-id: 101, 8.8.8.8
15.15.15.15/32 [0] tunnel-id: 101, 8.8.8.8
20.20.15.0/24 [0] tunnel-id: 101, 8.8.8.8
```

[Table 1-41](#) explains the fields in the output.

Table 1-41: show ip igp-shortcut-route output details

Field	Description
OSPF process	OSPF process identifier.
Destination	IP address of the destination port.
Metric	Number of tunnel metric.
Tunnel-ID	Tunnel address (destination port) for the session.
Tunnel-End-Point	Tunnel endpoint address of ospf.

show ip ospf interface

Use this command to display interface information for OSPF.

Command Syntax

```
show ip ospf interface IFNAME brief
show ip ospf interface brie
```

Parameters

IFNAME	Interface name.
brief	Brief summary of interface

Command Mode

Privileged Exec mode and Exec mode

Applicability

This command was introduced before OcnOS version 1.3.

Example

```
#show ip ospf interface
eth1 is up, line protocol is up
Internet Address 10.100.10.72/24, Area 0.0.0.0, MTU 1500
  Router ID 100.100.100.72, Network Type BROADCAST, Cost: 10, TE Metric 0
  Transmit Delay is 1 sec, State DR, Priority 1
  LDP-OSPF Sync configured
  Holddown timer : 50 seconds, Remaining time = 30seconds
  Designated Router (ID) 100.100.100.72, Interface Address 10.100.10.72
  Backup Designated Router (ID) 10.100.12.57, Interface Address 10.100.10.105
  Timer intervals configured, Hello 10, Dead 40, Wait 40, Retransmit 5
    Hello due in 00:00:05
  Neighbor Count is 1, Adjacent neighbor count is 1
  Crypt Sequence Number is 0
  Hello received 19 sent 106, DD received 4 sent 3
  LS-Req received 1 sent 1, LS-Upd received 3 sent 3
  LS-Ack received 2 sent 3, Discarded 0
```

OSPF Interface Fields

[Table 1-42](#) explains the fields for each interface entry.

Table 1-42: OSPF interface output details

Field	Description
Internet address	IP address and subnet mask of the interface.
Area	OSPF area to which the interface belongs.
MTU	Maximum Transmission Unit (MTU) of the interface.

Table 1-42: OSPF interface output details

Field	Description
Transmit Delay	Transmit delay of the interface.
Priority	OSPF priority of the interface used for election of Designated Router (DR) and Backup Designated Router (BDR).
Hello	OSPF hello-interval.
Dead	OSPF dead-interval.
Wait	Hello wait-interval.
Retransmit	The period, in seconds, for which the router waits between retransmissions of OSPF packets that have not been acknowledged.
Hello due in	Time period for which router expects to receive hello packet.
Neighbor Count	OSPF neighbor count.
Adjacent neighbor	OSPF adjacent neighbor count.
Crypt Sequence Number	Used for authentication.
Hello received	Number of Hello packets and DD packets sent and received.
LS-Req	Number of LSA requests and LSA updates sent and received.
LS-Ack	Number of LSA acknowledgments sent and received number of LSA acknowledgment discards.

Example: DoNotAge

The following is sample output of this command when DoNotAge is enabled:

```
#show ip ospf interface eth1
eth1 is up, line protocol is up
 Internet Address 1.1.1.1/24, Area 0.0.0.0, MTU 1500
 Process ID 0, Router ID 33.33.33.33, Network Type BROADCAST, Cost: 10
 Transmit Delay is 1 sec, State Waiting, Priority 1, TE Metric 0
 No designated router on this network
 No backup designated router on this network
 Timer intervals configured, Hello 10, Dead 40, Wait 40, Retransmit 5
 Hello due in 00:00:02
 Neighbor Count is 0, Adjacent neighbor count is 0
 Crypt Sequence Number is 1106347721
 Hello received 0 sent 1, DD received 0 sent 0
 LS-Req received 0 sent 0, LS-Upd received 0 sent 0
 LS-Ack received 0 sent 0, Discarded 0
 Reduce LSA flooding
```

Example: Hello Suppression

The following is sample output of this command when Hello-Suppression is enabled:

```
#sh ip os interface
```

```

p7p1 is up, line protocol is up
  Internet Address 14.1.1.2/24, Area 0.0.0.0, MTU 1500
  Process ID 1, VRF (default), Router ID 2.2.2.2, Network Type POINTOMULTIPOINT, Cost:
1
  Reduce LSA flooding.
  Transmit Delay is 1 sec, State Point-To-Point, TE Metric 1
  Timer intervals configured, Hello 30, Dead 120, Wait 120, Retransmit 5
    Hello due in 00:00:03
  Neighbor Count is 1, Adjacent neighbor count is 1
  Suppress hello for 1 neighbor(s)
  Hello received 5 sent 8, DD received 8 sent 6
  LS-Req received 2 sent 2, LS-Upd received 8 sent 9
  LS-Ack received 6 sent 6, Discarded 0
  No authentication

```

```
#show ip ospf interface brief
```

```

Interface  PID  Area          Intf ID  Cost  State          Neighbors  Status
lo         1   0.0.0.0      1        1    Loopback      0          Up
Interface  PID  Area          Intf ID  Cost  State          Neighbors  Status
xe1        1   0.0.0.0      4        10   DR            1          Up
Interface  PID  Area          Intf ID  Cost  State          Neighbors  Status
xe2        1   0.0.0.0     14        15   DR            1          Up
Interface  PID  Area          Intf ID  Cost  State          Neighbors  Status
xe3        1   0.0.0.0     15        20   DR            1          Up

```

[Table 1-43](#) explain the fields in the command output.

Table 1-43: show ip ospf interface brief output details

Field	Description
Interface	Interface name, also specifies interface type (eth0, lo, xe1/1, and xe1/2).
PID	OSPF process Identifier.
Area	OSPF Area ID in IPv4.v6 address format.
Interface ID	Interface is connected and passing traffic.
Cost	Indicates the IP OSPF cost value
State	Shows the OSPF Interface's state (DR or BDR or loopback).
Neighbors	OSPF router identifier of the neighbor.
Status	Indicate the status of the OSPF router.

show ip ospf multi-area-adjacencies

Use this command to display multi-area adjacency information for OSPF.

Command Syntax

```
show ip ospf (<0-65535>|) multi-area-adjacencies
```

Parameters

<0-65535> The ID of the router process for which information should be displayed.

Command Mode

Privileged Exec mode and Exec mode

Applicability

This command was introduced before OcNOS version 1.3.

Example

The following is a sample output of this command:

```
#show ip ospf 1 multi-area-adjacencies

Multi-area-adjacency on interface eth1 to neighbor 20.20.20.10
Internet Address 20.20.20.11/24, Area 0.0.0.1, MTU 1500
Process ID 1, Router ID 10.10.10.10, Network Type POINTOPOINT, Cost: 10
Transmit Delay is 1 sec, State Point-To-Point
Timer intervals configured, Hello 10, Dead 40, Wait 40, Retransmit 5
Hello due in 00:00:02
Neighbor Count is 0, Adjacent neighbor count is 0
Crypt Sequence Number is 1229928206
Hello received 0 sent 513, DD received 0 sent 0
LS-Req received 0 sent 0, LS-Upd received 0 sent 0
LS-Ack received 0 sent 0, Discarded 0
```

[Table 1-44](#) explains the fields for each adjacency entry.

Table 1-44: show ip ospf multi-area-adjacencies output details

Field	Description
Multi-area-adjacency	Specifies the interface name and the router ID to which it is connected.
Internet Address	As Stated
Area	As Stated
MTU	Maximum Transmission Unit in bytes.
Process ID	The Process Identifier.
Router ID	As Stated
Network Type	In multi-area adjacencies, this is a point-to-point network with the neighbor.

Table 1-44: show ip ospf multi-area-adjacencies output details (Continued)

Field	Description
Cost	A reference bandwidth of 100 Mbps for cost calculation. The formula to calculate the cost is reference bandwidth divided by interface bandwidth.
Transmit Delay	As stated
State	As stated
Timer intervals configured	Hello timer = 10, Dead timer = 40, Wait timer = 40, Retransmit timer = 5
Hello due in	Countdown timer for a Hello message from the neighbor.
Neighbor Count	The number of neighbor.
Adjacent neighbor count	The number of neighbors participating in adjacencies.
Crypt Sequence Number	The 32-bit cryptographic sequence number appended on each OSPF protocol packet.
Hello received, sent	Hello packets sent and received.
DD received, sent	Database Description packets sent and received.
LS-Req received, sent	Link State Request packets sent and received.
LS-Upd received, sent	Link State Update packets sent and received.
LS-Ack received, sent, discarded	Link State Acknowledgement packets sent, received, or discarded.

show ip ospf neighbor

Use this command to display information about OSPF neighbors.

Command Syntax

```
show ip ospf (<0-65535>|) neighbor
show ip ospf (<0-65535>|) neighbor all
show ip ospf (<0-65535>|) neighbor interface A.B.C.D
show ip ospf (<0-65535>|) neighbor A.B.C.D
show ip ospf (<0-65535>|) neighbor A.B.C.D detail
show ip ospf (<0-65535>|) neighbor detail
show ip ospf (<0-65535>|) neighbor detail all
```

Parameters

<0-65535>	The ID of the router process
all	Include downstatus neighbor
A.B.C.D	IPv4 address
detail	Details of neighbors

Command Mode

Privileged Exec mode and Exec mode

Applicability

This command was introduced before OcNOS version 1.3.

Example

```
#show ip ospf neighbor
```

Total number of full neighbors: 3

OSPF process 1 VRF(default):

Neighbor ID	Pri	State	Dead Time	Address	Interface	Instance ID
1.1.1.1	1	Full/ -	inactive	14.1.1.1	p7p1	0
3.3.3.3	1	Full/ -	00:01:41	15.1.1.2	p8p1	0
3.3.3.3	1	Full/ -	inactive	15.1.1.2	VLINK0	

OSPF Neighbor Fields

[Table 1-45](#) explains the fields for each neighbor entry.

Table 1-45: OSPF neighbor output details

Field	Description
OSPF process	OSPF process identifier.
Neighbor ID	OSPF router identifier of the neighbor.

Table 1-45: OSPF neighbor output details

Field	Description
Pri	OSPF priority of the neighbor.
State	<p>State of the OSPF neighbor:</p> <p>DependUpon: dummy state</p> <p>Down: no OSPF neighbors detected at this instant</p> <p>Attempt: in an NBMA environment, the router sends unicast hello packets every poll interval to the neighbor, from which hellos have not been received within the dead interval</p> <p>Init: hello packet received, but the receiving router's ID was not included in the hello packet</p> <p>2-Way: bi-directional communication established between two routers</p> <p>ExStart: master and slave roles determined</p> <p>Exchange: database description packets (DBD) sent</p> <p>Loading: exchange of LSRs (link state request) and LSUs (link state update) packets</p> <p>Full: routers fully adjacent with each other.</p>
Dead Time	If a new Hello is not received within this duration, the neighbor is declared dead.
Address	IP address of neighbor's interface attached to the network.
Interface	The interface attached to the network on which the neighbor is located.
Instance ID	Instance identifier for the session.

Example: Detail Parameter

This is sample output from the command when the `detail` parameter is specified:

```
#show ip ospf neighbor detail
Neighbor 10.10.10.50, interface address 10.10.10.50
In the area 0.0.0.0 via interface eth0
Neighbor priority is 1, State is Full, 5 state changes
DR is 10.10.10.50, BDR is 10.10.10.10
Options is 0x42 (*|O|_|-|_|-|E|-)
Dead timer due in 00:00:38
Neighbor is up for 00:53:07
Database Summary List 0
Link State Request List 0
Link State Retransmission List 0
Crypt Sequence Number is 0
Thread Inactivity Timer on
Thread Database Description Retransmission off
```

OSPF Neighbor Detail Fields

[Table 1-46](#) explains the fields for each neighbor detail entry.

Table 1-46: OSPF neighbor output detail

Field	Description
Neighbor	OSPF router identifier of the neighbor.
interface address	IP address of the neighbor interface.
In the area	Area and interface through which the OSPF neighbor is known.
Neighbor priority	OSPF priority of the neighbor.
State	OSPF state as explained in Table 1-45 .
state changes	Number of state changes since the neighbor was created.
Hello is suppressed	Hello suppression is enabled.
Poll interval	Poll timer value.
DR is	Router ID of the designated router for the interface.
BDR is	Router ID of the backup designated router for the interface.
Options	LSA options as explained in Table 1-34 .
LLS Options	LSDB Resynchronization (LR) Restart Signal (RS-bit) Whether link-local signalling (LLS) and out-of-band (OOB) link-state database resynchronization are performed for nonstop forwarding (NSF).
OOB-Resync in progress (receiver)/last OOB-Resync	Last successful OOB resynchronization with the NSF-capable neighbor. The router waits before taking a neighbor adjacency down if the OOB resynchronization has not taken place since the time a restart signal (Hello packet with RS-bit set) was received from the neighbor.
Dead timer due in	Expected time before declaring the neighbor dead.
Poll due in	Poll timer thread.
Neighbor is up for	Time since the neighbor went into the two-way state.
Database Summary List	Number of LSAs in the neighbor's database.
Link State Request List	Number of LSAs that need to be received from this neighbor to synchronize the neighbors' topological databases.
Link State Retransmission List	Number of advertisements flooded out an adjacency. To ensure flooding is reliable, advertisements are retransmitted until they are acknowledged.
Crypt Sequence Number is	MD5 cryptographic sequence number.
Thread Inactivity Timer	Off if hello suppression is enabled, on otherwise.
Thread Database Description Retransmission	Off if hello suppression is enabled, on otherwise.
Thread Link State Request Retransmission	Off if hello suppression is enabled, on otherwise.

Table 1-46: OSPF neighbor output detail (Continued)

Field	Description
Thread Link State Update Retransmission	Off if hello suppression is enabled, on otherwise.
Thread Poll Timer	Whether the poll timer thread is on.
Bidirectional Forwarding Detection is enabled	Status of BFD, enabled or disabled.

Example: Hello-Suppression Option

This is sample output from the command when the `detail` parameter is specified and Hello-Suppression is enabled:

```
#sh ip os neighbor detail
Neighbor 1.1.1.1, interface address 14.1.1.1
  In the area 0.0.0.0 via interface p7p1
  Neighbor priority is 1, State is Full, 5 state changes
  Hello is suppressed
  DR is 0.0.0.0, BDR is 0.0.0.0
  Options is 0x62 (-|O|DC|-|-|-|E|-)
  Dead timer due in inactive
  Neighbor is up for 00:05:03
  Database Summary List 0
  Link State Request List 0
  Link State Retransmission List 0
  Crypt Sequence Number is 0
  Thread Inactivity Timer off
  Thread Database Description Retransmission off
  Thread Link State Request Retransmission off
  Thread Link State Update Retransmission off
```

show ip ospf route

Use this command to display the OSPF routing table.

Command Syntax

```
show ip ospf (<0-65535>|) route ( A.B.C.D |A.B.C.D/M |summary |)  
show ip ospf (<0-65535>|) route ( A.B.C.D |A.B.C.D/M |summary | fast-reroute |)
```

Parameters

<0-65535>	Router process identifier.
A.B.C.D	Single route.
A.B.C.D/M	Single exact match route.
summary	Route counts.
fast-reroute	Fast-reroute routes.

Command Mode

Privileged Exec mode

Applicability

This command was introduced before OcNOS version 1.3.

Example

```
#show ip ospf route  
OSPF process 10:  
Codes: C - connected, D - Discard, O - OSPF, IA - OSPF inter area  
N1 - OSPF NSSA external type 1, N2 - OSPF NSSA external type 2  
E1 - OSPF external type 1, E2 - OSPF external type 2  
C 50.0.0.0/24 [10] is directly connected, eth1, Area 0.0.0.10  
C 60.0.0.0/24 [10] is directly connected, eth3, Area 0.0.0.10  
OSPF process 15:  
Codes: C - connected, D - Discard, O - OSPF, IA - OSPF inter area  
N1 - OSPF NSSA external type 1, N2 - OSPF NSSA external type 2  
E1 - OSPF external type 1, E2 - OSPF external type 2  
C 80.0.0.0/24 [1] is directly connected, eth4, Area 0.0.0.15
```

Header

Each entry in this table has a code preceding it indicating the source of the routing entry.

[Table 1-47](#) explains the fields of route codes.

Table 1-47: route codes

Code	Meaning	Description
C	connected	Routes directly connected to the local device that were not distributed via IGP. The device inherently knows of these networks, so there is no need to learn about these from another device. Connected routes are preferred over routes for the same network learned from routing protocols.
O	OSPF	Modifiers: IA - OSPF inter area N1 - OSPF NSSA external type 1 N2 - OSPF NSSA external type 2 E1 - OSPF external type 1 E2 - OSPF external type 2
D	discard	An ABR or ASBR performing summarization installs a discard route in its routing table for the summarized network range to prevent routing loops where portions of the summarized network range do not have a more specific route in the RIB. External and internal discard route entries are installed by default. During route summarization, routing loops can happen if data sent to a nonexisting network appears to be a part of the summary, and the router doing the summarization has a less specific route that points back to the sending router for the network.

Route Entry Fields

[Table 1-48](#) shows the route entry fields.

Table 1-48: route entry output details

Field	Description
Codes	As explained in Table 1-47 .
IP address	IP address of the remote network.
Metric	For OSPF the metric is cost, which indicates the best quality path to use to forward packets.
Next hop router IP address	This route is available through the next hop router located at this IP address. This identifies exactly where packets go when they match this route.
Outgoing interface name	Interface used to get to the next-hop address for this route.
Area	OSPF area identifier

Example: Process Identifier

The following is a sample output with the process identifier parameter.

```
#show ip ospf 10 route
OSPF process 10:
Codes: C - connected, D - Discard, O - OSPF, IA - OSPF inter area
N1 - OSPF NSSA external type 1, N2 - OSPF NSSA external type 2
E1 - OSPF external type 1, E2 - OSPF external type 2
C 50.0.0.0/24 [10] is directly connected, eth1, Area 0.0.0.10
C 60.0.0.0/24 [10] is directly connected, eth3, Area 0.0.0.10
```

show ip ospf sham-links

Use this command to display sham link information.

Command Syntax

```
show ip ospf (<0-65535>|) sham-links (brief|)
```

Parameters

<0-65535>	The ID of the router process for which information will be displayed.
brief	Display summary of OSPF sham-links.

Command Mode

Privileged Exec mode and Exec mode

Applicability

This command was introduced before OcnOS version 5.0.

Examples

The following is the display of the sham link information for two routers, one with the sham link up and one with sham link down.

```
#show ip ospf sham-links
Sham Link SLINK0 to destination 2.2.2.2 is down
  area 0.0.0.1 source 1.1.1.1
  Transmit Delay is 1 sec, State Down,
  Timer intervals , Hello 10, Dead 40, Wait 40, Retransmit 5
  Hello due in inactive
  No authentication
  Adjacency state Down
#
#show ip ospf sham-links brief

OSPF Process ID 1 VRF vrf1
Total number of slinks: 1
Shamlink Name      DestinationID  SourceID  Area    Status
SLINK0             2.2.2.2      1.1.1.1  0.0.0.1  down

OSPF Process ID 100 VRF default
Total number of slinks: 0
Shamlink Name      DestinationID  SourceID  Area    Status
#

#show ip ospf sham-links
Sham Link SLINK0 to destination 44.44.44.44 is up
  area 0.0.0.2 source 33.33.33.33
  Transmit Delay is 1 sec, State Point-To-Point,
  Timer intervals , Hello 10, Dead 40, Wait 40, Retransmit 5
```



```

Hello due in 00:00:05
No authentication
Adjacency state Full
#
#show ip ospf sham-links brief

OSPF Process ID 1 VRF vrf1
Total number of slinks: 1
Shamlink Name      DestinationID  SourceID  Area      Status
SLINK0             44.44.44.44          33.33.33.33 0.0.0.2  up

OSPF Process ID 100 VRF default
Total number of slinks: 0
Shamlink Name      DestinationID  SourceID  Area      Status
#

```

Table 1-49: show ip ospf sham-links output details

Field	Description
sham Link	Sham link name, the Destination to which it is connected, and the state of the link.
Area	The area the sham link is connected to
Source	Source address of the sham link
Transmit Delay	The delay, in seconds, between link-state transmits. This value must be the same for all nodes on the network. The range is 0 to 65535. The default is 1. The state is point-to-point.
Timer intervals	The Default values in seconds of the following timers: Hello, Dead, Wait, Retransmit.
Hello due in	A countdown timer that indicates when the next Hello packet should arrive.
Adjacency State	Whether the adjacency state is either up or down.

show ip ospf valid

Use this command to display information about opaque LSAs.

Command Syntax

```
show ip ospf (<0-65535>|) opaque-link valid
```

Parameters

<0-65535>	The ID of the router process for which information will be displayed.
opaque-link	Displays information about the opaque link-local LSAs.

Command Mode

Privileged Exec mode

Applicability

This command was introduced before OcNOS version 1.3.

Examples

```
#show ip ospf 1 opaque-link valid
```

show ip ospf virtual-links

Use this command to display virtual link information.

Command Syntax

```
show ip ospf (<0-65535>|) virtual-links (brief|)
```

Parameters

<0-65535>	The ID of the router process for which information will be displayed.
brief	Display summary of OSPF virtual-links.

Command Mode

Privileged Exec mode and Exec mode

Applicability

This command was introduced before OcNOS version 1.3.

Examples

The following is the display of the virtual link information for two routers, one with the virtual link up and one with virtual link down.

```
ospfd#show ip ospf virtual-links
Virtual Link VLINK0 to router 10.10.0.9 is up
Transit area 0.0.0.1 via interface eth0
Transmit Delay is 1 sec, State Point-To-Point,
Timer intervals configured, Hello 10, Dead 40, Wait 40, Retransmit 5
Hello due in 00:00:02
Adjacency state Full
Virtual Link VLINK1 to router 10.10.0.123 is down
Transit area 0.0.0.1 via interface *
Transmit Delay is 1 sec, State Down,
Timer intervals configured, Hello 10, Dead 40, Wait 40, Retransmit 5
Hello due in inactive
Adjacency state Down
```

The following is the display of the virtual link information for two routers, one with the virtual link up and one with virtual link down when flood reduction is enabled

```
ospfd#show ip ospf virtual-links
Virtual Link VLINK0 to router 10.10.0.9 is up
Transit area 0.0.0.1 via interface eth0
Transmit Delay is 1 sec, State Point-To-Point,
Timer intervals configured, Hello 10, Dead 40, Wait 40, Retransmit 5
Hello due in 00:00:02
Adjacency state Full
Virtual Link VLINK1 to router 10.10.0.123 is down
Transit area 0.0.0.1 via interface *
Transmit Delay is 1 sec, State Down,
Timer intervals configured, Hello 10, Dead 40, Wait 40, Retransmit 5
Hello due in inactive
Adjacency state Down
```

```
DoNotAge LSA Allowed
```

If Hello-Suppression is enabled

```
M1#sh ip ospf virtual-links
Virtual Link VLINK0 to router 3.3.3.3 is up
  Transit area 0.0.0.1 via interface p8p1
  Hello suppression enabled
  DoNotAge LSA allowed
  Local address 15.1.1.1/32
  Remote address 15.1.1.2/32
  Transmit Delay is 1 sec, State Point-To-Point,
  Timer intervals configured, Hello 10, Dead 40, Wait 40, Retransmit 5
  Hello due in inactive
  No authentication
  Adjacency state Full
M1#
```

Table 1-50 explains the fields for each virtual-links entry.

Table 1-50: show ip ospf virtual-links output details

Field	Description
Virtual Link	Virtual link name, the router ID to which it is connected, and the state of the link.
Transit area	Transit area ID, the interface it uses, and its instance ID – an Instance ID should default to 0. It is only necessary to assign a value other than 0 on those links that will contain multiple separate communities of OSPF routers.
Local address	The local IP address and subnet mask.
Remote address	The remote IP address and subnet mask.
Transmit Delay	The delay, in seconds, between link-state transmits. This value must be the same for all nodes on the network. The range is 0 to 65535. The default is 1. The state is point-to-point.
Timer intervals configured	The configured values in seconds of the following timers: Hello, Dead, Wait, Retransmit.
Hello due in	A countdown timer that indicates when the next Hello packet should arrive.
Adjacency State	Whether the adjacency state is either up or down.

show ip protocols

Use this command to display OSPF process parameters and statistics.

Command Syntax

```
show ip protocols
show ip protocols ospf
```

Parameters

None

Command Mode

Privileged Exec mode

Applicability

This command was introduced before OcNOS version 1.3.

Examples

This is an example of the output from the `show ip protocols` command:

```
#show ip protocols
Routing Protocol is "ospf 200"
  Invalid after 0 seconds, hold down 0, flushed after 0
  Outgoing update filter list for all interfaces is
  Redistributed kernel filtered by filter1
  Incoming update filter list for all interfaces is
  Redistributing: kernel
  Routing for Networks:
  192.30.30.0/24
  192.40.40.0/24
  Routing Information Sources:
  GatewayDistanceLast Update
  Distance: (default is 110)
  AddressMaskDistance List
```

[Table 1-51](#) explains the fields for each ip protocol entry.

Table 1-51: show ip protocols output details

Field	Description
Routing Protocol is "ospf 200"	Specifies the routing protocol used.
Invalid after 0 seconds	Specifies the value of the invalid parameter.
Hold down 0	Specifies the current value of the hold-down parameter.
Flushed after 0	Specifies the time in seconds after which the individual routing information will be thrown (flushed) out.
Outgoing update	Specifies whether the outgoing filtering list has been set.

Table 1-51: show ip protocols output details

Field	Description
Incoming update	Specifies whether the incoming filtering list has been set.
Redistributing	Lists the protocol that is being redistributed.
Routing for Networks	Specifies the networks for which the routing process is currently injecting routes.
Routing Information Sources	Lists all the routing sources the IP Infusion software is using to build its routing table.

show ip route fast-reroute

Use this command to display routes with alternate next hops.

Command Syntax

```
show ip route fast-reroute
```

Parameters

None

Command Mode

Privileged Exec mode

Applicability

This command was introduced before OcNOS version 1.3.

Examples

```
#show ip route fast-reroute
```

shutdown

Use the this command to temporarily shut down a protocol in the least disruptive manner and to notify its neighbors that it is going away.

Use the no parameter of this command.

Command Syntax

```
shutdown
no shutdown
```

Parameters

None

Default

No default value is specified

Command Mode

Router mode

Applicability

This command was introduced before OcNOS version 1.3.

Examples

```
#configure terminal
(config)#router ospf 100
(config-router)#shutdown
```

```
#configure terminal
(config)#router ospf 100
(config-router)#no shutdown
```

snmp context-name

Use this command to configure the SNMP context name which will be mapped to each OSPFv2 instance.

When context name is configured OSPF OID will be registered with SNMP to that context.

Use `no` form of the command to un-map the SNMP context name from OSPFv2 instance and unregister OSPF OID from SNMP.

Note: `snmp context-name` will not be allowed in default ospf context.

Command Syntax

```
snmp context-name <WORD>
no snmp context-name <WORD>
```

Parameters

`WORD` snmp context-name mapped to ospf instance. max length is 32

Command Mode

Router OSPF mode

Applicability

This command was introduced before OcnOS version 5.1.

Examples

```
(config)#router ospf 1
(config-router)#snmp context-name context1
```

snmp restart ospf

Use this command restart SNMP in OSPF

Command Syntax

```
snmp restart ospf
```

Parameter

None

Default

By default, SNMP restart is disabled.

Command Mode

Configure mode

Applicability

This command was introduced before OcNOS version 1.3.

Examples

```
#configure terminal  
(config)#snmp restart ospf
```

summary-address

Use this command to summarize or suppress external routes with the specified address range.

Use the `no` option with this command to disable summary address.

An address range is a pairing of an address and a mask that is almost the same as IP network number. For example, if the specified address range is 192.168.0.0/255.255.240.0, it matches 192.168.1.0/24, 192.168.4.0/22, 192.168.8.128/25 and so on.

Redistributing routes from other protocols into OSPF requires the router to advertise each route individually in an external LSA. Use this command to advertise one summary route for all redistributed routes covered by a specified network address and mask. This minimizes the size of the OSPF link state database.

Command Syntax

```
summary-address (A.B.C.D/M | A.B.C.D A.B.C.D) (not-advertise|tag <0-4294967295>|)
no summary-address (A.B.C.D/M | A.B.C.D A.B.C.D) (not-advertise|tag)
```

Parameters

A.B.C.D/M	The range of addresses given as IPv4 starting address and a mask.
A.B.C.D	IP summary prefix e.g. i.i.i.i
A.B.C.D	IP summary prefix mask e.g. m.m.m.m
not-advertise	Suppress routes that match the range.
tag	Tag value to use as a “match” value for controlling redistribution via route maps.
<0-4294967295>	Set a tag value.

Default

By default, tag value is 0

Command Mode

Router mode

Applicability

This command was introduced before OcNOS version 1.3.

Examples

The following example uses the `summary-address` command to aggregate external LSAs that match the network 172.16.0.0/24 and assign a tag value of 3.

```
#configure terminal
(config)#router ospf 100
(config-router)#summary-address 172.16.0.0/16 tag 3
```

te-metric

This command sets the traffic engineering (TE) metric for an interface.

The traffic engineering metric is used in OSPF-TE Link State Advertisements. If the traffic engineering metric is not set, the [ip ospf cost](#) value for an interface is used in OSPF-TE Link State Advertisements.

Use the `no` parameter with this command to set the traffic engineering metric to its default.

Command Syntax

```
te-metric <1-65535>
no te-metric
```

Parameters

<1-65535> Traffic engineering metric.

Default

By default, the [ip ospf cost](#) value for an interface is used.

Command Mode

Interface mode

Applicability

This command was introduced before OcNOS version 1.3.

Examples

```
#configure terminal
(config)#interface eth0
(config-if)#te-metric 6
```

timers lsa arrival

This command sets the minimum interval to accept the same link-state advertisement (LSA) from OSPF neighbors. Use the `no` form of this command to restore the default value.

Command Syntax

```
timers lsa arrival <0-600000>
no timers lsa arrival
```

Parameters

<0-600000> The minimum delay in milliseconds between accepting the same LSA from neighbors.

Default

By default, Minimum LSA Arrival timer is 1 sec.

Command Mode

Router mode

Applicability

This command was introduced before OcnOS version 1.3.

Examples

```
#configure terminal
(config)#router ospf 100
(config-router)#timers lsa arrival 5000
```

timers spf exp

Use this command to set the Shortest-Path First (SPF) best-path schedule minimum and maximum delay between receiving a change to SPF calculation in milliseconds.

Use no parameter of this command to unset the SPF best-path schedule.

Command Syntax

```
timers spf exp <0-2147483647> <0-2147483647>
no timers spf exp
```

Parameters

- <0-2147483647> The minimum delay in milliseconds between receiving a change to SPF calculation.
- <0-2147483647> The maximum delay in milliseconds between receiving a change to SPF calculation.

Default

Default minimum delay: 500 milliseconds

Default maximum delay: 50000 milliseconds (50 seconds)

Command Mode

Router mode

Applicability

This command was introduced before OcNOS version 1.3.

Examples

```
#configure terminal
(config)#router ospf 100
(config-router)#timers spf exp 300 300
```

timers throttle lsa

This command sets the rate-limiting intervals for OSPF link-state advertisement (LSA) generation.

Use the `no` form of this command to restore the default values.

Command Syntax

```
timers throttle lsa all <0-600000> <1-600000> <1-600000>
no timers throttle lsa all
```

Parameters

- | | |
|------------|---|
| <0-600000> | Start interval: The minimum delay in milliseconds for the generation of LSAs. The first instance of LSA is always generated immediately upon a local OSPF topology change. The generation of the next LSA is not before the start interval. |
| <0-600000> | Hold interval: The hold time in milliseconds. This value is used to calculate the subsequent rate limiting times for LSA generation. |
| <0-600000> | Maximum interval: The maximum wait time in milliseconds between generation of the same LSA. |

Defaults

Default start interval: 0 milliseconds

Default hold interval: 5000 milliseconds

Default maximum interval: 5000 milliseconds

Command Mode

Router mode

Applicability

This command was introduced before OcnOS version 1.3.

Examples

```
#configure terminal
(config)#router ospf 100
(config-router)#timers throttle lsa all 200 10000 45000
```

CHAPTER 2 OSPFv2 Graceful Restart Commands

This chapter describes the OSPFv2 graceful restart commands.

- [action interface](#)
- [capability restart](#)
- [debug ip ospf graceful-restart](#)
- [event nbr](#)
- [if-event-track ospf event](#)
- [ospf restart grace-period](#)
- [ospf restart helper](#)
- [restart ip ospf graceful](#)

action interface

Configure action for an interface whose cost has to be updated on neighbor going down.

Use the no parameter with this command to remove the configs.

Command Syntax

```
action interface IFNAME cost <1-65535>
```

Parameters

interface	Apply action on interface
IFNAME	Interface's name
cost	Interface cost
<1-65535>	cost

Command Mode

ospf interface event mode (config-ospf-if-event)

Default

None

Applicability

This command was introduced before OcNOS version 1.3.

Example

```
R1 (config-ospf-if-event)#action interface eth1 cost 100
R1 (config-ospf-if-event)#commit
R1 (config-ospf-if-event)#no action interface eth1 cost
R1 (config-ospf-if-event)#commit
```

capability restart

Use this command to enable OSPF graceful restart or restart signaling. If a router is not restart-enabled, it cannot enter graceful restart mode and act as a helper.

Use the `no` parameter with this command to disable the features.

Command Syntax

```
capability restart graceful
no capability restart graceful
```

Parameters

None

Default

By default, OSPF graceful restart or restart signaling is enabled.

Command Mode

Router mode

Applicability

This command was introduced before OcNOS version 1.3.

Examples

```
#configure terminal
(config)#router ospf 100
(config-router)#capability restart graceful

(config)#router ospf 100
(config-router)#no capability restart graceful
```

debug ip ospf graceful-restart

Use this command to specify debugging option for OSPF graceful restart.

Use the `no` parameter with this command to disable this function.

Command Syntax

```
debug ip ospf graceful-restart (detail|terse|)
no debug ip ospf graceful-restart (detail|terse|)
```

Parameters

<code>detail</code>	Debug OSPF graceful restart detail information
<code>terse</code>	Debug OSPF graceful restart summary information

Command Mode

Privileged Exec mode and Configure mode

Applicability

This command was introduced before OcNOS version 1.3.

Examples

```
#debug ip ospf graceful-restart detail
```

event nbr

Configure events with OSPF neighbor id to monitor the state of OSPF neighbor in order to trigger events on any of the down states.

Use the `no` parameter with this command to remove the configuration.

Command Syntax

```
event nbr A.B.C.D down
```

Parameters

<code>nbr</code>	Configure neighbor sub-event
<code>A.B.C.D</code>	Destination IPv4 address
<code>down</code>	Event type down

Default

None

Command Mode

ospf interface event mode (config-ospf-if-event)

Applicability

This command was introduced before OcNOS version 1.3.

Example

```
(config-ospf-if-event)#event nbr 10.1.1.1 down
(config-ospf-if-event)#commit
(config-ospf-if-event)#no event nbr 10.1.1.1 down
(config-ospf-if-event)#commit
```

if-event-track ospf event

Use this command to configure an interface-track event with a valid event name with either matching all events or matching any of the events configured.

Use the no parameter with this command to remove the configs.

Command Syntax

```
if-event-track ospf event NAME match < all | any >
```

Parameters

ospf	OSPF specific commands
event	Configure the event
NAME	Event Name
match	Match criteria
all	Match criteria all
any	Match criteria any

Default

None

Command Mode

Config Mode

Applicability

This command was introduced before OcNOS version 1.3.

Example

```
R1(config)#if-event-track ospf event test match all
R1(config-ospf-if-event)#commit
R1(config-ospf-if-event)#exit
R1(config)#no if-event-track ospf event test
R1(config)#commit
```

ospf restart grace-period

Use this command to set the grace period for restarting the router.

If graceful restart is enabled, NSM is notified about the grace period. If the OSPF daemon unexpectedly shuts down, NSM sends this value to the OSPF daemon when it comes up again which uses this value to end the graceful state.

Use the `no` parameter with this command to revert to the default.

Command Syntax

```
ospf restart grace-period <2-1800>
no ospf restart grace-period
```

Parameters

<2-1800> Grace period in seconds.

Default

The default grace period for restarting the OSPF router is 120 seconds.

Command Mode

Configure mode

Applicability

This command was introduced before OcnOS version 1.3.

Examples

```
#configure terminal
(config)#ospf restart grace-period 250
```

ospf restart helper

Use this command to configure the helper behavior for graceful restart.

Use the `no` parameter with this command to revert to default.

Command Syntax

```
ospf restart helper max-grace-period <2-1800>
ospf restart helper never (router-id A.B.C.D|)
no ospf restart helper never
no ospf restart helper (never router-id (A.B.C.D | all) | max-grace-period|)
```

Parameters

<code>max-grace-period</code>	Help only if received grace-period is less than this value.
<code><2-1800></code>	Help only if received grace-period is less than this value.
<code>router-id</code>	Neighbor to never to act as helper.
<code>A.B.C.D</code>	Router ID of neighbor to never to act as helper.
<code>never</code>	Prevent the neighbor from entering helper mode.
<code>all</code>	All neighbors to never to act as helper.

Default

By default, router behave as helper. To disable it as helper, `ospf restart helper never` command should be configured. `ospf restart helper max-grace-period - Max-grace-period` to function as helper. If not configured, value will be the grace-period in restarting node.

Command Mode

Configure mode

Applicability

This command was introduced before OcnOS version 1.3.

Examples

```
#configure terminal
(config)#ospf restart helper never router-id 1.1.1.1

#configure terminal
(config)#no ospf restart helper never router-id all
```

restart ip ospf graceful

Use this command to restart OSPF gracefully.

After this command is executed, the router immediately shuts down. NSM is notified that OSPF has shut down gracefully. NSM preserves routes installed by OSPF until the grace period expires.

Command Syntax

```
restart ip ospf graceful (grace-period <1-1800>|)
```

Parameters

<1-1800> Grace period in seconds.

Default

By default, restart ospf graceful is disabled. Default value of `grace-period` is 120 seconds.

Command Mode

Privileged Exec mode and Exec mode

Applicability

This command was introduced before OcNOS version 1.3.

Examples

```
#restart ip ospf graceful grace-period 200
```

CHAPTER 3 OSPFv3 Commands

This chapter provides an alphabetized reference for each of the OSPFv3 commands. It includes the following commands:

- `abr-type`
- `area default-cost`
- `area nssa`
- `area range`
- `area stub`
- `area virtual-link`
- `auto-cost reference bandwidth`
- `bfd all-interfaces`
- `clear ipv6 ospf process`
- `debug ipv6 ospf`
- `debug ipv6 ospf bfd`
- `debug ipv6 ospf events`
- `debug ipv6 ospf ifsm`
- `debug ipv6 ospf lsa`
- `debug ipv6 ospf n fsm`
- `debug ipv6 ospf nsm`
- `debug ipv6 ospf packet`
- `debug ipv6 ospf retransmission`
- `debug ipv6 ospf rib`
- `debug ipv6 ospf route`
- `default-information originate`
- `default-metric`
- `distance`
- `distribute bgp-ls`
- `distribute-list`
- `enable db-summary-opt`
- `ipv6 ospf authentication`
- `ipv6 ospf bfd`
- `ipv6 ospf cost`
- `ipv6 ospf dead-interval`
- `ipv6 ospf display route single-line`
- `ipv6 ospf hello-interval`
- `ipv6 ospf link-lsa-suppression`
- `ipv6 ospf mtu`
- `ipv6 ospf mtu-ignore`

- `ipv6 ospf neighbor`
- `ipv6 ospf network`
- `ipv6 ospf priority`
- `ipv6 ospf retransmit-interval`
- `ipv6 ospf transmit-delay`
- `ipv6 router ospf`
- `ipv6 te-metric`
- `log-adjacency-changes`
- `max-concurrent-dd`
- `passive-interface`
- `redistribute`
- `router-id`
- `router ipv6 ospf`
- `show debugging ipv6 ospf`
- `show ipv6 ospf`
- `show ipv6 ospf database`
- `show ipv6 ospf interface`
- `show ipv6 ospf neighbor`
- `show ipv6 ospf route`
- `show ipv6 route fast-reroute`
- `show ipv6 ospfv3 topology`
- `show ipv6 ospf virtual-links`
- `show ipv6 vrf`
- `shutdown`
- `snmp restart ospf6`
- `summary-address`
- `timers spf exp`

abr-type

Use this command to set an OSPFv3 Area Border Router (ABR) type.

Use the `no` parameter with this command to revert the ABR type to the default setting (`cisco`).

Specifying the ABR type allows better functioning in a multi-vendor environment. The ABR types are:

- Cisco (RFC 3509): A router is considered an ABR if it has more than one area actively attached and one of them is the backbone area.
- IBM (RFC 3509): A router is considered an ABR if it has more than one area actively attached and the backbone area is configured. In this case the configured backbone need not be actively connected.
- Standard (RFC 2328): A router is considered an ABR if it has more than one area actively attached to it.

Command Syntax

```
abr-type (cisco|ibm|standard)
no abr-type
```

Parameters

<code>cisco</code>	Specify an alternative ABR using Cisco implementation. This is the default ABR type.
<code>ibm</code>	Specify an alternative ABR using IBM implementation.
<code>standard</code>	Specify a standard ABR.

Default

By default, ABR type is Cisco

Command Mode

Router mode

Applicability

This command was introduced before OcNOS version 1.3.

Examples

```
#configure terminal
(config)#router ipv6 ospf
(config-router)#abr-type standard
```

area default-cost

Use this command to specify the cost for default summary route sent into a stub or a NSSA area. If an area is configured as a stub, the OSPFv3 router originates one type-3 inter-area-prefix-LSA into the stub area. This command changes the metric for this LSA.

Use the `no` parameter with this command to remove the assigned default cost.

Command Syntax

```
area (A.B.C.D|<0-4294967295>) default-cost (<0-16777215>)  
no area (A.B.C.D|<0-4294967295>) default-cost
```

Parameters

A.B.C.D	OSPF Area ID in IPv4 address format.
<0-4294967295>	OSPF Area ID as a decimal value.
<0-16777215>	The advertised cost for the default summary route used for a stub or NSSA area.

Default

By default, advertised cost for the default summary route is 1.

Command Mode

Router mode

Applicability

This command was introduced before OcNOS version 1.3.

Examples

```
#configure terminal  
(config)#router ipv6 ospf  
(config-router)#area 1 default-cost 10
```

area nssa

Use this command to set an area as a Not-So-Stubby-Area (NSSA). There are no external routes in an OSPF stub area, so you cannot redistribute from another protocol into a stub area. An NSSA allows external routes to be flooded within the area. These routes are then leaked into other areas. However, the external routes from other areas still do not enter the NSSA. You can configure an area to be a stub area or an NSSA, but not both.

This command simplifies administration when connecting a central site using OSPF to a remote site that is using a different routing protocol. You can extend OSPF to cover the remote connection by defining the area between the central router and the remote router as a NSSA.

Use the `no` form of this command to make an area a normal area.

Command Syntax

```
area (A.B.C.D|<0-4294967295>) nssa
area (A.B.C.D|<0-4294967295>) nssa {translator-role (candidate|always)|stability-
  interval <0-2147483647>|no-redistribution|default-information-originate (metric
  <0-16777214>|metric-type <1-2>|)|no-summary}
no area (A.B.C.D|<0-4294967295>) nssa
no area (A.B.C.D|<0-4294967295>) nssa {translator-role|stability-interval|no-
  redistribution|default-information-originate|no-summary}
```

Parameters

A.B.C.D	OSPF Area ID in IPv4 address format.
<0-4294967295>	OSPF Area ID as a decimal value.
translator-role	NSSA-ABR translator role:
candidate	Translate NSSA-LSA to Type-5 LSA if router is elected.
always	Always translate NSSA-LSA to Type-5 LSA.
stability-interval	Stability timer for a NSSA area. If an elected translator determines its services are no longer required, it continues to perform its duties for this time interval. This minimizes excess flushing of translated Type-7 LSAs and provides a more stable translator transition.
<0-2147483647>	Stability interval in seconds.
no-redistribution	Do not redistribute into the NSSA.
default-information-originate	Originate Type-7 default LSA into the NSSA.
metric	Specify metric for default routes.
<0-16777214>	Specify metric value.
metric-type	Specify metric type (see RFC 3101).

<1-2>	Specify metric type: 1: Type 1 external route 2: Type 2 external route
no-summary	Do not inject inter-area routes into the NSSA.
translate-candidate	Translate NSSA-LSA to Type-5 LSA if router is elected.
translate-always	Always translate NSSA-LSA to Type-5 LSA.

Default

By default, the nssa option value is candidate.

Command Mode

Router mode

Applicability

This command was introduced before OcNOS version 1.3.

Examples

```
(config)#router ipv6 ospf
(config-router)#area 3 nssa translator-role candidate no-redistribution
default-information-originate metric 34 metric-type 2
```

area range

Use this command to configure the OSPF address range. This command summarizes intra-area routes for an area. The single summary route is then advertised to other areas by the Area Border Routers (ABRs). Routing information is condensed at area boundaries and outside the area. If the network numbers in an area are assigned in a way such that they are contiguous, the ABRs can be configured to advertise a summary route that covers all the individual networks within the area that fall into the specified range.

Use the `no` parameter with this command to remove the assigned area range.

Command Syntax

```
area (A.B.C.D|<0-4294967295>) range X:X::X:X/M
area (A.B.C.D|<0-4294967295>) range X:X::X:X/M (not-advertise|)
no area (A.B.C.D|<0-4294967295>) range X:X::X:X/M (not-advertise|)
```

Parameters

A.B.C.D	OSPF Area ID in IPv4 address format.
<0-4294967295>	OSPF Area ID as a decimal value.
X:X::X:X/M	The area IPv6 range prefix and length.
not-advertise	Does not advertise this range.

Default

By default, OSPF address range is advertised.

Command Mode

Router mode

Applicability

This command was introduced before OcNOS version 1.3.

Examples

```
#configure terminal
(config)#router ipv6 ospf
(config-router)#area 1 range 2000::/3
```

area stub

Use this command to define an area as a stub area on all routers. There are two stub area router configuration commands: the `stub` and `no stub` commands. In all routers attached to the stub area, configure the area by using the `stub` option of the `area` command. For an area border router (ABR) attached to the stub area, use the `area stub` command.

Use the `no` form of this command to make an area a normal area.

Command Syntax

```
area (A.B.C.D|<0-4294967295>) stub
area (A.B.C.D|<0-4294967295>) stub no-summary
no area (A.B.C.D|<0-4294967295>) stub
no area (A.B.C.D|<0-4294967295>) stub no-summary
```

Parameters

A.B.C.D	OSPF Area ID in IPv4 address format.
<0-4294967295>	OSPF Area ID as a decimal value.
no-summary	Stops an ABR from sending summary link advertisements into the stub area.

Default

No stub area is defined.

Command Mode

Router mode

Applicability

This command was introduced before OcNOS version 1.3.

Examples

```
#configure terminal
(config)#router ipv6 ospf
(config-router)#area 1 stub no-summary
```

area virtual-link

Use this command to configure a link between two backbone areas that are physically separated through other nonbackbone areas.

Use the `no` parameter with this command to remove the virtual link.

In OSPFv3, all non-backbone areas must be connected to a backbone area. If the connection to the backbone is lost, the virtual link repairs the connection. You can configure virtual links between any two backbone routers that have an interface to a common non-backbone area. The protocol treats these two routers joined by a virtual link as if they were connected by an unnumbered point-to-point network.

Configure the `hello-interval` to be the same for all routers attached to a common network. If the `hello-interval` is short, the router detects topological changes faster, but more routing traffic follows.

The `retransmit-interval` is the expected round-trip delay between any two routers in a network. Set the value to be greater than the expected round-trip delay to avoid needless retransmissions.

The `transmit-delay` is the time taken to transmit a link state update packet on the interface. Before transmission, the link state advertisements in the update packet are increased by this amount. Set the `transmit-delay` to be greater than zero. Also, take into account the transmission and propagation delays for the interface.

Command Syntax

```
area (A.B.C.D|<0-4294967295>) virtual-link A.B.C.D
area (A.B.C.D|<0-4294967295>) virtual-link A.B.C.D fall-over bfd
area (A.B.C.D|<0-4294967295>) virtual-link A.B.C.D (dead-interval <1-65535>|hello-
interval <1-65535>|retransmit-interval <1-1800>|transmit-delay <1-1800>)
area (A.B.C.D|<0-4294967295>) virtual-link A.B.C.D instance-id (<0-31>|<64-95>)
no area (A.B.C.D|<0-4294967295>) virtual-link A.B.C.D fall-over bfd
no area (A.B.C.D|<0-4294967295>) virtual-link A.B.C.D
no area (A.B.C.D|<0-4294967295>) virtual-link A.B.C.D (dead-interval|hello-
interval|retransmit-interval|transmit-delay)
no area (A.B.C.D|<0-4294967295>) virtual-link A.B.C.D instance-id
```

Parameters

<code>A.B.C.D</code>	OSPF Area ID in IP64 address format.
<code><0-4294967295></code>	OSPF Area ID as a decimal value.
<code>A.B.C.D</code>	Specify router ID associated with a virtual link neighbor.
<code>dead-interval</code>	The interval in seconds during which no packets are received and after which the router acknowledges a neighboring router as off-line.
<code><1-65535></code>	The timer interval.
<code>hello-interval</code>	The interval in seconds the router waits before it sends a hello packet.
<code><1-65535></code>	The timer interval.
<code>retransmit-interval</code>	The interval in seconds the router waits before it retransmits a packet.
<code><1-1800></code>	The timer interval.
<code>transmit-delay</code>	The interval in seconds the router waits before it transmits a packet.

<1-1800>	The timer interval.
instance-id	The OSPFv3 instance.
<0-31>	Interface instance ID for IPv6 unicast
<64-95>	Interface instance ID for IPv4 unicast.
fall-over bfd	Fall-over Bidirectional Forwarding Detection (BFD).

Default

Default hello interval:10 seconds.

Default dead interval:40 seconds.

Default retransmit interval: 5 seconds.

Default transmit delay: 1 second

Default instance-id: 0

Command Mode

Router mode

Applicability

This command was introduced before OcNOS version 1.3.

Examples

```
#configure terminal
(config)#router ipv6 ospf
(config-router)#area 1 virtual-link 10.10.11.50 hello 5 dead 10
(config-router)#area 1 virtual-link 10.10.11.50 instance-id 1
(config-router)#area 1 virtual-link 10.10.11.50 fall-over bfd
```

auto-cost reference bandwidth

Use this command to control how OSPFv3 calculates default metrics for the interface.

By default, OSPFv3 calculates the OSPFv3 metric for an interface by dividing the reference bandwidth by the interface bandwidth. The auto-cost command is used to differentiate high bandwidth links. For multiple links with high bandwidth, specify a larger reference bandwidth value to differentiate cost on those links.

Use the `no` form of this command to assign cost based only on the interface bandwidth.

Command Syntax

```
auto-cost reference-bandwidth <1-4294967>
no auto-cost reference-bandwidth
```

Parameters

<1-4294967> The reference bandwidth in Mbps per second.

Default

By default, reference bandwidth is 100Mbps

Command Mode

Router mode

Applicability

This command was introduced before OcNOS version 1.3.

Examples

This example changes the reference bandwidth to 1Gbps to change the Fast Ethernet interface cost from 1 to 10.

```
#configure terminal
(config)#router ipv6 ospf 1
(config-router)#auto-cost reference-bandwidth 1000

(config)#router ipv6 ospf 1
(config-router)#no auto-cost reference-bandwidth
```

bfd all-interfaces

Use this command to enable Bidirectional Forwarding Detection (BFD) on all interfaces.

Use the `no` form of this command to disable BFD.

Command Syntax

```
bfd all-interfaces
no bfd all-interfaces
```

Parameters

None

Default

By default, BFD is disabled on all OSPF enabled interfaces.

Command Mode

Router mode

Applicability

This command was introduced before OcNOS version 1.3.

Examples

This example changes the reference bandwidth to 1Gbps to change the Fast Ethernet interface cost from 1 to 10.

```
#configure terminal
(config)#router ipv6 ospf 1
(config-router)#bfd all-interfaces
```

clear ipv6 ospf process

Use this command to clear and restart all OSPFv3 routing processes or a given OSPFv3 routing process.

Command Syntax

```
clear ipv6 ospf (WORD|) process
```

Parameters

WORD OSPFv3 process tag.

Command Mode

Privileged Exec Mode

Applicability

This command was introduced before OcnOS version 1.3.

Examples

```
#clear ipv6 ospf Tag1 process
```

debug ipv6 ospf

Use this command to specify all debugging options for OSPFv3.

Use the `no` form of this command to disable the options.

Command Syntax

```
debug ipv6 ospf (all|bfd|events|ifsm|lsa|nfsm|nsm|packet|retransmission|rib|route|)
```

```
no debug ipv6 ospf
```

```
(all|bfd|events|ifsm|lsa|nfsm|nsm|packet|retransmission|rib|route|)
```

```
undebug ipv6 ospf (all|bfd|events|ifsm|lsa|nfsm|nsm|packet|rib|route)
```

```
no debug all ipv6 ospf
```

```
undebug all ipv6 ospf
```

```
no debug all
```

```
undebug all
```

Parameters

<code>all</code>	Enables all debugging information.
<code>bfd</code>	Debug OSPFv3 Bidirectional Forwarding Detection. (see debug ipv6 ospf bfd)
<code>events</code>	Debug OSPFv3 events (see debug ipv6 ospf events).
<code>ifsm</code>	Debug OSPFv3 Interface State Machines (see debug ipv6 ospf ifsm).
<code>lsa</code>	Debug OSPFv3 Link State Advertisements (see debug ipv6 ospf lsa).
<code>nfsm</code>	Debug OSPFv3 Neighbor State Machines (see debug ipv6 ospf nfsm).
<code>nsm</code>	Debug OSPFv3 NSM information (see debug ipv6 ospf nsm).
<code>packet</code>	Debug OSPFv3 packets (see debug ipv6 ospf packet).
<code>retransmission</code>	Debug OSPFv3 retransmission information. (see debug ipv6 ospf retransmission)
<code>rib</code>	Debug OSPFv3 Routing Information Base.(see debug ipv6 ospf rib)
<code>route</code>	Debug OSPFv3 route information (see debug ipv6 ospf route).

Command Mode

Privileged Exec and Configure mode

Applicability

This command was introduced before OcnOS version 1.3.

Examples

```
#debug ipv6 ospf all
```

debug ipv6 ospf bfd

Use this command to specify the debugging options for OSPFv3 Bidirectional Forwarding Detection

Use the `no` parameter with this command to disable this function.

Command Syntax

```
debug ipv6 ospf bfd
no debug ipv6 ospf bfd
undebug ipv6 ospf bfd
```

Parameters

None

Command Mode

Privileged Exec mode and Configure mode

Applicability

This command was introduced before OcnOS version 1.3.

Examples

```
#debug ipv6 ospf bfd
```

debug ipv6 ospf events

Use this command to display debug information related to OSPF internal events. Use this command without parameters to turn on all the options.

Use the `no` parameter with this command to disable this function.

Command Syntax

```
debug ipv6 ospf events {(abr|asbr|os|router|vlink|nssa)}  
no debug ipv6 ospf events {(abr|asbr|os|router|vlink|nssa)}  
undebug ipv6 ospf events {(abr|asbr|os|router|vlink|nssa)}
```

Parameters

abr	Debug ABR events
asbr	Debug ASBR events
os	Debug OS interaction events
router	Debug other router events
vlink	Debug virtual link events
nssa	Debug NSSA events

Command Mode

Privileged Exec mode and Configure mode

Applicability

This command was introduced before OcNOS version 1.3.

Examples

```
#no debug ipv6 ospf events abr  
#debug ipv6 ospf events asbr
```

debug ipv6 ospf ifsm

Use this command to specify debugging options for OSPFv3 Interface Finite State Machine (IFSM) troubleshooting.

Use the `no` parameter with this command to disable this function.

Command Syntax

```
debug ipv6 ospf ifsm ({events|status|timers|})
no debug ipv6 ospf ifsm ({events|status|timers|})
undebug ipv6 ospf ifsm ({events|status|timers|})
```

Parameters

<code>events</code>	Debug IFSM event information.
<code>status</code>	Debug IFSM status information.
<code>timers</code>	Debug IFSM timer information.

Command Mode

Privileged Exec mode and Configure mode

Applicability

This command was introduced before OcNOS version 1.3.

Examples

```
#debug ipv6 ospf ifsm status
```

debug ipv6 ospf lsa

Use this command to specify the debugging options for OSPFv3 Link State Advertisements (LSAs).

Use the `no` parameter with this command to disable this function.

Command Syntax

```
debug ipv6 ospf lsa {(generate|flooding|install|maxage|refresh) |}  
no debug ipv6 ospf lsa {(generate|flooding|install|maxage|refresh) |}  
undebug ipv6 ospf lsa {(generate|flooding|install|maxage|refresh) |}
```

Parameters

<code>generate</code>	Debug LSA generation.
<code>flooding</code>	Debug LSA flooding.
<code>install</code>	Debug LSA installation.
<code>maxage</code>	Debug the maximum age processing.
<code>refresh</code>	Debug LSA refresh.

Command Mode

Privileged Exec mode and Configure mode

Applicability

This command was introduced before OcnOS version 1.3.

Examples

```
#debug ipv6 ospf lsa
```

debug ipv6 ospf nfsm

Use this command to specify debugging options for OSPFv3 Neighbor Finite State Machines (NFSMs).

Use the `no` parameter with this command to disable this function.

Command Syntax

```
debug ipv6 ospf nfsm {(events|status|timers)}  
no debug ipv6 ospf nfsm {(events|status|timers)}  
undebug ipv6 ospf nfsm {(events|status|timers)}
```

Parameters

<code>events</code>	Debug NFSM event information.
<code>status</code>	Debug NFSM status information.
<code>timers</code>	Debug NFSM timer information.

Command Mode

Privileged Exec mode and Configure mode

Applicability

This command was introduced before OcNOS version 1.3.

Examples

```
#debug ipv6 ospf nfsm events  
#no debug ipv6 ospf nfsm timers
```

debug ipv6 ospf nsm

Use this command to specify the debugging options for OSPFv3 NSM information.

Use the `no` parameter with this command to disable this function.

Command Syntax

```
debug ipv6 ospf nsm {(interface|redistribute)}  
no debug ipv6 ospf nsm {(interface|redistribute)}  
undebug ipv6 ospf nsm {(interface|redistribute)}
```

Parameters

<code>redistribute</code>	Debug redistribute.
<code>interface</code>	Debug the NSM interface.

Command Mode

Privileged Exec mode and Configure mode

Applicability

This command was introduced before OcnOS version 1.3.

Examples

```
#debug ipv6 ospf nsm interface
```

debug ipv6 ospf packet

Use this command to specify the packet debugging options for OSPFv3 information.

Use the `no` parameter with this command to disable this function.

Command Syntax

```
debug ipv6 ospf packet ({hello|dd|ls-request|ls-update|ls-ack|send|recv|detail}|)
```

```
no debug ipv6 ospf packet ({hello|dd|ls-request|ls-update|ls-ack|send|recv|detail}|)
```

```
undebug ipv6 ospf packet ({hello|dd|ls-request|ls-update|ls-ack|send|recv|detail}|)
```

Parameters

<code>hello</code>	Debug OSPFv3 hello.
<code>dd</code>	Debug OSPFv3 database description.
<code>ls-request</code>	Debug OSPFv3 link state request.
<code>ls-update</code>	Debug OSPFv3 link state update.
<code>ls-ack</code>	Debug OSPFv3 link state acknowledgment.
<code>send</code>	Debug packets sent
<code>recv</code>	Debug packets received.
<code>detail</code>	Debug detail information.

Command Mode

Privileged Exec mode and Configure mode

Applicability

This command was introduced before OcNOS version 1.3.

Examples

```
#debug ipv6 ospf packet ls-request
```

debug ipv6 ospf retransmission

Use this command to specify the debugging options for OSPFv3 retransmission information.

Use the `no` parameter with this command to disable this function.

Command Syntax

```
debug ipv6 ospf retransmission
no debug ipv6 ospf retransmission
```

Parameters

None

Command Mode

Privileged Exec mode and Configure mode

Applicability

This command was introduced before OcNOS version 1.3.

Examples

```
#debug ipv6 ospf retransmission
```

debug ipv6 ospf rib

Use this command to specify the debugging options for OSPFv3 RIB information.

Use the `no` parameter with this command to disable this function.

Command Syntax

```
debug ipv6 ospf rib {(interface|redistribute)|}
```

```
no debug ipv6 ospf rib {(interface|redistribute)|}
```

```
undebug ipv6 ospf rib {(interface|redistribute)|}
```

Parameters

<code>redistribute</code>	Debug redistribute.
<code>interface</code>	Debug the NSM interface.

Command Mode

Privileged Exec mode and Configure mode

Applicability

This command was introduced before OcNOS version 1.3.

Examples

```
#debug ipv6 ospf rib interface
```

debug ipv6 ospf route

Use this command to specify which route calculation to debug. Use this command without parameters to turn on all the options.

Use the `no` parameter with this command to disable this function.

Command Syntax

```
debug ipv6 ospf route {(ase|ia|install|spf)|}  
no debug ipv6 ospf route {(ase|ia|install|spf)|}  
undebug ipv6 ospf route {(ase|ia|install|spf)|}
```

Parameters

ase	Debug external route calculations.
ia	Debug inter-area route calculations.
install	Debug the route installation.
spf	Debug the SPF calculation.

Command Mode

Privileged Exec mode and Configure mode

Applicability

This command was introduced before OcNOS version 1.3.

Examples

```
#no debug ipv6 ospf route  
#debug ipv6 ospf route ia
```

default-information originate

Use this command to create a default external route into an OSPF routing domain.

The system acts like an Autonomous System Boundary Router (ASBR) when you use the `default-information originate` command to redistribute routes into an OSPF routing domain. An ASBR does not by default generate a default route into the OSPF routing domain.

When you give the `default-information originate` command, also specify a `route-map` to avoid a dependency on the default network in the routing table.

Use the `no` parameter with this command to disable this feature.

Command Syntax

```
default-information originate
default-information originate {metric <0-16777214>|metric-type (1|2)|route-map
WORD|always}
no default-information originate
no default-information originate {metric|metric-type|route-map|always}
```

Parameters

<code>always</code>	Used to advertise the default route regardless of whether there is a default route.
<code>metric</code>	Sets the OSPF metric used in creating the default route.
<code><0-16777214></code>	Sets the OSPF metric used in creating the default route. The value used is specific to the protocol.
<code>metric-type</code>	The external link type associated with the default route advertised into the OSPF routing domain (see RFC 3101).
<code>1</code>	Sets OSPF External Type 1 metric.
<code>2</code>	Sets OSPF External Type 2 metric (default).
<code>route-map</code>	Route map.
<code>WORD</code>	Specify the name of route map.

Default

Sets the OSPF metric used in creating the default route. The default metric value is 20. The value used is specific to the protocol. `metric-type` The external link type associated with the default route advertised into the OSPF routing domain (see RFC 3101).

By default, 2 sets OSPF External Type 2 metric

Command Mode

Router mode

Applicability

This command was introduced before OcNOS version 1.3.

Examples

```
#configure terminal
(config)#router ipv6 ospf
(config-router)#default-information originate always metric 23 metric-type 2
route-map myinfo

(config)#router ipv6 ospf
(config-router)#no default-information originate metric metric-type route-map
```

default-metric

Use this command to set a default metric for OSPF.

A default metric facilitates redistributing routes with incompatible metrics. If the metrics do not convert, the default metric provides an alternative. Use this command to use the same metric value for all redistributed routes. Use this command in conjunction with the [redistribute](#) command.

Use the `no` parameter with this command to return to the default state.

Command Syntax

```
default-metric <1-16777214>
no default-metric
```

Parameter

<1-16777214> Default metric value.

Default

Default metric for redistributed routes will be 20.

Command Mode

Router mode

Applicability

This command was introduced before OcnOS version 1.3.

Examples

```
#configure terminal
(config)#router ipv6 ospf
(config-router)#default-metric 100
```

distance

Use this command to define OSPFv3 route administrative distances based on route type. This command sets the distance for an entire group of routes rather than a specific route that passes an access list.

The administrative distance rates the trustworthiness of a routing information source. A higher distance value means a lower trust rating. For example, an administrative distance of 254 means that the routing information source cannot be trusted and should be ignored.

Use the `no` form of this command to restore the default value.

Command Syntax

```
distance <1-254>
distance ospfv3 {intra-area <1-254>|inter-area <1-254>|external <1-254>}
no distance (<1-254>|)
no distance ospfv3 {intra-area |inter-area |external}
```

Parameters

<1-254>	Used alone, this parameter specifies a default administrative distance used when no other specification exists for a routing information source.
intra-area	Routes within an area.
<1-254>	Distance for all routes within an area
inter-area	Routes from one area to another area.
<1-254>	Distance for all routes from one area to another area.
external	Routes from other routing domains learned by redistribution.
<1-254>	Distance for routes from other routing domains learned by redistribution.

Default

By default, distance value for each type of route is 110

Command Mode

Router mode

Applicability

This command was introduced before OcnOS version 1.3.

Example

```
#configure terminal
(config)#router ipv6 ospf 100
(config-router)#distance ospfv3 inter-area 20 intra-area 10 external 40
```

distribute bgp-ls

Use this command to advertise IGP (OSPFv3) Updates to BGP module. Throttle value is optional, which can be used to delay the transmission of processing and sending updates to BGP

Use the `no` command to disable this function.

Command Syntax

```
distribute bgp-ls
distribute bgp-ls (throttle <val>)
no distribute bgp-ls
```

Parameters

<code>distribute</code>	distribute information
<code>bgp-ls</code>	Link State distribution to BGP

Default

By default, `bgp-ls` is disabled

Command Mode

Router mode

Applicability

This command was introduced before OcnOS version 6.1.0.

Examples

```
OcnOS#conf t
Enter configuration commands, one per line. End with CNTL/Z.
(config)#router ipv6 ospf 1
(config-router)#distribute bgp-ls throttle 10
```

distribute-list

Use this command to filter networks in routing updates. This command redistributes other routing protocols into the OSPF routing table.

Use the `no` parameter with this command to disable this function.

Command Syntax

```
distribute-list WORD out ((kernel|connected|static|rip|bgp|isis|ospf (WORD|<1-65535>|)))
distribute-list WORD in
no distribute-list WORD out ((kernel|connected|static|rip|bgp|isis|ospf (WORD|<1-65535>|)))
no distribute-list WORD in
```

Parameters

<code>WORD</code>	Specify the name of the access list.
<code>in</code>	Filter incoming routing updates.
<code>out</code>	Filter outgoing routing updates.
<code>kernel</code>	Specify kernel routes.
<code>connected</code>	Specify connected routes.
<code>static</code>	Specify static routes.
<code>rip</code>	Specify RIP routes.
<code>bgp</code>	Specify BGP routes.
<code>isis</code>	Specify IS-IS routes.
<code>ospf</code>	Specify OSPF routes.
<code>WORD</code>	Specify the OSPF process tag. If not specified, redistribute OSPF process with tag "null".
<code><1-65535></code>	Specify OSPF process ID <code><1-65535></code> . If not specified, redistribute OSPF instance with process ID 0.

Default

No default value is specified

Command Mode

Router mode

Applicability

This command was introduced before OcnOS version 1.3.

Examples

The following example shows the distribution of BGP routing updates based on the access list `list1` (network 172.10.0.0).

```
#configure terminal
(config)#access-list list1 permit 172.10.0.0/16
```



```
(config)#router ipv6 ospf 100  
(config-router)#distribute-list list1 out bgp  
(config-router)#redistribute bgp
```

enable db-summary-opt

Use this command to enable the database summary list optimization for OSPFv3.

When this feature is enabled, the database exchange process is optimized by removing the LSA from the database summary list for the neighbor if the LSA instance in the summary list is the same as or less recent than the LSA in the database description packet received from the neighbor.

Use the `no` form of the command to disable database summary list optimization.

Command Syntax

```
enable db-summary-opt
no enable db-summary-opt
```

Parameters

None

Default

By default, db summary opt is disabled

Command Mode

Router mode

Applicability

This command was introduced before OcNOS version 1.3.

Examples

```
#configure terminal
(config)#router ipv6 ospf
(config-router)#enable db-summary-opt
(config-router)#no enable db-summary-opt
```

ipv6 ospf authentication

Use this command to enable the authentication and/or confidentiality for OSPFv3 sessions on this interface using crypto map configuration.

Use no form of this command to disable the authentication and/or confidentiality for OSPFv3 sessions.

Command Syntax

```
ipv6 ospf authentication cryptomap WORD
no ipv6 ospf authentication cryptomap WORD
```

Parameters

authentication	IPsec Authentication
cryptomap	Map used to setup IPsec SA
WORD	Name of the Crypto-map

Default

No default value.

Command Mode

Interface mode

Applicability

This command was introduced in OcNOS version 6.0.0.

Example

```
#configure terminal
(config)#interface eth1
(config-if)#ipv6 ospf authentication cryptomap map1
```

ipv6 ospf bfd

Use this command to enable Bidirectional Forwarding Detection (BFD).

Use this command with either the no or disable parameter to disable BFD.

Command Syntax

```
ipv6 ospf bfd (disable|)
ipv6 ospf bfd (disable|)instance-id (<0-31>|<64-95>)
no ipv6 ospf bfd (disable|)
no ipv6 ospf bfd (disable|)instance-id (<0-31>|<64-95>)
```

Parameters

disable	Specify to disable BFD.
instance-id	Specify the instance. Default value for instance-id is 0.
<0-31>	Interface instance ID for IPv6 unicast
<64-95>	Interface instance ID for IPv4 unicast

Default

By default, IPv6 OSPF BFD is disabled

Command Mode

Interface mode

Applicability

This command was introduced before OcnOS version 1.3.

Example

```
#configure terminal
(config)#interface eth1
(config-if)#ipv6 ospf bfd instance-id 2
```

Note: Interface level CLI: "ipv6 ospf bfd" will be displayed as "ipv6 ospf bfd instance-id 0" from 5.0 release.

ipv6 ospf cost

Use this command to specify the link-cost described in LSAs.

The cost (or metric) of an interface in OSPF indicates the overhead required to send packets across a certain interface. The value is taken to describe Link State information, and used for route calculation.

Use the `no` parameter with this command to reset the cost to default.

Command Syntax

```
ipv6 ospf cost <1-65535>
ipv6 ospf cost <1-65535> instance-id (<0-31>|<64-95>)
no ipv6 ospf cost
no ipv6 ospf cost instance-id (<0-31>|<64-95>)
```

Parameters

<code>cost</code>	Specify the link-state metric.
<code><1-65535></code>	Specify the link-state metric.
<code>instance-id</code>	Specify the instance.
<code><0-31></code>	Interface instance ID for IPv6 unicast
<code><64-95></code>	Interface instance ID for IPv4 unicast.

Default

By default, ipv6 cost value is 10.

Command Mode

Interface mode

Applicability

This command was introduced before OcnOS version 1.3.

Examples

```
#configure terminal
(config)#interface eth0
(config-if)#ipv6 ospf cost 20 instance-id 1
```

ipv6 ospf dead-interval

Use this command to set the amount of time that the router waits to receive an OSPF hello packet from the neighbor before declaring the neighbor down.

The dead interval is advertised in hello packets. OSPF compares the dead interval in a received packet to the dead interval configured for the receiving interface. If the intervals do not match, the hello packet is discarded.

Use the `no` parameter with this command to reset the interval to default.

Command Syntax

```
ipv6 ospf dead-interval <1-65535>
ipv6 ospf dead-interval <1-65535> instance-id (<0-31>|<64-95>)
no ipv6 ospf dead-interval
no ipv6 ospf dead-interval instance-id (<0-31>|<64-95>)
```

Parameters

<code>dead-interval</code>	Specify the interval.
<code><1-65535></code>	Specify the interval in seconds.
<code>instance-id</code>	Specify the instance.
<code><0-31></code>	Interface instance ID for IPv6 unicast
<code><64-95></code>	Interface instance ID for IPv4 unicast.

Default

By default, dead interval is 40 seconds

Command Mode

Interface mode

Applicability

This command was introduced before OcNOS version 1.3.

Examples

```
#configure terminal
(config)#interface eth0
(config-if)#ipv6 ospf dead-interval 20
```

ipv6 ospf display route single-line

Use this command to display the output of the [show ipv6 ospf route](#) command with each route entry in a single-line.

Use the `no` parameter with this command to display the output with each route entry in a multiple lines.

Command Syntax

```
ipv6 ospf display route single-line
no ipv6 ospf display route single-line
```

Parameters

None

Default

By default, [show ipv6 ospf route](#) displays routes in multiple lines

Command Mode

Configure mode

Applicability

This command was introduced before OcNOS version 1.3.

Examples

```
#configure terminal
(config)#ipv6 ospf display route single-line
```

ipv6 ospf hello-interval

Use this command to specify the interval between `hello` packets.

The hello interval is advertised in the hello packets. An OSPF router compares the hello interval in a received packet to the interval configured for the receiving interface. If this interval does not match, the hello packet is discarded. A shorter hello interval ensures faster detection of topological changes, but results in more routing traffic.

Use the `no` parameter with this command to reset the interval to default.

Command Syntax

```
ipv6 ospf hello-interval <1-65535>
ipv6 ospf hello-interval <1-65535> instance-id (<0-31>|<64-95>)
no ipv6 ospf hello-interval
no ipv6 ospf hello-interval instance-id (<0-31>|<64-95>)
```

Parameters

<code>hello-interval</code>	Specify the interval.
<code><1-65535></code>	Specify the interval in seconds.
<code>instance-id</code>	Specify the instance.
<code><0-31></code>	Interface instance ID for IPv6 unicast
<code><64-95></code>	Interface instance ID for IPv4 unicast.

Default

By default, hello interval is 10 seconds

Command Mode

Interface mode

Applicability

This command was introduced before OcnOS version 1.3.

Examples

```
#configure terminal
(config)#interface eth0
(config-if)#ipv6 ospf hello-interval 5 instance-id 1
```

ipv6 ospf link-lsa-suppression

Use this command to enable or disable link LSA (type 8) suppression. A type 8 LSA gives information about link-local addresses and a list of IPv6 addresses on the link.

If enabled and the interface type is *not* broadcast or NBMA, the router does not send type 8 link LSAs. This implies that other routers on the link determine the router's next-hop address using a mechanism other than the type 8 link LSA. This feature is implicitly disabled if the interface type is broadcast or NBMA.

Command Syntax

```
ipv6 ospf link-lsa-suppression (enable|disable)
ipv6 ospf link-lsa-suppression (enable|disable) instance-id (<0-31>|<64-95>)
```

Parameters

enable	Enable type 8 link LSA suppression
disable	Disable type 8 link LSA suppression (default).
<0-31>	Interface instance ID for IPv6 unicast
<64-95>	Interface instance ID for IPv4 unicast.

Default

By default, type 8 link LSA suppression is disabled

Command Mode

Interface mode

Applicability

This command was introduced before OcnOS version 1.3.

Examples

```
#configure terminal
(config)#interface eth0
(config-if)#ipv6 ospf link-lsa-suppression enable
```

ipv6 ospf mtu

Use this command to set MTU size for OSPFv3 to construct packets based on this value. Whenever OSPFv3 constructs packets, it uses interface MTU size as Maximum IP packet size. This command forces OSPFv3 to use the specified value overriding the actual interface MTU size.

Use the `no` parameter with this command to return to the default value.

Command syntax

```
ipv6 ospf mtu <1280-65535> instance-id (<0-31>|<64-95>)  
no ipv6 ospf mtu instance-id (<0-31>|<64-95>)
```

Parameters

<1280-65535>	Interface MTU value from OSPFv3's perspective.
<0-31>	Interface instance ID for IPv6 unicast
<64-95>	Interface instance ID for IPv4 unicast.

Default

By default, OSPFv3 uses interface MTU derived from the kernel and Instance ID as 0 if not configured.

Command Mode

Interface mode

Applicability

This command was introduced in OcNOS version 4.0.

Examples

```
#configure terminal  
Enter configuration commands, one per line. End with CNTL/Z.  
(config)#interface eth1  
(config-if)#ipv6 ospf mtu 1287 instance-id 10
```

ipv6 ospf mtu-ignore

Use this command to configure OSPF so that it does not check the MTU size during DD (Database Description) exchange.

Use the `no` form of this command to make OSPF check the MTU size during DD exchange.

Command syntax

```
ipv6 ospf mtu-ignore
ipv6 ospf mtu-ignore instance-id (<0-31>|<64-95>)
no ipv6 ospf mtu-ignore
no ipv6 ospf mtu-ignore instance-id (<0-31>|<64-95>)
```

Parameters

<0-31>	Interface instance ID for IPv6 unicast
<64-95>	Interface instance ID for IPv4 unicast.

Default

By default, during the DD exchange process, OSPF checks the MTU size described in DD packets received from its neighbor. If the MTU size does not match the interface MTU, the neighbor adjacency is not established. Using this command makes OSPF ignore this check and allows establishing of adjacency regardless of MTU size in the DD packet.

Command Mode

Interface mode

Applicability

This command was introduced before OcnOS version 1.3.

Examples

```
#configure terminal
Enter configuration commands, one per line.  End with CNTL/Z.
(config)#interface eth1
(config-if)#ipv6 ospf mtu-ignore
```

ipv6 ospf neighbor

Use this command to connect OSPFv3 routers to non-broadcast multi-access (NBMA) networks.

One neighbor entry must be included for each known NBMA neighbor. The neighbor address must be a link-local address.

Note: For point-to-multipoint interfaces, the `cost` parameter is the only applicable option.

Use the `no` parameter with this command to remove a configuration.

Command Syntax

```
ipv6 ospf neighbor X:X::X:X (instance-id (<0-31>|<64-95>)|)
ipv6 ospf neighbor X:X::X:X {cost <1-65535>} (instance-id (<0-31>|<64-95>)|)
ipv6 ospf neighbor X:X::X:X {poll-interval <0-4294967295>|priority <0-255>}
(instance-id (<0-31>|<64-95>)|)
no ipv6 ospf neighbor X:X::X:X ({cost|poll-interval|priority}|) (instance-id (<0-
31>|<64-95>)|)
```

Parameters

<code>X:X::X:X</code>	Specify a neighbor IP address.
<code>instance-id</code>	Specify the instance.
<code><0-255></code>	Specify the instance ID.
<code>cost</code>	Cost of the interface. This parameter does not apply to NBMA networks.
<code><1-65535></code>	Cost of the interface.
<code>poll-interval</code>	Dead neighbor polling interval.
<code><0-4294967295></code>	Dead neighbor polling interval in seconds. It is recommended to set this value much higher than the hello interval.
<code>priority</code>	Specify a priority. This parameter does not apply to point-to-multipoint interfaces.
<code><0-31></code>	Interface instance ID for IPv6 unicast
<code><64-95></code>	Interface instance ID for IPv4 unicast.

Default

Default cost is 10.

Default poll interval is 120 seconds.

Command Mode

Interface mode

Applicability

This command was introduced before OcnOS version 1.3.

Examples

```
#configure terminal
```

```
(config)#interface eth0  
(config-if)#ipv6 ospf neighbor 2000:500::1 cost 2 instance-id 3
```

ipv6 ospf network

Use this command to set an OSPFv3 network type.

Use the `no` option with this command to return to the default value.

Command Syntax

```
ipv6 ospf network (broadcast|non-broadcast|point-to-multipoint (non-  
broadcast|)|point-to-point) (instance-id (<0-31>|<64-95>)|)  
no ipv6 ospf network (instance-id (<0-31>|<64-95>)|)
```

Parameters

<code>broadcast</code>	Sets the network type to broadcast.
<code>non-broadcast</code>	Sets the network type to NBMA.
<code>point-to-multipoint</code>	Sets the network type to point-to-multipoint.
<code>non-broadcast</code>	Sets the network type to NBMA.
<code>point-to-point</code>	Sets the network type to point-to-point.
<code>instance-id</code>	Specify the instance.
<code><0-31></code>	Interface instance ID for IPv6 unicast
<code><64-95></code>	Interface instance ID for IPv4 unicast.

Default

By default, `ipv6 ospf network` is broadcast type

Command Mode

Interface mode

Applicability

This command was introduced before OcNOS version 1.3.

Examples

The following example shows how to set the network to point-to-point type on the eth0 interface.

```
#configure terminal  
(config)#interface eth0  
(config-if)#ipv6 ospf network point-to-point
```

ipv6 ospf priority

Use this command to set the router priority for determining the designated router (DR) for the network.

A router with the higher router priority becomes the DR. If the priority is the same for two routers, the router with the higher router ID takes precedence.

Only routers with a nonzero priority value are eligible to become the designated or backup designated router. Configure router priority for broadcast or NBMA networks only and not for point-to-point networks.

Use the `no` parameter with this command to reset the value to default.

Command Syntax

```
ipv6 ospf priority <0-255>
ipv6 ospf priority <0-255> instance-id (<0-31>|<64-95>)
no ipv6 ospf priority instance-id (<0-31>|<64-95>)
```

Parameters

<code>priority</code>	Specify the router priority of the interface.
<code><0-255></code>	Specify the router priority of the interface. The default is 1.
<code>instance-id</code>	Specify the instance.
<code><0-31></code>	Interface instance ID for IPv6 unicast
<code><64-95></code>	Interface instance ID for IPv4 unicast.

Default

By default, priority is 1

Applicability

This command was introduced before OcnOS version 1.3.

Examples

```
#configure terminal
(config)#interface eth0
(config-if)#ipv6 ospf priority 127
```

ipv6 ospf retransmit-interval

Use this command to set the interval between retransmission of Link State Update packets. This interval is also used to retransmit DD packets and Link State Request packets.

After sending an LSA to a neighbor, the router keeps the LSA on the LS-retransmission list until it receives an acknowledgement. If the router does not receive an acknowledgment from the neighbor during the retransmit interval, it sends the LSA to the neighbor again.

Use the `no` parameter with this command to reset the interval to the default value.

Command Syntax

```
ipv6 ospf retransmit-interval <1-1800>
ipv6 ospf retransmit-interval <1-1800> instance-id (<0-31>|<64-95>)
no ipv6 ospf retransmit-interval
no ipv6 ospf retransmit-interval instance-id (<0-31>|<64-95>)
```

Parameters

<code>retransmit-interval</code>	Specify the interval.
<code><1-1800></code>	Specify the interval in seconds.
<code>instance-id</code>	Specify the instance.
<code><0-31></code>	Interface instance ID for IPv6 unicast
<code><64-95></code>	Interface instance ID for IPv4 unicast.

Default

By default, `ipv6 ospf retransmit interval` is 5 seconds

Command Mode

Interface mode

Applicability

This command was introduced before OcNOS version 1.3.

Examples

```
#configure terminal
(config)#interface eth0
(config-if)#ipv6 ospf retransmit-interval 3
```

ipv6 ospf transmit-delay

Use this command to set the estimated time it takes to transmit a Link State Update packet over the interface. The transmit-delay value is added to the LS age of LSAs and is advertised through this interface whenever the LSAs are transmitted.

Use the `no` parameter with this command to reset the delay to the default value.

Command Syntax

```
ipv6 ospf transmit-delay <1-1800>
ipv6 ospf transmit-delay <1-1800> instance-id (<0-31>|<64-95>)
no ipv6 ospf transmit-delay
no ipv6 ospf transmit-delay instance-id (<0-31>|<64-95>)
```

Parameters

<code>transmit-delay</code>	Specify the time to transmit a link-state update.
<code><1-1800></code>	Specify the time in seconds to transmit a link-state update.
<code>instance-id</code>	Specify the instance.
<code><0-31></code>	Interface instance ID for IPv6 unicast
<code><64-95></code>	Interface instance ID for IPv4 unicast.

Default

By default, transmit delay is 1 second

Command Mode

Interface mode

Applicability

This command was introduced before OcnOS version 1.3.

Examples

```
#configure terminal
(config)#interface eth0
(config-if)#ipv6 ospf transmit-delay 2
```

ipv6 router ospf

Use this command to enable OSPFv3 routing on an interface.

Specify the process ID to configure multiple instances of OSPFv3. When running a single instance of OSPFv3, you do not need to specify an instance ID.

When OSPFv3 receives a packet, it checks if the instance ID in the packet matches the instance ID of the receiving interface.

Use the `no` parameter with this command to disable OSPFv3 routing on an interface.

Command Syntax

```
ipv6 router ospf area (A.B.C.D|<0-4294967295>)
ipv6 router ospf area (A.B.C.D|<0-4294967295>) instance-id (<0-31>|<64-95>)
ipv6 router ospf area (A.B.C.D|<0-4294967295>) tag WORD
ipv6 router ospf area (A.B.C.D|<0-4294967295>) tag WORD instance-id (<0-31>|<64-95>)
ipv6 router ospf tag WORD area (A.B.C.D|<0-4294967295>)
ipv6 router ospf tag WORD area (A.B.C.D|<0-4294967295>) instance-id (<0-31>|<64-95>)
no ipv6 router ospf area (A.B.C.D|<0-4294967295>)
no ipv6 router ospf area (A.B.C.D|<0-4294967295>) instance-id (<0-31>|<64-95>)
no ipv6 router ospf area (A.B.C.D|<0-4294967295>) tag WORD
no ipv6 router ospf area (A.B.C.D|<0-4294967295>) tag WORD instance-id (<0-31>|<64-95>)
no ipv6 router ospf tag WORD area (A.B.C.D|<0-4294967295>)
no ipv6 router ospf tag WORD area (A.B.C.D|<0-4294967295>) instance-id (<0-31>|<64-95>)
```

Parameters

<code>area</code>	OSPF Area ID in IPv4 address format.
<code>A.B.C.D</code>	OSPF area ID in IP address format.
<code><0-4294967295></code>	OSPF area ID as a decimal value.
<code>instance-id</code>	Specify the instance.
<code><0-31></code>	Interface instance ID for IPv6 unicast
<code><64-95></code>	Interface instance ID for IPv4 unicast.
<code>tag</code>	Tag value to use as a “match” value for controlling redistribution via route maps.
<code>WORD</code>	Set the tag value.

Default

By default, `ipv6 router ospf` is disabled

Command Mode

Interface mode

Applicability

This command was introduced before OcnOS version 1.3.

Examples

```
#configure terminal
(config)#interface eth0
(config-if)#ipv6 router ospf area 1 tag Tag1 instance-id 1
```

ipv6 te-metric

Use this command to set the traffic engineering metric for an interface.

The traffic engineering metric is used in OSPF-TE Link State Advertisements. If the traffic engineering metric is not set, the [ipv6 ospf cost](#) value for an interface is used in OSPF-TE Link State Advertisements.

Use the `no` parameter with this command to unset the traffic engineering metric for this interface.

Command Syntax

```
ipv6 te-metric <1-65535>
ipv6 te-metric <1-65535> instance-id (<0-31>|<64-95>)
no ipv6 te-metric
no ipv6 te-metric instance-id (<0-31>|<64-95>)
```

Parameters

<code>te-metric</code>	Specify the TE metric.
<code><1-65535></code>	Specify the TE metric value.
<code>instance-id</code>	Specify the instance.
<code><0-31></code>	Interface instance ID for IPv6 unicast
<code><64-95></code>	Interface instance ID for IPv4 unicast.

Default

By default, traffic engineering metric value is 0

Command Mode

Interface mode

Applicability

This command was introduced before OcNOS version 1.3.

Examples

```
#configure terminal
(config)#interface eth0
(config-if)#ipv6 te-metric 6
```

log-adjacency-changes

Use this command for the router to send a SYSLOG message when an OSPF neighbor goes up or down.

Use `no` parameter of this command to stop sending SYSLOG message.

Command Syntax

```
log-adjacency-changes (brief|detail|)
no log-adjacency-changes
```

Parameters

<code>detail</code>	Sends a SYSLOG message for each state change, not just when a neighbor goes up or down.
---------------------	---

Default

None

Command Mode

Router mode

Applicability

This command was introduced before OcnOS version 1.3.

Example

```
#configure terminal
(config)#router ipv6 ospf
(config-router)#log-adjacency-changes brief
(config-router)#log-adjacency-changes detail

#configure terminal
(config)#router ipv6 ospf
(config-router)#no log-adjacency-changes
```

max-concurrent-dd

Use this command to limit the number of Database Descriptors (DD) that can be processed concurrently.

This command is useful when a router's performance is affected from simultaneously bringing up several OSPFv3 adjacencies. This command limits the maximum number of DD exchanges that can occur concurrently per OSPFv3 instance, thus allowing for all of the adjacencies to come up.

Use the `no` option with this command to remove the limit.

Command Syntax

```
max-concurrent-dd <1-65535>
no max-concurrent-dd
```

Parameters

<1-65535> Specify the number of DD processes.

Default

By default, number of maximum concurrent DD processes is 5

Command Mode

Router mode

Applicability

This command was introduced before OcnOS version 1.3.

Examples

The following example set the `max-concurrent-dd` value to 4.

```
#configure terminal
(config)#router ipv6 ospf
(config-router)#max-concurrent-dd 4
```

passive-interface

Use this command to suppress sending Hello packets on all interfaces, or on a specified interface.

This command configures OSPFv3 on simplex Ethernet interfaces. Since a simplex interface represents only one network segment between two devices, configure the transmitting interface as a passive interface. This ensures that OSPFv3 does not send hello packets for the transmitting interface. Both the devices can see each other via the hello packet generated for the receiving interface.

Use the `no` form with this command to resume sending `hello` packets on all interfaces, or on a specified interface.

Command Syntax

```
passive-interface
passive-interface IFNAME (disable|enable)
no passive-interface
no passive-interface IFNAME
```

Parameters

IFNAME Specify an interface name

Default

By default, passive interface is disabled

Command Mode

Router mode

Applicability

This command was introduced before OcnOS version 1.3.

Examples

```
#configure terminal
(config)#router ipv6 ospf
(config-router)#passive-interface
(config-router)#passive-interface eth0 disable
```

redistribute

Use this command to import routes from other routing protocols, or from another OSPF instance, into OSPFv3 AS-external-LSAs.

OSPFv3 advertises routes learned from other routing protocols or from other OSPF instances, including static or connected routes. Each injected prefix is put into the AS-external-LSA with a specified metric and metric-type.

Use the `no` parameter with this command to stop redistribution.

Command Syntax

```
redistribute (kernel|connected|static|rip|bgp|isis|ospf (WORD|<1-65535>|)) {metric
  <0-16777214>|metric-type (1|2)|route-map WORD|tag <0-4294967295>}
no redistribute (kernel|connected|static|rip|bgp|isis|ospf (WORD|)) (metric|metric-
  type|route-map|tag|)
```

Parameters

<code>kernel</code>	Specify kernel routes.
<code>connected</code>	Specify connected routes.
<code>static</code>	Specify static routes.
<code>rip</code>	Specify RIP routes.
<code>bgp</code>	Specify BGP routes.
<code>isis</code>	Specify IS-IS routes.
<code>ospf</code>	Specify OSPF routes.
<code>WORD</code>	Specify an OSPFv3 Process Tag. If not specified, redistribute OSPF process with tag "null".
<code><1-65535></code>	Specify an OSPF process identifier. If not specified, redistribute OSPF instance with process ID 0.
<code>metric</code>	Specify the external metric.
<code><0-16777214></code>	Specify the external metric.
<code>metric-type</code>	Specify the external metric-type (see RFC 3101):
<code>1</code>	Set OSPF External Type 1 metric.
<code>2</code>	Set OSPF External Type 2 metric.
<code>route-map</code>	Specify a route map reference.
<code>WORD</code>	Specify name of the route-map.
<code>tag</code>	Tag value to use as a "match" value for controlling redistribution via route maps
<code><0-4294967295></code>	Specify the route tag.

Default

By default, `redistribute` is disabled

Command Mode

Router mode

Applicability

This command was introduced before OcNOS version 1.3.

Examples

The following example shows redistribution of BGP routes into the OSPFv3 routing table, with the metric as 10.

```
#configure terminal
(config)#router ipv6 ospf
(config-router)#redistribute bgp metric 10 metric-type 1
```

The following example shows redistribution of static IPv4 routes into the OSPFv3 routing table.

```
#configure terminal
(config)#router ipv6 ospf
(config-router)#redistribute static
```

router-id

Use this command to specify a router ID for the OSPFv3 process.

Configure each router with a unique router-id. In an OSPFv3 router process that has active neighbors, a new router-id is used at the next reload or when you start the OSPFv3 manually.

Use the `no` form of this command to force OSPFv3 to stop the routing functionality.

Command Syntax

```
router-id A.B.C.D
no router-id
```

Parameters

A.B.C.D Specify the router ID in IPv4 address format.

Default

By default, router id is loop-back IP address of IP address with highest IP

Command Mode

Router mode

Applicability

This command was introduced before OcnOS version 1.3.

Examples

The following example shows a fixed router ID 43.3.3.3

```
#configure terminal
(config)#router ipv6 ospf
(config-router)#router-id 43.3.3.3
```

router ipv6 ospf

Use this command to initiate OSPFv3 routing process and enter Router mode to configure OSPFv3 routing process. For making the OSPFv3 routing process functional, you must specify OSPFv3 process tag in router mode and enable OSPFv3 on at least one interface. OSPFv3 is only enabled on interfaces where OSPFv3 process tag matches the tag specified using `ipv6 router ospf area` command in Interface mode.

Use the `no` parameter with this command to remove OSPFv3 process.

Command Syntax

```
router ipv6 ospf
router ipv6 ospf WORD
router ipv6 vrf ospf WORD
no router ipv6 ospf
no router ipv6 ospf WORD
no router ipv6 vrf ospf WORD
```

Parameters

<code>WORD</code>	Tag value to use as a “match” value for controlling redistribution via route maps.
<code>vrf</code>	Enable an IPv6 VRF routing process

Default

No default value is specified

Command Mode

Configure mode

Applicability

This command was introduced before OcNOS version 1.3.

Examples

```
#configure terminal
(config)#router ipv6 ospf Tag1
(config-router)#
```

show debugging ipv6 ospf

Use this command to display the OSPFv3 debugging options.

Command Syntax

```
show debugging ipv6 ospf
```

Parameters

None

Command Mode

Exec mode and Privileged Exec mode

Applicability

This command was introduced before OcNOS version 1.3.

Examples

```
#show debugging ipv6 ospf
```

```
OSPFv3 debugging status:  
  OSPFv3 all packet debugging is on  
  OSPFv3 all NFSM debugging is on  
#
```

show ipv6 ospf

Use this command to display global and area information about OSPFv3.

Command Syntax

```
show ipv6 ospf (WORD|)
```

Parameters

WORD Tag value to use as a “match” value for controlling redistribution via route maps.

Command Mode

Privileged Exec mode and Exec Mode

Applicability

This command was introduced before OcnOS version 1.3.

Example

```
OcNOS#show ipv6 ospf
Routing Process "OSPFv3 (null)" with ID 1.2.3.4
Process uptime is 18 hours 12 minutes
SPF schedule delay initial 0.500 secs
SPF schedule delay min 0.500 secs
SPF schedule delay max 50.0 secs
Minimum LSA interval 5 secs, Minimum LSA arrival 1 secs
Number of incoming current DD exchange neighbors 0/5
Number of outgoing current DD exchange neighbors 0/5
Number of external LSA 0. Checksum Sum 0x0000
Number of LSA originated 6
Number of LSA received 142
Number of areas in this router is 1
  Area BACKBONE(0)
    Number of interfaces in this area is 2(2)
    SPF algorithm executed 12 times
    Number of LSA 6. Checksum Sum 0x317BC
    Number of Unknown LSA 0
Dste Staus: Disabled
```

[Table 3-52](#) explains the fields for each ospf entry.

Table 3-52: show ipv6 ospf output details

Field	Description
Routing Process with ID	OSPFv3 process identifier and router identifier.
Process uptime is	OSPFv3 process is running time.
SPF schedule delay initial	Initial SPF schedule delay.
SPF schedule delay min	Minimum delay between receiving a change to SPF calculation.

Table 3-52: show ipv6 ospf output details

Field	Description
SPF schedule delay max	Maximum delay between receiving a change to SPF calculation.
Minimum LSA interval	Minimum LSA refresh interval.
Minimum LSA arrival	Minimum time between reception of new LSAs during flooding.
Number of incoming current DD exchange neighbors	Incoming neighbor Database Descriptors and maximum concurrent DDs. Shows the count of DD that is getting received at the moment of executing the show CLI and the maximum concurrent DDs configured.
Number of outgoing current DD exchange neighbors	Outgoing neighbor Database Descriptors and maximum concurrent DDs. Shows the count of DD that is getting sent at the moment of executing the show CLI and the maximum concurrent DDs configured.
Number of external LSA	Number of AS external LSAs and checksum.
Number of opaque AS LSA	Number of AS opaque LSAs and checksum.
Number of LSA originated	LSAs originated by the OSPFv3 instance.
Number of LSA received	LSAs received by the OSPFv3 instance.
Number of areas in this router is	Number of areas attached to this router.
Area	Area identifier.
(BACKBONE)	Area is a backbone.
no-summary	Area is a stub and does no import summaries.
(Inactive)	Area is not active.
Number of interfaces in this area is	Number of interfaces in this area.
Dste Status	Whether DSTE is enabled or disabled.

show ipv6 ospf database

Use this command to display information in the OSPFv3 Link State database.

Command Syntax

```
show ipv6 ospf database
show ipv6 ospf database (self-originate|max-age|adv-router A.B.C.D|)
show ipv6 ospf database (router|network|inter-prefix|inter-router|external|nssa-external|link|intra-prefix|te|grace)
show ipv6 ospf database (router|network|inter-prefix|inter-router|external|nssa-external|link|intra-prefix|te|grace) (self-originate|adv-router A.B.C.D|)
show ipv6 ospf database (router|network|inter-prefix|inter-router|external|nssa-external|link|intra-prefix|te|grace) A.B.C.D (self-originate|adv-router A.B.C.D|)
show ipv6 ospf WORD database
show ipv6 ospf WORD database (router|network|inter-prefix|inter-router|external|nssa-external|link|intra-prefix|te|grace)
show ipv6 ospf WORD database (router|network|inter-prefix|inter-router|external|nssa-external|link|intra-prefix|te|grace) adv-router A.B.C.D
```

Parameters

self-originate	Self-originated link states
max-age	LSAs in MaxAge list
adv-router	Advertising router for Type 8 Link LSAs (Link State Advertisements):
A.B.C.D	Router ID of the advertising router.
router	Router LSAs.
network	Network LSAs.
inter-prefix	Inter-Area-Prefix LSAs.
inter-router	Inter-Area-Router LSAs.
external	AS external LSAs.
nssa-external	NSSA LSAs.
link	Link LSAs.
intra-prefix	Intra-Area-Prefix LSAs (Type 9) with prefixes for stub and transit networks
te	Intra-area TE LSAs.
grace	Grace LSAs.
A.B.C.D	Link state ID as an IP address.
WORD	Tag value to use as a “match” value for controlling redistribution via route maps.

Command Mode

Privileged Exec mode and Exec Mode

Applicability

This command was introduced before OcNOS version 1.3.

Example: adv-router Parameter

This example shows using the `adv-router` parameter:

```
#show ipv6 ospf database link adv-router 10.70.0.58
      OSPFv3 Router with ID (10.70.0.58) (Process 100)
        Link-LSA (Interface eth1)
  LS age: 492
  LS Type: Link-LSA
  Link State ID: 0.0.0.3
  Advertising Router: 10.70.0.58
  LS Seq Number: 0x80000001
  Checksum: 0xC2D6
  Length: 68
  Priority: 1
  Options: 0x000013 (-|R|-|-|E|V6)
  Link-Local Address: fe80::204:75ff:feaa:fedb
  Number of Prefixes: 2
    Prefix: 5f00:1:2:10::/64
    Prefix Options: 0 (-|-|-|-)
```

Header

```
OSPFv3 Router with ID (10.70.0.58) (Process 100)
Link-LSA (Interface eth1)
```

The router ID and OSPFv3 process tag of the local router.

Interface name of the router associated with this Link-LSA.

OSPFv3 Database Fields

[Table 3-53](#) explains the fields for each database entry.

Table 3-53: OSPFv3 database fields

Field	Description
LS age	The length of time in seconds since the LSA was originated.
LS Type	The type of LSA
Link State ID	Interface identifier of the originating router.
Advertising router	The Router ID of the router advertising this LSA. On a transit network, this is always the Designated Router ID.
LS Seq Number	Sequence number of an LSA.
Checksum	LSA header checksum (excluding the LS age field).
Length	The length in bytes of the LSA (including the 20-byte header).
Priority	The router priority of the interface attaching the originating router of the link.

Table 3-53: OSPFv3 database fields

Field	Description
Options	<p>Bits in network LSAs that originate on the link:</p> <p>DC-bit: Whether the router supports OSPF over Demand Circuits. R-bit: Whether the router is active. If this bit is clear, routes which transit the advertising node cannot be computed. N-bit: How the router handles Type 7 LSAs. MC-bit: Whether IP multicast packets are forwarded. E-bit: Whether AS-External-LSAs are flooded. This bit is set in all AS External LSAs and in all LSAs originated in the backbone and non-stub areas. V6-bit: Whether to include the router/link in routing calculations.</p>
Link-Local Address	The originating router's link-local interface address.
Number of Prefixes	<p>The number of IPv6 prefixes associated to the link:</p> <p>Prefix: The global IPv6 prefix associated to this link. Prefix Options: Each prefix is advertised along with an 8-bit capabilities field. They serve as input for routing calculations allowing, for example, some prefixes to be ignored or marked as not re-advertisable.</p>
Referenced LS Type	<p>Identifies the Router-LSA or Network-LSA with which the IPv6 prefixes are associated:</p> <p>Type 0x2001: prefixes associated with Router-LSA Type 0x2002: prefixes associated with Network-LSA</p>
Referenced Link State ID	<p>Referenced LS Type 0x2001: this field is 0 Referenced LS Type 0x2002: the interface ID of the link's Designated Router.</p>
Referenced Advertising Router	<p>Referenced LS Type 0x2001: ID of the originating router. Referenced LS Type 0x2002: ID of the Designated Router</p> <p>Prefix:</p> <p>Referenced LS Type 0x2001: global IPv6 prefix associated with the router Referenced LS Type 0x2002: global IPv6 prefix associated with the transit link</p> <p>Prefix Options: Bits in network LSAs that originate on the link: DC: How the router handles demand circuits R: Whether the router is active. If this bit is clear, routes which transit the advertising node cannot be computed. N: How the router handles Type 7 LSAs MC: Whether IP multicast packets are forwarded E: Whether AS-External-LSAs are flooded V6: Whether to include the router/link in routing calculations</p> <p>Metric: The cost of this prefix.</p>

Example: intra-prefix and adv-router Parameters

This example shows using the `adv-router` and `intra-prefix` parameters.

Note: The same information for OSPFv2 can be viewed in type 1 router LSAs and type 2 network LSAs. However, in OSPFv3 all addressing information has been removed from router LSAs and network LSAs, leading to the introduction of the Intra-Area-Prefix LSA. In a transit network, the Intra-Area-Prefix-LSA serves the same purpose as a network LSA and on a point-to-point or point-to-multipoint network serves the same purpose as a router LSA.

```
#show ipv6 ospf database intra-prefix adv-router 10.70.0.58
    OSPFv3 Router with ID (10.70.0.58) (Process 100)
```

Intra-Area-Prefix-LSA (Area 0.0.0.0)

LS age: 1435
LS Type: Intra-Area-Prefix-LSA
Link State ID: 0.0.0.2
Advertising Router: 10.70.0.58
LS Seq Number: 0x80000001
Checksum: 0x1B4E
Length: 56
Number of Prefixes: 2
Referenced LS Type: 0x2002
Referenced Link State ID: 0.0.0.3
Referenced Advertising Router: 10.70.0.58
Prefix: 5f00:1:2:10::/64
Prefix Options: 0 (-|-|-|-)
Metric: 0
Prefix: 6f00:1:2:10::/64
Prefix Options: 0 (-|-|-|-)
Metric: 0

Header

OSPFv3 Router with ID (10.70.0.58) (Process 100)
Intra-Area-Prefix-LSA (Area 0.0.0.0)

- The router ID and OSPFv3 process tag for the router.
- Intra-Area-Prefix-LSA has area flooding scope. This LSA belongs to Area 0.0.0.0.

show ipv6 ospf interface

Use this command to display OSPFv3 interface information.

Command Syntax

```
show ipv6 ospf interface
show ipv6 ospf interface IFNAME
```

Parameters

IFNAME The name of the interface.

Command Mode

Privileged Exec mode and Exec mode

Applicability

This command was introduced before OcNOS version 1.3.

Usage

This is a sample output from the `show ipv6 ospf interface` command displaying the OSPFv3 interface information:

```
#show ipv6 ospf interface
eth0 is up, line protocol is up
  Interface ID 3, Instance ID 0, Area 0.0.0.0
  IPv6 Link-Local Address fe80::248:54ff:fec0:f32d/10
  Router ID 1.2.3.4, Network Type BROADCAST, Cost: 10
  Transmit Delay is 1 sec, State Backup, Priority 1
  Designated Router (ID) 5.6.7.8
  Interface Address fe80::203:47ff:fe4c:776e
  Backup Designated Router (ID) 1.2.3.4
  Interface Address fe80::248:54ff:fec0:f32d
  Timer interval configured, Hello 10, Dead 40, Wait 40, Retransmit 5
  Hello due in 00:00:01
  Neighbor Count is 1, Adjacent neighbor count is 1
```

If Hello Suppression is enabled

```
RTR_B#show ipv6 ospf interface
eth1 is up, line protocol is up
  Interface ID 3
  IPv6 Prefixes
    fe80::5054:ff:fef3:f166/64 (Link-Local Address)
    2001::2/64
  OSPFv3 Process (1), Area 0.0.0.0, Instance ID 66
  Router ID 2.2.2.2, Network Type P2MP-NBMA, Cost: 1, TE Metric: 1
  Reduce LSA Flooding
  Transmit Delay is 1 sec, State Point-To-Point, Priority 1
  Timer interval configured, Hello 30, Dead 120, Wait 120, Retransmit 5
  Hello due in 00:00:32
  Neighbor Count is 1, Adjacent neighbor count is 1
  Suppress hello for 1 neighbor(s)
```

```

Hello received 2 sent 3, DD received 4 sent 6
LS-Req received 1 sent 1, LS-Upd received 7 sent 4
LS-Ack received 0 sent 3, Discarded 0
    
```

Table 3-54 explains the fields for each ospf interface entry.

Table 3-54: show ipv6 ospf interface output details

Field	Description
Interface Type and whether it is up or down.	Status of the interface type.
Line protocol	Status of the line protocol.
Interface ID	Interface for which information is displayed.
Instance ID	For running multiple instances of OSPFv3 on the router
Area	Area ID in A.B.C.D form
IPv6 Link-Local Address	link-local address is an IPv6 unicast address – cannot communicate to link-local addresses that are outside the directly connected network. In IPv6 (X:X::X:X/M) form.
Router ID	As stated – In A.B.C.D form.
Network Type	One of the following: 1. Ethernet is Broadcast 2. Serial p2p non-broadcast 3. NBMA – Non-Broadcast MultiAccess (NBMA) media
cost	The cost of sending packets over this interface – range is 1 to 65535.
Transmit Delay	The delay, in seconds, between link-state transmits. This value must be the same for all nodes on the network. The range is 1 to 65535. The default is 1.
Priority	OSPFv3 router priority for the interface. The range is 0 to 255. A router with priority 0 can never become the designated router, the default is 1.
Designated Router (ID)	The ID number of the Designated Router (DR).
Interface Address	The IPV6 address of this device.
Backup Designated Router	The ID number or the Backup Designated Router (BDR).
Interface Address	The IPv6 address of the Backup Designated Router.
Timer interval configured	The timer values of the following instances: Hello, Dead, Wait, Retransmit.
Hello due in	The countdown for receiving the next Hello packet.
Neighbor Count is	Number of neighbor count.
Adjacent neighbor count is	Number of adjacent neighbor count.

show ipv6 ospf neighbor

Use this command to display information about an OSPFv3 neighbor.

Command Syntax

```
show ipv6 ospf neighbor
show ipv6 ospf WORD neighbor
show ipv6 ospf neighbor INTERFACE
show ipv6 ospf WORD neighbor INTERFACE
show ipv6 ospf neighbor INTERFACE detail
show ipv6 ospf WORD neighbor INTERFACE detail
show ipv6 ospf neighbor detail
show ipv6 ospf WORD neighbor detail
show ipv6 ospf neighbor A.B.C.D
show ipv6 ospf WORD neighbor A.B.C.D
```

Parameters

WORD	Tag value to use as a “match” value for controlling redistribution via route maps.
INTERFACE	Display the name of the Interface
A.B.C.D	Neighbor IP address.
detail	Details of neighbors

Command Mode

Privileged Exec mode and Exec Mode

Applicability

This command was introduced before OcnOS version 1.3.

Example

This is a sample output from the show ipv6 ospf neighbor command displaying information about the OSPFv3 neighbor.

```
#show ipv6 ospf neighbor
OSPFv3 Process (*null*)
Neighbor ID Pri State Dead Time Interface Instance ID
5.6.7.8 1 Full/DR 00:00:38 eth0 0
```

If Hello Suppression is enabled

```
RTR_B#
RTR_B#show ipv6 ospf neighbor
OSPFv3 Process (1)
Neighbor ID      Pri   State           Dead Time   Interface   Instance ID
1.1.1.1          1    Full/ -        inactive   eth1        0
4.4.4.4          1    Full/DR        00:00:40   eth2        0
4.4.4.4          1    Full/ -        inactive   VLINK1     0
```

```
RTR_B#
RTR_B#
RTR_B#show ipv6 ospf neighbor detail
Neighbor 1.1.1.1, interface address fe80::5054:ff:feb3:d3bc
  In the area 0.0.0.0 via interface eth1
  Neighbor priority is 1, State is Full, 7 state changes
  Hello is suppressed
  DR is 0.0.0.0 BDR is 0.0.0.0
  Options is 0x000133 (AF|*|*|DC|R|-|-|E|V6)
  Dead timer due in inactive
  Database Summary List 0
  Link State Request List 0
```

Table 3-55 explains the fields for each ospf neighbor entry.

Table 3-55: show ipv6 ospf neighbor output details

Field	Description
Neighbor	Router ID of the neighbor router.
interface address	IPv6 address of the neighbor's interface.
In the area	The neighbor router's area ID.
via interface	Neighbor router's interface name.
Neighbor Priority is	OSPFv3 router priority for the interface. The range is 0 to 255. A router with priority 0 can never become the designated router, the default is 1.
State	The Link State Address (LSA) of the neighbor, and there has been 7 state changes, and sending Hello packets is suppressed.
DR	Designated Router (DR) ID
BDR	Backup Designated Router (BDR) ID
Options is	<p>The hexadecimal representation of the seven bits in the Options Field of Hello packets (see RFC 5340):</p> <ul style="list-style-type: none"> • AF-bit – Address Family bit. • V6-bit – If this bit is clear, the router/link should be excluded from IPv6 routing calculations. • E-bit – This bit describes the way AS-external-LSAs are flooded. • N-bit – This bit indicates whether or not the router is attached to an NSSA. • R-bit – This bit (the 'Router' bit) indicates whether the originator is an active router. If the router bit is clear, then routes that transit the advertising node cannot be computed. Clearing the router bit is appropriate for a multi-homed host that wants to participate in routing, but does not want to forward non-locally addressed packets. • DC-bit – This bit describes the router's handling of demand circuits, as specified in [DEMAND]. • *-bit – These bits are reserved for migration of OSPFv2 protocol extensions.

Table 3-55: show ipv6 ospf neighbor output details (Continued)

Field	Description
Dead timer due in	The countdown timer for marking neighbor connections dead. In this example, the Dead Timer has been deactivated.
Database Summary List	Describes routes to IPv6 address prefixes that belong to other areas.
Link State Request List	Sent or received when Link-State Request packets finds that parts of the Link State Database are out of date.
Timer interval configured	The set values for the following packet types: Hello, Dead, Wait, Retransmit.
Neighbor Count	The number of known neighbors.
Adjacent neighbor count	The number of directly adjacent neighbors.

show ipv6 ospf route

Use this command to display the IPv6 routing table for OSPFv3.

The routes can be displayed in two ways:

- Each routing entry in a single-line
- Each routing entry in multiple lines

By default, the routing table is displayed in the multi-line format. For a single line display, give the [ipv6 ospf display route single-line](#) command.

Command Syntax

```
show ipv6 ospf route
show ipv6 ospf WORD route
```

Parameters

WORD Tag value to use as a “match” value for controlling redistribution via route maps.

Command Mode

Privileged Exec mode and Exec mode

Applicability

This command was introduced before OcnOS version 1.3.

Example

The following is sample output in single-line format:

```
#show ipv6 ospf route
Destination Metric Next-hop
3ffe:1:1::/48 10 directly connected, eth0
3ffe:2:1::/48 10 directly connected, eth0
3ffe:2:2::/48 10 directly connected, eth0
3ffe:3:1::/48 10 directly connected, eth0
3ffe:3:2::/48 10 directly connected, eth0
3ffe:3:3::/48 10 directly connected, eth0
E2 3ffe:100:1::1/128 10/20 via fe80::203:47ff:fe4c:776e, eth0
E2 3ffe:100:2::1/128 10/20 via fe80::203:47ff:fe4c:776e, eth0
E2 3ffe:100:3::1/128 10/20 via fe80::203:47ff:fe4c:776e, eth0
IA 3ffe:101:1::/48 20 via fe80::203:47ff:fe4c:776e, eth0
IA 3ffe:101:2::/48 20 via fe80::203:47ff:fe4c:776e, eth0
IA 3ffe:101:3::/48 20 via fe80::203:47ff:fe4c:776e, eth0
```

The following is sample output in multi-line format:

```
#show ipv6 ospf route
Destination Metric
Next-hop Interface
3ffe:1:1::/48 10
-- eth0
3ffe:2:1::/48 10
-- eth0
3ffe:2:2::/48 10
```



```

-- eth0
3ffe:3:1::/48 10
-- eth0
3ffe:3:2::/48 10
-- eth0
3ffe:3:3::/48 10
-- eth0
E2 3ffe:100:1::1/128 10/20
fe80::203:47ff:fe4c:776e eth0

```

Table 3-56 explains the fields for each ospf route entry.

Table 3-56: show ipv6 ospf route output details

Field	Description
IP address	IP address of the remote network.
Metric	For OSPF the metric is cost, which indicates the best quality path to use to forward packets.
Next hop router IP address	This route is available through the next hop router located at this IP address. This identifies exactly where packets go when they match this route.
Outgoing interface name	Interface used to get to the next-hop address for this route.

show ipv6 route fast-reroute

Use this command to display loop-free alternate routes with alternate next hops.

Command Syntax

```
show ipv6 route fast-reroute
```

Parameters

None

Command Mode

Privileged Exec mode

Applicability

This command was introduced before OcNOS version 1.3.

Usage

```
#show ipv6 route fast-reroute
```

show ipv6 ospfv3 topology

Use this command to display information about OSPFv3 topology for each area.

Command Syntax

```
show ipv6 ospfv3 topology
show ipv6 ospfv3 WORD topology
show ipv6 ospfv3 topology area (A.B.C.D|<0-4294967295>)
show ipv6 ospfv3 WORD topology area (A.B.C.D|<0-4294967295>)
```

Parameters

WORD	Tag value to use as a “match” value for controlling redistribution via route maps.
area	OSPFv3 area ID
A.B.C.D	OSPFv3 Area ID in IPv4 address format.
<0-4294967295>	OSPFv3 Area ID as a decimal value.

Command Mode

Privileged Exec mode and Exec Mode

Applicability

This command was introduced before OcnOS version 1.3.

Example

```
#show ipv6 ospfv3 topology
OSPFv3 paths to Area (0.0.0.0) routers
Router ID Bits Metric Next-Hop Interface
1.2.3.4 --
5.6.7.8 E 10 5.6.7.8 eth0
```

Example

```
#show ipv6 ospfv3 topology

OSPFv3 paths to Area (0.0.0.0) routers
Router ID      Bits  Metric  Next-Hop      Interface
1.2.3.4
5.6.7.8      E     10     5.6.7.8      eth0
```

[Table 3-57](#) explains the fields for each ospfv3 topology entry.

Table 3-57: show ipv6 ospfv3 topology output details

Field	Description
OSPFv3 path to Area	Area ID in IPv4 format.
Router ID	ID in IPv4 format,

Table 3-57: show ipv6 ospfv3 topology output details

Field	Description
Bits	Bits appended to packets: <ul style="list-style-type: none">• V-bit Indicates whether the advertising router is an endpoint of a virtual link.• E-bit Indicates whether the advertising router is an Autonomous System Border Router (ASBR).• B-bit Indicates whether the advertising router is an Area Border Router (ABR).• W-bit When set, the router is a wild-card multicast receiver.
Metric	The value of ospfv3 metric.
Next-Hop	The next-hop identifier.
Interface	The interface name through which the virtual link extends.

show ipv6 ospf virtual-links

Use this command to display information about OSPFv3 virtual-links.

Command Syntax

```
show ipv6 ospf virtual-links
show ipv6 ospf WORD virtual-links
```

Parameters

WORD Tag value to use as a “match” value for controlling redistribution via route maps.

Command Mode

Privileged Exec mode and Exec Mode

Applicability

This command was introduced before OcnOS version 1.3.

Example

```
#show ipv6 ospf virtual-links
Virtual Link VLINK1 to router 5.6.7.8 is up
Transit area 0.0.0.1 via interface eth0, instance ID 0
Local address 3ffe:1234:1::1/128
Remote address 3ffe:5678:3::1/128
Transmit Delay is 1 sec, State Point-To-Point,
Timer intervals configured, Hello 10, Dead 40, Wait 40, Retransmit 5
Hello due in 00:00:01
Adjacency state Up
```

If Hello Suppression is enabled

```
RTR_B#show ipv6 ospf virtual-links
Virtual Link VLINK1 to router 4.4.4.4 is up
Transit area 0.0.0.1 via interface eth2, instance ID 0
Hello suppression Enabled
DoNotAge LSA allowed
Local address 2002::1/128
Remote address 2002::2/128
Transmit Delay is 1 sec, State Point-To-Point,
Timer intervals configured, Hello 10, Dead 40, Wait 40, Retransmit 5
Hello due in inactive
Adjacency state Full
RTR_B#
RTR_B#
```

[Table 3-58](#) explains the fields for each ospf virtual-links entry.

Table 3-58: show ipv6 ospf virtual-links output details

Field	Description
Virtual Link	Virtual link name, the router ID to which it is connected, and the state of the link.
Transit area	Transit area ID, the interface it uses, and its instance ID – an Instance ID should default to 0. It is only necessary to assign a value other than 0 on those links that will contain multiple separate communities of OSPF routers.
Local address	The local IPV6 address and subnet mask.
Remote address	The remote IPV6 address and subnet mask.
Transmit Delay	The delay, in seconds, between link-state transmits. This value must be the same for all nodes on the network. The range is 1 to 65535. The default is 1. The state is point-to-point.
Timer intervals configured	The configured values in seconds of the following timers: Hello, Dead, Wait, Retransmit.
Hello due in	A countdown timer that indicates when the next Hello packet should arrive.
Adjacency State	Whether the adjacency state is either up or down.

show ipv6 vrf

Use this command to list information about VRFs.

Command Syntax

```
show ipv6 vrf (WORD|)
```

Parameter

WORD VPN Routing/Forwarding instance name.

Command Mode

Exec mode and Privileged Exec mode

Applicability

This command was introduced before OcnOS version 1.3.

Examples

The following is a sample output of the `show ipv6 vrf` command displaying VRF information:

```
#show ipv6 vrf
Name           Interfaces

qa             eth0
you            eth1
myVRF         eth2
```

[Table 3-59](#) explains the fields.

Table 3-59: show ipv6 vrf output details

Field	Description
Name	Name of the interface.
Interfaces	Type of an interface.

shutdown

Use this command to temporarily shut down a protocol in the least disruptive manner and to notify its neighbors that it is going away.

Use the `no` parameter of this command, not to temporarily shut a protocol.

Command Syntax

```
shutdown
no shutdown
```

Parameter

None

Default

None

Command Mode

Router mode

Applicability

This command was introduced before OcNOS version 1.3.

Example

```
#configure terminal
(config)#router ipv6 ospf
(config-router)#shutdown

#configure terminal
(config)#router ipv6 ospf
(config-router)#no shutdown
```

snmp restart ospf6

Use this command restart SNMP in OSPFv3

Command Syntax

```
snmp restart ospf6
```

Parameter

None

Default

By default, SNMP restart is disabled

Command Mode

Configure mode

Applicability

This command was introduced before OcNOS version 1.3.

Examples

```
#snmp restart ospf6
```

summary-address

Use this command to summarize or suppress external routes with the specified address range.

An address range is a pairing of a starting address and a mask that is almost the same as IP network number. For example:

- If the specified IPv6 address range is 2020:100:100:2000::/53, it matches 2020:100:100:2222::/64, 2020:100:100:2666::/64 and so on.
- If the specified IPv4 address range is 192.168.0.0/255.255.240.0, it matches 192.168.1.0/24, 192.168.4.0/22, 192.168.8.128/25 and so on.

Redistributing routes from other protocols into OSPF requires the router to advertise each route individually in an external LSA. Use this command to advertise one summary route for all redistributed routes covered by a specified network address and mask. This minimizes the size of the OSPF link state database.

Use the `no` form this command to remove summary addresses.

Command Syntax

```
summary-address X:X::X:X/M (not-advertise| (all-tag (<0-4294967295> )| )
    (translate-tag (<0-4294967295> ) | )
summary-address A.B.C.D/M (not-advertise|tag <0-4294967295>|)
no summary-address A.B.C.D/M
no summary-address X:X::X:X/M (not-advertise|all-tag|translate-tag)
no summary-address A.B.C.D/M (not-advertise|tag)
```

Parameters

<code>X:X::X:X/M</code>	The range of addresses given as IPv6 starting address and a mask.
<code>A.B.C.D/M</code>	The range of addresses given as IPv4 starting address and a mask.
<code>not-advertise</code>	Suppress routes that match the range.
<code>tag</code>	Tag value to use as a “match” value for controlling redistribution via route maps. <code><0-4294967295></code> Set a tag value. The default is 0.
<code>all-tag</code>	Set tag for all summarized type-5, translated type5 and type-7 LSA.
<code>translate-tag</code>	Set tag only for summarized translated type-5 LSA.

Default

By default, summary-address value is 0

Command Mode

Router mode

Applicability

This command was introduced before OcNOS version 1.3.

Examples

The following example uses the `summary-address` command to aggregate external LSAs that match the network 172.16.0.0/24 and assign a tag value of 3.

```
#configure terminal
(config)#router ipv6 ospf
(config-router)#summary-address 2020:100:100:2000::/53 all-tag 3
```

timers spf exp

Use this command to set the Shortest-Path First (SPF) best-path schedule minimum and maximum delay between receiving a change to SPF calculation in milliseconds.

Use `no` parameter of this command to unset the SPF best-path schedule.

Command Syntax

```
timers spf exp <0-2147483647> <0-2147483647>
no timers spf exp
```

Parameters

<0-2147483647>

The minimum delay in milliseconds between receiving a change to SPF calculation.

<0-2147483647>

The maximum delay in milliseconds between receiving a change to SPF calculation.

Default

Default minimum delay: 500 milliseconds

Default maximum delay: 50000 milliseconds (50 seconds)

Command Mode

Router mode

Applicability

This command was introduced before OcNOS version 1.3.

Example

```
#configure terminal
(config)#router ipv6 ospf
(config-router)#timers spf exp 300 300
```

CHAPTER 4 OSPFv3 Graceful Restart Commands

This chapter describes the OSPFv3 graceful restart commands.

- [capability restart](#)
- [ipv6 ospf restart grace-period](#)
- [ipv6 ospf restart helper](#)
- [ipv6 ospf restart planned-only](#)
- [restart ipv6 ospf graceful](#)

capability restart

Use this command to enable OSPFv3 graceful restart capability. If a router is not restart-enabled, it cannot enter graceful restart mode and act as a helper.

Use the `no` parameter with this command to disable the feature.

Command Syntax

```
capability restart graceful
no capability restart
```

Parameter

None

Default

By default, `capability restart graceful` is enabled

Command Mode

Router mode

Applicability

This command was introduced before OcNOS version 1.3.

Examples

```
#configure terminal
(config)#router ipv6 ospf 100
(config-router)#capability restart graceful

(config)#router ipv6 ospf 100
(config-router)#no capability restart
```

ipv6 ospf restart grace-period

Use this command to enable the graceful restart feature and set the grace period for restarting the router.

If graceful restart is enabled, NSM is notified about the grace period. If the OSPF daemon unexpectedly shuts down, NSM sends this value to the OSPF daemon when it comes up again which uses this value to end the graceful state.

Use the `no` parameter with this command to revert to the default grace period.

Command Syntax

```
ipv6 ospf restart grace-period <2-1800>
no ipv6 ospf restart grace-period
```

Parameters

<2-1800> Grace period in seconds.

Default

By default, grace period is 120 seconds

Command Mode

Configure mode

Applicability

This command was introduced before OcnOS version 1.3.

Examples

```
#configure terminal
(config)#ipv6 ospf restart grace-period 250
```

ipv6 ospf restart helper

Use this command to configure the helper behavior for graceful restart.

Use the `no` parameter with this command to revert to the default.

Command Syntax

```
ipv6 ospf restart helper {max-grace-period <2-1800>}
ipv6 ospf restart helper never (router-id A.B.C.D|)
no ipv6 ospf restart helper
no ipv6 ospf restart helper never
no ipv6 ospf restart helper {max-grace-period|never router-id (A.B.C.D|all)}
```

Parameters

<code><2-1800></code>	Help only if received grace-period is less than this value.
<code>A.B.C.D</code>	Router ID of neighbor to never to act as helper.
<code>never</code>	Prevent the neighbor from entering helper mode.
<code>max-grace-period</code>	Help only if received grace-period is less than this value.
<code>router-id</code>	Router of neighbor to never to act as helper.

Default

By default, router behave as helper. To disable it as helper, `ospf restart helper never` command should be configured. `ospf restart helper max-grace-period` – Max-grace-period to function as helper. If not configured, value will be the grace-period in restarting node.

Command Mode

Configure mode

Applicability

This command was introduced before OcNOS version 1.3.

Examples

```
#configure terminal
(config)#ipv6 ospf restart helper never router-id 1.1.1.1

#configure terminal
(config)#no ipv6 ospf restart helper never
```

ipv6 ospf restart planned-only

Use this command to configure the OSPFv3 GR support for only planned restart.

Use the `no` parameter with this command to revert to the default.

Note: OSPFv3 supports only planned restart. Hence this command configuration and un-configuration does not have any functionality impact

Command Syntax

```
ipv6 ospf restart planned-only
no ipv6 ospf restart planned-only
```

Parameters

None

Default

By default, OSPFv3 supports planned restart only.

Command Mode

Configure mode

Applicability

This command was introduced before OcNOS version 1.3.

Example

```
#configure terminal
(config)#ipv6 ospf restart planned-only

#configure terminal
(config)#no ipv6 ospf restart planned-only
```

restart ipv6 ospf graceful

Use this command to restart OSPFv3 gracefully.

After this command is executed, the router immediately shuts down. NSM is notified that OSPF has shut down gracefully. NSM preserves routes installed by OSPF until the grace period expires.

Command Syntax

```
restart ipv6 ospf graceful (grace-period <1-1800>|)
```

Parameters

<1-1800> Grace period in seconds.

Default

By default, restart ipv6 ospf graceful is disabled. Default value of grace-period is 120 seconds.

Command Mode

Privileged Exec mode and Exec mode

Applicability

This command was introduced before OcNOS version 1.3.

Examples

```
#restart ipv6 ospf graceful grace-period 200
```

CHAPTER 5 OSPF VPN Commands

This chapter provides an alphabetized reference of the OSPF VPN commands. It includes the following commands:

- [capability vrf-lite](#)
- [router ospf vrf](#)
- [domain-id](#)

capability vrf-lite

Use this command to enable the `vrf-lite` capability for an OSPF instance.

Use the `no` parameter with this command to disable the same for an OSPF instance.

Command Syntax

```
capability vrf-lite
no capability vrf-lite
```

Parameters

None

Default

By default, VRF lite capability for an OSPF instance is disabled.

Command Mode

Router mode

Applicability

This command was introduced before OcNOS version 1.3.

Example

```
#configure terminal
(config)#router ospf 100
(config-router)#capability vrf-lite
(config)#router ospf 100
(config-router)#no capability vrf-lite
```

router ospf vrf

Use this command to specify a VRF instance in OSPF. To use this command, you must first create a VRF Name in the NSM using the `ip vrf` command. Associate the same name with the OSPF instance using this command.

Command Syntax

```
router ospf <1-65535> WORD
```

Parameters

<1-65535>	Routing process ID; should be unique for each routing process.
WORD	Name of the VRF to associate with this OSPF instance.

Default

By default, `router ospf vrf` is disabled

Command Mode

Configure mode

Applicability

This command was introduced before OcnOS version 1.3.

Examples

```
#configure terminal
(config)#router ospf 100 myVRF
(config-router)#
```

domain-id

Use this command to specify the domain ID for a OSPF bound to VRF.

The routes sent from OSPF to the VPN cloud are sent along with the domain ID. In this way, the domain ID acts as an identification for the route received from each OSPF domain.

Use the `no` form of this command to remove a domain ID.

Command Syntax

```
domain-id ((A.B.C.D (secondary|)) | (type (type-as|type-as4|type-back-comp) value
HEX_DATA (secondary|)))
no domain-id ((A.B.C.D (secondary|)) | (type (type-as|type-as4|type-back-comp)
value HEX_DATA (secondary|)))
```

Parameters

A.B.C.D	Domain ID in IP address format.
secondary	Domain ID is secondary. If not specified the domain ID is primary.
type	Domain type:
type-as	AS format. Hexadecimal value is 0x0005.
type-as4	AS4 format. Hexadecimal value is 0x0205.
type-back-comp	Used for backward compatibility. Hexadecimal value is 0x8000.
value	Domain ID.
HEX_DATA	Domain ID in hexadecimal.
secondary	Domain ID is secondary. If not specified the domain ID is primary

Default

No domain ID is defined.

Command Mode

Router mode

Applicability

This command was introduced before OcNOS version 1.3.

Example

The following example shows configuring a primary domain ID in IP address format.

```
#configure terminal
(config)#router ospf 100 vrf
(config-router)#domain-id 12.12.12.12
```

The following example shows configuring a secondary domain ID in IP address format.

```
#configure terminal
(config)#router ospf 100 vrf
```

```
(config-router)#domain-id 13.13.13.13 secondary
```

The following example shows configuring a primary domain ID in AS type format.

```
#configure terminal
(config)#router ospf 100 vrf
(config-router)#domain-id type type-as value 123456abcdef
```

CHAPTER 6 CSPF-TE Commands

This chapter is a reference for Constrained Shortest Path First Traffic Engineering (CSPF-TE) commands:

- [cspf default-retry-interval](#)
- [cspf disable-better-protection](#)
- [cspf enable-better-protection](#)
- [cspf enable-resource-constraint-crankback](#)
- [cspf tie-break](#)

cspf default-retry-interval

Use this command to set the default route computation retry interval for an OSPFv2 instance. This value is used for route recomputation (in the case of computation failures) and no retry interval is specified for a given LSP.

Use the `no` parameter with this command to unset default route computation retry interval.

Command Syntax

```
cspf default-retry-interval <1-3600>
no cspf default-retry-interval
```

Parameter

<1-3600> The retry interval in seconds. The default is 10 seconds.

Default

10 seconds

Command Mode

Configure mode

Applicability

This command was introduced before OcNOS version 1.3.

Examples

```
#configure terminal
(config)#cspf default-retry-interval 720
```

cspf disable-better-protection

Use this command to disable better protection (Default).

Command Syntax

```
cspf disable-better-protection
```

Parameter

None

Default

None

Command Mode

Configure mode

Applicability

This command was introduced before OcNOS version 1.3.

Examples

```
#configure terminal  
(config)#cspf disable-better-protection
```

cspf enable-better-protection

Use this command to enable better protection.

Command Syntax

```
cspf enable-better-protection
```

Parameter

None

Default

None

Command Mode

Configure mode

Applicability

This command was introduced before OcNOS version 1.3.

Examples

```
#configure terminal  
(config)#cspf enable-better-protection
```

cspf enable-resource-constraint-crankback

Use this command to enable resource constraint checking for crank back when the selected path does not meet the requirements.

Use `cspf disable-resource-constraint-crankback` to disable resource constraint checking for crank back when the selected path does not meet the requirements.

Command Syntax

```
cspf enable-resource-constraint-crankback
cspf disable-resource-constraint-crankback
```

Parameter

None

Default

```
cspf disable-resource-constraint-crankback
```

Command Mode

Configure mode

Applicability

This command was introduced before OcNOS version 1.3.

Examples

```
#configure terminal
(config)#cspf enable-resource-constraint-crankback
```

cspf tie-break

Use this command to set the tie-break method for an OSPFv2 instance. This selects a link (during route computation) when more than one candidate link satisfies all the route constraints and the associated cost and hop limit link attributes are equal.

Use the `no` parameter with this command to unset tie-break method.

Command Syntax

```
cspf tie-break (random|least-fill|most-fill)
no cspf tie-break
```

Parameters

<code>random</code>	Pick any path at random. This method places an equal number of LSPs on each link without taking into account the available bandwidth ratio. This is the default tie-break method.
<code>least-fill</code>	Pick the path with the largest minimum available bandwidth ratio. This method equalizes the reservation on each link.
<code>most-fill</code>	Pick the path with the smallest minimum available bandwidth ratio. This method uses one link until it is completely full and then uses the next link.

Default

By default, the tie-break method is set to `random`.

Command Mode

Configure mode

Applicability

This command was introduced before OcNOS version 1.3.

Examples

```
#configure terminal
(config)#cspf tie-break least-fill
```

Intermediate System to Intermediate System Command Reference

CHAPTER 1 IS-IS Commands

This chapter describes the IS-IS commands:

- `accept-lifetime`
- `address-family ipv6`
- `adjacency-check`
- `area-password`
- `authentication key-chain`
- `authentication mode`
- `authentication send-only`
- `bfd all-interfaces`
- `capability cspf`
- `clear clns neighbors`
- `clear clns is-neighbors`
- `clear ip isis route`
- `clear isis adjacency`
- `clear isis counter`
- `clear isis interface counter`
- `clear isis process`
- `debug isis`
- `default-information originate`
- `distance (IPv4)`
- `distance (IPv6)`
- `domain-password`
- `dynamic-hostname`
- `fast-reroute per-prefix`
- `fast-reroute per-prefix remote-lfa`
- `fast-reroute terminate-hold-on interval`
- `fast-reroute tie-break`
- `ignore-lsp-errors`
- `ip router isis`
- `ipv6 router isis`
- `isis authentication key-chain`
- `isis authentication mode md5`
- `isis authentication send-only`
- `isis bfd`
- `isis circuit-type`
- `isis csnp-interval`

- isis fast-reroute per-prefix candidate disable
- isis hello-interval
- isis hello-multiplier
- isis hello padding
- isis lsp-interval
- isis mesh-group
- isis metric
- isis network
- isis password
- isis priority
- isis retransmit-interval
- ispf
- isis wait-timer
- isis wide-metric
- isis tag
- isis te-metric
- is-type
- key chain
- key-id
- key-string
- key-string encrypted
- lsp-gen-interval
- lsp-mtu
- lsp-refresh-interval
- max-area-address
- max-lsp-lifetime
- metric-style
- mpls traffic-eng
- mpls traffic-eng router-id
- net
- passive-interface
- prc-interval-exp
- redistribute
- redistribute isis
- redistribute isis WORD
- router isis
- send-lifetime
- snmp restart isis
- spf-interval-exp

- [summary-address](#)
- [summary-prefix](#)

accept-lifetime

Use this command to specify the time period during which the authentication on a key chain is received as valid.

Use the `no` parameter with this command to negate this command.

Command Syntax

```
accept-lifetime HH:MM:SS MONTH <01-31> <1993-2035> HH:MM:SS MONTH <01-31> <1993-2035>
accept-lifetime HH:MM:SS MONTH <01-31> <1993-2035> infinite
accept-lifetime HH:MM:SS MONTH <01-31> <1993-2035> duration <1-2147483646>
no accept-lifetime
```

Parameters

HH:MM:SS	Specify the start time of accept-lifetime in hours, minutes and seconds.
<01-31>	Specify the day of the month to start. If the day is a single-digit, the leading 0 must be added, example: 01, 02, 03, etc.
MONTH	Specify the month of the year to start as the first three letters of the month with first letter in upper case, for example, Jan. (case sensitive).
<1993-2035>	Specify the year to start.
HH:MM:SS	Specify the end time of accept-lifetime in hours, minutes and seconds.
<01-31>	Specify the day of the month to end. If the day is a single-digit, the leading 0 must be added, example: 01, 02, 03, etc.
MONTH	Specify the month of the year to end as the first three letters of the month with first letter in caps, for example, Jan. (case sensitive).
<1993-2035>	Specify the year to end.
duration	Indicate the duration parameter.
<1-2147483646>	Specify the actual end time duration of a key in seconds.
infinite	Specify the end time to never expire.

Default

By default, accept-lifetime command is disabled

Command Mode

Keychain-key mode

Applicability

This command was introduced before OcNOS version 1.3.

Examples

The following example shows the setting of accept-lifetime for key-id 1 on the key chain named mychain.

```
#configure terminal
(config)#key chain mychain
```

```
(config-keychain)#key-id 1  
(config-keychain-key)#accept-lifetime 03:03:01 Dec 03 2004 04:04:02 Oct 06  
2006
```

address-family ipv6

Use this command to enter 'address-family ipv6' mode, where users can configure IPv6 routing specific configuration. Use the no parameter with this command to remove all configuration under 'address-family ipv6'.

Command Syntax

```
address-family ipv6 (unicast|)
no address-family ipv6 (unicast|)
```

Parameters

unicast Specify unicast routing for IPv6.

Default

Unicast routing is not configured.

Command Mode

Router mode

Example

```
#configure terminal
(config)#router isis bb
(config-router)#address-family ipv6 unicast
```

adjacency-check

Use this command to check ISIS neighbor protocol support.

Use the `no` parameter with this command to uncheck ISIS neighbor protocol support.

Command Syntax

```
adjacency-check
no adjacency-check
```

Parameters

None

Default

By default, adjacency-check command is disabled

Command Mode

Router mode

Applicability

This command was introduced before OcNOS version 1.3.

Examples

```
(config)#router isis bb
(config-router)#adjacency-check

(config-router)#no adjacency-check
```

area-password

Use this command to set the authentication password for the Level-1 area and to set authentication on Level-1 sequence number PDUs. This command enables authentication when receiving and sending link-state and sequence number PDUs in Level-1 areas. The password must be the same for all the ISIS routers in the same area.

Use the `no` parameter with this command to clear the area password.

Command Syntax

```
area-password WORD
area-password WORD authenticate snp (send-only|validate)
no area-password
```

Parameters

<code>WORD</code>	Password string.
<code>authenticate</code>	Insert the password into Level-1 SNP PDUs.
<code>snp</code>	Sequence number PDUs.
<code>send-only</code>	Only insert the password into the Level-1 sequence number PDUs, but not check the password in sequence number PDUs that it receives. Use this keyword during a software upgrade to ease the transition.
<code>validate</code>	Insert the password into Level-1 sequence number PDUs and check the password in sequence number PDUs that it receives.

Default

By default, the area password is not configured

Command Mode

Router mode

Applicability

This command was introduced before OcNOS version 1.3.

Examples

```
(config)#router isis bb
(config-router)#area-password mypasswd

(config)#router isis bb
(config-router)#area-password myPass authenticate snp send-only

(config)#router isis bb
(config-router)#no area-password
```

authentication key-chain

Use this command to set the key chain to be used for authentication at the instance level. Authentication mode must be set to `md5` to configure the key chain. If no key chain is configured with the `key-chain` command, no key-chain authentication is performed.

Only one authentication key-chain is applied to an ISIS interface at a time. That is, issuing a second `isis authentication key-chain` command overrides the first `isis authentication key-chain` command. If neither the `level-1` nor the `level-2` keyword is configured, the chain applies to both levels. Authentication can be specified for an individual ISIS interface using the `isis authentication key-chain` command.

Use the `no` parameter with this command to unset the key chain used for authentication.

Command Syntax

```
authentication key-chain WORD (level-1|level-2|)
no authentication key-chain (level-1|level-2|)
```

Parameters

<code>WORD</code>	Specify the chain name (valid authentication keys).
<code>level-1</code>	Specify an authentication key-chain for level-1 PDUs.
<code>level-2</code>	Specify an authentication key-chain for level-2 PDUs.

Default

The key chain applies to the level(s) on which authentication mode is configured as MD5 if no level is specified.

Command Mode

Router mode

Applicability

This command was introduced before OcnOS version 1.3.

Example

```
#configure terminal
(config)#router isis 1
(config-router)#authentication key-chain myKey level-1
```

authentication mode

Use this command to set the authentication mode at the instance level.

If clear-text authentication was configured using the `area-password` or `domain-password` commands, the `authentication mode` command overrides both of those commands (based on the level at which MD5 is configured). If the `authentication mode` command was used first, and subsequently an attempt is made to use the `area-password` or `domain-password` commands, the attempt fails. To configure clear-text authentication using the `area-password` or `domain-password` commands, first use the `no authentication mode` command.

The type of authentication and the level to which it applies can be specified for a single ISIS interface, rather than per ISIS instance, using the `isis authentication mode` command.

Use the `no` parameter with this command to unset the authentication mode.

Command Syntax

```
authentication mode {md5|text} (level-1|level-2|)
no authentication mode {md5|text} (level-1|level-2|)
```

Parameters

<code>md5</code>	Keyed message digest
<code>text</code>	Text mode
<code>level-1</code>	Specify an authentication key-chain for level-1 PDUs.
<code>level-2</code>	Specify an authentication key-chain for level-2 PDUs.

Default

The authentication mode is set to MD5 for both levels if no level is specified.

Command Mode

Router mode

Applicability

This command was introduced before OcnOS version 1.3.

Examples

```
#configure terminal
(config)#router isis 1
(config-router)#authentication mode md5 level-1

(config-router)#no authentication mode md5 level-1
```

authentication send-only

Use this command to set the send-only option at the instance level.

Use this command before configuring the authentication mode and authentication key-chain, so that the implementation of authentication goes smoothly. That is, the routers will have more time for the keys to be configured on each router if authentication is inserted only on the packets being sent, not checked on packets being received. After all routers that must communicate are configured with this command, enable the authentication mode and key chain on each router. Then, specify the `no authentication send-only` command to disable the send-only feature.

If the `level-1-2` keyword is configured, the send-only feature applies to both levels.

Use the `no` parameter with this command to unset the send-only option.

Command Syntax

```
authentication send-only (level-1-only|level-2-only|level-1-2)
no authentication send-only
```

Parameters

<code>level-1-only</code>	Set send-only option for level-1 only.
<code>level-2-only</code>	Set send-only option for level-2 only.
<code>level-1-2</code>	Set send-only option for level-1-2 only.

Default

By default, authentication send only is disabled

Command Mode

Router mode

Applicability

This command was introduced before OcnOS version 1.3.

Examples

```
#configure terminal
(config)#router isis 1
(config-router)#authentication send-only level-1-only

(config-router)#no authentication send-only
```

bfd all-interfaces

Use this command to enable the Bidirectional Forwarding Detection (BFD) feature on the interfaces enabled with this ISIS instance.

This command sets BFD fall-over check for all the neighbors under specified process. To disable BFD checking on particular interface use `isis bfd disable` command at interface mode.

Use the `no` parameter with this command to disable BFD functionality for an ISIS instance.

Command Syntax

```
bfd all-interfaces
no bfd all-interfaces
```

Parameters

None

Default

By default, the BFD feature is disabled.

Command Mode

Router mode

Applicability

This command was introduced before OcNOS version 1.3.

Examples

```
(config)#router isis aa
(config-router)#bfd all-interfaces

(config-router)#no bfd all-interfaces
```

capability cspf

Use this command to enable the constrained shortest path first (CSPF) feature in the ISIS module. CSPF calculates optimum explicit route (ER), using Traffic Engineering Database and (TED) and pre-existing Label Switched Path (LSP). The resulting ER is used by a signaling protocol (RSVP-TE) to set up LSPs. Use the no parameter with this command to disable CSPF functionality for an ISIS instance.

Command Syntax

```
capability cspf
no capability cspf
```

Parameters

None

Default

If this command is not used, the CSPF feature is disabled.

Command Mode

Router mode

Example

```
(config)#router isis aa
(config-router)#capability cspf
```

clear clns neighbors

Use this command to clear CLNS neighbor adjacencies.

Command Syntax

```
clear clns neighbors
```

Parameters

None

Command Mode

Exec mode and Privileged Exec mode

Applicability

This command was introduced before OcNOS version 1.3.

Example

```
>ena
#clear clns neighbors
```

clear clns is-neighbors

Use this command to clear IS neighbor adjacencies.

Command Syntax

```
clear clns is-neighbors System-ID
```

Parameters

System-ID Neighbor system ID in XXXX.XXXX.XXXX format.

Command Mode

Exec mode and Privileged Exec mode

Applicability

This command was introduced before OcnOS version 1.3.

Example

```
>enable  
#clear clns is-neighbors 1111.1111.1111.1111
```

clear ip isis route

Use this command to clear IPv4 routes.

Command Syntax

```
clear ip isis (WORD|) route (redistribution|all)
```

Parameters

<code>WORD</code>	Name that identifies the IS-IS area.
<code>redistribution</code>	Clear IS-IS local redistribution routes.
<code>all</code>	Clear all of the IS-IS routing tables.

Command Mode

Exec mode and Privileged Exec mode

Applicability

This command was introduced before OcnOS version 1.3.

Example

```
>ena  
#clear ip isis route redistribution
```

clear isis adjacency

This command is used to remove the entries from the IS-IS adjacency database. Clears all adjacencies for the specified routing instance or specified interface or particular system ID.

Command Syntax

```
clear isis adjacency (*|IFNAME|system-id XXXX.XXXX.XXXX|) (vrf VRFNAME|)
```

Parameters

*	Clear all neighbors.
IFNAME	Interface name.
XXXX.XXXX.XXXX	Neighbor System-ID.
VRFNAME	VRF name.

Command Mode

Exec mode and Privileged Exec mode

Applicability

This command was introduced before OcNOS version 1.3.

Example

```
#clear isis adjacency *
```

clear isis counter

Use this command to clear system-wide IS-IS counters (IsisSystemCounterEntry in RFC 4444).

Command Syntax

```
clear isis counter
```

Parameters

None

Command Mode

Exec mode and Privileged Exec mode

Applicability

This command was introduced before OcNOS version 1.3.

Example

```
#clear isis counter
```

clear isis interface counter

Use this command to clear interface counters. If you do not specify a parameter, then counters for all interfaces are cleared.

Command Syntax

```
clear isis interface counter (IFNAME|)
```

Parameters

IFNAME Interface name.

Command Mode

Exec mode and Privileged Exec mode

Applicability

This command was introduced before OcnOS version 1.3.

Example

```
#clear isis interface counter
```

clear isis process

Use this command to restart ISIS processes. If you do not specify a parameter, then all ISIS processes are restarted.

Command Syntax

```
clear isis (WORD|) process
```

Parameters

WORD Name that identifies the IS-IS area.

Command Mode

Exec mode and Privileged Exec mode

Applicability

This command was introduced before OcnOS version 1.3.

Example

```
#clear isis process
```

debug isis

Use this command to turn on debugging for specified criteria. Debug commands enable to show some debugging information about specified criteria into file or terminal.

Use the `no` parameter to turn off debugging for specified criteria.

Command syntax

```
debug isis (all|)
debug isis (authentication|bfd|checksum|events|hello|mpls (interface IFNAME |
  System-ID|)|cspf (events | hexdump|)|ifsm|local-updates|lsp|nfsm|nsm
  |pdu|protocol-errors|rib|spf)
no debug isis (all|)
no debug all
no debug all isis
undebug all
undebug isis (all|)
undebug all isis
no debug isis (authentication|bfd|checksum|events|hello|mpls (interface IFNAME |
  System-ID|)|cspf (events | hexdump|)|ifsm|local-updates|lsp|nfsm|nsm
  |pdu|protocol-errors|rib|spf)
undebug isis (authentication|bfd|checksum|events|hello|mpls (interface IFNAME |
  System-ID|)|cspf (events | hexdump|)|ifsm|local-updates|lsp|nfsm|nsm
  |pdu|protocol-errors|rib|spf)
```

Parameters

<code>all</code>	Enables all debugging.
<code>authentication</code>	Debugging for authentication.
<code>checksum</code>	Debugging for checksums.
<code>bfd</code>	Debugging for bidirectional forwarding detection.
<code>events</code>	Debugging for internal events.
<code>hello</code>	Debugging for hello processing.
<code>mpls</code>	Debugging for MPLS.
<code>IFNAME</code>	Interface name.
<code>System-ID</code>	System identifier.
<code>cspf</code>	Debugging for CSPF.
<code>events</code>	Events.
<code>hexdump</code>	Hexdump.
<code>ifsm</code>	Debugging for interface finite state machine.
<code>local-updates</code>	Debugging for local updates.
<code>lsp</code>	Debugging for link-state packet.
<code>nfsm</code>	Debugging for neighbor finite state machine.

nsm	Debugging for NSM messages.
pdu	Debugging for protocol data unit.
protocol-errors	Debugging for protocol errors.
rib	Debugging for RIB information.
spf	Debugging for shortest path first route calculation.

Command Mode

Privileged Exec mode and Configure mode

Applicability

This command was introduced before OcNOS version 1.3.

Examples

```
#configure terminal
(config)#debug isis pdu
```

```
#configure terminal
(config)#debug isis nsm
```

default-information originate

Use this command to originate reachability information to a default route into link-state packets.

There is no default information in a Level-2 domain by default, while a Level-1 router calculates a default to L1L2 route during SPF calculation. This command originates a default route into a Level-2 domain.

Use the `no` parameter with this command to withdraw reachability information to a default route from link-state packets.

Command Syntax

```
default-information originate (always| level-1|) (route-map WORD|)
no default-information originate (always| level-1|)
```

Parameters

<code>originate</code>	Specify to distribute a default route
<code>always</code>	The default route is advertised even if there is no default route in the router's routing table.
<code>level-1</code>	Distribute in level-1.
<code>route-map</code>	Identifies other filtering options via a route map.

Default

There is no default information in Level-2 domain by default, while Level-1 router calculates default to L1L2 route during SPF calculation. This command enables to originate default route into Level-2 domain. As an added option, if the user wants to originate the default route in L1 LSP, the "level-1" parameter can be used as follows:

```
default-information originate level-1
```

Command Mode

Router mode

Applicability

This command was introduced before OcnOS version 1.3.

Examples

```
#configure terminal
(config)#router isis bb
(config-router)#default-information originate
(config-router)#exit
(config)#exit
```

distance (IPv4)

Use this command in router mode to set the administrative distance for all IPv4 routes or routes from a specific source. Use the no parameter with this command to remove an administrative distance.

Command Syntax

```
distance <1-255> (System-ID (WORD|))  
no distance (System-ID|)
```

Parameters

<1-255>	Distance range.
System-ID	Source ID in XXXX.XXXX.XXXX format.
WORD	Access-list name.

Default

By default, all options are turned off.

Command Mode

Router mode

Examples

The following example shows setting the administrative distance for all routes.

```
#configure terminal  
(config)#router isis  
(config-router)#distance 10
```

The following example shows setting the administrative distance for a specific route source.

```
#configure terminal  
(config)#router isis  
(config-router)#distance 40 0000.0000.0001
```

distance (IPv6)

Use this command in router mode to set the administrative distance for all IPv6 routes.

Use the `no` parameter with this command to remove an administrative distance.

Command Syntax

```
distance <1-255>
no distance
```

Parameters

<1-255> Distance range.

Default

By default, all options are turned off.

Command Mode

Address-family ipv6 mode

Applicability

This command was introduced before OcNOS version 1.3.

Examples

The following example shows setting the administrative distance for all routes.

```
#configure terminal
(config)#router isis
(config-router)#address-family ipv6
(config-router-af)#distance 14
```

domain-password

Use this command to set the authentication password for the Level-2 domain, and optionally, the authentication password on Level-2 sequence number PDUs.

Configuring this command to enable authentication when receiving and sending link state and sequence number PDUs in Level-2 domain. The domain password must be the same in the Level-2 domain.

Use the `no` parameter with this command to clear the domain password.

Command Syntax

```
domain-password WORD
domain-password WORD authenticate snp (send-only|validate)
no domain-password
```

Parameters

<code>WORD</code>	Password string.
<code>authenticate</code>	Inserts the password into Level-1 sequence number PDUs.
<code>snp</code>	sequence number PDUs.
<code>send-only</code>	Only inserts the password into the Level-1 sequence number PDUs, but does not check the password in sequence number PDUs that it receives. Use this keyword during a software upgrade to ease the transition.
<code>validate</code>	Inserts the password into the Level-1 sequence number PDUs and checks the password in sequence number PDUs received.

Default

By default, there is no domain password.

Command Mode

Router mode

Applicability

This command was introduced before OcNOS version 1.3.

Examples

```
#configure terminal
(config)#router isis bb
(config-router)#domain-password mypasswd

(config)#router isis bb
(config-router)#domain-password myPass authenticate snp send-only

(config)#router isis bb
(config-router)#no domain-password
```

dynamic-hostname

Use this command to configure the hostname to advertise for an ISIS instance using the dynamic hostname exchange mechanism (RFC 2763) and system-ID-to-hostname translation. This command configures a hostname to use for the Dynamic Hostname Exchange Mechanism and System-ID to hostname translation. This is required to get accurate results when using the show isis database and a few other commands.

Use the `no` parameter to disable the Hostname configured.

Command Syntax

```
dynamic-hostname
hostname dynamic
dynamic-hostname area-tag
no dynamic-hostname
no hostname dynamic
```

Parameters

`area-tag` Use the routing area tag as the hostname, not the router's global hostname.

Default

By default, the Dynamic Hostname Exchange Mechanism is disabled.

Command Mode

Router mode

Example

```
#configure terminal
(config)#router isis bb
(config-router)#dynamic-hostname area-tag
```

fast-reroute per-prefix

Use this command to enable Loop Free Alternate Fast Reroute (LFA FRR) for all prefixes or only those prefixes in a route map.

Use the no form of this command to disable LFA FRR.

Command Syntax

```
fast-reroute per-prefix (level-1|level-2) proto (ipv4) (all|route-map WORD)
no fast-reroute per-prefix (level-1|level-2) proto (ipv4)
```

Parameters

level-1	Level 1 only.
level-2	Level 2 only.
ipv4	IPv4 address family only.
all	All prefixes.
route-map	Prefixes from a route map.
WORD	Route map name.

Command Mode

Router mode

Applicability

This command was introduced before OcNOS version 3.0.

Examples

```
#configure terminal
(config)#router isis 100
(config-router)#fast-reroute per-prefix level-2 proto ipv4 all
(config-router)#fast-reroute per-prefix level-1 proto ipv4 route-map rmap1
(config-router)#no fast-reroute per-prefix level-2 proto ipv4
```

fast-reroute per-prefix remote-lfa

Use this command to configure remote loop-free alternate fast reroute configuration for a particular level of an IS-IS instance.

Use the `no` parameter to remove remote loop-free alternate fast reroute configuration.

Command Syntax

```
fast-reroute per-prefix remote-lfa (level-1|level-2) proto ipv4 tunnel mpls-ldp
no fast-reroute per-prefix remote-lfa (level-1|level-2) proto ipv4
```

Parameters

<code>level-1</code>	Level 1 only.
<code>level-2</code>	Level 2 only.

Default

By default, `fast-reroute per-prefix remote-lfa` is not enabled.

Command Mode

Router mode

Applicability

This command was introduced before OcnOS version 5.1.

Examples

```
#configure terminal
(config)#router isis 1
(config-router)#fast-reroute per-prefix remote-lfa level-1 proto ipv4 tunnel
mpls-ldp
(config-router)#
```

fast-reroute terminate-hold-on interval

Use this command to set the Loop Free Alternate Fast Reroute (LFA FRR) termination hold-on timer.

Use the no form of this command to set the termination hold-on timer to its default value (1000 milliseconds).

Command Syntax

```
fast-reroute terminate-hold-on interval <100-100000>
no fast-reroute terminate-hold-on interval
```

Parameters

<100-100000> LFA FRR termination hold-on timer interval in milliseconds.

Default

1000 milliseconds

Command Mode

Router mode

Applicability

This command was introduced before OcNOS version 3.0.

Examples

```
#configure terminal
(config)#router isis 100
(config-router)#fast-reroute terminate-hold-on interval 7000
(config-router)#no fast-reroute terminate-hold-on interval
```

fast-reroute tie-break

Use this command to set the tie-breaking policy for selecting a fast reroute repair path. You assign a priority to each type of repair path. The tie-breaker value is used to select an LFA FRR route when multiple LFA FRR routes are available for the same primary route.

Use the `no` form of this command to set the tie-break preference value for a protection type to its default value.

To set all types of repair paths to their default priorities, do not specify a repair path with the `no` form of this command.

Command Syntax

```
fast-reroute tie-break (level-1|level-2) proto (ipv4) (primary-path|interface-
disjoint|node-protecting|broadcast-interface-disjoint|secondary-path|downstream-
path) index <1-255>
```

```
no fast-reroute tie-break (level-1|level-2) proto (ipv4) (primary- path|interface-
disjoint|node-protecting|broadcast-interface-disjoint|secondary-
path|downstream-path)
```

Parameters

<code>level-1</code>	Level 1 only.
<code>level-2</code>	Level 2 only.
<code>ipv4</code>	IPv4 address family only.
<code>primary-path</code>	Use a path from the Equal-Cost Multipath Path (ECMP) set. An ECMP found during the primary shortest path first (SPF) repair might not be desirable in networks where traffic exceeds the capacity of any single link.
<code>interface-disjoint</code>	Link protecting: prefer a backup path that uses a different interface than the interface used to reach destination via the primary path.
<code>node-protecting</code>	Bypass the <code>primary-path</code> gateway router which might not protect the router that is the next hop in the primary path. This ensures complete traffic protection even if the primary next-hop router fails.
<code>broadcast-interface-disjoint</code>	Do not use the interface if connected to a broadcast network. Repair paths protect links when a repair path and a protected primary path use <i>different</i> next-hop interfaces. However, on broadcast interfaces, if the repair path is computed via the same interface as the primary path, but their next-hop gateways are different, the router is protected but the link might not be.
<code>secondary-path</code>	Prefer a non-ECMP backup path.
<code>downstream-path</code>	Prefer a backup path to the destination which satisfies the downstream condition where the path cost to reach the destination from the LFA next hop is less than the path cost to the destination from the self node via primary next hop: $Distance_opt(N, D) < Distance_opt(S, D)$ This might result in lost traffic, but prevents looping.
<code>index</code>	Tie breaking index. A lower value has higher preference.

<1-255> Tie breaking index value.

Defaults

primary-path	20
interface-disjoint	60
node-protecting	30
broadcast-interface-disjoint	70
secondary-path	255
downstream-path	90

Command Mode

Router mode

Applicability

This command was introduced before OcNOS version 3.0.

Examples

```
#configure terminal
(config)#router isis 100
(config-router)#fast-reroute tie-break level-2 proto ipv4 node-protecting
index 127
(config-router)#no fast-reroute tie-break level-1 proto ipv4
broadcastinterface-disjoint
```

ignore-lsp-errors

Use this command to ignore link-state packets (LSPs) with checksum errors. By default, ISIS validates the checksum for LSP and if the checksum has an error, the LSP is dropped. Giving this command says to ignore the LSP checksum error and treat it as if checksum is passed.

Use the `no` parameter to turn off this function.

Command Syntax

```
ignore-lsp-errors
no ignore-lsp-errors
```

Parameters

None

Default

By default, the LSP checksum is checked on receipt.

Command Mode

Router mode

Applicability

This command was introduced before OcNOS version 1.3.

Example

In this sample, rtr1 does not drop LSP packets with bad checksum.

```
#configure terminal
(config)#router isis bb
(config-router)#ignore-lsp-errors
```

ip router isis

Use this command to enable ISIS IPv4 routing on the interface. This command is mandatory to ISIS configuration.

After giving this command, the router sends ISIS Hello with IP address TLV on this interface and IP reachability information TLV in link-state packets are updated.

Use the `no` parameter with this command to disable ISIS IPv4 routing on the interface. This action does not clear the ISIS database. To clear the database, unconfigure the ISIS routing instance.

Command Syntax

```
ip router isis WORD
no ip router isis WORD
```

Parameters

`WORD` Name that identifies the IS-IS area. Specify an existing area name or a new area name.

Default

By default, IPv4 routing is disabled on the router.

Command Mode

Interface mode

Applicability

This command was introduced before OcNOS version 1.3.

Example

```
#configure terminal
(config)#interface eth0
(config-if)#ip router isis bb
```

ipv6 router isis

Use this command to enable ISIS IPv6 routing on the interface. This command is mandatory to IPv6 ISIS configuration. Match the ISIS instance tag to one of existing instance's tags, or a new instance with the tag name should be initiated, otherwise routing will not run on this interface.

Configuring this command, the router sends ISIS Hello with IPv6 address TLV on this interface, and IPv6 reachability information TLV in the LSP will be updated.

Use the no parameter with this command to disable ISIS IPv6 routing on the interface.

Command Syntax

```
ipv6 router isis WORD
no ipv6 router isis WORD
```

Parameters

WORD ISIS instance name.

Default

By default, IPv6 routing is disabled on the router.

Command Mode

Interface mode

Example

```
#configure terminal
(config)#interface eth0
(config-if)#ipv6 router isis bb
```

isis authentication key-chain

Use this command to set the key chain to be used for authentication on the interface-related packets.

Authentication mode must be set to `md5` to configure the key chain. If no key chain is configured with the `key-chain` command, no key-chain authentication is performed. Only one authentication key-chain is applied to an ISIS interface at a time. That is, issuing a second `isis authentication key-chain` command overrides the first `isis authentication key-chain` command.

If neither the `level-1` nor `level-2` keyword is configured, the key chain applies to the level(s) on which the authentication mode is configured as `md5`. Authentication can be specified for an entire instance of ISIS, instead of at the interface level, by using the `authentication key-chain` command.

Use the `no` parameter with this command to unset the key chain used for authentication on the interface-related packets.

Command Syntax

```
isis authentication key-chain WORD (level-1|level-2|)
no isis authentication key-chain (level-1|level-2|)
```

Parameters

<code>WORD</code>	Chain name - valid authentication keys.
<code>level-1</code>	Specify an authentication key-chain for level-1 PDUs.
<code>level-2</code>	Specify an authentication key-chain for level-2 PDUs.

Default

By default, this option is disabled. The key chain applies to the level(s) on which authentication mode is configured as MD5 if no level is specified.

Command Mode

Interface mode

Applicability

This command was introduced before OcNOS version 1.3.

Example

```
#configure terminal
(config)#interface eth1
(config-if)#isis authentication key-chain myKey level-1
```

isis authentication mode md5

Use this command to set the MD5 authentication mode. If the `isis password` command was used, then subsequently an attempt is made to use the `isis authentication mode` command, the attempt fails. To configure `isis authentication mode` command, first use the `no isis password` command. If the `isis authentication mode` command was used, then subsequently an attempt is made to use the `isis password` command, the attempt fails.

To configure clear text authentication using the `isis password` command, first use the `no isis authentication mode` command. The type of authentication and the level to which it applies can be specified for the entire ISIS instance, rather than per interface, using the `authentication mode` command.

Use the `no` parameter with this command to unset the MD5 authentication mode.

Command Syntax

```
isis authentication mode {md5|text} (level-1|level-2|)
no isis authentication mode {md5|text} (level-1|level-2|)
```

Parameters

<code>md5</code>	Keyed message digest
<code>text</code>	Text mode
<code>level-1</code>	Specify an authentication key-chain for level-1 PDUs.
<code>level-2</code>	Specify an authentication key-chain for level-2 PDUs.

Default

By default, this option is disabled. The authentication mode will be set to MD5 for both levels if no level is specified.

Command Mode

Interface mode

Applicability

This command was introduced before OcNOS version 1.3.

Example

```
#configure terminal
(config)#interface eth1
(config-if)#isis authentication mode md5 level-1
```

isis authentication send-only

Use this command to set the send-only option to the interface-related packets.

Use this command before configuring the ISIS authentication mode and ISIS authentication key-chain, so that the implementation of authentication goes smoothly. That is, the routers will have more time for the keys to be configured on each router if authentication is inserted only on the packets being sent, not checked on packets being received. After all routers that must communicate are configured with this command, enable the authentication mode and key chain on each router.

Use the `no` parameter with this command to unset the send-only option to the interface-related packets.

Command Syntax

```
isis authentication send-only (level-1-only|level-2-only|level-1-2)
no isis authentication send-only
```

Parameters

<code>level-1-only</code>	Set send-only option for level-1 only.
<code>level-2-only</code>	Set send-only option for level-2 only.
<code>level-1-2</code>	Set send-only option for level-1-2 only.

Default

By default, this option is disabled. The send-only option applies to both levels if no level is specified.

Command Mode

Interface mode

Applicability

This command was introduced before OcnOS version 1.3.

Example

```
#configure terminal
(config)#interface eth1
(config-if)#isis authentication send-only level-1-only
```

isis bfd

Use this command to enable/disable the BFD check on interface.

The `isis bfd` command allows a user to enable BFD on an interface. The `isis bfd disable` command disables BFD checking on an interface. However, the `no isis bfd` and `no isis bfd disable` commands both remove the enable/disable configuration, but do not disable/enable BFD.

The `bfd all-interfaces` command enables BFD on all interfaces attached to an instance then configuring. This command disables BFD configuration on a particular interface.

Command Syntax

```
isis bfd (disable|)
no isis bfd (disable|)
```

Parameters

`disable` Specify to disable BFD.

Default

By default, bfd feature enable/disable is not configured.

Command Mode

Interface mode

Applicability

This command was introduced before OcnOS version 1.3.

Example

```
#configure terminal
(config)#interface eth0
(config-if)#isis bfd disable
```

isis circuit-type

Use this command to set the circuit type for the interface.

If level-1 or level-2-only is specified in this command, ISIS sends only the specified level of PDUs. On the point-to-point interface, there is only one type of Hello packet, so in this case ISIS Hello will be sent regardless of circuit-type. If is-type is configured as level-1 or level-2 only, routing for this instance is performed for only the specified level. In this manner, only the particular level of PDU is sent on the interface.

Use the `no` parameter to reset circuit type to the default.

Command Syntax

```
isis circuit-type (level-1|level-1-2|level-2-only)
no isis circuit-type
```

Parameters

<code>level-1</code>	Specify that only Level-1 adjacencies are formed.
<code>level-1-2</code>	Specify that Level-1-2 adjacencies are formed.
<code>level-2-only</code>	Specify that only Level-2 adjacencies are formed.

Default

By default, the default circuit-type is level-1-2.

Command Mode

Interface mode

Applicability

This command was introduced before OcnOS version 1.3.

Example

```
#configure terminal
(config)#interface eth0
(config-if)#isis circuit-type level-2-only
```

isis csnp-interval

Use this command to set CSNP (Complete sequence number PDU) interval in seconds.

Configuring this command changes the interval between two consecutive CSNP transmission. By default, CSNP is sent every 10 seconds only by LAN DIS. This parameter is only valid on broadcast interface, since periodic CSNP is only sent on broadcast interface, while CSNP on Point-to-Point interface is sent only when adjacency is initiated.

Use the `no` parameter with this command to reset CSNP interval to the default value.

Command Syntax

```
isis csnp-interval <1-65535> (level-1|level-2|)
no isis csnp-interval (level-1|level-2|)
```

Parameters

<1-65535>	Specify the CSNP interval in seconds.
level-1	Specify Level-1 CSNP.
level-2	Specify Level-2 CSNP.

Default

By default, ISIS uses 10 seconds for the interval and the interval is applied to both level-1 and level-2.

Command Mode

Interface mode

Applicability

This command was introduced before OcnOS version 1.3.

Example

```
#configure terminal
(config)#interface eth0
(config-if)#isis csnp-interval 20
```

isis fast-reroute per-prefix candidate disable

Use this command to prevent an interface from becoming an Loop Free Alternate Fast Reroute (LFA FRR) for a primary route.

Use the no form of this command to enable an interface to become an LFA FRR for a primary route.

Command Syntax

```
isis fast-reroute per-prefix candidate disable (level-1|level-2)
no isis fast-reroute per-prefix candidate disable (level-1|level-2)
```

Parameters

level-1	Level-1 only
level-2	Level-2 only

Command Mode

Interface mode

Applicability

This command was introduced before OcNOS version 3.0.

Example

```
#configure terminal
(config)#interface eth0
(config-if)#isis fast-reroute per-prefix candidate disable level-2
(config-if)#no isis fast-reroute per-prefix candidate disable level-2
```

isis hello-interval

Use this command to set the Hello interval in seconds. The Hello-interval is set with the hello-multiplier (see `isis hello-multiplier` command).

Configuring this command changes the time interval between two consecutive Hello transmissions. If a device receives its own LSP with a maximum sequence number, then it suspends ISIS for the hold interval. DIS sends Hello transmissions at three times the rate than non-DIS. If ISIS is elected as DIS on this interface, ISIS sends Hello every 3.3 seconds.

If `minimal` keyword is specified, Holding timer in Hello PDU is set to 1 second and Hello interval is calculated by dividing by the hello-multiplier. For example, if the hello-multiplier is configured as 4 and `hello-interval minimal` is the command used, an Hello PDU is sent every 250 milliseconds.

Use the `no` parameter to set the Hello interval to the default.

Command Syntax

```
isis hello-interval <1-65535> (level-1|level-2|)
isis hello-interval minimal (level-1-only|level-2-only|level-1-2)
no isis hello-interval (level-1|level-2|)
no isis hello-interval minimal
```

Parameters

<code><1-65535></code>	Specify the hello interval in seconds.
<code>minimal</code>	Specify the holding-time as 1 second.
<code>level-1</code>	Specify Level-1 CSNP.
<code>level-2</code>	Specify Level-2 CSNP.
<code>level-1-only</code>	Specify only Level-1 CSNP.
<code>level-2-only</code>	Specify only Level-2 CSNP.
<code>level-1-2</code>	Specify only Level-1-2 CSNP.

Default

By default, ISIS uses 10 seconds for the interval and the interval is applied to both level-1 and level-2.

Command Mode

Interface mode

Applicability

This command was introduced before OcnOS version 1.3.

Examples

```
#configure terminal
(config)#interface eth0
(config-if)#isis hello-interval 5 level-1

(config-if)#isis hello-interval minimal level-1-only
```

isis hello-multiplier

Use this command to set multiplier for Hello holding time.

Changes Holding Timer in Hello PDU. Holding timer is calculated by “Hello-Interval” multiplied by this value. If `minimal` keyword is specified with the Hello-Interval, the holding timer is set to 1 second and the hello-interval is calculated by dividing 1 by this value.

Use the `no` parameter with this command to set multiplier to the default.

Command Syntax

```
isis hello-multiplier <2-100> (level-1|level-2|)
no isis hello-multiplier (level-1|level-2|)
```

Parameters

<code><2-100></code>	Specify a hello multiplier value.
<code>level-1</code>	Specify Level-1 hello.
<code>level-2</code>	Specify Level-2 hello.

Default

By default, ISIS uses 3 seconds for the multiplier value and the multiplier is applied to both level-1 and level-2.

Command Mode

Interface mode

Applicability

This command was introduced before OcnOS version 1.3.

Example

```
#configure terminal
(config)#interface eth0
(config-if)#isis hello-multiplier 4
```

isis hello padding

Use this command to enable IS-IS hello padding at the interface level.

Intermediate System-to-Intermediate System (IS-IS) hellos are padded to the full maximum transmission unit (MTU) size. The benefit of padding IS-IS hellos to the full MTU is that it allows for early detection of errors that result from transmission problems with large frames or errors that result from mismatched MTUs on adjacent interfaces.

Use the `no` parameter with this command to disable IS-IS hello padding.

Command Syntax

```
isis hello padding
no isis hello padding
```

Parameters

None

Default

By default, IS-IS hello padding is enabled

Command Mode

Interface mode

Applicability

This command was introduced before OcNOS version 1.3.

Examples

```
#configure terminal
(config)#interface eth1
(config-if)#isis hello padding

(config-if)#no isis hello padding
```

isis lsp-interval

Use this command to set the link-state packet (LSP) transmission interval.

Giving this command changes the minimum interval between two consecutive LSP transmission. When flooding or some other event triggers LSP transmission, the LSP is put in the interface queue and scheduled to send according to this interval. Two consecutive LSP transmissions are scheduled to have at least this interval.

Use the `no` parameter with this command to set LSP transmission interval to the default.

Command Syntax

```
isis lsp-interval <1-4294967295>
no isis lsp-interval
```

Parameters

<1-4294967295> LSP transmission interval in milliseconds.

Default

By default, ISIS uses 33 milliseconds for the interval.

Command Mode

Interface mode

Applicability

This command was introduced before OcNOS version 1.3.

Examples

```
#configure terminal
(config)#interface eth0
(config-if)#isis lsp-interval 100

(config-if)#no isis lsp-interval
```

isis mesh-group

Use this command to set Mesh Group ID on the current interface.

Use the `no` parameter to unset mesh group on the current interface.

Command Syntax

```
isis mesh-group <1-4294967295>
no isis mesh-group
```

Parameters

<1-4294967295> Specify a mesh group number

Default

By default, mesh groups are not enabled on this interface.

Command Mode

Interface mode

Examples

```
(config)#interface eth0
(config-if)#isis mesh-group 20

(config)#interface eth2
(config-if)#no isis mesh-group
```

isis metric

Use this command to set the default metric for the interface. The interface default metric is put into IP reachability information TLVs and in IS reachability information TLVs in link-state packets. The value is used for SPF calculation, and is applied when the metric-style is configured as “narrow”.

Use the `no` parameter with this command to set default metric to the default.

Command Syntax

```
isis metric <1-63> (level-1|level-2|)
no isis metric (level-1|level-2|)
```

Parameters

<code><1-63></code>	Default metric.
<code>level-1</code>	Default metric for level-1 circuit.
<code>level-2</code>	Default metric for level-2 circuit.

Default

By default, ISIS uses 10 for the metric value and the value is applied to both level-1 and level-2.

Command Mode

Interface mode

Applicability

This command was introduced before OcnOS version 1.3.

Example

```
#configure terminal
(config)#interface eth0
(config-if)#isis metric 20
```

isis network

Use this command to change a broadcast interface network type to a point-to-point network type.

Use the `no` parameter with this command to revert to the default setting of a broadcast interface network type.

Command Syntax

```
isis network (broadcast|point-to-point)
no isis network
```

Parameters

<code>broadcast</code>	Specify ISIS a broadcast multi-access network.
<code>point-to-point</code>	Specify ISIS a point-to-point network.

Default

By default, the network is set to a broadcast multi-access network type.

Command Mode

Interface mode

Applicability

This command was introduced before OcNOS version 1.3.

Example

```
#configure terminal
(config)#interface eth0
(config-if)#isis network point-to-point
```

isis password

Use this command to set the authentication password of Hello PDU on the interface.

If the `isis authentication mode` command was used, then subsequently an attempt is made to use the `isis password` command, the attempt fails. To configure clear text authentication using the `isis password` command, first use the `no isis authentication mode` command.

Use the `no` parameter to clear the password.

Command Syntax

```
isis password WORD (level-1|level-2|)
no isis password (level-1|level-2|)
```

Parameters

WORD	Specify a password string.
level-1	Specify a password for Level-1 hello PDUs.
level-2	Specify a password for Level-2 hello PDUs.

Default

By default, no password is configured; this applies to both level-1 and level-2.

Command Mode

Interface mode

Applicability

This command was introduced before OcnOS version 1.3.

Example

```
#configure terminal
(config)#interface eth0
(config-if)#isis password mypassword level-1
```

isis priority

Use this command to set the priority for LAN DIS election. This command changes the priority value in LAN ISIS Hello PDUs. A lower priority value is less preferred in DIS election, and a higher priority value is more preferred.

Note: This command is not valid for Point-to-Point interface.

Use the `no` parameter to set priority to the default.

Command Syntax

```
isis priority <0-127> (level-1|level-2|)
no isis priority (level-1|level-2|)
```

Parameters

<0-127>	Priority value
level-1	Specify a password for Level-1 hello PDUs.
level-2	Specify a password for Level-2 hello PDUs.

Default

By default, ISIS uses 64 for the priority value, and the priority is applied to both level-1 and level-2.

Command Mode

Interface mode

Applicability

This command was introduced before OcnOS version 1.3.

Example

```
#configure terminal
(config)#interface eth0
(config-if)#isis priority 127
```

isis retransmit-interval

Use this command to set the link-state packet (LSP) retransmission interval.

Use the `no` parameter to set the interval to the default.

Command Syntax

```
isis retransmit-interval <1-65535>
no isis retransmit-interval
```

Parameters

<1-65535> Interval for retransmission of the same LSP in seconds.

Default

By default, ISIS uses an interval of 5 seconds.

Command Mode

Interface mode

Applicability

This command was introduced before OcNOS version 1.3.

Examples

```
#configure terminal
(config)#interface eth0
(config-if)#isis retransmit-interval 10

(config-if)#no isis retransmit-interval
```

ispf

Use this command to enable incremental SPF for a routing process.

Use the `no` parameter to disable incremental SPF from a routing process.

Command Syntax

```
ispf (level-1|level-2-only|)
no ispf
```

Parameters

<code>level-1</code>	Act as level-1 only IS.
<code>level-2-only</code>	Act as level-2 only IS.

Default

By default, all levels are turned off.

Command Mode

Router mode

Applicability

This command was introduced before OcnOS version 1.3.

Examples

```
#configure terminal
(config)#router isis bb
(config-router)#ispf level-1

(config)#router isis bb
(config-router)#no ispf
```

isis wait-timer

Use the `isis wait-timer seconds` command to configure the number of seconds the router will wait for adjacency information

Use the `no` parameter to set the wait-timer to the default.

Command Syntax

```
isis wait-timer <1-65535> (level-1|level-2|)
no isis wait-timer (level-1|level-2|)
```

Parameters

<code>level-1</code>	Act as level-1 only IS.
<code>level-2</code>	Act as level-2 only IS.

Default

By default, wait-timer will be 20 seconds (2 times the hello timer).

Command Mode

Router mode

Applicability

This command was introduced before OcNOS version 1.3.

Examples

```
#configure terminal
(config)#router isis bb
(config-router)#isis wait-timer 30

(config)#router isis bb
(config-router)#no isis wait-timer
```

isis wide-metric

Use this command to set wide metric for the interface.

Interface wide-metric is put into Extended IP reachability TLVs. Extended IS reachability TLVs and IPv6 reachability TLVs in LSPs. The value is used for SPF calculation. The value is applied when metric-style is configured as 'wide'.

Use the `no` parameter to set wide metric to the default.

Command Syntax

```
isis wide-metric <1-16777214> (level-1|level-2|)
no isis wide-metric (level-1|level-2|)
```

Parameters

<1-16777214>	Specify a wide metric.
level-1	Specify the wide metric for Level-1 circuit.
level-2	Specify the wide metric for Level-2 circuit.

Default

By default, ISIS uses 10 for the metric value and the metric is applied to both level-1 and level-2.

Command Mode

Interface mode

Applicability

None.

Examples

```
#configure terminal
(config)#interface eth0
(config-router)#isis wide-metric 100

(config)#interface eth0
(config-router)#no isis wide-metric
```

isis tag

Use this command to sets the tag for link-state packets (LSPs) sent out advertising routes for networks directly connected to an interface.

If you do not specify a parameter, then the tag value is set for level-1-2 boundary.

Use the `no` parameter to unset the tag.

Command Syntax

```
isis tag <1-4294967295> (level-1|level-2|)  
no isis tag (level-1|level-2|)
```

Parameters

<code><1-4294967295></code>	Tag value.
<code>level-1</code>	Specify the tag value for the level-1 boundary.
<code>level-2</code>	Specify the tag value for the level-2 boundary.

Command Mode

Interface mode

Examples

```
>ena  
#con term  
Enter configuration commands, one per line. End with CNTL/Z.  
(config)#interface eth0  
(config-if)#isis tag 500 level-1
```

isis te-metric

Use this command to set TE metric for the interface. Interface te-metric is put into Extended IS reachability TLV. The value is used for CSPF calculation. The value is applied when metric-style is configured as wide.

Use the `no` parameter to unset the TE metric.

Command Syntax

```
isis te-metric <1-16777214> (level-1|level-2|)
no isis te-metric (level-1|level-2|)
```

Parameters

<1-16777214>	Specify a TE metric.
level-1	Specify the TE metric for level-1 circuit.
level-2	Specify the TE metric for level-2 circuit.

Default

By default, it will take ISIS wide metric value.

Command Mode

Interface mode

Applicability

This command was introduced in OcNOS version 5.0

Examples

```
#configure terminal
(config)#interface eth1
(config-router)#isis te-metric 100
(config)#interface eth1
(config-router)#no isis te-metric
```

is-type

Use this command to set the IS to the specified level of routing.

Changing `is-type` brings down, then brings up a particular level of routing. There is a limitation: Only one ISIS instance can run Level-2 routing (either Level-2 only IS, or Level-1-2 IS).

Use the `no` parameter to set the IS to the default.

Command Syntax

```
is-type (level-1|level-1-2|level-2-only)
no is-type
```

Parameters

<code>level-1</code>	Act as level-1 only IS.
<code>level-1-2</code>	Act as level-1-2 IS.
<code>level-2-only</code>	Act as level-2 only IS.

Default

By default, ISIS uses level-1-2 if there is no Level-2 instance nor a Level-1-2 instance. Otherwise, it uses level-1.

Command Mode

Router mode

Applicability

This command was introduced before OcnOS version 1.3.

Examples

```
#configure terminal
(config)#router isis bb
(config-router)#is-type level-1

(config)#router isis bb
(config-router)#no is-type
```

key chain

Use this command to enter the key chain management mode and to configure a key chain with a key chain name. This command allows you to enter the keychain mode to specify keys on this key chain.

Command Syntax

```
key chain WORD
no key chain WORD
```

Parameters

WORD Specify the name of the key chain to manage.

Default

By default, keychain mode is disabled.

Command Mode

Configure mode

Applicability

This command was introduced before OcnOS version 1.3.

Examples

The following example shows the creation of a key chain named `mychain` and the change to keychain mode:

```
#configure terminal
(config)#key chain mychain
(config-keychain)#
```

key-id

Use this command to manage, add or delete authentication keys in a key-chain. This command allows you to enter the keychain-key mode to set a password for the key.

Command Syntax

```
key-id <0-2147483647>
no key-id <0-2147483647>
```

Parameters

<0-2147483647> Specify a key identifier.

Default

By default, ISIS uses level-1-2 if there is no Level-2 instance nor a Level-1-2 instance. Otherwise, it uses level-1.

Command Mode

Keychain mode

Applicability

This command was introduced before OcnOS version 1.3.

Examples

The following example configures a key number 1 and shows the change to keychain-key command mode.

```
#configure terminal
(config)#key chain mychain
(config-keychain)#key-id 1
(config-keychain-key)#
```

key-string

Use this command to define a password in plain-text to be used by a key.

The password is stored as encrypted, and is displayed in encrypted text when show running-config command is executed.

Use the `no` parameter with this command to disable this feature.

Command Syntax

```
key-string WORD
no key-string
```

Parameters

WORD	Specify a string of characters to be used as a password by the key. The length of the string should be between 1-80 characters.
------	---

Default

By default, password is not configured.

Command Mode

Keychain mode and Keychain-key mode

Applicability

This command was introduced before OcnOS version 1.3.

Examples

In the following example, the password for `key 1` in the key chain named `mychain` is set to `prime`:

```
#configure terminal
(config)#key chain mychain
(config-keychain)#key-id 1
(config-keychain-key)#key-string prime

(config-keychain)#key-id 1
(config-keychain-key)#no key-string
```

key-string encrypted

Use this command to define a password in its encrypted format to be used by a key.

Use the `no` parameter with this command to disable this feature

Command Syntax

```
key-string encrypted WORD
no key-string encrypted
```

Parameters

WORD	Specify the encrypted string of characters to be used as a password by the key. The length of this string should be between 18-162 characters.
------	--

Default

By default, password is not configured.

Command Mode

Keychain mode and Keychain-key mode.

Applicability

This command was introduced in OcNOS version 4.1.

Examples:

In the following example, the encrypted password for key-id 1 in the key chain named mykeychain is set to 0xd6c50b442de47f70 (equivalent to "mychain" in plain-text):

```
#configure terminal
(config)#key chain mykeychain
(config-keychain)#key-id 1
(config-keychain-key)#key-string encrypted 0xd6c50b442de47f70
(config-keychain)#key-id 1
(config-keychain-key)#no key-string
```

lsp-gen-interval

Use this command to set the minimum interval before regenerating the same link-state packet (LSP). The smaller the interval, the faster the convergence. However, this setting might cause more frequent flooding.

Use the `no` parameter with this command to set the interval to the default.

Command Syntax

```
lsp-gen-interval <1-120>
lsp-gen-interval (level-1|level-2) <1-120>
no lsp-gen-interval (level-1|level-2|)
```

Parameters

<1-120>	Minimum interval in seconds.
level-1	Interval for Level-1 IS.
level-2	Interval for Level-2 IS.

Default

By default, ISIS uses 5 seconds for the interval and the interval is applied to both level-1 and level-2.

Command Mode

Router mode

Applicability

This command was introduced before OcNOS version 1.3.

Example

```
#configure terminal
(config)#router isis bb
(config-router)#lsp-gen-interval 10
```

lsp-mtu

Use this command to set maximum transfer unit for link-state packets (LSPs).

Use the `no` parameter with this command to set the interval to the default.

Command Syntax

```
lsp-mtu (level-1|level-2|) <512-4352>
no lsp-mtu (level-1|level-2|)
```

Parameters

<512-4352>	MTU size
level-1	Size for Level-1 IS.
level-2	Size for Level-2 IS.

Default

By default, the MTU is 1492 bytes.

Command Mode

Router mode

Applicability

This command was introduced before OcNOS version 1.3.

Example

```
#configure terminal
(config)#router isis bb
(config-router)#lsp-mtu 555
```

lsp-refresh-interval

Use this command to set the link-state packet (LSP) refresh interval.

IP Infusion Inc. recommends making the `lsp-refresh-interval` smaller than the [max-lsp-lifetime](#) value.

Use the `no` parameter to set the interval to the default value.

Command Syntax

```
lsp-refresh-interval <1-65535>
no lsp-refresh-interval
```

Parameters

<1-65535> Refresh interval in seconds.

Default

By default, the interval is 900 seconds.

Command Mode

Router mode

Applicability

This command was introduced before OcNOS version 1.3.

Examples

```
#configure terminal
(config)#router isis bb
(config-router)#lsp-refresh-interval 600

(config)#router isis bb
(config-router)#no lsp-refresh-interval
```

max-area-address

Use this command to set the maximum number of ISIS areas that can be configured on this router with the `net` command. By default, ISIS permits a maximum of three areas that can be defined on a router.

Use the `no` parameter with this command to set the maximum number of ISIS areas to its default (3).

Command Syntax

```
max-area-address <3-254>
no max-area-address
```

Parameters

<3-254> The maximum number of areas in the network.

Default

By default, the maximum number of areas is 3.

Command Mode

Router mode

Applicability

This command was introduced before OcNOS version 1.3.

Examples

```
(config)#router isis net2
(config-router)#max-area-address 5
(config-router)#net 71.0001.0000.0000.0001.00
(config-router)#net 72.0001.0000.0000.0001.00
(config-router)#net 73.0001.0000.0000.0001.00
(config-router)#net 74.0001.0000.0000.0001.00
(config-router)#net 75.0001.0000.0000.0001.00
```

max-lsp-lifetime

Use this command to set the maximum link-state packet (LSP) lifetime. You must set `max-lsp-lifetime` greater than the `lsp-refresh-interval` interval.

Use the `no` parameter to set the lifetime to the default.

Command Syntax

```
max-lsp-lifetime <350-65535>
no max-lsp-lifetime
```

Parameters

<350-65535> Maximum LSP lifetime in seconds.

Default

By default, `max-lsp-lifetime` is set to 1200 seconds.

Command Mode

Router mode

Applicability

This command was introduced before OcNOS version 1.3.

Examples

```
#configure terminal
(config)#router isis bb
(config-router)#max-lsp-lifetime 1500

(config)#router isis bb
(config-router)#no max-lsp-lifetime
```

metric-style

Use this command to configure the ISIS metric style. Use the following table when changing the method of how TLV encodes and SPF calculates a decision:

Metric-style Command	Wide SPF	Wide TLV	Narrow SPF	Narrow TLV
narrow (default)	OFF	OFF	ON	OFF
narrow transition	ON	OFF	ON	ON
wide	ON	ON	OFF	OFF
wide transition	ON	ON	ON	OFF
transition	ON	ON	ON	ON

Where:

- Wide SPF: Uses wide TLVs for SPF calculation.
- Wide TLV: Encodes wide TLVs in the LSP.
- Narrow SPF: Uses narrow TLVs for SPF calculation.
- Narrow TLV: Encodes narrow TLVs in the LSP.

Use the `no` parameter to set the style to the default style, narrow.

Command Syntax

```
metric-style (narrow|wide|transition) (level-1|level-2|)
metric-style (narrow|wide) transition (level-1|level-2|)
no metric-style
```

Parameters

<code>narrow</code>	Specify the old style of TLVs with narrow metric.
<code>wide</code>	Specify the new style of TLVs to carry wider metric.
<code>transition</code>	Specify to send and accept both styles of TLVs during transition.
<code>level-1</code>	Specify the level-1 metric style.
<code>level-2</code>	Specify the level-2 metric style.
<code>transition</code>	Accept both styles of TLVs during transition

Default

By default, ISIS uses narrow metric style for level 1 and 2.

Command Mode

Router mode

Examples

```
(config)#router isis bb  
(config-router)#metric-style narrow transition
```

mpls traffic-eng

Use this command to configure MPLS Traffic Engineering feature for ISIS.

Use the `no` parameter to turn off the feature.

Note: Metric-style wide must be enabled before using this CLI.

Command Syntax

```
mpls traffic-eng (level-1|level-2)
no mpls traffic-eng (level-1|level-2)
```

Parameters

<code>level-1</code>	Specify the level-1 MPLS Traffic Engineering feature.
<code>level-2</code>	Specify the level-2 MPLS Traffic Engineering feature.

Default

If this command is not used, ISIS does not encode traffic engineering TLVs and Sub-TLVs.

Command Mode

Router mode

Examples

```
(config)#router isis bb
(config-router)#metric-style wide
(config-router)#mpls traffic-eng level-1

(config)#router isis bb
(config-router)#no mpls traffic-eng level-1
```

mpls traffic-eng router-id

Use this command to configure the traffic engineering stable IP address for a system.

Use the `no` parameter to turn off the feature.

Command Syntax

```
mpls traffic-eng router-id A.B.C.D
no mpls traffic-eng router-id
```

Parameters

A.B.C.D Specify the ISIS router-ID in an IP address format.

Default

If this command is not used, and traffic engineering is enabled, ISIS will use global router-id..

Command Mode

Router mode

Examples

```
(config)#router isis bb
(config-router)#mpls traffic-eng router-id 10.10.0.23
```

```
(config)#router isis bb
(config-router)#no mpls traffic-eng router-id
```

net

Use this command to add a Network Entity Title (NET) for the instance.

On a router running ISIS, a NET can be 8 to 20 bytes in length. The last byte is always the n-selector, and must be zero. The n-selector indicates no transport entity, and means that the packet is for the routing software of the system. The six bytes directly preceding the n-selector are the system ID. The system ID length is a fixed size and cannot be changed. The system ID must be unique throughout each area (Level 1) and throughout the backbone (Level 2).

The bytes preceding the system ID are the area ID, which can be from 1 - 13 bytes in length. By default, a maximum of three NETs per router are allowed with a different area ID but the system ID should be the same for all NETs. You can increase the number of area IDs per system ID with the `max-area-address` command.

Use the `no` parameter to remove the NET.

Command Syntax

```
net NET
no net NET
```

Parameters

NET Specify a network entity title (NET) in 1 to 13 octets (that is, XX.XXXX.XXXX.XX).

Default

By default, ISIS does not configure a NET and routing is not enabled for the interface.

Command Mode

Router mode

Applicability

This command was introduced before OcNOS version 1.3.

Example

```
#configure terminal
(config)#router isis bb
(config-router)#net 49.0000.0001.0002.0003.00
```

passive-interface

Use this command to suppress routing updates on all interfaces or on a specified interface, which puts the interfaces into passive mode.

To advertise passive prefixes in LSP, an interface must be configured with ip router isis when using "passive-interface" command. If interface is not configured with isis instance "passive-interface IFNAME" command must be used to add that interface as passive. Enabling passive interface on an ISIS enabled interface disables ISIS routing updates on the interface and makes the interface passive.

Use the `no` parameter with this command to remove interfaces from passive mode.

Note: The command `passive-interface IFNAME disable` is used to make a particular interface active after the `passive-interface` command (with no parameters) has set all interfaces as passive.

Command Syntax

```
passive-interface
passive-interface IFNAME
passive-interface IFNAME disable

no passive-interface
no passive-interface IFNAME
no passive-interface IFNAME disable
```

Parameters

IFNAME	Interface name. If this parameter is omitted, then all interfaces become passive or active.
disable	Disable passive interface.

Command Mode

Router mode

Examples

The following suppresses routing updates on a specified interface.

```
#configure terminal
(config)#router isis 100
(config-router)#passive-interface
(config-router)#passive-interface eth0 disable
```

prc-interval-exp

Use this command to configure exponential back-off delay between PRC calculations.

Use the `no` parameter to disable any set exponential back-off delay between PRC calculations.

Command Syntax

```
prc-interval-exp  
prc-interval-exp <0-2147483647> <0-2147483647>  
no prc-interval-exp
```

Parameters

- <0-2147483647> Set the minimum delay between receiving a change to PRC calculation in milliseconds.
- <0-2147483647> Set the maximum delay between receiving a change to PRC calculation in milliseconds.

Default

By default, minimum delay is 500 milliseconds and maximum delay is 50 seconds.

Command Mode

Router mode

Applicability

This command was introduced before OcNOS version 1.3.

Examples

```
(config)#router isis  
(config-router)#prc-interval-exp 100 10000  
  
(config)#router isis  
(config-router)#no prc-interval-exp
```

redistribute

Use this command to redistribute routes from another protocol into the ISIS routing table.

Use the `no` form of this command to disable redistribution.

Command Syntax

```
redistribute (kernel|connected|static|rip|ospf|bgp) {metric <0-16777215>| metric-
  type (internal|external)|level-1|level-2|level-1-2|route-map WORD}
no redistribute (kernel|connected|static|rip|ospf|bgp) {metric <0-16777215>|
  metric-type (internal|external)|level-1|level-2|level-1-2|route-map WORD}
```

Parameters

<code>kernel</code>	Redistribute kernel routes.
<code>connected</code>	Redistribute connected routes.
<code>static</code>	Redistribute static routes.
<code>rip</code>	Redistribute RIP routes.
<code>ospf</code>	Redistribute OSPF routes.
<code>bgp</code>	Redistribute BGP routes.
<code>metric</code>	Metric for redistributed routes.
<code><0-16777215></code>	IS-IS default metric.
<code>metric-type</code>	IS-IS exterior metric type for redistributed routes:
<code>internal</code>	IS-IS internal metric type.
<code>external</code>	IS-IS external metric type.
<code>level-1</code>	Redistribute routes into level 1 only.
<code>level-2</code>	Redistribute routes into level 2 only (default).
<code>level-1-2</code>	Redistribute routes into both levels.
<code>route-map</code>	Route map reference.
<code>WORD</code>	Route map name.

Default

By default, redistribution is disabled.

If no level parameter is specified, by default redistributed routes will be added in level-2 LSP. If is-type of an IS-IS instance is level-1, the level parameter must be set to level-1 for redistribute command to take effect and redistribute routes in L1 LSP.

Command Mode

For IPv4: Router mode

For IPv6: address-family ipv6 mode

Applicability

This command was introduced before OcNOS version 1.3.

Examples

```
(config)#router isis A  
(config-router)#redistribute bgp metric 12
```

redistribute isis

Use this command to redistribute reachability information from one level to the other level. If an distribute-list name is given with this command for an access list that does not exist, the routes are still redistributed.

Use the `no` form of this command to disable redistribution.

Command Syntax

```
redistribute isis level-1 into level-2
redistribute isis level-2 into level-1
redistribute isis level-1 into level-2 distribute-list WORD
redistribute isis level-2 into level-1 distribute-list WORD
no redistribute isis level-1 into level-2
no redistribute isis level-2 into level-1
```

Parameters

level-1	Specify an inter-area route from level-1.
level-2	Specify an inter-area routes from level-2.
into	Specify a level from level-n into level-m.
level-1	Specify an inter-area route into level-1.
level-2	Specify an inter-area routes into level-2.
distribute-list	Indicate the distributed-list parameter.
WORD	Specify the actual selected route.

Default

By default, ISIS redistributes selected L1 routes into L2.

Command Mode

For Ipv4: Router mode

For Ipv6: address-family ipv6 mode

Applicability

This command was introduced before OcNOS version 1.3.

Examples

```
#configure terminal
(config)#router isis bb
(config-router)#redistribute isis level-2 into level-1

(config)#router isis bb
(config-router)#redistribute isis level-2 into level-1 distribute-list new

(config)#router isis bb
(config-router)#no redistribute isis level-2 into level-1
```

redistribute isis WORD

Use this command to redistribute reachability information from one isis instance into another instance. Only one isis instance can be redistributed.

Use the `no` parameter with this command to stop redistribution.

Note: This command is not supported for address family IPv6.

Command Syntax

```
redistribute isis WORD {metric <0-16777215>| metric-type (internal | external )
|level-1|level-2|level-1-2|route-map WORD}
no redistribute isis WORD {metric <0-16777215>| metric-type (internal|external)
|level-1|level-2|level-1-2|route-map WORD}
```

Parameters

WORD	Specify an isis instance name or tag
metric	Specify the metric for redistributed routes. <0-16777215>Specify the IS-IS default metric.
metric-type	Specify the IS-IS exterior metric type for redistributed routes:
internal	Set IS-IS internal metric type.
external	Set IS-IS external metric type.
level-1	IS-IS Level-1 routes.
level-2	IS-IS Level-2 routes.
level-1-2	IS-IS Level-1 and Level-2 routes.
route-map	Specify a Route map reference.
WORD	Specify name of the route-map.

Default

By default, redistribute command is disabled.

Command Mode

Router mode

Applicability

This command was introduced before OcNOS version 1.3.

Examples

```
(config)#router isis A
(config-router)#redistribute isis B metric 12
```

router isis

Use this command to initiate an ISIS routing instance. This command starts the ISIS routing instance and enters router configuration mode. Configure at least one NET to start routing. Also, enable a particular interface with the [ip router isis](#) command.

Use the `no` parameter with this command to remove an ISIS routing instance.

Command Syntax

```
router isis WORD
no router isis WORD
```

Parameters

WORD Name that specifies an ISO routing instance tag.

Default

By default, ISIS routing instance is not configured.

Command Mode

Configure mode

Applicability

This command was introduced before OcnOS version 1.3.

Example

```
#configure terminal
(config)#router isis New
(config-router)#
```

send-lifetime

Use this command to specify the time period during which the authentication key on a key chain can be sent.

Use the `no` parameter with this command to negate this command.

Command Syntax

```
send-lifetime HH:MM:SS MONTH <01-31> <1993-2035> HH:MM:SS MONTH <01-31> <1993-2035>
send-lifetime HH:MM:SS MONTH <01-31> <1993-2035> infinite
send-lifetime HH:MM:SS MONTH <01-31> <1993-2035> duration <1-2147483646>
no send-lifetime
```

Parameters

HH:MM:SS	Specify the start time of send-lifetime in hours, minutes and seconds.
<01-31>	Specify the day of the month to start. If the day is a single-digit, the leading 0 must be added, example: 01, 02, 03, etc.
MONTH	Specify the month of the year to start as the first three letters of the month with first letter in caps, for example, Jan. (case sensitive)
<1993-2035>	Specify the year to start.
HH:MM:SS	Specify the end time of send-lifetime in hours, minutes and seconds.
<01-31>	Specify the day of the month to end. If the day is a single-digit, the leading 0 must be added, example: 01, 02, 03, etc.
MONTH	Specify the month of the year to end as the first three letters of the month with first letter in caps, for example, Jan. (case sensitive)
<1993-2035>	Specify the year to end.
duration	Indicate the duration parameter.
<1-2147483646>	Specify the actual end time duration of a key in seconds.
infinite	Specify the end time to never expire.

Applicability

No default value is specified

Command Mode

Keychain-key mode

Applicability

This command was introduced before OcnOS version 1.3.

Examples

The following example shows the setting of `send-lifetime` for `key-id 1` on the key chain named `mychain`:

```
#configure terminal
(config)#key chain mychain
(config-keychain)#key-id 1
```



```
(config-keychain-key)#send-lifetime 03:03:01 Jan 03 2004 04:04:02 Dec 06 2006
```

snmp restart isis

Use this command to restart SNMP in Intermediate System to Intermediate System (IS-IS)

Command Syntax

```
snmp restart isis
```

Parameters

None

Default

By default, snmp restart is not configured.

Command Mode

Configure mode

Applicability

This command was introduced before OcNOS version 1.3.

Examples

```
#snmp restart isis
```

spf-interval-exp

Use this command to set the minimum and maximum hold intervals between Shortest Path First (SPF) calculations.

The `spf-interval-exp` command configures the minimum and maximum interval time between the receipt of a topology change and the calculation of the SPF.

Use the `no` parameter with this command to set the minimum and maximum hold intervals to the default.

Command Syntax

```
spf-interval-exp <0-2147483647> <0-2147483647>
spf-interval-exp (level-1|level-2) <0-2147483647> <0-2147483647>
no spf-interval-exp ((level-1|level-2) |)
```

Parameters

<0-2147483647>	Specify the minimum delay between receiving a change to the SPF calculation in milliseconds. The default SPF minimum hold-time interval value is 500 milliseconds.
<0-2147483647>	Specify the maximum delay between receiving a change to the SPF calculation in milliseconds. The default SPF maximum hold-time interval value is 50 seconds.
level-1	Specify an interval for Level-1 IS.
level-2	Specify an interval for Level-2 IS.

Default

By default, ISIS uses 500 milliseconds and 50,000 milliseconds for the minimum and maximum hold intervals, respectively. The values are applied to both level-1 and level-2 if the `level` parameter is omitted.

Command Mode

Router mode

Applicability

This command was introduced before OcNOS version 1.3.

Examples

```
#configure terminal
(config)#router isis bb
(config-router)#spf-interval-exp level-1 600 60000

(config)#router isis bb
(config-router)#no spf-interval-exp level-1
```

summary-address

Use this command to configure Summary Address to summarize IPv4 reachability information.

Use the `no` parameter with this command to unconfigure the summary.

Command Syntax

```
summary-address A.B.C.D/M (level-1 |level-1-2 |level-2) (metric <1-63>|)
no summary-address A.B.C.D/M
```

Parameters

A.B.C.D/M	Specify the IPv4 prefix to be announced.
level-1	Specify the reachability information only for Level-1.
level-1-2	Specify the reachability information for both Level-1 and Level-2.
level-2	Specify the reachability information only for Level-2.
metric	Specify the metric for the summarized address.
<1-63>	Specify the metric. The default is 0.

Default

By default, ISIS does not configure the summary-address. Level must be configured along with summary-address. Metric is optional.

Command Mode

Router mode

Applicability

This command was introduced before OcNOS version 1.3.

Examples

```
#configure terminal
(config)#router isis bb
(config-router)#summary-address 10.10.0.0/16 level-1-2 metric 3

(config)#router isis bb
(config-router)#no summary-address 10.10.0.0/16
```

summary-prefix

Use this command to configure Summary Prefix to summarize IPv6 reachability information.

Use the `no` parameter with this command to unconfigure the summary.

Command Syntax

```
summary-prefix X:X::X:X/M (level-1 |level-1-2 |level-2) (metric <1-63>|)
no summary-prefix X:X::X:X/M
```

Parameters

<code>X:X::X:X/M</code>	Specify the IPv6 prefix to be announced.
<code>level-1</code>	Specify the reachability information only for Level-1.
<code>level-1-2</code>	Specify the reachability information for both Level-1 and Level-2.
<code>level-2</code>	Specify the reachability information only for Level-2.
<code>metric</code>	Specify the metric for the summarized address.
<code><1-63></code>	Specify the metric. The default is 0.

Default

By default, ISIS does not configure the summary-prefix. Level must be configured along with summary-prefix. Metric is optional.

Command Mode

Address Family IPv6 mode

Applicability

This command was introduced before OcNOS version 1.3.

Examples

```
#configure terminal
(config)#router isis 1
(config-router)#address-family ipv6
(config-router-af)#summary-prefix 2356::1/64 level-1 metric 30
```

CHAPTER 2 IS-IS Graceful Restart Commands

This chapter describes the IS-IS graceful restart commands:

- `capability restart graceful`
- `isis restart grace-period`
- `isis restart-hello-interval`
- `isis restart helper`
- `isis restart suppress-adjacency`
- `restart isis graceful`
- `restart-timer`

capability restart graceful

Use this command to enable the graceful restart capability.

Use the `no` parameter with this command to negate this command.

Command Syntax

```
capability restart graceful
no capability restart graceful
```

Parameters

NA

Default

By default, graceful restart capability is enabled.

Command Mode

Router mode

Applicability

This command was introduced before OcNOS version 1.3.

Example

The following example enables the graceful restart capability on a router.

```
#configure terminal
(config)#router isis bb
(config-router)#capability restart graceful
```

isis restart grace-period

Use this command to configure the T3 timer, the time the restarting router retains the forwarding table.

Use the `no` parameter to use the default value.

Command Syntax

```
isis restart grace-period <1-65535>
no isis restart grace-period
```

Parameters

<1-65535> Grace period in seconds.

Default

By default, ISIS uses 65535 for the period value, and the value is applied to both level-1 and level-2.

Command Mode

Configure mode

Applicability

This command was introduced before OcNOS version 1.3.

Examples

The following example enables and then disables a restart grace period at one second.

```
#configure terminal
(config)#isis restart grace-period 1

(config)#no isis restart grace-period
```

isis restart-hello-interval

Use this command to configure the T1 timer, interval of ISIS Hello packet with restart TLV.

Use the `no` parameter to use the default value.

Command Syntax

```
isis restart-hello-interval <1-65535> (level-1|level-2|)
no isis restart-hello-interval (level-1|level-2|)
```

Parameters

<1-65535>	Specify the number of seconds in the interval.
level-1	Specify the hello-interval for level-1 IHS.
level-2	Specify the hello-interval for level-1 IHS.

Default

By default, ISIS uses 3 seconds for the hello value, and the interval is applied to both level-1 and level-2.

Command Mode

Interface mode

Applicability

This command was introduced before OcNOS version 1.3.

Example

The following example enables and then disables a restart hello interval at 123 seconds for a level 1 interface.

```
#configure terminal
(config)#interface eth0
(config-if)#isis restart-hello-interval 123 level-1

(config-if)#no isis restart-hello-interval level-1
```

isis restart helper

Use this command to configure the router's helper mode capability.

Use the `no` parameter to disable the helper mode for this router.

Command Syntax

```
isis restart helper
no isis restart helper
```

Parameters

None

Default

By default, most routers are not a restart helper router.

Command Mode

Configure mode

Applicability

This command was introduced before OcNOS version 1.3.

Example

The following example enables and then disables ISIS restart helper.

```
#configure terminal
(config)#isis restart helper

(config)#no isis restart helper
```

isis restart suppress-adjacency

Use this command to enable ISIS to request that its adjacency be suppressed after the ISIS daemon process starts or restarts until the Link State Packet Database (LSPDB) synchronizes.

Use the `no` parameter to disable suppress-adjacency.

Command Syntax

```
isis restart suppress-adjacency
no isis restart suppress-adjacency
```

Parameters

None

Default

By default, ISIS does not request that its adjacency be suppressed after the ISIS daemon process starts or restarts.

Command Mode

Configure mode

Applicability

This command was introduced before OcNOS version 1.3.

Example

The following example enables and then disables ISIS restart suppress adjacency.

```
#configure terminal
(config)#isis restart suppress-adjacency

(config)#no isis restart suppress-adjacency
```

restart isis graceful

Use this command to restart the ISIS router.

Command Syntax

```
restart isis graceful (grace-period <1-65535>|)
```

Parameters

<1-65535> Grace period in seconds.

Default

By default, the ISIS router is not restarted gracefully. Default grace-period is 65535 seconds.

Command Mode

Privileged Exec mode

Applicability

This command was introduced before OcNOS version 1.3.

Example

```
#restart isis graceful grace-period 60
```

restart-timer

Use this command to restart the ISIS T2 timer. When a node comes up after graceful restart, within this time, the LSPDB sync should be completed.

Use the `no` parameter with this command to negate this command.

Command Syntax

```
restart-timer <5-65535> (level-1|level-2|)
no restart-timer (level-1|level-2|)
```

Parameters

<5-65535>	Restart time in seconds
level-1	Restart is only for Level-1.
level-2	Restart is only for Level-2.

Default

The default value is 60 seconds.

Command Mode

Router mode

Applicability

This command was introduced before OcNOS version 1.3.

Example

The following example enables and then disables the restart timer at 555 seconds for a level 2 interface.

```
#configure terminal
(config)#router isis bb
(config-router)#restart-timer 555 level-2

(config)#router isis bb
(config-router)#no restart-timer level-2
```

CHAPTER 3 IS-IS Microloop-Avoidance Commands

This chapter describes the IS-IS microloop-avoidance commands:

- `microloop-avoidance`
- `microloop-avoidance hold-timer`
- `microloop-avoidance max-fib`
- `show isis microloop-avoidance`

microloop-avoidance

Use this command to enable microloop avoidance using ordered FIB (oFIB) for an ISIS process.

Use the `no` form of this command to disable microloop avoidance for an ISIS process.

Microloop avoidance will be enabled with default hold-timer and max-fib values if it is not configured by the user:

- Default value of hold-timer is 6 seconds
- Default value for max-fib is 2 seconds

Microloop avoidance has to be enabled in conjunction with a fast reroute (FRR) mechanism such as TILFA that converts a sudden link or node failure into a non-urgent topology change by having complete repair path for all affected destinations. With microloop avoidance, the convergence will be slower compared to traditional (SPF) convergence mechanisms. So, when there is any failure of a link or a set of links that are not protected using an FRR mechanism, it is advised to use conventional SPF (faster) mode of operation to minimize packet loss during convergence/reconvergence.

Command Syntax

```
microloop-avoidance (level-1|level-2)
no microloop-avoidance (level-1|level-2)
```

Parameters

level-1	Level-1 only
level-2	Level-2 only

Defaults

N/A

Command Mode

ISIS router mode

Applicability

This command was introduced in OcNOS version 6.3.0.

Examples

```
#configure terminal
(config)#router isis 100
(config-router)#microloop-avoidance level-1
(config-router)#microloop-avoidance level-2
(config-router)#
```

```
#configure terminal
(config)#router isis 100
(config-router)#no microloop-avoidance level-1
(config-router)#no microloop-avoidance level-2
(config-router)#
```

microloop-avoidance hold-timer

Use this command to configure the hold-timer value for microloop avoidance.

Use the `no` form of this command to return to the default hold-timer value for microloop avoidance.

Hold-timer value means the time that router will wait after receiving first LSP update with a topology change, to group all related LSP updates together to process using oFIB.

Microloop avoidance has to be enabled first for the particular level before configuring the hold-timer.

Hold-timer value must be configured same across all routers in the network to get the desired results.

Command Syntax

```
microloop-avoidance hold-timer <1-60> (level-1|level-2)
no microloop-avoidance hold-timer (level-1|level-2)
```

Parameters

<1-60>	Hold-timer value in seconds
level-1	Level-1 only
level-2	Level-2 only

Defaults

Default value for hold-timer is 6 seconds

Command Mode

ISIS router mode

Applicability

This command was introduced in OcNOS version 6.3.0.

Examples

```
#configure terminal
(config)#router isis 100
(config-router)#microloop-avoidance hold-timer 3 level-1
(config-router)#microloop-avoidance hold-timer 3 level-2
(config-router)#
```

```
#configure terminal
(config)#router isis 100
(config-router)#no microloop-avoidance hold-timer level-1
(config-router)#no microloop-avoidance hold-timer level-2
(config-router)#
```

microloop-avoidance max-fib

Use this command to configure the max-fib value for microloop avoidance.

Use the `no` form of this command to return to the default max-fib value for microloop avoidance.

The max-fib value is a network-wide constant that reflects the maximum time required to update a FIB irrespective of the change required. This value will be further multiplied by the oFIB RANK to get the actual FIB update delay time.

Microloop avoidance has to be enabled first for the particular level before configuring max-fib.

Max-fib value must be configured same across all routers in the network to get the desired results.

Command Syntax

```
microloop-avoidance max-fib <1-60> (level-1|level-2)
no microloop-avoidance max-fib (level-1|level-2)
```

Parameters

<1-60>	Max-fib value in seconds
level-1	Level-1 only
level-2	Level-2 only

Defaults

Default value for max-fib is 2 seconds

Command Mode

ISIS router mode

Applicability

This command was introduced in OcNOS version 6.3.0.

Examples

```
#configure terminal
(config)#router isis 100
(config-router)#microloop-avoidance max-fib 3 level-1
(config-router)#microloop-avoidance max-fib 3 level-2
(config-router)#
```

```
#configure terminal
(config)#router isis 100
(config-router)#no microloop-avoidance max-fib level-1
(config-router)#no microloop-avoidance max-fib level-2
(config-router)#
```

show isis microloop-avoidance

Use this command to display microloop avoidance FSM states, timer values, and the oFIB route table.

Command Syntax

```
show isis microloop-avoidance (level-1|level-2|) (detail|)
```

Parameters

level-1	Display level-1 information only
level-2	Display level-2 information only
detail	Display detailed information for one or both levels

Command Mode

Privileged Exec mode

Applicability

This command was introduced in OcNOS version 6.3.0.

Example

```
PE1#sh isis microloop-avoidance
```

```
Tag 1: VRF : default
```

```
Level-1 status:
```

```
FSM State: OFIB_STABLE
```

```
Level-2 status:
```

```
FSM State: OFIB_STABLE
```

```
PE1#show isis microloop-avoidance detail
```

```
Tag 1: VRF : default
```

```
Level-1 status:
```

```
FSM State: OFIB_HOLDING_DOWN
```

```
Event type: Neighbor Down
```

```
Near end: 0000.0000.0001.00 Far end:0000.0000.0004.00
```

```
Hold-down timer running: Yes Time Remaining: 00:00:02.716
```

```
Delay timer running: No
```

```
Level-2 status:
```

```
FSM State: OFIB_STABLE
```

```
oFIB Route Table:
```

	Destination	Metric	Next-Hop	Interface	Tag
L1	3.3.3.3/32	30	10.0.0.2	xe2	0
	Src: 0000.0000.0003				
L1	4.4.4.4/32	40	10.0.0.2	xe2	0
	Src: 0000.0000.0004				
L1	30.0.0.0/24	30	10.0.0.2	xe2	0

Src: 0000.0000.0003

CHAPTER 4 IS-IS Show Commands

This chapter provides describes the IS-IS show commands:

- `show clns is-neighbors`
- `show clns neighbors`
- `show cspf rsvp forwarding-timer`
- `show debugging isis`
- `show ip isis igp-shortcut-lsp`
- `show ip isis route`
- `show ip isis route igp-shortcut`
- `show ip protocols`
- `show ip route fast-reroute`
- `show ip isis route fast-reroute`
- `show ip isis lfa-config`
- `show ipv6 isis topology`
- `show isis counter`
- `show isis database`
- `show isis interface`
- `show isis microloop-avoidance`
- `show isis spf-logs`
- `show isis topology`
- `show running-config interface isis`
- `show running-config router isis`

show clns is-neighbors

Use this command to display IS neighbor adjacencies.

Command Syntax

```
show clns is-neighbors (detail|)
show clns WORD is-neighbors (detail|)
show clns is-neighbors IFNAME (detail|)
show clns WORD is-neighbors IFNAME (detail|)
```

Parameters

detail	Detailed information.
WORD	Information for a single IS-IS area.
IFNAME	Information for a single interface.

Command Mode

Exec mode and Privileged Exec mode

Applicability

This command was introduced before OcNOS version 1.3.

Example

```
#show clns is-neighbors detail
Tag abc: VRF : default
System Id      Interface   State  Type Priority  Circuit Id
0000.0000.0003 eth1       Up     L1   64       0000.0000.0003.01
L1 Adjacency ID: 1
L2 Adjacency ID: 2
Uptime: 00:12:31
Area Address(es): 52
IP Address(es): 11.11.11.2
Level-1 Protocols Supported: IPv4
Adjacency advertisement: Advertise
#
```

[Table 4-60](#) explains the fields in the output.

Table 4-60: show clns is-neighbors output

Field	Description
Tag	Name that identifies the IS-IS area.
VRF	VRF name.
System Id	Uniquely identifies a system within an area.
Interface	Interface from which the system was learned.

Table 4-60: show clns is-neighbors output (Continued)

Field	Description
State	Adjacency state: Init: Router is an IS and is waiting for an IS-IS hello message. IS-IS regards the neighbor as not adjacent. Up: IS is considered reachable
Type	Type of adjacency: L1: Router adjacency for level 1 routing only L2: Router adjacency for level 2 only L1L2: Router adjacency for level 1 and level 2 routing
Priority	IS-IS priority that the respective neighbor is advertising. The highest priority neighbor is elected the designated IS-IS router for the interface.
Circuit Id	Number that the router uses to uniquely identify its IS-IS interface. When the interface is attached to a broadcast network, the Circuit ID is concatenated with System ID of the designated router for the interface.
Adjacency ID	Adjacency identifier.
Uptime	How long the adjacency has existed.
Area Addresses	Area addresses associated with the intermediate-system adjacencies.
IPv4/IPv6 address(es)	IP addresses of the ES or IS.
Protocols Supported	IPv4 and/or IPv6.
Adjacency advertisement	Restart: Suppress or Advertise.

show clns neighbors

Use this command to display ES and IS neighbor adjacencies.

Command Syntax

```
show clns neighbors (detail|)
show clns WORD neighbors (detail|)
show clns neighbors IFNAME (detail|)
show clns WORD neighbors IFNAME (detail|)
```

Parameters

detail	Detailed information for all interfaces.
WORD	Information for a single IS-IS area.
IFNAME	Information for a single interface.

Command Mode

Exec mode, Privileged Exec mode

Applicability

This command was introduced before OcNOS version 1.3.

Example

```
#show clns neighbors detail

Tag abc: VRF : default
System Id      Interface  SNPA                State  Holdtime  Type  Protocol
0000.0000.0003 eth1      0800.277b.411d      Up     6         L1   IS-IS
L1 Adjacency ID: 1
L2 Adjacency ID: 2
Uptime: 00:15:58
Area Address(es): 52
IP Address(es): 11.11.11.2
Level-1 Protocols Supported: IPv4
Adjacency advertisement: Advertise
#
```

[Table 4-61](#) explains the fields in the output.

Table 4-61: show clns neighbors output

Field	Description
Tag	Name that identifies the IS-IS area.
VRF	VRF name.
System Id	Uniquely identifies a system within an area.
Interface	Interface from which the system was learned.

Table 4-61: show clns neighbors output (Continued)

Field	Description
SNPA	SubNetwork Point of Attachment (SNPA): MAC address of the next-hop.
State	Adjacency state: Init: Router is an IS and is waiting for an IS-IS hello message. IS-IS regards the neighbor as not adjacent. Up: ES or IS is considered reachable
Holdtime	Number of seconds before this adjacency entry times out.
Type	Type of adjacency: L1: Router adjacency for level 1 routing only L2: Router adjacency for level 2 only L1L2: Router adjacency for level 1 and level 2 routing
Protocol	Protocol through which the adjacency was learned.
Adjacency ID	Adjacency identifier.
Uptime	How long the adjacency has existed.
Area Addresses	Area addresses associated with the intermediate-system adjacencies.
IPv4/IPv6 address(es)	IP addresses of the ES or IS.
Topology	IPv4 and/or IPv6.
Protocols Supported	IPv4 and/or IPv6.
Adjacency advertisement	Restart: Suppress or Advertise.

show cspf rsvp forwarding-timer

This command displays the information of Graceful Restart capable RSVP client to ISIS or OSPF, CSPF that are currently shutdown.

Command Syntax

```
show cspf rsvp forwarding-timer
```

Parameters

None

Command Mode

Privileged Exec modes

Applicability

This command was introduced before OcNOS version 5.0.

Example

```
#sh cspf rsvp forwarding-timer
CSPF Server Protocol-Name GR-State Time Remaining (sec) Disconnected-time
ISIS RSVP ACTIVE 88 2021/08/18 04:49:23
#
```

show debugging isis

Use this command to display the status of the debugging of the ISIS system.

Command Syntax

```
show debugging isis
```

Parameters

None

Command Mode

Exec mode, Privileged Exec mode

Applicability

This command was introduced before OcNOS version 1.3.

Example

```
#show debugging isis
IS-IS debugging status:
IS-IS Interface FSM debugging is on
IS-IS Neighbor FSM debugging is on
IS-IS events debugging is on
IS-IS PDU debugging is on
IS-IS lsp debugging is on
IS-IS spf debugging is on
IS-IS NSM debugging is on
IS-IS Check-sum debugging is on
IS-IS Authentication debugging is on
IS-IS Protocol-error debugging is on
IS-IS Local Updates debugging is on
IS-IS Hello debugging is on
IS-IS BFD debugging is on
IS-IS MPLS debugging is on
IS-IS RIB debugging is on
#
```

show ip isis igp-shortcut-lsp

Use this command to display IS-IS shortcut MPLS label-switched paths (LSPs).

Command Syntax

```
show ip isis (WORD|) igp-shortcut-lsp
```

Parameters

WORD Information for a single IS-IS area.

Command Mode

Exec mode, Privileged Exec mode

Applicability

This command was introduced before OcnOS version 1.3.

Example

```
#show ip isis igp-shortcut-lsp  
#
```

[Table 4-62](#) explains the fields in the output.

Table 4-62: show ip isis igp-shortcut-lsp output

Field	Description
Tunnel-endpoint	Tunnel endpoint address.
Tunnel-id	Tunnel identifier.
Tunnel-metric	Tunnel metric.
active/inactive	Whether the tunnel is active or inactive.

show ip isis route

Use this command to display IS-IS routing table for IPv4.

Command Syntax

```
show ip isis (WORD|) route
```

Parameters

WORD Information for a single IS-IS area.

Command Mode

Exec mode, Privileged exec mode

Applicability

This command was introduced before OcNOS version 1.3.

Example

```
#show ip isis route
Codes: C - connected, E - external, L1 - IS-IS level-1, L2 - IS-IS level-2
       ia - IS-IS inter area, D - discard, e - external metric
Tag xyz: VRF : default
      Destination      Metric      Next-Hop      Interface      Tag
L1      10.10.10.0/24    20          11.11.11.1    eth1           0
C       11.11.11.0/24    10          -             eth1           0
#
```

Header

Each entry in this table has a code preceding it, indicating the source of the routing entry. [Table 4-63](#) shows these codes.

[Table 4-63](#) explains the fields in the output.

Table 4-63: route codes and modifiers

Code	Description
C	Routes directly connected to the local device that were not distributed via IGP. The device inherently knows of these networks, so there is no need to learn about these from another device. Connected routes are preferred over routes for the same network learned from other routing protocols.
E	External.
L1	IS-IS level-1.
L2	IS-IS level-2.
ia	IS-IS inter area (leaked).

Table 4-63: route codes and modifiers (Continued)

Code	Description
D	Discard route. A device performing summarization installs a discard route in its routing table for the summarized network range to prevent routing loops where portions of the summarized network range do not have a more specific route in the RIB. External and internal discard route entries are installed by default. During route summarization, routing loops can happen if data sent to a nonexisting network appears to be a part of the summary, and the router doing the summarization has a less specific route that points back to the sending router for the network.
e	External metric. Routes can be redistributed into IS-IS with either internal or external metrics (internal is the default). The metric type determines the base metric value of the redistributed routes. The value of an internal metric is lower than 64. The value of an external metric is 64-128.

Route Entry Fields

[Table 4-64](#) shows the route entry fields.

Table 4-64: route entry fields

Field	Description
Code	As explained in Table 4-63 .
Tag	Name that identifies the IS-IS area.
VRF	VRF name.
Destination	IP address of the remote network.
Metric	ISIS metric used for SPF calculation (1-63). When a route is imported into the IS-IS network without a specified metric, IS-IS uses 10 for the metric value and the value is applied to both level-1 and level-2.
Next-Hop	This route is available through the next hop router located at this IP address. This identifies exactly where packets go when they match this route.
Interface	Interface used to get to the next-hop address for this route.
Tag	Name that identifies the IS-IS area.

show ip isis route igp-shortcut

Use this command to display the IS-IS IGP shortcut routing table.

Command Syntax

```
show ip isis (WORD|) route igp-shortcut
```

Parameters

WORD Information for an IS-IS area.

Command Mode

Exec mode, Privileged exec mode

Applicability

This command was introduced before OcNOS version 1.3.

Example

```
#show ip isis new_isis route igp-shortcut
Codes: C - connected, E - external, L1 - IS-IS level-1, L2 - IS-IS level-2
ia - IS-IS inter area, D - discard, e - external metric
```

```
Tag aa: VRF : default
Destination          Metric          Tunnel-ID          Tunnel-End-Point
#
```

Header

Each entry in this table has a code preceding it, indicating the source of the routing entry. [Table 4-65](#) shows these codes.

Table 4-65: Route codes and modifiers

Code	Description
C	Routes directly connected to the local device that were not distributed via IGP. The device inherently knows of these networks, so there is no need to learn about these from another device. Connected routes are preferred over routes for the same network learned from other routing protocols.
E	External.
L1	IS-IS level-1.
L2	IS-IS level-2.
ia	IS-IS inter area (leaked).

Table 4-65: Route codes and modifiers (Continued)

Code	Description
D	Discard route. A device performing summarization installs a discard route in its routing table for the summarized network range to prevent routing loops where portions of the summarized network range do not have a more specific route in the RIB. External and internal discard route entries are installed by default. During route summarization, routing loops can happen if data sent to a nonexisting network appears to be a part of the summary, and the router doing the summarization has a less specific route that points back to the sending router for the network.
e	External metric. Routes can be redistributed into IS-IS with either internal or external metrics (internal is the default). The metric type determines the base metric value of the redistributed routes. The value of an internal metric is lower than 64. The value of an external metric is 64-128.

Route Entry Fields

[Table 4-66](#) shows the route entry fields.

Table 4-66: Route entry fields

Field	Description
Code	As explained in Table 4-63 .
Tag	Name that identifies the IS-IS area.
VRF	VRF name.
Destination	IP address.
Metric	Tunnel metric.
Tunnel-ID	Tunnel identifier.
Tunnel-End-Point	Tunnel endpoint address.

show ip protocols

Use this command to display IP process parameters and statistics.

Command Syntax

```
show ip protocols
show ip protocols isis
```

Parameters

None

Command Mode

Exec mode, Privileged exec mode

Applicability

This command was introduced before OcNOS version 1.3.

Example

```
#show ip protocols
Routing Protocol is "isis 1 "
Redistributing:
Area Address(es): 52
Distance : (default is 115)
#
```

[Table 4-67](#) explains the output fields.

Table 4-67: show ip protocols output

Field	Description
Routing Protocol	"isis" and the name that identifies the IS-IS area.
Redistributing	Protocols being redistributed (such as RIP, OSPF, or BGP), including metric, metric type (internal or external), and route map.
redistribute isis	Whether redistributing IS-IS level-1 into level-2 and vice versa.
Area Address	Network address of the areas into which the routing process is injecting routes.
Distance: (default is 115)	Administrative distance.

show ip route fast-reroute

Use this command to display Loop Free Alternate Fast Reroute (LFA FRR) routes.

Command Syntax

```
show ip route fast-reroute
```

Parameters

None

Command Mode

Exec mode, Privileged exec mode

Applicability

This command was introduced before OcNOS version 3.0.

Example

```
#show ip route fast-reroute
Codes: K - kernel, C - connected, S - static, R - RIP, B - BGP
O - OSPF, IA - OSPF inter area
N1 - OSPF NSSA external type 1, N2 - OSPF NSSA external type 2 E1 - OSPF
external type 1, E2 - OSPF external type 2
i - IS-IS, L1 - IS-IS level-1, L2 - IS-IS level-2, ia - IS-IS inter area ,p -
stale info
* - candidate default

IP Route Table for VRF "default"
i L140.40.40.0/24 [115/10] via 10.10.10.142, eth1, 00:00:50
[FRR-NH] via 30.30.30.144, eth3

i L150.50.50.0/24 [115/15] via 20.20.20.143, eth2, 00:00:50
[FRR-NH] via 10.10.10.142, eth1

i L160.60.60.0/24 [115/15] via 10.10.10.142, eth1, 00:00:50
[FRR-NH] via 20.20.20.143, eth2
```

show ip isis route fast-reroute

Use this command to display Loop Free Alternate Fast Reroute (LFA FRR) route information and interfaces on which LFA FRR is disabled.

Command Syntax

```
show ip isis (WORD|) route fast-reroute
```

Parameters

WORD Routing area tag.

Command Mode

Exec mode, Privileged exec mode

Applicability

This command was introduced before OcnOS version 3.0.

Example

```
#show ip route fast-reroute
Codes: K - kernel, C - connected, S - static, R - RIP, B - BGP
O - OSPF, IA - OSPF inter area
N1 - OSPF NSSA external type 1, N2 - OSPF NSSA external type 2 E1 - OSPF external type
1, E2 - OSPF external type 2
i - IS-IS, L1 - IS-IS level-1, L2 - IS-IS level-2, ia - IS-IS inter area ,p - stale info
* - candidate default

IP Route Table for VRF "default"
i L140.40.40.0/24 [115/10] via 10.10.10.142, eth1, 00:00:50
[FRR-NH] via 30.30.30.144, eth3

i L150.50.50.0/24 [115/15] via 20.20.20.143, eth2, 00:00:50
[FRR-NH] via 10.10.10.142, eth1

i L160.60.60.0/24 [115/15] via 10.10.10.142, eth1, 00:00:50
[FRR-NH] via 20.20.20.143, eth2
```

show ip isis lfa-config

Use this command to display the Loop Free Alternate Fast Reroute (LFA FRR) tie-break preferences for protection types and the termination hold-on timer.

Command Syntax

```
show ip isis (WORD|) lfa-config (level-1|level-2)
```

Parameters

WORD Routing area tag.

level-1 Level 1 only.

level-2 Level 2 only

Command Mode

Exec mode, Privileged exec mode

Applicability

This command was introduced before OcNOS version 3.0.

Example

```
#show ip isis lfa-config level-1
```

```
TIE-Breaker           Preference values
-----
Primary Path:         20
Link Protecting:      30
Node Protecting:      60
Broadcast Interface Disjoint: 70
Secondary Path:       0
Downstream Path:      0
```

Termination Hold On Interval : 1000 ms

show ipv6 isis topology

Use this command to display IPv6 paths to Intermediate Systems.

Command Syntax

```
show ipv6 isis topology (level-1|level-2|)
show ipv6 isis WORD topology (level-1|level-2|)
```

Parameters

WORD	Display information for specified instance.
level-1	Display the path to all level-1 routers in the area.
level-2	Display the path to all level-2 routers in the domain.

Command Mode

Exec mode, Privileged Exec mode

Applicability

This command was introduced before OcNOS version 1.3.

Example

```
#show ipv6 isis topology

Tag abc: VRF : default
IS-IS paths to level-1 routers
System Id      Metric      Next-Hop      Interface      SNPA
000F.0000.0001  --
000F.0000.0002  10          000F.0000.0002 eth2           0006.5B0E.D27D

IS-IS paths to level-2 routers
System Id      Metric      Next-Hop      Interface      SNPA
0000.0000.0001  10          0000.0000.0001 eth2           0000.0CFA.F002
```

[Table 4-68](#) explains the output fields.

Table 4-68: show ipv6 isis topology output

Field	Description
Tag	Name that identifies the IS-IS area.
VRF	VRF name.
IS-IS paths to level-n routers	Each IS-IS level has a section with topology information.
System Id	Uniquely identifies a system within an area.
Metric	ISIS metric used for SPF calculation (1-63).
Next-Hop	This route is available through the next hop router located at this IP address.

Table 4-68: show ipv6 isis topology output

Field	Description
Interface	Interface from which the system was learned.
SNPA	SubNetwork Point of Attachment (SNPA): MAC address of the device.

show isis counter

Use this command to display the MIB variables used to construct routing tables for IP networks for IS-IS as defined in RFC 4444.

Command Syntax

```
show isis counter
```

Parameters

None

Command Mode

Exec mode, Privileged exec mode

Applicability

This command was introduced before OcNOS version 1.3.

Example

```
#show isis counter
Tag abc: VRF : default
IS-IS Level-1 isisSystemCounterEntry:
isisSysStatCorrLSPs: 0
isisSysStatAuthTypeFails: 0
isisSysStatAuthFails: 0
isisSysStatLSPDbaseOloads: 0
isisSysStatManAddrDropFromAreas: 0
isisSysStatAttmptToExMaxSeqNums: 0
isisSysStatSeqNumSkips: 0
isisSysStatOwnLSPPurges: 0
isisSysStatIDFieldLenMismatches: 0
isisSysStatMaxAreaAddrMismatches: 0
isisSysStatPartChanges: 0
isisSysStatSPFRuns: 7
isisSysStatPCRRuns: 0

IS-IS Level-2 isisSystemCounterEntry:
isisSysStatCorrLSPs: 0
isisSysStatAuthTypeFails: 0
isisSysStatAuthFails: 0
isisSysStatLSPDbaseOloads: 0
isisSysStatManAddrDropFromAreas: 0
isisSysStatAttmptToExMaxSeqNums: 0
isisSysStatSeqNumSkips: 0
isisSysStatOwnLSPPurges: 0
isisSysStatIDFieldLenMismatches: 0
isisSysStatMaxAreaAddrMismatches: 0
isisSysStatPartChanges: 0
isisSysStatSPFRuns: 3
isisSysStatPCRRuns: 0
#
```

show isis database

Use this command to display link-state database (LSDB) database information. The LSDB is the core of IS-IS routing. All link-state information advertised by neighbors in the same area is stored in the LSDB.

Command Syntax

```
show isis database
show isis database (detail|verbose)
show isis database (detail|verbose) WORD
show isis database (detail|verbose) WORD (level-1|level-2)
show isis database (detail|verbose) (level-1|level-2)
show isis database (detail|verbose) (level-1|level-2) WORD
show isis database WORD
show isis database WORD (level-1|level-2)
show isis database WORD (level-1|level-2) (detail|verbose)
show isis database WORD (detail|verbose)
show isis database WORD (detail|verbose) (level-1|level-2)
show isis database (level-1|level-2)
show isis database (level-1|level-2) (detail|verbose)
show isis database (level-1|level-2) (detail|verbose) WORD
show isis database (level-1|level-2) WORD
show isis database (level-1|level-2) WORD (detail|verbose)
```

Parameters

detail	Detailed information.
verbose	Verbose information.
WORD	Link-state packet (LSP) identifier in the form of XXXX.XXXX.XXXX.XX-XX.
level-1	IS-IS level-1.
level-2	IS-IS level-2.

Command Mode

Exec mode, Privileged exec mode

Applicability

This command was introduced before OcNOS version 1.3.

Example

```
#show isis database detail
Area bb:
IS-IS Level-1 Link State Database:
LSPID          LSP Seq Num  LSP Checksum  LSP Holdtime  ATT/P/OL
000F.0000.0001.00-00* 0x00000007  0xE15E        1188          1/0/0
Area Address: 49.000F
```



```

NLPID:          0xCC
IP Address:     10.10.12.97
Metric: 10      IP 10.10.12.0 255.255.255.0
Metric: 10      IS 000F.0000.0001.02
000F.0000.0001.02-00* 0x00000003 0x3C66          1026          1/0/0
Metric: 0       IS 000F.0000.0001.00
Metric: 0       IS 000F.0000.0002.00
000F.0000.0002.00-00 0x00000003 0x8C4B          1025          1/0/0
Area Address: 49.000F
NLPID:          0xCC
Hostname:       isisd@redhat
IP Address:     10.10.12.94
Metric: 10      IP 10.10.12.0 255.255.255.0
Metric: 10      IS 000F.0000.0001.02
#

```

Table 4-69 explains the output fields.

Table 4-69: show isis database output

Field	Description
Tag	Name that identifies the IS-IS area.
VRF	VRF name.
IS-IS Level-n Link State Database	Each IS-IS level has a section with Link-State Packet (LSP) information.
LSPID	<p>Link-state packet identifier in the form of XXXX.XXXX.XXXX.XX-XX.</p> <p>The first six octets ("XXXX.XXXX.XXXX") are the system identifier of the router that originated the LSP. The next octet is the pseudonode identifier:</p> <ul style="list-style-type: none"> When this octet is nonzero, the LSP describes links from a designated router (pseudonode) that creates and floods an LSP that describes all systems attached to the network. This mechanism is similar to a router link-state advertisement (LSA) in OSPF. When this octet is zero, the LSP is from a nonpseudonode which describes the state of the originating router. <p>The last octet is the LSP number. If the value is 0x00, the entire LSP was carried in one LSP. If there is more data than can fit in a single LSP, the LSP is divided into multiple LSP fragments and each fragment has a different LSP number.</p> <p>An asterisk (*) means the LSP originated on the system where the command was given.</p>
LSP Seq Num	LSP sequence number.
LSP Checksum	LSP checksum.
LSP Holdtime	Amount of time the LSP remains valid (in seconds). An LSP hold time of zero means the LSP was purged and is being removed from the link-state database (LSDB) of all routers. The value indicates how long the purged LSP will stay in the LSDB before being completely removed.
ATT	<p>Attached bit. A Level-2 IS indicates its attachment to other areas by setting its attached bit in its Level-1 LSP 0. In other words, this is only set for inter-area routes.</p> <p>Level 1-only routers and Level 1-2 routers that have lost connection to other Level 2 routers will use the attach bit to find the closest Level-2 router. They will point a default route to the closest Level-2 router.</p>

Table 4-69: show isis database output

Field	Description
P	Partition repair. A Level-1 area can become partitioned; this bit means the partition can be repaired via use of Level-2 routes.
OL	Overload bit. Determines whether the IS is congested. When the overload-bit is set in an LSP, other routers will not use this router as a transit router during SPF calculation. Only packets for destinations directly connected to the overloaded router will be sent to this router.

This command also displays information about the IS-IS TLVs in [Table 4-70](#) if present in an LSP. For more about the TLV information, search for “IS-IS TLV Codepoints” on the Internet, check ISO/IEC 10589:2002(E), or other standard mentioned in [Table 4-70](#).

Table 4-70: IS-IS TLV Codepoints

IS-IS TLV Codepoint	Description	Standard
1	Area Addresses	ISO 10589
2	IIS Neighbors	ISO 10589
3	ES Neighbors	ISO 10589
10	Authentication	ISO 10589, RFC 6233
22	Extended IS reachability	RFC 5305
128	IP internal reachability	RFC 1195, RFC 5302
129	Protocols supported	RFC 1195
130	IP external reachability	RFC 1195, RFC 5302
132	IP interface address	RFC 1195
134	Traffic engineering router ID	RFC 5305
135	Extended IP reachability	RFC 5305
137	Host name	RFC 5301, RFC 6233
222	Multi IS reachability	RFC 5120
229	Multi topology	RFC 5120
232	IPv6 interface address	RFC 5308
235	Multi IPv4 reachability	RFC 5120
236	IPv6 reachability	RFC 5308
237	Multi IPv6 reachability	RFC 5120

show isis interface

Use this command to display detailed interface information.

Command Syntax

```
show isis interface
show isis interface IFNAME
show isis interface counter
```

Parameters

IFNAME	Interface name.
counter	Interface counters.

Command Mode

Exec mode, Privileged exec mode

Applicability

This command was introduced before OcNOS version 1.3.

Example

```
>show isis interface
eth2 is up, line protocol is up
Routing Protocol: IS-IS (abc)
Network Type: Broadcast
Circuit Type: level-2
Local circuit ID: 0x01
Extended Local circuit ID: 0x00000004
Local SNPA: 0800.2731.a9a0
IP interface address:
10.10.10.1/24
IPv6 interface address:
fe80::a00:27ff:fe31:a9a0/64
Level-2 Metric: 10/10, Priority: 64, Circuit ID: 0000.0000.0001.01
Number of active level-2 adjacencies: 0
Level-2 LSP MTU: 1492
Next IS-IS LAN Level-2 Hello in 9 seconds
eth1 is up, line protocol is up
Routing Protocol: IS-IS (abc)
Network Type: Broadcast
Circuit Type: level-1
Local circuit ID: 0x02
Extended Local circuit ID: 0x00000003
Local SNPA: 0800.2714.e7f8
IP interface address:
11.11.11.1/24
IPv6 interface address:
fe80::a00:27ff:fe14:e7f8/64
Level-1 Metric: 10/10, Priority: 64, Circuit ID: 0000.0000.0003.01
Number of active level-1 adjacencies: 1
Level-1 LSP MTU: 1492
```

```

Next IS-IS LAN Level-1 Hello in 5 seconds

>show isis interface eth1
eth1 is up, line protocol is up
Routing Protocol: IS-IS ((null))
Network Type: Broadcast
Circuit Type: level-1
Local circuit ID: 0x02
Extended Local circuit ID: 0x00000003
Local SNPA: 0800.27e3.0e64
IP interface address:
30.0.0.1/24
IPv6 interface address:
fe80::a00:27ff:fee3:e64/64
LDP-ISIS Sync Configured
Holddown timer = 100 seconds, Remaining time = 90 seconds
Level-1 Metric: 63/16777214, Priority: 64, Circuit ID: 0000.0000.0001.02
Number of active level-1 adjacencies: 1
Level-1 LSP MTU: 1492
Next IS-IS LAN Level-1 Hello in 1 seconds

```

Table 4-71 explains the output fields.

Table 4-71: show isis interface

Field	Description
IFNAME is up, line protocol is up/down	Whether the interface is up or down
Routing Protocol	"IS-IS" and the name that identifies the IS-IS instance.
Network Type	<ul style="list-style-type: none"> • Broadcast • Point-to-Point • Loopback
Circuit Type	Whether the interface is configured for: <ul style="list-style-type: none"> • Local routing: level-1 • Area routing: level 2 • Local and area routing: level-1-2
Local circuit ID	Local circuit identifier assigned when interface is created. Each IS-IS interface is assigned a circuit identifier to identify the interface within the link-state database. If the interface is attached to a multiaccess network, the circuit ID is concatenated with the system ID of the designated IS. This is called the pseudonode ID.
Extended Local circuit ID	Interface index.
Local SNPA	SubNetwork Point of Attachment: for broadcast networks, MAC address.
IP interface address	IPv4 addresses assigned to IS-IS interface.
IPv6 interface address	IPv6 addresses assigned to IS-IS interface.
LDP-ISIS Sync Configured	LDP IS-IS synchronization is enabled.

Table 4-71: show isis interface (Continued)

Field	Description
Holddown timer	Delay for notifications of LDP convergence to IS-IS
Remaining time	Remaining LDP convergence hold time in seconds.
Holddown timer not configured	The LDP convergence holddown timer has not been set.
Level-1 Metric	Interface metric value; used for SPF calculation.
Priority	Priority for designated IS election.
Circuit ID	Unique ID assigned to a circuit internally.
Number of active level-1 adjacencies	Number of adjacencies formed with a neighboring router.
Level-1 LSP MTU	Maximum transmission unit: maximum transmission size for a packet on this interface.
Level-2 Metric	Interface metric value; used for SPF calculation.
Priority	Priority for designated IS election.
Circuit ID	Unique ID assigned to a circuit internally.
Number of active level-2 adjacencies	Number of adjacencies formed with a neighboring router.
Level-2 LSP MTU	Maximum transmission unit: maximum transmission size for a packet on this interface.
Next IS-IS LAN Level-1 Hello	For broadcast networks, when the next IS hello will be sent on this interface.
Next IS-IS LAN Level-2 Hello	For broadcast networks, when the next IS hello will be sent on this interface.
Next IS-IS Hello in	For point-to-point networks, when the next IS hello will be sent on this interface.
Bandwidth	Traffic engineering: interface bandwidth.
Maximum reservable bandwidth	Traffic engineering: maximum reservable interface bandwidth.
Available bandwidth at priority	Traffic engineering: available interface bandwidth at priority.
Bidirectional Forwarding Detection is disabled/enabled/configured	BFD state

show isis microloop-avoidance

Use this command to display microloop avoidance FSM states, timer values, and the oFIB route table.

Command Syntax

```
show isis microloop-avoidance (level-1|level-2|) (detail|)
```

Parameters

level-1	Display level-1 information only
level-2	Display level-2 information only
detail	Display detailed information for one or both levels

Command Mode

Privileged Exec mode

Applicability

This command was introduced in OcNOS version 6.3.0.

Example

```
PE1#sh isis microloop-avoidance
```

```
Tag 1: VRF : default
```

```
Level-1 status:
```

```
FSM State: OFIB_STABLE
```

```
Level-2 status:
```

```
FSM State: OFIB_STABLE
```

```
PE1#show isis microloop-avoidance detail
```

```
Tag 1: VRF : default
```

```
Level-1 status:
```

```
FSM State: OFIB_HOLDING_DOWN
```

```
Event type: Neighbor Down
```

```
Near end: 0000.0000.0001.00 Far end:0000.0000.0004.00
```

```
Hold-down timer running: Yes Time Remaining: 00:00:02.716
```

```
Delay timer running: No
```

```
Level-2 status:
```

```
FSM State: OFIB_STABLE
```

```
oFIB Route Table:
```

	Destination	Metric	Next-Hop	Interface	Tag
L1	3.3.3.3/32	30	10.0.0.2	xe2	0
	Src: 0000.0000.0003				
L1	4.4.4.4/32	40	10.0.0.2	xe2	0
	Src: 0000.0000.0004				
L1	30.0.0.0/24	30	10.0.0.2	xe2	0

Src: 0000.0000.0003

show isis spf-logs

Use this command to display the Shortest Path First (SPF) related information. It also display Partial Route Calculation (PRC) related information only when prc-interval-exp is enabled.

Command Syntax

```
show isis (WORD|) spf-logs (level-1|level-2|level-1-2)
```

Parameters

WORD	Routing area tag.
level-1	Level 1 only.
level-2	Level 2 only.
level-1-2	Level 1-2

Command Mode

Exec mode, Privileged exec mode

Applicability

This command was introduced before OcNOS version 3.0.

Example

```
#show isis spf-logs level-1
Tag 1: VRF : default
Level-1 spf logs:
Next SPF is not scheduled yet
SPF schedule delay min 0 secs 500 msec
SPF schedule delay max 50 secs 0 msec
SPF algorithm executed 5 times
SPF algorithm last executed 00:05:06.106 ago

PRC logs:
Next PRC is not scheduled yet
PRC schedule delay min 16 secs 0 msec
PRC schedule delay max 65 secs 0 msec
PRC algorithm executed 2 times
PRC algorithm last executed 00:03:58.256 ago
```

show isis topology

Use this command to display paths to Intermediate Systems.

Command Syntax

```
show isis topology (level-1|level-2|)
show isis WORD topology (level-1|level-2|)
```

Parameters

WORD	Display information for specified instance.
level-1	Display the path to all level-1 routers in the area.
level-2	Display the path to all level-2 routers in the domain.

Command Mode

Exec mode, Privileged Exec mode

Applicability

This command was introduced before OcNOS version 1.3.

Example

```
#show isis topology

Tag abc: VRF : default
IS-IS paths to level-1 routers
System Id      Metric      Next-Hop      Interface      SNPA
000F.0000.0001  --
000F.0000.0002  10          000F.0000.0002 eth2           0006.5B0E.D27D

IS-IS paths to level-2 routers
System Id      Metric      Next-Hop      Interface      SNPA
0000.0000.0001  10          0000.0000.0001 eth2           0000.0CFA.F002
```

[Table 4-72](#) explains the output fields.

Table 4-72: show isis topology output

Field	Description
Tag	Name that identifies the IS-IS area.
VRF	VRF name.
IS-IS paths to level-n routers	Each IS-IS level has a section with topology information.
System Id	Uniquely identifies a system within an area.
Metric	ISIS metric used for SPF calculation (1-63).
Next-Hop	This route is available through the next hop router located at this IP address.

Table 4-72: show isis topology output

Field	Description
Interface	Interface from which the system was learned.
SNPA	SubNetwork Point of Attachment (SNPA): MAC address of the device.

show running-config interface isis

Use this command to display the ISIS interface configuration.

Command Syntax

```
show running-config interface IFNAME isis
```

Parameters

IFNAME Interface name.

Command Mode

Exec mode

Applicability

This command was introduced before OcnOS version 1.3.

Example

```
#show running-config interface eth0 isis
!
interface eth0
  isis tag 500 level-1
!
```

show running-config router isis

Use this command to display the ISIS router configuration.

Command Syntax

```
show running-config router isis
```

Parameters

None

Command Mode

Exec mode

Applicability

This command was introduced before OcNOS version 1.3.

Example

```
(config-router)#show running-config router isis
!  
router isis 1  
passive-interface eth1  
!
```

Routing Information Protocol Command Reference

CHAPTER 1 Routing Information Protocol Commands

This chapter provides an alphabetized reference for each of the Routing Information Protocol (RIP) commands, which support IPv4. It includes the following commands:

- `accept-lifetime`
- `cisco-metric-behavior`
- `clear ip rip route`
- `clear ip rip route vrf NAME`
- `clear ip rip statistics`
- `debug rip`
- `default-information originate`
- `default-metric`
- `distance`
- `distribute-list`
- `ip rip authentication key-chain`
- `ip rip authentication mode`
- `ip rip authentication string`
- `ip rip receive-packet`
- `ip rip receive version`
- `ip rip send-packet`
- `ip rip send version`
- `ip rip split-horizon`
- `key-id`
- `key chain`
- `key-string`
- `key-string encrypted`
- `maximum-prefix`
- `neighbor`
- `network`
- `offset-list`
- `passive-interface`
- `recv-buffer-size`
- `redistribute`
- `route`
- `router rip`
- `send-lifetime`
- `show debugging rip`

- `show ip protocols rip`
- `show ip rip`
- `show ip rip interface`
- `show ip rip statistics`
- `snmp restart rip`
- `timers basic`
- `version`

accept-lifetime

Use this command to specify the time period during which the authentication key on a key chain is received as valid.

Use the `no` option with this command to disable it.

See [Appendix A, Routing Information Protocol Authentication](#) for information on how this command is related to the other authentication commands.

Command Syntax

```
accept-lifetime HH:MM:SS MONTH <01-31> <1993-2035> HH:MM:SS MONTH <01-31> <1993-2035>
accept-lifetime HH:MM:SS MONTH <01-31> <1993-2035> infinite
accept-lifetime HH:MM:SS MONTH <01-31> <1993-2035> duration <1-2147483646>
no accept-lifetime
```

Parameters

HH:MM:SS	Specify the start time of accept-lifetime in hours, minutes and seconds.
<01-31>	Specify the day of the month to start. If the day is a single-digit, the leading 0 must be added, example: 01, 02, 03, etc.
MONTH	Specify the month of the year to start as the first three letters of the month with first letter in upper case, for example, Jan. (case sensitive).
<1993-2035>	Specify the year to start.
HH:MM:SS	Specify the time when accept-lifetime expires in hours, minutes and seconds.
<01-31>	Specify the day of the month to end. If the day is a single-digit, the leading 0 must be added, example: 01, 02, 03, etc.
MONTH	Specify the month of the year to end as the first three letters of the month with first letter in caps, for example, Jan. (case sensitive).
<1993-2035>	Specify the year to expire.
duration	Specify the duration of the key in seconds <1-2147483646>.
infinite	Specify the end time to never expire.

Default

None

Command Mode

Keychain-key mode

Applicability

This command was introduced before OcNOS version 1.3.

Examples

The following example shows the setting of accept-lifetime for `key-id 1` on the key chain named `mychain`.

```
#configure terminal
(config)#key chain mychain
```

```
(config-keychain)#key-id 1  
(config-keychain-key)#accept-lifetime 03:03:01 Dec 30 2004 04:04:02 Oct 06  
2006
```

```
(config)#key chain mychain  
(config-keychain)#key-id 1  
(config-keychain-key)#no accept-lifetime
```

cisco-metric-behavior

Use this command to enable the metric update consistent with Cisco.

Use either the `no` or `disable` parameter with this command to disable this feature.

Command Syntax

```
cisco-metric-behavior (enable|disable)
no cisco-metric-behavior
```

Parameters

<code>enable</code>	Enable updating the metric consistent with Cisco.
<code>disable</code>	Disable updating the metric consistent with Cisco.

Default

By default, the Cisco metric-behavior is disabled.

Command Mode

Router mode

Applicability

This command was introduced before OcNOS version 1.3.

Example

This example shows how to enable the metric update behavior to be consistent with Cisco in the Router mode.

```
#configure terminal
(config)#router rip
(config-router)#cisco-metric-behavior enable
```

clear ip rip route

Use this command to clear specific data from the RIP routing tables.

Using this command with the `all` parameter, clears the RIP table of all the routes. If you do not want that your RIP network to be deleted, use the `redistribute connected` command and make the RIP network a connected route. To delete the RIP routes learned from neighbor and also keep the RIP network intact, use the `rip (clear ip rip route rip)` parameter with this command.

Command Syntax

```
clear ip rip route (A.B.C.D/M|rip|kernel|connected|static|ospf|isis|bgp|all)
```

Parameters

A.B.C.D/M	Removes entries which exactly match this destination address from RIP routing table.
bgp	Removes only BGP routes from the RIP routing table.
connected	Removes entries for connected routes from the RIP routing table.
isis	Removes only IS-IS routes from the RIP routing table
kernel	Removes kernel entries from the RIP routing table.
ospf	Removes only OSPF routes from the RIP routing table.
rip	Removes only RIP routes from the RIP routing table.
static	Removes static entries from the RIP routing table.
all	Removes the entire RIP routing table.

Default

None

Command Mode

Privileged Exec mode

Applicability

This command was introduced before OcNOS version 1.3.

Examples

```
#clear ip rip route 10.0.0.0/8
#clear ip rip route ospf
```

clear ip rip route vrf NAME

Use this command to clear all IPv4 RIP VRF route or any specific prefix RIP VRF route of any particular VRF name.

Command Syntax

```
clear ip rip route vrf NAME (*|A.B.C.D/M)
```

Parameters

A.B.C.D/M	Removes entries with the prefix specified.
*	Removes all routes
NAME	VPN Routing or Forwarding instance name

Default

None

Command Mode

Privileged Exec mode

Applicability

This command was introduced before OcnOS version 1.3.

Examples

```
#clear ip rip route vrf myVRF *
```

clear ip rip statistics

Use this command to clear an IPv4 RIP statistics.

Command Syntax

```
clear ip rip statistics (IFNAME |)
```

Parameters

IFNAME Removes entries from the interface.

Default

None

Command Mode

Privileged Exec mode

Applicability

This command was introduced before OcNOS version 1.3.

Examples

```
#clear ip rip statistics
```

debug rip

Use this command to specify the options for the displayed debugging information for RIP events, RIP packets and RIP NSM.

Use the `no` parameter with this command to disable all debugging. The `undebug` alias command can also be used.

Command Syntax

```
debug rip (all|events|packet (recv|send))|packet detail|nsm|rib|bfd|
no debug rip (all|events|packet (recv|send))|packet detail|nsm|rib|bfd|
undebug rip (all|)
undebug rip bfd
undebug rip events
undebug rip nsm
undebug rip packet (recv|send|) (detail|)
undebug rip rib
```

Parameters

<code>all</code>	Debug all RIP information.
<code>bfd</code>	Debug all RIP and BFD information.
<code>events</code>	Debug RIP events.
<code>nsm</code>	Debug RIP and NSM communications.
<code>packet</code>	Debug RIP packets, only
<code>recv</code>	Debug received packets.
<code>rib</code>	Debug RIP and RIB communications.
<code>send</code>	Debug sent packets.
<code>detail</code>	Display detailed information for the sent or received packet.

Default

Disabled

Command Mode

Privileged Exec mode and Configure mode

Applicability

This command was introduced before OcNOS version 1.3 and modified in OcNOS version 6.1.0.

Examples

The following example specifies the options for the displayed debugging information in `Configure mode` prompt.

```
#configure terminal
(config)#debug rip events
(config)#debug rip packet send detail
(config)#debug rip nsm
```

The following example shows to disable all debugging in `Privileged Exec` mode prompt.

```
#undebug rip events
#undebug rip packet send detail
#undebug rip nsm
```

default-information originate

Use this command to add default routes to the RIP updates.

Use the `no` parameter with this command to disable this feature.

Command Syntax

```
default-information originate (always|) (route-map WORD|)
no default-information originate
```

Parameters

<code>always</code>	Always advertise default route
<code>route map</code>	Route map reference
<code>WORD</code>	Pointer to route-map entries

Default

Disabled

Command Mode*

Router mode

Applicability

This command was introduced before OcnOS version 1.3.

Examples

```
#configure terminal
(config)#router rip
(config-router)#default-information originate route-map pmap
```

default-metric

Use this command to specify the metrics to be assigned to redistributed routes.

This command is used in conjunction with the `redistribute` command to make the routing protocol use the specified metric value for all redistributed routes. A default metric is useful in redistributing routes with incompatible metrics. Every protocol has different metrics and can not be compared directly. Default metric provides the standard to compare. All routes that are redistributed will use the default metric.

Use the `no` parameter with this command to disable this feature.

Command Syntax

```
default-metric <1-15>
no default-metric
```

Parameter

<1-15> Specify the default metric.

Default

By default, the metric value is set to 1.

Command Mode

Router mode

Applicability

This command was introduced before OcnOS version 1.3.

Examples

This example assigns the cost of 10 to the OSPF routes which are redistributed into RIP.

```
#configure terminal
(config)#router rip
(config-router)#redistribute ospf
(config-router)#default-metric 10
```

distance

Use this command to set the administrative distance. The administrative distance is a feature used by the routers to select the path when there are two or more different routes to the same destination from two different routing protocols. A smaller administrative distance indicating a more reliable protocol.

Use the `no` parameter with this command to disable this function.

Command Syntax

```
distance <1-255>
distance <1-255> A.B.C.D/M (WORD|)
no distance
no distance A.B.C.D/M
```

Parameters

<1-255>	Specify the administrative distance value.
A.B.C.D./M	Specify the network prefix and length
WORD	Specify the access list name.

Default

By default, the administrative distance is 120.

Command Mode

Router mode

Applicability

This command was introduced before OcNOS version 1.3 and modified in OcNOS version 6.1.0.

Examples

```
#configure terminal
(config)#router rip
(config-router)#distance 8 10.0.0.0/8 mylist
```

distribute-list

Use this command to filter incoming or outgoing route updates using an access list or a prefix list. You can filter out incoming or outgoing route updates using an access list or a prefix list. If you do not specify the name of the interface, the filter will be applied to all the interfaces.

Use the `no` parameter with this command to disable this feature.

Command Syntax

```
distribute-list WORD (in|out) (IFNAME|)
distribute-list prefix WORD (in|out) (IFNAME|)
no distribute-list (in|out) (IFNAME|)
no distribute-list prefix (in|out) (IFNAME|)
```

Parameters

<code>WORD</code>	Specify the IPv4 access-list number or name to use.
<code>prefix</code>	Filter prefixes in routing updates.
<code>WORD</code>	Specify the name of the IPv4 prefix-list to use.
<code>in</code>	Filter incoming routing updates.
<code>out</code>	Filter outgoing routing updates.
<code>IFNAME</code>	Specify the name of the interface on which distribute-list applies.

Default

Disabled

Command Mode

Router mode

Applicability

This command was introduced before OcNOS version 1.3 and modified in OcNOS version 6.1.0.

Example

```
#configure terminal
(config)#router rip
(config-router)#distribute-list prefix myfilter in eth0
```

ip rip authentication key-chain

Use this command to enable RIPv2 authentication on an interface and specify the name of the key chain to be used. If you do not configure a key chain results in no authentication.

Use the `no` parameter with this command to disable this function.

See [Appendix A, Routing Information Protocol Authentication](#) for information on how this command is related to the other authentication commands.

Command Syntax

```
ip rip authentication key-chain LINE
no ip rip authentication key-chain (LINE|)
```

Parameters

LINE Specify the name of the key chain.

Default

If you do not configure a key chain, authentication is not used.

Command Mode

Interface mode

Applicability

This command was introduced before OcNOS version 1.3.

Examples

In the following example, interface eth0 is configured key-chain authentication and the name is specified as `mykey`. This name is used to enter the key-chain mode to specify the password. See the `key` command.

```
#configure terminal
(config)#interface eth0
(config-if)#ip rip authentication key-chain mykey
```

ip rip authentication mode

Use this command to specify the type of authentication mode used for RIP v2 packets.

Use the `no` parameter with this command to restore clear text authentication.

See [Appendix A, Routing Information Protocol Authentication](#) for information on how this command is related to the other authentication commands.

Command Syntax

```
ip rip authentication mode md5
ip rip authentication mode text
no ip rip authentication mode
```

Parameters

<code>md5</code>	Uses the keyed MD5 authentication algorithm.
<code>text</code>	Specify the clear text or simple password authentication.

Default

No authentication mode is enabled by default. But, when any authentication key (string or key-chain) is configured, text authentication mode is enabled by default.

Command Mode

Interface mode

Applicability

This command was introduced before OcnOS version 1.3.

Examples

The following example shows `md5` authentication configured on the `eth1` interface, ensuring authentication of RIP packets received.

```
#configure terminal
(config)#interface eth1
(config-if)#ip rip authentication mode md5
```

ip rip authentication string

Use this command to specify the authentication string or password used by a key.

You can configure authentication for a single key or multiple keys at different times. Use this command to specify password for a single key on an interface.

Use the `no` parameter with this command to disable this feature.

See [Appendix A, Routing Information Protocol Authentication](#) for how this command is related to the other authentication commands.

Command Syntax

```
ip rip authentication string LINE
no ip rip authentication string
```

Parameters

`LINE` Specify the authentication string or password used by a key.

Default

None

Command Mode

Interface mode

Applicability

This command was introduced before OcNOS version 1.3.

Examples

In the following example, the interface `eth1` is configured to have an authentication string as `guest`, any receiving RIP packet in that interface should have the same string as password.

```
#configure terminal
(config)#interface eth1
(config-if)#ip rip authentication string guest
```

ip rip receive-packet

Use this command to configure the interface to enable the reception of RIP packets.

Use the `no` parameter with this command to disable this feature.

Command Syntax

```
ip rip receive-packet
no ip rip receive-packet
```

Parameters

None

Default

Receive-packet is enabled

Command Mode

Interface mode

Applicability

This command was introduced before OcNOS version 1.3.

Example

This example shows packet receiving being turned on for interface `eth0`.

```
#configure terminal
(config)#interface eth0
(config-if)#ip rip receive-packet
```

ip rip receive version

Use this command to receive specified version of RIP packets on an interface basis using version control, and override the setting of the version command.

Use the `no` form of this command to use the setting established by the version command.

Command Syntax

```
ip rip receive version (1|2)
ip rip receive version 1 2
no ip rip receive version
```

Parameters

- | | |
|-----|---|
| 1 | Specify acceptance of RIP version 1 packets on the interface. |
| 2 | Specify acceptance of RIP version 2 packets on the interface. |
| 1 2 | Specify acceptance of RIP version 1 and version 2 packets on the interface. |

Default

Version 2

Command Mode

Interface mode

Applicability

This command was introduced before OcNOS version 1.3 and modified in OcNOS version 6.1.0.

Examples

In the following example, interface eth1 is configured to receive both RIP version 1 and 2 packets.

```
#configure terminal
(config)#interface eth1
(config-if)#ip rip receive version 1 2
```

ip rip send-packet

Use this command to enable sending RIP packets through the current interface.

Use the `no` parameter with this command to disable this feature.

Command Syntax

```
ip rip send-packet
no ip rip send-packet
```

Parameters

None

Default

Send packet is enabled.

Command Mode

Interface mode

Applicability

This command was introduced before OcNOS version 1.3.

Example

This example shows packet sending being turned on for interface `eth0`.

```
#configure terminal
(config)#interface eth0
(config-if)#ip rip send-packet
```

ip rip send version

Use this command to send RIP packets on an interface using version control. In addition to version 1 and version 2, compatible version packets can be specified. With the parameter 1-compatible, a version 2 RIP interface will broadcast the packets instead of multicasting them.

This command applies to a specific interface and overrides any the version specified by the `version` command.

Use the `no` parameter with this command to use the global RIP version control rules.

Command Syntax

```
ip rip send version (1|2|1-compatible)
ip rip send version 1 2
no ip rip send version
```

Parameters

1	Specify sending RIP version 1 packets out of an interface.
2	Specify sending RIP version 2 packets out of an interface.
1 2	Specify acceptance of RIP version 1 and version 2 packets on the interface.
1-compatible	Specify sending RIP version 1 compatible packets from a version 2 RIP interface.

Default

Version 2

Command Mode

Interface mode

Applicability

This command was introduced before OcNOS version 1.3 and modified in OcNOS version 6.1.0.

Examples

In the following example, interface eth1 is configured to send both RIP version 1 and 2 packets.

```
#configure terminal
(config)#interface eth1
(config-if)#ip rip send version 1 2
```

ip rip split-horizon

Use this command to perform the split-horizon action on the interface

This command helps avoid including routes in updates sent to the same gateway from which they were learned. Using the `split horizon` command omits routes learned from one neighbor, in updates sent to that neighbor. Using the `poisoned` parameter with this command includes such routes in updates, but sets their metrics to infinity. Thus, advertising that these routes are not reachable.

Use the `no` parameter with this command to disable this function.

Command Syntax

```
ip rip split-horizon
ip rip split-horizon poisoned
no ip rip split-horizon
```

Parameter

`poisoned` Performs split-horizon with poisoned reverse.

Default

Split horizon poisoned

Command Mode

Interface mode

Applicability

This command was introduced before OcNOS version 1.3.

Examples

```
#configure terminal
(config)#interface eth0
(config-if)#ip rip split-horizon poisoned
```

key-id

Use this command to manage, add or delete authentication keys in a key-chain. This command allows you to enter the Keychain-key mode to set a password for the key.

Use the no option with this command to disable this feature.

See [Appendix A, Routing Information Protocol Authentication](#) for information on how this command is related to the other authentication commands.

Command Syntax

```
key-id <0-2147483647>
no key-id <0-2147483647>
```

Parameters

<0-2147483647> Specify a key identifier.

Default

By default, RIP uses level-1-2 if there is no Level-2 instance nor a Level-1-2 instance. Otherwise, it uses level-1.

Command Mode

Keychain mode

Applicability

This command was introduced before OcnOS version 1.3.

Examples

In the following example, the password for `key-id 1` in the key chain named `mychain` is set to `prime`:

```
#configure terminal
(config)#key chain mychain
(config-keychain)#key-id 1
(config-keychain-key)#key-string prime

(config-keychain)#key-id 1
(config-keychain-key)#no key-string
```

key chain

Use this command to enter the key chain management mode and to configure a key chain with a key chain name. This command allows you to enter the keychain mode to specify keys on this key chain.

Use the `no` option with this command to disable this feature.

See [Appendix A, Routing Information Protocol Authentication](#) for information on how this command is related to the other authentication commands.

Command Syntax

```
key chain WORD
no key chain WORD
```

Parameter

WORD Specify the name of the key chain to manage.

Default

None

Command Mode

Configure mode and Keychain mode

Applicability

This command was introduced before OcnOS version 1.3.

Examples

The following example shows the creation of a key chain named `mychain` and the change into `keychain` mode prompt.

```
#configure terminal
(config)#key chain mychain
(config-keychain)#
```

The following example shows the creation of a key chain named `mykeychain3` in the `keychain` mode and the addition of an authentication key `key-id 10` in the same mode.

```
(config-keychain)#key chain mykeychain3
(config-keychain)#key-id 10
(config-keychain-key)#
```

key-string

Use this command to define a password in plain-text to be used by a key.

The password is stored as encrypted, and is displayed in encrypted text when show running-config command is executed.

Use the `no` parameter with this command to disable this feature.

See [Appendix A, Routing Information Protocol Authentication](#) for information on how this command is related to the other authentication commands.

Command Syntax

```
key-string WORD
no key-string
```

Parameters

`WORD` Specify a string of characters to be used as a password by the key.

Default

Disabled

Command Mode

Keychain-key mode

Applicability

This command was introduced before OcNOS version 1.3.

Examples

In the following example, the password for `key-id 1` in the key chain named `mychain` is set to `prime`:

```
#configure terminal
(config)#key chain mychain
(config-keychain)#key-id 1
(config-keychain-key)#key-string prime

(config-keychain)#key-id 1
(config-keychain-key)#no key-string
```

key-string encrypted

Use this command to define a password in its encrypted format to be used by a key.

Use the `no` parameter with this command to disable this feature

Command Syntax

```
key-string encrypted WORD
no key-string encrypted
```

Parameters

WORD	Specify the encrypted string of characters to be used as a password by the key. The length of this string should be between 18-162 characters.
------	--

Default

By default, password is not configured.

Command Mode

Keychain mode and Keychain-key mode.

Applicability

This command was introduced in OcNOS version 4.1.

Examples:

In the following example, the encrypted password for key-id 1 in the key chain named mykeychain is set to 0xd6c50b442de47f70 (equivalent to "mychain" in plain-text):

```
#configure terminal
(config)#key chain mykeychain
(config-keychain)#key-id 1
(config-keychain-key)#key-string encrypted 0xd6c50b442de47f70
(config-keychain)#key-id 1
(config-keychain-key)#no key-string
```

maximum-prefix

Use this command to configure the maximum prefix.

Use the `no` parameter with this command to disable the limiting of the number of RIP routes in the routing table.

Command Syntax

```
maximum-prefix <1-65535> (<1-100>|)  
no maximum-prefix
```

Parameters

<1-65535>	The maximum number of RIP routes allowed.
<1-100>	Percentage of maximum routes to generate a warning. The default threshold is 75%.

Default

The default maximum-prefix threshold is 75%.

Command Mode

Router mode

Applicability

This command was introduced before OcnOS version 1.3.

Examples

```
#configure terminal  
(config)#router rip  
(config-router)#maximum-prefix 150
```

neighbor

Use this command to specify a neighbor router. It is used for each connected point-to-point link. This command to exchanges non-broadcast routing information. It can be used multiple times for additional neighbors.

`Passive-interface` command disables sending routing updates on an interface. Use the `neighbor` command in conjunction with the `passive-interface` command to send routing updates to specific neighbors.

Use the `no` parameter with this command to disable the specific router.

Command Syntax

```
neighbor A.B.C.D
no neighbor A.B.C.D
```

Parameter

A.B.C.D	An IP address of a neighboring router with which the routing information will be exchanged.
---------	---

Default

Disabled

Command Mode

Router mode

Applicability

This command was introduced before OcNOS version 1.3.

Examples

```
#configure terminal
(config)#router rip
(config-router)#neighbor 10.7.1.12
```

network

Use this command to specify a network as one that runs RIP. This command specifies the networks to which routing updates will be sent and received. If a network is not specified, the interfaces in that network will not be advertised in any RIP update.

Use the `no` parameter with this command to remove the specified network as one that runs RIP.

Command Syntax

```
network A.B.C.D/M
network IFNAME
no network A.B.C.D/M
no network IFNAME
```

Parameters

A.B.C.D/M	The IP address prefix and length of this IP network.
IFNAME	Alphanumeric string that defines the interface name.

Default

Disabled

Command Mode

Router mode

Applicability

This command was introduced before OcnOS version 1.3.

Examples

```
#configure terminal
(config)#router rip
(config-router)#network 10.0.0.0/8
(config-router)#network eth0
```

offset-list

Use this command to add an offset to in and out metrics to routes learned through RIP. This command specifies the offset value that is added to the routing metric. When the networks match the access list the offset is applied to the metrics. No change occurs if the offset value is zero.

Use the `no` parameter with this command to remove the offset list.

Command Syntax

```
offset-list WORD (in|out) (IFNAME|)
no offset-list WORD (in|out) (IFNAME|)
```

Parameters

WORD	Specify the access-list number or names to apply.
in	Indicates the access list will be used for metrics of incoming advertised routes.
out	Indicates the access list will be used for metrics of outgoing advertised routes.
IFNAME	An alphanumeric string that specifies the interface to match.

Default

The default `offset value` is the interface metric value which is defined by the operating system.

Command Mode

Router mode

Applicability

This command was introduced before OcNOS version 1.3 and modified in OcNOS version 6.1.0.

Examples

In this example the router examines the RIP updates being sent out from interface eth0 and adds 16 hops to the routes matching the ip addresses specified in the access list `accesslist1`.

```
#configure terminal
(config)#router rip
(config-router)#offset-list accesslist1 in eth0
```

passive-interface

Use this command to block RIP broadcast on the interface.

Use the `no` parameter with this command to disable this function.

Command Syntax

```
passive-interface IFNAME
no passive-interface IFNAME
```

Parameters

IFNAME Specify the interface name.

Default

Disabled

Command Mode

Router mode

Applicability

This command was introduced before OcNOS version 1.3.

Examples

```
#configure terminal
(config)#router rip
(config-router)#passive-interface eth0
```

recv-buffer-size

Use this command to run-time configure the RIP UDP receive-buffer size.

Use the `no` parameter with this command to return to the default value.

Command Syntax

```
recv-buffer-size <8192-2147483647>
no recv-buffer-size
```

Parameters

```
<8192-2147483647>
```

Specify the RIP UDP receive buffer size value.

Default

The default value of the RIP UDP receive-buffer size is 32768.

Command Mode

Router mode

Applicability

This command was introduced before OcnOS version 1.3.

Examples

```
#configure terminal
(config)#router rip
(config-router)#recv-buffer-size 150000
```

redistribute

Use this command to redistribute information from other routing protocols.

Use the `no` parameter with this command to disable this function.

Command Syntax

```
redistribute (kernel|connected|static|ospf|isis|bgp)
redistribute (kernel|connected|static|ospf|isis|bgp) metric <0-16>
redistribute (kernel|connected|static|ospf|isis|bgp) route-map WORD
redistribute (kernel|connected|static|ospf|isis|bgp) metric <0-16> route-map WORD
no redistribute (kernel|connected|static|ospf|isis|bgp)
no redistribute (kernel|connected|static|ospf|isis|bgp) metric <0-16>
no redistribute (kernel|connected|static|ospf|isis|bgp) route-map WORD
no redistribute (kernel|connected|static|ospf|isis|bgp) metric <0-16> route-map
WORD
```

Parameters

<code>bgp</code>	Redistribute from BGP routes
<code>connected</code>	Redistribute from connected routes
<code>isis</code>	Redistribute from ISO IS-IS routes
<code>kernel</code>	Redistribute from kernel routes
<code>ospf</code>	Redistribute from OSPFv3 routes
<code>static</code>	Redistribute from static routes
<code>metric</code>	Metric value
<code><0-16></code>	Specify a metric value
<code>route-map</code>	Route map reference
<code>WORD</code>	Specify name of the route-map

Default

Disabled

Command Mode

Router mode

Applicability

This command was introduced before OcNOS version 1.3.

Examples

```
#configure terminal
(config)#router rip
(config-router)#redistribute kernel
```

```
#configure terminal
(config)#router rip
(config-router)#redistribute kernel route-map myroutemap
```

route

Use this command to configure static RIP routes.

Use the `no` parameter with this command to disable this function.

Command Syntax

```
route A.B.C.D/M
no route A.B.C.D/M
```

Parameter

A.B.C.D/M Specify the IP address prefix and length.

Default

No route is added.

Command Mode

Router mode

Applicability

This command was introduced before OcNOS version 1.3.

Examples

Use this command to add a static RIP route. This command is used most often for debugging purposes and does not show up in the kernel routing table. After adding the RIP route, it can be checked in the RIP routing table.

```
#configure terminal
(config)#router rip
(config-router)#version 1
(config-router)#network 10.10.10.0/24
(config-router)#network 10.10.11.0/24
(config-router)#neighbor 10.10.10.10
(config-router)#route 10.10.10.0/24

(config-router)#version 1
(config-router)#network 10.10.10.0/24
(config-router)#network 10.10.11.0/24
(config-router)#no route 10.10.10.0/24
```

router rip

Use this global command to enable a RIP routing process.

Use the `no` parameter with this command to disable RIP routing.

Command Syntax

```
router rip
no router rip
```

Parameter

None

Default

Disabled

Command Mode

Configure mode

Applicability

This command was introduced before OcNOS version 1.3.

Examples

This command is used to begin the RIP routing process.

```
#configure terminal
(config)#router rip
(config-router)#version 1
(config-router)#network 10.10.10.0/24
(config-router)#network 10.10.11.0/24
(config-router)#neighbor 10.10.10.10
```

send-lifetime

Use this command to specify the time period during which the authentication key on a key chain can be sent.

Use the `no` parameter with this command to negate this command.

Command Syntax

```
send-lifetime HH:MM:SS MONTH <01-31> <1993-2035> HH:MM:SS MONTH <01-31> <1993-2035>
send-lifetime HH:MM:SS MONTH <01-31> <1993-2035> infinite
send-lifetime HH:MM:SS MONTH <01-31> <1993-2035> duration <1-2147483646>
no send-lifetime
```

Parameters

HH:MM:SS	Specify the start time of send-lifetime in hours, minutes and seconds.
<01-31>	Specify the day of the month to start. If the day is a single-digit, the leading 0 must be added, example: 01, 02, 03, etc.
MONTH	Specify the month of the year to start as the first three letters of the month with first letter in upper case, for example, Jan. (case sensitive)
<1993-2035>	Specify the year to start.
HH:MM:SS	Specify the time when send-lifetime expires in hours, minutes and seconds.
<01-31>	Specify the day of the month to end. If the day is a single-digit, the leading 0 must be added, example: 01, 02, 03, etc.
MONTH	Specify the month of the year to end as the first three letters of the month with first letter in caps, for example, Jan. (case sensitive)
<1993-2035>	Specify the year to expire.
duration	Specify the duration of the key in seconds <1-2147483646>.
infinite	Specify the end time to never expire.

Default

Disabled

Command Mode

Keychain-key mode

Applicability

This command was introduced before OcNOS version 1.3.

Examples

The following example shows the setting of `send-lifetime` for `key-id 1` on the key chain named `mychain`:

```
#configure terminal
(config)#key chain mychain
(config-keychain)#key-id 1
(config-keychain-key)#send-lifetime 03:03:01 Jan 03 2004 04:04:02 Dec 06 2006
```

show debugging rip

Use this command to display the RIP debugging status for these debugging options: nsm debugging, RIP event debugging, RIP packet debugging and RIP nsm debugging.

Command Syntax

```
show debugging rip
```

Parameters

None

Default

None

Command Mode

Exec mode and Privileged Exec mode

Applicability

This command was introduced before OcNOS version 1.3.

Example

```
#show debugging rip
R2#show debugging rip
RIP debugging status:
  RIP event debugging is on
  RIP packet detail debugging is on
  RIP RIB debugging is on
  RIP NSM debugging is on
  RIP BFD debugging is on
```

```
R2#
```

show ip protocols rip

Use this command to display RIP process parameters and statistics.

Command Syntax

```
show ip protocols
show ip protocols rip
```

Parameters

None

Default

None

Command Mode

Exec mode and Privileged Exec mode

Applicability

This command was introduced before OcNOS version 1.3.

Example

This is an example of the output from the `show ip protocols rip` command:

```
#show ip protocols rip
Routing Protocol is "rip"
Sending updates every 30 seconds with +/-50%, next due in 12 seconds
Timeout after 180 seconds, garbage collect after 120 seconds
Outgoing update filter list for all interface is not set
Incoming update filter list for all interface is not set
Default redistribution metric is 1
Redistributing: connected static
Default version control: send version 2, receive version 2
Interface          Send  Recv  Key-chain
   eth0             2     2
Routing for Networks:
  10.10.0.0/24
Routing Information Sources:
  Gateway          BadPackets BadRoutes  Distance Last Update
Distance: (default is 120)
#
```

[Figure 1-73](#) Explains the show command output details.

Table 1-73: Show ip protocols output details

Field	Description
Routing Protocol is "rip"	Specifies the routing protocol used.
Sending updates every 30 seconds	Specifies the time between sending updates.

Routing Information Protocol Commands

Next due in 12 seconds	Precisely when the next update is due to be sent.
Timeout after 180 seconds	Specifies the value of the timeout parameter.
Redistributing	Lists the protocol that is being redistributed.
Routing for Networks	Specifies the networks for which the routing process is currently injecting routes.
Routing Information Sources	Lists all the routing sources the IP Infusion software is using to build its routing table.

show ip rip

Use this command to show RIP routes.

Command Syntax

```
show ip rip (database|)
```

Parameters

database Specify to display information about the IP RIP database.

Default

None

Command Mode

Exec mode and Privileged Exec mode

Applicability

This command was introduced before OcNOS version 1.3.

Example

The following output displays the RIP routing table with the destination network, nexthop and metric to reach it.

```
#show ip rip
Codes: R - RIP, K - Kernel, C - Connected, S - Static, O - OSPF, I - IS-IS,
B - BGP
Network Next Hop Metric From If Time
K 0.0.0.0/0 10.0.1.1 16 eth1 01:58
C 10.0.1.0/24 1 eth1
S 10.10.10.0/24 1 eth0
C 10.10.11.0/24 1 eth0
S 192.168.101.0/24 1 eth0
R 192.192.192.0/24 1 --
```

Table 1-74 shows the status codes displayed at the start of a route entry.

Table 1-74: Status codes

Status Code	Meaning	Description
R	RIP	RIP prevents routing loops by implementing a limit on the number of hops allowed in a path from source to destination.
K	Kernel	Kernel is central component of operating system.
C	Connected	Redistribute from locally connected networks.
S	Static	Connections in a static network are fixed links, while connections in a dynamic network are established on the fly as needed.
O	OSPF	Open Shortest Path First (OSPF) is a routing protocol for Internet Protocol (IP) networks.

Routing Information Protocol Commands

I	IS-IS	Intermediate System to Intermediate System (IS-IS) is a routing protocol designed to move information efficiently within a host network.
B	BGP	BGP makes routing decisions based on paths, rules or network policies configured by a network administrator.

show ip rip interface

Use this command to display information about RIP interfaces. You can specify an interface name to display information about a specific interface.

Command Syntax

```
show ip rip interface (IFNAME|)
```

Parameters

IFNAME Name of the interface for which information is to be displayed.

Default

None

Command Mode

Exec mode and Privileged Exec mode

Applicability

This command was introduced before OcNOS version 1.3.

Example

The following output displays the RIP routing table with the destination network, nexthop and metric to reach it.

```
#show ip rip interface
lo is up, line protocol is up
RIP is not enabled on this interface
eth0 is up, line protocol is up
RIP is not enabled on this interface
eth1 is down, line protocol is down
RIP is not enabled on this interface
eth2 is up, line protocol is up
Routing Protocol: RIP
Receive RIP packets
Send RIPv1 Compatible
Passive interface: Disabled
Split horizon: Enabled with Poisoned Reversed
IP interface address:
10.10.1.1/24
10.10.2.1/24
```

[Figure 1-75](#) Explains the show command output details.

Table 1-75: Show ip rip interface output details

Field	Description
Network	IP address of a network entity.
Nexthop	IP address of the next system that is used when forwarding a packet to the destination network.

Routing Information Protocol Commands

Metric	If shown, the value of the inter-autonomous system metric.
Routing Protocol	Specifies the routing protocol used.
Passive Interface	Used in all routing protocols to disable sending updates out from a specific interface.
Split horizon	the routing switch does not advertise a route on the same interface as the one on which the routing switch learned the route.
IP Interface address	IP address of the RIP peer neighbor.

show ip rip statistics

Use this command to display information about RIP statistics. You can specify an interface name to display information about a specific interface.

Command Syntax

```
show ip rip statistics (IFNAME|)
```

Parameters

IFNAME Name of the interface for which information is to be displayed.

Default

None

Command Mode

Exec mode and Privileged Exec mode

Applicability

This command was introduced before OcNOS version 1.3.

Example

The following output displays the RIP routing table with the destination network, nexthop and metric to reach it.

```
#show ip rip statistics eth1
Interface Name : eth1
Sent Multicast Updates   : 3
Sent Multicast Requests  : 1
Sent Unicast Updates     : 0
Sent Unicast Requests    : 0
Recv Multicast Updates   : 3
Recv Multicast Requests  : 0
Recv Unicast Updates     : 1
Recv Unicast Requests    : 0
Recv Bad Packets         : 0
Recv Bad Routes          : 0
```

Figure 1-76 Explains the show command output details.

Table 1-76: Show ip rip statistics output details

Field	Description
Network	IP address of a network entity.
Nexthop	IP address of the next system that is used when forwarding a packet to the destination network.
Metric	If shown, the value of the inter autonomous system metric.
Sent updates	Number of RIP routing updates that have been sent on Multicast/Unicast interface.

Routing Information Protocol Commands

Sent Request	Number of RIP routing request that have been sent on Multicast/Unicast interface.
Recv updates	Number of RIP routing updates that have been received on Multicast/Unicast interface.
Recv Request	Number of RIP routing request that have been received on Multicast/Unicast interface.
Recv Bad Packets	Number of packets that were received on this interface and were not processed for any reason.
Recv Bad Routes	Number of route entries that were received on this interface and were not processed for any reason.

snmp restart rip

Use this command to restart SNMP in Routing Information Protocol (RIP)

Command Syntax

```
snmp restart rip
```

Parameters

None

Default

By default, snmp restart is disabled.

Command Mode

Configure mode

Applicability

This command was introduced before OcNOS version 1.3.

Examples

```
#configure terminal  
(config)#snmp restart rip
```

timers basic

Use this command to adjust routing network timers.

This command adjusts the RIP timing parameters. Every 30 seconds, an update is sent out containing the complete routing table to every neighboring router. When the time specified by the timeout parameter expires, the route is no longer valid. However, it is retained in the routing table for a short time so that neighbors are notified that the route has been dropped. When the time specified by the garbage parameter expires, the route is finally removed from the routing table. Until the garbage time expires, the route is included in all updates sent by the router.

All routers in the network must have the same timers to allow RIP to execute a distributed and asynchronous routing algorithms. The timers should not be synchronized as it might lead to unnecessary collisions on the network.

Use the `no` parameter with this command to restore the default routing network timers.

Command Syntax

```
timers basic <5-2147483647> <5-2147483647> <5-2147483647>
no timers basic
```

Parameters

- <5-2147483647> Specify the routing table update timer in seconds. The default is 30 seconds.
- <5-2147483647> Specify the routing information timeout timer in seconds. The default is 180 seconds. After this interval has elapsed and no updates for a route are received, the route is declared invalid.
- <5-2147483647> Specify the routing garbage collection timer in seconds. The default is 120 seconds.

Default

The default routing table update time is 30 seconds.

The default routing information timeout time is 180 seconds.

The default routing garbage collection time is 120 seconds.

Command Mode

Router mode

Applicability

This command was introduced before OcNOS version 1.3.

Examples

```
#configure terminal
(config)#router rip
(config-router)#timers basic 30 180 120

(config)#router rip
(config-router)#no timers basic
```

version

Use this command to specify a RIP version used globally by the router. RIP can be run in version 1 as well as version 2 mode. Version 2 has more features than version 1 including authentication. Once the rip version is set, rip packets of that version will be received and sent on all the rip-enabled interfaces.

Use the `no` parameter with this command to restore the default version.

Note: The `ip rip receive version` command and the `ip rip send version` command override the value set by the `version` command.

Command Syntax

```
version <1-2>
no version
```

Parameters

<1-2> Specify the version of RIP processing.

Default

Version 2

Command Mode

Router mode

Applicability

This command was introduced before OcnOS version 1.3.

Examples

```
#configure terminal
(config)#router rip
(config-router)#version 1
(config-router)#network 10.10.10.0/24
(config-router)#network 10.10.11.0/24
```

CHAPTER 2 RIPng Commands

This chapter provides an alphabetized reference for each of the Routing Information Protocol next generation (RIPng) commands, which support IPv6. It includes the following commands:

- [aggregate-address](#)
- [cisco-metric-behavior](#)
- [clear ipv6 rip route](#)
- [debug ipv6 rip](#)
- [default-information originate](#)
- [default-metric](#)
- [distance](#)
- [distribute-list](#)
- [ipv6 rip metric-offset](#)
- [ipv6 rip split-horizon](#)
- [ipv6 router rip](#)
- [neighbor](#)
- [offset-list](#)
- [passive-interface](#)
- [recv-buffer-size](#)
- [redistribute](#)
- [route](#)
- [route-map](#)
- [router ipv6 rip](#)
- [show debugging ipv6 rip](#)
- [show ipv6 protocols rip](#)
- [show ipv6 rip](#)
- [show ipv6 rip interface](#)
- [timers basic](#)

aggregate-address

Use this command to set an aggregate RIPng route announcement.

Use the `no` parameter with this command to disable this feature.

Command Syntax

```
aggregate-address X:X::X:X/M
no aggregate-address X:X::X:X/M
```

Parameter

`X:X::X:X/M` Specify an aggregate network (IPv6 address prefix and length).

Command Mode

Router mode

Applicability

This command was introduced before OcnOS version 1.3.

Examples

```
#configure terminal
(config)#router ipv6 rip
(config-router)#aggregate-address 3ffe:8088::/32

(config)#router ipv6 rip
(config-router)#no aggregate-address 3ffe:8088::/32
```

cisco-metric-behavior

Use this command to enable or disable the metric update as Cisco.

Use the `no` parameter with this command to disable this feature.

Command Syntax

```
cisco-metric-behavior (enable|disable)
no cisco-metric-behavior
```

Parameters

<code>enable</code>	Enable updating the metric consistent with Cisco.
<code>disable</code>	Disable updating the metric consistent with Cisco.

Default

By default, the Cisco metric-behavior is disabled.

Command Mode

Router mode

Applicability

This command was introduced before OcnOS version 1.3.

Example

This example shows how to enable the metric update behavior to be consistent with Cisco in the Router mode.

```
#configure terminal
(config)#router ipv6 rip
(config-router)#cisco-metric-behavior enable
```

clear ipv6 rip route

Use this command to clear specific data from the RIPng routing table.

Command Syntax

```
clear ipv6 rip route (X:X::X:X/M|rip|kernel|connected|static|ospf6|isis|bgp|all)
```

Parameters

<code>X:X::X:X/M</code>	Removes entries which exactly match this destination address from the RIPng routing table.
<code>bgp</code>	Removes only BGP routes from the RIP routing table.
<code>connected</code>	Removes entries for connected routes from the RIP routing table.
<code>isis</code>	Removes only IS-IS routes from the RIP routing table.
<code>kernel</code>	Removes kernel entries from the RIP routing table.
<code>ospf</code>	Removes only OSPF routes from the RIP routing table.
<code>static</code>	Removes static entries from the RIP routing table.
<code>all</code>	Removes the entire RIP routing table.

Command Mode

Privileged Exec mode

Applicability

This command was introduced before OcnOS version 1.3.

Example

```
#clear ipv6 rip route isis
#clear ipv6 rip route 3ffe:ffff::/16
```

debug ipv6 rip

Use this command to specify the options for the displayed debugging information for RIPng events, RIPng packets and RIPng NSM communications.

Use the `no` option with this command to turn off debugging options for RIPng. The `undebug` alias command can also be used.

Command Syntax

```
debug ipv6 rip (all|events|packet send|packet rcv|packet|packet detail|nsm|rib|)
no debug ipv6 rip (all|events|packet send|packet rcv|packet|packet
  detail|nsm|rib|)
undebug ipv6 rip (all|)
undebug ipv6 rip events
undebug ipv6 rip nsm
undebug ipv6 rip packet (rcv|send|) (detail|)
undebug ipv6 rip rib
```

Parameters

<code>all</code>	Debug all RIP information.
<code>events</code>	Debug RIP events.
<code>nsm</code>	Debug RIP and NSM communications.
<code>rib</code>	Debug RIP and RIB communications.
<code>packet</code>	Debug RIP packets, only Routing Information Protocol
<code>rcv</code>	Debug received packets.
<code>send</code>	Debug sent packets.
<code>detail</code>	Display detailed information for the sent or received packet.

Default

Disabled

Command Mode

Privileged Exec mode and Configure mode

Applicability

This command was introduced before OcNOS version 1.3.

Examples

The following example specifies the options for the displayed debugging information in `Configure` mode prompt.

```
#configure terminal
(config)#debug ipv6 rip events
(config)#debug ipv6 rip packet send detail
(config)#debug ipv6 rip nsm
```

The following example shows to disable all debugging in `Privileged Exec` mode prompt.

RIPng Commands

```
#undebug ipv6 rip events  
#undebug ipv6 rip packet send detail  
#undebug ipv6 rip nsm
```

default-information originate

Use this command to generate a default route into the RIPng.

Use the `no` parameter with this command to disable this feature.

Command Syntax

```
default-information originate
no default-information originate
```

Parameters

None

Default

Disabled

Command Mode

Router mode

Applicability

This command was introduced before OcNOS version 1.3.

Examples

```
#configure terminal
(config)#router ipv6 rip
(config-router)#default-information originate
```

default-metric

Use this command to specify the metrics to be assigned to redistributed routes.

Use the `no` parameter with this command to disable this feature.

For more details about this command, see the IPv4 version of this command ([default-metric](#)).

Command Syntax

```
default-metric <1-15>
no default-metric
```

Parameter

<1-15> Specify the default metric.

Default

By default, the metric value is set to 1.

Command Mode

Router mode

Applicability

This command was introduced before OcnOS version 1.3.

Examples

```
#configure terminal
(config)#router ipv6 rip
(config-router)#default-metric 8
```

distance

Use this command to set the administrative distance for RIP.

Use the no option with this command to disable this function.

For more details about this command, see the IPv4 version of this command ([distance](#)).

Command Syntax

```
distance <1-255>
no distance
```

Parameter

<1-255> Specify the administrative distance value.

Default

By default, the administrative distance is 120.

Command Mode

Router mode

Applicability

This command was introduced before OcnOS version 1.3.

Example

```
#configure terminal
(config)#router ipv6 rip
(config-router)#distance 100
```

distribute-list

Use this command to filter incoming or outgoing route updates using the access-list or the prefix-list. You can filter out incoming or outgoing route updates using access-list or prefix-list. If you do not specify the name of the interface, the filter will be applied to all the interfaces.

Use the `no` parameter with this command to disable this feature.

Command Syntax

```
distribute-list WORD (in|out) (IFNAME|)
distribute-list prefix WORD (in|out) (IFNAME|)
no distribute-list (in|out) (IFNAME|)
no distribute-list prefix (in|out) (IFNAME|)
```

Parameters

<code>WORD</code>	Specify the IPv6 access-list number or name to use.
<code>prefix</code>	Filter prefixes in routing updates.
<code>WORD</code>	Specify the name of the IPv6 prefix-list to use.
<code>in</code>	Filter incoming routing updates.
<code>out</code>	Filter outgoing routing updates.
<code>IFNAME</code>	Specify the name of the interface on which distribute-list applies.

Default

Disabled

Command Mode

Router mode

Applicability

This command was introduced before OcnOS version 1.3 and modified in OcnOS version 6.1.0.

Example

```
#configure terminal
(config)#router ipv6 rip
(config-router)#distribute-list prefix myfilter in eth0
```

ipv6 rip metric-offset

Use this command to set RIP metric offset.

Use the `no` parameter with this command to disable this function.

Command Syntax

```
ipv6 rip metric-offset <1-16>
no ipv6 rip metric-offset
```

Parameter

<1-16>	Set a metric value
--------	--------------------

Default

None

Command Mode

Interface mode

Applicability

This command was introduced before OcNOS version 1.3.

Examples

```
#configure terminal
(config)#interface eth0
(config-if)#ipv6 rip metric-offset 1

(config)#interface eth0
(config-if)#no ipv6 rip metric-offset
```

ipv6 rip split-horizon

Use this command to perform the split-horizon action on the interface.

Use the `no` parameter with this command to disable this function.

For more details about this command, see the IPv4 version of this command ([ip rip split-horizon](#)).

Command Syntax

```
ipv6 rip split-horizon
ipv6 rip split-horizon poisoned
no ipv6 rip split-horizon
```

Parameter

<code>poisoned</code>	Performs split-horizon with poisoned reverse.
-----------------------	---

Default

By default, Split horizon poisoned is enabled.

Command Mode

Interface mode

Applicability

This command was introduced before OcNOS version 1.3.

Examples

```
#configure terminal
(config)#interface eth1
(config-if)#ipv6 rip split-horizon

(config)#interface eth1
(config-if)#no ipv6 rip split-horizon
```

ipv6 router rip

Use this command to enable RIPng routing on the interface.

Use the `no` parameter with this command to disable RIPng routing.

Command Syntax

```
ipv6 router rip
no ipv6 router rip
```

Parameters

None

Default

None

Command Mode

Interface mode

Applicability

This command was introduced before OcNOS version 1.3.

Example

```
#configure terminal
(config)#interface eth0
(config-if)#ipv6 router rip
```

neighbor

Use this command to specify a neighbor router.

Use the `no` parameter with this command to disable the specific router.

For more details about this command, see the IPv4 version of this command ([neighbor](#)).

Command Syntax

```
neighbor X:X::X:X IFNAME
no neighbor X:X::X:X IFNAME
```

Parameters

X:X::X:X	Specify a link-local address of the peer router with which the routing information is exchanged.
IFNAME	Specify the name of the interface.

Default

Disabled

Command Mode

Router mode

Applicability

This command was introduced before OcNOS version 1.3.

Example

```
#configure terminal
(config)#router ipv6 rip
(config-router)#neighbor fe80::5054:ff:fece:30cd eth1
(config-router)#end
#show running-config ripng
!
router ipv6 rip
neighbor fe80::5054:ff:fece:30cd eth1
!
#
#show ipv6 interface brief
Interface          IPv6-Address          Admin-
Status
eth0                fe80::5054:ff:fe4e:22d3  [up/up]
eth1                2001:2001::1:2         [up/up]
                   fe80::5054:ff:fe5c:6a4f
[up/up]
eth2                fe80::5054:ff:fe16:8339  [up/up]
eth3                fe80::5054:ff:feb9:bc7c  [up/up]
lo                  ::1                    [up/up]
```

offset-list

Use this command to add an offset to in and out metrics to routes learned through RIPng.

Use the `no` parameter with this command to remove this function.

For more details about this command, see the IPv4 version of this command ([offset-list](#)).

Command Syntax

```
offset-list WORD (in|out) (IFNAME|)
no offset-list in|out (IFNAME|)
```

Parameters

WORD	Specify the access-list number or names to apply.
in	Indicates the access list will be used for metrics of incoming advertised routes.
out	Indicates the access list will be used for metrics of outgoing advertised routes.
IFNAME	An alphanumeric string that specifies the interface to match.

Default

The default offset value is the metric value of the interface which is defined by the operating system.

Command Mode

Router mode

Applicability

This command was introduced before OcNOS version 1.3 and modified in OcNOS version 6.1.0.

Examples

In this example the router examines the RIP updates being sent out from interface eth0 and adds 16 hops to the routes matching the ip addresses specified in the access list `accesslist1`.

```
#configure terminal
(config)#router ipv6 rip
(config-router)#offset-list accesslist1 in eth0
```

passive-interface

Use this command to suppress routing updates on an interface.

Use the `no` parameter with this command to disable this function.

Command Syntax

```
passive-interface IFNAME
no passive-interface IFNAME
```

Parameters

IFNAME Specify the interface name.

Default

Disabled

Command Mode

Router mode

Applicability

This command was introduced before OcNOS version 1.3.

Examples

```
#configure terminal
(config)#router ipv6 rip
(config-router)#passive-interface eth0
```

recv-buffer-size

Use this command to run-time configure the RIPng UDP receive-buffer size.

Use the `no` parameter with this command to return to the default value.

Command Syntax

```
recv-buffer-size <8192-2147483647>  
no recv-buffer-size
```

Parameters

```
<8192-2147483647>
```

Specify the RIP UDP receive buffer size value.

Default

The default value of the RIP UDP receive-buffer size is 8192.

Command Mode

Router mode

Applicability

This command was introduced before OcnOS version 1.3.

Examples

```
#configure terminal  
(config)#router ipv6 rip  
(config-router)#recv-buffer-size 150000
```

redistribute

Use this command to redistribute information from other routing protocols.

Use the `no` parameter with this command to disable this function.

Command Syntax

```
redistribute (kernel|connected|static|ospf|isis|bgp)
redistribute (kernel|connected|static|ospf|isis|bgp) metric <0-16>
redistribute (kernel|connected|static|ospf|isis|bgp) route-map WORD
redistribute (kernel|connected|static|ospf|isis|bgp) metric <0-16> route-map WORD
no redistribute (kernel|connected|static|ospf|isis|bgp)
no redistribute (kernel|connected|static|ospf|isis|bgp) metric <0-16>
no redistribute (kernel|connected|static|ospf|isis|bgp) route-map WORD
no redistribute (kernel|connected|static|ospf|isis|bgp) metric <0-16> route-map
WORD
```

Parameters

<code>bgp</code>	Redistribute from BGP routes
<code>connected</code>	Redistribute from connected routes
<code>isis</code>	Redistribute from ISO IS-IS routes
<code>kernel</code>	Redistribute from kernel routes
<code>ospf</code>	Redistribute from OSPF routes (version 3)
<code>static</code>	Redistribute from static routes
<code>metric</code>	Metric value
<0-16>	Specify a metric value
<code>route-map</code>	Route map reference
WORD	Specify name of the route-map

Command Mode

Router mode

Applicability

This command was introduced before OcNOS version 1.3.

Examples

```
#configure terminal
(config)#router ipv6 rip
(config-router)#redistribute kernel route-map mymap
(config-router)#redistribute kernel metric 8
```

route

Use this command to debug the specified route advertisement. Use this command to configure static RIPng routes.

Use the `no` parameter with this command to disable this function.

Command Syntax

```
route X:X::X:X/M
no route X:X::X:X/M
```

Parameter

`X:X::X:X/M` Specify the IPv6 address prefix and length.

Command Mode

Router mode

Applicability

This command was introduced before OcnOS version 1.3.

Examples

```
#configure terminal
(config)#router ipv6 rip
(config-router)#route 3ffe:1234:5678::1/64
```

route-map

Use this command to set a route map for input or output filtering on a specified interface.

Use the `no` parameter with this command to disable this function.

Command Syntax

```
route-map WORD (in|out) IFNAME
no route-map (in|out) IFNAME
```

Parameters

WORD	Specify a route map name
in	Specify to set the route map for input filtering
out	Specify to set the route map for output filtering
IFNAME	Specify an interface name to which to associate the route map

Command Mode

Router mode

Applicability

This command was introduced before OcNOS version 1.3.

Examples

```
#configure terminal
(config)#router ipv6 rip
(config-router)#route-map myRM in eth1
```

router ipv6 rip

Use this global command to enable a RIPng routing process.

Use the `no` parameter with this command to disable the RIPng routing process.

Command Syntax

```
router ipv6 rip
no router ipv6 rip
```

Parameters

None

Command Mode

Configure mode

Applicability

This command was introduced before OcNOS version 1.3.

Examples

```
#configure terminal
(config)#router ipv6 rip
(config-router)#
```

show debugging ipv6 rip

Use this command to display the RIPng debugging status for RIPng NSM, RIPng events, and RIPng packets.

Command Syntax

```
show debugging ipv6 rip
```

Parameters

None

Command Mode

Exec Mode and Privileged Exec Mode

Applicability

This command was introduced before OcNOS version 1.3.

Example

```
#show debugging ipv6 rip
RIPng packet debugging is on
```

show ipv6 protocols rip

Use this command to display RIPng process parameters and statistics.

Command Syntax

```
show ipv6 protocols rip
```

Parameters

None

Command Mode

Exec mode and Privileged Exec mode

Applicability

This command was introduced before OcNOS version 1.3.

Example

The following is a sample output from the `show ipv6 protocols rip` command.

```
#show ipv6 protocols rip
Routing Protocol is "ripng"
  Sending updates every 30 seconds with +/-50%, next due in 10 seconds
  Timeout after 180 seconds, garbage collect after 120 seconds
  Outgoing update filter list for all interface is not set
  Incoming update filter list for all interface is not set
  Default redistribute metric is 1
  Redistributing: connected
  Routing for Networks:
    3ffe:1::/64
#
```

show ipv6 rip

Use this command to show RIP routes.

Command Syntax

```
show ipv6 rip (database|)
```

Parameters

database Specify to display information about the IPv6 RIP database.

Command Mode

Exec mode and Privileged Exec mode

Applicability

This command was introduced before OcnOS version 1.3.

Example

The following is a sample output from the show ipv6 rip database command.

```
#show ipv6 rip database
Codes: R - RIP, K - Kernel, C - Connected, S - Static, O - OSPF, I - IS-IS,
B - BGP, a - aggregate, s - suppressed
Network Next Hop If Met Tag Time
R 3ffe:1234:5678::/64 fe80::3 eth1 3 0 02:28
C 3ffe:ffff:1::/64 :: eth0 1 0
Ra 3ffe:ffff:2::/48 -- 1 0
Rs 3ffe:ffff:2::/48 fe80::3 eth1 3 0 02:32
Cs 3ffe:ffff:2::/64 :: eth1 1 0
R 3ffe:ffff:ffff:ffff::/64 fe80::3 eth1 3 0 02:28
```

show ipv6 rip interface

Use this command to display information about the RIPng interfaces. You can specify an interface name to display information about a specific interface.

Command Syntax

```
show ipv6 rip interface (IFNAME|)
```

Parameters

IFNAME Name of the interface for which information is to be displayed.

Command Mode

Exec mode and Privileged Exec mode

Applicability

This command was introduced before OcNOS version 1.3.

Example

The following is a sample output from the `show ipv6 rip interface` command.

```
#show ipv6 rip interface
lo is up, line protocol is up
RIPng is not enabled on this interface
eth0 is up, line protocol is up
RIPng is not enabled on this interface
eth1 is down, line protocol is down
RIPng is not enabled on this interface
eth2 is up, line protocol is up
Routing Protocol: RIPng
Passive interface: Disabled
Split horizon: Enabled with Poisoned Reversed
IP interface address:
3ffe:ffff::1/64
3ffe:fffe::1/64
```

timers basic

Use this command to adjust routing network timers.

Use the `no` parameter with this command to restore the defaults.

For more details about this command, see the IPv4 version of this command ([timers basic](#)).

Command Syntax

```
timers basic <5-2147483647> <5-2147483647> <5-2147483647>
no timers basic
```

Parameters

- <5-2147483647> Specify the routing table update timer in seconds. The default is 30 seconds.
- <5-2147483647> Specify the routing information timeout timer in seconds. The default is 180 seconds. After this interval has elapsed and no updates for a route are received, the route is declared invalid.
- <5-2147483647> Specify the routing garbage collection timer in seconds. The default is 120 seconds.

Command Mode

Router mode

Applicability

This command was introduced before OcNOS version 1.3.

Examples

```
#configure terminal
(config)#router ipv6 rip
(config-router)#timers basic 30 180 120

(config)#router ipv6 rip
(config-router)#no timers basic
```

CHAPTER 3 Routing Information Protocol VPN Commands

This chapter provides information about RIP VPN commands. These commands are available when the RIP Provider Edge (PE) and Customer Edge (CE) feature is supported. Using these commands, VPN you can use RIP to receive information which the CE-router places into the connected Virtual Routing and Forwarding (VRF) from the receiving interface. The information is then advertised across the MPLS/VPN backbone between PE-routers.

To provide a VPN service, the PE-router needs to be configured so that any routing information learned from a VPN customer interface can be associated with a particular VRF. This is achieved using any standard routing protocol process (RIP, OSPF, BGP or static routes etc).

This chapter contains the following commands:

- `show ip rip interface vrf`
- `show ip rip vrf`
- `show ip vrf`

show ip rip interface vrf

Use this command to display VRF information. This command is supported in RIP (IPv4).

Command Syntax

```
show ip rip interface vrf WORD (IFNAME|)
```

Parameters

WORD	Specify the name for the VRF instance.
IFNAME	Specify name for the interface.

Default

None

Command Mode

Exec mode and Privileged Exec mode

Applicability

This command was introduced before OcnOS version 1.3.

Example

```
#show ip rip interface vrf myVRF

eth1 is up, line protocol is up
  Routing Protocol: RIP
    VPN Routing/Forwarding: myVRF
    Receive RIP packets
    Send RIP packets
    Passive interface: Disabled
    Split horizon: Enabled with Poisoned Reversed
    IP interface address:
      1.1.1.92/24
eth3 is up, line protocol is up
  RIP is not enabled on this interface
```

[Figure 3-77](#) Explains the show command output details.

Table 3-77: Show ip rip interface vrf output details

Field	Description
Routing Protocol	Specifies the routing protocol used.
VPN Routing/Forwarding	Specifies the name of the virtual routing and forwarding (VRF) instance.
Receive RIP packets	Number of RIP packets that were received on this interface.
Send RIP packets	Number of RIP packets that were send on this interface.
Passive Interface	Used in all routing protocols to disable sending updates out from a specific interface.

Split horizon	the routing switch does not advertise a route on the same interface as the one on which the routing switch learned the route.
IP Interface address	IP address of the RIP peer neighbor.

show ip rip vrf

Use this command to display VRF information. This command is supported in RIP (IPv4).

Command Syntax

```
show ip rip (database) vrf WORD
```

Parameters

database Specify to display information about the IP RIP database.
WORD Specify the name for the VRF instance.

Default

None

Command Mode

Privileged Exec mode and Exec mode

Applicability

This command was introduced before OcnOS version 1.3.

Examples

```
#show ip rip database vrf myVRF
Codes: R - RIP, Rc - RIP connected, Rs - RIP static, K - Kernel,
       C - Connected, S - Static, O - OSPF, I - IS-IS, B - BGP
```

	Network	Next Hop	Metric	From	If	Time
Rc	1.1.1.0/24		1		eth1	
S	72.72.75.0/24	98.98.8.2	1		eth3	

[Table 3-78](#) shows the status codes displayed at the start of a route entry.

Table 3-78: Status codes

Status Code	Meaning	Description
R	RIP	RIP prevents routing loops by implementing a limit on the number of hops allowed in a path from source to destination.
Rc	RIP Connected	Redistribute from locally RIP connected networks.
Rs	RIP Static	Connections in a RIP static network are fixed links, while connections in a dynamic network are established on the fly as needed.
K	Kernel	Kernel is central component of operating system.
C	Connected	Redistribute from locally connected networks.

Rs	RIP Static	Connections in a RIP static network are fixed links, while connections in a dynamic network are established on the fly as needed.
O	OSPF	Open Shortest Path First (OSPF) is a routing protocol for Internet Protocol (IP) networks.
I	IS-IS	Intermediate System to Intermediate System (IS-IS) is a routing protocol designed to move information efficiently within a host network.
B	BGP	BGP makes routing decisions based on paths, rules or network policies configured by a network administrator.
	Network	IP address of a network entity.
	Nextthop	IP address of the next system that is used when forwarding a packet to the destination network.
	Metric	If shown, the value of the inter-autonomous system metric.

Figure 3-79 Explains the show command output details.

Table 3-79: Show ip rip vrf output details

Field	Description
Network	IP address of a network entity.
Nextthop	IP address of the next system that is used when forwarding a packet to the destination network.
Metric From	If shown, the value of the inter-autonomous system metric.
If	Ethernet interface.
Time	Specifies the time between forwarding packets.

show ip vrf

Use this command to display VRF information. This command is supported in RIP (IPv4).

Command Syntax

```
show ip vrf
show ip vrf WORD
```

Parameters

WORD Specify the name for the VRF instance.

Default

None

Command Mode

Exec mode and Privileged Exec mode

Applicability

This command was introduced before OcnOS version 1.3.

Example

```
#show ip vrf myVRF

VRF myVRF, FIB ID 1
Router ID: 1.1.1.2 (config)
Interfaces:
  eth1
  eth3
VRF myVRF; (id=1); RIP enabled Interfaces:
  eth1
```

Appendix A Routing Information Protocol Authentication

To support RIPv2 message authentication, you can choose plain text or MD5 authentication, with the option for a single key or multiple keys in different modes and stages.

Single Key Authentication

Use the following steps to configure route to enable RIPv2 authentication using a single key or password:

1. Define the authentication string or password

In the Interface mode, specify the authentication string or password used by the key using the following command:

```
ip rip authentication string LINE
```

where `LINE` is the authentication string or password

2. Specify mode of authentication for the interface

In the Interface mode, specify either text or MD5 authentication using the following command:

```
ip rip authentication mode md5|text
```

Example

```
#configure terminal
(config)#interface eth0
(config-if)#ip rip authentication string mykey
(config-if)#ip rip authentication mode md5
```

Multiple Keys Authentication

Use the following steps to configure route to enable RIPv2 authentication using multiple keys at different times:

1. Define a key chain

In the Configure mode, identify a key chain with a key chain name using the following command:

```
key chain KEYNAME
```

where `KEYNAME` is the name of the chain to manage.

2. Define the key(s)

In the Keychain mode, specify a key on this key chain using the following command:

```
key-id KEYID
```

where `KEYID = <0-2147483647>` Key Identifier number

3. Define the authentication string or password

In the Keychain-key mode, define the password used by a key, using the following command:

```
key-string WORD
```

where `WORD` is a string of characters to be used as a password by the key.

4. Set key management options

This step can be performed at this stage or later when multiple keys are used. The options are configured in the `keychain-key` command mode.

- Set the time period during which the authentication key on a key chain is received as valid, using the following command:

```
accept-lifetime START END
```

where *START* and *END* are the beginning and end of the time period.

- Set the time period during which the authentication key on a key chain can be sent using the following command:

```
send-lifetime START END
```

where *START* and *END* are the beginning and end of the time period.

5. Enable authentication on an interface

In the Interface mode, enable authentication on an interface and specify the key chain to be used, using the following command:

```
ip rip authentication key-chain CHAINNAME
```

where *CHAINNAME* is a set of valid authentication keys

6. Specify mode of authentication for the interface

In the Interface mode, specify either text or MD5 authentication using the following command:

```
ip rip authentication mode md5|text
```

Example

In the following example, a password *toyota* is set for a *key-id 1* in a key chain *cars*. On Interface *eth0* authentication is enabled and the authentication mode is set as MD5.

```
#configure terminal
(config)#key chain cars
(config-keychain)#key-id 1
(config-keychain-key)#key-string toyota
(config-keychain-key)#accept-lifetime 10:00:00 Oct 08 2002 duration 43200
(config-keychain-key)#send-lifetime 10:00:00 Oct 08 2002 duration 43200
(config-keychain-key)#exit
(config-keychain)#exit
(config)#interface eth0
(config-if)#ip rip authentication key-chain cars
(config-if)#ip rip authentication mode md5
(config-if)#exit
```

Two-Way Active Measurement Protocol Command Reference

CHAPTER 1 TWAMP Commands

This chapter describes the commands used to manage the Two-Way Active Measurement Protocol (TWAMP).

Note: The implementation of TWAMP measurement relies on software timestamps collected at the application layer. The measured packet path in this case is longer than the actual link path and thus the timestamps used in the delay measurement are less accurate.

- [control-admin-state](#)
- [reflector-admin-state](#)
- [reflector-name](#)
- [show debugging twamp](#)
- [show running-config twamp](#)
- [show twamp server sessions information](#)
- [show twamp statistics](#)
- [show twamp server status](#)
- [test-session-name \(Deprecated\)](#)
- [twamp-light control](#)
- [twamp-light reflector](#)
- [twamp server](#)
- [twamp server port](#)
- [twamp server max-connection-duration](#)
- [twamp server max-connections](#)
- [twamp server max-connections-per-client](#)
- [twamp server maximum-sessions](#)
- [twamp server maximum-sessions-per-connection](#)
- [twamp server inactivity-timeout](#)
- [twamp server listen-vrf](#)
- [twamp server admin state](#)
- [twamp start-test-session \(Deprecated\)](#)
- [twamp stop-test-session \(Deprecated\)](#)

control-admin-state

Use this command to enable or disable the TWAMP sender framework. The sender framework needs to be enabled before configuring any TWAMP sessions.

Command Syntax

```
control-admin-state (enable | disable)
```

Parameters

enable	Enable the TWAMP sender framework.
disable	Disable the TWAMP sender framework.

Default

Disable

Command Mode

TWAMP light control mode (config-twamp-light-ctrl)

Applicability

This command was introduced before OcnOS version 3.0.

Example

```
(config)#twamp-light control  
(config-twamp-light-ctrl)#control-admin-state enable
```

reflector-admin-state

Use this command to enable or disable the TWAMP reflector framework. The reflector framework needs to be enabled before configuring any reflector session.

Command Syntax

```
reflector-admin-state (enable | disable)
```

Parameters

enable	Enable the TWAMP reflector framework.
disable	Disable the TWAMP reflector framework.

Default

Disabled

Command Mode

TWAMP light reflector mode (config-twamp-light-ctrl)

Applicability

This command was introduced before OcnOS version 3.0.

Example

```
(config)#twamp-light reflector  
(config-twamp-light-ctrl)#reflector-admin-state enable
```

reflector-name

Use this command to configure a TWAMP light reflector session.

Command Syntax

```
reflector-name WORD reflector-ip (ipv4 A.B.C.D|ipv6 X:X::X:X|HOSTNAME) (reflector-  
port (862|<1025-65535>)|) (vrf NAME|) (sender-ip (ipv4 A.B.C.D|ipv6  
X:X::X:X|HOSTNAME)|) (sender-port (862|<1025-65535>)|)
```

Parameters

WORD	Set TWAMP Light reflector session name
X:X::X:X	TWAMP Reflector IP address in IPv6 format.
A.B.C.D	TWAMP Reflector IP address in IPv4 format.
HOSTNAME	The hostname of the TWAMP reflector
vrf NAME	Set TWAMP Light reflector session VRF name
reflector-port	Set the TWAMP Reflector UDP port number where the reflector will be listening
sender-ip	Set the sender IP from which the reflector will accept the TWAMP packets. If the source of the TWAMP packet does not match this address, the packet will be ignored. In case not set, the reflector will not discriminate on the sender IP value.
sender-port	Set the sender UDP port from which the reflector will accept the TWAMP packets. In case not set, the reflector will not discriminate on the sender UDP port value.

Default

862 for reflector-port

0 for the sender-port (interpreted as no filtering on sender port)

Command Mode

TWAMP light reflector mode (config-twamp-light-ctrl)

Applicability

This command was introduced before OcnOS version 5.1.

The sender-IP and sender-port parameters were added in OcnOS version 6.0.0

Example

```
(config)#twamp-light reflector  
(config-twamp-light-ref)# reflector-name R11 reflector-ip 23.1.1.1 vrf vrf1  
(config-twamp-light-ref)# reflector-name R12 reflector-ip 24.1.1.1 vrf vrf2  
(config-twamp-light-ref)# reflector-name R12 reflector-ip 24.1.1.1 sender-ip  
24.1.1.2 vrf vrf2  
(config-twamp-light-ref)# reflector-name R12 reflector-ip 24.1.1.1 sender-ip  
24.1.1.2 sender-port 1555 vrf vrf2
```

show debugging twamp

Use this command to display the status of debug information of the TWAMP.

Command Syntax

```
show debugging twamp
```

Parameters

None

Default

Debug status is off.

Config Mode

Exec mode and Privileged Exec mode

Applicability

This command was introduced in OcNOS version 6.1.0.

Examples

```
OcNOS#show debugging twamp  
TWAMP debugging status: OFF
```

show running-config twamp

Use this command to display TWAMP running configuration alone.

Command Syntax

```
show running-config twamp
```

Parameters

None

Command Mode

Exec mode and Privileged Exec mode

Applicability

This command was introduced before OcNOS version 3.0.

Examples

Reflector:

```
#show running-config twamp
twamp-light reflector
  reflector-admin-state enable
  reflector-ip 10.0.0.1 reflector-port 1234
```

Control or Sender:

```
#show running-config twamp
twamp-light control
  control-admin-state enable
  test-session-name s1 sender-ip 10.0.0.1 sender-port 1234 reflector-ip
10.0.0.1 reflector-port 1234
```

show twamp server sessions information

Show the existing sessions information

Command Syntax

```
show twamp server session (WORD|)
```

Parameters

WORD The session ID

Default

None

Command mode

Exec mode

Applicability

This command was introduced in OcNOS version 6.2.0

Examples

```
OcNOS# show twamp server session
Connection ID      Session Id          Sender
Receiver          State
91.91.91.2        1 5B.5B.5B.03:E00FD9FF99B7F173:D8CE5E5D
                  91.91.91.3        Started
9.1.9.1           2 5B.5B.5B.03:E00FCF8221DF548E:EF824500
                  91.91.91.3        Started
```

```
OcNOS# show twamp server session 5B.5B.5B.03:E00FCF8221DF548E:EF824500
State              : Started
Connection ID     : 2
Session ID        : 5B.5B.5B.03:E00FCF8221DF548E:EF824500
Sender address    : 9.1.9.1
Sender port       : 44566
Receiver address  : 91.91.91.3
Receiver port     : 44001
Receiver VRF      : default
Start time        : 2022-08-31 16:44:00
Timeout           : 5 sec
OcNOS#
```

show twamp statistics

Use this command to display TWAMP test session.

Command Syntax

```
show twamp-statistics (WORD|)
```

Parameters

WORD TWAMP test session name.

Command Mode

Exec mode and Privileged Exec mode

Applicability

This command was introduced before OcnOS version 3.0.

Examples

```
#show twamp statistics
=====
TWAMP Test-Session Statistics
=====
Test-Session Name      : s1
Start Time             : 2019 Aug 05 08:40:12
Elapsed time(milli sec) : 4004
Packets Sent          : 4
Packets Received      : 4
Packet Loss(%)        : 0.0000
Round Trip Delay(usec)
  Minimum              : 585
  Maximum              : 2306
  Average              : 1038
Forward Delay(usec)
  Minimum              : 254
  Maximum              : 318
  Average              : 280
Reverse Delay(usec)
  Minimum              : 331
  Maximum              : 1988
  Average              : 758
Round Trip Delay Variation(usec)
  Minimum              : 2306
  Maximum              : 2640
  Average              : 2444
Forward Delay Variation(usec)
  Minimum              : 318
  Maximum              : 375
  Average              : 345
Reverse Delay Variation(usec)
  Minimum              : 1988
  Maximum              : 2265
  Average              : 2099
```

Table 1-80: show twamp statistics fields

Field	Description
Test-Session Name	TWAMP test session name
Start Time	TWAMP test start time
Elapsed time(milli sec)	Time taken to complete the test in milliseconds
Packets Sent	Number of packet sent
Packets Received	Number of packet received
Packet Loss(%)	Packet lost in percentage
Round Trip Delay(usec)	Round trip delay between TWAMP sender and reflector. Displayed Minimum, Maximum and Average round trip delay in micro-seconds
Forward Delay(usec)	Forward delay between TWAMP sender and reflector. Displayed Minimum, Maximum and Average forward delay in micro-seconds In case the clocks on the sender and reflector are not in sync, a (*) will be displayed here.
Reverse Delay(usec)	Reverse delay between TWAMP reflector and sender. Displayed Minimum, Maximum and Average reverse delay in micro-seconds In case the clocks on the sender and reflector are not in sync, a (*) will be displayed here.
Round Trip Delay Variation(usec)	Round trip delay variation between TWAMP sender and reflector. Displayed Minimum, Maximum and Average round trip delay variation in micro-seconds
Forward Delay Variation(usec)	Forward delay variation between TWAMP sender and reflector. Displayed Minimum, Maximum and Average forward delay variation in micro-seconds In case the clocks on the sender and reflector are not in sync, a (*) will be displayed here.
Reverse Delay Variation(usec)	Reverse delay variation between TWAMP reflector and sender. Displayed Minimum, Maximum and Average reverse delay variation in micro-seconds In case the clocks on the sender and reflector are not in sync, a (*) will be displayed here.

show twamp server status

Show the general status of the TWAMP server

Command Syntax

```
show twamp server status
```

Parameters

None

Default

None

Command mode

Exec mode

Applicability

This command was introduced in OcNOS version 6.2.0.

Examples

```
OcNOS#show twamp server status
Status           : Enabled
Listening Port   : 862
Server VRF list  : management default vrf1
Number of connections : 3
Number of sessions : 15
Number of running sessions: 5
OcNOS#
```

test-session-name (Deprecated)

This command is not supported anymore. The “delay-measurement dynamic twamp” command under interface mode should be used to start twamp measurement instead.

Use this command to configure the TWAMP test sessions.

Use the `no` form of this command to un-configure or remove the configured TWAMP test sessions.

Notes:

- The `dscp-to-queue` mapping is performed for egress only when the sender port has the default value 862. Otherwise, Queue-6 will always be used.
- The `dscp-to-queue` mapping is done based on the first 3 bits of the `dscp` value.
- If `dscp` is not supplied (value 0), Queue-6 will always be used.

Command Syntax

```
test-session-name WORD sender-ip (A.B.C.D|X:X::X:X|HOSTNAME) (sender-port
(862|<1025-65535>)|) reflector-ip (A.B.C.D|X:X::X:X|HOSTNAME) (reflector-port
(862|<1025-
65535>)|) (dscp (default|cs1|af11|af12|af13|cs2|af21|af22|af23|cs3|af31|af32|af33|
cs4|af41|af42|af43|cs5|ef|cs6|cs7|<0-63>)|)
no test-session-name WORD
```

Parameters

WORD	TWAMP test session name.
X:X::X:X	TWAMP Sender or Reflector IP address in IPv6 format.
A.B.C.D	TWAMP Sender or Reflector IP address in IPv4 format.
<1025-65535>	TWAMP Sender or Reflector UDP port number.
dscp	The DSCP value to used by the sender for TWAMP messages. This can be an explicit value 0-63, or it can be a well-known name: (af11 af12 af13 af21 af22 af23 af31 af32 af33 af41 af42 af43 cs1 cs2 cs3 cs4 cs5 cs6 cs7 default ef)

Default

The `sender-port` and `reflector-port` default values are 862.

The `dscp` default value is 0.

Command Mode

TWAMP light control mode (config-twamp-light-ctrl)

Applicability

This command was introduced before OcnOS version 3.0. The `dscp` parameter was added in OcnOS version 5.0.

Examples

To configure:

```
(config)#twamp-light control
```

TWAMP Commands

```
(config-twamp-light-ctrl)# test-session-name s1 sender-ip 10.0.0.1 sender-port  
1234 reflector-ip 10.0.0.1 reflector-port 1234 dscp af23
```

To un-configure:

```
(config)#twamp-light control  
(config-twamp-light-ctrl)# no test-session-name s1
```

twamp-light control

Use this command to initialize the TWAMP light Control or Sender Session.

Use the `no` form of this command to un-initialize and to remove the configured TWAMP light control configurations.

Command Syntax

```
twamp-light control
no twamp-light control
```

Parameters

NA

Command Mode

Configuration mode

Applicability

This command was introduced before OcnOS version 3.0.

Example

```
#configure terminal
(config)#twamp-light control
```

twamp-light reflector

Use this command to initialize the TWAMP reflector.

Use the `no` form of this command to un-initialize and to remove the configured TWAMP light reflector configurations.

Command Syntax

```
twamp-light reflector
no twamp-light reflector
```

Parameters

NA

Command Mode

Configuration mode

Applicability

This command was introduced before OcnOS version 3.0.

Examples

```
#configure terminal
(config)#twamp-light reflector
```

twamp server

Use this command to change to the twamp server mode.

Command Syntax

```
twamp server
```

Parameters

None

Default

-

Command mode

Config mode

Applicability

This command was introduced in OcNOS version 6.2.0

Examples

```
OcNOS (config) #  
OcNOS (config) #twamp server  
OcNOS (config-twamp-server) #
```

twamp server port

Use this command to set the twamp server mode TCP listen port.

Use the no form of this command to reset the port value to the default value 862.

Command Syntax

```
port (862|<1025-65535>)
```

Parameters

<1025-65535> Set the TCP port value where the twamp server will be listening. It could be either the default value 862, or in the range 1025-65535.

Default

Default value is 862

Command mode

twamp-server mode

Applicability

This command was introduced in OcnOS version 6.2.0.

Examples

```
OcnOS(config)#twamp server
OcnOS(config-twamp-server)#port 2555
OcnOS(config-twamp-server)#commit
OcnOS(config-twamp-server)#no port
OcnOS(config-twamp-server)#commit
OcnOS(config-twamp-server)#
```

twamp server max-connection-duration

Use this command to set the maximum connection duration that a client can establish with the server in hours. The default value of this flag is 0, which means that there is no limit for the connection duration.

Use the no form of this command to set the value to the default value 0.

Command Syntax

```
max-connection-duration <0-120>
```

Parameters

<0-120> Set the maximum connection duration value between 0 and 120 hours.

Default

Default value is 0

Command mode

twamp-server mode

Applicability

This command was introduced in OcNOS version 6.2.0

Examples

```
OcNOS(config)#twamp server
OcNOS(config-twamp-server)#max-connection-duration 5
OcNOS(config-twamp-server)#commit
OcNOS(config-twamp-server)#no max-connection-duration
OcNOS(config-twamp-server)#commit
OcNOS(config-twamp-server)#
```

twamp server max-connections

Use this command to set the maximum number of connections that the server can simultaneously handle. The default value of this flag is 16.

Use the no form of this command to set the value to the default value 16.

Command Syntax

```
max-connections <1-32>
```

Parameters

<1-32> Set the maximum number of connections value between 1 and 32.

Default

Default value is 16

Command mode

twamp-server mode

Applicability

This command was introduced in OcNOS version 6.2.0

Examples

```
OcNOS(config)#twamp server
OcNOS(config-twamp-server)#max-connections 12
OcNOS(config-twamp-server)#commit
OcNOS(config-twamp-server)#no max-connections
OcNOS(config-twamp-server)#commit
OcNOS(config-twamp-server)#
```

twamp server max-connections-per-client

Use this command to set the maximum number of connections that the server can simultaneously handle from the same client (same IP). The default value of this flag is 1.

Use the no form of this command to set the value to the default value 1.

Command Syntax

```
maximum-connections-per-client <1-4>
```

Parameters

<1-4> Set the maximum number of connections per client value between 1 and 4.

Default

Default value is 1

Command mode

twamp-server mode

Applicability

This command was introduced in OcNOS version 6.2.0

Examples

```
OcNOS(config)#twamp server
OcNOS(config-twamp-server)#max-connections-per-client 3
OcNOS(config-twamp-server)#commit
OcNOS(config-twamp-server)#no max-connections-per-client
OcNOS(config-twamp-server)#commit
OcNOS(config-twamp-server)#
```

twamp server maximum-sessions

Use this command to set the maximum number of sessions that the server can simultaneously handle. The default value of this flag is 64.

Use the no form of this command to set the value to the default value 64.

Command Syntax

```
maximum-sessions <1-64>
```

Parameters

<1-64> Set the maximum number of sessions between 1 and 64.

Default

Default value is 64

Command mode

twamp-server mode

Applicability

This command was introduced in OcNOS version 6.2.0

Examples

```
OcNOS(config)#twamp server
OcNOS(config-twamp-server)#maximum-sessions 44
OcNOS(config-twamp-server)#commit
OcNOS(config-twamp-server)#no max
OcNOS(config-twamp-server)#no maximum-sessions
OcNOS(config-twamp-server)#commit
OcNOS(config-twamp-server)#
```

twamp server maximum-sessions-per-connection

Use this command to set the maximum number of sessions that the server can simultaneously accept on the same connection. The default value of this flag is 1.

Use the no form of this command to set the value to the default value 1.

Command Syntax

```
maximum-sessions-per-connection <1-64>
```

Parameters

<1-64> Set the maximum number of sessions per connection between 1 and 64.

Default

Default value is 1

Command mode

twamp-server mode

Applicability

This command was introduced in OcNOS version 6.2.0

Examples

```
OcNOS(config)#twamp server
OcNOS(config-twamp-server)#maximum-sessions-per-connection 26
OcNOS(config-twamp-server)#commit
OcNOS(config-twamp-server)#no maximum-sessions-per-connection
OcNOS(config-twamp-server)#commit
OcNOS(config-twamp-server)#
```

twamp server inactivity-timeout

Use this command to set the inactivity timeout in minutes. In case the server does not receive any control packet from the client during this timeout, the connection to the client is dropped and any session started by this client will be stopped.

The default value of this flag is 0. In this case the server does not check for inactivity from the client.

Use the no form of this command to set the value to the default value 0.

Command Syntax

```
inactivity-timeout <0-30>
```

Parameters

<0-30> Set the inactivity timeout to a value between 0 and 30 in minutes.

Default

Default value is 0

Command mode

twamp-server mode

Applicability

This command was introduced in OcNOS version 6.2.0

Examples

```
OcNOS(config)#twamp server
OcNOS(config-twamp-server)#inactivity-timeout 22
OcNOS(config-twamp-server)#commit
OcNOS(config-twamp-server)#no inactivity-timeout
OcNOS(config-twamp-server)#commit
OcNOS(config-twamp-server)#
```

twamp server listen-vrf

Use this command to add custom VRFs to the list of VRFs where the TWAMP server is running. If no listen-vrf is specified, the TWAMP server is started in the default VRF only.

Multiple VRFs can be specified. The user can issue the same command multiple times, once for each VRF.

Only clients in the configured VRFs are allowed to connect to the server and only sessions to IPs in the configured VRFs are allowed to be established.

Use the no form of this command to delete a listen-vrf.

Command Syntax

```
listen-vrf <NAME>
no listen-vrf <NAME>
```

Parameters

NAME VRF name to add to the server.

Default

Default value is "default"

Command mode

twamp-server mode

Applicability

This command was introduced in OcNOS version 6.2.0.

Examples

```
OcNOS(config)#twamp server
OcNOS(config-twamp-server)#listen-vrf default
OcNOS(config-twamp-server)#listen-vrf management
OcNOS(config-twamp-server)#listen-vrf vrf1
OcNOS(config-twamp-server)#commit
OcNOS(config-twamp-server)#
OcNOS(config-twamp-server)#no listen-vrf management
OcNOS(config-twamp-server)#commit
OcNOS(config-twamp-server)#
```

twamp server admin state

Use this command to Start/Stop the TWAMP server with the above configured parameters.

In case any of the twamp server parameters are modified after the server is started, the modification will be applied after the server is stopped and started again.

Command Syntax

```
server-admin-state (enable|disable)
```

Parameters

enable	Start the TWAMP server
disable	Stop the TWAMP server

Default

Default value is disable

Command mode

twamp-server mode

Applicability

This command was introduced in OcNOS version 6.2.0

Examples

```
OcNOS(config)#twamp server
OcNOS(config-twamp-server)#server-admin-state enable
OcNOS(config-twamp-server)#commit
OcNOS(config-twamp-server)#server-admin-state disable
OcNOS(config-twamp-server)#commit
OcNOS(config-twamp-server)#
```

twamp start-test-session (Deprecated)

This command is not supported anymore. The “delay-measurement dynamic twamp” command under interface mode should be used to start twamp measurement instead.

Use this command to start the TWAMP test session.

Command Syntax

```
twamp start test-session WORD packet-count <1-65535> (interval <500-10000>|)
(delay-threshold <0-1000000|)
```

Parameters

WORD	TWAMP test session name.
<1-65535>	Number packed to send for test.
<500-10000>	Interval to send each packet in milliseconds.
<0-1000000>	Delay threshold, in microseconds (default = 0). A notification is sent when the average delay crosses this value during the measurement. However, no checking is carried on the delay value when it is set to 0, hence, no notification is sent.

Default

1000 for interval

Command Mode

Privileged Exec mode

Applicability

This command was introduced before OcnOS version 3.0.

Examples

```
#twamp start test-session s1 packet-count 10 interval 500 delay-threshold 100
```

twamp stop-test-session (Deprecated)

This command is not supported anymore. The “delay-measurement dynamic twamp” command under interface mode should be used to start/stop twamp measurement instead.

Use this command to stop the TWAMP test session.

Command Syntax

```
twamp stop test-session WORD
```

Parameters

WORD TWAMP test session name.

Default

NA

Command Mode

Privileged Exec mode

Applicability

This command was introduced before OcNOS version 3.0.

Examples

```
#twamp stop test-session s1
```

Show twamp server connections information

Show the existing connections information

Command Syntax

```
show twamp server connection (WORD|)
```

Parameters

WORD The connection ID

Default

None

Command mode

Exec mode

Applicability

This command was introduced in OcNOS version 6.2.0

Examples

```
OcNOS# show twamp server connection
Connection ID Client Address   Client Port
           1      100.1.0.1           59807
           2      100.1.0.2           59808
           3      100.1.0.3           59809
           4      100.1.0.4           59810

OcNOS# show twamp server connection 2
Connection ID      : 2
Client Address     : 100.1.0.2
Client Port        : 59808
Client VRF         : default
State              : Control session established
Connection Time    : Thu Feb 14 12:13:51 2019
Last Activity Time : Thu Feb 14 12:13:51 2019
Number of session requests : 7
Number of accepted sessions: 3
OcNOS#
```

Layer 3 Subinterface Commands

CHAPTER 1 Layer 3 Subinterface Commands

This chapter describes the Layer 3 subinterface commands:

- `encapsulation`
- `interface IFNAME.SUBINTERFACE_ID`
- `show interface IFNAME.SUBINTERFACE_ID`

encapsulation

Use this command to configure encapsulation under a subinterface. Using this command, a Layer 3 subinterface can be configured as a port-vlan or stacked vlan. Before configuring the encapsulation on sub-interface, the operating state of the sub-interface is admin down. After configuring the encapsulation, the operating state of the sub-interface becomes up.

Command Syntax

```
encapsulation ((dot1q|dot1ad) VLAN_ID (inner-dot1q VLAN_ID|))
no encapsulation
```

Parameters

dot1q	IEEE 802.1Q VLAN-tagged packets
dot1ad	IEEE 802.1ad VLAN-tagged packets
VLAN_ID	First (outer) VLAN identifier on the subinterface <2-4094>
inner-dot1q VLAN_ID	Second (inner 802.1Q) VLAN identifier on the subinterface <2-4094>

Command Mode

Interface mode

Applicability

This command was introduced in OcnOS version 3.0.

Example

```
#configure terminal
(config-if)#interface xe9.1
(config-if)#encapsulation dot1q 10

(config-if)#interface xe9.2
(config-if)#encapsulation dot1q 20 inner-dot1q 20

(config-if)#interface xe9.3
(config-if)#encapsulation dot1ad 30

(config-if)#interface xe9.4
(config-if)#encapsulation dot1ad 40 inner-dot1q 40
```

interface IFNAME.SUBINTERFACE_ID

Use this command to configure a subinterface. Subinterfaces are supported for raw Ethernet interfaces as well as dynamic/static LAG interfaces. The number of subinterfaces supported is 2000 per parent port and a total of 4000 subinterfaces per device. This command displays an error when the identifier of the subinterface is out of range.

Use `no` form of this command to unconfigure a sub-interface.

Command Syntax

```
interface IFNAME.SUBINTERFACE_ID
no interface IFNAME.SUBINTERFACE_ID
```

Parameters

IFNAME	Interface name, such as xe1, po1, or sa1
SUBINTERFACE_ID	Subinterface identifier <1-2000>

Command Mode

Interface mode

Applicability

This command was introduced in OcNOS version 3.0.

Example

```
(config)#int xe1.5
(config-if)#exit
(config)#no interface xe1.5

(config)#int po1
(config-if)#exit
(config)#int po1.1
(config-if)#exit
(config)#no interface po1.1

(config)#int sa1
(config-if)#exit
(config)#int sa1.1
(config-if)#exit
(config)#no interface sa1.1
```

show interface IFNAME.SUBINTERFACE_ID

Use this command to display the details of the sub-interface. This command displays the information about the operating status, hardware address, VRF binding details, and input/output counters. This command can display details of the a sub-interface for a dynamic/static LAG as well.

Command Syntax

```
show interface IFNAME.SUBINTERFACE_ID
```

Parameters

IFNAME	Interface name, such as xe1, po1, or sa1
SUBINTERFACE_ID	Subinterface identifier <1-2000>

Command Mode

Exec mode

Applicability

This command was introduced in OcNOS version 3.0.

Example

```
#show int xe1.1
Interface xe1.1
  Hardware is SUBINTERFACE Current HW addr: 6cb9.c500.1647
  Physical:6cb9.c500.1647 Logical:(not set)
  Port Mode is Router
  Interface index: 20482049
  Metric 1 mtu 1500
  <UP,BROADCAST,RUNNING,MULTICAST>
  VRF Binding: Not bound
  Label switching is disabled
  No Virtual Circuit configured
  Administrative Group(s): None
  DHCP client is disabled.
  Last Flapped: Never
  Statistics last cleared: Never
  inet6 fe80::6eb9:c5ff:fe00:1647/64
RX
  unicast packets 0 multicast packets 0 broadcast packets 0
  input packets 0 bytes 0
  jumbo packets 0
  undersize 0 oversize 0 CRC 0 fragments 0 jabbers 0
  input error 0
  input with dribble 0 input discard 0
  Rx pause 0
TX
  unicast packets 0 multicast packets 0 broadcast packets 0
```

```
output packets 0 bytes 0
jumbo packets 0
output errors 0 collision 0 deferred 0 late collision 0
output discard 0
Tx pause 0
```

```
#show int sa1.1
```

```
Interface sa1.1
```

```
Hardware is SUBINTERFACE Current HW addr: 6cb9.c500.1647
Physical:6cb9.c500.1647 Logical:(not set)
Port Mode is Router
Interface index: 409602049
Metric 1 mtu 1500
<UP,BROADCAST,RUNNING,MULTICAST>
VRF Binding: Not bound
Label switching is disabled
No Virtual Circuit configured
Administrative Group(s): None
DHCP client is disabled.
Last Flapped: Never
Statistics last cleared: Never
inet6 fe80::6eb9:c5ff:fe00:1647/64
RX
```

```
unicast packets 0 multicast packets 0 broadcast packets 0
input packets 0 bytes 0
jumbo packets 0
undersize 0 oversize 0 CRC 0 fragments 0 jabbers 0
input error 0
input with dribble 0 input discard 0
Rx pause 0
```

```
TX
```

```
unicast packets 0 multicast packets 0 broadcast packets 0
output packets 0 bytes 0
jumbo packets 0
output errors 0 collision 0 deferred 0 late collision 0
output discard 0
Tx pause 0
```

```
#show int po1.3
```

```
Interface po1.3
```

```
Hardware is SUBINTERFACE Current HW addr: 0030.abf1.0ec8
Physical:0030.abf1.0ec8 Logical:(not set)
Port Mode is Router
Interface index: 204802051
Metric 1 mtu 1500
<UP,BROADCAST,RUNNING,MULTICAST>
VRF Binding: Not bound
Label switching is disabled
No Virtual Circuit configured
Administrative Group(s): None
```

Layer 3 Subinterface Commands

```
DHCP client is disabled.
Last Flapped: Never
Statistics last cleared: Never
inet 23.0.0.2/24 broadcast 23.0.0.255
inet6 fe80::230:abff:fe1:ec8/64
RX
  unicast packets 0 multicast packets 0 broadcast packets 0
  input packets 141805 bytes 9643544
  jumbo packets 0
  undersize 0 oversize 0 CRC 0 fragments 0 jabbers 0
  input error 0
  input with dribble 0 input discard 0
  Rx pause 0
TX
  unicast packets 0 multicast packets 0 broadcast packets 0
  output packets 0 bytes 0
  jumbo packets 0
  output errors 0 collision 0 deferred 0 late collision 0
  output discard 0
  Tx pause 0
```

Neighbor Discovery Configuration Guide

CHAPTER 3 Neighbor Discovery Configuration

This chapter provides an overview of Neighbor Discovery (ND) configuration.

The Address Resolution Protocol (ARP) translates network layer addresses into link-layer addresses. ARP converts an IPv4 address to an Ethernet address (MAC address).

In Internet Protocol Version 6 (IPv6) networks, the functionality of ARP is provided by the Neighbor Discovery (ND) protocol. Neighbor Discovery operates at the link layer and is responsible for auto configuration of nodes, discovery of other nodes on the link, determining the link layer addresses of other nodes, duplicate address detection, finding available routers and Domain Name System (DNS) servers, address prefix discovery, and maintaining reachability information about the paths to other active neighbor nodes.

ARP/Neighbor Discovery Operation

Neighbor Discovery module manages the ARP and IPv6 ND entries and provides information to other protocols, the forwarding module for their use, and reports state changes.

Neighbor Entry States

INCOMPLETE	Address resolution is in progress and the link-layer address of the neighbor has not yet been determined.
REACHABLE	The neighbor is known to have been reachable recently.
STALE	The neighbor is no longer known to be reachable (not used by higher level protocol for reachable-time) but still valid and used for forwarding. Until any control packet is sent to the neighbor, no attempt will be made to verify its reachability.
DELAY	The neighbor is no longer known to be reachable, and traffic has recently been sent to the neighbor. Rather than probing the neighbor immediately, delay sending probes for a short while to give upper-layer protocols a chance to provide reachability confirmation.
PROBE	The neighbor is no longer known to be reachable, and probes are being sent to verify reachability.
FAILED	Address resolution failed. No response received from the neighbor.

Below are timers that control the above state transitions.

reachable-time	<p>The amount of time the entry is in REACHABLE state. The default value is 60 seconds.</p> <p>Once a neighbor is found, the entry is considered reachable for at least a random value between (A) and (3xA) where:</p> $A = \text{reachable-time} / 2$ <p>Once entry reachability expires it moves to STALE state. The entry's reachability is extended if it receives positive feedback (ARP reply/NA).</p>
stale-time	<p>Determines how often to check for stale neighbor entries. The default value is 1440 seconds.</p> <p>Once the stale-timer expires, the entry is marked for garbage collection.</p>
arp-aging-time	<p>The approximate amount of time an ARP entry is valid. The default value is 1500 seconds. Aging time is configured internally as:</p> $\text{aging-time} = \text{reachable-time} + \text{stale-time}$

The garbage collector runs every 60 seconds once, to clean-up the entries which have crossed STALE timeout and FAILED entries. For improved performance, the following are the additional criteria for the neighbor entries to be garbage collected (removal of the entry completely).

- The garbage collector does not run if the total number of entries is less than 2048 that conveys some STALE, and FAILED entries still exist. The entry is refreshed ONLY when higher-level protocols use it.
- The garbage collector always runs if the number of entries is more than 262144 for IPv4 and 131072 for IPv6.

The garbage collection triggers the refresh of neighbor entries which are marked to be garbage collected. A total of 3 retries with a 3 second interval is done to reach the neighbor, before declaring the neighbor as not reachable by the forwarder. During this retry period, neighbor entries are still in use for hardware forwarding. If the neighbor is still not reachable after retries (after 9 seconds), the neighbor entry is removed from hardware forwarding as well.

Configuring ARP for IPv4

The procedures in this section use the topology in [Figure 3-163](#)



Figure 3-163: ARP for IPv4

RTR1

#configure terminal	Enter the configure mode.
(config)#interface xel1	Enter interface mode.
(config-if)#ip address 2.2.2.2/24	Configure IP address on the interface.
(config-if)#commit	Commit the candidate configuration to the running configuration
(config-if)#exit	Exit interface mode.
(config)#arp 2.2.2.3 0000.0000.0003	Configure ARP entry for neighbor.
(config-if)#commit	Commit the candidate configuration to the running configuration
(config)#exit	Exit configure mode.

RTR2

#configure terminal	Enter the configure mode.
(config)#interface xel1	Enter interface mode.
(config-if)#ip address 2.2.2.3/24	Configure IP address on the interface.
(config-if)#commit	Commit the candidate configuration to the running configuration
(config-if)#exit	Exit interface mode.
(config)#arp 2.2.2.2 0000.0000.0004	Configure ARP entry for neighbor.
(config-if)#commit	Commit the candidate configuration to the running configuration
(config)#exit	Exit configure mode.

Validation

```
#show arp
Address                HWaddress            Interface            Type
2.2.2.3                00:00:00:00:00:03   eth1                 Static
10.12.65.1             00:07:7d:67:6f:bf   eth0                 Dynamic
```

Configuring Neighbor Discovery for IPv6

The procedures in this section use the topology in [Figure 3-164](#).



Figure 3-164: ND for IPv6

RTR1

#configure terminal	Enter the configure mode.
(config)#interface xel1	Enter interface mode.
(config-if)#ipv6 address 3ffe:506::1/48	Configure IPv6 address on the interface.
(config-if)#commit	Commit the candidate configuration to the running configuration
(config-if)#exit	Exit interface mode.
(config)#ipv6 neighbor 3ffe:506::2 xel1 0000.0000.0004	Configure neighbor IPv6 address and MAC.
(config-if)#commit	Commit the candidate configuration to the running configuration
(config)#exit	Exit configure mode.

RTR2

#configure terminal	Enter the configure mode.
(config)#interface xel1	Enter interface mode.
(config-if)#ipv6 address 3ffe:506::2/48	Configure IPv6 address on the interface.
(config-if)#commit	Commit the candidate configuration to the running configuration
(config-if)#exit	Exit interface mode.
(config)#ipv6 neighbor 3ffe:506::1 xel1 0000.0000.0003	Configure neighbor IPv6 address and MAC.
(config-if)#commit	Commit the candidate configuration to the running configuration
(config)#exit	Exit configure mode.

Validation

```
#show ipv6 neighbors
IPv6 Address          MAC Address          Interface            Type
3ffe:506::2          0000.0000.0004      xel1                 static
```

Neighbor Discovery Command Reference

CHAPTER 1 Neighbor Discovery Commands

This chapter describes the Neighbor Discovery commands:

- `arp-ageing-timeout`
- `arp-reachable-time`
- `clear arp`
- `clear ipv6 neighbors`
- `debug ip arp`
- `debug ipv6 nd`
- `ip arp`
- `ip arp vrf`
- `ip proxy-arp`
- `ipv6 nd current-hoplimit`
- `ipv6 nd link-mtu`
- `ipv6 nd managed-config-flag`
- `ipv6 nd other-config-flag`
- `ipv6 nd prefix`
- `ipv6 nd ra-interval`
- `ipv6 nd ra-lifetime`
- `ipv6 nd reachable-time`
- `ipv6 nd retransmission-time`
- `ipv6 nd suppress-ra`
- `ipv6 neighbor`
- `nd-ageing-timeout`
- `nd-reachable-time`
- `no debug all`
- `show arp`
- `show debugging ip arp`
- `show debugging ipv6 nd`
- `show ipv6 neighbors`

arp-ageing-timeout

Use this command to set the ARP aging timeout.

Note: The bridge aging time affects the ARP entries which are dependent upon the MAC addresses in hardware. If a MAC address ages out, it causes the corresponding ARP entry to refresh.

Use `no` form of this command to set the aging to its default value.

Command Syntax

```
arp-ageing-timeout <60-28800>
no arp-ageing-timeout
```

Parameter

<60-28800> ARP aging timeout.

Default value

By default, the ARP aging timeout is 1500.

Command Mode

Interface mode

Applicability

This command was introduced before OcnOS version 1.3.

Example

```
#configure terminal
(config)#interface xe2
(config-if)#arp-ageing-timeout 5000
(config-if)#exit

(config)#interface xe2
(config-if)#no arp-ageing-timeout
```

arp-reachable-time

Use this command to set the ARP reachable time.

Use `no` form of this command to set the reachable time to its default value.

Command Syntax

```
arp-reachable-time <10-3600>
no arp-reachable-time
```

Parameters

<10-3600> Specify the ARP reachable time.

Default value

By default, arp-reachable-time is 60

Command Mode

Interface mode

Applicability

This command was introduced before OcNOS version 1.3.

Example

```
#configure terminal
(config)#interface xe2
(config-if)#arp-reachable-time 120
(config-if)#exit

(config)#interface xe2
(config-if)#no arp-reachable-time
```

clear arp

Use this command to clear dynamic ARP entries.

Command Syntax

```
clear arp (| A.B.C.D) (| vrf (all | VRFNAME | default))
clear arp IFNAME (| vrf (all | VRFNAME | default))
```

Parameters

A.B.C.D	Specify the IP address of the ARP entry.
IFNAME	Specify the name of the interface.
all	All VRFs.
VRFNAME	VPN routing/forwarding instance name.
default	Default VRF.

Command Mode

Exec mode

Applicability

This command was introduced before OcNOS version 1.3.

Example

```
#clear arp
#clear arp xe1
#clear arp 10.10.10.10
#clear arp vrf VRF1
```

clear ipv6 neighbors

Use this command to clear dynamic neighbor entries.

Command Syntax

```
clear ipv6 neighbors (|X:X::X:X) (|vrf (all | VRFNAME | default))
clear ipv6 neighbors IFNAME (|vrf (all | VRFNAME | default))
```

Parameters

X:X::X:X	Specify the neighbor's IPv6 address.
IFNAME	Specify the name of the interface.
all	All VRFs.
VRFNAME	VPN routing/forwarding instance name.
default	Default VRF.

Command Mode

Exec mode

Applicability

This command was introduced before OcNOS version 1.3.

Example

```
#clear ipv6 neighbors
#clear ipv6 neighbors xe1
#clear ipv6 neighbors 2000::3
#clear ipv6 neighbors vrf VRF1
```

debug ip arp

Use this command to enable debugging for ARP events.

Note: Packet dumps are not available as part of debug logs. Use the `tcpdump` command to view packets.

Use the `no` parameter with this command to disable event debugging.

Command Syntax

```
debug ip arp event
no debug ip arp event
```

Parameters

`event` ARP event debugging.

Command Mode

Exec mode and configure mode

Applicability

This command was introduced before OcNOS version 1.3.

Example

```
#debug ip arp event
```

debug ipv6 nd

Use this command to enable debugging for neighbor events.

Note: Packet dumps are not available as part of debug logs. Use the `tcpdump` command to view packets.

Use the `no` parameter with this command to disable event debugging.

Command Syntax

```
debug ipv6 nd event
no debug ipv6 nd event
```

Parameters

`event` ND event debugging.

Command Mode

Exec mode and configure mode

Applicability

This command was introduced before OcnOS version 1.3.

Example

```
#debug ipv6 nd event
```

ip arp

Use this command to create a static ARP entry.

Use the `no` parameter to remove the static ARP entry.

Command Syntax

```
ip arp A.B.C.D XXXX.XXXX.XXXX (alias|)
no ip arp A.B.C.D
```

Parameters

A.B.C.D	Specify the IP address of the ARP entry.
XXXX.XXXX.XXXX	Specify the MAC (hardware) address of the ARP entry.
alias	Specify the response to ARP requests for the IP address.

Default value

No default value is specified

Command Mode

Configure mode

Applicability

This command was introduced before OcnOS version 1.3.

Example

```
#configure terminal
(config)#ip arp 10.10.10.10 0000.0001.4566
(config)#no ip arp 10.10.10.10
```

ip arp vrf

Use this command to create a static ARP entry for the non-default VRF.

Note: This command is supported only for multiple VRF support.

Command Syntax

```
ip arp vrf NAME A.B.C.D XXXX.XXXX.XXXX (alias|)
```

Parameter

NAME	Specify VRF name to which entry need to be added.
A.B.C.D	Specify the IP address of the ARP entry.
XXXX.XXXX.XXXX	Specify the MAC (hardware) address of the ARP entry.
alias	Specify the response to ARP requests for the IP address.

Default value

No default value is specified

Command Mode

Configure mode

Applicability

This command was introduced before OcnOS version 1.3.

Example

```
#configure terminal  
(config)#ip arp vrf VRF1 10.10.10.10 0000.0001.4566
```

ip proxy-arp

Use this command to enable the proxy ARP feature.

Use the `no` parameter to disable the proxy ARP feature.

Command Syntax

```
ip proxy-arp
no ip proxy-arp
```

Parameter

None

Default value

No default value is specified

Command Mode

Interface mode

Applicability

This command was introduced before OcNOS version 1.3.

Examples

```
#configure terminal
(config)#interface xe1
(config-if)#ip proxy-arp
(config-if)#no ip proxy-arp
```

ipv6 nd current-hoplimit

Use this command to set an ND (Neighbor Discovery) advertised hop limit for an interface.

Use the `no` option of this command to set the current hop limit to its default value.

Command Syntax

```
ipv6 nd current-hoplimit <0-255>
no ipv6 nd current-hoplimit
```

Parameter

<0-255>	Hop limit.
---------	------------

Default

By default, hop limit is 64

Command Mode

Interface mode

Applicability

This command was introduced before OcNOS version 1.3.

Examples

```
#configure terminal
(config)#interface eth3
(config-if)#ipv6 nd current-hoplimit 10
(config-if)#no ipv6 nd current-hoplimit
```

ipv6 nd link-mtu

Use this command to set an advertised maximum transmission unit (MTU).

Use the `no` option with the command to reset the MTU to the default statute.

Command Syntax

```
ipv6 nd link-mtu (<1280-65535>)  
no ipv6 nd link-mtu
```

Parameters

<1280-65535> Link MTU value.

Default

By default, link MTU value is 1500

Command Mode

Interface mode

Applicability

This command was introduced before OcnOS version 1.3.

Example

```
#configure terminal  
(config)#interface eth3  
(config-if)#ipv6 nd link-mtu 1600  
(config-if)#no ipv6 nd link-mtu
```

ipv6 nd managed-config-flag

Use this command to set the managed address configuration flag in the Router Advertisement to be used for the IPv6 address auto-configuration.

Use the `no` parameter with this command to reset the value to default.

Command Syntax

```
ipv6 nd managed-config-flag
no ipv6 nd managed-config-flag
```

Parameters

None

Default

The managed address configuration flag is not set.

Command Mode

Interface mode

Applicability

This command was introduced before OcNOS version 1.3.

Examples

```
#configure terminal
(config)#interface eth3
(config-if)#ipv6 nd managed-config-flag
(config-if)#no ipv6 nd managed-config-flag
```

ipv6 nd other-config-flag

Use this command to set the other stateful configuration flag in Router Advertisement to be used for IPv6 address auto-configuration.

Use `no` parameter with this command to reset the value to default.

Command Syntax

```
ipv6 nd other-config-flag
no ipv6 nd other-config-flag
```

Parameters

None

Default

Other stateful configuration flag is not set.

Command Mode

Interface mode

Applicability

This command was introduced before OcNOS version 1.3.

Examples

```
#configure terminal
(config)#interface eth3
(config-if)#ipv6 nd other-config-flag
```

ipv6 nd prefix

Use this command to set IPv6 prefix information that is advertised for address auto-configuration.

Use `no` parameter with this command to remove an IPv6 prefix.

Command Syntax

```

ipv6 nd prefix X:X::X:X/M <0-4294967295> <0-4294967295> (off-link|) (no-
  autoconfig|)
ipv6 nd prefix X:X::X:X/M
ipv6 nd prefix valid-lifetime <0-4294967295>
ipv6 nd prefix preferred-lifetime <0-4294967295>
ipv6 nd prefix offlink
ipv6 nd prefix no-autoconf
no ipv6 nd prefix X:X::X:X/M (off-link|) (no-autoconfig|)
no ipv6 nd prefix valid-lifetime
no ipv6 nd prefix preferred-lifetime

```

Parameters

<code>X:X::X:X/M</code>	IPv6 prefix.
<code><0-4294967295></code>	Valid lifetime in seconds. Use the preferred-lifetime value < valid-lifetime.
<code><0-4294967295></code>	Preferred lifetime in seconds. Use the preferred-lifetime value < valid-lifetime.
<code>off-link</code>	Do not use prefix for onlink determination.
<code>no-autoconfig</code>	Do not use prefix for autoconfiguration.

Default

By default, valid life time is 2592000 seconds and preferred life time is 604800 seconds

Command Mode

Interface mode

Applicability

This command was introduced before OcNOS version 1.3.

Defaults

The default valid lifetime is 2592000 seconds.

The default preferred lifetime is 604800 seconds.

Examples

```

(config)#interface eth3
(config-if)#ipv6 nd prefix 2001:ffff::/64

(config)#interface eth3
(config-if)#ipv6 nd prefix no-autoconf

```

```
(config)#interface eth3  
(config-if)#ipv6 nd prefix preferred-lifetime 550000
```

ipv6 nd ra-interval

Use this command to specify the interval between IPv6 Router Advertisements (RA).

Use `no` parameter with this command to set the value to its default.

Note: The RA interval will have a random variation from configured interval to avoid synchronization of advertisement with routers.

Command Syntax

```
ipv6 nd ra-interval <4-1800> (<3-1350>|)
no ipv6 nd ra-interval
```

Parameter

<4-1800>	RA interval in seconds.
<3-1350>	Minimum RA interval (in seconds).

Default

By default, RA interval is 600 seconds, and Minimum RA interval is 0.33*RA interval.

Command Mode

Interface mode

Applicability

This command was introduced before OcnOS version 1.3.

Examples

```
#configure terminal
(config)#interface eth3
(config-if)#ipv6 nd ra-interval 60 15
(config-if)#ipv6 nd prefix 3ffe:ffff:ffff::/64

(config-if)#no ipv6 nd ra-interval
```

ipv6 nd ra-lifetime

Use this command to specify the Router Advertisement (RA) lifetime for this device to act as a default gateway for the network.

Use `no` parameter with this command to reset the value to default.

Command Syntax

```
ipv6 nd ra-lifetime <0-9000>
no ipv6 nd ra-lifetime
```

Parameter

<0-9000> RA lifetime duration in seconds.

Default

The default RA lifetime is 1800 seconds.

Command Mode

Interface mode

Applicability

This command was introduced before OcNOS version 1.3.

Examples

```
#configure terminal
(config)#interface eth3
(config-if)#ipv6 nd ra-lifetime 9000
(config-if)#no ipv6 ra-lifetime 9000
```

ipv6 nd reachable-time

Use this command to specify the reachable time in the Router Advertisement to be used for detecting unreachability of the IPv6 neighbor.

Use the `no` parameter with this command to set the value to its default.

Command Syntax

```
ipv6 nd reachable-time <0-3600000>  
no ipv6 nd reachable-time
```

Parameter

<0-3600000> Reachable time in milliseconds.

Default

By default, reachable time is zero (0) milliseconds.

Command Mode

Interface mode

Applicability

This command was introduced before OcNOS version 1.3.

Examples

```
#configure terminal  
(config)#interface eth3  
(config-if)#ipv6 nd reachable-time 1800000  
(config-if)#no ipv6 nd reachable-time 1800000
```

ipv6 nd retransmission-time

Use this command to set an IPv6 advertised retransmission time for the current interface.

Use the `no` form of the command to set the retransmission time to its default value.

Command Syntax

```
ipv6 nd retransmission-time (0-4294967295)
no ipv6 nd retransmission-time
```

Parameter

<0-4294967295> Retransmission time in milliseconds

Default

By default, retransmission time is zero (0) milliseconds.

Command Mode

Interface mode

Applicability

This command was introduced before OcNOS version 1.3.

Examples

```
#configure terminal
(config)#interface eth3
(config-if)#ipv6 nd retransmission-time 1200
(config-if)#no ipv6 nd retransmission-time
```

ipv6 nd suppress-ra

Use this command to suppress IPv6 Router Advertisement (RA) transmission for the current interface. Router Advertisement is used for IPv6 stateless auto-configuration.

Use the `no` parameter with this command to enable Router Advertisement transmission.

Command Syntax

```
ipv6 nd suppress-ra (mtu |)
no ipv6 nd suppress-ra (mtu |)
```

Parameters

<code>mtu</code>	Send maximum transmission unit (MTU) in Router Advertisement messages
------------------	---

Default

By default, `ipv6 nd suppress-ra` is disabled.

Command Mode

Interface mode

Applicability

This command was introduced before OcnOS version 1.3.

Example

```
#configure terminal
(config)#interface eth3
(config-if)#ipv6 nd suppress-ra
```

ipv6 neighbor

Use this command to add a static neighbor entry.

Use the `no` form of this command to remove a static neighbor entry.

Command Syntax

```
ipv6 neighbor X:X::X:X IFNAME XXXX.XXXX.XXXX
no ipv6 neighbor X:X::X:X IFNAME
```

Parameter

<code>X:X::X:X</code>	Specify the neighbor's IPv6 address.
<code>IFNAME</code>	Specify the name of the interface.
<code>XXXX.XXXX.XXXX</code>	Specify the MAC hardware address.

Default value

No default value is specified

Command Mode

Configure mode

Applicability

This command was introduced before OcNOS version 1.3.

Examples

```
#configure terminal
(config)#ipv6 neighbor 2000::3 xe1 0000.0002.3dc1
(config)#no ipv6 neighbor 2000::3 xe1
```

nd-ageing-timeout

Use this command to set the neighbor ageing timeout value.

Use `no` form of this command to set the ageing to its default value.

Command Syntax

```
nd-ageing-timeout <60-28800>
no nd-ageing-timeout
```

Parameters

<60-2880>	ND ageing timeout in seconds.
IFNAME	Specify the name of the interface.
XXXX.XXXX.XXXX	Specify the MAC hardware address.

Default value

By default, `nd-ageing-timeout` is 1500 seconds

Command Mode

Interface mode

Applicability

This command was introduced before OcnOS version 1.3.

Example

```
#configure terminal
(config)#interface xe1
(config-if)#nd-ageing-timeout 3600
(config-if)#no nd-ageing-timeout
```

nd-reachable-time

Use this command to set neighbor reachable time value.

Use `no` form of this command to set the reachable time to its default value.

Command Syntax

```
nd-reachable-time <10-3600>
no nd-reachable-time
```

Parameter

<10-3600> ND reachable time in seconds.

Default value

By default, `nd-reachable-time` is 60 seconds

Command Mode

Interface mode

Applicability

This command was introduced before OcNOS version 1.3.

Examples

```
#configure terminal
(config)#interface xe1
(config-if)#nd-reachable-time 300
(config-if)#no nd-reachable-time
```

no debug all

Use this command to disable all ARP and the neighbor debugging.

Command Syntax

```
no debug all
undebug all
```

Parameters

None

Command Mode

Exec mode

Applicability

This command was introduced before OcnOS version 1.3.

Example

```
#no debug all
```

show arp

Use this command to display ARP entry information.

Command Syntax

```
show arp (| (A.B.C.D | detail | static) (| vrf (all | VRFNAME | default)))
show arp IFNAME (| vrf (all | VRFNAME | default))
show arp summary (|IFNAME) (| vrf (all | VRFNAME | default))
```

Parameters

detail	Display detailed information.
static	Display static ARP entries.
A.B.C.D	Specify the IP address of the ARP entry.
IFNAME	Specify the name of the interface.
all	All VRFs.
VRFNAME	VPN routing/forwarding instance name.
default	Default VRF.

Command Mode

Exec mode

Applicability

This command was introduced before OcNOS version 1.3.

Example

```
#show arp
```

```
Flags: D - Static Adjacencies attached to down interface
```

```
IP ARP Table for context default
```

```
Total number of entries: 2
```

Address	Age	MAC Address	Interface	State
10.12.18.1	00:00:18	44e4.d982.274b	eth0	REACHABLE
10.10.10.20	00:02:33	a8b1.d433.4140	xe1	STALE

```
#show arp summary vrf default
```

```
IP ARP Table - Adjacency Summary
```

```
Resolved      : 2
Incomplete    : 0
Unknown       : 0
Total         : 2
```

[Table 1-81](#) explains the show command output fields.

Table 1-81: show arp output details

Entry	Description
Address	ARP entry's IP address in the device.
Age	The number of minutes before the ARP entry was refreshed. If this value reaches the ARP aging period, the entry is removed from the table. Static entries do not age out.
MAC Address	Physical address of the host.
Interface	Logical address to connect the device over network.
State	<p>INCOMPLETE – first ARP request sent, send ARP request. REACHABLE – normal expiration reset use counter. STALE – still usable; needs verification reset use counter; change state to delay. DELAY – schedule ARP request; needs verification reset use counter. PROBE – sending ARP request reset use counter. FAILED – no response received send ARP request. NOARP – normal expiration; never verified reset use counter. PERMANENT – never expires; never verified reset use counter.</p> <p>Note: INCOMPLETE/FAILED state entries are only cleared if the total number of ARP entries is more than 2048. It might take up to 60 seconds to clear the entries. This is an optimization to improve ND performance.</p>

Network devices are considered adjacent if they can reach each other with a single hop. The summary command shows the count of the state of devices that are adjacencies.

[Table 1-82](#) explains the show command output fields.

Table 1-82: show arp summary output details

Field	Description
Resolved	Count of working/known adjacencies.
Incomplete	Count of yet to be established adjacencies.
unknown	Count of adjacencies not currently in ARP table.
Total	Total count of all adjacencies.

show debugging ip arp

Use this command to display debugging information for ARP.

Command Syntax

```
show debugging ip arp
```

Parameters

None

Command Mode

Exec mode

Applicability

This command was introduced before OcNOS version 1.3.

Example

```
#show debugging ip arp
ND IP Debugging status:
  ND ip arp event debugging is off
  ND ip arp packet debugging is off
```

show debugging ipv6 nd

Use this command to display debugging information for the neighbor.

Command Syntax

```
show debugging ipv6 nd
```

Parameters

None

Command Mode

Exec mode

Applicability

This command was introduced before OcNOS version 1.3.

Example

```
#show debugging ipv6 nd
ND IPV6 Debugging status:
  ND ipv6 event debugging is off
  ND ipv6 packet debugging is off
```

show ipv6 neighbors

Use this command to display the neighbor information.

Command Syntax

```
show ipv6 neighbors (| (X:X::X:X | detail | static) (| vrf (all | VRFNAME | default)))  
show ipv6 neighbors IFNAME (| vrf (all | VRFNAME | default))  
show ipv6 neighbors summary (| IFNAME) (| vrf (all | VRFNAME | default))
```

Parameters

detail	Show detail information of neighbor.
static	Static entry.
X:X::X:X	Specify the neighbor's IPv6 address.
IFNAME	Specify the name of the interface.
all	All VRFs.
VRFNAME	VPN routing/forwarding instance name.
default	Default VRF.

Command Mode

Exec mode

Applicability

This command was introduced before OcnOS version 1.3.

Example

```
#show ipv6 neighbors  
  
R - Reachable, I - Incomplete, S - Stale, F - Failed, P - Probe,  
D - Delay, PR - Permanent  
  
Flags: (D) - Static neighbors attached to down interface  
  
IPv6 Neighbor Table for context default  
Total number of entries:2  
Address      Age      MAC Address      Source  Interface      State  
fe80::210:18ff:fe7f:f758  
                00:43:04  0010.187f.f758  icmpv6  eth0           S  
2000::5      00:55:25  0000.0001.0242  icmpv6  xe1            S  
  
#show ipv6 neighbors summary  
  
IPv6 Neighbors Table - Adjacency Summary  
  
Resolved      : 2  
Incomplete    : 0  
Unknown       : 0  
Total         : 2
```

Table 1-83 shows the status codes displayed at the start of a route entry.

Table 1-83: status code output details

Status Code	Field	Description
R	Reachable	Normal expiration reset use counter.
I	Incomplete	First ARP request sent, send ARP request.
S	Stale	Still usable; needs verification reset use counter; change state to delay.
F	Failed	ARP requests response not received.
P	Probe	ARP request reset use counter.
D	Delay	Schedule ARP request; needs verification reset use counter.
PR	Permanent	Never expires; never verified reset use counter.

Table 1-84 explains the show command output fields.

Table 1-84: show ipv6 neighbors output details

Field	Description
Address	ARP entry's IP address in the device.
Age	The number of minutes before the ARP entry was refreshed. If this value reaches the ARP aging period, the entry is removed from the table. Static entries do not age out.
MAC Address	Physical address of the host.
Source	ARP request source in the interface.
Interface	Logical address to connect the device over network.
State	ARP request state that is being handled by the IPv6 neighbor session.

Table 1-85 explains the show command output fields.

Table 1-85: show arp summary output details

Field	Description
Resolved	Count of working/known adjacencies.
Incomplete	Count of yet to be established adjacencies.
unknown	Count of adjacencies not currently in ARP table.
Total	Total count of all adjacencies.

Bidirectional Forwarding Detection Configuration Guide

CHAPTER 1 Base BFD Configuration

This chapter provides the steps for configuring the base Bidirectional Forwarding Detection (BFD) setup.

Overview

This section provides an overview of Bidirectional Forwarding Detection (BFD). BFD is a detection protocol designed to provide fast forwarding path failure detection times for all media types, encapsulations, topologies, and routing protocols like BGP, EIGRP, IS-IS, and OSPF. In addition to fast forwarding path failure detection, BFD provides a consistent failure detection method for network administrators. The configuration and command reference for BFD is given in the following chapters in this section.

Topology



Figure 1-165: Basic Topology of Three Routers

BFD Echo Function

R1

R1#configure terminal	Enter the Configure mode.
R1(config)#interface eth1	Enter interface Mode.
R1(config-if)#ip address 10.1.1.1/24	Assign IP address for interface
R1(config-if)#bfd session 10.1.1.1 10.1.1.2	Configure BFD session on interface.
R1(config-if)#exit	Exit from interface mode.
R1(config)#bfd echo	Enable BFD echo mode.
R1(config)#commit	Commit the candidate configuration to the running configuration.
R1(config)#exit	Exit from interface mode.

R2

R2#configure terminal	Enter the Configure mode.
R2(config)#interface eth1	Enter interface Mode.
R2(config-if)#ip address 10.1.1.2/24	Assign IP address for interface
R2(config-if)#bfd session 10.1.1.2 10.1.1.1	Configure BFD session on interface.
R2(config-if)#exit	Exit from interface mode.
R2(config)#bfd echo	Enable BFD echo mode.

Base BFD Configuration

R2(config)#commit	Commit the candidate configuration to the running configuration.
R2(config)#exit	Exit from interface mode.

Validation

R1

```
#sh bfd session detail
```

```
Session Interface Index : 3           Session Index : 1
Lower Layer : IPv4                   Version : 1
Session Type : Single Hop            Session State : Down
Local Discriminator : 1              Local Address : 10.1.1.1/32
Remote Discriminator : 1             Remote Address : 10.1.1.2/32
Local Port : 49152                   Remote Port : 3784
Local Echo Port : 49153
Options :
Echo Enabled
Diagnostics : None

Timers in Milliseconds :
Min Tx: 250           Min Rx: 250           Multiplier: 3
Neg Tx: 2000         Neg Rx: 2000         Neg detect mult: 3
Min echo Tx: 1000    Min echo Rx: 1000    Neg echo intrvl: 1000
Storage type : 2
Sess down time : 00:00:01
Sess discontinue time : 00:00:00
Bfd GTSM Disabled
Bfd Authentication Disabled

Counters values:
Pkt In : 0000000000000010a          Pkt Out : 000000000000001f7
Echo Out : 000000000000000ab        IPv6 Echo Out : 0000000000000000
IPv6 Pkt In : 000000000000000000    IPv6 Pkt Out : 0000000000000000
UP Count : 57                        UPTIME : 00:00:00
```

```
Protocol Client Info:
BFD-> Client ID: 28           Flags: 4
```

```
-----
Number of Sessions:      1
```

R2

```
#sh bfd session detail
```

```
Session Interface Index : 3           Session Index : 1
Lower Layer : IPv4                   Version : 1
Session Type : Single Hop            Session State : Up
Local Discriminator : 1              Local Address : 10.1.1.2/32
Remote Discriminator : 1             Remote Address : 10.1.1.1/32
Local Port : 49152                   Remote Port : 3784
Local Echo Port : 49153
Options :
Echo Enabled
Diagnostics : None
```

```

Timers in Milliseconds :
Min Tx: 250           Min Rx: 250           Multiplier: 3
Neg Tx: 2000         Neg Rx: 2000         Neg detect mult: 3
Min echo Tx: 1000    Min echo Rx: 1000    Neg echo intrvl: 1000
Storage type : 2
Sess down time : 00:00:00
Sess discontinue time : 00:00:00
Bfd GTSM Disabled
Bfd Authentication Disabled

```

```

Counters values:
Pkt In : 00000000000000ad      Pkt Out : 0000000000000105
Echo Out : 0000000000000063    IPv6 Echo Out : 0000000000000000
IPv6 Pkt In : 0000000000000000  IPv6 Pkt Out : 0000000000000000
UP Count : 33                  UPTIME : 00:00:03

```

```

Protocol Client Info:
BFD-> Client ID: 28      Flags: 4
-----

```

```

Number of Sessions:      1

```

BFD Slow Timer

R1

R1#configure terminal	Enter the Configure mode.
R1(config)#interface eth1	Enter interface Mode.
R1(config-if)#ip address 10.1.1.1/24	Assign IP address for interface
R1(config-if)#bfd session 10.1.1.1 10.1.1.2	Configure BFD session on interface.
R1(config-if)#exit	Exit from interface mode.
R1(config)#bfd slow-timer 1000	Configure BFD slow-timer in milliseconds.
R2(config)#commit	Commit the candidate configuration to the running configuration.
R2(config)#exit	Exit from interface mode.

R2

R2#configure terminal	Enter the Configure mode.
R2(config)#interface eth1	Enter interface Mode.
R2(config-if)#ip address 10.1.1.2/24	Assign IP address for interface
R2(config-if)#bfd session 10.1.1.2 10.1.1.1	Configure BFD session on interface.
R2(config-if)#exit	Exit from interface mode.
R2(config)#bfd slow-timer 1000	Configure BFD slow-timer in milliseconds.

BFD Multihop Peer Timer

R1

R1#configure terminal	Enter the Configure mode.
R1(config)#interface eth1	Enter interface Mode.
R1(config-if)#ip address 10.1.1.1/24	Assign IP address for interface
R1(config-if)#exit	Exit from interface mode.
R1(config)#router ospf 1	Enter router OSPF mode
R1(config-router)#network 10.1.1.0/24 area 0	Advertise the network to area 0
R1(config-router)#redistribute connected	
R1(config-router)#exit	Exit router OSPF mode
R1(config)#bfd multihop-peer 20.1.1.3 interval 100 minrx 100 multiplier 3	Configure BFD multihop-peer timer and reception intervals in milliseconds and the Hello multiplier.
R1(config)#commit	Commit the candidate configuration to the running configuration.
R1(config)#exit	Exit router OSPF mode

R2

R2#configure terminal	Enter the Configure mode.
R2(config)#interface eth1	Enter interface Mode.
R2(config-if)#ip address 10.1.1.2/24	Assign IP address for interface
R2(config-if)#exit	Exit from interface mode.
R2(config)#interface eth2	Enter interface Mode.
R2(config-if)#ip address 20.1.1.2/24	Assign IP address for interface
R2(config-if)#exit	Exit from interface mode.
R2(config)#router ospf 1	Enter router OSPF mode
R2(config-router)#network 10.1.1.0/24 area 0	Advertise the network to area 0
R2(config-router)#network 20.1.1.0/24 area 0	Advertise the network to area 0
R2(config-router)#redistribute connected	
R2(config-router)#commit	Commit the candidate configuration to the running configuration.
R2(config-router)#exit	Exit router OSPF mode

R3

R1#configure terminal	Enter the Configure mode.
R1(config)#interface eth2	Enter interface Mode.
R1(config-if)#ip address 20.1.1.3/24	Assign IP address for interface
R1(config-if)#exit	Exit from interface mode.
R1(config)#router ospf 1	Enter router OSPF mode
R1(config-router)#network 20.1.1.0/24 area 0	Advertise the network to area 0
R1(config-router)#redistribute connected	
R1(config-router)#exit	Exit router OSPF mode

R1(config)#bfd multihop-peer 10.1.1.1 interval 100 minrx 100 multiplier 3	Configure BFD multihop-peer timer and reception intervals in milliseconds and the Hello multiplier.v
R1(config)#commit	Commit the candidate configuration to the running configuration.
R1(config)#exit	Exit router OSPF mode

Validation:

R1

```
#sh bfd session detail
```

```

Session Interface Index : 0           Session Index : 2
Lower Layer : IPv4                   Version : 1
Session Type : Multihop Arbit Path   Session State : Up
Local Discriminator : 2               Local Address : 10.1.1.1/32
Remote Discriminator : 0              Remote Address : 20.1.1.3/32
Local Port : 49153                    Remote Port : 4784
Options :
```

```
Diagnostics : None
```

```
Timers in Milliseconds :
```

```

Min Tx: 100           Min Rx: 100           Multiplier: 3
Neg Tx: 0             Neg Rx: 0             Neg detect mult: 0
Min echo Tx: 1000    Min echo Rx: 1000    Neg echo intrvl: 0
Storage type : 2
Sess down time : 00:00:00
Sess discontinue time : 00:00:00
Bfd GTSM Disabled
Bfd Authentication Disabled
```

```
Counters values:
```

```

Pkt In : 0000000000000000          Pkt Out : 0000000000000097
Echo Out : 0000000000000000        IPv6 Echo Out : 0000000000000000
IPv6 Pkt In : 0000000000000000      IPv6 Pkt Out : 0000000000000000
UP Count : 0                          UPTIME : 00:00:00
```

```
Protocol Client Info:
```

```
BFD-> Client ID: 28      Flags: 4
```

```
-----
Number of Sessions:      1
```

R3

```
#sh bfd session detail
```

```

Session Interface Index : 0           Session Index : 1
Lower Layer : IPv4                   Version : 1
Session Type : Multihop Arbit Path   Session State : Up
Local Discriminator : 1               Local Address : 20.1.1.3/32
Remote Discriminator : 1              Remote Address : 10.1.1.1/32
Local Port : 49152                    Remote Port : 4784
```

Base BFD Configuration

Options :

Diagnostics : None

Timers in Milliseconds :

Min Tx: 100	Min Rx: 100	Multiplier: 3
Neg Tx: 100	Neg Rx: 100	Neg detect mult: 3
Min echo Tx: 1000	Min echo Rx: 1000	Neg echo intrvl: 0

Storage type : 2
Sess down time : 00:00:00
Sess discontinue time : 00:00:00
Bfd GTSM Disabled
Bfd Authentication Disabled

Counters values:

Pkt In : 00000000000001df	Pkt Out : 00000000000001e0
Echo Out : 0000000000000000	IPv6 Echo Out : 0000000000000000
IPv6 Pkt In : 0000000000000000	IPv6 Pkt Out : 0000000000000000
UP Count : 1	UPTIME : 00:01:26

Protocol Client Info:

BFD-> Client ID: 28 Flags: 4

Number of Sessions: 1

BFD Single-hop Session Timer

R1

R1#configure terminal	Enter the Configure mode.
R1(config)#interface eth1	Enter interface Mode.
R1(config-if)#ip address 10.1.1.1/24	Assign IP address for interface
R1(config-if)#bfd session 10.1.1.1 10.1.1.2	Configure BFD session on interface.
R1(config-if)#bfd interval 100 minrx 100 multiplier 4	Configure BFD single-hop sessions timer and reception interval in millisecond and the Hello multiplier.
R1(config-if)#commit	Commit the candidate configuration to the running configuration.
R1(config-if)#exit	Exit from interface mode.

R2

R2#configure terminal	Enter the Configure mode.
R2(config)#interface eth1	Enter interface Mode.
R2(config-if)#ip address 10.1.1.2/24	Assign IP address for interface
R2(config-if)#bfd session 10.1.1.2 10.1.1.1	Configure BFD session on interface.
R2(config-if)#bfd interval 100 minrx 100 multiplier 4	Configure BFD single-hop sessions timer and reception interval in millisecond and the Hello multiplier.
R2(config-if)#commit	Commit the candidate configuration to the running configuration.
R2(config-if)#exit	Exit from interface mode.

Validation:

R1

```
#sh bfd session detail
```

```
Session Interface Index : 3           Session Index : 1
Lower Layer : IPv4                   Version : 1
Session Type : Single Hop            Session State : Up
Local Discriminator : 1              Local Address : 10.1.1.1/32
Remote Discriminator : 1             Remote Address : 10.1.1.2/32
Local Port : 49152                   Remote Port : 3784
Options :
```

```
Diagnostics : None
```

```
Timers in Milliseconds :
```

```
Min Tx: 100           Min Rx: 100           Multiplier: 4
Neg Tx: 100           Neg Rx: 100           Neg detect mult: 4
Min echo Tx: 100      Min echo Rx: 1000     Neg echo intrvl: 0
Storage type : 2
Sess down time : 00:00:00
Sess discontinue time : 00:00:00
Bfd GTSM Disabled
Bfd Authentication Disabled
```

```
Counters values:
```

```
Pkt In : 000000000000156e           Pkt Out : 0000000000001748
Echo Out : 000000000000019b         IPv6 Echo Out : 0000000000000000
IPv6 Pkt In : 0000000000000000      IPv6 Pkt Out : 0000000000000000
UP Count : 139                       UPTIME : 00:14:23
```

```
Protocol Client Info:
```

```
BFD-> Client ID: 28           Flags: 4
```

```
-----
Number of Sessions:      1
```

R2

```
#sh bfd session detail
```

```
Session Interface Index : 3           Session Index : 1
Lower Layer : IPv4                   Version : 1
Session Type : Single Hop            Session State : Up
Local Discriminator : 1              Local Address : 10.1.1.2/32
Remote Discriminator : 1             Remote Address : 10.1.1.1/32
Local Port : 49152                   Remote Port : 3784
Options :
```

```
Diagnostics : None
```

```
Timers in Milliseconds :
```

```
Min Tx: 100           Min Rx: 100           Multiplier: 4
Neg Tx: 100           Neg Rx: 100           Neg detect mult: 4
Min echo Tx: 100      Min echo Rx: 1000     Neg echo intrvl: 0
Storage type : 2
```

Base BFD Configuration

Sess down time : 00:00:00
Sess discontinue time : 00:00:00
Bfd GTSM Disabled
Bfd Authentication Disabled

Counters values:

Pkt In : 000000000000181d	Pkt Out : 00000000000019ab
Echo Out : 0000000000001b5	IPv6 Echo Out : 0000000000000000
IPv6 Pkt In : 0000000000000000	IPv6 Pkt Out : 0000000000000000
UP Count : 145	UPTIME : 00:15:19

Protocol Client Info:

BFD-> Client ID: 28 Flags: 4

Number of Sessions: 1

BFD Echo Interval

R1

R1#configure terminal	Enter the Configure mode.
R1(config)#interface eth1	Enter interface Mode.
R1(config-if)#ip address 10.1.1.1/24	Assign IP address for interface
R1(config-if)#bfd session 10.1.1.1 10.1.1.2	Configure BFD session on interface.
R1(config-if)#bfd echo interval 100	
R1(config-if)#exit	Exit from interface mode.
R1(config)#bfd echo	Enable BFD echo mode.
R1(config)#commit	Commit the candidate configuration to the running configuration.
R1(config)#exit	Exit from interface mode.

R2

R2#configure terminal	Enter the Configure mode.
R2(config)#interface eth1	Enter interface Mode.
R2(config-if)#ip address 10.1.1.2/24	Assign IP address for interface
R2(config-if)#bfd session 10.1.1.2 10.1.1.1	Configure BFD session on interface.
R1(config-if)#bfd echo interval 100	.
R2(config-if)#exit	Exit from interface mode.
R2(config)#bfd echo	Enable BFD echo mode.
R2(config)#commit	Commit the candidate configuration to the running configuration.
R2(config)#exit	Exit from interface mode.

Validation

R1

```
#sh bfd session detail
```

```

Session Interface Index : 3           Session Index : 1
Lower Layer : IPv4                   Version : 1
Session Type : Single Hop            Session State : Down
Local Discriminator : 1               Local Address : 10.1.1.1/32
Remote Discriminator : 1              Remote Address : 10.1.1.2/32
Local Port : 49152                    Remote Port : 3784
Local Echo Port : 49153
Options :
Echo Enabled
Diagnostics : None

```

```
Timers in Milliseconds :
```

```

Min Tx: 250           Min Rx: 250           Multiplier: 3
Neg Tx: 2000          Neg Rx: 2000          Neg detect mult: 3
Min echo Tx: 100      Min echo Rx: 1000     Neg echo intrvl: 1000
Storage type : 2
Sess down time : 00:00:00
Sess discontinue time : 00:00:00
Bfd GTSM Disabled
Bfd Authentication Disabled

```

```
Counters values:
```

```

Pkt In : 000000000000001ea          Pkt Out : 00000000000000398
Echo Out : 00000000000000147        IPv6 Echo Out : 00000000000000000
IPv6 Pkt In : 000000000000000000    IPv6 Pkt Out : 00000000000000000
UP Count : 109                       UPTIME : 00:00:00

```

```
Protocol Client Info:
```

```
BFD-> Client ID: 28      Flags: 4
```

```
-----
Number of Sessions:      1
```

R2

```
#sh bfd session detail
```

```

Session Interface Index : 3           Session Index : 1
Lower Layer : IPv4                   Version : 1
Session Type : Single Hop            Session State : Down
Local Discriminator : 1               Local Address : 10.1.1.2/32
Remote Discriminator : 1              Remote Address : 10.1.1.1/32
Local Port : 49152                    Remote Port : 3784
Local Echo Port : 49153
Options :
Echo Enabled
Diagnostics : None

```

```
Timers in Milliseconds :
```

```

Min Tx: 250           Min Rx: 250           Multiplier: 3
Neg Tx: 2000          Neg Rx: 2000          Neg detect mult: 3

```

Base BFD Configuration

Min echo Tx: 100 Min echo Rx: 1000 Neg echo intrvl: 1000
Storage type : 2
Sess down time : 00:00:01
Sess discontinue time : 00:00:00
Bfd GTSM Disabled
Bfd Authentication Disabled

Counters values:
Pkt In : 0000000000000028f Pkt Out : 000000000000003b8
Echo Out : 00000000000000183 IPv6 Echo Out : 00000000000000000
IPv6 Pkt In : 00000000000000000 IPv6 Pkt Out : 00000000000000000
UP Count : 129 UPTIME : 00:00:00

Protocol Client Info:
BFD-> Client ID: 28 Flags: 4

Number of Sessions: 1

CHAPTER 2 BFD Protocol Configurations

This chapter describes the BFD protocol configurations.

OSPF—BFD Single-Hop Session

This section provides the steps for configuring BFD for Single-Hop OSPF.

Topology



Figure 2-166: Single-Hop OSPF Topology

R1

R1#configure terminal	Enter the Configure mode.
R1(config)#interface lo	Enter the Interface configuration mode for lo
R1(config-if)#ip address 1.1.1.1/32 secondary	Assign IP Address
R1(config)#interface eth1	Enter the Interface configuration mode for eth1.
R1(config-if)#ip address 10.1.1.1/24	Assign IP Address
R1(config-if)#exit	Exit the Interface configuration mode.
R1(config)#router ospf 100	Enter the Router mode for OSPF.
R1(config-router)#network 10.1.1.0/24 area 1	Advertise network 10.1.1.0/24 in OSPF area 1.
R1(config-router)#network 1.1.1.1/32 area 1	Advertise loopback network 1.1.1.1/32 in OSPF area 1.
R1(config-router)#bfd all-interfaces	Enable BFD for all neighbors.
R1(config-router)#commit	Commit the configuration on the node
R1(config-router)#exit	Exit the router mode

R2

R2#configure terminal	Enter the Configure mode.
R2(config)#interface eth1	Enter the Interface configuration mode for eth1.
R2(config-if)#ip address 10.1.1.2/24	Assign IP Address
R2(config-if)#exit	Exit the Interface configuration mode.
R2(config)#interface eth2	Enter the Interface configuration mode for eth2.
R2(config-if)#ip address 20.1.1.1/24	Assign IP Address
R2(config-if)#exit	Exit the Interface configuration mode
R2(config)#router ospf 100	Enter the Router mode for OSPF.

BFD Protocol Configurations

R2(config-router)#network 10.1.1.0/24 area 1	Advertise network 10.1.1.0/24 in OSPF area 1.
R2(config-router)#network 20.1.1.0/24 area 1	Advertise network 20.1.1.0/24 in OSPF area 1.
R2(config-router)#network 2.2.2.2/32 area 1	Advertise loopback network 2.2.2.2/32 in OSPF area 1.
R2(config-router)#bfd all-interfaces	Enable BFD for all neighbors.
R2(config)#interface lo	Enter the Interface configuration mode for lo
R2(config-if)#ip address 2.2.2.2/32 secondary	Assign IP Address
R2(config-router)#commit	Commit the configuration on the node
R2(config-router)#exit	Exit the router mode.

R3

R3#configure terminal	Enter the Configure mode.
R3(config)#interface lo	Enter the Interface configuration mode for lo
R3(config-if)#ip address 3.3.3.3/32 secondary	Assign IP Address
R3(config)#interface eth2	Enter the Interface configuration mode for eth2.
R3(config-if)#ip address 20.1.1.2/24	Assign IP Address.
R3(config-if)#exit	Exit the Interface configuration mode.
R3(config)#router ospf 100	Enter the Router mode for OSPF.
R3(config-router)#network 20.1.1.0/24 area 1	Advertise network 20.1.1.0/24 in OSPF area 1.
R3(config-router)#network 3.3.3.3/32 area 1	Advertise loopback network 3.3.3.3/32 in OSPF area 1.
R3(config-router)#bfd all-interfaces	Enable BFD for all neighbors
R3(config-router)#commit	Commit the configuration on the node
R3(config-router)#exit	Exit the router mode.

Validation

R1

R1#show ip ospf n

Total number of full neighbors: 1

OSPF process 100 VRF(default):

Neighbor ID	Pri	State	Dead Time	Address	Interface	Instance ID
2.2.2.2	1	Full/Backup	00:00:35	10.1.1.2	xe23	0

R1#show bfd session

BFD process for VRF: (DEFAULT VRF)

```
=====
Sess-Idx  Remote-Disc  Lower-Layer  Sess-Type  Sess-State  UP-Time  Interface  Down-
Reason  Remote-Addr
```

1		1	IPv4	Single-Hop	Up	00:02:55
xe23	NA		10.1.1.2/32			
257		0	IPv4	Multi-Hop	Up	00:00:18
xe8	NA		3.3.3.3/32			

Number of Sessions: 2

R1#show bfd session detail

BFD process for VRF: (DEFAULT VRF)

=====

```

Session Interface Index : 10023          Interface name :xe23
Session Index : 1
Lower Layer : IPv4                      Version : 1
Session Type : Single Hop                Session State : Up
Local Discriminator : 1                   Local Address : 10.1.1.1/32
Remote Discriminator : 1                  Remote Address : 10.1.1.2/32
Local Port : 49152                        Remote Port : 3784
Options :
```

Diagnostics : None

Timers in Milliseconds :

```

Min Tx: 250          Min Rx: 250          Multiplier: 3
Neg Tx: 250          Neg Rx: 250          Neg detect mult: 3
Min echo Tx: 1000    Min echo Rx: 1000    Neg echo intrvl: 0
Storage type : 2
Sess down time : 00:00:00
Sess Down Reason : NA
Bfd GTSM Disabled
Bfd Authentication Disabled
```

Counters values:

```

Pkt In : 0000000000000000000814          Pkt Out : 0000000000000000000814
Pkts Drop : 000000000000000000000000    Auth Pkts Drop : 000000000000000000000000
Echo Out : 00000000000000000000000000    IPv6 Echo Out : 00000000000000000000000000
IPv6 Pkt In : 00000000000000000000000000    IPv6 Pkt Out : 00000000000000000000000000
UP Count : 1                                UPTIME : 00:02:59
```

Protocol Client Info:

BGP-> Client ID: 44 Flags: 4

```

-----
Session Interface Index : 0          Session Index : 257
Lower Layer : IPv4                  Version : 1
Session Type : Multihop Arbit Path  Session State : Up
Local Discriminator : 257           Local Address : 1.1.1.1/32
Remote Discriminator : 0            Remote Address : 3.3.3.3/32
Local Port : 49153                  Remote Port : 4784
Options :
```

BFD Protocol Configurations

Diagnostics : None

Timers in Milliseconds :

Min Tx: 250 Min Rx: 250 Multiplier: 3
Neg Tx: 0 Neg Rx: 0 Neg detect mult: 0
Min echo Tx: 1000 Min echo Rx: 1000 Neg echo intrvl: 0
Storage type : 2
Sess down time : 00:00:00
Sess Down Reason : NA
Bfd GTSM Disabled
Bfd Authentication Disabled

Counters values:

Pkt In : 00000000000000000000 Pkt Out : 0000000000000000000107
Pkts Drop : 00000000000000000000 Auth Pkts Drop : 00000000000000000000
Echo Out : 00000000000000000000 IPv6 Echo Out : 00000000000000000000
IPv6 Pkt In : 00000000000000000000 IPv6 Pkt Out : 00000000000000000000
UP Count : 0 UPTIME : 00:00:00

R3#show bfd session

BFD process for VRF: (DEFAULT VRF)

```
=====
Sess-Idx Remote-Disc Lower-Layer Sess-Type Sess-State UP-Time Interface      Down-Reason
Remote-Addr
1          1          IPv4          Single-Hop  Up        00:04:33  eth2          NA
20.1.1.3/32
-----
```

R1#show bfd session detail

```
=====
Session Interface Index : 3
Interface name : eth1                      Session Index : 1
Lower Layer : IPv4                        Version : 1
Session Type : Single Hop                Session State : Up
Local Discriminator : 1                    Local Address : 10.1.1.1/32
Remote Discriminator : 1                  Remote Address : 10.1.1.2/32
Local Port : 49152                        Remote Port : 3784
Options :
```

Diagnostics : None

Timers in Milliseconds :

Min Tx: 250 Min Rx: 250 Multiplier: 3
Neg Tx: 250 Neg Rx: 250 Neg detect mult: 3
Min echo Tx: 1000 Min echo Rx: 1000 Neg echo intrvl: 0
Storage type : 2
Sess down time : 00:00:00
Bfd GTSM Disabled
Bfd Authentication Disabled

Counters values:

```
Pkt In : 00000000000000cf3          Pkt Out : 00000000000000cfc
Echo Out : 00000000000000000      IPv6 Echo Out : 00000000000000000
IPv6 Pkt In : 00000000000000000    IPv6 Pkt Out : 00000000000000000
UP Count : 1                        UPTIME : 00:12:12
```

Protocol Client Info:

```
OSPF-> Client ID: 4          Flags: 4
-----
```

```
Number of Sessions:      1
```

R2#show bfd session detail

```
=====
Session Interface Index : 3
Interface name : eth1          Session Index : 1
Lower Layer : IPv4            Version : 1
Session Type : Single Hop     Session State : Up
Local Discriminator : 1       Local Address : 10.1.1.2/32
Remote Discriminator : 1      Remote Address : 10.1.1.1/32
Local Port : 49152           Remote Port : 3784
Options :
```

```
Diagnostics : None
```

Timers in Milliseconds :

```
Min Tx: 250          Min Rx: 250          Multiplier: 3
Neg Tx: 250          Neg Rx: 2000         Neg detect mult: 3
Min echo Tx: 1000    Min echo Rx: 1000    Neg echo intrvl: 0
Storage type : 2
Sess down time : 00:00:00
Bfd GTSM Disabled
Bfd Authentication Disabled
```

Counters values:

```
Pkt In : 00000000000000d6f        Pkt Out : 00000000000000da5
Echo Out : 00000000000000000      IPv6 Echo Out : 00000000000000000
IPv6 Pkt In : 00000000000000000    IPv6 Pkt Out : 00000000000000000
UP Count : 1                        UPTIME : 00:12:39
```

Protocol Client Info:

```
OSPF-> Client ID: 4          Flags: 4
-----
```

```
Session Interface Index : 4
Interface name : eth1          Session Index : 2
Lower Layer : IPv4            Version : 1
Session Type : Single Hop     Session State : Up
Local Discriminator : 2       Local Address : 20.1.1.1/32
Remote Discriminator : 1      Remote Address : 20.1.1.2/32
```

BFD Protocol Configurations

Local Port : 49153 Remote Port : 3784
Options :

Diagnostics : None

Timers in Milliseconds :

Min Tx: 250 Min Rx: 250 Multiplier: 3
Neg Tx: 250 Neg Rx: 2000 Neg detect mult: 3
Min echo Tx: 1000 Min echo Rx: 1000 Neg echo intrvl: 0
Storage type : 2
Sess down time : 00:00:00
Bfd GTSM Disabled
Bfd Authentication Disabled

Counters values:

Pkt In : 00000000000000d30 Pkt Out : 00000000000000d5e
Echo Out : 00000000000000000 IPv6 Echo Out : 00000000000000000
IPv6 Pkt In : 00000000000000000 IPv6 Pkt Out : 00000000000000000
UP Count : 1 UPTIME : 00:12:24

R2

R2#show ip ospf neighbor

Total number of full neighbors: 2

OSPF process 100 VRF(default):

Neighbor ID	Pri	State	Dead Time	Address	Interface	Instance ID
1.1.1.1	1	Full/DR	00:00:32	10.1.1.1	xe9/3	0
3.3.3.3	1	Full/Backup	00:00:40	20.1.1.2	xe17/1	0

R2#show bfd session

BFD process for VRF: (DEFAULT VRF)

```
=====
```

Sess-Idx	Remote-Disc	Lower-Layer	Sess-Type	Sess-State	UP-Time	Interface	Down-Reason
1	1	IPv4		Single-Hop	Up	00:02:33	
xe9/3	NA	10.1.1.1/32					
2	1	IPv4		Single-Hop	Up	00:01:54	
xe17/1	NA	20.1.1.2/32					

Number of Sessions: 2

R2#show bfd session detail

BFD process for VRF: (DEFAULT VRF)

```
=====
```

Session Interface Index : 10023 Interface name :xe9/3
Session Index : 1

Lower Layer : IPv4
Session Type : Single Hop
Local Discriminator : 1
Remote Discriminator : 1
Local Port : 49152
Options :

Version : 1
Session State : Up
Local Address : 10.1.1.2/32
Remote Address : 10.1.1.1/32
Remote Port : 3784

Diagnostics : None

Timers in Milliseconds :

Min Tx: 250	Min Rx: 250	Multiplier: 3
Neg Tx: 250	Neg Rx: 250	Neg detect mult: 3
Min echo Tx: 1000	Min echo Rx: 1000	Neg echo intrvl: 0

Storage type : 2
Sess down time : 00:00:00
Sess Down Reason : NA
Bfd GTSM Disabled
Bfd Authentication Disabled

Counters values:

Pkt In : 00000000000000000713	Pkt Out : 00000000000000000714
Pkts Drop : 00000000000000000000	Auth Pkts Drop : 00000000000000000000
Echo Out : 00000000000000000000	IPv6 Echo Out : 00000000000000000000
IPv6 Pkt In : 00000000000000000000	IPv6 Pkt Out : 00000000000000000000
UP Count : 1	UPTIME : 00:02:37

Protocol Client Info:
BGP-> Client ID: 44 Flags: 4

Session Interface Index : 10053 Interface name :xe17/1
Session Index : 2
Lower Layer : IPv4
Session Type : Single Hop
Local Discriminator : 2
Remote Discriminator : 1
Local Port : 49153
Options :

Version : 1
Session State : Up
Local Address : 20.1.1.1/32
Remote Address : 20.1.1.2/32
Remote Port : 3784

Diagnostics : None

Timers in Milliseconds :

Min Tx: 250	Min Rx: 250	Multiplier: 3
Neg Tx: 250	Neg Rx: 250	Neg detect mult: 3
Min echo Tx: 1000	Min echo Rx: 1000	Neg echo intrvl: 0

Storage type : 2
Sess down time : 00:00:00
Sess Down Reason : NA
Bfd GTSM Disabled
Bfd Authentication Disabled

BFD Protocol Configurations

Counters values:

```
Pkt In : 00000000000000000535          Pkt Out : 00000000000000000537
Pkts Drop : 00000000000000000000      Auth Pkts Drop : 00000000000000000000
Echo Out : 00000000000000000000      IPv6 Echo Out : 00000000000000000000
IPv6 Pkt In : 00000000000000000000    IPv6 Pkt Out : 00000000000000000000
UP Count : 1                          UPTIME : 00:01:58
```

Protocol Client Info:

```
BGP-> Client ID: 44          Flags: 4
```

Number of Sessions: 2

R3

R3#show ip ospf n

Total number of full neighbors: 1

OSPF process 100 VRF(default):

Neighbor ID	Pri	State	Dead Time	Address	Interface	Instance ID
2.2.2.2	1	Full/DR	00:00:36	20.1.1.1	xe17/10	0

R3#show bfd session

BFD process for VRF: (DEFAULT VRF)

```
=====
Sess-Idx  Remote-Disc  Lower-Layer  Sess-Type  Sess-State  UP-Time  Interface  Down-
Reason   Remote-Addr
1         NA          2           IPv4       Single-Hop  Up       xe17/1     00:01:21
xe17/1
257      00:00:00    xe6         1           IPv4       Multi-Hop  Up
00:00:00
Number of Sessions: 2
Total number of Established sessions 2
```

R3#show bfd session detail

BFD process for VRF: (DEFAULT VRF)

```
=====
Session Interface Index : 10053          Interface name :xe17/1
Session Index : 1
Lower Layer : IPv4                       Version : 1
Session Type : Single Hop                 Session State : Up
Local Discriminator : 1                   Local Address : 20.1.1.2/32
Remote Discriminator : 2                   Remote Address : 20.1.1.1/32
Local Port : 49152                        Remote Port : 3784
Options :
```

Diagnostics : None

Timers in Milliseconds :

```
Min Tx: 250                Min Rx: 250                Multiplier: 3
Neg Tx: 250                Neg Rx: 250                Neg detect mult: 3
Min echo Tx: 1000         Min echo Rx: 1000         Neg echo intrvl: 0
Storage type : 2
Sess down time : 00:00:00
Sess Down Reason : NA
Bfd GTSM Disabled
Bfd Authentication Disabled
```

Counters values:

```
Pkt In : 000000000000000000391          Pkt Out : 000000000000000000391
Pkts Drop : 000000000000000000000000    Auth Pkts Drop : 000000000000000000000000
Echo Out : 00000000000000000000000000    IPv6 Echo Out : 000000000000000000000000
IPv6 Pkt In : 00000000000000000000000000    IPv6 Pkt Out : 00000000000000000000000000
UP Count : 1                                UPTIME : 00:01:26
```

Protocol Client Info:

```
BGP-> Client ID: 44          Flags: 4
-----
```

```
Session Interface Index : 0                Session Index : 257
Lower Layer : IPv4                          Version : 1
Session Type : Multihop Arbit Path         Session State : Up
Local Discriminator : 257                  Local Address : 3.3.3.3/32
Remote Discriminator : 1                   Remote Address : 1.1.1.1/32
Local Port : 49153                          Remote Port : 4784
Options :
```

```
Diagnostics : None
```

Timers in Milliseconds :

```
Min Tx: 250                Min Rx: 250                Multiplier: 3
Neg Tx: 250                Neg Rx: 250                Neg detect mult:250
Min echo Tx: 1000         Min echo Rx: 1000         Neg echo intrvl: 0
Storage type : 2
Sess down time : 00:00:00
Sess Down Reason : NA
Bfd GTSM Disabled
Bfd Authentication Disabled
```

Counters values:

```
Pkt In : 0000000000000000000000000000    Pkt Out : 000000000000000000000047
Pkts Drop : 0000000000000000000000000000    Auth Pkts Drop : 000000000000000000000000
Echo Out : 0000000000000000000000000000    IPv6 Echo Out : 000000000000000000000000
IPv6 Pkt In : 0000000000000000000000000000    IPv6 Pkt Out : 00000000000000000000000000
UP Count : 0                                UPTIME : 00:00:00
```

Protocol Client Info:

BGP-> Client ID: 44 Flags: 4

 Number of Sessions: 2

OSPF—BFD Multi-Hop Session

This section provides the steps for configuring BFD for OSPF multi-hop sessions.

Topology

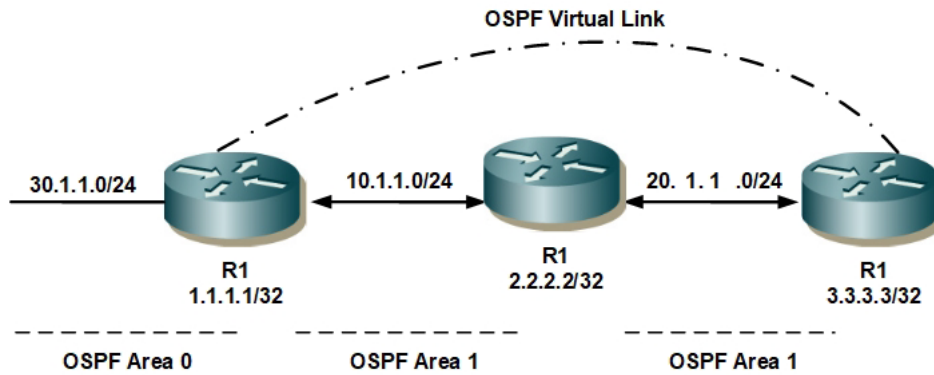

Figure 2-167: Multi-hop OSPFv2 Topology

R1

R1#configure terminal	Enter the Configure mode.
R1(config)#interface lo	Enter the Interface configuration mode for lo
R1(config-if)#ip address 1.1.1.1/32 secondary	Assign IP Address
R1(config)#interface eth1	Enter the Interface configuration mode for eth1.
R1(config-if)#ip address 10.1.1.1/24	Assign IP Address
R1(config-if)#exit	Exit the Interface configuration mode.
R1(config)#interface eth2	Enter the Interface configuration mode for eth1.
R1(config-if)#ip address 30.1.1.1/24	Assign IP Address
R1(config-if)#exit	Exit the Interface configuration mode.
R1(config)#router ospf 100	Enter the Router mode for OSPF.
R1(config-router)#ospf router-id 1.1.1.1	OSPF router ID in IPv4 format
R1(config-router)#bfd all-interfaces	Enable BFD for all neighbors.
R1(config-router)#network 10.1.1.0/24 area 1	Advertise network 20.1.1.0/24 in OSPF area 1.
R1(config-router)#network 1.1.1.1/32 area 1	Advertise loopback network 1.1.1.1/32 in OSPF area 1.
R1(config-router)#network 30.1.1.0/24 area 0	Advertise network 30.1.1.0/24 in OSPF area 0.
R1(config-router)#area 1 virtual-link 3.3.3.3 fall-over bfd	Create a virtual link to R3 with BFD.
R1(config-router)#commit	Commit the configuration on the node

R2

R2#configure terminal	Enter the Configure mode
R2(config)#interface eth1	Enter the Interface configuration mode for eth1.
R2(config-if)#ip address 10.1.1.2/24	Assign IP Address
R2(config-if)#exit	Exit the Interface configuration mode.
R2(config)#interface eth2	Enter the Interface configuration mode for eth2.
R2(config-if)#ip address 20.1.1.1/24	Assign IP Address
R2(config-if)#exit	Exit the Interface configuration mode
R2(config)#interface lo	Enter the Interface configuration mode for lo
R2(config-if)#ip address 2.2.2.2/32 secondary	Assign IP Address
R2(config-if)#exit	Exit the Interface configuration mode
R2(config)#router ospf 100	Enter the Router mode for OSPF.
R2(config-router)#bfd all-interfaces	Enable BFD for all neighbors.
R2(config-router)#ospf router-id 2.2.2.2	OSPF router ID in IPv4 format
R2(config-router)#network 10.1.1.0/24 area 1	Advertise network 10.1.1.0/24 in OSPF area 1.
R2(config-router)#network 20.1.1.0/24 area 1	Advertise network 20.1.1.0/24 in OSPF area 1.
R2(config-router)#network 2.2.2.2/32 area 1	Advertise loopback network 2.2.2.2/32 in OSPF area 1.
R2(config-router)#commit	Commit the configuration on the node
R2(config-router)#exit	Exit the router mode.

R3

R3#configure terminal	Enter the Configure mode.
R3(config)#interface lo	Enter the Interface configuration mode for lo
R3(config-if)#ip address 3.3.3.3/32 secondary	Assign IP Address
R3(config-if)#exit	Exit the Interface configuration mode.
R3(config)#interface eth2	Enter the Interface configuration mode for eth2.
R3(config-if)#ip address 20.1.1.2/24	Assign IP Address.
R3(config-if)#exit	Exit the Interface configuration mode.
R3(config)#router ospf 100	Enter the Router mode for OSPF.
R3(config-router)#ospf router-id 3.3.3.3	OSPF router ID in IPv4 format
R3(config-router)#bfd all-interfaces	Enable BFD for all neighbors.
R3(config-router)#network 20.1.1.0/24 area 1	Advertise network 20.1.1.0/24 in OSPF area 1.
R3(config-router)#network 3.3.3.3/32 area 1	Advertise loopback network 3.3.3.3/32 in OSPF area 1.
R3(config-router)#area 1 virtual-link 1.1.1.1 fall-over bfd	Create a virtual link to R1 with BFD.
R3(config-router)#commit	Commit the configuration on the node

Validation

R1#sh bfd session

BFD process for VRF: (DEFAULT VRF)

```
=====
Sess-Idx  Remote-Disc  Lower-Layer  Sess-Type   Sess-State  UP-Time   Interface
Down-Reason Remote-Addr
257       257          IPv4         Multi-Hop   Up          00:00:54
NA        NA           20.1.1.2/32
```

Number of Sessions: 1

R2#sh bfd session

BFD process for VRF: (DEFAULT VRF)

```
=====
Sess-Idx  Remote-Disc  Lower-Layer  Sess-Type   Sess-State  UP-Time   Interface
Down-Reason Remote-Addr
```

Number of Sessions: 0

R3#sh bfd session

BFD process for VRF: (DEFAULT VRF)

```
=====
Sess-Idx  Remote-Disc  Lower-Layer  Sess-Type   Sess-State  UP-Time   Interface
Down-Reason Remote-Addr
257       257          IPv4         Multi-Hop   Up          00:01:46  NA
10.1.1.1/32
```

Number of Sessions: 1

R1#sh bfd session detail

BFD process for VRF: (DEFAULT VRF)

```
=====
Session Interface Index : 0           Session Index : 257
Lower Layer : IPv4                 Version : 1
Session Type : Multihop Arbit Path  Session State : Up
Local Discriminator : 257           Local Address : 10.1.1.1/32
Remote Discriminator : 257          Remote Address : 20.1.1.2/32
Local Port : 49152                  Remote Port : 4784
Options :
```

Diagnostics : None

Timers in Milliseconds :

```

Min Tx: 250           Min Rx: 250           Multiplier: 3
Neg Tx: 250           Neg Rx: 250           Neg detect mult: 3
Min echo Tx: 1000     Min echo Rx: 1000     Neg echo intrvl: 0
Storage type : 2
Sess down time : 00:00:00
Sess Down Reason : NA
Bfd GTSM Disabled
Bfd Authentication Disabled

```

Counters values:

```

Pkt In : 0000000000000000000606           Pkt Out : 0000000000000000000605
Pkts Drop : 00000000000000000000000000000000   Auth Pkts Drop : 00000000000000000000000000000000
Echo Out : 00000000000000000000000000000000   IPv6 Echo Out : 00000000000000000000000000000000
IPv6 Pkt In : 00000000000000000000000000000000   IPv6 Pkt Out : 00000000000000000000000000000000
UP Count : 1                                     UPTIME : 00:02:13

```

Protocol Client Info:

```

OSPF-> Client ID: 4           Flags: 4
-----

```

```

Number of Sessions:      1

```

R2#sh bfd session detail

```

BFD process for VRF: (DEFAULT VRF)
=====

```

```

Number of Sessions:      0
R2#

```

R3#sh bfd session detail

```

BFD process for VRF: (DEFAULT VRF)
=====

```

```

Session Interface Index : 0           Session Index : 257
Lower Layer : IPv4                   Version : 1
Session Type : Multihop Arbit Path    Session State : Up
Local Discriminator : 257             Local Address : 20.1.1.2/32
Remote Discriminator : 257            Remote Address : 10.1.1.1/32
Local Port : 49152                    Remote Port : 4784
Options :

```

```

Diagnostics : None

```

Timers in Milliseconds :

```

Min Tx: 250           Min Rx: 250           Multiplier: 3
Neg Tx: 250           Neg Rx: 250           Neg detect mult: 3

```

BFD Protocol Configurations

```
Min echo Tx: 1000           Min echo Rx: 1000           Neg echo intrvl: 0
Storage type : 2
Sess down time : 00:00:00
Sess Down Reason : NA
Bfd GTSM Disabled
Bfd Authentication Disabled
```

Counters values:

```
Pkt In : 00000000000000000529           Pkt Out : 00000000000000000530
Pkts Drop : 00000000000000000000       Auth Pkts Drop : 00000000000000000000
Echo Out : 00000000000000000000       IPv6 Echo Out : 00000000000000000000
IPv6 Pkt In : 00000000000000000000     IPv6 Pkt Out : 00000000000000000000
UP Count : 1                           UPTIME : 00:01:56
```

Protocol Client Info:

```
OSPF-> Client ID: 4           Flags: 4
```

```
-----
Number of Sessions:      1
```

BFD Configuration in IS-IS

This section provides the steps for configuring BFD for the IS-IS protocol.

Topology



Figure 2-168: Basic Topology for BFD-ISIS

R1

R1#configure terminal	Enter the Configure mode.
R1(config)#interface eth1	Enter interface mode.
R1(config-if)#ip address 10.1.1.1/24	Configure IP address.
R2(config-if)#ip router isis 1	Configure ISIS router
R1(config-if)#exit	Exit interface mode.
R1(config)#router isis 1	Enter the Router mode for IS-IS.
R1(config-router)#net 10.0000.0000.0001.00	Advertise network 10.0000.0000.0001.00 in IS-IS.
R1(config-router)#bfd all-interfaces	Enable BFD for all neighbors.
R1(config-router)#commit	Commit the configuration on the node

R2

R2#configure terminal	Enter the Configure mode.
R2(config)#interface eth1	Enter interface mode.
R2(config-if)#ip address 10.1.1.2/24	Configure IP address.
R2(config-if)#ip router isis 1	Configure ISIS router
R2(config-if)#exit	Exit interface mode.
R2(config)#router isis 1	Enter the Router mode for IS-IS.
R2(config-router)#net 10.0000.0000.0002.00	Advertise network 10.0000.0000.0002.00 in IS-IS.
R2(config-router)#bfd all-interfaces	Enable BFD for all neighbors.
R2(config-router)#commit	Commit the configuration on the node

Validation

R1#show bfd session

BFD process for VRF: (DEFAULT VRF)

=====

Sess-Idx	Remote-Disc	Lower-Layer	Sess-Type	Sess-State	UP-Time	Interface
1		1	IPv4	Single-Hop		Up
00:00:42	eth1		NA	10.1.1.1/32		

Number of Sessions: 1

R2#show bfd session

BFD process for VRF: (DEFAULT VRF)

=====

Sess-Idx	Remote-Disc	Lower-Layer	Sess-Type	Sess-State	UP-Time	Interface
1	1		IPv4	Single-Hop	Up	00:10:23
NA	10.1.1.2/32					eth1
1	1		IPv4	Single-Hop	Up	00:10:23
NA	20.1.1.2/32					eth2

Number of Sessions: 2

R1#show bfd session detail

=====

Session Interface Index : 3

Interface name : eth1

Lower Layer : IPv4

Session Type : Single Hop

Local Discriminator : 2

Remote Discriminator : 3

Local Port : 49153

Options :

Diagnostics : None

Session Index : 2

Version : 1

Session State : Up

Local Address : 10.1.1.1/32

Remote Address : 10.1.1.2/32

Remote Port : 3784

BFD Protocol Configurations

Timers in Milliseconds :

Min Tx: 250 Min Rx: 250 Multiplier: 3
Neg Tx: 250 Neg Rx: 2000 Neg detect mult: 3
Min echo Tx: 1000 Min echo Rx: 1000 Neg echo intrvl: 0
Storage type : 2
Sess down time : 00:00:00
Bfd GTSM Disabled
Bfd Authentication Disabled

Counters values:

Pkt In : 0000000000000027b Pkt Out : 00000000000000278
Echo Out : 00000000000000000 IPv6 Echo Out : 00000000000000000
IPv6 Pkt In : 00000000000000000 IPv6 Pkt Out : 00000000000000000
UP Count : 1 UPTIME : 00:02:19

Protocol Client Info:

ISIS-> Client ID: 6 Flags: 4

Number of Sessions: 1

R2#sh bfd session detail

=====
Session Interface Index : 3
Interface name : eth1 Session Index : 3
Lower Layer : IPv4 Version : 1
Session Type : Single Hop Session State : Up
Local Discriminator : 3 Local Address : 10.1.1.2/32
Remote Discriminator : 2 Remote Address : 10.1.1.1/32
Local Port : 49154 Remote Port : 3784
Options :

Diagnostics : None

Timers in Milliseconds :

Min Tx: 250 Min Rx: 250 Multiplier: 3
Neg Tx: 250 Neg Rx: 250 Neg detect mult: 3
Min echo Tx: 1000 Min echo Rx: 1000 Neg echo intrvl: 0
Storage type : 2
Sess down time : 00:00:00
Bfd GTSM Disabled
Bfd Authentication Disabled

Counters values:

Pkt In : 000000000000002db Pkt Out : 000000000000002dd
Echo Out : 00000000000000000 IPv6 Echo Out : 00000000000000000
IPv6 Pkt In : 00000000000000000 IPv6 Pkt Out : 00000000000000000
UP Count : 1 UPTIME : 00:02:42

```

Protocol Client Info:
ISIS-> Client ID: 6      Flags: 4
-----
Number of Sessions:      1

```

BFD Configuration in BGP

This section provides the steps for configuring BFD for the BGP protocol.

Topology



Figure 2-169: Basic Topology for BFD in BGP

R1

R1#configure terminal	Enter configure mode
R1(config)#interface eth1	Enter the Interface configuration mode for eth1.
R1(config-if)#ip address 10.1.1.1/24	Assign IP Address
R1(config-if)#exit	Exit the Interface configuration mode.
R1(config)# interface lo	Enter interface mode
R1(config-if)#ip address 1.1.1.1/32 secondary	Configure the IP address on loopback interface.
R1(config-if)#bfd session 1.1.1.1 3.3.3.3 multihop	Enable BFD multihop session
R1(config)#router ospf 100	Enter Router mode for OSPF
R1(config-router)# ospf router-id 1.1.1.1	Configure router-id in OSPF
R1(config-router)# network 1.1.1.1/32 area 0.0.0.1	Advertise network 1.1.1.1/32 in OSPF area 1.
R1(config-router)# network 10.1.1.0/24 area 0.0.0.1	Advertise network 10.1.1.0/24 in OSPF area 1.
R1(config)#router bgp 100	Enter Router mode for BGP
R1(config-router)# neighbor 3.3.3.3 remote- as 100	Add the neighbor 3.3.3.3 to remote-as 100.
R1(config-router)# neighbor 3.3.3.3 fall- over bfd	Enable BFD option for neighbor multihop
R1(config-router)#neighbor 3.3.3.3 update- source lo	Add neighbor 3.3.3.3 to update-source lo.
R1(config-router)#neighbor 10.1.1.2 remote- as 100	Add neighbor 10.1.1.2 to remote-as 100.
R1(config-router)# neighbor 10.1.1.2 fall- over bfd	Enable BFD option for neighbor

BFD Protocol Configurations

R1(config-router)#commit	Commit the configuration on the node
R1(config-router)#end	Exit from Router BGP mode

R2

R2#configure terminal	Enter configure mode
R2(config)#interface eth1	Enter the Interface configuration mode for eth1.
R2(config-if)#ip address 10.1.1.2/24	Assign IP Address
R2(config-if)#exit	Exit the Interface configuration mode.
R2(config)#interface eth2	Enter the Interface configuration mode for eth2.
R2(config-if)#ip address 20.1.1.1/24	Assign IP Address
R2(config-if)#exit	Exit the Interface configuration mode
R2(config)# interface lo	Enter interface mode
R2(config-if)#ip address 2.2.2.2/32 secondary	Configure the IP address on loopback interface.
R2(config-if)#exit	Exit the Interface configuration mode
R2(config)#router ospf 100	Enter Router mode for OSPF
R2(config-router)#ospf router-id 2.2.2.2	Configure router-id in OSPF
R2(config-router)# network 2.2.2.2/32 area 0.0.0.1	Advertise network 1.1.1.1/32 in OSPF area 1.
R2(config-router)#network 10.1.1.0/24 area 0.0.0.1	Advertise network 10.1.1.0/24 in OSPF area 1.
R2(config-router)# network 20.1.1.0/24 area 0.0.0.1	Advertise network 20.1.1.0/24 in OSPF area 1.
R3(config-router)#exit	Exit from Router OSPF mode
R2(config)#router bgp 100	Enter Router mode for BGP
R2(config-router)# neighbor 10.1.1.1 remote- as 100	Add neighbor 10.1.1.1 to remote-as 100.
R2(config-router)#neighbor 10.1.1.1 fall- over bfd	Enable BFD option for neighbor
R2(config-router)# neighbor 20.1.1.2 remote- as 100	Add neighbor 20.1.1.2 to remote-as 100.
R2(config-router)# neighbor 20.1.1.2 fall- over bfd	Enable BFD option for neighbor
R2(config-router)#commit	Commit the configuration on the node
R2(config-router)#end	Exit from Router BGP mode

R3

R3#configure terminal	Enter configure mode
R3(config)#interface eth2	Enter the Interface configuration mode for eth2.
R3(config-if)#ip address 20.1.1.2/24	Assign IP Address.
R3(config-if)#exit	Exit the Interface configuration mode.
R3(config)# interface lo	Enter interface mode

R3(config-if)#ip address 3.3.3.3/32 secondary	Configure IP address on loopback interface.
R1(config-if)#bfd session 3.3.3.3 1.1.1.1 multihop	Enable BFD multihop session
R2(config-if)#exit	Exit the Interface configuration mode
R3(config)#router ospf 100	Enter Router mode for OSPF
R3(config-router)#ospf router-id 3.3.3.3	Configure router-id in OSPF
R3(config-router)# network 3.3.3.3/32 area 0.0.0.1	Advertise network 3.3.3.3/32 in OSPF area 1.
R3(config-router)# network 20.1.1.0/24 area 0.0.0.1	Advertise network 20.1.1.0/24 in OSPF area 1.
R3(config-router)#exit	Exit from Router OSPF mode
R3(config)#router bgp 100	Enter Router mode for BGP
R3(config-router)# neighbor 1.1.1.1 remote-as 100	Add neighbor 1.1.1.1 to remote-as 100.
R3(config-router)# neighbor 1.1.1.1 fall-over bfd multihop	Enable BFD option for neighbor
R3(config-router)#neighbor 1.1.1.1 update-source lo	Add neighbor 1.1.1.1 to update-source lo.
R3(config-router)# neighbor 20.1.1.1 remote-as 100	Add neighbor 20.1.1.1 to remote-as 100.
R3(config-router)#neighbor 20.1.1.1 fall-over bfd	Enable BFD option for neighbor
R3(config-router)#commit	Commit the configuration on the node
R3(config-router)#end	Exit from Router BGP mode

Validation

R1

```
R1#show ip ospf neighbor
```

```
Total number of full neighbors: 1
```

```
OSPF process 100 VRF(default):
```

Neighbor ID	Pri	State	Dead Time	Address	Interface	Instance ID
2.2.2.2	1	Full/Backup	00:00:35	10.1.1.2	eth1	0

```
R1#show bfd session
```

```
BFD process for VRF: (DEFAULT VRF)
```

```
=====
```

Sess-Idx	Remote-Disc	Lower-Layer	Sess-Type	Sess-State	UP-Time	Interface	Down-Reason
1	NA	1	IPv4	Single-Hop	Up	eth1	00:02:55
257	NA	0	IPv4	Multi-Hop	Up	eth1	00:00:18

```
Number of Sessions: 2
```

BFD Protocol Configurations

R1#show bfd session detail

BFD process for VRF: (DEFAULT VRF)

=====
=====

```
Session Interface Index : 10023      Interface name :eth1
Session Index : 1
Lower Layer : IPv4                  Version : 1
Session Type : Single Hop          Session State : Up
Local Discriminator : 1             Local Address : 10.1.1.1/32
Remote Discriminator : 1           Remote Address : 10.1.1.2/32
Local Port : 49152                 Remote Port : 3784
Options :
```

Diagnostics : None

Timers in Milliseconds :

```
Min Tx: 250          Min Rx: 250          Multiplier: 3
Neg Tx: 250          Neg Rx: 250          Neg detect mult: 3
Min echo Tx: 1000    Min echo Rx: 1000    Neg echo intrvl: 0
Storage type : 2
Sess down time : 00:00:00
Sess Down Reason : NA
Bfd GTSM Disabled
Bfd Authentication Disabled
```

Counters values:

```
Pkt In : 00000000000000000814      Pkt Out : 00000000000000000814
Pkts Drop : 00000000000000000000    Auth Pkts Drop : 00000000000000000000
Echo Out : 00000000000000000000      IPv6 Echo Out : 00000000000000000000
IPv6 Pkt In : 00000000000000000000    IPv6 Pkt Out : 00000000000000000000
UP Count : 1                          UPTIME : 00:02:59
```

Protocol Client Info:

```
BGP-> Client ID: 44      Flags: 4
-----
```

```
Session Interface Index : 0          Session Index : 257
Lower Layer : IPv4                  Version : 1
Session Type : Multihop Arbit Path  Session State : Up
Local Discriminator : 257           Local Address : 1.1.1.1/32
Remote Discriminator : 0            Remote Address : 3.3.3.3/32
Local Port : 49153                 Remote Port : 4784
Options :
```

Diagnostics : None

Timers in Milliseconds :

Min Tx: 250 Min Rx: 250 Multiplier: 3
Neg Tx: 0 Neg Rx: 0 Neg detect mult: 0
Min echo Tx: 1000 Min echo Rx: 1000 Neg echo intrvl: 0
Storage type : 2
Sess down time : 00:00:00
Sess Down Reason : NA
Bfd GTSM Disabled
Bfd Authentication Disabled

Counters values:
Pkt In : 000000000000000000000 Pkt Out : 00000000000000000000107
Pkts Drop : 000000000000000000000 Auth Pkts Drop : 000000000000000000000
Echo Out : 000000000000000000000 IPv6 Echo Out : 000000000000000000000
IPv6 Pkt In : 000000000000000000000 IPv6 Pkt Out : 000000000000000000000
UP Count : 0 UPTIME : 00:00:00

R2

R2#show ip ospf neighbor

Total number of full neighbors: 2
OSPF process 100 VRF(default):
Neighbor ID Pri State Dead Time Address Interface Instance ID
1.1.1.1 1 Full/DR 00:00:32 10.1.1.1 eth1 0
3.3.3.3 1 Full/Backup 00:00:40 20.1.1.2 eth2 0

R2#show bfd session

BFD process for VRF: (DEFAULT VRF)
Sess-Idx Remote-Disc Lower-Layer Sess-Type Sess-State UP-Time Interface Down-Reason Remote-Addr
1 1 IPv4 Single-Hop Up eth1 00:02:33 NA 10.1.1.1/32
2 1 IPv4 Single-Hop Up eth2 00:01:54 NA 20.1.1.2/32
Number of Sessions: 2

R2#show bfd session detail

BFD process for VRF: (DEFAULT VRF)
Session Interface Index : 10023 Interface name :eth1
Session Index : 1
Lower Layer : IPv4 Version : 1
Session Type : Single Hop Session State : Up
Local Discriminator : 1 Local Address : 10.1.1.2/32

BFD Protocol Configurations

Remote Discriminator : 1 Remote Address : 10.1.1.1/32
Local Port : 49152 Remote Port : 3784
Options :

Diagnostics : None

Timers in Milliseconds :

Min Tx: 250	Min Rx: 250	Multiplier: 3
Neg Tx: 250	Neg Rx: 250	Neg detect mult: 3
Min echo Tx: 1000	Min echo Rx: 1000	Neg echo intrvl: 0

Storage type : 2
Sess down time : 00:00:00
Sess Down Reason : NA
Bfd GTSM Disabled
Bfd Authentication Disabled

Counters values:

Pkt In : 00000000000000000713	Pkt Out : 00000000000000000714
Pkts Drop : 00000000000000000000	Auth Pkts Drop : 00000000000000000000
Echo Out : 00000000000000000000	IPv6 Echo Out : 00000000000000000000
IPv6 Pkt In : 00000000000000000000	IPv6 Pkt Out : 00000000000000000000
UP Count : 1	UPTIME : 00:02:37

Protocol Client Info:
BGP-> Client ID: 44 Flags: 4

Session Interface Index : 10053 Interface name : eth2
Session Index : 2
Lower Layer : IPv4 Version : 1
Session Type : Single Hop Session State : Up
Local Discriminator : 2 Local Address : 20.1.1.1/32
Remote Discriminator : 1 Remote Address : 20.1.1.2/32
Local Port : 49153 Remote Port : 3784
Options :

Diagnostics : None

Timers in Milliseconds :

Min Tx: 250	Min Rx: 250	Multiplier: 3
Neg Tx: 250	Neg Rx: 250	Neg detect mult: 3
Min echo Tx: 1000	Min echo Rx: 1000	Neg echo intrvl: 0

Storage type : 2
Sess down time : 00:00:00
Sess Down Reason : NA
Bfd GTSM Disabled
Bfd Authentication Disabled

Counters values:

Pkt In : 00000000000000000535	Pkt Out : 00000000000000000537
-------------------------------	--------------------------------

```

Pkts Drop : 00000000000000000000
Echo Out : 00000000000000000000
IPv6 Pkt In : 00000000000000000000
UP Count : 1
Auth Pkts Drop : 00000000000000000000
IPv6 Echo Out : 00000000000000000000
IPv6 Pkt Out : 00000000000000000000
UPTIME : 00:01:58

```

Protocol Client Info:

BGP-> Client ID: 44 Flags: 4

Number of Sessions: 2

R3

R3#show ip ospf neighbor

Total number of full neighbors: 1

OSPF process 100 VRF(default):

Neighbor ID	Pri	State	Dead Time	Address	Interface	Instance ID
2.2.2.2	1	Full/DR	00:00:36	20.1.1.1	eth1	0

R3#show bfd session

BFD process for VRF: (DEFAULT VRF)

=====

Sess-Idx	Remote-Disc	Lower-Layer	Sess-Type	Sess-State	UP-Time	Interface	Down-Reason
1	NA	2	IPv4	Single-Hop	Up	00:01:21	
eth1			20.1.1.1/32				
257	NA	1	IPv4	Multi-Hop	Up	00:00:00	
NA			1.1.1.1/32				

Number of Sessions: 2

Total number of Established sessions 2

R3#show bfd session detail

BFD process for VRF: (DEFAULT VRF)

=====

```

Session Interface Index : 10053           Interface name :eth1
Session Index : 1
Lower Layer : IPv4                        Version : 1
Session Type : Single Hop                Session State : Up
Local Discriminator : 1                    Local Address : 20.1.1.2/32
Remote Discriminator : 2                   Remote Address : 20.1.1.1/32
Local Port : 49152                        Remote Port : 3784
Options :

```

Diagnostics : None

BFD Protocol Configurations

Timers in Milliseconds :

Min Tx: 250 Min Rx: 250 Multiplier: 3
Neg Tx: 250 Neg Rx: 250 Neg detect mult: 3
Min echo Tx: 1000 Min echo Rx: 1000 Neg echo intrvl: 0
Storage type : 2
Sess down time : 00:00:00
Sess Down Reason : NA
Bfd GTSM Disabled
Bfd Authentication Disabled

Counters values:

Pkt In : 000000000000000000391 Pkt Out : 000000000000000000391
Pkts Drop : 000000000000000000000 Auth Pkts Drop : 00000000000000000000
Echo Out : 000000000000000000000 IPv6 Echo Out : 00000000000000000000
IPv6 Pkt In : 000000000000000000000 IPv6 Pkt Out : 00000000000000000000
UP Count : 1 UPTIME : 00:01:26

Protocol Client Info:

BGP-> Client ID: 44 Flags: 4

Session Interface Index : 0

Session Index : 257

Lower Layer : IPv4

Version : 1

Session Type : Multihop Arbit Path

Session State : Up

Local Discriminator : 257

Local Address : 3.3.3.3/32

Remote Discriminator : 1

Remote Address : 1.1.1.1/32

Local Port : 49153

Remote Port : 4784

Options :

Diagnostics : None

Timers in Milliseconds :

Min Tx: 250 Min Rx: 250 Multiplier: 3
Neg Tx: 250 Neg Rx: 250 Neg detect mult:250
Min echo Tx: 1000 Min echo Rx: 1000 Neg echo intrvl: 0
Storage type : 2
Sess down time : 00:00:00
Sess Down Reason : NA
Bfd GTSM Disabled
Bfd Authentication Disabled

Counters values:

Pkt In : 000000000000000000000 Pkt Out : 000000000000000000047
Pkts Drop : 000000000000000000000 Auth Pkts Drop : 00000000000000000000
Echo Out : 000000000000000000000 IPv6 Echo Out : 00000000000000000000
IPv6 Pkt In : 000000000000000000000 IPv6 Pkt Out : 00000000000000000000
UP Count : 0 UPTIME : 00:00:00

Protocol Client Info:

BGP-> Client ID: 44 Flags: 4

Number of Sessions: 2

CHAPTER 3 BFD Static Route Configuration

This chapter describes the configurations for BFD static routes.

In order to establish alternate paths to destinations that have the least possible delay it is important to quickly detect any changes to static route validity. BFD detects the liveness of a static route's nexthop and then uses the nexthop's reachability information to determine whether routes are valid. Using BFD to reach a static route's nexthop also ensures that a static route is inserted in the forwarding database only when the nexthop neighbor is reachable.

Topology

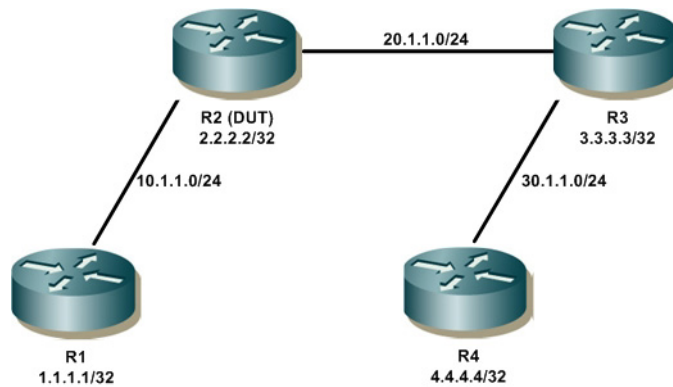

Figure 3-170: BFD Static Route Basic Topology

R1

R1(config)#interface eth2	Enter the Interface configuration mode for eth2.
R1(config-if)#ip address 10.1.1.1/24	Assign IP address on interface.
R1(config-if)#commit	Commit the candidate configuration to the running configuration.
R1(config-if)#exit	Exit the Interface configuration mode.

R2

R2#configure terminal	Enter the Configure mode.
R2(config)#ip route 30.1.1.0/24 20.1.1.3	Configure static route.
R2(config)#ip bfd static all-interfaces	Enable BFD for all static routes.
R2(config)#interface eth1	Enter the Interface configuration mode for eth1.
R2(config-if)#ip static bfd enable	Enable static BFD on the interface.
R2(config-if)#ip address 20.1.1.2/24	Assign IP address on interface.
R2(config-if)#commit	Commit the candidate configuration to the running configuration.
R2(config-if)#exit	Exit the Interface configuration mode.
R2(config)# ip static 30.1.1.0/24 20.1.1.3 fall-over-bfd enable	Enable static BFD at static route level.
R2(config)#interface eth2	Enter the Interface configuration mode for eth2.
R2(config-if)#ip address 10.1.1.2/24	Assign IP address on interface.

BFD Static Route Configuration

R2(config-if)#commit	Commit the candidate configuration to the running configuration.
R2(config-if)#exit	Exit the Interface configuration mode.

R3

R3#configure terminal	Enter the Configure mode.
R3(config)#ip route 10.1.1.0/24 20.1.1.2	Configure static route.
R3(config)#ip bfd static all-interfaces	Enable BFD for all static routes.
R3(config)#interface eth1	Enter the Interface configuration mode for eth1.
R3(config-if)#ip address 20.1.1.3/24	Assign IP address on interface.
R3(config-if)#ip static bfd enable	Enable static BFD at interface level.
R3(config-if)#commit	Commit the candidate configuration to the running configuration.
R3(config-if)#exit	Exit the Interface configuration mode.
R3(config)#ip static 10.1.1.0/24 20.1.1.2 fall-over-bfd enable	Enable static BFD at static route level.
R3(config)#interface eth2	Enter the Interface configuration mode for eth2.
R3(config-if)#ip address 30.1.1.2/24	Assign IP address on interface.
R3(config-if)#commit	Commit the candidate configuration to the running configuration.
R3(config-if)#exit	Exit the Interface configuration mode.

R4

R4(config)#interface eth2	Enter the Interface configuration mode for eth2.
R4(config-if)#ip address 30.1.1.1/24	Assign IP address on interface.
R4(config-if)#commit	Commit the candidate configuration to the running configuration.
R4(config-if)#exit	Exit the Interface configuration mode.

Validation

R2

```
#sh bfd session
Sess-Idx  Remote-Disc  Lower-Layer  Sess-Type  Sess-State  UP-Time  Remote-
Addr
5         1              IPv4         Single-Hop Up           00:09:32
20.1.1.3/32
Number of Sessions: 1
VPC2#sh bfd session detail
=====

Session Interface Index : 3           Session Index : 5
Lower Layer : IPv4              Version : 1
Session Type : Single Hop        Session State : Up
Local Discriminator : 5           Local Address : 20.1.1.2/32
Remote Discriminator : 1          Remote Address : 20.1.1.3/32
```

```

Local Port : 49156                      Remote Port : 3784
Options :

Diagnostics : None

Timers in Milliseconds :
Min Tx: 250                            Min Rx: 250                Multiplier: 3
Neg Tx: 250                            Neg Rx: 2000              Neg detect mult: 3
Min echo Tx: 1000                      Min echo Rx: 1000        Neg echo intrvl: 0
Storage type : 2
Sess down time : 00:00:00
Sess discontinue time : 00:00:00
Bfd GTSM Disabled
Bfd Authentication Disabled

Counters values:
Pkt In : 00000000000000a29             Pkt Out : 00000000000000bb6
Echo Out : 000000000000000000         IPv6 Echo Out : 000000000000000000
IPv6 Pkt In : 000000000000000000      IPv6 Pkt Out : 000000000000000000
UP Count : 1                           UPTIME : 00:09:34

Protocol Client Info:
RIB-> Client ID: 42                    Flags: 4
-----
Number of Sessions: 1

```

R3

```

#sh bfd session
Sess-Idx  Remote-Disc  Lower-Layer  Sess-Type  Sess-State  UP-Time  Remote-
Addr
1         5                IPv4        Single-Hop  Up          00:09:39
20.1.1.2/32
Number of Sessions: 1
VPC3#sh bfd session detail
=====

Session Interface Index : 3                Session Index : 1
Lower Layer : IPv4                        Version : 1
Session Type : Single Hop                  Session State : Up
Local Discriminator : 1                    Local Address : 20.1.1.3/32
Remote Discriminator : 5                   Remote Address : 20.1.1.2/32
Local Port : 49152                         Remote Port : 3784
Options :

Diagnostics : None

Timers in Milliseconds :
Min Tx: 250                            Min Rx: 250                Multiplier: 3
Neg Tx: 250                            Neg Rx: 250                Neg detect mult: 3
Min echo Tx: 1000                      Min echo Rx: 1000        Neg echo intrvl: 0
Storage type : 2
Sess down time : 00:00:00
Sess discontinue time : 00:00:00
Bfd GTSM Disabled
Bfd Authentication Disabled

Counters values:

```

BFD Static Route Configuration

```
Pkt In : 00000000000000a59          Pkt Out : 00000000000000a53
Echo Out : 0000000000000000          IPv6 Echo Out : 0000000000000000
IPv6 Pkt In : 00000000000000000000  IPv6 Pkt Out : 000000000000000000
UP Count : 1                          UPTIME : 00:09:41
```

Protocol Client Info:

```
RIB-> Client ID: 42          Flags: 4
```

```
-----
Number of Sessions:      1
```

CHAPTER 4 BFD Authentication

This chapter provides BFD authentication configuration examples.

Overview

Bidirectional Forwarding Detection (BFD) is a protocol intended to detect faults in the bidirectional path between two forwarding engines, including physical interfaces, sub-interfaces, and data link. It operates independently of media, data protocols, and routing protocols. A session will be created between links. When BFD links is hacked, the link may be falsely declared to be down, or falsely declared to be up. To overcome this type of situations, need to use authentication on BFD. Using this we can mitigate threats from attackers.

OcNOS supports the following authentication types:

- Simple password
- Meticulous-Keyed-SHA1
- Keyed-SHA1

Among these types, Meticulous-Keyed-SHA1 is the strongest one.

Authentication is optionally enabled on BFD sessions. By default, it is disabled and is configurable via CLI. When authentication is enabled, BFD packets will exchange with authentication section (based on the configured auth type). Receiving system will examine the authentication section of the packet; if it is successful then it will accept. Otherwise, it will discard.

Enabling BFD Authentication for Multihop for IPv4, Using Key-ID

In this example, the BFD Multihop session is configured between R1 and R3 using single key (using key-ID). Once the BFD session is up, the authentication is enabled on both the routers, with the authentication type as Keyed-SHA1. We can enable the authentication on BFD session using any one of the above mentioned authentication type, with the Identical authentication type on both side.

Note: BFD authentication is not supported for Single hop BFD session.

Topology



Figure 4-171: Basic Topology of Three Routers

Router 1 (R1)

R1#configure terminal	Enter the Configure mode.
R1(config)#interface lo	Enter the Loopback Interface configuration mode.
R1(config-if)#ip address 1.1.1.1/32 secondary	Assign IP address for interface
R1(config-if)#commit	Commit the candidate configuration to the running configuration.

BFD Authentication

R1(config-if)#exit	Exit from interface mode.
R1(config)#interface xe9	Enter Interface Mode.
R1(config-if)#ip address 10.1.1.1/24	Assign IP address for interface
R1(config-if)#bfd session 10.1.1.1 20.1.1.2 multihop	Enabling BFD Multihop session
R1(config-if)#commit	Commit the candidate configuration to the running configuration.
R1(config-if)#exit	Exit from interface mode.
R1(config)#router ospf 1	Enter router OSPF mode
R1(config-router)#redistribute connected	
R1(config-router)#network 10.1.1.0/24 area 0	Advertise the network to area 0
R1(config-if)#commit	Commit the candidate configuration to the running configuration.
R1(config-router)#exit	Exit router OSPF mode
R1(config)#bfd multihop-peer 20.1.1.2 auth type keyed-shal key-id 2 0 key ocnos	Enabling Authentication for Multihop session

Router 2 (R2)

R2#configure terminal	Enter the Configure mode.
R2(config)#interface lo	Enter the Loopback Interface configuration mode.
R2(config-if)#ip address 2.2.2.2/32 secondary	Assign IP address for interface
R2(config-if)#commit	Commit the candidate configuration to the running configuration.
R2(config-if)#exit	Exit from interface mode.
R2(config)#interface xe9	Enter Interface Mode.
R2(config-if)#ip address 10.1.1.2/24	Assign IP address for interface
R2(config-if)#exit	Exit from interface mode.
R2(config)#interface xe2	Enter Interface Mode.
R2(config-if)#ip address 20.1.1.1/24	Assign IP address for interface
R2(config-if)#commit	Commit the candidate configuration to the running configuration.
R2(config-if)#exit	Exit from interface mode.
R2(config)#router ospf 1	Enter router OSPF mode
R2(config-router)#redistribute connected	
R2(config-router)#network 10.1.1.0/24 area 0	Advertise the network to area 0
R2(config-router)#network 20.1.1.0/24 area 0	Advertise the network to area 0
R2(config-router)#commit	Commit the candidate configuration to the running configuration.
R2(config-router)#exit	Exit router OSPF mode

Router 3 (R3)

R3#configure terminal	Enter the Configure mode.
R3(config)#interface lo	Enter the Loopback Interface configuration mode.

R3(config-if)#ip address 3.3.3.3/32 secondary	Assign IP address for interface
R3(config-if)#commit	Commit the candidate configuration to the running configuration.
R3(config-if)#exit	Exit from interface mode.
R3(config)#interface xe2	Enter Interface Mode.
R3(config-if)#ip address 20.1.1.2/24	Assign IP address for interface
R3(config-if)#bfd session 20.1.1.2 10.1.1.1 multihop	Enabling BFD Multihop session
R3(config-if)#commit	Commit the candidate configuration to the running configuration.
R3(config-if)#exit	Exit from interface mode.
R3(config)#router ospf 1	Enter router OSPF mode
R3(config-router)#redistribute connected	
R3(config-router)#network 20.1.1.0/24 area 0	Advertise the network to area 0
R3(config-router)#exit	Exit router OSPF mode
R3(config)#bfd multihop-peer 10.1.1.1 auth type keyed-sha1 key-id 2 0 key ocnos	Enabling Authentication for Multihop session
R3(config)#commit	Commit the candidate configuration to the running configuration.

Validation

Check Multihop session is up between R1 and R3 with authentication type configured.

```
R1#show ip ospf neighbor
```

```
Total number of full neighbors: 1
OSPF process 1 VRF(default):
Neighbor ID    Pri   State           Dead Time   Address        Interface
Instance ID
2.2.2.2        1    Full/DR         00:00:33   10.1.1.2       xe9
0
```

```
R1#sh bfd session
```

```
BFD process for VRF: (DEFAULT VRF)
```

```
=====
Sess-Idx  Remote-Disc  Lower-Layer  Sess-Type  Sess-State  UP-Time
Interface Down-Reason  Remote-Addr
1001      1001         IPv4         Multi-Hop  Up          00:34:32  NA
NA        20.1.1.2/32
Number of Sessions: 1
```

```
R1#sh bfd session detail
```

```
BFD process for VRF: (DEFAULT VRF)
```

```
=====
Session Interface Index : 0           Session Index : 1001
Lower Layer : IPv4                 Version : 1
Session Type : Multihop Arbit Path  Session State : Up
Local Discriminator : 1001          Local Address : 10.1.1.1/32
```

BFD Authentication

Remote Discriminator : 1001 Remote Address : 20.1.1.2/32
Local Port : 49152 Remote Port : 4784
Options :

Diagnostics : None

Timers in Milliseconds :
Min Tx: 250 Min Rx: 250 Multiplier: 3
Neg Tx: 250 Neg Rx: 250 Neg detect mult: 3
Min echo Tx: 1000 Min echo Rx: 1000 Neg echo intrvl: 0
Storage type : 2
Sess down time : 00:00:00
Sess Down Reason : NA
Bfd GTSM Disabled
Bfd Authentication Enabled
Authentication type : keyed-shal
Authentication Key-id : 2

Counters values:
Pkt In : 00000000000000027907 Pkt Out : 0000000000000028347
Pkts Drop : 00000000000000000000 Auth Pkts Drop :
00000000000000000000
Echo Out : 00000000000000000000 IPv6 Echo Out :
00000000000000000000
IPv6 Pkt In : 00000000000000000000 IPv6 Pkt Out : 00000000000000000000
UP Count : 12 UPTIME : 00:34:34

Protocol Client Info:
BFD-> Client ID: 28 Flags: 4

Number of Sessions: 1

R3#show ip ospf neighbor

Total number of full neighbors: 1
OSPF process 1 VRF(default):
Neighbor ID Pri State Dead Time Address Interface
Instance ID
2.2.2.2 1 Full/Backup 00:00:32 20.1.1.1 xe2
0

R3#sh bfd session

BFD process for VRF: (DEFAULT VRF)

=====
=====
Sess-Idx Remote-Disc Lower-Layer Sess-Type Sess-State UP-Time
Interface Down-Reason Remote-Addr
1001 1001 IPv4 Multi-Hop Up 00:36:27 NA
NA 10.1.1.1/32
Number of Sessions: 1

R3#sh bfd session detail

BFD process for VRF: (DEFAULT VRF)

=====
=====

Session Interface Index : 0 Session Index : 1001

Lower Layer : IPv4
Session Type : Multihop Arbit Path
Local Discriminator : 1001
Remote Discriminator : 1001
Local Port : 49152
Options :

Version : 1
Session State : Up
Local Address : 20.1.1.2/32
Remote Address : 10.1.1.1/32
Remote Port : 4784

Diagnostics : None

Timers in Milliseconds :

Min Tx: 250 Min Rx: 250 Multiplier: 3
Neg Tx: 250 Neg Rx: 250 Neg detect mult: 3
Min echo Tx: 1000 Min echo Rx: 1000 Neg echo intrvl: 0
Storage type : 2
Sess down time : 00:00:00
Sess Down Reason : NA
Bfd GTSM Disabled
Bfd Authentication Enabled
Authentication type : keyed-sha1
Authentication Key-id : 2

Counters values:

Pkt In : 000000000000000028428 Pkt Out : 000000000000000028715
Pkts Drop : 00000000000000000000 Auth Pkts Drop :
00000000000000000000
Echo Out : 00000000000000000000 IPv6 Echo Out :
00000000000000000000
IPv6 Pkt In : 00000000000000000000 IPv6 Pkt Out : 00000000000000000000
UP Count : 12 UPTIME : 00:36:29

Protocol Client Info:

BFD-> Client ID: 28 Flags: 4

Number of Sessions: 1

CHAPTER 5 BFD with VRF Configuration

This chapter shows using BFD with user defined VRF for OSPFv2 and OSPFv3.

Topology

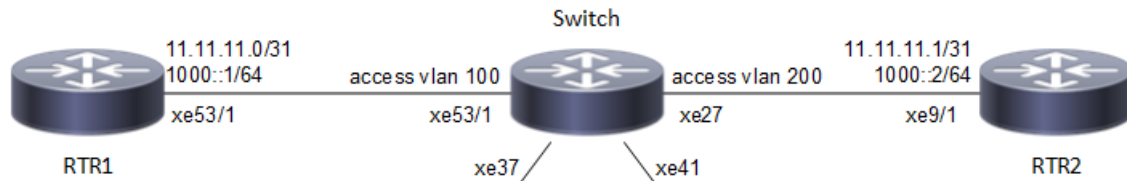

Figure 5-172: BFD user-defined VRF

RTR1

#configure terminal	Enter configure mode.
(config)#ip vrf vrf10	Create VRF instance with VRF10 and enter into VRF mode
(config-vrf)#exit	Exit from VRF mode
(config)#commit	Commit the candidate configuration to the running configuration.
(config)#interface xe53/1	Enter interface mode
(config-if)#ip vrf forwarding vrf10	Enable VRF forwarding on interface
(config-if)#ip address 11.11.11.0/31	Assign IPv4 address in /31 mask.
(config-if)#ipv6 address 1000::1/64	Assign IPv6 address in /64 mask.
(config-if)#ipv6 router ospf area 0 tag vrf10	Tag OSPFv3 instance on interface with VRF10 for area 0
(config-if)#exit	Exit interface mode.
(config)#commit	Commit the candidate configuration to the running configuration.
(config)#router ospf 65535 vrf10	Enter into OSPF VRF configuration mode
(config-router)#router-id 1.1.1.1	Assign router ID 1.1.1.1 for OSPF process 65535
(config-router)#bfd all-interfaces	Enable BFD for all-interface into OSPF
(config-router)#network 11.11.11.0/31 area 0	Enable routing for network 11.11.11.0/31 in area 0
(config-router)#exit	Exit from OSPF VRF configuration mode
(config)#commit	Commit the candidate configuration to the running configuration.
(config)#router ipv6 vrf ospf vrf10	Enter into IPv6 OSPF VRF configuration mode
(config-router)#router-id 2.2.2.2	Assign router-id 2.2.2.2 for IPv6 OSPF process
(config-router)#bfd all-interfaces	Enable BFD for all-interface into OSPF
(config-router)#exit	Exit from IPv6 OSPF VRF configuration mode
(config)#commit	Commit the candidate configuration to the running configuration.

Switch

#configure terminal	Enter configure mode.
(config)#bridge 32 protocol rstp vlan-bridge	Create a RSTP VLAN aware bridge with bridge-id 32
(config)#vlan 100 bridge 32	Create VLAN 100 and map it to bridge 32
(config)#vlan 200 bridge 32	Create VLAN 200 and map it to bridge 32
(config)#interface xe53/1	Enter interface mode
(config-if)#switchport	Make it port as L2 interface
(config-if)#bridge-group 32	Configure bridge group to l2 interface
(config-if)#switchport mode trunk	Set the layer 2 interface as trunk interface
(config-if)#switchport trunk allowed vlan all	Allow all VLAN to trunk interface
(config-if)#exit	Exit interface mode.
(config)#commit	Commit the candidate configuration to the running configuration.
(config)#interface xe27	Enter interface mode
(config-if)#switchport	Make it port as L2 interface
(config-if)#bridge-group 32	Configure bridge group to l2 interface
(config-if)#switchport mode trunk	Set the layer 2 interface as trunk interface
(config-if)#switchport trunk allowed vlan all	Allow all VLAN to trunk interface
(config-if)#exit	Exit interface mode.
(config)#interface xe37	Enter interface mode
(config-if)#switchport	Make it port as L2 interface
(config-if)#bridge-group 32	Configure bridge group to l2 interface
(config-if)#switchport mode trunk	Set the layer 2 interface as trunk interface
(config-if)#switchport trunk allowed vlan all	Allow all VLAN to trunk interface
(config-if)#exit	Exit interface mode.
(config)#commit	Commit the candidate configuration to the running configuration.
(config)#interface xe41	Enter interface mode
(config-if)#switchport	Make it port as L2 interface
(config-if)# bridge-group 32 spanning-tree disable	Configure bridge group to l2 interface with spanning-tree disable
(config-if)#switchport mode trunk	Allow all VLAN to trunk interface
(config-if)#switchport trunk allowed vlan all	Map the VLAN 200 to access interface
(config-if)#exit	Exit interface mode.
(config)#commit	Commit the candidate configuration to the running configuration.

RTR2

#configure terminal	Enter configure mode.
(config)#ip vrf vrf10	Create VRF instance with VRF10 and enter into vrf mode
(config-vrf)#exit	Exit from VRF mode
(config)#commit	Commit the candidate configuration to the running configuration.
(config)#interface xe9/1	Enter interface mode
(config-if)#ip vrf forwarding vrf10	Enable VRF forwarding on interface
(config-if)#ip address 11.11.11.1/31	Assign IPv4 address in /31 mask.
(config-if)#ipv6 address 1000::2/64	Assign IPv6 address in /64 mask.
(config-if)#ipv6 router ospf area 0 tag vrf10	Tag OSPFv3 instance on interface with VRF10 for area 0
(config-if)#exit	Exit interface mode.
(config)#commit	Commit the candidate configuration to the running configuration.
(config)#router ospf 65535 vrf10	Enter into OSPF VRF configuration mode
(config-router)#router-id 3.3.3.3	Assign router ID 3.3.3.3 for OSPF process 65535
(config-router)#bfd all-interfaces	Enable BFD for all-interface into OSPF
(config-router)#network 11.11.11.0/31 area 0	Enable routing for network 11.11.11.0/31 in area 0
(config-router)#exit	Exit from OSPF VRF configuration mode
(config)#commit	Commit the candidate configuration to the running configuration.
(config)#router ipv6 vrf ospf vrf10	Enter into IPv6 OSPF VRF configuration mode
(config-router)#router-id 4.4.4.4	Assign router-id 4.4.4.4 for IPv6 OSPF process
(config-router)#bfd all-interfaces	Enable BFD for all-interface into OSPF
(config-router)#exit	Exit from IPv6 OSPF VRF configuration mode
(config)#commit	Commit the candidate configuration to the running configuration.

Validation**RTR1**

```
#show ip ospf neighbor
```

```
Total number of full neighbors: 1
```

```
OSPF process 65535 VRF(vrf10):
```

Neighbor ID Instance ID	Pri	State	Dead Time	Address	Interface
3.3.3.3 0	1	Full/Backup	00:00:32	11.11.11.1	xe15

```
#sh bfd session vrf vrf10
```

```
BFD process for VRF: vrf10
```

```
=====
```

```

Sess-Idx  Remote-Disc Lower-Layer Sess-Type  Sess-State  UP-Time
Interface Down-Reason Remote-Addr
256      256        IPv6        Single-Hop Up           00:26:26  xe15
NA       fe80::eac5:7aff:fe64:4ald/128
1        1          IPv4        Single-Hop Up           00:19:05  xe15
NA       11.11.11.1/32
Number of Sessions: 2

```

```
#sh bfd session vrf vrf10 detail
```

```
BFD process for VRF: vrf10
```

```
=====
```

```

Session Interface Index : 10016          Interface name :xe15
Session Index : 256
Lower Layer : IPv6                      Version : 1
Session Type : Single Hop                Session State : Up
Local Discriminator : 256                 Local Address :
fe80::eac5:7aff:fe78:711d/128
Remote Discriminator : 256                Remote Address :
fe80::eac5:7aff:fe64:4ald/128
Local Port : 49153                        Remote Port : 3784
Options :

```

```
Diagnostics : None
```

```
Timers in Milliseconds :
```

```

Min Tx: 250           Min Rx: 250           Multiplier: 3
Neg Tx: 250           Neg Rx: 250           Neg detect mult: 3
Min echo Tx: 1000    Min echo Rx: 1000    Neg echo intrvl: 0
Storage type : 2
Sess down time : 00:00:00
Sess Down Reason : NA
Bfd GTSM Disabled
Bfd Authentication Disabled

```

```
Counters values:
```

```

Pkt In : n/a          Pkt Out : n/a
Pkts Drop : 000000000000000000000000 Auth Pkts Drop :
000000000000000000000000
Echo Out : 000000000000000000000000 IPv6 Echo Out :
000000000000000000000000
IPv6 Pkt In : 00000000000000000007256 IPv6 Pkt Out : 00000000000000000007256
UP Count : 1          UPTIME : 00:26:28

```

```
Protocol Client Info:
```

```
OSPF6-> Client ID: 5  Flags: 4
```

```
-----
```

```

Session Interface Index : 10016          Interface name :xe15
Session Index : 1
Lower Layer : IPv4                      Version : 1
Session Type : Single Hop                Session State : Up
Local Discriminator : 1                   Local Address : 11.11.11.0/32
Remote Discriminator : 1                  Remote Address : 11.11.11.1/32
Local Port : 49154                        Remote Port : 3784
Options :

```

Diagnostics : None

Timers in Milliseconds :

Min Tx: 250	Min Rx: 250	Multiplier: 3
Neg Tx: 250	Neg Rx: 250	Neg detect mult: 3
Min echo Tx: 1000	Min echo Rx: 1000	Neg echo intrvl: 0

Storage type : 2
Sess down time : 00:00:00
Sess Down Reason : NA
Bfd GTSM Disabled
Bfd Authentication Disabled

Counters values:

Pkt In : n/a	Pkt Out : n/a
Pkts Drop : 00000000000000000000	Auth Pkts Drop :
Echo Out : 00000000000000000000	IPv6 Echo Out :
IPv6 Pkt In : 00000000000000000000	IPv6 Pkt Out : 00000000000000000000
UP Count : 1	UPTIME : 00:19:07

Protocol Client Info:

OSPF-> Client ID: 4 Flags: 4

Number of Sessions: 2

RTR3

#sh ip ospf neighbor

Total number of full neighbors: 1

OSPF process 65535 VRF(vrf10):

Neighbor ID	Pri	State	Dead Time	Address	Interface
Instance ID					
1.1.1.1	1	Full/DR	00:00:31	11.11.11.0	xe10
0					

#sh ipv6 ospf neighbor

Total number of full neighbors: 1

OSPFv3 Process (vrf10)

Neighbor ID	Pri	State	Dead Time	Interface	Instance ID
2.2.2.2	1	Full/DR	00:00:28	xe10	0

#sh bfd session vrf vrf10

BFD process for VRF: vrf10

```
=====
```

Sess-Idx	Remote-Disc	Lower-Layer	Sess-Type	Sess-State	UP-Time
Interface	Down-Reason	Remote-Addr			
1	1	IPv4	Single-Hop	Up	00:20:44 xe10
NA	11.11.11.0/32				
256	256	IPv6	Single-Hop	Up	00:28:05 xe10
NA	fe80::eac5:7aff:fe78:711d/128				

Number of Sessions: 2

#sh bfd session vrf vrf10 detail

BFD process for VRF: vrf10

=====

Session Interface Index : 10011 Interface name :xe10
Session Index : 1
Lower Layer : IPv4 Version : 1
Session Type : Single Hop Session State : Up
Local Discriminator : 1 Local Address : 11.11.11.1/32
Remote Discriminator : 1 Remote Address : 11.11.11.0/32
Local Port : 49152 Remote Port : 3784
Options :

Diagnostics : None

Timers in Milliseconds :

Min Tx: 250 Min Rx: 250 Multiplier: 3
Neg Tx: 250 Neg Rx: 250 Neg detect mult: 3
Min echo Tx: 1000 Min echo Rx: 1000 Neg echo intrvl: 0
Storage type : 2
Sess down time : 00:00:00
Sess Down Reason : NA
Bfd GTSM Disabled
Bfd Authentication Disabled

Counters values:

Pkt In : n/a Pkt Out : n/a
Pkts Drop : 00000000000000000000000000000000 Auth Pkts Drop :
00000000000000000000000000000000
Echo Out : 00000000000000000000000000000000 IPv6 Echo Out :
00000000000000000000000000000000
IPv6 Pkt In : 00000000000000000000000000000000 IPv6 Pkt Out : 00000000000000000000000000000000
UP Count : 2 UPTIME : 00:20:46

Protocol Client Info:

OSPF-> Client ID: 4 Flags: 4

Session Interface Index : 10011 Interface name :xe10
Session Index : 256
Lower Layer : IPv6 Version : 1
Session Type : Single Hop Session State : Up
Local Discriminator : 256 Local Address :
fe80::eac5:7aff:fe64:4ald/128
Remote Discriminator : 256 Remote Address :
fe80::eac5:7aff:fe78:711d/128
Local Port : 49153 Remote Port : 3784
Options :

Diagnostics : None

Timers in Milliseconds :

Min Tx: 250 Min Rx: 250 Multiplier: 3
Neg Tx: 250 Neg Rx: 250 Neg detect mult: 3
Min echo Tx: 1000 Min echo Rx: 1000 Neg echo intrvl: 0
Storage type : 2
Sess down time : 00:00:00

Sess Down Reason : NA
Bfd GTSM Disabled
Bfd Authentication Disabled

Counters values:

Pkt In : n/a	Pkt Out : n/a
Pkts Drop : 00000000000000000000	Auth Pkts Drop :
00000000000000000000	
Echo Out : 00000000000000000000	IPv6 Echo Out :
00000000000000000000	
IPv6 Pkt In : 00000000000000007707	IPv6 Pkt Out : 00000000000000007718
UP Count : 1	UPTIME : 00:28:07

Protocol Client Info:

OSPF6-> Client ID: 5 Flags: 4

Number of Sessions: 2

BFD Over Static Routing IPv4 and IPv6

RTR1

#configure terminal	Enter configure mode.
(config)#ip vrf vrf10	Create VRF instance with VRF10 and enter into VRF mode
(config-vrf)#exit	Exit from VRF mode
(config)#commit	Commit the candidate configuration to the running configuration.
(config)#ip bfd vrf vrf10 static all-interfaces	Enable global IPv4 BFD config for user defined VRF interfaces
(config)#ipv6 bfd vrf vrf10 static all-interfaces	Enable global IPv6 BFD config for user defined VRF interfaces
(config)#interface xe53/1	Enter interface mode
(config-if)#ip vrf forwarding vrf10	Enable VRF forwarding on interface
(config-if)#ip address 11.11.11.0/31	Assign IPv4 address in /31 mask.
(config-if)#ipv6 address 1000::1/64	Assign IPv6 address in /64 mask.
(config-if)#exit	Exit interface mode.
(config)#commit	Commit the candidate configuration to the running configuration.
(config)#ip route vrf vrf10 200.200.200.200/32 11.11.11.1 xe53/1	Create IPv4 VRF static route for static BFD session
(config)#ipv6 route vrf vrf10 2000::/64 1000::2 xe53/1	Create IPv6 VRF static route for static BFD session
(config)#exit	Exit from configuration mode
(config)#commit	Commit the candidate configuration to the running configuration.

RTR2

#configure terminal	Enter configure mode.
(config)#ip vrf vrf10	Create VRF instance with VRF10 and enter into VRF mode
(config-vrf)#exit	Exit from VRF mode
(config)#commit	Commit the candidate configuration to the running configuration.
(config)#ip bfd vrf vrf10 static all-interfaces	Enable global IPv4 BFD config for user defined VRF interfaces
(config)#ipv6 bfd vrf vrf10 static all-interfaces	Enable global IPv6 BFD config for user defined VRF interfaces
(config)#interface xe9/1	Enter interface mode for xe9/1
(config-if)#ip vrf forwarding vrf10	Enable VRF forwarding on interface
(config-if)#ip address 11.11.11.1/31	Assign IPv4 address in /31 mask.
(config-if)#ipv6 address 1000::2/64	Assign IPv6 address in /64 mask.
(config-if)#exit	Exit interface mode.

(config)#commit	Commit the candidate configuration to the running configuration.
(config)# ip route vrf vrf10 100.100.100.100/32 11.11.11.0 xe9/1	Create IPv4 VRF static route for static BFD session
(config)# ipv6 route vrf vrf10 3000::2/64 1000::1 xe9/1	Create IPv6 VRF static route for static BFD session
(config)#commit	Commit the candidate configuration to the running configuration.
(config)#exit	Exit from configuration mode

Validation

RTR1

```
#show bfd session vrf vrf10
  BFD process for VRF: vrf10
=====
Sess-Idx Remote-Disc Lower-Layer Sess-Type Sess-State UP-Time Inter-
face Down-Reason Remote-Addr
3
00:14:13 xe53/ 1 4 NA IPv4 11.11.11.1/32 Single-Hop Up
4
00:13:24 xe53/ 1 5 NA IPv6 1000::2/128 Single-Hop Up
Number of Sessions: 2
```

```
R1#show bfd session vrf vrf10 detail
BFD process for VRF: vrf10
=====
Session Interface Index : 4           Interface name :xe53/1
Session Index : 1
Lower Layer : IPv4                     Version : 1
Session Type : Single Hop              Session State : Up
Local Discriminator : 1                 Local Address : 11.11.11.0/32
Remote Discriminator : 1                Remote Address : 11.11.11.1/32
Local Port : 49152                      Remote Port : 3784
Options :

Diagnostics : None

Timers in Milliseconds :
Min Tx: 250                            Min Rx: 250           Multiplier: 3
Neg Tx: 250                            Neg Rx: 250           Neg detect
mult: 3
Min echo Tx: 1000                      Min echo Rx: 1000    Neg echo intrvl: 0
Storage type : 2
Sess down time : 00:00:00
Sess Down Reason : NA
Bfd GTSM Disabled
Bfd Authentication Disabled

Counters values:
```

BFD with VRF Configuration

```
Pkt In : 00000000000000001184          Pkt Out :
00000000000000001184
Echo Out : 00000000000000000000          IPv6 Echo Out :
00000000000000000000
IPv6 Pkt In : 00000000000000000000        IPv6 Pkt Out :
00000000000000000000
UP Count : 1                               UPTIME :
00:00:21
```

```
Protocol Client Info:
OSPF-> Client ID: 4          Flags: 4
-----
```

```
Session Interface Index : 4          Interface name :xe53/1
Session Index : 2
Lower Layer : IPv6                   Version : 1
Session Type : Single Hop           Session State : Up
Local Discriminator : 2              Local Address :
fe80::5054:ff:fed0:e0c1/128
Remote Discriminator : 2            Remote Address :
fe80::5054:ff:fe3d:af2b/128
Local Port : 49153                  Remote Port : 3784
Options :
```

Diagnostics : None

```
Timers in Milliseconds :
Min Tx: 250                          Min Rx: 250          Multiplier: 3
Neg Tx: 250                          Neg Rx: 250          Neg detect
mult: 3
Min echo Tx: 1000                    Min echo Rx: 1000   Neg echo intrvl: 0
Storage type : 2
Sess down time : 00:00:00
Sess Down Reason : NA
Bfd GTSM Disabled
Bfd Authentication Disabled
```

```
Counters values:
Pkt In : 00000000000000000000          Pkt Out :
00000000000000000000
Echo Out : 00000000000000000000        IPv6 Echo Out :
00000000000000000000
IPv6 Pkt In : 00000000000000001158      IPv6 Pkt Out :
00000000000000001163
UP Count : 1                            UPTIME : 00:00:14
```

```
Protocol Client Info:
OSPF6-> Client ID: 5          Flags: 4
-----
```

Number of Sessions: 2

```
R1#show bfd
BFD ID: 00          Start Time:Tue Mar 19 13:31:08 2019
  BFD Admin State: UP
Number of Sessions: 2
Slow Timer: 2000          Image type: MONOLITHIC
```

Echo Mode: Disabled BFD Notifications disabled
 Next Session Discriminator: 3

RTR2

```
#show bfd session vrf vrf10
BFD process for VRF: vrf10
```

```
=====
Sess-Idx  Remote-Disc  Lower-Layer  Sess-Type  Sess-State  UP-Time
Interface Down-Reason Remote-Addr
4         3           xe9/1       NA         IPv4        Single-Hop
Up        00:15:39    11.11.11.0/32
5         4           xe9/1       NA         IPv6        Single-Hop
Up        00:14:50    1000::1/128
Number of Sessions:        2
```

```
R2#show bfd session vrf vrf10 detail
BFD process for VRF: vrf10
```

```
=====
Session Interface Index : 3                      Interface name :xe9/1
Session Index : 1
Lower Layer : IPv4                              Version : 1
Session Type : Single Hop                      Session State : Up
Local Discriminator : 1                         Local Address : 11.11.11.1/32
Remote Discriminator : 1                        Remote Address : 11.11.11.0/32
Local Port : 49152                             Remote Port : 3784
Options :
```

Diagnostics : None

Timers in Milliseconds :

```
Min Tx: 250                                      Min Rx: 250                                      Multiplier: 3
Neg Tx: 250                                      Neg Rx: 250                                      Neg detect
mult: 3
```

```
Min echo Tx: 1000                              Min echo Rx: 1000                              Neg echo intrvl: 0
```

Storage type : 2

Sess down time : 00:00:00

Sess Down Reason : NA

Bfd GTSM Disabled

Bfd Authentication Disabled

Counters values:

```
Pkt In : 00000000000000000001661                      Pkt Out : 00000000000000000001665
Echo Out : 00000000000000000000000000000000                      IPv6 Echo Out :
00000000000000000000000000000000
IPv6 Pkt In : 00000000000000000000000000000000                      IPv6 Pkt Out : 00000000000000000000000000000000
UP Count : 1                                                              UPTIME :
00:00:53
```

Protocol Client Info:

```
OSPF-> Client ID: 4                      Flags: 4
```

```
-----
Session Interface Index : 3
```

```
Interface name :xe9/1
```

BFD with VRF Configuration

```
Session Index : 2
Lower Layer : IPv6
Session Type : Single Hop
Local Discriminator : 2
fe80::5054:ff:fe3d:af2b/128
Remote Discriminator : 2
fe80::5054:ff:fed0:e0c1/128
Local Port : 49153
Options :

Diagnostics : None

Timers in Milliseconds :
Min Tx: 250           Min Rx: 250           Multiplier: 3
Neg Tx: 250          Neg Rx: 250           Neg detect
mult: 3
Min echo Tx: 1000     Min echo Rx: 1000     Neg echo intrvl: 0
Storage type : 2
Sess down time : 00:00:00
Sess Down Reason : NA
Bfd GTSM Disabled
Bfd Authentication Disabled

Counters values:
Pkt In : 00000000000000000000000000000000           Pkt Out : 00000000000000000000000000000000
Echo Out : 00000000000000000000000000000000         IPv6 Echo Out :
00000000000000000000000000000000
IPv6 Pkt In : 000000000000000000000000000000001642   IPv6 Pkt Out : 000000000000000000000000000000001636
UP Count : 1                                           UPTIME :
00:00:56

Protocol Client Info:
OSPF6-> Client ID: 5      Flags: 4
-----
Number of Sessions:      2
```

Bidirectional Forwarding Detection Command Reference

CHAPTER 1 Bidirectional Forwarding Commands

This chapter explains the commands used to configure Bidirectional Forwarding (BFD):

- `accept-lifetime`
- `bfd auth type`
- `bfd`
- `bfd echo`
- `bfd echo interval`
- `bfd echo ipv4 source`
- `bfd interval`
- `bfd multihop-peer`
- `bfd multihop-peer A.B.C.D interval`
- `bfd multihop-peer X:X::X:X interval`
- `bfd notification`
- `bfd session`
- `bfd slow-timer`
- `debug bfd`
- `hardware-profile micro-bfd`
- `hardware-profile seamless-bfd`
- `key-id`
- `key chain`
- `key-string`
- `key-string encrypted`
- `send-lifetime`
- `show bfd`
- `show bfd interface`
- `show bfd session`
- `show bfd session A.B.C.D`
- `show bfd session ipv6`
- `show debugging bfd`
- `snmp restart bfd`

accept-lifetime

Use this command to specify the time period during which the authentication on a key chain is received as valid.

Use the `no` parameter with this command to negate this command.

Command Syntax

```
accept-lifetime HH:MM:SS MONTH <01-31> <1993-2035> HH:MM:SS MONTH <01-31> <1993-2035>
accept-lifetime HH:MM:SS MONTH <01-31> <1993-2035> infinite
accept-lifetime HH:MM:SS MONTH <01-31> <1993-2035> duration <1-2147483646>
no accept-lifetime
```

Parameters

HH:MM:SS	Specify the start time of accept-lifetime in hours, minutes and seconds.
<01-31>	Specify the day of the month to start. If the day is a single-digit, the leading 0 must be added, example: 01, 02, 03, etc.
MONTH	Specify the month of the year to start as the first three letters of the month with first letter in upper case, for example, Jan. (case sensitive).
<1993-2035>	Specify the year to start.
HH:MM:SS	Specify the end time of accept-lifetime in hours, minutes and seconds.
<01-31>	Specify the day of the month to end. If the day is a single-digit, the leading 0 must be added, example: 01, 02, 03, etc.
MONTH	Specify the month of the year to end as the first three letters of the month with first letter in caps, for example, Jan. (case sensitive).
<1993-2035>	Specify the year to end.
duration	Indicate the duration parameter.
<1-2147483646>	Specify the actual end time duration of a key in seconds.
infinite	Specify the end time to never expire.

Default

By default, accept-lifetime command is disabled

Command Mode

Keychain-key mode

Applicability

This command was introduced before OcNOS version 1.3.

Examples

The following example shows the setting of accept-lifetime for key1 on the key chain named mychain.

```
#configure terminal
(config)#key chain mychain
```



```
(config-keychain)#key-id 1  
(config-keychain-key)#accept-lifetime 03:03:01 Dec 03 2004 04:04:02 Oct 06  
2006
```

bfd auth type

Use this command to enable BFD authentication on an interface that has either an IPv4 or an IPv6 BFD session.

Use the `no` form of the command to disable BFD authentication.

Note: BFD authentication is not supported for single hop IPv4 sessions.

Command Syntax

```
bfd auth type (keyed-md5 | keyed-sha1 | meticulous-keyed-md5 | meticulous-keyed-  
  sha1 | simple) key-id <0-255> <0|1> key (WORD)  
no bfd auth
```

Parameters

<code>auth type</code>	Specify an authentication type.
<code>keyed-md5</code>	Specify a keyed message digest authentication type.
<code>simple</code>	Specify a simple authentication type.
<code>keyed-sha1</code>	Specify a keyed secure hashing algorithm authentication type.
<code>meticulous-keyed-md5</code>	Specify an authentication key meticulous keyed message digest authentication.
<code>meticulous-keyed-sha1</code>	Specify an authentication key meticulous keyed secure hashing algorithm authentication.
<code>key-id</code>	Indicate the <code>key-id</code> keyword.
<code><0-255></code>	Specify the key ID value.
<code><0 1></code>	0 Unencrypted password (key) 1 Encrypted password (key)
<code>key</code>	Indicate the <code>key</code> keyword.
<code>WORD</code>	Specify the authentication key name. Whitespaces is not allowed in key.

Command Mode

Interface mode

Applicability

This command was introduced before OcNOS version 1.3.

Example

Do the following to configure a single-key support:

Use value 0 before the key parameter for plain text key.

Use value 1 before the key parameter for already encrypted key.

```
(config)#interface eth1  
(config-if)#bfd auth type keyed-md5 key-id 10 0 key test-key  
(config-if)#bfd auth type keyed-sha1 key-id 20 1 key 0x4d8ea8d7e9ee090b
```

bfd

Use this command to enable and disable all the BFD sessions on this interface.

Command Syntax

```
bfd (enable|disable)
```

Parameters

enable	Enable BFD
disable	Disable BFD

Command Mode

Interface mode

Applicability

This command was introduced before OcNOS version 1.3.

Example

```
#configure terminal  
(config)#interface eth1  
(config-if)#bfd disable
```

bfd echo

Use this command to set BFD sessions to echo mode.

Use the `no` form of the command to return a BFD session to its default mode off.

Note: BFD echo mode is supported for IPv4 BFD single hop sessions only.

Command Syntax

```
bfd echo
no bfd echo
```

Parameters

None

Default

By default, `bfd echo` is off.

Command Mode

Configure mode

Applicability

This command was introduced before OcNOS version 1.3.

Example

```
#configure terminal
(config)#bfd echo
```

bfd echo interval

Use this command to set the BFD echo interval.

Use the `no` form of this command to reset the echo interval to its default value.

Command Syntax

```
bfd echo interval <50-4294967>
no bfd echo interval
```

Parameter

<50-4294967> Transmit interval in milliseconds.

Default

The default value is 1000 milliseconds.

Command Mode

Interface mode

Applicability

This command was introduced before OcNOS version 1.3.

Example

The following command sets the BFD echo with no values.

```
#configure terminal
(config)#interface eth1
(config-if)#bfd echo interval 234
```

bfd echo ipv4 source

Use this command to set the echo ipv4 source address.

Use the `no` form of this command to reset the value.

Command Syntax

```
bfd echo ipv4 source A.B.C.D
no bfd echo ipv4 source
```

Parameter

A.B.C.D Source IPv4 address.

Command Mode

Interface mode

Applicability

This command was introduced before OcNOS version 1.3.

Example

The following command displays the ipv4 source address value.

```
#configure terminal
(config)#interface eth1
(config-if)#bfd echo interval 234
(config-if)#bfd echo ipv4 source A.B.C.D
```

bfd interval

Use this command to configure BFD transmit and receive intervals, and the hello multiplier value.

Use the `no` form of the command to set the intervals and multiplier to their default values.

Note: If "bfd session software" configured on any I3 interface then minimum tx/rx can be configured as 10 else minimum tx/rx can be configured as 3.

Command Syntax

```
bfd interval <3-999> minrx <3-999> multiplier <3-50>
no bfd interval
```

Parameters

<code><3-999></code>	Transmit interval in milliseconds.
<code>minrx</code>	Receive interval.
<code><3-999></code>	Receive interval in milliseconds.
<code>multiplier</code>	Hello multiplier.
<code><3-50></code>	Hello multiplier value.

Defaults

The default for the transmit and receive intervals is 250 milliseconds.

The default hello multiplier value is 3.

Command Mode

Interface mode

Applicability

This command was introduced before OcNOS version 1.3.

Example

```
#configure terminal
(config)#interface eth1
(config-if)#bfd interval 100 minrx 100 multiplier 5
(config-if)#
```

bfd multihop-peer

Use this command to enable authentication over either a multihop IPv4 or IPv6 session

Use the `no` form of the command to disable BFD authentication.

Command Syntax

```
bfd multihop-peer (A.B.C.D | X:X::X:X) auth type (keyed-md5 | keyed-sha1 |
meticulous-keyed-md5 | meticulous-keyed-sha1 | simple) key-id <0-255> <0|1> key
(WORD)

no bfd multihop-peer (A.B.C.D) auth
```

Parameters

A.B.C.D	Specify an IPv4 address.
X:X::X:X	Specify
auth type	Specify an authentication type.
simple	Specify a simple authentication type.
keyed-md5	Specify a keyed message digest authentication type.
keyed-sha1	Specify a keyed secure hashing algorithm authentication type.
meticulous-keyed-sha1	Specify an authentication key Meticulous Keyed Secure hashing algorithm authentication type.
meticulous-keyed-md5	Specify an authentication key meticulous keyed message digest authentication.
key-id	Indicate the <code>key-id</code> keyword.
<0-255>	Specify the key ID value.
<0 1>	0 Unencrypted password (key) 1 Encrypted password (key)
key	Indicate the <code>key</code> keyword.
WORD	Specify the authentication key name. Whitespaces is not allowed in key.

Command Mode

Configure mode

Applicability

This command was introduced before OcNOS version 1.3.

Example

Do the following to configure a single-key support:

Use value 0 before the key parameter for plain text key.

Use value 1 before the key parameter for already encrypted key.

```
#configure terminal
```



```
(config)#bfd multihop-peer 10.10.10.2 auth type keyed-md5 key-id 100 0 key  
test-key  
(config)#bfd multihop-peer 20.20.20.2 auth type keyed-sha1 key-id 200 1 key  
0x4d8ea8d7e9ee090b
```

bfd multihop-peer A.B.C.D interval

Use this command to configure IPv4 BFD multihop peer timer values.

Use the `no` form of the command to reset the IPv4 multihop peer timer value.

Note: Multihop BFD operates at control plane. When handling numerous services or traffic sessions, BFD session instability might occur. To address this, it's recommended to increase RX/TX interval to the maximum value 999 milliseconds and refrain from selecting or configuring the default 250-millisecond option.

Command Syntax

```
bfd multihop-peer A.B.C.D interval <50-999> minrx <50-999> multiplier <3-50>
no bfd multihop-peer A.B.C.D interval
```

Parameters

<code>interval</code>	Indicate the interval parameter.
<code><50-999></code>	Specify the actual transmit interval in milliseconds.
<code>minrx</code>	Indicate the minrx parameter.
<code><50-999></code>	Specify the actual reception interval in milliseconds.
<code>multiplier</code>	Indicate the multiplier parameter.
<code><3-50></code>	Specify the actual hello multiplier value.

Command Mode

Configure mode

Default

Multiplier value is 3

Applicability

This command was introduced before OcNOS version 1.3.

Example

```
#configure terminal
(config)#bfd multihop-peer 10.1.1.67 interval 100 minrx 100 multiplier 3
(config)#
```

bfd multihop-peer X:X::X:X interval

Use this command to configure an IPv6 BFD multihop peer timer values.

Use the `no` form of the command to reset the IPv6 multihop peer timer values.

Command Syntax

```
bfd multihop-peer X:X::X:X interval <50-999> minrx <50-999> multiplier <3-50>
no bfd multihop-peer X:X::X:X interval
```

Parameters

<code>interval</code>	Indicate the interval parameter.
<code><50-999></code>	Specify the actual transmit interval in milliseconds.
<code>minrx</code>	Indicate the minrx parameter.
<code><50-999></code>	Specify the actual reception interval in milliseconds.
<code>multiplier</code>	Indicate the multiplier parameter.
<code><3-50></code>	Specify the actual hello multiplier value.

Command Mode

Configure mode

Default

Default multiplier value is 3

Applicability

This command was introduced before OcNOS version 1.3.

Example

```
#configure terminal
(config)#bfd multihop-peer 10.1.1.1 interval 100 minrx 100 multiplier 3
```

bfd notification

Use this command to enable or disable BFD notification.

Command Syntax

```
bfd notification (enable | disable)
```

Parameters

disable	Disable BFD notification.
enable	Enable BFD notification.

Command Mode

Configure mode

Applicability

This command was introduced before OcNOS version 1.3.

Examples

```
#configure terminal  
(config)#bfd notification enable  
  
(config)#bfd notification disable
```

bfd session

Use this command to create a BFD IPv4 or IPv6 session on an interface.

Use the no form of the command to delete a BFD session from an interface.

Command Syntax

```
interface <IFNAME>/bfd session (A.B.C.D | X:X::X:X) (A.B.C.D | X:X::X:X) (multihop)
    (non-persistent | admin-down | demand-mode)
```

Parameters

A.B.C.D	Source IPv4 address
X:X::X:X	Source IPv6 address
multihop	Multihop Session
admin-down	Administrative down session
demand-mode	Demand mode session
non-persistent	Non persistent session

Command Mode

Configure mode

Applicability

This command was introduced before OcNOS version 1.3.

Examples

```
#configure terminal
(config)#interface eth2
(config-if)#bfd session 20.20.20.2 20.20.20.1 admin-down
(config-if)#do sh run bfd
!
interface eth2
bfd session 20.20.20.2 20.20.20.1 admin-down
!
(config-if)#no bfd session 20.20.20.2 20.20.20.1 admin-down
(config-if)#do sh run bfd
!
interface eth2
bfd session 20.20.20.2 20.20.20.1
!
(config-if)#bfd session 20.20.20.2 20.20.20.1 admin-down
(config-if)#do sh run bfd
!
interface eth2
bfd session 20.20.20.2 20.20.20.1 admin-down
!
(config-if)#no bfd session 20.20.20.2 20.20.20.1
(config-if)#do sh run bfd
!
```

bfd slow-timer

Use this command to set a BFD slow timer interval.

Use the `no` form of the command to reset the timer to default values.

Command Syntax

```
bfd slow-timer <1000-30000>
no bfd slow-timer
```

Parameter

<1000-30000> Interval for the slow-timer in milliseconds

Command Mode

Configure mode

Default

Default slow-timer value is 2000

Applicability

This command was introduced before OcNOS version 1.3.

Example

```
#configure terminal
(config)#bfd slow-timer 1500
(config)#
```

debug bfd

Use this command to enable debugging for BFD.

Use the `no` form of the command to disable all debugging for BFD.

Command Syntax

```
debug bfd (all|)
debug bfd (event|ipc-error|ipc-event|nsm|packet|session)
no debug bfd (all|)
no debug all
no debug bfd (event|ipc-error|ipc-event|nsm|packet|session)
```

Parameters

<code>all</code>	Enable all debugging.
<code>event</code>	Enable BFD event debugging.
<code>ipc-error</code>	Enable BFD IPC-error debugging.
<code>ipc-event</code>	Enable BFD IPC-event debugging.
<code>nsm</code>	Enable BFD NSM debugging.
<code>packet</code>	Enable BFD packet debugging.
<code>session</code>	Enable BFD session debugging.

Command Mode

Exec, Privileged Exec and Configure Mode

Applicability

This command was introduced before OcNOS version 1.3.

Examples

```
#debug bfd all
#debug bfd event
#debug bfd ipc-error
#debug bfd ipc-event
#debug bfd nsm
#debug bfd packet
#debug bfd session
```

hardware-profile micro-bfd

Use this command to enable micro-BFD support on hardware.

Note: Micro-bfd support is optional when a BFD session is configured over a LAG interface between two Qumran devices. It is mandatory to enable micro-bfd when the BFD session is configured over LAG interface between different platforms. When BFD sessions are configured over LAG interfaces, both Qumran nodes should have micro-bfd enabled or disabled.

Command Syntax

```
hardware-profile micro-bfd (enable|disable)
```

Parameter

enable	Enable micro-bfd support on Qumran
disable	Disable micro-bfd support on Qumran

Default

By default, micro-bfd support is disabled on Qumran.

Command Mode

Configure mode

Applicability

This command was introduced in OcNOS version 3.0.

Example

```
#configure terminal  
(config)# hardware-profile micro-bfd enable
```

hardware-profile seamless-bfd

Use this command to enable the hardware-profile for seamless-bfd to successfully activate seamless-bfd in the hardware.

Before configuring s-bfd sr policy NAME or s-bfd discriminator A.B.C.D give this command.

Before disabling the hardware-profile, unconfigure s-bfd sr policy NAME or s-bfd discriminator.

Note: You need to save the configuration and do a reboot after giving this command.

Use `disable` form of this command to disable the configured hardware-profile.

Command Syntax

```
hardware-profile seamless-bfd enable
hardware-profile seamless-bfd disable
```

Parameter

None

Default

By default, seamless-bfd hardware-profile is disabled.

Command Mode

Configure mode

Applicability

This command was introduced in OcNOS version 6.1.0.

Example

```
#configure terminal
(config)# hardware-profile seamless-bfd enable
(config)# hardware-profile seamless-bfd disable
```

key-id

Use this command to manage, add or delete authentication keys in a key chain. This command allows you to enter the keychain-key mode to set a password for the key.

Command Syntax

```
key-id <0-2147483647>
no key-id <0-2147483647>
```

Parameters

<0-2147483647> Specify a key identifier.

Default

By default, BFD uses level-1-2 if there is no Level-2 instance nor a Level-1-2 instance. Otherwise, it uses level-1.

Command Mode

Keychain mode

Applicability

This command was introduced before OcnOS version 1.3.

Examples

The following example configures a key number 1 and shows the change to keychain-key command mode.

```
#configure terminal
(config)#key chain mychain
(config-keychain)#key-id 1
(config-keychain-key)#
```

key chain

Use this command to enter key chain mode to configure a key chain with a key chain name. This command allows you to enter the keychain mode to specify keys on this key chain.

Command Syntax

```
key chain WORD
no key chain WORD
```

Parameters

WORD Specify the name of the key chain to manage.

Command Mode

Configure mode

Applicability

This command was introduced before OcnOS version 1.3.

Examples

The following example shows the creation of a key chain named `mychain` and the change to keychain mode:

```
#configure terminal
(config)#key chain mychain
(config-keychain)#
```

key-string

Use this command to define a password in plain-text to be used by a key.

The password is stored as encrypted, and is displayed in encrypted text when show running-config command is executed.

Use the `no` parameter with this command to disable this feature.

Command Syntax

```
key-string WORD
no key-string
```

Parameters

WORD	Specify a string of characters to be used as a password by the key. The length of the string should be between 1-80 characters.
------	---

Default

By default, password is not configured.

Command Mode

Keychain mode and Keychain-key mode

Applicability

This command was introduced before OcnOS version 1.3.

Examples

In the following example, the password for `key-id 1` in the key chain named `mychain` is set to `prime`:

```
#configure terminal
(config)#key chain mychain
(config-keychain)#key-id 1
(config-keychain-key)#key-string prime

(config-keychain)#key-id 1
(config-keychain-key)#no key-string
```

key-string encrypted

Use this command to define a password in its encrypted format to be used by a key.

Use the `no` parameter with this command to disable this feature

Command Syntax

```
key-string encrypted WORD
no key-string encrypted
```

Parameters

`WORD` Specify the encrypted string of characters to be used as a password by the key. The length of this string should be between 18-162 characters.

Default

By default, password is not configured.

Command Mode

Keychain mode and Keychain-key mode.

Applicability

This command was introduced in OcNOS version 4.1.

Examples:

In the following example, the encrypted password for key-id 1 in the key chain named mykeychain is set to 0xd6c50b442de47f70 (equivalent to "mychain" in plain-text):

```
#configure terminal
(config)#key chain mykeychain
(config-keychain)#key-id 1
(config-keychain-key)#key-string encrypted 0xd6c50b442de47f70
(config-keychain)#key-id 1
(config-keychain-key)#no key-string
```

send-lifetime

Use this command to specify the time period during which the authentication key on a key chain can be sent.

Use the `no` parameter with this command to negate this command.

Command Syntax

```
send-lifetime HH:MM:SS MONTH <01-31> <1993-2035> HH:MM:SS MONTH <01-31> <1993-2035>
send-lifetime HH:MM:SS MONTH <01-31> <1993-2035> infinite
send-lifetime HH:MM:SS MONTH <01-31> <1993-2035> duration <1-2147483646>
no send-lifetime
```

Parameters

HH:MM:SS	Specify the start time of send-lifetime in hours, minutes and seconds.
<01-31>	Specify the day of the month to start. If the day is a single-digit, the leading 0 must be added, example: 01, 02, 03, etc.
MONTH	Specify the month of the year to start as the first three letters of the month with first letter in upper case, for example, Jan. (case sensitive).
<1993-2035>	Specify the year to start.
HH:MM:SS	Specify the end time of send-lifetime in hours, minutes and seconds.
<01-31>	Specify the day of the month to end.
MONTH	Specify the month of the year to end as the first three letters of the month with first letter in upper case, for example, Jan. (case sensitive).
<1993-2035>	Specify the year to end.
duration	Indicate the duration parameter.
<1-2147483646>	Specify the actual end time duration of a key in seconds.
infinite	Specify the end time to never expire.

Command Mode

Keychain-key mode

Applicability

This command was introduced before OcnOS version 1.3.

Examples

The following example shows the setting of `send-lifetime` for `key-id 1` on the key chain named `mychain`:

```
#configure terminal
(config)#key chain mychain
(config-keychain)#key-id 1
(config-keychain-key)#send-lifetime 03:03:01 Jan 03 2004 04:04:02 Dec 06 2006
```

show bfd

Use this command to display information about the BFD process.

Command Syntax

```
show bfd
```

Parameters

None

Command Mode

Exec mode and Privileged Exec mode

Applicability

This command was introduced before OcNOS version 1.3.

Example

The example below displays the command syntax and sample output from the command.

```
#show bfd
BFD ID: 00          Start Time: Fri May 1 09:55:06 2009
Number of Sessions: 1
Slow Timer: 1000   Image type: MONOLITHIC
Echo Mode: Disabled Next Session Discriminator: 2
#
```

[Table 1-86](#) explains the output fields.

Table 1-86: show BFD fields

Entry	Description
BFD ID	ID number of the BFD session.
Start Time	The date and time when the BFD session was started
BFD Admin State	State of the BFD session: Initializing: session is initializing Up: session is up. Down: session is down
Number of Sessions	Number of BFD sessions running on the device.
Slow Timer	Required minimum transmission time for the BFD session.
Image Type	Distributed or Monolithic.
Echo Mode	Either enabled or disabled.
Next Session Discriminator	An opaque discriminator value that identifies each session on the device that is used to demultiplex multiple BFD sessions between the same pair of devices.

show bfd interface

Use this command to display details for an interface running BFD or for all interfaces configured for BFD.

Command Syntax

```
show bfd interface (ifindex <0-4294967295>|all|)
```

Parameters

all	Display all interfaces.
ifindex	Display an interface index.
<0-4294967295>	Display an ID of an interface in this range.

Command Mode

Exec mode and Privileged Exec mode

Applicability

This command was introduced before OcNOS version 1.3.

Example

The example below displays the command syntax and sample output from the command.

```
#show bfd interface all
Interface:      lo ifindex: 1 state:  UP
Interface level configuration: NO ECHO, NO SLOW TMR
Timers in Milliseconds
Min Tx: 20 Min Rx: 20 Multiplier: 5

Interface:      eth0 ifindex: 2 state:  UP
Interface level configuration: NO ECHO, NO SLOW TMR
Timers in Milliseconds
Min Tx: 20 Min Rx: 20 Multiplier: 5

Interface:      eth1 ifindex: 3 state: DOWN
Interface level configuration: NO ECHO, NO SLOW TMR
Timers in Milliseconds
Min Tx: 20 Min Rx: 20 Multiplier: 5

Interface:      sit0 ifindex: 4 state: DOWN
Interface level configuration: NO ECHO, NO SLOW TMR
Timers in Milliseconds
Min Tx: 20 Min Rx: 20 Multiplier: 5

Interface:      gre0 ifindex: 5 state: DOWN
Interface level configuration: NO ECHO, NO SLOW TMR
Timers in Milliseconds
Min Tx: 20 Min Rx: 20 Multiplier: 5
```

Table 1-87 explains the output fields.

Table 1-87: show BFD interface fields

Entry	Description
interface	Interface on which BFD is running
ifindex	Interface index number
state	State of the BFD session for the interface: UP: session is up. DOWN: session is down
Interface level configuration	State of interface-level properties: echo on or off slow-timer (timer dampening) on or off
Min Tx	The minimum interval that the local device would like to use when transmitting BFD control packets.
Min Rx	The minimum interval between received BFD control packets that this device is capable of supporting
Multiplier	The negotiated transmit interval, multiplied by this value, provides the detection time for the receiving device in asynchronous mode.

show bfd session

Use this command to display BFD sessions.

Note: BFD Packet In and BFD Packet Out counters are not supported for Single Hop IPv4 BFD sessions on Qumran devices.

Command Syntax

```
show bfd session (detail|)
show bfd session vrf (WORD|all|default) (detail|)
```

Parameters

detail	Session details.
WORD	Sessions for this user-defined Virtual Routing and Forwarding instance name.
all	Show information for all Virtual Routing and Forwarding instances
default	Show information for only the default Virtual Routing and Forwarding instance

Command Mode

Exec mode and Privileged Exec mode

Applicability

This command was introduced before OcNOS version 1.3.

Example

```
#show bfd session detail
Session Interface Index : 3                Session Index : 1
Lower Layer : IPv4                        Version : 1
Session Type : Single Hop                 Session State : Down
Local Discriminator : 1                   Local Address : 19.19.19.2/32
Remote Discriminator : 0                   Remote Address : 19.19.19.1/32
Local Port : 49152                         Remote Port : 3784
Options :

Diagnostics: None

Timers in Milliseconds :
Min Tx: 20                               Min Rx: 20           Multiplier: 5
Neg Tx: 0                                 Neg Rx: 0            Neg detect mult: 0
Min echo Tx: 20                           Min echo Rx: 10     Neg echo intrvl: 0
Storage type: 2
Sess down time: 00:00:00
Bfd Authentication Enabled
Authentication type : simple
Auth-Key-Id: 47

Counters values:
Pkt In : 0000000000000000                Pkt Out : 0000000000000011
Echo Out : 0000000000000000              IPv6 Echo Out : 0000000000000000
IPv6 Pkt In : 0000000000000000           IPv6 Pkt Out : 0000000000000000
UP Count : 0                              UPTIME : 00:00:00
```

```
Protocol Client Info:
bfd-> Client ID: 28      Flags: 4
-----
```

```
#show bfd session vrf all
```

```
BFD process for VRF: vrf1
```

```
=====
Sess-Idx  Remote-Disc  Lower-Layer  Sess-Type  Sess-State  UP-Time
Interface  Down-Reason  Remote-Addr
1          1             IPv4         Single-Hop Up           00:05:38 eth1
NA        1.1.1.2/32
Number of Sessions: 1
```

```
BFD process for VRF: (DEFAULT VRF)
```

```
=====
Sess-Idx  Remote-Disc  Lower-Layer  Sess-Type  Sess-State  UP-Time
Interface  Down-Reason  Remote-Addr
1          7             IPv4         Single-Hop Up           00:03:31 eth3
NA        3.3.3.2/32
2          9             IPv4         Single-Hop Up           00:00:45 eth4
NA        4.4.4.2/32
Number of Sessions: 2
```

```
BFD process for VRF: vrf2
```

```
=====
Sess-Idx  Remote-Disc  Lower-Layer  Sess-Type  Sess-State  UP-Time
Interface  Down-Reason  Remote-Addr
1          6             IPv4         Single-Hop Up           00:03:37 eth2
NA        2.2.2.2/32
Number of Sessions: 1
```

Table 1-88 explains the output fields.

Table 1-88: show bfd session detail fields

Entry	Description
Session Interface Index	ID number of the interface.
Session Index Sess-Idx	ID number of this BFD session.
Lower Layer	The lower layer protocol on which BFD is carried: IPv4 IPv6 MPLS LSP MPLS VCCV MPLS-TP
Version	Session version number; generally 1.

Table 1-88: show bfd session detail fields (Continued)

Entry	Description
Session Type Sess-Type	Single Hop Multihop Arbit Path Multihop OOB Signalled Multihop Unidirectional.
Session State Sess-State	The State of the session: Init: The session is initializing Up: The session is up. Down: The session is down AdminDown: The session has been administratively shutdown indefinitely.
Local Discriminator	A unique discriminator value generated by the transmitting device used to demultiplex multiple BFD sessions between the same pair of devices.
Local Address	Local address of the transmitting device.
Remote Discriminator Remote-Disc	The discriminator received from the corresponding remote device; zero if that value is unknown.
Remote Address Remote-Addr	Remote address of the receiving device.
Local Port	UDP port number of the transmitting device.
Remote Port	UDP port number of destination.
Options	Fate Shared Echo Enabled Demand Enabled Remote Demand Enbl Remote admin Down Poll seq Init.
Diagnostics	Performance diagnostics: None Control Detection Time Expired Echo Failed Neighbor Session Down Forwarding Plane Reset Path Down Concatenated Path Down Admin Down Reverse Concatenated Path Down
Min Tx	Minimum transmit interval.
Min Rx	Minimum receive interval.
Multiplier	The negotiated transmit interval, multiplied by this value, provides the detection time for the receiving system in asynchronous mode.
Neg Tx	Negotiated transmit interval.
Neg Rx	Negotiated receive interval in milliseconds.

Table 1-88: show bfd session detail fields (Continued)

Entry	Description
Neg detect mult	Negotiated detection multiplier.
Min echo Tx	Minimum echo transmit interval in milliseconds.
Min echo Rx	Minimum echo receive interval in milliseconds.
Neg echo intrvl	Negotiated echo interval.
Storage type	SNMPv2 storage type (usually be set to 2): other(1) volatile(2) non-Volatile(3) permanent(4) read-Only(5)
Sess down time	Length of time this BFD session has been down.
Bfd GTSM	Whether the BFD session has enabled or disabled the Generalized TTL Security Mechanism (GTSM), which uses the time to live (TTL) or hop count to prevent off-link attackers from spoofing packets.
Bfd Authentication Enabled	When authentication is enabled.
Authentication type	Type of authentication: simple: Simple Password keyed-md5: Keyed message digest keyed-sha1: Keyed Secure hashing algorithm meticulous-keyed-md5: Meticulous Keyed message digest meticulous-keyed-sha1: Meticulous Keyed Secure hashing algorithm
Authentication Key-id	ID number of the authentication key.
Pkt In	Number of packets that have been received during this BFD session.
Pkt Out	Number of packets that have been transmitted during this BFD session.
Echo Out	Number of Echo-packets that have been transmitted during this BFD session.
IPv6 Pkt In	Number of IPv6 packets that have been received during this BFD session.
IPv6 Pkt Out	Number of IPv6 packets that have been transmitted during this BFD session.
UP Count	Number of times the BFD session has been up.
UPTIME	Length of time this BFD session has been up.
BGP-> Client ID	Protocol and module ID number of this BFD session's neighboring device.
Flags	Session state of the neighboring device.
Interface	The interface on which the VRF resides.
Down-Reason	The reason causing the VRF to be down.

show bfd session A.B.C.D

Use this command to display information about an IPv4 BFD session neighbor.

Command Syntax

```
show bfd session A.B.C.D A.B.C.D (detail|)
show bfd session vrf WORD A.B.C.D A.B.C.D (detail|)
show bfd session A.B.C.D A.B.C.D <0-4294967295> (detail|)
show bfd session vrf WORD A.B.C.D A.B.C.D <0-4294967295> (detail|)
```

Parameters

WORD	Name of a specific Virtual Routing and Forwarding instance
A.B.C.D	Display the local IPv4 address.
A.B.C.D	Display the neighbor IPv4 address.
<0-4294967295>	Display the interface index of the address.
detail	Display detailed information.

Command Mode

Exec mode and Privileged Exec mode

Applicability

This command was introduced before OcnOS version 1.3.

Example

The example below displays the command syntax and sample output from the command.

```
#show bfd session 10.1.1.66 10.1.1.67 3
Session Interface Index: 3      Session Index: 1
Lower Layer: IPv4      Single Hop
Session State: Up
Local Discriminator: 1 Remote Discriminator: 163
Local Address: 10.1.1.66/32      Remote Address: 10.1.1.67/32
Local Port: 49152      Remote Port: 3784
Timers in Milliseconds
Min Tx: 1000 Min Rx: 1000 Multiplier: 4
UP Count: 1 UPTIME: 00:10:08

#show bfd session vrf raj 130.1.1.1 130.1.1.2 detail

Session Interface Index : 10017      Interface name :xe16
Session Index : 2
Lower Layer : IPv4      Version : 1
Session Type : Single Hop      Session State : Up
Local Discriminator : 2      Local Address : 130.1.1.1/32
Remote Discriminator : 2      Remote Address : 130.1.1.2/32
Local Port : 49153      Remote Port : 3784
Options :
```

Diagnostics : None

Timers in Milliseconds :

```

Min Tx: 250              Min Rx: 250              Multiplier: 3
Neg Tx: 250              Neg Rx: 250              Neg detect mult: 3
Min echo Tx: 1000        Min echo Rx: 1000        Neg echo intrvl: 0
Storage type : 2
Sess down time : 00:00:00
Sess Down Reason : NA
Bfd GTSM Disabled
Bfd Authentication Disabled
    
```

Counters values:

```

Pkt In : n/a              Pkt Out : n/a
Pkts Drop : 00000000000000000000000000000000    Auth Pkts Drop :
00000000000000000000000000000000
Echo Out : 00000000000000000000000000000000    IPv6 Echo Out :
00000000000000000000000000000000
IPv6 Pkt In : 00000000000000000000000000000000    IPv6 Pkt Out : 00000000000000000000000000000000
UP Count : 1              UPTIME : 00:01:38
    
```

Protocol Client Info:

```

OSPF-> Client ID: 4      Flags: 4
    
```

Table 1-89 explains the output fields.

Table 1-89: Show BFD session fields

Entry	Description
Session Interface Index	ID number of the Interface.
Session Index	ID number for this BFD session.
Lower Layer	The lower layer protocol on which BFD is carried (IPv4 or IPv6).
Session State	The state of the session: Init: session is initializing Up: session is up. Down: session is down AdminDown: session has been administratively shutdown indefinitely
Local Discriminator	A unique value generated by the transmitting device used to demultiplex multiple BFD sessions between the same pair of devices.
Remote Discriminator	The discriminator received from the corresponding remote device. This field is zero if the value is unknown.
Local Address	Local address of the transmitting device.
Remote Address	Remote address of the receiving device.
Local Port	UDP port number of the transmitting device.
Remote Port	UDP port number of the receiving device.
Min Tx	Minimum transmit interval in milliseconds.

Table 1-89: Show BFD session fields

Entry	Description
Min Rx	Minimum receive interval in milliseconds.
Multiplier	The negotiated transmit interval, multiplied by this value, provides the detection time for the receiving system in asynchronous mode.
UP Count	The number of times the BFD session has been in up state.
UPTIME	The length of time this BFD session has been in the up state.

show bfd session ipv6

Use this command to display information about an IPv6 BFD session neighbor.

Command Syntax

```
show bfd session ipv6 X:X::X:X X:X::X:X (detail|)
show bfd session ipv6 vrf WORD X:X::X:X X:X::X:X (detail|)
show bfd session ipv6 X:X::X:X X:X::X:X <0-4294967295> (detail|)
show bfd session ipv6 vrf WORD X:X::X:X X:X::X:X <0-4294967295> (detail|)
```

Parameters

WORD	Name of a specific Virtual Routing and Forwarding instance
X:X::X:X	Display the local IPv6 address.
X:X::X:X	Display the neighbor IPv6 address.
<0-4294967295>	Display the interface index of the address.
detail	Display detailed information.

Command Mode

Exec mode and Privileged Exec mode

Applicability

This command was introduced before OcNOS version 1.3.

Example

The example below displays the command syntax and sample output from the command.

```
#show bfd session 2001::1222 2001::1223 3
Session Interface Index : 3      Session Index: 1
Lower Layer: IPv6      Single Hop
Session State : Up
Local Discriminator : 1 Remote Discriminator: 163
Local Address : 2001::1222/128   Remote Address: 2001::1223/128
Local Port : 49152      Remote Port: 3784
Timers in Milliseconds
Min Tx: 1000 Min Rx: 1000 Multiplier: 4
UP Count: 1 UPTIME: 00:06:03
```

```
#show bfd session ipv6 vrf raj fe80::ba6a:97ff:fed3:26c5
fe80::ba6a:97ff:fece:3bc5 detail

Session Interface Index : 10017      Interface name :xe16
Session Index : 259
Lower Layer : IPv6                  Version : 1
Session Type : Single Hop          Session State : Up
Local Discriminator : 259           Local Address :
fe80::ba6a:97ff:fed3:26
c5/128
```

Bidirectional Forwarding Commands

```

Remote Discriminator : 257
fe80::ba6a:97ff:fece:3
bc5/128
Local Port : 49152
Options :

Remote Address :
Remote Port : 3784

Diagnostics : None

Timers in Milliseconds :
Min Tx: 250           Min Rx: 250           Multiplier: 3
Neg Tx: 250           Neg Rx: 250           Neg detect mult: 3
Min echo Tx: 1000     Min echo Rx: 1000     Neg echo intrvl: 0
Storage type : 2
Sess down time : 00:00:00
Sess Down Reason : NA
Bfd GTSM Disabled
Bfd Authentication Disabled

Counters values:
Pkt In : n/a           Pkt Out : n/a
Pkts Drop : 00000000000000000000000000000000
00000000000000000000000000000000
Echo Out : 00000000000000000000000000000000
00000000000000000000000000000000
IPv6 Pkt In : 00000000000000000000000001671
UP Count : 1           IPv6 Pkt Out : 00000000000000000000000001675
UPTIME : 00:06:05

Protocol Client Info:
OSPF6-> Client ID: 5   Flags: 4

```

Table 1-90 explains the output fields.

Table 1-90: show BFD session fields

Entry	Description
Session Interface Index	ID number of the Interface.
Session Index	ID number for this BFD session.
Lower Layer	The lower layer protocol on which BFD is carried (IPv4 or IPv6).
Session State	The state of the session: Init: session is initializing Up: session is up. Down: session is down AdminDown: session has been administratively shutdown indefinitely
Session Type	Whether the session is Single Hop or Multiple Hop
Local Discriminator	A unique value generated by the transmitting device used to demultiplex multiple BFD sessions between the same pair of devices.
Remote Discriminator	The discriminator received from the corresponding remote device. This field is zero if the value is unknown.

Table 1-90: show BFD session fields

Entry	Description
Local Address	Local address of the transmitting device.
Remote Address	Remote address of the receiving device.
Local Port	UDP port number of the transmitting device.
Remote Port	UDP port number of the receiving device.
Min Tx	Minimum transmit interval in milliseconds.
Min Rx	Minimum receive interval in milliseconds.
Min echo Tx	Minimum transmit interval for echo packets
Min echo Rx	minimum receive interval for echo packets
Neg echo intrvl	The negotiated
Storage type	Indicates the storage type: 1 = other 2 = volatile 3 = nonvolatile 4 = permanent 5 = read only
Sess down time	How long the session was down
Sess Down Reason	Reason for Session being down
Bfd GTSM	Whether Generalized TTL Security Mechanism (GTSM) is enabled or disabled on the connection.
Multiplier	The negotiated transmit interval, multiplied by this value, provides the detection time for the receiving system in asynchronous mode.
UP Count	Number of times the BFD session has been in up state.
UPTIME	Length of time this BFD session has been in the up state.
Bfd Authentication	If authentication is used, if yes, the type authentication: simple password, MD5, and so on.
Pkt In	Number of Packets received on the BFD session
Pkt Out	Number of packets transmitted on the BFD session
Pkts Drop	Number of packets dropped on the session
Auth Pkts Drop	Number of Authentication packets dropped
Echo Out	Number of Transmitted BFD Echo Packets
IPv6 Echo Out	Number of transmitted BFD Ipv6 Echo packets
IPv6 Pkt In	Number of received IPv6 BFD packets
IPv6 Pkt Out	Number of transmitted IPV6 BFD packets
Protocol Client Info	Client ID and flags

show debugging bfd

Use this command to display debugging information for BFD processes.

Command Syntax

```
show debugging bfd
```

Parameters

None

Command Mode

Exec mode and Privileged Exec mode

Applicability

This command was introduced before OcNOS version 1.3.

Example

The example below displays the command syntax and sample output from the command.

```
#show debugging bfd
BFD debugging status:
BFD events debugging is on
BFD packet debugging is on
BFD ipc-error debugging is on
BFD ipc-event debugging is on
BFD session debugging is on
BFD nsm debugging is on
#
```

snmp restart bfd

Use this command to restart SNMP in Bidirectional Forwarding (BFD)

Command Syntax

```
snmp restart bfd
```

Parameters

None

Command Mode

Configure mode

Applicability

This command was introduced before OcNOS version 1.3.

Examples

```
#snmp restart bfd
```

CHAPTER 2 Protocol Commands for BFD

The chapter describes the commands used to manage BFD functionality for OSPF, IS-IS and BGP.

- [area virtual-link](#)
- [bfd all-interfaces](#)
- [debug bgp bfd](#)
- [debug isis bfd](#)
- [debug ospf bfd](#)
- [ip ospf bfd](#)
- [isis bfd](#)

area virtual-link

Use this command to enable the BFD option for a specified virtual-link neighbor.

Use the `no` form of the command to disable BFD on a virtual-link neighbor.

Command Syntax

```
area (A.B.C.D|<0-4294967295>) virtual-link A.B.C.D {fall-over bfd}
no area (A.B.C.D|<0-4294967295>) virtual-link A.B.C.D {fall-over bfd}
```

Parameters

A.B.C.D	Indicate an area IP address
<0-4294967295>	Indicate an area ID in integer format
virtual-link	Indicate a virtual link and its parameters
A.B.C.D	Indicate the IP address of the virtual link
fall-over	Indicate fall-over detection
bfd	Specify the Bidirectional Forwarding Detection (BFD)

Default

No default value is specified

Command Mode

Router mode

Applicability

This command was introduced before OcNOS version 1.3.

Example

```
#configure terminal
(config)#router ospf
(config-router)#area 1 virtual-link 192.168.0.1 fall-over bfd
```

bfd all-interfaces

Use this command to enable BFD for all neighbors maintained by an OSPF process or an ISIS instance.

Use the `no` form of the command to disable BFD.

Note: This command does not apply BFD to virtual-link neighbors.

Command Syntax

```
bfd all-interfaces
no bfd all-interfaces
```

Parameters

None

Default

By default, `bfd all interface` is disabled

Command Mode

Configure router mode

Applicability

This command was introduced before OcNOS version 1.3.

Example

```
#configure terminal
(config)#router ospf
(config-router)#bfd all-interfaces

#configure terminal
(config)#router isis
(config-router)#bfd all-interfaces
```

debug bgp bfd

Use this command to debug BFD processes in BGP.

Use the `no` form of the command to stop debugging.

Command Syntax

```
debug bgp bfd
no debug bgp bfd
undebug bgp bfd
```

Parameters

None

Command Mode

Exec mode and Configure mode

Applicability

This command was introduced before OcNOS version 1.3.

Example

```
#configure terminal
(config)#debug bgp bfd
```

debug isis bfd

Use this command to debug BFD processes in IS-IS.

Use the `no` form of the command to stop debugging.

Command Syntax

```
debug isis bfd
no debug isis bfd
undebug isis bfd
```

Parameters

None

Command Mode

Exec mode and Configure mode

Applicability

This command was introduced before OcnOS version 1.3.

Example

```
#configure terminal
(config)#debug isis bfd
```

debug ospf bfd

Use this command to debug BFD processes in OSPF.

Use the `no` form of the command to stop debugging.

Command Syntax

```
debug ospf bfd
no debug ospf bfd
undebug ospf bfd
```

Parameters

None

Command Mode

Exec mode and Configure mode

Applicability

This command was introduced before OcNOS version 1.3.

Example

```
#configure terminal
(config)#debug ospf bfd
```

ip ospf bfd

Use this command to enable the BFD option for OSPF neighbors on an interface. Use the `no` form of the command to disable the BFD option for OSPF neighbors on an interface.

Note: When BFD monitoring is enabled for ospf session, protocol admin events like clear/ shutdown will cause BFD session to go to admin down. Due to this, neighbourship/adjacency down detection on peer will be according to the protocol configured dead interval and is not based on BFD interval.

Command Syntax

```
ip ospf bfd (disable|)
no ip ospf bfd (disable|)
```

Parameter

<code>disable</code>	Disable the BFD option for neighbors on an interface
----------------------	--

Default

No default value is specified

Command Mode

Interface mode

Applicability

This command was introduced before OcNOS version 1.3.

Example

```
#configure terminal
(config)#interface eth1
(config-if)#ip ospf bfd
```

isis bfd

Use this command to enable the BFD option for IS-IS neighbors on an interface. Use the `no` form of the command to disable the BFD option for neighbors on an interface.

Note: When BFD monitoring is enabled for ISIS session, protocol admin events like clear/ shutdown will cause BFD session to go to admin down. Due to this, neighbourship/adjacency down detection on peer will be according to the protocol configured hello hold interval and is not based on BFD interval.

Command Syntax

```
isis bfd (disable|)
no isis bfd (disable|)
```

Parameter

<code>disable</code>	Used to disable the BFD option for neighbors on an interface
----------------------	--

Default

No default value is specified

Command Mode

Interface mode

Applicability

This command was introduced before OcNOS version 1.3.

Example

```
#configure terminal
(config)#interface eth1
(config-if)#isis bfd disable
```

CHAPTER 3 BFD Static Route Commands

Bidirectional Forwarding Detection (BFD) support for static routes can be configured on a static route basis, interface basis, or on a global level:

- When BFD is configured for an IPv4 or IPv6 static route, BFD provides the next-hop reachability detection for the given static route.
- When BFD is configured for an interface, BFD provides the data plane next-hop reachability information for any IPv4 or IPv6 static route configured through the given interface.
- When BFD is configured globally, BFD is applied on all interfaces with a single command. In all these cases, the BFD session update for NSM governs the state of the static routes.

This chapter includes the following commands:

- [ip bfd static all-interfaces](#)
- [ip static fall-over-bfd](#)
- [ip static bfd](#)
- [ipv6 bfd static all-interfaces](#)
- [ipv6 static fall-over-bfd](#)
- [ipv6 static bfd](#)

ip bfd static all-interfaces

Use this command to enable BFD support for IPv4 static routes configured on all interfaces.

Use the `no` option with this command to disable BFD support for IPv4 static routes configured on all interfaces.

Command Syntax

```
ip bfd static all-interfaces
ip bfd vrf NAME static all-interfaces
no ip bfd static all-interfaces
no ip bfd vrf NAME static all-interfaces
```

Parameters

NAME	Enable/disable IPv4 static BFD on all interfaces bound to this user-defined Virtual Routing and Forwarding instance name.
------	---

Command Mode

Configure mode

Applicability

This command was introduced before OcNOS version 1.3 and updated in OcNOS version 1.3.5.

Example

```
#configure terminal
(config)#ip bfd static all-interfaces

#configure terminal
(config)#ip bfd vrf vrf1 static all-interfaces
```

ip static fall-over-bfd

Use this command to enable BFD support for a specific IPv4 static route.

Use the `no` form of the command to disable the BFD support for a specific IPv4 static route.

Command Syntax

```
ip static A.B.C.D/M A.B.C.D fall-over-bfd (disable|enable)
no ip static A.B.C.D/M A.B.C.D
ip static vrf NAME A.B.C.D/M A.B.C.D fall-over-bfd (disable|enable)
no ip static vrf NAME A.B.C.D/M A.B.C.D
```

Parameters

A.B.C.D/M	The IPv4 destination prefix and mask length.
A.B.C.D	The IPv4 gateway address.
disable	Disable BFD.
enable	Enable BFD.
NAME	Enable/disable BFD for the IPv4 routes for this user-defined Virtual Routing and Forwarding instance name.

Command Mode

Configure mode

Applicability

This command was introduced before OcNOS version 1.3 and updated in OcNOS version 1.3.5.

Example

```
#configure terminal
(config)#ip static A.B.C.D/M A.B.C.D fall-over-bfd disable

#configure terminal
(config)# ip static vrf vrf1 A.B.C.D/M A.B.C.D fall-over-bfd enable
```

ip static bfd

Use this command to enable or disable BFD support for IPv4 static route(s) configured on an interface.

Use the `no` option with this command to reset BFD support for IPv4 static route(s) configured on an interface.

Note: When `static bfd` is enabled on the interface (`ip static bfd enable`) and if the `bfd` session is not up, then the related static route to that interface will fall into inactive state.

Command Syntax

```
ip static bfd (disable|enable)
no ip static bfd
```

Parameters

<code>disable</code>	Disable BFD
<code>enable</code>	Enable BFD

Command Mode

Interface mode

Default

By default, BFD static route support is disabled at all levels.

Applicability

This command was introduced before OcNOS version 1.3.

Example

```
#configure terminal
(config)#interface eth1
(config-if)#ip static bfd disable

(config)#interface eth1
(config-if)#ip static bfd enable
```

ipv6 bfd static all-interfaces

Use this command to enable BFD support for IPv6 static routes on all interfaces.

Use the `no` option with this command to disable BFD support for IPv6 static routes on all interfaces.

Command Syntax

```
ipv6 bfd static all-interfaces
ipv6 bfd vrf NAME static all-interfaces
no ipv6 bfd static all-interfaces
no ipv6 bfd vrf NAME static all-interfaces
```

Parameters

NAME	Enable/disable IPv6 static BFD on all interfaces bound to this user-defined Virtual Routing and Forwarding instance name.
------	---

Command Mode

Configure mode

Applicability

This command was introduced before OcNOS version 1.3 and updated in OcNOS version 1.3.5.

Example

```
#configure terminal
(config)#ipv6 bfd static all-interfaces

#configure terminal
(config)#ipv6 bfd vrf vrf1 static all-interfaces
```

ipv6 static fall-over-bfd

Use this command to enable BFD support for a specific IPv6 static route.

Use the `no` option with this command to disable BFD support for a specific IPv6 static route.

Command Syntax

```
ipv6 static X:X::X:X/M X:X::X:X fall-over-bfd (disable|enable)
no ipv6 static X:X::X:X/M X:X::X:X
ipv6 static vrf NAME X:X::X:X/M X:X::X:X fall-over-bfd (disable|enable)
no ipv6 static vrf NAME X:X::X:X/M X:X::X:X
```

Parameters

X:X::X:X/M	The IPv6 destination prefix and mask length.
X:X::X:X	The IPv6 gateway address.
NAME	Enable/disable BFD for the IPv6 routes for this user-defined Virtual Routing and Forwarding instance name.
disable	Disable BFD.
enable	Enable BFD.

Command Mode

Configure mode

Applicability

This command was introduced before OcNOS version 1.3 and updated in OcNOS version 1.3.5.

Examples

```
#configure terminal
(config)#ipv6 static X:X::X:X/M X:X::X:X fall-over-bfd disable

#configure terminal
(config)#ipv6 static X:X::X:X/M X:X::X:X fall-over-bfd enable

#configure terminal
(config)#ipv6 static vrf vrf1 X:X::X:X/M X:X::X:X fall-over-bfd disable
```

ipv6 static bfd

Use this command to disable BFD support for IPv6 static route(s) configured on an interface.

Use the `no` option with this command to reset BFD support for IPv6 static route(s) configured on an interface.

Command Syntax

```
ipv6 static bfd (disable|enable)
no ipv6 static bfd
```

Parameters

<code>disable</code>	Disable BFD
<code>enable</code>	Enable BFD

Command Mode

Interface mode

Applicability

This command was introduced before OcnOS version 1.3.

Example

```
#configure terminal
(config)#interface eth1
(config-if)#ipv6 static bfd disable
```

Virtual Router Redundancy Protocol Configuration Guide

CHAPTER 1 VRRP Configuration

This chapter provides an overview of Virtual Router Redundancy Protocol (VRRP) and its implementation with OcNOS. VRRP eliminates the risk of a single point of failure inherent in a static default routing environment. It specifies an election protocol that dynamically assigns responsibility for a virtual router to one of the VRRP routers on a LAN. One of the major advantages of VRRP is that it makes default path available without requiring configuration of dynamic routing on every end-host.

OcNOS only supports VRRP protocol version 3.

For complete information about MC-LAG configuration with Intra-domain-Link (IDL), refer to [Configuration](#) and Intra-domain-peer (IDP), refer to [Configuration](#) in *OcNOS Layer 2 Config Guide*.

Terminology

Terms related to VRRP configuration are defined in the table below.

Backup Router	The VRRP router that is backing up an IP address. It assumes forwarding responsibility for the virtual IP address if the Master fails.
Critical IP	The IP address that a VRRP router sends/receives messages on for a particular session.
IP Address Owner	The VRRP Router that has the virtual router's IP address(es) as real interface address(es). This is the router that, when up, will respond to packets addressed to one of these IP addresses for ICMP pings, TCP connections, and so on
Master Router	The VRRP router that owns the IP address (i.e., is being backed up), and which is the default router for forwarding for that IP address.
Virtual IP	The IP address that is being backed up by a VRRP session.
Virtual Router	A router managed by VRRP that acts as a default router for hosts on a shared LAN. It consists of a Virtual Router Identifier and a set of associated IP addresses across a common LAN. A VRRP Router might backup one or more virtual routers.
VRRPv2 Router	A router running the Virtual Router Redundancy Protocol version 2. It might participate in one or more virtual routers.
VRRPv3 Router	A router running the Virtual Router Redundancy Protocol version 3. It might participate in one or more virtual routers.

VRRP Process

Typically, end hosts are connected to the enterprise network through a single router (first-hop router) that is in the same Local Area Network (LAN) segment. The most popular method of configuration is for the end hosts to configure statically this router as their default gateway. This minimizes configuration and processing overhead. As shown in [Figure 1-173](#), the problem with this configuration is that it produces a single point of failure if this first-hop router fails.

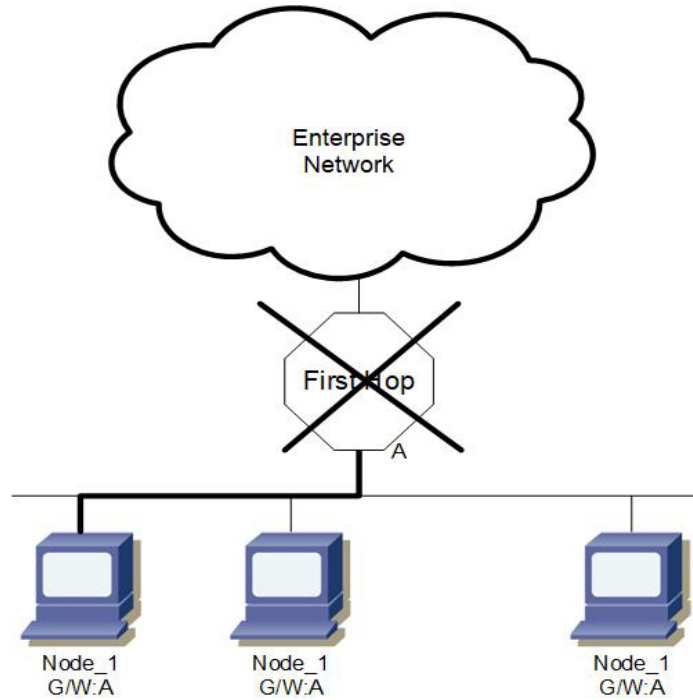

Figure 1-173: VRRP Process - First-Hop Not Reachable

The Virtual Router Redundancy Protocol attempts to solve this problem by introducing the concept of a virtual router, composed of two or more VRRP routers on the same subnet as shown in [Figure 1-174](#). The concept of a virtual IP address is also introduced, which is the address that end hosts configure as their default gateway. One of the routers called the “Master” forwards packets on behalf of this IP address.

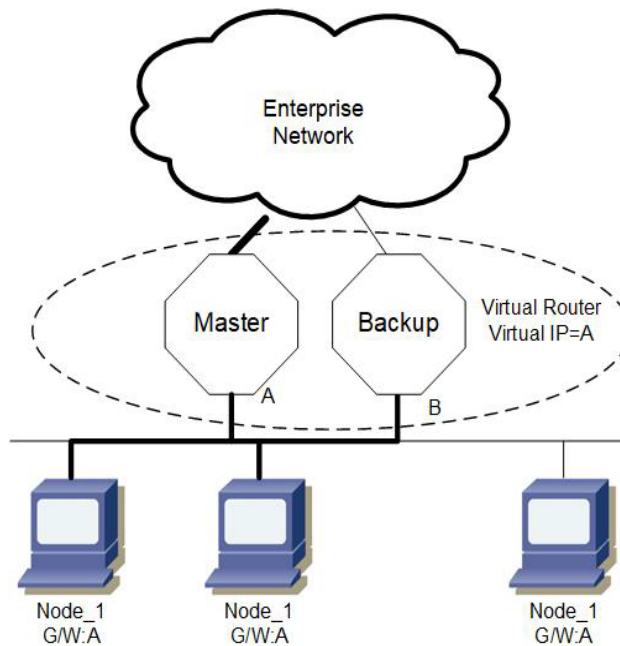

Figure 1-174: VRRP Process - Master and Backup VR

As shown in [Figure 1-175](#), if the Master router fails, one of the other routers (Backup) assumes forwarding responsibility for it.

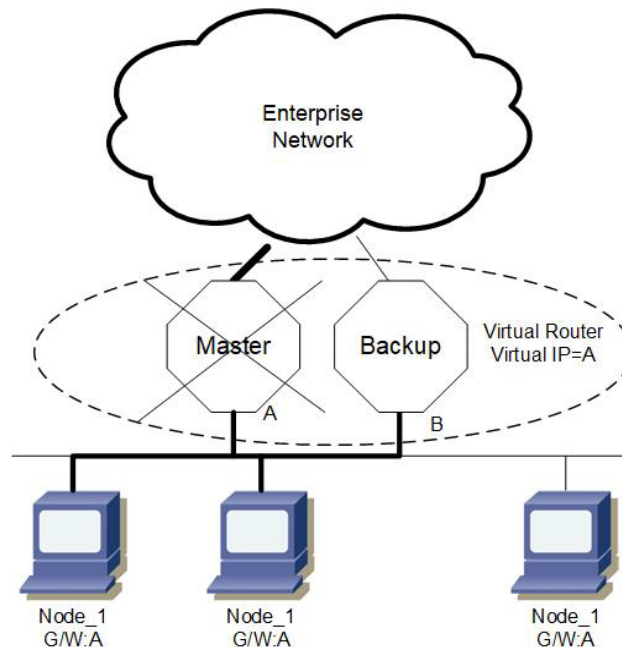

Figure 1-175: VRRP Process - Master Down and Backup Takeover

At first glance, the configuration in might not seem very useful, as it doubles the cost, and leaves one router idle at all times. This, however, can be avoided by creating two virtual routers and splitting the traffic between them.

Note: Adding a default route in the kernel on the interface that is used for VRRP might cause loss of network connectivity. According to the VRRP guidelines, when the VRRP session changes, the MAC address for the machine that attains the master state also changes. The change causes the default route from the kernel to disappear and leads to loss of connectivity. To avoid this situation, add the default route in the NSM and not in the kernel. This ensures that the default route remains on the machine across changes in the VRRP state.

To add default route through NSM, run the following command in NSM:

```
ip route 0.0.0.0/0 <IPADDRESS>
```

where <IPADDRESS> is the IP address of the default gateway.

One Virtual Router

In this configuration, the end-hosts install a default route to the IP address of virtual router 1 (VRID = 1), and both routers R1 and R2 run VRRP. R1 is configured to be the Owner for virtual router 1 (VRID = 1) and R2 as a Backup for virtual router 1. If R1 fails, R2 will take over virtual router 1 and its IP addresses, and provide uninterrupted service for the hosts. Configuring only one virtual router doubles the cost, and leaves R2 idle at all times.

Topology

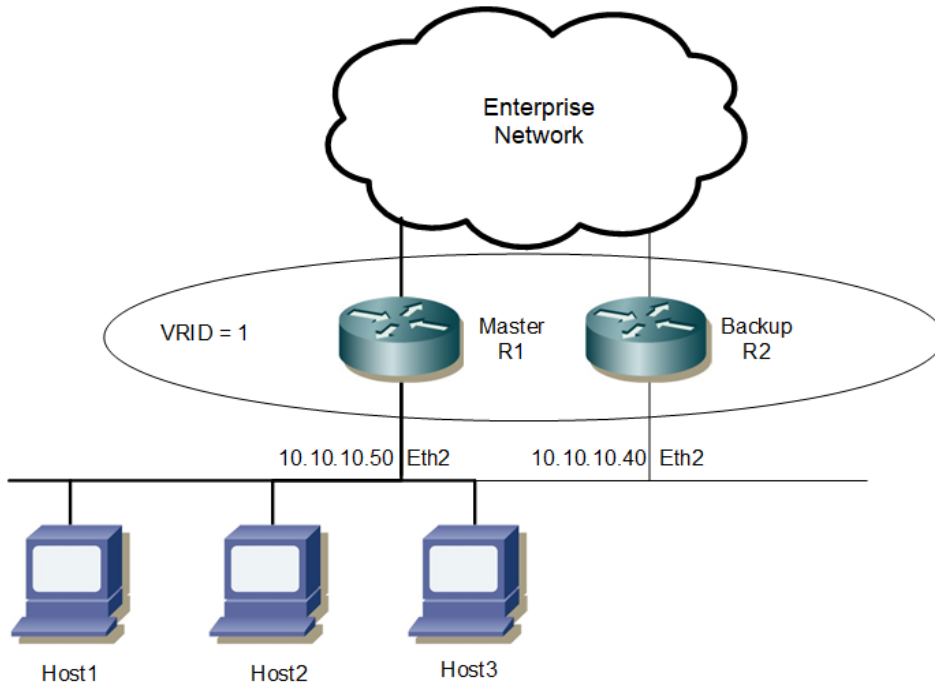

Figure 1-176: VRRP with One Virtual Router

R1

<code>#configure terminal</code>	Enter the Configure mode.
<code>(config)#router vrrp 1 eth2</code>	Create a VRRP instance for interface eth2.
<code>(config-router)#virtual-ip 10.10.10.50 owner</code>	Set the virtual IP address for the VRRP session. Define the default state (owner) of the VRRP router within the virtual router.
<code>(config-router)#preempt-mode true</code>	Set the preempt mode to specify that the highest priority will function as a backup to master when master is unavailable.
<code>(config-router)#advertisement-interval 100</code>	Configure the advertisement interval to 100 centi seconds (value must be a multiple of 5).
<code>(config-router)# v2-compatible</code>	Enable the v2-compatible
<code>(config-router)#authentication text abcd</code>	Configure the authentication text to specify that as simple text for vrrpv2 packets, accept only 8 characters
<code>(config-router)#enable</code>	Enable the VRRP session on the router.
<code>(config-router)#commit</code>	Commit the candidate configuration to the running configuration.
<code>(config-router)#exit</code>	Exit Router mode.

R2

<code>#configure terminal</code>	Enter the Configure mode.
<code>(config)#router vrrp 1 eth2</code>	Create a VRRP instance for interface eth2.
<code>(config-router)#virtual-ip 10.10.10.50</code>	Set the virtual IP address for the VRRP session.

(config-router)#priority 200	Configure the priority to 200 (less than 255), because R2 is the Backup router.
(config-router)#preempt-mode true	Set the preempt mode to specify that the highest priority will function as a backup to master when master is unavailable.
(config-router)#advertisement-interval 100	Configure the advertisement interval to 100 centi seconds (value must be a multiple of 5).
(config-router)# v2-compatible	Enable the v2-compatible
(config-router)#authentication text abcd	Configure the authentication text to specify that as simple text for vrrpv2 packets, accept only 8 characters
(config-router)#enable	Enable the VRRP session on the router.
(config-router)#commit	Commit the candidate configuration to the running configuration.
(config-router)#exit	Exit Router mode.

Validation

DUT

```
#sh vrrp
VRRP Version: 3
VMAC enabled
Backward Compatibility enabled
```

```
Address family IPv4
VRRP Id: 1 on interface: vlan1.1000
State: AdminUp - Master
Virtual IP address: 10.1.1.1 (Not-owner)
Virtual MAC address is 0000.5e00.0101
Operational primary IP address: 10.1.1.2
Operational master IP address: 10.1.1.2
Priority is 100
Advertisement interval: 100 centi sec
Master Advertisement interval: 100 centi sec
Virtual router uptime: 0 hours 1 minutes 52 seconds (11200 centi sec)
Master uptime: 0 hours 0 minutes 21 seconds (2100 centi sec)
Accept mode: TRUE
Preempt mode: TRUE
Multicast membership on IPv4 interface vlan1.1000: JOINED
V2-Compatible: TRUE
```

SD-1

```
#show vrrp
VRRP Version: 3
VMAC enabled
Backward Compatibility disabled
```

```
Address family IPv4
VRRP Id: 1 on interface: eth2
State: AdminUp - Backup
Virtual IP address: 10.10.10.1 (Not-owner)
```

```
Virtual MAC address is 0000.5e00.0101
Operational primary IP address: 10.10.10.40
Operational master IP address: 10.10.10.50
Priority is 90
Advertisement interval: 100 centi sec
Master Advertisement interval: 100 centi sec
Virtual router uptime: 0 hours 0 minutes 29 seconds (2900 centi sec)
Skew time: 80 centi sec
Master Down Interval: 380 centi sec
Accept mode: TRUE
Preempt mode: TRUE
Auth-type: simple text, String: abcd
Multicast membership on IPv4 interface eth2: JOINED
V2-Compatible: TRUE
```

Two Virtual Routers

In the previous, one virtual router example, R2 is not backed up by R1. This example illustrates how to back up R2 by configuring a second virtual router. In this configuration, R1 and R2 are two virtual routers, and the hosts split their traffic between R1 and R2. R1 and R2 function as backups for each other.

Topology

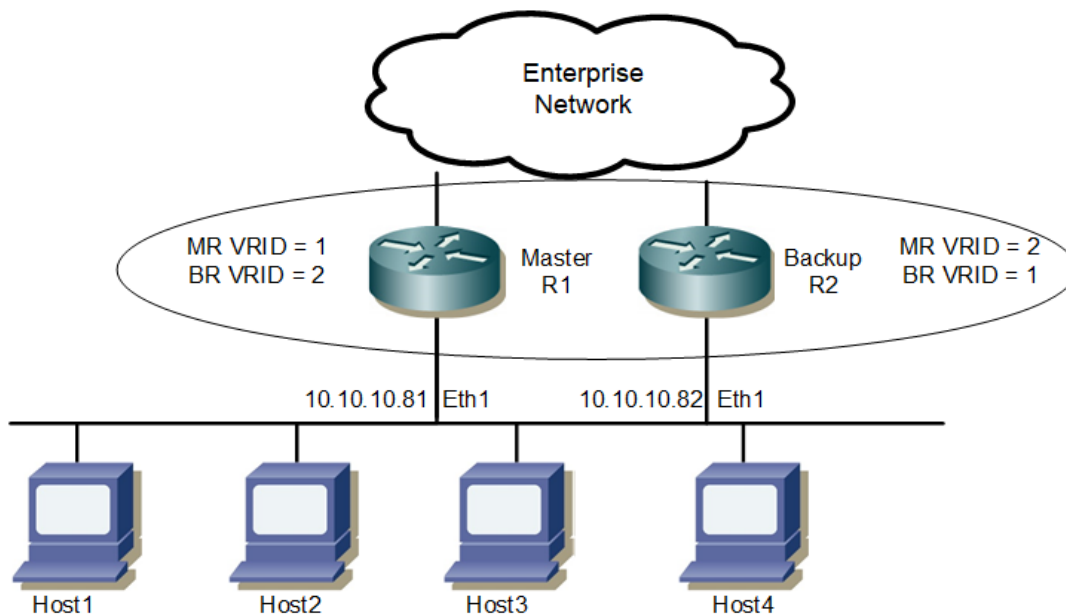

Figure 1-177: Configuring VRRP with Two Virtual Routers

R1

#configure terminal	Enter the Configure mode.
(config)#router vrrp 1 xe1	Create a VRRP instance for interface xe1.

(config-router)#virtual-ip 10.10.10.81 owner	Set the virtual IP address for the VRRP session. Define the default state (owner) of the VRRP router within the virtual router.
(config-router)#preempt-mode true	Set the preempt mode to specify that the highest priority will function as a backup to master when master is unavailable.
(config-router)#advertisement-interval 100	Configure the advertisement interval to 100 centi seconds (value must be a multiple of 5).
(config-router)# v2-compatible	Enable the v2-compatible
(config-router)#authentication text abcd	Configure the authentication text to specify that as simple text for vrrpv2 packets, accept only 8 characters
(config-router)#enable	Enable the VRRP session 1 on the router.
(config-router)#commit	Commit the candidate configuration to the running configuration.
(config-router)#exit	Exit Router mode and enter the Configure mode.
(config)#router vrrp 2 xe1	Create a VRRP instance for interface xe1.
(config-router)#virtual-ip 10.10.10.82	Set the virtual IP address for the VRRP session.
(config-router)#priority 200	Configure the priority to 200 (less than 255), because R2 is the Backup router.
(config-router)#preempt-mode true	Set the preempt mode to specify that the highest priority will function as a backup to master when master is unavailable.
(config-router)#advertisement-interval 100	Configure the advertisement interval to 100 centi seconds (value must be a multiple of 5).
(config-router)# v2-compatible	Enable the v2-compatible
(config-router)#authentication text abcd	Configure the authentication text to specify that as simple text for vrrpv2 packets, accept only 8 characters
(config-router)#enable	Enable the VRRP session two on the router.
(config-router)#commit	Commit the candidate configuration to the running configuration.
(config-router)#exit	Exit Router mode.

R2

#configure terminal	Enter the Configure mode.
(config)#router vrrp 1 xe1	Create a VRRP instance for interface xe1.
(config-router)#virtual-ip 10.10.10.81	Set the virtual IP address for the VRRP session.
(config-router)#priority 200	Configure the priority to 200 (less than 255), because R2 is the Backup router.
(config-router)#preempt-mode true	Set the preempt mode to specify that the highest priority will function as a backup to master when master is unavailable.
(config-router)#advertisement-interval 100	Configure the advertisement interval to 100 centi seconds (value must be a multiple of 5).
(config-router)# v2-compatible	Enable the v2-compatible
(config-router)#authentication text abcd	Configure the authentication text to specify that as simple text for vrrpv2 packets, accept only 8 characters
(config-router)#enable	Enable the VRRP session 1 on the router.
(config-router)#commit	Commit the candidate configuration to the running configuration.

VRRP Configuration

<code>(config-router)#exit</code>	Exit the Router mode and enter the Configure mode.
<code>(config)#router vrrp 2 xe1</code>	Create a VRRP instance for interface xe1
<code>(config-router)#virtual-ip 10.10.10.82 owner</code>	Set the virtual IP address for the VRRP session. Define the default state (owner) of the VRRP router within the virtual router.
<code>(config-router)#preempt-mode true</code>	Set the preempt mode to specify that the highest priority will function as a backup to master when master is unavailable.
<code>(config-router)#advertisement-interval 100</code>	Configure the advertisement interval to 100 centi seconds (value must be a multiple of 5).
<code>(config-router)# v2-compatible</code>	Enable the v2-compatible
<code>(config-router)#authentication text abcd</code>	Configure the authentication text to specify that as simple text for vrrpv2 packets, accept only 8 characters
<code>(config-router)#enable</code>	Enable the VRRP session two on the router.
<code>(config-router)#commit</code>	Commit the candidate configuration to the running configuration.
<code>(config-router)#exit</code>	Exit Router mode.

Validation

The following outputs on R1 and R2 display the complete configuration for each session on R1 and R2. In session one, R1 is the master router, and in session two R2 is the master router.

R1

```
R1#sh vrrp 1 eth1 VRRP Version: 3 VMAC enabled
Backward Compatibility disabled
```

```
Address family IPv4
VRRP Id: 1 on interface: xe1
State: AdminUp- Master
Virtual IP address: 10.10.10.81 (Owner)
Virtual MAC address is 0000.5e00.0101
Operational primary IP address: 10.10.10.81
Operational master IP address: 10.10.10.81
Priority is 255
Advertisement interval: 100 centi sec
Master Advertisement interval: 100 centi sec
Virtual router uptime: 0 hours 1 minutes 25 seconds (8500 centi sec)
Master uptime: 0 hours 1 minutes 18 seconds (7800 centi sec)
Accept mode: FALSE Preempt mode: TRUE
Auth-type: simple text, String: abcd
Multicast membership on IPv4 interface eth1: JOINED V2-Compatible: TRUE
```

```
R1#sh vrrp 2 eth1 VRRP Version: 3 VMAC enabled
Backward Compatibility disabled
```

```
Address family IPv4
VRRP Id: 2 on interface: xe1
State: AdminUp- Backup
Virtual IP address: 10.10.10.82 (Not-owner)
```

```
Virtual MAC address is 0000.5e00.0102
Operational primary IP address: 10.10.10.81
Operational master IP address: 10.10.10.82 Priority is 200
Advertisement interval: 100 centi sec
Master Advertisement interval: 100 centi sec
Virtual router uptime: 0 hours 2 minutes 3 seconds (12300 centi sec)
Skew time: 80 centi sec
Master Down Interval: 380 centi sec
Accept mode: FALSE Preempt mode: TRUE
Auth-type: simple text, String: abcd
Multicast membership on IPv4 interface eth1: JOINED V2-Compatible: TRUE
```

R2

```
R2#sh vrrp 1 eth1 VRRP Version: 3 VMAC enabled
Backward Compatibility disabled
```

```
Address family IPv4
VRRP Id: 1 on interface: xe1
State: AdminUp- Backup
Virtual IP address: 10.10.10.81 (Not-owner)
Virtual MAC address is 0000.5e00.0101
Operational primary IP address: 10.10.10.82
Operational master IP address: 10.10.10.81
Priority is 200
Advertisement interval: 100 centi sec
Master Advertisement interval: 100 centi sec
Virtual router uptime: 0 hours 0 minutes 37 seconds (3700 centi sec)
Skew time: 80 centi sec
Master Down Interval: 380 centi sec
Accept mode: FALSE Preempt mode: TRUE
Auth-type: simple text, String: abcd
Multicast membership on IPv4 interface eth1: JOINED
V2-Compatible: TRUE
```

```
R2#sh vrrp 2 eth1 VRRP Version: 3 VMAC enabled
Backward Compatibility disabled
```

```
Address family IPv4
VRRP Id: 2 on interface: xe1
State: AdminUp- Master
Virtual IP address: 10.10.10.82 (Owner)
Virtual MAC address is 0000.5e00.0102
Operational primary IP address: 10.10.10.82
Operational master IP address: 10.10.10.82 Priority is 255
Advertisement interval: 100 centi sec
Master Advertisement interval: 100 centi sec
Virtual router uptime: 0 hours 0 minutes 12 seconds (1200 centi sec)
Master uptime: 0 hours 1 minutes 18 seconds (7800 centi sec)
Accept mode: FALSE
```

```
Preempt mode: TRUE
Auth-type: simple text, String: abcd
Multicast membership on IPv4 interface eth1: JOINED
V2-Compatible: TRUE
```

R2#

Two Backup Routers

In this configuration, Host B could be a gateway router. As such, interface eth1 on Routers R1, R2, and R3, and the gateway router, would run the IGP protocol.

Topology

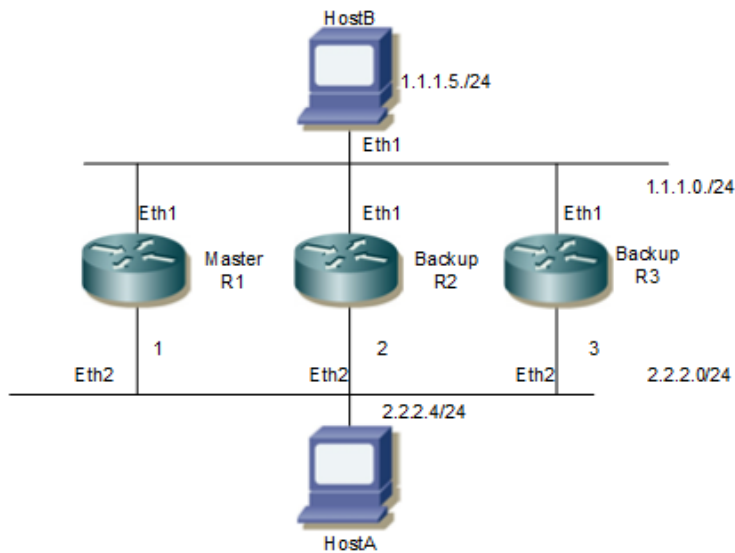

Figure 1-178: Configuring VRRP with Two Backup Routers

R1

#configure terminal	Enter the Configure mode.
(config)#interface eth2	Enter interface mode for eth2.
(config-if)#ip address 2.2.2.1/24	Configure the IP address for interface eth2 to be in network 0.
(config-if)#commit	Commit the candidate configuration to the running configuration.
(config-if)#exit	Exit interface mode.
(config)#interface eth1	Enter interface mode for eth1.
(config-if)#ip address 1.1.1.1/24	Configure the IP address for interface eth1 to be in network 1.
(config-if)#commit	Commit the candidate configuration to the running configuration.
(config-if)#exit	Exit interface mode.

(config)#router vrrp 1 eth2	Create a VRRP instance for interface eth2.
(config-router)#virtual-ip 2.2.2.1 owner	Configure R1 as the owner.
(config-router)#advertisement-interval 100	Configure the default value for the advertisement interval. The configurable range is 5 to 4095 centi seconds (value must be a multiple of 5).
(config-router)#preempt-mode true	Set true as the default value for the field.
(config-router)# v2-compatible	Enable the v2-compatible
(config-router)#authentication text abcd	Configure the authentication text to specify that as simple text for vrrpv2 packets, accept only 8 characters
(config-router)#enable	Enable the VRRP session on the router.
(config-router)#commit	Commit the candidate configuration to the running configuration.
(config-router)#exit	Exit Router mode.

R2

#configure terminal	Enter the Configure mode.
(config)#interface eth2	Enter interface mode for eth2.
(config-if)#ip address 2.2.2.2/24	Configure the IP address for interface eth2 to be in network 0.
(config-if)#commit	Commit the candidate configuration to the running configuration.
(config-if)#exit	Exit interface mode.
(config)#interface eth1	Enter interface mode for eth1.
(config-if)#ip address 1.1.1.2/24	Configure the IP address for interface eth1 to be in network 1.
(config-if)#commit	Commit the candidate configuration to the running configuration.
(config-if)#exit	Exit interface mode.
(config)#router vrrp 1 eth2	Create a VRRP instance for interface eth2.
(config-router)#virtual-ip 2.2.2.1	Configure R2 as the backup.
(config-router)#advertisement-interval 100	Configure the default value for the advertisement interval. The configurable range is 5 to 4095 centi seconds (value must be a multiple of 5).
(config-router)#priority 100	Set the default value for the backup router.
(config-router)#preempt-mode true	Set true as the default value for the field.
(config-router)# v2-compatible	Enable the v2-compatible
(config-router)#authentication text abcd	Configure the authentication text to specify that as simple text for vrrpv2 packets, accept only 8 characters
(config-router)#enable	Enable the VRRP session on the router.
(config-router)#commit	Commit the candidate configuration to the running configuration.
(config-router)#exit	Exit Router mode.

R3

#configure terminal	Enter the Configure mode.
(config)#interface eth2	Enter interface mode for eth2.
(config-if)#ip address 2.2.2.3/24	Configure the IP address for interface eth2 to be in network 0.
(config-if)#commit	Commit the candidate configuration to the running configuration.
(config-if)#exit	Exit interface mode.
(config)#interface eth1	Enter interface mode for eth1.
(config-if)#ip address 1.1.1.3/24	Configure the IP address for interface eth1 to be in network 1.
(config-if)#commit	Commit the candidate configuration to the running configuration.
(config-if)#exit	Exit interface mode.
(config)#router vrrp 1 eth2	Create a VRRP instance for interface eth2.
(config-router)#virtual-ip 2.2.2.1	Configure R3 as the backup.
(config-router)#advertisement-interval 100	Configure the default value for the advertisement interval. The configurable range is 5 to 4095 centi seconds (value must be a multiple of 5).
(config-router)#priority 254	Configure the priority for R3. The configurable range is 1-255.
(config-router)#preempt-mode true	Set true as the default value for the field.
(config-router)# v2-compatible	Enable the v2-compatible
(config-router)#authentication text abcd	Configure the authentication text to specify that as simple text for vrrpv2 packets, accept only 8 characters
(config-router)#enable	Enable the VRRP session on the router.
(config-router)#commit	Commit the candidate configuration to the running configuration.
(config-router)#exit	Exit Router mode.

Validation**Router 1**

```

R1#show vrrp
VRRP Version: 3
VMAC enabled
Backward Compatibility disabled

Address family IPv4
VRRP Id: 1 on interface: eth2
State: AdminUp - Master
Virtual IP address: 2.2.2.1 (Owner)
Virtual MAC address is 0000.5e00.0101
Operational primary IP address: 2.2.2.1
Operational master IP address: 2.2.2.1
Priority is 255
Advertisement interval: 100 centi sec

```

```
Master Advertisement interval: 100 centi sec
Virtual router uptime: 0 hours 9 minutes 6 seconds (54600 centi sec)
Master uptime: 0 hours 1 minutes 18 seconds (7800 centi sec)
Accept mode: TRUE
Preempt mode: TRUE
Auth-type: simple text, String: abcd
Multicast membership on IPv4 interface eth2: JOINED
V2-Compatible: TRUE
```

Router 2

```
R2#sh vrrp
VRRP Version: 3
VMAC enabled
Backward Compatibility disabled
```

```
Address family IPv4
VRRP Id: 1 on interface: eth2
State: AdminUp - Backup
Virtual IP address: 2.2.2.1 (Not-owner)
Virtual MAC address is 0000.5e00.0101
Operational primary IP address: 2.2.2.2
Operational master IP address: 2.2.2.1
Priority is 100
Advertisement interval: 100 centi sec
Master Advertisement interval: 100 centi sec
Virtual router uptime: 0 hours 11 minutes 28 seconds (68800 centi sec)
Skew time: 80 centi sec
Master Down Interval: 380 centi sec
Accept mode: TRUE
Preempt mode: TRUE
Auth-type: simple text, String: abcd
Multicast membership on IPv4 interface eth2: JOINED
V2-Compatible: TRUE
```

Router 3

```
R3#sh vrrp
VRRP Version: 3
VMAC enabled
Backward Compatibility disabled
```

```
Address family IPv4
VRRP Id: 1 on interface: eth2
State: AdminUp - Backup
Virtual IP address: 2.2.2.1 (Not-owner)
Virtual MAC address is 0000.5e00.0101
Operational primary IP address: 2.2.2.3
Operational master IP address: 2.2.2.1
Priority is 254
Advertisement interval: 100 centi sec
Master Advertisement interval: 100 centi sec
Virtual router uptime: 0 hours 14 minutes 23 seconds (86300 centi sec)
Skew time: 80 centi sec
Master Down Interval: 380 centi sec
Accept mode: TRUE
Preempt mode: TRUE
Auth-type: simple text, String: abcd
```

```
Multicast membership on IPv4 interface eth2: JOINED
V2-Compatible: TRUE
```

Ping Output at Host A

```
HOSTA#ping 1.1.1.5
Press CTRL+C to exit
PING 1.1.1.5 (1.1.1.5) 56(84) bytes of data.
64 bytes from 1.1.1.5: icmp_seq=1 ttl=63 time=1.40 ms
64 bytes from 1.1.1.5: icmp_seq=2 ttl=63 time=1.09 ms
```

Disabling the Master/Owner

#configure terminal	Enter the Configure mode.
(config)#router vrrp 1 eth2	Create a VRRP instance for interface eth2.
(config-router)#disable	Disable the VRRP session.
(config-router)#commit	Commit the candidate configuration to the running configuration.
(config-router)#exit	Exit Router mode.

Output After Disabling the Master

Router 1

```
R1#sh vrrp
VRRP Version: 3
VMAC enabled
Backward Compatibility disabled
```

```
Address family IPv4
```

```
VRRP Id: 1 on interface: eth2
```

```
State: AdminDown - Init (admin state down)
```

```
Virtual IP address: 2.2.2.1 (Owner)
```

```
Virtual MAC address is 0000.5e00.0101
```

```
Operational primary IP address: 2.2.2.1
```

```
Operational master IP address: 2.2.2.1
```

```
Priority is 255
```

```
Advertisement interval: 100 centi sec
```

```
Master Advertisement interval: 100 centi sec
```

```
Virtual router uptime: 0 hours 0 minutes 0 seconds (0 centi sec)
```

```
Skew time: 80 centi sec
```

```
Master Down Interval: 380 centi sec)
```

```
Accept mode: TRUE
```

```
Preempt mode: TRUE
```

```
Auth-type: simple text, String: abcd
```

```
Multicast membership on IPv4 interface eth2: LEFT
```

```
V2-Compatible: TRUE
```

Router 3

```
R3#sh vrrp
```

```
VRRP Version: 3
```

```
VMAC enabled
Backward Compatibility disabled
```

```
Address family IPv4
```

```
VRRP Id: 1 on interface: eth2
```

```
State: AdminUp - Master
```

```
Virtual IP address: 2.2.2.1 (Not-owner)
```

```
Virtual MAC address is 0000.5e00.0101
```

```
Operational primary IP address: 2.2.2.3
```

```
Operational master IP address: 2.2.2.3
```

```
Priority is 254
```

```
Advertisement interval: 100 centi sec
```

```
Master Advertisement interval: 100 centi sec
```

```
Virtual router uptime: 0 hours 40 minutes 55 seconds (245500 centi sec)
```

```
Master uptime: 0 hours 1 minutes 18 seconds (7800 centi sec)
```

```
Accept mode: TRUE
```

```
Preempt mode: TRUE
```

```
Auth-type: simple text, String: abcd
```

```
Multicast membership on IPv4 interface eth2: JOINED
```

```
V2-Compatible: TRUE
```

```
HOSTA#ping 1.1.1.5
```

```
Press CTRL+C to exit
```

```
PING 1.1.1.5 (1.1.1.5) 56(84) bytes of data.
```

```
64 bytes from 1.1.1.5: icmp_seq=1 ttl=63 time=1.40 ms
```

```
64 bytes from 1.1.1.5: icmp_seq=2 ttl=63 time=1.09 m
```

Interface Tracking

The need for VRRP Interface Tracking arose because VRRPv3 was unable to track the gateway interface status. The VRRP Interface Tracking feature provides dynamic failover of an entire circuit, in the event that one member of the group fails. It introduces the concept of a circuit, where two or more Virtual Routers on a single system can be grouped. In the event that a failure occurs, and one of the Virtual Routers performs the Master to Backup transition, the other Virtual Routers in the group are notified, and are forced into the Master to Backup transition, so that both incoming and outgoing packets are routed through the same gateway router, eliminating the problem for Firewall/NAT environments.

Note: VRRP Interface Tracking feature allows you to track the state of an upstream Interface and update the VRRP router priority accordingly. Up to 5 interfaces can be tracked per VRRP session for upstream interfaces and Interface tracking will be disabled when the session is the owner of the VIP.

To configure VRRP Interface Tracking, each circuit is configured to have a corresponding priority-delta value, which is passed to VRRP when a failure occurs. The priority of each Virtual Router on the circuit is decremented by the priority-delta value, causing the VR Master to VR Backup transition.

In this example, two routers, R1 and R2, are configured as backup routers with different priorities. The priority-delta value is configured to be greater than the difference of both the priorities. R1 is configured to have a priority of 150, and R2 has a priority of 50. R1, with a greater priority, is the Virtual Router Master. The priority-delta value is 110, greater than 100 (150 minus 50). On R1, when the external interface xe41, xe50/1 and xe50/2 fails, the priority of R1 becomes 40 (150 minus 110). Since R2 has a greater priority (50) than R1, R2 becomes the VR Master, and routing of packages continues without interruption. When this VR Backup (R1) is up again, it regains its original priority (150), and becomes the VR Master again.

Topology

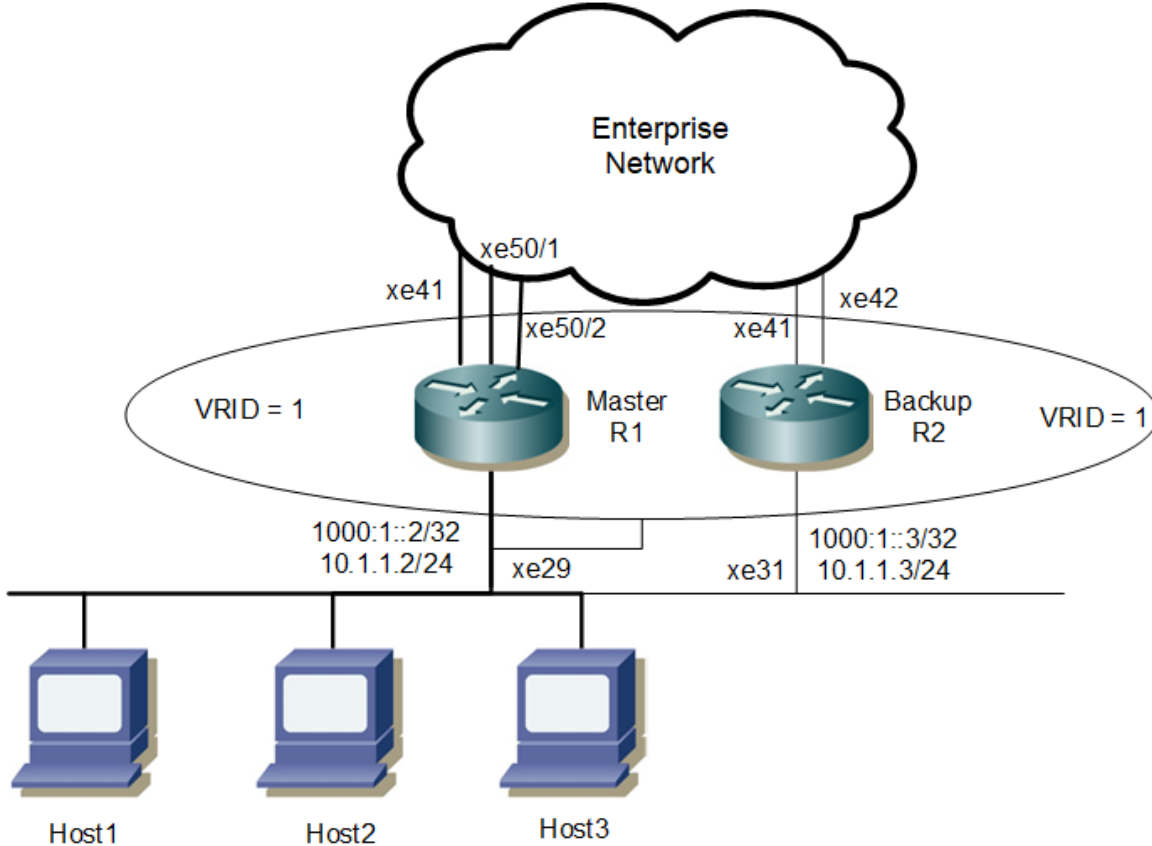

Figure 1-179: VRRP Interface Tracking

R1

(config)#configure terminal	Enter the Configure mode.
(config)#bridge 1 protocol rstp vlan-bridge	Create a RSTP VLAN aware bridge.
(config)#vlan 1001-1002 bridge 1	Create VLAN 1001,1002 and map it to bridge 1.
(config)#interface xe29	Enter interface mode.
(config-if)#switchport	Configure switch port.
(config-if)#bridge-group 1 spanning-tree disable	Configure bridge group to I2 interface with spanning-tree Disable.
(config-if)#switchport mode trunk	Configure switch port mode as trunk.
(config-if)#switchport trunk allowed vlan add 1001,1002	Allow vlan 1001 ,1002 on the interface.
(config-if)#interface vlan1.1001	Enter the vlan interface
(config-if)#ip address 10.1.1.2/24	Configure ipv4 address
(config-if)#ipv6 address 1000:1::2/32	Configure ipv6 address
(config-if)#ipv6 router ospf area 0.0.0.0	Tag ospfv3 instance on interface with area 0
(config-if)#exit	Exit the interface mode
(config)#router vrrp 1 vlan1.1001	Create a new ipv4 VRRP instance for interface vlan1.1001

(config-router)#virtual-ip 10.1.1.1	Set the virtual IP address for the VRRP session
(config-router)#priority 150	Configure the priority to 150
(config-router)#circuit-failover xe41 70	Configure the priority-delta value to be 70. In case of failover, this priority-delta value is subtracted from the current VR Master.
(config-router)#circuit-failover xe50/1 10	Configure the priority-delta value to be 10. In case of failover, this priority-delta value is subtracted from the current VR Master.
(config-router)#circuit-failover xe50/2 30	Configure the priority-delta value to be 10. In case of failover, this priority-delta value is subtracted from the current VR Master.
(config-router)#v2-compatible	Enable the v2-compatible
(config-router)#authentication text abcd	Configure the authentication text to specify that as simple text for vrrpv2 packets, accept only 8 characters.
(config-router)#enable	Enable the VRRP session on the router.
(config-router)#commit	Commit the configuration on the node
(config-router)#exit	Exit the router mode.
(config)#router ipv6 vrrp 1 vlan1.1001	Create a new ipv6 VRRP instance for interface vlan1.1001.
(config-router)#virtual-ipv6 fe80::1	Set the virtual IPv6 address for the VRRP session.
(config-router)#priority 150	Configure the priority to 150
(config-router)#circuit-failover xe41 70	Configure the priority-delta value to be 70. In case of failover, this priority-delta value is subtracted from the current VR Master.
(config-router)#circuit-failover xe50/1 10	Configure the priority-delta value to be 10. In case of failover, this priority-delta value is subtracted from the current VR Master.
(config-router)#circuit-failover xe50/2 30	Configure the priority-delta value to be 10. In case of failover, this priority-delta value is subtracted from the current VR Master.
(config-router)#enable	Enable the VRRP session on the router.
(config-router)#commit	Commit the configuration on the node
(config-router)#exit	Exit the router mode
(config)#interface xe50/1	Enter interface mode
(config-if)#ip address 20.1.1.1/24	Configure ipv4 address
(config-if)#ipv6 address 2000::1/64	Configure ipv6 address
(config-if)#ipv6 router ospf area 0.0.0.0	Tag ospfv3 instance on interface with area 0
(config-if)#interface xe50/2	Enter interface mode
(config-if)#ip address 30.1.1.1/24	Configure ipv4 address
(config-if)#ipv6 address 3000::1/64	Configure ipv6 address
(config-if)#ipv6 router ospf area 0.0.0.0	Tag ospfv3 instance on interface with area 0
(config-if)#interface xe41	Enter interface mode
(config-if)#ip address 60.1.1.1/24	Configure ipv4 address
(config-if)#ipv6 address 6000::1/64	Configure ipv6 address
(config-if)#ipv6 router ospf area 0.0.0.0	Tag ospfv3 instance on interface with area 0

VRRP Configuration

(config-if)#commit	Commit the configuration on the node
(config-if)#exit	Exit interface and configure mode

R2

(config)#bridge 1 protocol rstp vlan-bridge	Create a RSTP VLAN aware bridge with bridge-id.
(config)#vlan 1001-1002 bridge 1	Create VLAN 1001,1002 and map it to bridge 1
(config)#interface xe31	Enter interface mode
(config-if)#switchport	Configure switch port
(config-if)#bridge-group 1 spanning-tree disable	Configure bridge group to I2 interface with spanning-tree Disable
(config-if)#switchport mode trunk	Configure switch port mode as trunk
(config-if)#switchport trunk allowed vlan add 1001,1002	Allow vlan 1001 ,1002 on the interface
(config-if)#interface vlan1.1001	Enter the vlan interface
(config-if)#ip address 10.1.1.3/24	Configure ipv4 address
(config-if)#ipv6 address 1000:1::3/32	Configure ipv6 address
(config-if)#ipv6 router ospf area 0.0.0.0	Tag ospfv3 instance on interface with area 0
(config-if)#commit	Commit the configuration on the node
(config-if)#exit	Exit interface mode
(config)#router vrrp 1 vlan1.1001	Create a router ipv4 VRRP instance for interface vlan1.1001.
(config-router)#virtual-ip 10.1.1.1	Set the virtual IP address for the VRRP session.
(config-router)#priority 50	Configure the priority to 50 (less than 150), because R2 is the VR Backup router.
(config-router)#v2-compatible	Enable the v2-compatible
(config-router)#authentication text abcd	Configure the authentication text to specify that as simple text for vrrpv2 packets, accept only 8 characters.
(config-router)#enable	Enable the VRRP session
(config-router)#commit	Commit the configuration on the node
(config-router)#exit	Exit the router mode
(config)#router ipv6 vrrp 1 vlan1.1001	Create a router ipv6 VRRP ipv6 instance for interface vlan1.1001.
(config-router)#virtual-ipv6 fe80::1	Set the virtual IPv6 address for the VRRP session.
(config-router)#priority 50	Configure the priority to 50 (less than 150), because R2 is the VR Backup router.
(config-router)#commit	Commit the configuration on the node
(config-router)#exit	Exit the router mode
(config)#interface xe41	Enter interface mode
(config-if)#ip address 80.1.1.1/24	Configure ipv4 address
(config-if)#ipv6 address 8000::1/64	Configure ipv6 address
(config-if)#ipv6 router ospf area 0.0.0.0	Tag ospfv3 instance on interface with area 0
(config-if)#interface xe42	Enter interface mode
(config-if)#ip address 90.1.1.1/24	Enter the tracked interface

(config-if)#ipv6 address 9000::1/64	Configure ipv6 address
(config-if)#ipv6 router ospf area 0.0.0.0	Tag ospfv3 instance on interface with area 0
(config-if)#commit	Commit the configuration on the node
(config-if)#exit	Exit interface and configure mode

Validation

```
R1# show vrrp 1 vlan1.1001
VRRP Version: 3
VMAC enabled
Backward Compatibility disabled
Address family IPv4
VRRP Id: 1 on interface: vlan1.1001
State: AdminUp - Master
Virtual IP address: 10.1.1.1 (Not-owner)
Virtual MAC address is 0000.5e00.0101
Operational primary IP address: 10.1.1.2
Operational master IP address: 10.1.1.2
Configured priority: 150, Current priority: 150
Advertisement interval: 100 centi sec
Master Advertisement interval: 100 centi sec
Virtual router uptime: 0 hours 1 minutes 12 seconds (7200 centi sec)
Master uptime: 0 hours 2 minutes 34 seconds (15400 centi sec)
Accept mode: TRUE
Preempt mode: TRUE
Monitored circuit: xe41, Priority Delta: 70, Status: UP
Monitored circuit: xe50/1, Priority Delta: 10, Status: UP
Monitored circuit: xe50/2, Priority Delta: 30, Status: UP
Auth-type: simple text, String: abcd
Multicast membership on IPv4 interface vlan1.1001: JOINED V
2-Compatible: TRUE
```

```
R1#
R2#show vrrp 1 vlan1.1001
VRRP Version: 3
VMAC enabled
Backward Compatibility disabled
Address family IPv4
VRRP Id: 1 on interface: vlan1.1001
State: AdminUp - Backup
Virtual IP address: 10.1.1.1 (Not-owner)
Virtual MAC address is 0000.5e00.0101
Operational primary IP address: 10.1.1.3
Operational master IP address: 10.1.1.2
Priority is 50
Advertisement interval: 100 centi sec
Master Advertisement interval: 100 centi sec
Virtual router uptime: 7 hours 52 minutes 53 seconds (2837300 centi sec)
Skew time: 80 centi sec
Master Down Interval: 380 centi sec
Accept mode: TRUE
Preempt mode: TRUE
Auth-type: simple text, String: abcd
Multicast membership on IPv4 interface vlan1.1001: JOINED
V2-Compatible: TRUE
```

```
R2#
R1#show vrrp ipv6 1 vlan1.1001
VRRP Version: 3
VMAC enabled
Backward Compatibility disabled
Address family IPv6
VRRP Id: 1 on interface: vlan1.1001
  State: AdminUp - Master
  Virtual IP address: fe80::1 (Not-owner)
  Virtual MAC address is 0000.5e00.0201
  Operational primary IP address: fe80::ba6a:97ff:fe3c:de9d
  Operational master IP address: fe80::ba6a:97ff:fe3c:de9d
  Configured priority: 150, Current priority: 150
  Advertisement interval: 100 centi sec
  Master Advertisement interval: 100 centi sec
  Virtual router uptime: 0 hours 3 minutes 54 seconds (23400 centi sec)
  Master uptime: 0 hours 2 minutes 34 seconds (15400 centi sec)
  Accept mode: TRUE
  Preempt mode: TRUE
  Monitored circuit: xe41, Priority Delta: 70, Status: UP
  Monitored circuit: xe50/1, Priority Delta: 10, Status: UP
  Monitored circuit: xe50/2, Priority Delta: 30, Status: UP
  Multicast membership on IPv6 interface vlan1.1001: JOINED
  V2-Compatible: FALSE
R1#
R2#show vrrp ipv6 1 vlan1.1001
VRRP Version: 3
VMAC enabled
Backward Compatibility disabled
Address family IPv6
VRRP Id: 1 on interface: vlan1.1001
  State: AdminUp - Backup
  Virtual IP address: fe80::1 (Not-owner)
  Virtual MAC address is 0000.5e00.0201
  Operational primary IP address: fe80::82a2:35ff:fe35:135f
  Operational master IP address: fe80::ba6a:97ff:fe3c:de9d
  Priority is 50
  Advertisement interval: 100 centi sec
  Master Advertisement interval: 100 centi sec
  Virtual router uptime: 7 hours 55 minutes 11 seconds (2851100 centi sec)
  Skew time: 80 centi sec
  Master Down Interval: 380 centi sec
  Accept mode: TRUE
  Preempt mode: TRUE
  Multicast membership on IPv6 interface vlan1.1001: JOINED
  V2-Compatible: FALSE
R2#
After shut down of all tracked interfaces (xe50/1, xe50/2 and xe41) in R1:
R1#show vrrp 1 vlan1.1001
VRRP Version: 3
VMAC enabled
Backward Compatibility disabled
Address family IPv4
VRRP Id: 1 on interface: vlan1.1001
  State: AdminUp - Backup
  Virtual IP address: 10.1.1.1 (Not-owner)
```

```
Virtual MAC address is 0000.5e00.0101
Operational primary IP address: 10.1.1.2
Operational master IP address: 10.1.1.3
Configured priority: 150, Current priority: 40
Advertisement interval: 100 centi sec
Master Advertisement interval: 100 centi sec
Virtual router uptime: 0 hours 7 minutes 46 seconds (46600 centi sec)
Skew time: 84 centi sec
Master Down Interval: 380 centi sec
Accept mode: TRUE
Preempt mode: TRUE
Monitored circuit: xe41, Priority Delta: 70, Status: DOWN
Monitored circuit: xe50/1, Priority Delta: 10, Status: DOWN
Monitored circuit: xe50/2, Priority Delta: 30, Status: DOWN
Auth-type: simple text, String: abcd
Multicast membership on IPv4 interface vlan1.1001: JOINED
V2-Compatible: TRUE
R1#
R2#show vrrp 1 vlan1.1001
VRRP Version: 3
VMAC enabled
Backward Compatibility disabled
Address family IPv4
VRRP Id: 1 on interface: vlan1.1001
State: AdminUp - Master
Virtual IP address: 10.1.1.1 (Not-owner)
Virtual MAC address is 0000.5e00.0101
Operational primary IP address: 10.1.1.3
Operational master IP address: 10.1.1.3
Priority is 50
Advertisement interval: 100 centi sec
Master Advertisement interval: 100 centi sec
Virtual router uptime: 7 hours 57 minutes 41 seconds (2866100 centi sec)
Master uptime: 0 hours 2 minutes 34 seconds (15400 centi sec)
Accept mode: TRUE
Preempt mode: TRUE
Multicast membership on IPv4 interface vlan1.1001: JOINED
V2-Compatible: FALSE
R2#
R1#show vrrp ipv6 1 vlan1.1001
VRRP Version: 3
VMAC enabled
Backward Compatibility disabled
Address family IPv6
VRRP Id: 1 on interface: vlan1.1001
State: AdminUp - Backup
Virtual IP address: fe80::1 (Not-owner)
Virtual MAC address is 0000.5e00.0201
Operational primary IP address: fe80::ba6a:97ff:fe3c:de9d
Operational master IP address: fe80::82a2:35ff:fe35:135f
Configured priority: 150, Current priority: 40
Advertisement interval: 100 centi sec
Master Advertisement interval: 100 centi sec
Virtual router uptime: 0 hours 8 minutes 43 seconds (52300 centi sec)
Skew time: 84 centi sec
Master Down Interval: 380 centi sec
Accept mode: TRUE
```

```
Preempt mode: TRUE
Monitored circuit: xe41, Priority Delta: 70, Status: DOWN
Monitored circuit: xe50/1, Priority Delta: 10, Status: DOWN
Monitored circuit: xe50/2, Priority Delta: 30, Status: DOWN
Multicast membership on IPv6 interface  vlan1.1001: JOINED
V2-Compatible: FALSE
R1#
R2#show vrrp ipv6 1 vlan1.1001
VRRP Version: 3
VMAC enabled
Backward Compatibility disabled
Address family IPv6
VRRP Id: 1 on interface: vlan1.1001
State: AdminUp   - Master
Virtual IP address: fe80::1 (Not-owner)
Virtual MAC address is 0000.5e00.0201
Operational primary IP address: fe80::82a2:35ff:fe35:135f
Operational master IP address: fe80::82a2:35ff:fe35:135f
Priority is 50
Advertisement interval: 100 centi sec
Master Advertisement interval: 100 centi sec
Virtual router uptime: 7 hours 59 minutes 4 seconds (2874400 centi sec)
Master uptime: 0 hours 2 minutes 34 seconds (15400 centi sec)
Accept mode: TRUE
Preempt mode: TRUE
Multicast membership on IPv6 interface  vlan1.1001: JOINED
V2-Compatible: FALSE
R2#
```

VRRP-Backward Compatibility

This section contains VRRP Backward Compatibility configuration examples.

The backward compatibility feature which implements version 3 of VRRP protocol recognizes the presence of VRRP version 2 compatible routers in the network and performs all operations normally. This support is intended for upgrade scenarios and is not recommended for permanent deployments. This should only occur when a router is transitioning from VRRPv2 to VRRPv3.

VRRP Backward Compatibility is applicable only for VRRP IPv4.

Topology

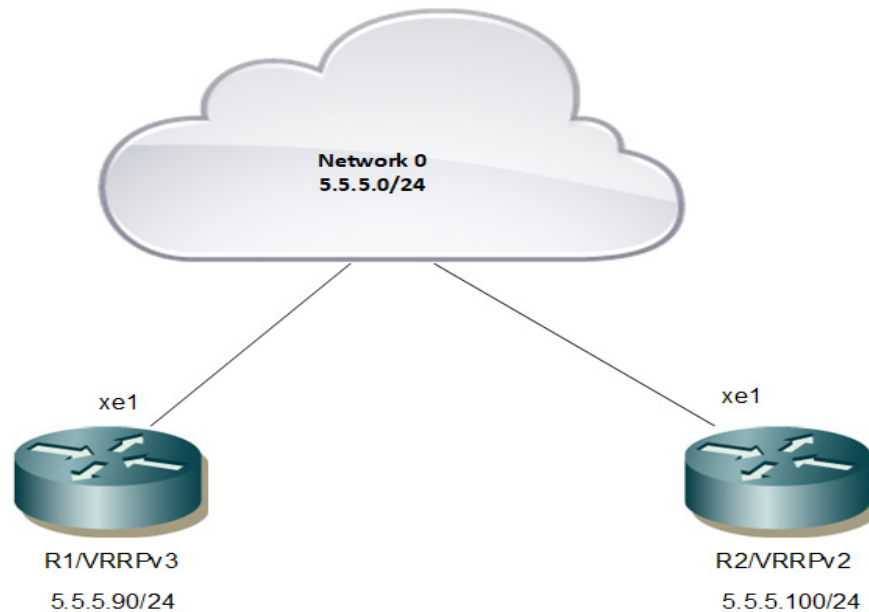

R1

#configure terminal	Enter the Configure mode.
(config)#interface xe1	Enter Interface configuration mode.
(config-if)#ip address 5.5.5.90/24	Configure IP address on the interface.
(config-if)#commit	Commit the candidate configuration to the running configuration.
(config-if)#exit	Exit Router mode.
(config)#router vrrp 1 xe1	Configure VRRP on DUT with Virtual router Identifier as 1 on the interface xe1.
(config-router)#virtual-ip 5.5.5.190	Configure Virtual-IP address as the interface IP address of Owner which is not actually present in the LAN.
(config-router)#v2-compatible	Enable the v2-compatible
(config-router)#authentication text abcd	Configure the authentication text to specify that as simple text for vrrpv2 packets, accept only 8 characters
(config-router)#enable	Enable VRRP session on DUT.
(config-router)#commit	Commit the candidate configuration to the running configuration.
(config-router)#exit	Exit Router mode.
(config)#vrrp compatible-v2 enable	Enable VRRP-Backward compatibility feature on a VRRPv3 running router.
(config-router)#commit	Commit the candidate configuration to the running configuration.
(config-router)#exit	Exit Router mode.

R2

#configure terminal	Enter the Configure mode.
(config)# interface xe1	Enter Interface configuration mode.
(config-if)#ip address 5.5.5.100/24	Configure IP address on the interface.
(config-if)#commit	Commit the candidate configuration to the running configuration.
(config-if)#exit	Exit Router mode.
(config)#router vrrp 1 xe1	Configure VRRP on DUT with Virtual router Identifier as 1 on the interface xe1.
(config-router)#virtual-ip 5.5.5.190	Configure Virtual-IP address as the interface IP address of Owner which is not actually present in the LAN.
(config-router)#v2-compatible	Enable the v2-compatible
(config-router)#authentication text abcd	Configure the authentication text to specify that as simple text for vrrpv2 packets, accept only 8 characters
(config-router)#enable	Enable VRRP session on DUT.
(config-router)#commit	Commit the candidate configuration to the running configuration.
(config-router)#exit	Exit Router mode.

Validation

R1

```
#sh vrrp
VRRP Version: 3
VMAC enabled
Backward Compatibility enabled
```

```
Address family IPv4
VRRP Id: 1 on interface: xe1
State: AdminUp - Master
Virtual IP address: 5.5.5.190 (Not-owner)
Virtual MAC address is 0000.5e00.0101
Operational primary IP address: 5.5.5.90
Operational master IP address: 5.5.5.90
Priority is 100
Advertisement interval: 100 centi sec
Master Advertisement interval: 100 centi sec
Virtual router uptime: 0 hours 2 minutes 32 seconds (15200 centi sec)
Master uptime: 0 hours 2 minutes 28 seconds (14800 centi sec)
Accept mode: TRUE
Preempt mode: TRUE
Auth-type: simple text, String: abcd
Multicast membership on IPv4 interface xe1: JOINED
V2-Compatible: TRUE
```

R2

```
#sh vrrp
```



```
VRRP Version: 3
VMAC enabled
Backward Compatibility disabled

Address family IPv4
VRRP Id: 1 on interface: xe1
State: AdminUp - Backup
Virtual IP address: 5.5.5.190 (Not-owner)
Virtual MAC address is 0000.5e00.0101
Operational primary IP address: 5.5.5.100
Operational master IP address: 5.5.5.90
Priority is 100
Advertisement interval: 100 centi sec
Master Advertisement interval: 100 centi sec
Virtual router uptime: 0 hours 1 minutes 11 seconds (7100 centi sec)
Skew time: 60 centi sec
Master Down Interval: 360 centi sec
Accept mode: TRUE
Preempt mode: TRUE
Auth-type: simple text, String: abcd
Multicast membership on IPv4 interface xe1: JOINED
V2-Compatible: TRUE
```

Redundancy Using VRRP and OSPF: Two Virtual Routers

This example illustrates a configuration of two routers between two end-hosts. R1 and R2 are two virtual routers functioning as backups for each other, with VRRP running on the 10.10.12.0/24 network (LAN), and OSPF running on the 10.10.10.0/24 network (ISP).

Topology

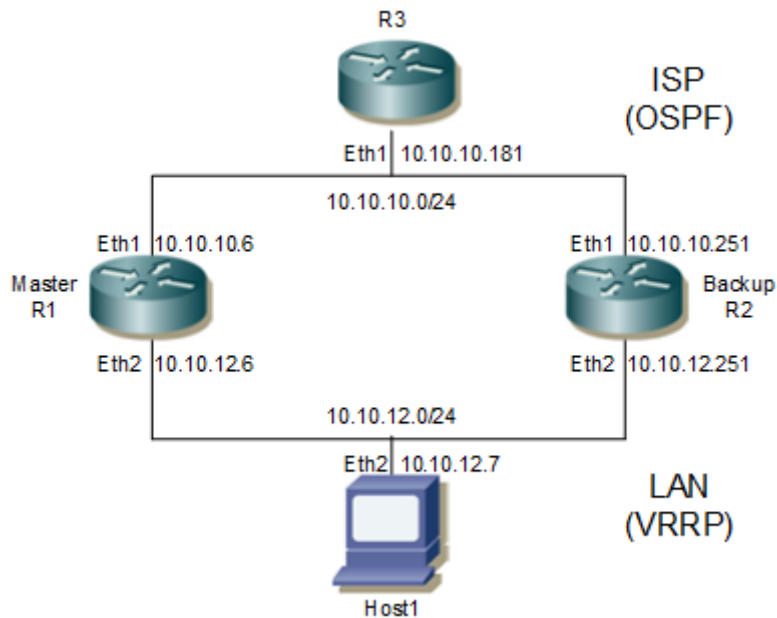

Figure 1-180: Redundancy Using VRRP and OSPF

In [Figure 1-180](#):

- R3 is an OSPF router representing an OSPF network to an ISP.
- R1 is the VRRP Master/OSPF router.
- R2 is the VRRP Backup/OSPF router.
- Host 1 is an end-host.

VRRP handles any failure of the Master's link to the LAN. Failures in the OSPF network that could cause the Master to lose routing information would cause packets from Host 1 that are targeted for R3 to be dropped. Running VRRP on the OSPF network to create redundancy is undesirable, because doing so would cause erroneous VRRP packets to be sent to the ISP.

An alternative method to achieve redundancy is to run OSPF on the LAN side. By running OSPF on the LAN, any routing information lost by the Master would be regained from the Backup on the LAN interface, resulting in ICMP redirects to R2 for traffic received from Host 1. To reduce OSPF control traffic, R1 and R2 are configured as Area Border Routers (ABR), and the LAN is configured as a stub network to reduce LSA advertisement traffic on the LAN. Before enabling OSPF on the LAN, verify that VRRP is running with R1 as the Master and R2 as the Backup.

```
R1#sh vrrp
VRRP Version: 3
VMAC enabled
Backward Compatibility disabled

Address family IPv4
VRRP Id: 1 on interface: vlan1.1000
State: AdminUp - Master
Virtual IP address: 10.1.1.2 (Owner)
Virtual MAC address is 0000.5e00.0101
Operational primary IP address: 10.1.1.2
Operational master IP address: 10.1.1.2
```

```

Priority is 255
Advertisement interval: 100 centi sec
Master Advertisement interval: 100 centi sec
Virtual router uptime: 0 hours 1 minutes 11 seconds (7100 centi sec)
Master uptime: 0 hours 1 minutes 11 seconds (7100 centi sec)
Accept mode: TRUE
Preempt mode: TRUE
Multicast membership on IPv4 interface vlan1.1000: JOINED
V2-Compatible: FALSE

```

```

R2#sh vrrp
VRRP Version: 3
VMAC enabled
Backward Compatibility disabled

```

```

Address family IPv4
VRRP Id: 1 on interface: vlan1.1000
State: AdminUp - Backup
Virtual IP address: 10.1.1.2 (Not-owner)
Virtual MAC address is 0000.5e00.0101
Operational primary IP address: 10.1.1.3
Operational master IP address: 10.1.1.2
Priority is 100
Advertisement interval: 100 centi sec
Master Advertisement interval: 100 centi sec
Virtual router uptime: 0 hours 0 minutes 38 seconds (3800 centi sec)
Skew time: 60 centi sec
Master Down Interval: 360 centi sec
Accept mode: TRUE
Preempt mode: TRUE
Multicast membership on IPv4 interface vlan1.1000: JOINED
V2-Compatible: FALSE

```

Steps to configure OSPF on the LAN are given below.

R3

#configure terminal	Enter the Configure mode.
(config)#router ospf 1	Configure the routing process and specify the process ID (1). The process ID should be a unique integer.
(config-router)#ospf router-id 10.10.10.181	Specify the OSPF router ID.
(config-router)#timers spf exp 0 0	Set timers to minimum time for quick convergence.
(config-router)#network 10.10.10.0/24 area 0	Define one interface (10.10.10.0/24) on which OSPF runs and associate the area ID (0).
(config-router)#commit	Commit the candidate configuration to the running configuration.
(config-router)#exit	Exit router VRRP mode.

R1

#configure terminal	Enter the Configure mode.
(config)#router ospf 1	Configure the routing process and specify the process ID (1). The process ID should be a unique integer.
(config-router)#ospf router-id 10.10.12.6	Specify the OSPF router ID.
(config-router)#area 1 stub	Define area 1 as a stub network.
(config-router)#network 10.10.10.0/24 area 0	Define one interface (10.10.10.0/24) on which OSPF runs and associate the area ID (0).
(config-router)#network 10.10.12.0/24 area 1	Define the other interface (10.10.12.0/24) on which OSPF runs and associate the area ID (1)
(config-router)#commit	Commit the candidate configuration to the running configuration.
(config-router)#exit	Exit router VRRP mode.

R2

#configure terminal	Enter the Configure mode.
(config)#router ospf 1	Configure the routing process, and specify the process ID (1). The process ID should be a unique integer
(config-router)#ospf router-id 10.10.12.251	Specify the OSPF router ID.
(config-router)#area 1 stub	Define area 1 as a stub network.
(config-router)#network 10.10.10.0/24 area 0	Define one interface (10.10.10.0/24) on which OSPF runs and associate the area ID (0).
(config-router)#network 10.10.12.0/24 area 1	Define the other interface (10.12.10.0/24) on which OSPF runs and associate the area ID (1)
(config-router)#commit	Commit the candidate configuration to the running configuration.
(config-router)#exit	Exit router VRRP mode.

Verification

1. Set gateway on the end-host (statically):

```
(root@host1)#route add -net 10.10.10.0 netmask 255.255.255.0 gw 10.10.12.6
```

2. Verify end-host reachability via traceroute:

```
(root@host1)#traceroute 10.10.10.181
traceroute to 10.10.10.181 (10.10.10.181), 30 hops max, 38 byte packets
1 10.10.12.6 (10.10.12.6) 0.835 ms 0.350 ms 0.341 ms
2 10.10.10.181 (10.10.10.181) 9.557 ms 0.572 ms 0.545 ms
```

3. Bring down eth2 of R1:

```
[root@r1 sbin]#ifconfig eth2 down
```

4. Verify end-host reachability via traceroute:

```
(root@host1)#traceroute 10.10.10.181
traceroute to 10.10.10.181 (10.10.10.181), 30 hops max, 38 byte packets
1 10.10.12.6 (10.10.12.6) 0.461 ms 0.352 ms 0.334 ms
```

```
2 10.10.12.251 (10.10.12.251) 0.425 ms 0.432 ms 0.410 ms
3 10.10.10.181 (10.10.10.181) 0.691 ms 0.639 ms 0.607 ms
```

5. Bring up eth2 of R1:

```
[root@r1 sbin]#ifconfig eth2 up
```

6. Verify end-host reachability via traceroute:

```
(root@host1)#traceroute 10.10.10.181
traceroute to 10.10.10.181 (10.10.10.181), 30 hops max, 38 byte packets
1 10.10.12.6 (10.10.12.6) 0.457 ms 0.356 ms 0.443 ms
2 10.10.10.181 (10.10.10.181) 0.698 ms 0.642 ms 0.618 ms
```

VRRP Over MLAG

This section contains VRRP over MLAG configuration examples.

In this configuration TOR1 and TOR2 forms the VRRP master/back-up relationship over MLAG interface.

For complete information about MC-LAG configuration with Intra-domain-Link (IDL) and Intra-domain-peer (IDP), refer to [Configuration](#) and [Configuration](#) in *OcNOS Layer 2 Config Guide*.

Topology

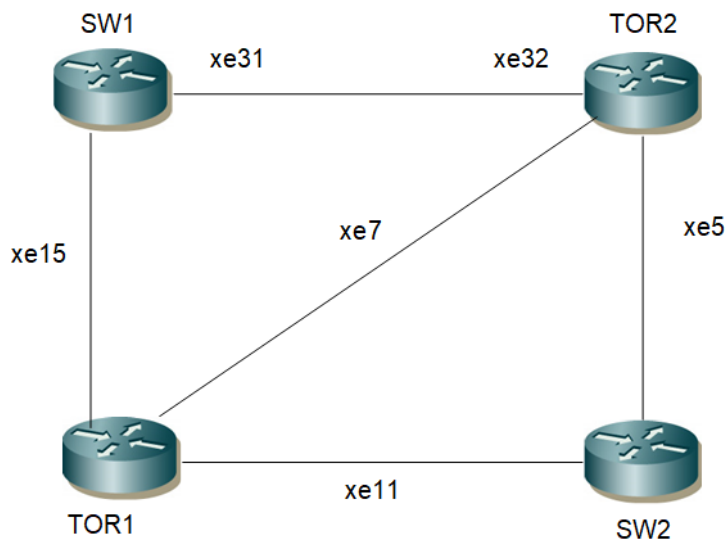

Figure 1-181: VRRP over MLAG

SW1

#config terminal	Enter the Configure mode.
(config)#hostname SW1	Assign the hostname for the router.
SW1(config)# bridge 1 protocol rstp vlan-bridge	Create bridge
SW1(config)#vlan database	Enter to VLAN database
SW1(config-vlan)#vlan 2-1002 bridge 1 state enable	Create VLANs
SW1(config-vlan)#exit	Exit the VLAN database mode
SW1(config)# int po1	Enter the interface mode
SW1(config-if)#switchport	Configure the interface as Layer 2
SW1(config-if)# bridge-group 1	Assign the bridge to the interface.
SW1(config-if)#switchport mode trunk	Configure the interface as trunk mode
SW1(config-if)#switchport trunk allowed vlan all	Configure the interface to allow all VLAN IDs
(config-if)#commit	Commit the candidate configuration to the running configuration.

SW1(config-if)#exit	Exit the interface mode
SW1(config)# int xe15	Enter the interface mode
SW1(config-if)# channel-group 1 mode active	Add the interface as member of LAG interface
SW1(config-if)# int xe31	Enter the interface mode
SW1(config-if)# channel-group 1 mode active	Add the interface as member of LAG interface
SW1(config-if)# int xe36	Enter the interface mode
SW1(config-if)#switchport	Configure the interface as Layer 2
SW1(config-if)# bridge-group 1	Assign the bridge to the interface.
SW1(config-if)#switchport mode trunk	Configure the interface as trunk mode
SW1(config-if)#switchport trunk allowed vlan all	Configure the interface to allow all VLAN IDs
SW1(config-if)#exit	Exit the interface mode
SW1(config-if)#commit	Commit the candidate configuration to the running configuration.
SW1(config-if)#exit	Exit the interface mode.

TOR1

#config terminal	Enter the Config terminal
(config)#hostname TOR1	Assign the hostname to the router
TOR1(config)# bridge 1 protocol rstp vlan-bridge	Configure the bridge
TOR1(config)#vlan database	Enter the VLAN database
TOR1(config-vlan)#vlan 2-1002 bridge 1 state enable	Configure VLANs
TOR1(config-vlan)#commit	Commit the candidate configuration to the running configuration.
TOR1(config-vlan)#exit	Exit the VLAN database
TOR1(config)# int po1	Enter the interface mode
TOR1(config-if)#switchport	Configure the interface as L2
TOR1(config-if)# bridge-group 1	Assign the bridge to the interface
TOR1(config-if)#switchport mode trunk	Configure the interface as trunk mode
TOR1(config-if)#switchport trunk allowed vlan all	Configure to allow all the VLANs
TOR1(config-if)#commit	Commit the candidate configuration to the running configuration.
TOR1(config-if)#exit	Exit the interface mode
TOR1(config)# int xe15	Enter the interface mode
TOR1(config-if)# channel-group 1 mode active	Assign the interface as member of LAG interface
TOR1(config-if)#exit	Exit the interface mode
TOR1(config)#interface xe7	Enter interface mode.
TOR1(config)#switchport	Configure as switchport L2 interface.
TOR1(config)#mcec domain configuration	Enter the MCEC mode

VRRP Configuration

TOR1 (config-mcec-domain) #domain-system-number 1	Assign the domain system number for MLAG interface.
TOR1 (config-mcec-domain) #domain-address 1111.2222.3333	Assign the domain address
TOR1 (config-mcec-domain) #domain-hello-timeout short	Assign the domain hello timeout
TOR1 (config-mcec-domain) #intra-domain-link xe7	Assign the interface as IDL
TOR1 (config-mcec-domain) #commit	Commit the candidate configuration to the running configuration.
TOR1 (config-mcec-domain) #exit	Exit the MCEC domain
TOR1 (config) #interface lo	Enter the interface mode
TOR1 (config-if) #ip add 1.1.1.1/32 secondary	Assign IP address to the interface
TOR1 (config-if) #int xe11	Enter the interface mode
TOR1 (config-if) #ip add 20.20.20.1/24	Assign IP address to the interface
TOR1 (config-if) #commit	Commit the candidate configuration to the running configuration.
TOR1 (config-if) #exit	Exit the interface mode
TOR1 (config) #router ospf 100	Configure the routing process and specify the process ID (100). The process ID should be a unique integer.
TOR1 (config-router) #network 20.20.20.1/24 area 0	Add the network to the OSPF process
TOR1 (config-router) #network 1.1.1.1/32 area 0	Define one interface (1.1.1.1/32) on which OSPF runs and associate the area ID (0).
TOR1 (config-router) #redistribute connected	Redistribute the connected routes
TOR1 (config-router) #commit	Commit the candidate configuration to the running configuration
TOR1 (config-router) #exit	Exit the OSPF process
TOR1 (config) #interface mlag1	Enter mlag1 interface
TOR1 (config) #switchport	Configure as switchport L2 interface
TOR1 (config) #bridge-group 1	Assign the bridge to the interface
TOR1 (config) #switchport mode trunk	Make the interface trunk mode
TOR1 (config) #switchport trunk allowed vlan all	Configure to allow all vlans
TOR1 (config) #int po1	Enter the interface mode
TOR1 (config-if) #mlag 1	Redistribute the connected routes
TOR1 (config-if) #exit	Exit the interface mode
TOR1 (config) #int vlan1.2	Enter interface mode
TOR1 (config-if) #ip address 10.10.10.1/24	Assign IP address
TOR1 (config-if) #exit	Exit the interface mode
TOR1 (config) #router vrrp 1 vlan1.2	Create the VRRP process
TOR1 (config-router) # virtual-ip 10.10.10.1 owner	Assign the virtual IP address to VRRP
TOR1 (config-router) #enable	Enable the VRRP process

TOR1 (config-router) #commit	Commit the candidate configuration to the running configuration.
TOR1 (config-router) #exit	Exit the VRRP mode

TOR2

#config terminal	Enter the Config terminal
(config) #hostname TOR2	Assign the hostname to the router
TOR2 (config) # bridge 1 protocol rstp vlan-bridge	Configure the bridge
TOR2 (config) #vlan database	Enter the VLAN database
TOR2 (config-vlan) #vlan 2-1002 bridge 1 state enable	Configure VLANs
TOR2 (config-vlan) #commit	Commit the candidate configuration to the running configuration.
TOR2 (config-vlan) #exit	Exit the VLAN database
TOR2 (config) # int po1	Enter the interface mode
TOR2 (config-if) #switchport	Configure the interface as L2
TOR2 (config-if) # bridge-group 1	Assign the bridge to the interface
TOR2 (config-if) #switchport mode trunk	Configure the interface as trunk mode
TOR2 (config-if) #switchport trunk allowed vlan add 2	Configure to add the VLAN 2 to the receiving packet.
TOR2 (config-if) #commit	Commit the candidate configuration to the running configuration.
TOR2 (config-if) #exit	Exit the interface mode
TOR2 (config) # int xe32	Enter the interface mode
TOR2 (config-if) # channel-group 1 mode active	Assign the interface as member of LAG interface
TOR2 (config-if) #exit	Exit the interface mode
TOR2 (config) #interface xe7	Enter interface mode
TOR2 (config) #switchport	Configure as switchport L2 interface
TOR2 (config) #mcec domain configuration	Enter the MCEC mode
TOR2 (config-mcec-domain) #domain-system-number 2	Assign the domain system number for MLAG interface.
TOR2 (config-mcec-domain) #domain-address 1111.2222.3333	Assign the domain address
TOR2 (config-mcec-domain) #domain-hello-timeout short	Assign the domain hello timeout
TOR2 (config-mcec-domain) #intra-domain-link xe7	Assign the interface as IDL
TOR2 (config-mcec-domain) #commit	Commit the candidate configuration to the running configuration.
TOR2 (config-mcec-domain) #exit	Exit the MCEC domain
TOR2 (config) #interface mlag1	Enter mlag1 interface
TOR2 (config) #switchport	Configure as switchport L2 interface
TOR2 (config) #bridge-group 1	Assign the bridge to the interface

VRRP Configuration

TOR2(config)#switchport mode trunk	Make the interface trunk mode
TOR2(config)#switchport trunk allowed vlan all	Configure to allow all vlans
TOR2(config)# int po1	Enter the interface mode
TOR2(config-if)# mlag 1	Create the MLAG interface.
TOR2(config-if)#commit	Commit the candidate configuration to the running configuration.
TOR2(config-if)#exit	Exit the interface mode
TOR2(config)#interface lo	Enter the interface mode
TOR2(config-if)#ip add 2.2.2.2/32 secondary	Assign IP address to the interface
TOR2(config-if)#int xe5	Enter the interface mode
TOR2(config-if)#ip add 30.30.30.1/24	Assign IP address to the interface
TOR2(config-if)#commit	Commit the candidate configuration to the running configuration.
TOR2(config-if)#exit	Exit the interface mode
TOR2(config)#router ospf 100	Enter the OSPF router mode
TOR2(config-router)#network 30.30.30.1/24 area 0	Add the network to the OSPF process
TOR2(config-router)#network 2.2.2.2/32 area 0	Add the network to the OSPF process
TOR2(config-router)#redistribute connected	Redistribute the connected routes
TOR2(config-router)#commit	Commit the candidate configuration to the running configuration.
TOR2(config-router)#exit	Exit the OSPF process
TOR2(config)#int vlan1.2	Enter interface mode
TOR2(config-if)#ip address 10.10.10.2/24	Assign IP address
TOR2(config-if)#exit	Exit the interface mode
TOR2(config)#router vrrp 1 vlan1.2	Create the VRRP process
TOR2(config-router)# virtual-ip 10.10.10.1	Assign the virtual IP address to VRRP
TOR2(config-router)#enable	Enable the VRRP process
TOR2(config-router)#commit	Commit the candidate configuration to the running configuration.
TOR2(config-router)#exit	Exit the VRRP mode

SW2

#config terminal	Enter the Config terminal
(config)#hostname SW2	Assign the hostname to the router
SW2(config)# bridge 1 protocol rstp vlan-bridge	Configure the bridge
SW2(config)#vlan database	Enter the VLAN database
SW2(config-vlan)#vlan 2-1002 bridge 1 state enable	Configure VLANs
SW2(config-vlan)#commit	Commit the candidate configuration to the running configuration.
SW2(config-vlan)#exit	Exit the VLAN database

SW2(config)# int xe11	Enter the interface mode
SW2(config-if)#ip address 20.20.20.2/24	Assign IP address to the interface
SW2(config-if)# int xe5	Enter the interface mode
SW2(config-if)#ip address 30.30.30.2/24	Assign IP address to the interface
SW2(config-if)#commit	Commit the candidate configuration to the running configuration.
SW2(config-if)# int xe46	Enter the interface mode
SW2(config-if)#ip address 40.40.40.1/24	Assign IP address to the interface
SW2(config-if)#int lo	Enter the interface mode
SW2(config-if)#ip add 3.3.3.3/32 secondary	Assign IP address to the interface
SW2(config-if)#int xe32	Enter the interface mode
SW2(config-if)#ip add 50.50.50.2/24	Assign IP address to the interface
SW2(config-if)#exit	Exit interface mode
SW2(config)# router ospf 100	Enter OSPF router
SW2(config-router)# network 3.3.3.3/32 area 0	Add the IP address to the OSPF process
SW2(config-router)# network 20.20.20.0/24 area 0	Add the IP address to the OSPF process
SW2(config-router)# network 30.30.30.0/24 area 0	Add the IP address to the OSPF process
SW2(config-router)#network 50.50.50.2/24 area 0	Add the IP address to the OSPF process
SW2(config-router)#commit	Commit the candidate configuration to the running configuration.
SW2(config-router)#exit	Exit the OSPF mode

Validation

TOR1

```
TOR1#show mlag domain summary
```

```
-----
Domain Configuration
-----

Domain System Number      : 1
Domain Address            : 1111.2222.3333
Domain Priority           : 32768
Intra Domain Interface    : xe7
Domain Adjacency         : UP
Domain Sync via          : Intra-domain-interface
-----

MLAG Configuration
-----

MLAG-1
  Mapped Aggregator       : po1
```

VRRP Configuration

```
Physical properties Digest      : 54 a9 3a 2a 2b 50 65 bb 3c bc 3d bd c2 43 d6 22
Total Bandwidth                 : 10g
Mlag Sync                       : IN_SYNC
Mode                            : Active-Standby
Current Mlag state              : Active
Switchover-mode                 : Revertive
```

```
TOR1#show vrrp 1 vlan1.2
```

```
VRRP Version: 3
VMAC enabled
Backward Compatibility disabled
```

```
Address family IPv4
```

```
VRRP Id: 1 on interface: vlan1.2
State: AdminUp - Master
Virtual IP address: 10.10.10.1 (Owner)
Virtual MAC address is 0000.5e00.0101
Operational primary IP address: 10.10.10.1
Operational master IP address: 10.10.10.1
Priority is 255
Advertisement interval: 100 centi sec
Master Advertisement interval: 100 centi sec
Virtual router uptime: 0 hours 5 minutes 11 seconds (31100 centi sec)
Master uptime: 0 hours 5 minutes 11 seconds (31100 centi sec)
Accept mode: TRUE
Preempt mode: TRUE
Auth-type: simple text, String: abcd
Multicast membership on IPv4 interface vlan1.2: JOINED
V2-Compatible: TRUE
```

TOR2

```
TOR2#show mlag domain summary
```

```
-----
Domain Configuration
-----
```

```
Domain System Number          : 2
Domain Address                 : 1111.2222.3333
Domain Priority                 : 32768
Intra Domain Interface        : xe7
Domain Adjacency               : UP
Domain Sync via                : Intra-domain-interface
```

```
-----
MLAG Configuration
-----
```

```
MLAG-1
Mapped Aggregator             : po1
```

```
Physical properties Digest : 54 a9 3a 2a 2b 50 65 bb 3c bc 3d bd c2 43 d6 22
Total Bandwidth           : 10g
Mlag Sync                 : IN_SYNC
Mode                      : Active-Standby
Current Mlag state        : Standby
Switchover-mode           : Revertive
```

```
TOR2#show vrrp 1 vlan1.2
```

```
VRRP Version: 3
```

```
VMAC enabled
```

```
Backward Compatibility disabled
```

```
Address family IPv4
```

```
VRRP Id: 1 on interface: vlan1.2
```

```
State: AdminUp - Backup
```

```
Virtual IP address: 10.10.10.1 (Not-owner)
```

```
Virtual MAC address is 0000.5e00.0101
```

```
Operational primary IP address: 10.10.10.2
```

```
Operational master IP address: 10.10.10.1
```

```
Priority is 100
```

```
Advertisement interval: 100 centi sec
```

```
Master Advertisement interval: 100 centi sec
```

```
Virtual router uptime: 0 hours 6 minutes 27 seconds (38700 centi sec)
```

```
Skew time: 80 centi sec
```

```
Master Down Interval: 380 centi sec
```

```
Preempt mode: TRUE
```

```
Auth-type: simple text, String: abcd
```

```
Multicast membership on IPv4 interface vlan1.2: JOINED
```

```
V2-Compatible: TRUE
```

```
Session is on MLAG interface. Dataplane acting as Master
```

CHAPTER 2 Object Tracking Using IP SLA

This feature is used to track the state of an object for reachability using IP SLA. A client process such as Virtual Router Redundancy Protocol (VRRP), or RIB, registers itself to track objects and then get notified when a state change occurs.

IP SLA (Service-Level Assurance Protocol) is a Performance Measurement protocol. The protocol is used to Analyze IP Service Levels for IP applications and services. IP SLA's uses active traffic-monitoring technology to monitor continuous traffic on the network.

IP SLA uses Internet Control Message Protocol (ICMP) pings to identify a link failure and notifies to the clients that are registered for tracking.

The Object Tracking feature provides complete separation between the objects to be tracked and the action to be taken by a client when a tracked object state changes. Thus, several clients such as VRRP, or RIB can register their interest with the tracking process, track the same object, and each take different action when the object changes. The Tracking feature is present in OAMD.

Each tracked object is identified by a unique number that is specified on the tracking CLI. Client processes use this number to track a specific object.

The tracking process processes events from the tracked objects and notes any change of value. The changes in the tracked object are communicated to interested client processes, either immediately or after a specified delay. The object values are reported as either up or down.

To configure VRRP Object Tracking, the object is configured to have a priority-delta value, which is passed to VRRP when a failure occurs. The priority of Virtual Router on the circuit is decremented by the priority- delta value, causing the VR Master to VR Backup transition.

In this example, two routers, R1 and R2, are configured as Master and backup routers with different priorities respectively. The priority-delta value is configured to be greater than the difference of both the priorities. R1 is configured to have a priority of 150, and R2 has a priority of 100. R1, with a greater priority, is the Virtual Router Master. The priority-delta value is 60, greater than 50 (150 minus 100). On R1, when the external interface xe41 fails, the Track state becomes DOWN and the priority of R1 becomes 90 (150 minus 60). Since R2 has a greater priority (100) than R1, R2 becomes the VR Master, and routing of packages continues without interruption. When the track state comes UP this VR Backup (R1) is UP again, it regains its original priority (150), and becomes the VR Master again.

Topology

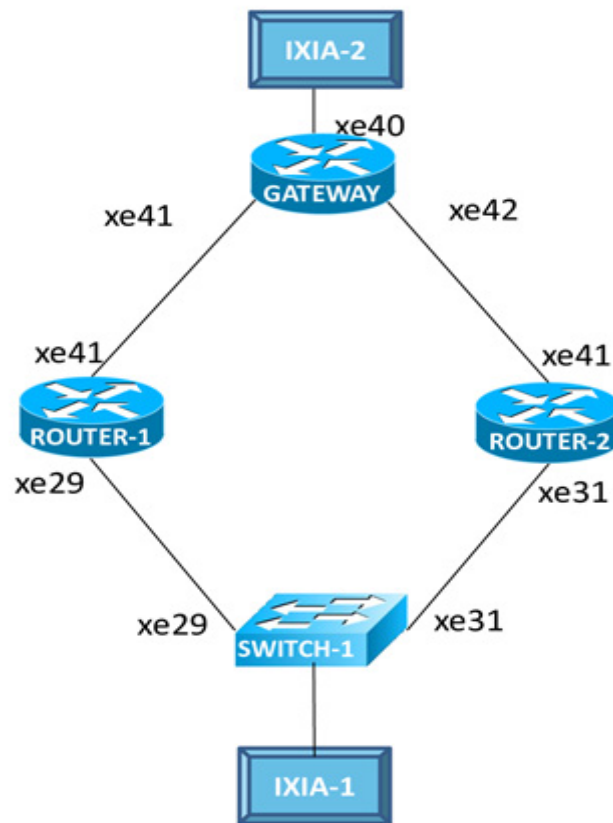

Figure 2-182: VRRP Object Tracking

R1

(config)#configure terminal	Enter the Configure mode.
(config)#bridge 1 protocol rstp vlan-bridge	Create a RSTP VLAN aware bridge.
(config)#vlan 1001-1002 bridge 1	Create VLAN 1001,1002 and map it to bridge 1.
(config)#interface xe29	Enter interface mode.
(config-if)#switchport	Configure switch port.
(config-if)#bridge-group 1 spanning-tree disable	Configure bridge group to I2 interface with spanning-tree Disable.
(config-if)#switchport mode trunk	Configure switch port mode as trunk.
(config-if)#switchport trunk allowed vlan add 1001,1002	Allow vlan 1001 ,1002 on the interface.
(config-if)#interface vlan1.1001	Enter the vlan interface
(config-if)#ip address 10.1.1.2/24	Configure ipv4 address
(config-if)#ipv6 address 1000:1::2/32	Configure ipv6 address
(config-if)#ipv6 router ospf area 0.0.0.0	Tag ospfv3 instance on interface with area 0
(config-if)#exit	Exit the interface mode

(config)#ip sla 1	Configure IP SLA
(config-ip-sla)#icmp-echo ipv4 4.4.4.4 source-interface xe41	Configure ICMP-echo with a destination ipv4/ipv6 address
(config)#time-range tr1	Configure Time-Range
(config-tr)#start-time now	Configure the Start-Time
(config-tr)#commit	commit
(config-tr)#end-time after 100	Configure end-time
(config)#track 1 ip sla 1 reachability	Track the reachability of the IP SLA
(config)#router vrrp 1 vlan1.1001	Create a new ipv4 VRRP instance for interface vlan1.1001
(config-router)#virtual-ip 10.1.1.1	Set the virtual IP address for the VRRP session
(config-router)#priority 150	Configure the priority to 150
(config-router)# track 1 decrement 60	Configure the priority-delta value to be 60. In case of failover, this priority-delta value is subtracted from the current VR Master.
(config-router)#v2-compatible	Enable the v2-compatible
(config-router)#enable	Enable the VRRP session on the router.
(config-router)#commit	Commit the configuration on the node
(config-router)#exit	Exit the router mode.
(config)#router ipv6 vrrp 1 vlan1.1001	Create a new ipv6 VRRP instance for interface vlan1.1001.
(config-router)#virtual-ipv6 fe80::1	Set the virtual IPv6 address for the VRRP session.
(config-router)#priority 150	Configure the priority to 150
(config-router)# track 1 decrement 60	Configure the priority-delta value to be 70. In case of failover, this priority-delta value is subtracted from the current VR Master.
(config-router)#enable	Enable the VRRP session on the router.
(config-router)#commit	Commit the configuration on the node
(config-router)#exit	Exit the router mode
(config-if)#interface xe41	Enter interface mode
(config-if)#ip address 60.1.1.1/24	Configure ipv4 address
(config-if)#ipv6 address 6000::1/64	Configure ipv6 address
(config-if)#ipv6 router ospf area 0.0.0.0	Tag ospfv3 instance on interface with area 0
(config-if)#commit	Commit the configuration on the node
(config-if)#exit	Exit interface and configure mode

R2

(config)#bridge 1 protocol rstp vlan-bridge	Create a RSTP VLAN aware bridge with bridge-id.
(config)#vlan 1001-1002 bridge 1	Create VLAN 1001,1002 and map it to bridge 1
(config)#interface xe31	Enter interface mode
(config-if)#switchport	Configure switch port
(config-if)#bridge-group 1 spanning-tree disable	Configure bridge group to I2 interface with spanning-tree Disable
(config-if)#switchport mode trunk	Configure switch port mode as trunk

Object Tracking Using IP SLA

(config-if)#switchport trunk allowed vlan add 1001,1002	Allow vlan 1001 ,1002 on the interface
(config-if)#interface vlan1.1001	Enter the vlan interface
(config-if)#ip address 10.1.1.3/24	Configure ipv4 address
(config-if)#ipv6 address 1000:1::3/32	Configure ipv6 address
(config-if)#ipv6 router ospf area 0.0.0.0	Tag ospfv3 instance on interface with area 0
(config-if)#commit	Commit the configuration on the node
(config-if)#exit	Exit interface mode
(config)#router vrrp 1 vlan1.1001	Create a router ipv4 VRRP instance for interface vlan1.1001.
(config-router)#virtual-ip 10.1.1.1	Set the virtual IP address for the VRRP session.
(config-router)#priority 50	Configure the priority to 50 (less than 150), because R2 is the VR Backup router.
(config-router)#v2-compatible	Enable the v2-compatible
(config-router)#authentication text abcd	Configure the authentication text to specify that as simple text for vrrpv2 packets, accept only 8 characters.
(config-router)#enable	Enable the VRRP session
(config-router)#commit	Commit the configuration on the node
(config-router)#exit	Exit the router mode
(config)#router ipv6 vrrp 1 vlan1.1001	Create a router ipv6 VRRP ipv6 instance for interface vlan1.1001.
(config-router)#virtual-ipv6 fe80::1	Set the virtual IPv6 address for the VRRP session.
(config-router)#priority 50	Configure the priority to 50 (less than 150), because R2 is the VR Backup router.
(config-router)#commit	Commit the configuration on the node
(config-router)#exit	Exit the router mode
(config)#interface xe41	Enter interface mode
(config-if)#ip address 80.1.1.1/24	Configure ipv4 address
(config-if)#ipv6 address 8000::1/64	Configure ipv6 address
(config-if)#ipv6 router ospf area 0.0.0.0	Tag ospfv3 instance on interface with area 0

Validation

```
R1# sh track
TRACK Id: 1
  IP SLA 1 reachability
  Reachability is UP
  2 changes, last change : 2019 Feb 19 07:19:57
```

```
R1# show vrrp 1 vlan1.1001VRRP Version: 3
VMAC enabled
Backward Compatibility disabledAddress family IPv4
VRRP Id: 1 on interface: vlan1.1001State: AdminUp- Master
```

```
Virtual IP address: 10.1.1.1 (Not-owner) Virtual MAC address is 0000.5e00.0101
Operational primary IP address: 10.1.1.2 Operational master IP address: 10.1.1.2
Configured priority: 150, Current priority: 150Advertisement interval: 100 centi sec
Master Advertisement interval: 100 centi sec
Virtual router uptime: 0 hours 1 minutes 12 seconds (7200 centi sec)
Master uptime: 0 hours 2 minutes 34 seconds (15400 centi sec)Accept mode: TRUE
Preempt mode: TRUE
Monitored circuit: xe41, Priority Delta: 70, Status: UP Monitored circuit: xe50/1,
Priority Delta: 10, Status: UP Monitored circuit: xe50/2, Priority Delta: 30, Status: UP
Auth-type: simple text, String: abcd
Multicast membership on IPv4 interface vlan1.1001: JOINED V2-Compatible: TRUE
```

R1#

```
R2#show vrrp 1 vlan1.1001VRRP Version: 3
VMAC enabled
Backward Compatibility disabledAddress family IPv4
VRRP Id: 1 on interface: vlan1.1001State: AdminUp- Backup
Virtual IP address: 10.1.1.1 (Not-owner)Virtual MAC address is 0000.5e00.0101
Operational primary IP address: 10.1.1.3Operational master IP address: 10.1.1.2Priority
is 100
Advertisement interval: 100 centi sec
Master Advertisement interval: 100 centi sec
Virtual router uptime: 7 hours 52 minutes 53 seconds (2837300 centi sec)Skew time: 80
centi sec
Master Down Interval: 380 centi secAccept mode: TRUE
Preempt mode: TRUE
Auth-type: simple text, String: abcd
Multicast membership on IPv4 interface vlan1.1001: JOINEDV2-Compatible: TRUE
```

R2#

```
R1#show vrrp ipv6 1 vlan1.1001VRRP Version: 3
VMAC enabled
Backward Compatibility disabledAddress family IPv6
VRRP Id: 1 on interface: vlan1.1001State: AdminUp- Master
Virtual IP address: fe80::1 (Not-owner)Virtual MAC address is 0000.5e00.0201
Operational primary IP address: fe80::ba6a:97ff:fe3c:de9dOperational master IP address:
fe80::ba6a:97ff:fe3c:de9dConfigured priority: 150, Current priority: 150 Advertisement
interval: 100 centi sec
Master Advertisement interval: 100 centi sec
Virtual router uptime: 0 hours 3 minutes 54 seconds (23400 centi sec)
Master uptime: 0 hours 2 minutes 34 seconds (15400 centi sec)Accept mode: TRUE
Preempt mode: TRUE
Monitored circuit: xe41, Priority Delta: 70, Status: UP Monitored circuit: xe50/1,
Priority Delta: 10, Status: UP Monitored circuit: xe50/2, Priority Delta: 30, Status: UP
Multicast membership on IPv6 interface vlan1.1001: JOINEDV2-Compatible: FALSE
```

R1#

```
R2#show vrrp ipv6 1 vlan1.1001VRRP Version: 3
VMAC enabled
Backward Compatibility disabledAddress family IPv6
VRRP Id: 1 on interface: vlan1.1001State: AdminUp- Backup
Virtual IP address: fe80::1 (Not-owner)Virtual MAC address is 0000.5e00.0201
```

Object Tracking Using IP SLA

```
Operational primary IP address: fe80::82a2:35ff:fe35:135fOperational master IP address:
fe80::ba6a:97ff:fe3c:de9dPriority is 100
Advertisement interval: 100 centi sec
Master Advertisement interval: 100 centi sec
Virtual router uptime: 7 hours 55 minutes 11 seconds (2851100 centi sec)Skew time: 80
centi sec
Master Down Interval: 380 centi secAccept mode: TRUE
Preempt mode: TRUE
Multicast membership on IPv6 interface  vlan1.1001: JOINEDV2-Compatible: FALSE
R2#
```

After shut down the tracked Object (xe41) in R1:

```
R1# sh track
TRACK Id: 1
  IP SLA 1 reachability
  Reachability is DOWN
    2 changes, last change : 2019 Feb 19 07:19:57
```

```
R1#show vrrp 1 vlan1.1001VRRP Version: 3
VMAC enabled
Backward Compatibility disabledAddress family IPv4
VRRP Id: 1 on interface: vlan1.1001State: AdminUp- Backup
Virtual IP address: 10.1.1.1 (Not-owner)
```

```
Virtual MAC address is 0000.5e00.0101 Operational primary IP address: 10.1.1.2
Operational master IP address: 10.1.1.3
Priority is 90 (Configured Priority is 150)Advertisement interval: 100 centi sec
Master Advertisement interval: 100 centi sec
Virtual router uptime: 0 hours 7 minutes 46 seconds (46600 centi sec)Skew time: 84 centi
sec
Master Down Interval: 380 centi secAccept mode: TRUE
Preempt mode: TRUE
Monitored circuit: xe41, Priority Delta: 70, Status: DOWN Monitored circuit: xe50/1,
Priority Delta: 10, Status: DOWNMonitored circuit: xe50/2, Priority Delta: 30, Status:
DOWNAuth-type: simple text, String: abcd
Multicast membership on IPv4 interface vlan1.1001: JOINEDV2-Compatible: TRUE
```

```
R1#
R2#show vrrp 1 vlan1.1001VRRP Version: 3
VMAC enabled
Backward Compatibility disabledAddress family IPv4
VRRP Id: 1 on interface: vlan1.1001State: AdminUp- Master
Virtual IP address: 10.1.1.1 (Not-owner)Virtual MAC address is 0000.5e00.0101
Operational primary IP address: 10.1.1.3Operational master IP address: 10.1.1.3Priority
is 100
Advertisement interval: 100 centi sec
Master Advertisement interval: 100 centi sec
Virtual router uptime: 7 hours 57 minutes 41 seconds (2866100 centi sec)
Master uptime: 0 hours 2 minutes 34 seconds (15400 centi sec)Accept mode: TRUE
Preempt mode: TRUE
Multicast membership on IPv4 interface vlan1.1001: JOINEDV2-Compatible: FALSE
```

```
R2#
R1#show vrrp ipv6 1 vlan1.1001VRRP Version: 3
VMAC enabled
Backward Compatibility disabledAddress family IPv6
VRRP Id: 1 on interface: vlan1.1001State: AdminUp- Backup
Virtual IP address: fe80::1 (Not-owner)Virtual MAC address is 0000.5e00.0201
Operational primary IP address: fe80::ba6a:97ff:fe3c:de9dOperational master IP
address: fe80::82a2:35ff:fe35:135fPriority is 90 (Configured Priority is 150)
Advertisement interval: 100 centi sec
Master Advertisement interval: 100 centi sec
Virtual router uptime: 0 hours 8 minutes 43 seconds (52300 centi sec)Skew time: 84 centi
sec
Master Down Interval: 380 centi secAccept mode: TRUE
```

```
Preempt mode: TRUE
Monitored circuit: xe41, Priority Delta: 70, Status: DOWN Monitored circuit: xe50/1,
Priority Delta: 10, Status: DOWNMonitored circuit: xe50/2, Priority Delta: 30, Status:
DOWNMulticast membership on IPv6 interface vlan1.1001: JOINEDV2-Compatible: FALSE
```

```
R1#
R2#show vrrp ipv6 1 vlan1.1001VRRP Version: 3
VMAC enabled
Backward Compatibility disabledAddress family IPv6
VRRP Id: 1 on interface: vlan1.1001State: AdminUp- Master
Virtual IP address: fe80::1 (Not-owner)Virtual MAC address is 0000.5e00.0201
Operational primary IP address: fe80::82a2:35ff:fe35:135fOperational master IP address:
fe80::82a2:35ff:fe35:135fPriority is 100
Advertisement interval: 100 centi sec
Master Advertisement interval: 100 centi sec
Virtual router uptime: 7 hours 59 minutes 4 seconds (2874400 centi sec)
Master uptime: 0 hours 2 minutes 34 seconds (15400 centi sec)Accept mode: TRUE
Preempt mode: TRUE
Multicast membership on IPv6 interface  vlan1.1001: JOINEDV2-Compatible: FALSE
R2#
```

CHAPTER 3 VRRP IPv6 Configuration

This chapter contains a Virtual Router Redundancy Protocol IPv6 (VRRPv6) configuration example.

VRRPv6 eliminates the risk of a single point of failure inherent in a static default routing environment. It specifies an election protocol that dynamically assigns responsibility for a virtual router to one of the VRRPv6 routers on a LAN. In this sample, OSPFv3 is enabled on Router 1 (R1), the master router, and the backup router. In R1, the connected routes are redistributed.

Note: IPv6 VRRP can be configured using link local address along with additional global ipv6 address as Virtual IP.

Topology

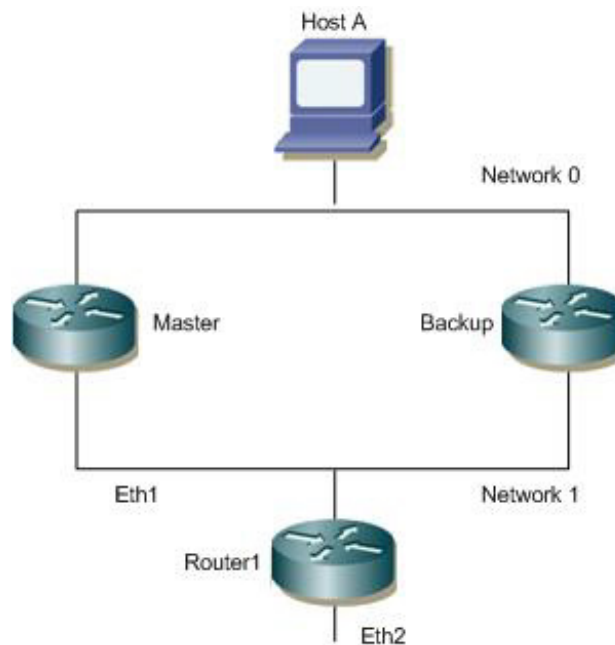

Figure 3-183: Topology

Configuration

Owner/Master Router

#configure terminal	Enter the Configure mode.
(config)#interface eth0	Enter the Interface mode for eth0.
(config-if)#ipv6 address fe80::3037:3aff:fe3a:3a32/64	Configure the IPv6 address for interface eth0 to be in network 0.
(config-if)#exit	Exit the Interface mode.
(config)#interface eth1	Enter the Interface mode for eth1.
(config-if)#ipv6 address fe80::3037:a0ff:fea4:3539/64	Configure the IPv6 address for interface eth1 to be in network 1.
(config-if)#exit	Exit the Interface mode.

VRRP IPv6 Configuration

(config)#router ipv6 vrrp 1 eth0	Create a VRRPv6 instance for interface eth0.
(config-router)#virtual-ipv6 fe80::3037:3aff:fe3a:3a32 owner	Configure R1 as the owner.
(config-router)#advertisement-interval 100	Configure the default value for the advertisement interval. The configurable range is <5-4095> (value must be a multiple of 5).
(config-router)#preempt-mode true	Set true as the default value for the field.
(config-router)#enable	Enable the VRRPv6 session on the router.
(config-router)#exit	Exit Router mode.

Backup Router

#configure terminal	Enter the Configure mode.
(config)#interface eth0	Enter the Interface mode for eth0.
(config-if)#ipv6 address fe80::3037:3aff:fe3a:3b45/64	Configure the IPv6 address for interface eth0 to be in network 0.
(config-if)#exit	Exit the Interface mode.
(config)#interface eth1	Enter the Interface mode for eth1.
(config-if)#ipv6 address fe80::3037:a0ff:fea4:3a40/64	Configure the IPv6 address for interface eth1 to be in network 1.
(config-if)#exit	Exit the Interface mode.
(config)#router ipv6 vrrp 1 eth0	Create a VRRPv6 instance for interface eth0.
(config-router)#virtual-ipv6 fe80::3037:3aff:fe3a:3a32	Configure Router 2 (R2) as the backup.
(config-router)#advertisement-interval 100	Configure the default value for the advertisement interval. The configurable range is <5-4095> (value must be a multiple of 5).
(config-router)#priority 100	Set the default value for the backup router.
(config-router)#preempt-mode true	Set true as the default value for the field.
(config-router)#enable	Enable the VRRPv6 session on the router.
(config-router)#exit	Exit Router mode.

Host A

#configure terminal	Enter the Configure mode.
(config)#interface eth0	Enter the Interface mode for eth0.
(config-if)#ipv6 address fe80::3037:3aff:fe3a:3a11/64	Configure the IPv6 address for interface eth0 to be in network 0.
(config-if)#exit	Exit the Interface mode.
(config)#ipv6 route 5ffe:14:14:14::/64 fe80::3037:3aff:fe3a:3a32	Configure a static route to reach interface eth2 of R1 through the virtual IPv6 address.

Router 1

#configure terminal	Enter the Configure mode.
(config)#interface eth1	Enter the Interface mode for eth1.
(config-if)#ipv6 address fe80::3037:a0ff:fea4:1111/64	Configure the IPv6 address for interface eth1 to be in network 1.
(config-if)#exit	Exit the Interface mode.
(config)#interface eth2	Enter the Interface mode for eth2.
(config-if)#ipv6 address fe80::3437:30ff:fe35:a6ac/64	Configure the IPv6 address of interface eth2.

Validation**Master Router**

```
R1#sh vrrp
VRRP Version: 3
VMAC enabled
Backward Compatibility disabled

Address family IPv6
VRRP Id: 1 on interface: eth0
State: AdminUp - Master
Virtual IP address: fe80::3037:3aff:fe3a:3a32 (Owner)
Priority is 255
Advertisement interval: 100 centi sec
Master Advertisement interval: 100 centi sec
Skew time: 0 centi sec
Accept mode: FALSE
Preempt mode: TRUE
Multicast membership on IPv6 interface eth0: JOINED
```

Backup Router

```
R1#sh vrrp
VRRP Version: 3
VMAC enabled
Backward Compatibility disabled

Address family IPv6
VRRP Id: 1 on interface: eth0
State: AdminUp - Backup
Virtual IP address: fe80::3037:3aff:fe3a:3a32 (Not-Owner)
Priority is 100
Advertisement interval: 100 centi sec
Master Advertisement interval: 100 centi sec
Skew time: 0 centi sec
Accept mode: FALSE
Preempt mode: TRUE
Multicast membership on IPv6 interface eth0: JOINED
```

Ping Output at Host A

```
[[root@HstA root]#ping ipv6 fe80::3437:30ff:fe35:a6ac
PING fe80::3437:30ff:fe35:a6ac(fe80::3437:30ff:fe35:a6ac) 56 data bytes
64 bytes from fe80::3437:30ff:fe35:a6ac: icmp_seq=1 ttl=63 time=0.398 ms
64 bytes from fe80::3437:30ff:fe35:a6ac: icmp_seq=2 ttl=63 time=0.230 ms
64 bytes from fe80::3437:30ff:fe35:a6ac: icmp_seq=3 ttl=63 time=0.234 ms
64 bytes from fe80::3437:30ff:fe35:a6ac: icmp_seq=4 ttl=63 time=0.230 ms
```

Disabling the Master

#configure terminal	Enter the Configure mode.
(config)#interface eth0	Enter the Interface mode for eth0.
(config-router)#shutdown	Shut down the interface

Validation

```
R1#sh vrrp
VRRP Version: 3
VMAC enabled
Backward Compatibility disabled

Address family IPv6
VRRP Id: 1 on interface: eth0
State: AdminUp - Init (interface is not running)
Virtual IP address: fe80::3037:3aff:fe3a:3a32 (Owner)
Priority is 255
Advertisement interval: 100 centi sec
Master Advertisement interval: 100 centi sec
Skew time: 0 centi sec
Accept mode: FALSE
Preempt mode: TRUE
Multicast membership on IPv6 interface eth0: LEFT
```

Backup Router

```
R1#sh vrrp
VRRP Version: 3
VMAC enabled
Backward Compatibility disabled

Address family IPv6
VRRP Id: 1 on interface: eth0
State: AdminUp - Backup
Virtual IP address: fe80::3037:3aff:fe3a:3a32 (Not-Owner)
Priority is 100
Advertisement interval: 100 centi sec
Master Advertisement interval: 100 centi sec
Skew time: 0 centi sec
```

```
Accept mode: FALSE
Preempt mode: TRUE
Multicast membership on IPv6 interface eth0: LEFT
```

Ping Output at Host A

```
[root@HstA root]#ping ipv6 fe80::3437:30ff:fe35:a6ac
PING fe80::3437:30ff:fe35:a6ac(fe80::3437:30ff:fe35:a6ac) 56 data bytes
64 bytes from fe80::3437:30ff:fe35:a6ac: icmp_seq=1 ttl=63 time=0.423 ms
64 bytes from fe80::3437:30ff:fe35:a6ac: icmp_seq=2 ttl=63 time=0.291 ms
```

GLOBAL IPV6 SUPPORT FOR VRRP

Master Router

#configure terminal	Enter the Configure mode.
(config)#interface eth0	Enter the Interface mode for eth0.
(config-if)#ipv6 address 2001::1/64	Configure global IPv6 address for interface eth0 to be in network 0.
(config-if)#commit	Commit the configurations.
(config-if)#exit	Exit the Interface mode.
(config)#interface eth1	Enter the Interface mode for eth1.
(config-if)#ipv6 address 3000::1/64	Configure global IPv6 address for interface eth1 to be in network 1.
(config-if)#commit	Commit the configurations.
(config-if)#exit	Exit the Interface mode.
(config)#router ipv6 vrrp 1 eth0	Create a VRRPv6 instance for interface eth0.
(config-router)#virtual-ipv6 fe80::1	Configure link local address as primary virtual-ip.
(config-router)#virtual-ipv6 2001::3	Configure global ipv6 address as additional virtual-ip.
(config-router)#priority 250	Set priority for master node as 250.
(config-router)#enable	Enable the VRRPv6 session on the router.
(config-router)#commit	Commit the configurations.
(config-router)#exit	Exit Router mode.
(config)#ipv6 route 4000::/64 3000::2	Configure static route to reach eth2 of router1.
(config-router)#commit	Commit the configurations.
(config-router)#exit	Exit Router mode.

Backup Router

#configure terminal	Enter the Configure mode.
(config)#interface eth0	Enter the Interface mode for eth0.
(config-if)#ipv6 address 2001::2/64	Configure global IPv6 address for interface eth0 to be in network 0.
(config-if)#commit	Commit the configurations.
(config-if)#exit	Exit the Interface mode.
(config)#interface eth1	Enter the Interface mode for eth1.
(config-if)#ipv6 address 3001::1/64	Configure global IPv6 address for interface eth1 to be in network 1.
(config-if)#commit	Commit the configurations.
(config-if)#exit	Exit the Interface mode.
(config)#router ipv6 vrrp 1 eth0	Create a VRRPv6 instance for interface eth0.
(config-router)#virtual-ipv6 fe80::1	Configure link local address as primary virtual-ip.
(config-router)#virtual-ipv6 2001::3	Configure global ipv6 address as additional virtual-ip.
(config-router)#priority 100	Set the default value for the backup router.
(config-router)#enable	Enable the VRRPv6 session on the router.
(config-router)#commit	Commit the configurations.
(config-router)#exit	Exit Router mode.
(config)#ipv6 route 4000::/64 3001::2	Configure static route to reach eth2 of router1.
(config-router)#exit	Exit Router mode.

Host A

#configure terminal	Enter the Configure mode.
(config)#bridge 1 protocol rstp vlan-bridge	Create a RSTP VLAN aware bridge with bridge-id.
(config)#vlan 100 bridge 1	Create VLAN 100 and map it to bridge 1
(config)#interface eth0	Enter the Interface mode for eth0.
(config-if)#switchport	Configure switch port.
(config-if)#bridge-group 1 spanning-tree disable	Configure bridge group to I2 interface with spanning-tree Disable
(config-if)#switchport mode trunk	Configure switch port mode as trunk
(config-if)#switchport trunk allowed vlan add 100	Allow vlan 100 on the interface
(config-if)#commit	Commit the configurations.
(config-if)#exit	Exit the Interface mode

(config)#interface eth1	Enter the Interface mode for eth1.
(config-if)#switchport	Configure switch port.
(config-if)#bridge-group 1 spanning-tree disable	Configure bridge group to I2 interface with spanning-tree Disable
(config-if)#switchport mode trunk	Configure switch port mode as trunk
(config-if)#switchport trunk allowed vlan add 100	Allow vlan 100 on the interface
(config-if)#commit	Commit the configurations.
(config-if)#exit	Exit the Interface mode.

Router 1

#configure terminal	Enter the Configure mode.
(config)#interface eth0	Enter the Interface mode for eth0.
(config-if)#ipv6 address 3000::2/64	Configure global IPv6 address for interface eth1 to be in network 1.
(config-if)#commit	Commit the configurations.
(config-if)#exit	Exit the Interface mode.
(config)#interface eth1	Enter the Interface mode for eth1.
(config-if)#ipv6 address 3001::2/64	Configure global IPv6 address for interface eth1 to be in network 1.
(config-if)#commit	Commit the configurations.
(config-if)#exit	Exit the Interface mode.
(config)#interface eth2	Enter the Interface mode for eth2.
(config-if)#ipv6 address 4000::1/64	Configure global ipv6 address for interface eth2.
(config-if)#commit	Commit the configurations.
(config-if)#exit	Exit the Interface mode.
(config)#ipv6 route 2001::/64 3001::1	Configure static route to reach eth2 of master.
(config)#ipv6 route 2001::/64 3001::1	Configure static route to reach eth2 of backup.
(config-if)#commit	Commit the configurations.
(config-if)# exit	Exit the Interface mode.

Validation

Master Router

```
OcNOS#sh vrrp
VRRP Version: 3
VMAC enabled
Backward Compatibility disabled

Address family IPv6
VRRP Id: 1 on interface: eth0
  State: AdminUp    - Master
  Virtual IP address: fe80::1 (Not-owner)
  Virtual IP address: 2001::3
  Virtual MAC address is 0000.5e00.0201
  Operational primary IP address: fe80::923c:b3ff:fe82:8d88
  Operational master IP address: fe80::923c:b3ff:fe82:8d88
  Priority is 250
  Advertisement interval: 100 centi sec
  Master Advertisement interval: 100 centi sec
  Virtual router uptime: 0 hours 1 minutes 0 seconds (6000 centi sec)
  Master uptime: 0 hours 0 minutes 57 seconds (5700 centi sec)
  Accept mode: TRUE
  Preempt mode: TRUE
  Multicast membership on IPv6 interface eth0: JOINED
  V2-Compatible: FALSE
```

Backup Router

```
OcNOS#sh vrrp
VRRP Version: 3
VMAC enabled
Backward Compatibility disabled

Address family IPv6
VRRP Id: 1 on interface: eth0
  State: AdminUp    - Backup
  Virtual IP address: fe80::1 (Not-owner)
  Virtual IP address: 2001::3
  Virtual MAC address is 0000.5e00.0201
  Operational primary IP address: fe80::1644:8fff:fe8e:32e7
  Operational master IP address: fe80::923c:b3ff:fe82:8d88
  Priority is 100
  Advertisement interval: 100 centi sec
  Master Advertisement interval: 100 centi sec
  Virtual router uptime: 0 hours 18 minutes 57 seconds (113700 centi sec)
  Skew time: 60 centi sec
  Master Down Interval: 360 centi sec
  Accept mode: TRUE
  Preempt mode: TRUE
  Multicast membership on IPv6 interface eth0: JOINED
```

V2-Compatible: FALSE

Ping From master to backup

```
[[root@HstA root]#ping ipv6 2001::2  
PING 2001::2(2001::2) 56 data bytes  
64 bytes from fe80::3437:30ff:fe35:a6ac: icmp_seq=1 ttl=63 time=0.398 ms  
64 bytes from fe80::3437:30ff:fe35:a6ac: icmp_seq=2 ttl=63 time=0.230 ms  
64 bytes from fe80::3437:30ff:fe35:a6ac: icmp_seq=3 ttl=63 time=0.234 ms  
64 bytes from fe80::3437:30ff:fe35:a6ac: icmp_seq=4 ttl=63 time=0.230 ms
```

Virtual Router Redundancy Protocol Command Reference

CHAPTER 1 VRRP Commands

This chapter describes the commands for VRRP.

- `accept-mode`
- `advertisement-interval`
- `authentication text`
- `circuit-failover`
- `debug vrrp`
- `disable`
- `enable`
- `ipv4-exclude-pseudo-header`
- `ip pim redundancy`
- `operational-ip`
- `preempt-mode`
- `priority`
- `router vrrp`
- `show debugging vrrp`
- `show running-config vrrpv6`
- `show running-config router vrrp`
- `show vrrp`
- `show vrrp summary`
- `show vrrp`
- `show vrrp (global | ipv4) statistics`
- `snmp restart vrrp`
- `switch-back-delay`
- `track decrement`
- `undebg vrrp`
- `virtual-ip`
- `vrrp compatible-v2`
- `vrrp ipv4-exclude-pseudo-header`
- `vrrp vmac`

accept-mode

Use this command to enable/disable accept mode for the session.

Controls whether a VRRP master node will accept/respond to packets addressed to the Virtual-IP address as its own address if it is not the Virtual-IP Owner.

Command Syntax

```
accept-mode true
accept-mode false
```

Parameter

None

Default

By default, accept-mode for the session is enabled

Command Mode

Router mode

Applicability

This command was introduced before OcNOS version 1.3.

Examples

The example below shows how to set and unset the accept-mode.

```
#configure terminal
(config)#router vrrp 2 eth0
(config-router)#accept-mode false

# configure terminal
(config)#router vrrp 2 eth2
(config-router)#accept-mode True
```

advertisement-interval

Use this command to configure the advertisement interval of a virtual router. This is the length of time, in seconds, between each advertisement sent from the master to its backup(s). The master virtual router sends VRRP advertisements to other VRRP routers in the same group. The advertisements communicate the priority and state of the master virtual router. The VRRP advertisements are encapsulated in IP packets and sent to the multicast address assigned to the VRRP group (224.0.0.18). Advertisements are sent every second by default.

Note: Higher-priority master routers with slower transmission rates than their backup routers are unstable. This is because low-priority nodes configured to faster rates could come online and decide they should be masters before they have heard anything from the higher-priority master with a slower rate. When this happens, it is temporary: once the lower-priority node does hear from the higher-priority Mmaster, it will relinquish mastership.

Use the `no` parameter with this command to restore the default setting.

Command Syntax

```
advertisement-interval <5-4095>
no advertisement-interval
```

Parameter

<5-4095>	Specify the advertisement interval in centi-seconds (in multiples of 5) when VRRPv3 is enabled
----------	--

Default

By default, advertisements are sent every second

Command Mode

Router mode

Applicability

This command was introduced before OcNOS version 1.3.

Examples

The example below shows how to configure an advertisement interval of 50 centi-seconds for the virtual router with VR ID 2 on interface eth0.

```
#configure terminal
(config)#router ip vrrp 2 eth0
(config-router)#advertisement-interval 50
```

authentication text

Use this command to enable authentication of VRRPv2 packets received from other routers in the group.

If configured, all routers within the VRRP group must use the same authentication string.

Authentication is supported only for VRRPv2 packets. V2-compatibility must be enabled.

Use the `no` form of this command to remove text authentication.

Command Syntax

```
authentication text TEXT-STRING
no authentication text
```

Parameter

`TEXT-STRING` Password, maximum eight alphanumeric characters

Default

By default, authentication is disabled.

Command Mode

Router mode

Applicability

This command was introduced in OcNOS version 4.2.

Examples

```
(config)#
(config)#router vrrp 1 eth3
(config-router)#v2-compatible
(config-router)#authentication text abc_123
(config-router)#end
#
```

```
(config)#router vrrp 1 eth3
(config-router)#no authentication text
(config-router)#end
#
```

circuit-failover

Use this command to enable the VRRP circuit failover feature.

Use the `no` parameter with this command to disable this feature.

Command Syntax

```
circuit-failover [IFNAME] |<1-253>
no circuit-failover [IFNAME] |<1-253>
```

Parameters

IFNAME	Specify an interface of the router that is monitored by the virtual router. This is usually an upstream interface. Should the interface go down, another router, configured as backup within the VRRP group, may take over as a master.
<1-253>	Specify the delta value. The value by which the virtual router decrements its priority value during a circuit failover event. Configure this value to be greater than the difference of priorities between the master and backup routers.

Default

By default, circuit failover feature is disabled

Command Mode

Router mode

Applicability

This command was introduced before OcnOS version 1.3.

Examples

The example below shows how to configure circuit failover for the VRRP session with VR ID 1. Interface eth1 is considered the monitored interface.

```
#configure terminal
(config)#router vrrp 1 eth0
(config-router)#circuit-failover eth1 30
```

debug vrrp

Use this command to specify debugging options for VRRP.

Use the `no` parameter with this command to disable debugging.

Command Syntax

```
debug vrrp (all|event|packet [send|recv|])
no debug vrrp (all|event|packet [send|recv|])
```

Parameters

<code>all</code>	Specify debugging options for all VRRP events.
<code>event</code>	Specify debugging options for VRRP event troubleshooting.
<code>packet</code>	Specify debugging options for VRRP packets
<code>send</code>	Specify the debug option set for sent packets.
<code>recv</code>	Specify the debug option set for received packets.

Command Mode

Configure mode and Privileged Exec mode

Applicability

This command was introduced before OcNOS version 1.3.

Examples

The example below shows how to enable all VRRP debug options.

```
#configure terminal
(config)#debug vrrp all
```

The example below shows how to enable debugging options for VRRP events.

```
#configure terminal
(config)#debug vrrp events
```

The example below shows how to enable debug options for VRRP packets sent.

```
#configure terminal
(config)#debug vrrp packet send
```

The example below shows how to enable debug options for VRRP packets received.

```
#configure terminal
(config)#debug vrrp packet recv
```

disable

Use this command to disable a VRRP session on the router (to stop the router from participating in virtual routing). When this command is configured, a backup Router assumes the Role of Master depending on its priority.

Command Syntax

```
disable
```

Parameters

None

Default

By default, VRRP session on the router is disabled

Command Mode

Router mode

Applicability

This command was introduced before OcNOS version 1.3.

Example

The example below shows how to disable a VRRP session.

```
#configure terminal
(config)#router vrrp 1 eth0
(config-router)#disable
```

enable

Use this command to enable a VRRP session on the router (to make it participate in virtual routing). To make any changes to the VRRP configuration, first disable the router from participating in virtual routing using the `disable` command.

Note: Configure the virtual IP address and define an interface for the VRRP session (using the `virtual-ip` and `interface` commands) before using this command.

Command Syntax

```
enable
```

Parameters

None

Default

By default, VRRP session on the router is disabled

Command Mode

Router mode

Applicability

This command was introduced before OcNOS version 1.3.

Example

The example below shows how to enable a VRRP session with VR ID 1 on interface eth0.

```
#configure terminal
(config)#router vrrp 1 eth0
(config-router)#enable
```

ipv4-exclude-pseudo-header

Use this command to exclude the pseudo-header in IPv4 VRRPv3 checksum calculation on the VRRP group in router mode to support IPv4 VRRPv3 interoperability.

Note: Use this command when checksum errors are observed with other vendors for VRRPv3.

Use the `no` form of this command to delete the VRRP IPv4 checksum pseudo-header exclude configuration from the VRRP group on the router.

Command Syntax

```
ipv4-exclude-pseudo-header
```

Parameter

None

Default

Disabled

Command Mode

Router mode

Applicability

This command was introduced in OcNOS-SP version 2.4.

Examples

```
#configure terminal
(config)#router vrrp 2 eth2
(config-router)#ipv4-exclude-pseudo-header
```

```
#configure terminal
(config)#router vrrp 2 eth2
(config-router)#no ipv4-exclude-pseudo-header
```

ip pim redundancy

Use this command to set the priority for which a router is elected as the designated router (DR).

Note: This command should be applied to the all related VRRP routers with identical priority values.

Command Syntax

```
ip pim redundancy <1-255> vrrp dr-priority <0-4294967294>
no ip pim redundancy vrrp
```

Parameter

<1-255> VRRP virtual router identifier
<0-4294967294> DR priority

Command Mode

Interface mode

Applicability

This command was introduced in OcNOS version 4.0.

Examples

```
#configure terminal
(config)#interface eth0
(config-if)#ip pim redundancy 1 vrrp dr-pripiroty 900

(config)#interface eth0
(config-if)#no ip pim redundancy vrrp
```

operational-ip

Use this command to set the primary IPv4 address.

Use the no parameter with this command to remove a primary IPv4 address.

Command Syntax

```
operational-ip A.B.C.D
no operational-ip
```

Parameters

A.B.C.D IPv4 address.

Default

No default value is specified

Command Mode

Router mode

Applicability

This command was introduced before OcNOS version 1.3.

Example

```
#configure terminal
(config)#router vrrp 1 eth0
(config-router)#operational-ip 1.2.3.4
```

preempt-mode

Use this command to configure preempt mode. If set to `true`, the highest priority backup is always the master when the default master is unavailable. If set to `false`, a higher priority backup does not preempt a lower priority backup which is acting as master.

When the master router fails, the backup routers come online in priority order — highest to lowest. Preempt mode set to `true` allows a higher priority backup router to relieve a lower priority backup.

By default, a preemptive scheme is enabled whereby a higher priority backup virtual router that becomes available takes over for the backup virtual router that was elected to become master virtual router. This preemptive scheme can be disabled using the `preempt-mode false` command. If preemption is disabled, the backup virtual router that is currently elected as Master does not transition to backup again when the alternate backup router with higher priority becomes available.

Command Syntax

```
preempt-mode (true|false)
```

Parameters

<code>true</code>	Specify that preemption is enabled.
<code>false</code>	Specify that preemption is disabled.

Default

By default, preempt mode is `true`

Command Mode

Router mode

Applicability

This command was introduced before OcnOS version 1.3.

Examples

The example below shows how to enable the preempt mode.

```
#configure terminal
(config)#router vrrp 1 eth0
(config-router)#preempt-mode false

#configure terminal
(config)#router vrrp 1 eth0
(config-router)#preempt-mode true
```

priority

Use this command to configure the priority to use by this VRRP router in master election. The value of 255 (decimal) is reserved for the router that owns the IP address associated with the virtual router. The value of 0 (zero) is reserved for the master router to indicate it is releasing responsibility for the virtual router. Higher values indicate higher priorities.

Use the `no` parameter with this command to restore the default setting.

Command Syntax

```
priority <1-254>
no priority
```

Parameter

<1-254>	Priority of a virtual router.
---------	-------------------------------

Default

100 (non-owner)

255 (owner)

Command Mode

Router mode

Applicability

This command was introduced in OcNOS version 4.2.

Examples

The example below shows how to configure priority 50 for the virtual router with VR ID 2 on interface eth0.

```
#configure terminal
(config)#router ip vrrp 2 eth0
(config-router)#priority 50
```

router vrrp

Use this command to enable a VRRP routing process.

Use the `no` form of this command to disable a VRRP routing process.

Command Syntax

```
router vrrp <1-255> IFNAME
no router vrrp <1-255> IFNAME
```

Parameters

<1-255>	Virtual router identifier
IFNAME	Interface name

Default

No default value is specified

Command Mode

Configure mode

Applicability

This command was introduced before OcNOS version 1.3.

Example

```
#configure terminal
(config)#router vrrp 1 eth0
```

show debugging vrrp

Use this command to display the set VRRP debugging option.

Command Syntax

```
show debugging vrrp
```

Parameters

None

Command Mode

Exec mode and Privileged Exec mode

Applicability

This command was introduced before OcNOS version 1.3.

Example

```
#show debugging vrrp
VRRP debugging status:
VRRP event debugging is on
VRRP packet debugging is on
```

show running-config vrrpv6

Use this command to show the running configuration for VRRPv6.

Command Syntax

```
show running-config router vrrpv6
```

Parameters

None

Command Mode

Exec mode

Applicability

This command was introduced before OcNOS version 3.0.

Example

```
#show running-config vrrpv6
!  
vrrp vmac disable  
!  
!  
router ipv6 vrrp 1 eth1  
virtual-ipv6 fe80::c0  
enable  
!
```

show running-config router vrrp

Use this command to show the running configuration for VRRP.

Command Syntax

```
show running-config router vrrp
```

Parameters

None

Command Mode

Exec mode

Applicability

This command was introduced before OcNOS version 1.3.

Example

The example below shows the running configuration of VRRP. Virtual Router is configured as Master and Owner of IP address.

```
#show running-config router vrrp
!
router vrrp 1 eth0
  virtual-ip 39.0.0.24 owner
  advertisement-interval 5
  preempt-mode false
  enable
!
```

show vrrp

Use this command to display a list of virtual router identifiers that are configured on the router.

Command Syntax

```
show vrrp
```

Parameters

None

Command Mode

Exec mode and Privileged Exec mode

Applicability

This command was introduced before OcNOS version 1.3.

Example

```
#show vrrp

R1#show vrrp
VrId <1>
State is Master
Virtual IP is 10.10.12.6 (IP owner)
Interface is eth0
Priority is 255
Advertisement interval: 5 centi sec
Preempt mode is TRUE

R2#show vrrp
VrId <1>
State is Backup
Virtual IP is 10.10.12.6 (Not IP owner)
Interface is eth0
Priority is 100
Advertisement interval: 5 centi sec
Preempt mode is TRUE
```

[Table 1-91](#) Explains the show command output fields.

Table 1-91: show vrrp output fields

Field	Description
VrID	Type of vr identifier by the system on the interface.
State	VRRP State: Master — The interface is acting as the master router interface. Backup —The interface is acting as the backup router interface.
Virtual IP	List of virtual IP addresses configured on the interface.
Interface	Name of the logical interface.

Field	Description
Priority	Configured VRRP priority for the interface.
Advertisement interval	Configured VRRP advertisement interval.
Preempt mode	Whether preemption is allowed on the interface.

show vrrp summary

Use this command to display a brief list of virtual router identifiers that are configured on the router.

Command Syntax

```
show vrrp summary
```

Parameters

None

Command Mode

Exec mode and Privileged Exec mode

Applicability

This command was introduced in OcNOS version 4.2.

Example

```
#show vrrp summary
VRRP Version: 3
VMAC enabled
Backward Compatibility disabled
```

Interface	Admin	IpVersion	VRGroup	VRState	Priority	VIP	InterfaceIp
eth3	Up	IPv4	255	Master	255	66.0.0.1	66.0.0.1
eth3	Up	IPv6	1	Master	250	fe80::1	fe80::2
Total Number of IPv4 VRRP group 1							
Total Number of IPv6 VRRP group 1							

[Table 1-92](#) explains the show command output fields.

Table 1-92: show vrrp summary output fields

Field	Description
interface	Interface name on which vrrp session is active.
Admin	Administrative state of the session Up/Down.
IpVersion	Internet protocol version IPv4 or IPv6.
VRGroup	Vrrp Group the router is part of.
priority	Configured VRRP priority for the interface.
VRState	VRRP State: Master - The interface is acting as the master router interface. Backup -The interface is acting as the backup router interface.
VIP	List of virtual IP addresses configured on the interface.
InterfaceIp	Primary IP address on the interface.

show vrrp

Use this command to display VRRP information for a virtual router.

Command Syntax

```
show vrrp <1-255> IFNAME
```

Parameters

<1-255>	Virtual router identifier
IFNAME	Interface name

Command Mode

Exec mode and Privileged Exec mode

Applicability

This command was introduced before OcnOS version 1.3.

Example

```
#show vrrp 7 eth0
```

show vrrp (global | ipv4) statistics

Use this command to display VRRP global or ipv4 router statistics.

Command Syntax

```
show vrrp (global | ipv4 ) statistics
```

Parameters

global	Global (VRRP Router)
ipv4	VRRP IPv4 router

Command Mode

Exec mode and Privileged Exec mode

Applicability

This command was introduced before OcNOS version 1.3.8.

Example

```
#show vrrp global statistics
VRRP Global Statistics
Checksum Errors   : 0
Version Errors   : 0
VRid Errors       : 0
Discontinuity Time: 00 hour, 00 min, 00 sec
```

```
#show vrrp ipv4 statistics
Address family IPv4
VRRP Id: 1 on interface: xe1
Master Transitions: 0
Advertisements Rcvd: 0
Pkts Rcvd with IP TTL Errors: 0
Pkts Rcvd with Zero Priority: 0
Pkts Sent with Zero Priority: 0
Pkts Rcvd with Invalid TYPE: 0
Pkts Rcvd with Packet Length Errors: 0
Pkts Rcvd with IP Count Mismatch: 0
Discontinuity Time: 00 hour, 00 min, 00 sec
Refresh Rate: 1000 ms
```

snmp restart vrrp

Use this command to restart SNMP in Virtual Routing Redundancy Protocol (VRRP).

Command Syntax

```
snmp restart vrrp
```

Parameters

None

Default

By default, SNMP restart is disabled

Command Mode

Configure mode

Applicability

This command was introduced before OcNOS version 1.3.

Examples

```
#configure terminal
(config)#snmp restart vrrp
```

switch-back-delay

Use this command to set a switch-back delay timer for the master VRRP router. This feature prevents the original master VRRP router from transitioning back to the master state after coming back online until the configured delay timer has expired.

Command Syntax

```
switch-back-delay <1-500000>
no switch-back-delay
```

Parameters

<1-500000> Specify a switch-back delay in milliseconds.

Command Mode

Router mode

Default

By default, the switch-back delay is set to 0

Applicability

This command was introduced before OcnOS version 1.3.

Examples

The example below shows how to set a switch-back delay timer of 7000 milliseconds.

```
#configure terminal
(config)#router vrrp 5 eth1
(config-router)#switch-back-delay 7000
```

track decrement

Use this command to decrement the priority value during a down event.

Use the `no` form of this command to not decrement the priority value during a down event.

Command Syntax

```
track <0-500> decrement <1-253>
no track <1-500>
```

Parameters

<1-500>	Identifier of the tracked object.
<1-253>	Priority delta value. The value by which the virtual router decrement its priority value during a down event. Configure this value to be greater than the difference of priorities between the master and backup routers.

Command Mode

VRRP router Mode

Applicability

This command was introduced in OcNOS version 5.1

Example

```
(config)#router vrrp 1 eth1
(config-router)#virtual-ip 11.0.0.5
(config-router)#track 1 decrement 30
```

undebug vrrp

Use this command to disable debugging options for VRRP.

Command Syntax

```
undebug vrrp (all|event|packet [send|recv|])
no undebug vrrp (all|event|packet [send|recv|])
```

Parameters

all	Specify debugging options for all VRRP events.
event	Specify debugging options for VRRP event troubleshooting.
packet	Specify debugging options for VRRP packets
send	Specify the debug option set for sent packets.
recv	Specify the debug option set for received packets.

Command Mode

Privileged Exec mode

Applicability

This command was introduced before OcNOS version 1.3.

Examples

```
#undebug vrrp all
```

The example below shows how to disable debug options for VRRP events.

```
#undebug vrrp events
```

The example below shows how to disable debug options for VRRP packets sent.

```
#undebug vrrp packet send
```

The example below shows how to disable debug options for VRRP packets received.

```
#undebug vrrp packet recv
```

virtual-ip

Use this command to set the virtual IP address for the VRRP virtual router as VRRP Owner. This is the IP address used by end hosts to address their default gateway.

The VRRP Owner of the Virtual IP address only responds to packets destined to the Virtual IP address (for example, ICMP packets destined to the Virtual IP address).

Use the `no` parameter with this command to remove a virtual IP address assignment.

Syntax Description

```
virtual-ip A.B.C.D (owner|)
no virtual-ip (owner|)
```

Parameters

A.B.C.D	Virtual IP address of the interface that participates in virtual routing.
owner	IP address as the owner.

Default

No default value is specified

Command Mode

Router mode

Applicability

This command was introduced before OcnOS version 1.3.

Example

The example below shows how to configure the router as VRRP owner.

```
#configure terminal
(config)#router vrrp 1 eth0
(config-router)#virtual-ip 10.10.20.30 owner
```

The example below removes the virtual IP address assignment.

```
#configure terminal
(config)#router vrrp 1 eth0
(config-router)#no virtual-ip
```

vrrp compatible-v2

Use this command to enable the backward-compatibility feature. When enabled, both VRRPv3 and VRRPv2 inter-operation are supported.

Command Syntax

```
vrrp compatible-v2 (enable| disable)
```

Parameters

enable	Enable VRRPv2 inter-operation
disable	Disable VRRPv2 inter-operation

Default

By default, vrrp compatible-v2 is enabled

Command Mode

Configure mode

Applicability

This command was introduced before OcnOS version 1.3.

Examples

```
#configure terminal  
(config)#vrrp compatible-v2 enable
```

vrrp ipv4-exclude-pseudo-header

Use this command to excludes the pseudo-header in IPv4 VRRPv3 checksum calculation on the VRRP groups in configuration mode to support IPv4 VRRPv3 interoperability.

Note: Use this command when checksum errors are observed with other vendors for VRRPv3.

Command Syntax

```
vrrp ipv4-exclude-pseudo-header (enable| disable)
```

Parameters

enable	Enable ipv4-exclude-pseudo-header
disable	Disable ipv4-exclude-pseudo-header

Default

By default, VRRP includes the pseudo header in checksum calculation.

Command Mode

Configure mode

Applicability

This command was introduced in OcNOS-SP version 2.4.

Examples

```
#configure terminal  
(config)#vrrp ipv4-exclude-pseudo-header enable
```

```
#configure terminal  
(config)#vrrp ipv4-exclude-pseudo-header disable
```

vrrp vmac

Use this command to enable or disable Virtual MAC (VMAC).

This command affects all VRRP groups in a router. On a single network segment, multiple VRRP groups can be configured, each using a different VMAC. The use of VMAC addressing allows for faster switchover when a backup router assumes the master role. When this command is used to enable a VMAC, the virtual router forwards packets with a special-purpose multicast VMAC address (0:0:5e:0:01:<VR ID>). Otherwise, it forwards with its interface's physical address.

The VMAC address is assigned to a router interface at the time the VRRP group is enabled in the router.

Command Syntax

```
vrrp vmac (enable|disable)
```

Parameters

<code>enable</code>	Enable virtual MAC addressing.
<code>disable</code>	Disable virtual MAC addressing and use physical MAC addressing.

Default

By default, VMAC is disabled

Command Mode

Configure mode

Applicability

This command was introduced before OcnOS version 1.3.

Example

The example below shows how to enable a virtual MAC address on the router.

```
#configure terminal
(config)#vrrp vmac enable
```

The example below shows how to disable a virtual MAC address on the router.

```
#configure terminal
(config)#vrrp vmac disable
```

CHAPTER 2 VRRP v6 Commands

This chapter describes the commands for VRRP IPv6.

- [advertisement-interval](#)
- [circuit-failover](#)
- [disable](#)
- [enable](#)
- [preempt-mode](#)
- [priority](#)
- [router ipv6 vrrp](#)
- [router ipv6 vrrp vlan](#)
- [show running-config router ipv6 vrrp](#)
- [virtual-ipv6](#)

advertisement-interval

Use this command to configure the advertisement interval of a virtual router. This is the length of time, in seconds, between each advertisement sent from the master to its backup(s). The master virtual router sends VRRP advertisements to other VRRP routers in the same group. The IPv6 VRRP advertisements are sent to the multicast address assigned to the VRRP IPv6 group (FF02:0:0:0:0:XXXX:XXXX) and a backup virtual router has to join all multicast groups within this range. As a convenient assignment, OcnOS sends a VRRP advertisement to the multicast address FF02::12. The advertisements are sent every second by default.

Note: VRRP Master router and backup routers should be configured with the same advertisement interval. If there is a mismatch in the configuration, VRRP goes to the INIT state.

Use the `no` parameter with this command to restore the default setting.

Command Syntax

```
advertisement-interval <5-4095>
no advertisement-interval
```

Parameter

<5-4095> Specify the advertisement interval in centi-seconds (multiples of 5) when VRRPv3 is enabled

Command Mode

Router mode

Applicability

This command was introduced before OcnOS version 1.3.

Examples

The example below shows how to configure an advertisement interval of 10 seconds for the virtual router with VR ID 3 on interface eth0.

```
#configure terminal
(config)#router ipv6 vrrp 3 eth0
(config-router)#advertisement-interval 10
```

circuit-failover

Use this command to enable the VRRP circuit failover feature.

Use the `no` parameter with this command to disable this feature.

Command Syntax

```
circuit-failover IFNAME <1-253>
no circuit-failover IFNAME <1-253>
no circuit-failover (IFNAME|)
```

Parameters

IFNAME	Specify an interface of the router that is monitored by the virtual router. This is usually an upstream interface. Should the interface go down, another router, configured as backup within the VRRP group, may take over as a master.
<1-253>	Specify the delta value. The value by which the virtual router decrements its priority value during a circuit failover event. Configure this value to be greater than the difference of priorities between the master and backup routers.

Command Mode

Router mode

Applicability

This command was introduced before OcNOS version 1.3.

Examples

The example below shows how to configure circuit failover for the VRRP session with VR ID 1. Interface eth1 is considered the monitored interface.

```
#configure terminal
(config)#router ipv6 vrrp 1 eth0
(config-router)#circuit-failover eth1 30
```

disable

Use this command to disable a VRRP session on the router (to stop the router from participating in virtual routing). Refer to [enable](#) to enable a VRRP session on the router.

When this command is configured, a backup router assumes the role of master depending on its priority.

Command Syntax

```
disable
```

Parameters

None

Command Mode

Router mode

Applicability

This command was introduced before OcNOS version 1.3.

Example

The example below shows to disable VRRP session.

```
#configure terminal
(config)#router ipv6 vrrp 1 eth0
(config-router)#disable
```

enable

Use this command to enable a VRRP session on the router, so the router participates in virtual routing. To make any changes to the VRRP configuration, first disable the Router from participating in Virtual Routing using the `disable` command.

Note: Configure the virtual IP address and define an interface for the VRRP session (using the `virtual-ip` and `interface` commands) before using this command.

Command Syntax

```
enable
```

Parameters

None

Command Mode

Router mode

Applicability

This command was introduced before OcNOS version 1.3.

Example

The example below shows to enable VRRP session with VR ID 1 on interface eth0

```
#configure terminal
(config)#router ipv6 vrrp 1 eth0
(config-router)#enable
```

preempt-mode

Use this command to configure preempt mode. If set to `true`, the highest priority backup is always the master when the default master is unavailable. If set to `false`, a higher priority backup does not preempt a lower priority backup that is acting as master.

When the master router fails, the backup routers come online in priority order — highest to lowest. Preempt mode set to `true` allows a higher priority backup router to relieve a lower priority backup.

By default, a preemptive scheme is enabled whereby a higher priority backup virtual router that becomes available takes over for the backup virtual router that was elected to become master virtual router. This preemptive scheme can be disabled using the `preempt-mode false` command. If preemption is disabled, the backup virtual router that is currently elected as Master does not transition to backup again when the alternate backup router with higher priority becomes available.

Command Syntax

```
preempt-mode true
preempt-mode false
```

Parameters

<code>true</code>	Specify that preemption is enabled.
<code>false</code>	Specify that preemption is disabled.

Default

Default is `true`.

Command Mode

Router mode

Applicability

This command was introduced before OcnOS version 1.3.

Example

The example below shows to configure preempt mode as False.

```
#configure terminal
(config)#router ipv6 vrrp 1 eth0
(config-router)#preempt-mode false
```

priority

Use this command to configure the VRRP router priority within the virtual router. Priority determines the role that each VRRP router plays and what happens if the master virtual router fails. If a VRRP router owns the IP address of the virtual router and the IP address of the physical interface, this router functions as the master virtual router.

Priority also determines whether a VRRP router functions as a backup virtual router and the order of ascendancy to becoming a master virtual router if the master virtual router fails.

Use the `no` parameter with this command to disable this feature.

Command Syntax

```
priority <1-255>
no priority
```

Parameter

<1-255>	Specify a priority. For the master router, specify 255; otherwise use any number in the range <1-254>.
---------	--

Default

Default values for priority are:

- master router = 255
- backup = 100

Command Mode

Router mode

Applicability

This command was introduced before OcNOS version 1.3.

Examples

The example below shows to set the priority

```
#configure terminal
(config)#router ipv6 vrrp 1 eth0
(config-router)#priority 101
```

router ipv6 vrrp

Use this command to associate an IPv6 interface with a VRRP session. When issued, this command enters the `Router mode`.

Use the `no` parameter with this command to remove the IPv6 VRRP configuration. Disable the IPv6 VRRP session before using this command.

Command Syntax

```
router ipv6 vrrp <1-255> IFNAME
no router ipv6 vrrp <1-255> IFNAME
```

Parameters

<code><1-255></code>	Specify the ID of the virtual router session to create.
<code>IFNAME</code>	Specify the name of the IPv6 interface on which VRRP is enabled.

Command Mode

Configure mode

Applicability

This command was introduced before OcnOS version 1.3.

Example

The example below shows how to enable an IPv6 VRRP session with VR ID 1 on interface eth0.

```
#configure terminal
(config)#router ipv6 vrrp 1 eth0
(config-router)#
```

router ipv6 vrrp vlan

Use this command to associate a VLAN with a VRRP session. When issued, this command enters the `Router` mode.

Use the `no` parameter with this command to remove the IPv6 VRRP configuration. Disable the IPv6 VRRP session before using this command.

Command Syntax

```
router ipv6 vrrp <1-255> vlan <1-4094>
no router ipv6 vrrp <1-255> vlan <1-4094>
```

Parameters

<1-255>	Specify a virtual router identifier. Must be unique for each routing process.
<1-4094>	Specify the actual VLAN identifier

Command Mode

Configure mode

Applicability

This command was introduced before OcnOS version 1.3.

Examples

This example shows the use of the `router vrrp` command to enter router mode. Note the change in the prompt.

```
#configure terminal
(config)#router ipv6 vrrp 100 vlan 123
(config-router)#
```

show running-config router ipv6 vrrp

Use this command to show the running configuration for VRRP.

Command Syntax

```
show running-config router ipv6 vrrp
```

Parameters

None

Command Mode

Exec mode and Privileged Exec mode

Applicability

This command was introduced before OcNOS version 1.3.

Example

The example below shows the running configuration of IPv6 VRRP. Virtual Router is configured as Master and Owner of IP address.

```
#show running-config router ipv6 vrrp
!
router ipv6 vrrp 1 eth0
  virtual-ip fe80::202:b3ff:fed5:983e master
  circuit-failover eth1 30
  advertisement-interval 6
  preempt-mode false
  enable
!
#
```

virtual-ipv6

Use this command to set the virtual IPv6 address for the VRRP virtual router. This is the IPv6 address used by end hosts to address their default gateway. A maximum of one link-local and one global IPv6 address can be configured as virtual IP.

The VRRP Owner of the Virtual IPv6 address only responds to packets destined to the Virtual IPv6 address.

Use the no parameter with this command to remove a virtual IPv6 address assignment.

Syntax Description

```
virtual-ipv6 X:X::X:X (owner|)
no virtual-ip (X:X::X:X |)
```

Parameters

X:X::X:X	Virtual IPv6 address of the interface that participates in virtual routing.
owner	Specify the IPv6 address as the owner.

Command Mode

Router mode

Applicability

This command was introduced before OcnOS version 1.3.

Example

The example below shows how to configure a router as VRRP Owner:

```
#configure terminal
(config)#router ipv6 vrrp 1 eth1
(config-router)#virtual-ipv6 fe80::1 owner
(config-router)#virtual-ipv6 2001::10
```

The example below removes the virtual IP address assignment.

```
#configure terminal
(config)#router ipv6 vrrp 1 eth1
(config-router)#no virtual-ipv6
```

Index

A

- ABRs 1909
- accept-lifetime 2008, 2141
- adding IP addresses to VLAN interface 998
- adding multiple instances of same AS to administer route selection 128
- Address Resolution Protocol 2263
- advantages
 - offload IP traffic from backbone routers 1087
 - reduced system cost 1087
 - simplified maintenance 1087
 - simplified network design 1087
- advantages of hybrid switch 1087
- advertisement interval, VRRP Commands
 - advertisement-interval 2510
- aggregate-address 2190
- aggregate-address command 1589
- aggregate-nexthop-check 1401
- area
 - authentication 1743
- area authentication 1743
- Area Border Router
 - configuring 634
- Area Border Router in OSPFv3 776
- Area Border Routers 1909
- area default cost 1744
- area default-cost 1906
- area filter-list 1745
- area nssa 1760, 1907
- area range 1762, 1909
- area shortcut 1764
- area stub 1765, 1910
- area virtual-link 1766, 1911
- area-password 2012
- area-password command 2012
- authentication 2343
- authentication BGP 81
- authentication commands
 - accept-lifetime 2141
 - ip rip authentication key-chain 2153
 - ip rip authentication mode md5 2154
 - ip rip authentication string 2155
 - key chain 2162
 - send-lifetime 2175
- authentication key-chain 2013
- authentication mode md5 2014
- authentication OSPF 653
- authentication rip multiple keys 1045
- authentication rip-multiple keys 1053
- authentication send-only 2015
- auto-cost reference bandwidth 1769
- auto-cost reference-bandwidth 1913
- auto-summary 1400

B

- backward compatibility 2442
- begin modifier 38
- bfd 2367
 - bfd all-interfaces 1770
 - bfd auth type 2366
- BFD Configuration 2303
 - Echo Function 2303
 - Echo Interval 2310
 - Multi-hop Peer Timer 2306
 - Single-hop Session Timer 2308
 - Slow Timer 2305
 - Topology 2303
- bfd echo 2368
- bfd echo interval 2369
- bfd interval 2371
- bfd multihop-peer 2372
- bfd multihop-peer A.B.C.D interval 2374
- bfd multihop-peer X::X::X:X interval 2375
- bfd notification 2376
- BFD protocol commands 2403
 - debug ospf bfd 2408
 - IS-IS
 - isis bfd 2410
- BFD Protocol Configurations 2313
- bfd slow-timer 2378
- BFD Static Configurations 2339
 - Topology 2339
- bfd-firmware 2371
- BGP 1367
- BGP Commands
 - address-family 1397, 1580
 - aggregate-address 1399
 - auto-summary 1400
 - bgp aggregate-nexthop-check 1401
 - bgp always-compare-med 1402
 - bgp bestpath as-path ignore 1404
 - bgp bestpath compare-confed-asm 1406
 - bgp bestpath compare-routerid 1407
 - bgp bestpath med 1409
 - bgp client-to-client reflection 1412
 - bgp cluster-id 1413
 - bgp confederation identifier 1414
 - bgp confederation peer 1415
 - bgp config-type 1416
 - bgp dampening 1417
 - bgp default local-preference 1419
 - bgp deterministic med 1420
 - bgp enforce-first-as 1421
 - bgp extended-asn-cap 1422
 - bgp fast-external-failover 1423
 - bgp g-shut 1426, 1570
 - bgp g-shut-capable 1427, 1571
 - bgp g-shut-local-preference 1428, 1572
 - bgp log-neighbor-changes 1429
 - bgp nexthop delay 1432
 - bgp nexthop enable 1433
 - bgp rfc1771-path-select 1434

- bgp rfc1771-strict 1435
 - bgp router-id 1436
 - bgp scan-time 1437
 - bgp update-delay 1440, 1573
 - clear bgp * 1442
 - clear bgp A.B.C.D|X:X::X:X 1441, 1593
 - clear bgp external 1450
 - clear bgp peer-group 1453, 1596
 - clear ip bgp A.B.C.D
 - clear ip bgp A.B.C.D 1457
 - clear ip bgp ASN 1445, 1449
 - clear ip bgp dampening 1449
 - clear ip bgp flap-statistics 1452
 - clear ip bgp view 1457
 - debug bgp 1462
 - distance 1467
 - exit address family mode 1468
 - ip as-path access-list 1469
 - ip community-list 1470, 1474
 - ip community-list expanded 1472
 - ip community-list standard 1473
 - ip extcommunity-list
 - expanded 1477
 - extended 1476
 - standard 1475, 1478
 - neighbor
 - activate 1485
 - advertisement-interval 1486
 - capability dynamic 1492
 - capability graceful-restart 1493, 1574
 - capability orf prefix-list 1494
 - capability route-refresh 1496
 - collide-established 1496
 - default-originate 1497
 - distribute-list 1502
 - dont-capability-negotiate 1503
 - ebgp-multihop 1504
 - enforce-multihop 1505
 - fall-over bfd 1508
 - filter-list 1508
 - maximum-prefix 1513
 - next-hop-self 1514
 - peer-group add 1518
 - port 1521
 - remote-as 1525
 - remove private-as 1527
 - restart-time 1528, 1577
 - route-map 1529
 - route-reflector-client 1531
 - send-community 1533
 - shutdown 1535
 - strict-capability-match 1537
 - timers 1538
 - unsuppress-map 1540
 - update-source 1541
 - version 1542
 - weight 1543
 - neighbor attribute-unchanged 1490
 - neighbor disallow-infinite-holdtime 1501
 - neighbor g-shut 1509, 1575
 - neighbor g-shut-timer 1510, 1576
 - neighbor passive 1517
 - neighbor prefix-list 1523
 - network 1546
 - network and network backdoor 1601
 - redistribute 1549
 - restart bgp graceful 1551
 - router bgp 1552
 - show
 - ip bgp cidr-only 1676
 - ip bgp community 1628
 - ip bgp community-info 1677
 - ip bgp community-list 1630
 - ip bgp filter-list 1637
 - ip bgp view 1670
 - ip protocols bgp 1693
 - show bgp neighbors received prefix-filter 1652
 - show bgp neighbors received-routes 1653
 - show bgp neighbors routes 1655
 - show bgp paths 1660
 - show bgp prefix-list 1661
 - show bgp quote-regexp 1662
 - show bgp route-map 1664
 - show bgp summary 1667
 - show ip bgp inconsistent-as 1639
 - show ip extcommunity-list 1692
 - synchronization 1555
 - timers 1556
- BGP community value
 - command syntax 36
- BGP configuration 47
 - adding multiple instances of same AS to administer route selection 128
 - configuring BGP Confederation 67
 - configuring BGP distance 167
 - configuring BGP Extended Community attributes 137
 - configuring BGP Four-Byte AS 133
 - configuring BGP weight per peer basis 171
 - configuring Next-hop Tracking 158
 - configuring Next-hop Tracking delay timer 160
 - enabling BGP- different autonomous systems 49
 - enabling EBGP Multihop 81
 - enabling peer groups 115
 - removing Multi-Exit Disc attribute from update messages 130
 - route reflector 52
 - route-map 50
- bgp dampening 1417
- bgp g-shut 1426, 1570
- bgp g-shut-capable 1427, 1571
- bgp g-shut-local-preference 1428, 1572
- BGP VPN Commands
 - clear ip bgp * vpnv4 1606
 - clear ip bgp <1-4294967295> vpnv4 1608
 - clear ip bgp A.B.C.D vpnv4 1610

- debug bgp mpls 1611
- import map 1614
- ip vrf 1614
- neighbor
 - send-community 1617
- neighbor allow-egbp-vpn 1615
- neighbor as-override 1616
- neighbor send-community 1617
- neighbor soo 1618
- rd (route distinguisher) 1619
- route-target 1620
- show ip vrf 1695
- site-of-origin 1618
- BGP4+ Commands
 - aggregate-address 1589
 - network and network backdoor 1601
- BGP4+ configuration 241
 - confederations 256
 - enable eBGP peering 247
 - enable iBGP peering 241
 - enable iBGP peering-link-local address 244
 - graceful restart 259
 - route reflector 254
 - route-map 250
- Bidirectional Forwarding Commands 2363
- Border Gateway BC Protocol (BGP) 1367
- braces
 - command syntax 35
- C**
- capability opaque 1773
- capability restart 1895
- capability restart graceful 1915, 1986
- circuit-failover 2483, 2511
- cisco-metric-behavior 2143, 2191
- clear bgp
 - * 1442
 - A.B.C.D|X::X:X 1441, 1593
 - external 1450
 - peer-group 1453, 1596
- clear bgp ipv6
 - A.B.C.D| X::X:X 1441, 1593
 - external 1450
 - peer-group 1453, 1596
- clear clns is-neighbors 2019
- clear clns neighbors 2018
- clear data from RIPng routing table 2192
- clear ip bgp
 - ASN 1445, 1449
 - view 1457
- clear ip bgp * vpnv4 1606
- clear ip bgp <1-4294967295> vpnv4 1608
- clear ip bgp A.B.C.D vpnv4 1610
- clear ip ospf process 1776
- clear ip rip route 2144
- clear ip route kernel 1283
- clear ipv6 ospf process 1915
- clear ipv6 rip route 2192
- clear isis interface counter 2023
- clear isis process 2024
- clear isis route 2020
- collide-established 1496
- command abbreviations 34
- command completion 34
- command line
 - errors 34
 - help 33
 - keyboard operations 37
- command modes 41
 - configure 41
 - exec 41
 - interface 41
 - privileged exec 41
 - router 41
- command negation 35
- command syntax
 - ? 36
 - . 36
 - () 35
 - { } 35
 - | 35
 - A.B.C.D/M 36
 - AA:NN 36
 - BGP community value 36
 - braces 35
 - conventions 35
 - curly brackets 35
 - HH:MM:SS 36
 - IFNAME 36
 - interface name 36
 - IPv4 address 36
 - IPv6 address 36
 - LINE 36
 - lowercase 35
 - MAC address 36
 - monospaced font 35
 - numeric range 36
 - parentheses 35
 - parentheses 35
 - period 36
 - question mark 36
 - square brackets 36
 - time 36
 - uppercase 35
 - variable placeholders 36
 - vertical bars 35
 - WORD 36
 - X::X:X 36
 - X::X:X/M 36
 - XX:XX:XX:XX:XX:XX 36
- common commands 1319
 - match as-path 1323
 - match community 1324
 - match interface 1326
 - match ip address 1327
 - match ip address prefix-list 1328
 - match ip next-hop 1329

- match ip next-hop prefix-list 1330
 - match ipv6 address 1332
 - match ipv6 address prefix-list 1333
 - match ipv6 next-hop 1334
 - match metric 1337
 - match origin 1338
 - match route-type 1339
 - match tag 1340
 - route-map 1341
 - set as-path 1343
 - set atomic-aggregate 1344
 - set comm-list delete 1345
 - set community 1346
 - set dampening 1348
 - set extcommunity 1349
 - set ip next-hop 1352
 - set ipv6 next-hop 1353
 - set level 1354
 - set metric 1356
 - set metric-type 1357
 - set origin 1358
 - set originator-id 1359
 - set tag 1360
 - set vpnv4 next-hop 1361
 - set weight 1362
 - compatible rfc1583 1777
 - confederations 256
 - Configuration
 - BFD Configuration in BGP 2329
 - BFD Configuration in IS-IS 2326
 - OSPF—BFD Multi-hop Session 2322
 - configure
 - Area Border Router for OSPFv3 776
 - BGP 47
 - BGP authentication 81
 - BGP4+ 241
 - distance 895
 - graceful restart 895
 - IP address on VLAN 998
 - IS-IS 851
 - IS-IS-IPv6 906
 - metric 864
 - OSPF 625
 - OSPFv3 769
 - passive interface 901
 - RIPng 1063
 - route leaking 884
 - route summarization 890
 - route-map 50
 - VLAN interfaces 997
 - configure hybrid switch as a layer-2 switch 1088
 - configure hybrid switch as port-based VLAN 1089
 - configure hybrid switch to work as a router or switch 1088
 - configure hybrid switch to work as I-3 router 1088
 - configure I-2 and I-3 protocols 1088
 - configure mode 41
 - Configure Multipath eBGP 180
 - Configure Multipath iBGP 192
 - configure static RIPng routes 2208
 - configuring BGP Confederation 67
 - configuring BGP Extended Community attributes 137
 - configuring BGP Four-Byte AS 133
 - configuring Layer-2 interfaces 1090
 - configuring Layer-3 interfaces 1090
 - configuring OSPF
 - redistributing routes into OSPF 639
 - configuring preempt mode 2490, 2514
 - configuring RIPng
 - enable RIPng 1063
 - Configuring VRRP
 - one virtual router 2423
 - two backup routers 2430
 - two virtual routers 2426
 - configuring VRRP IPv6 2467
 - control-admin-state 2226
 - cost
 - OSPF 640
 - creating a VLAN interface 997
 - cspf default-retry-interval 1998
 - cspf tie-break 2002
 - CSPF-TE Commands
 - cspf default-retry-interval 1998
 - cspf tie-break 2002
 - curly brackets
 - command syntax 35
- ## D
- damped route 1674
 - debug bfd all 2379
 - debug bgp events 1462
 - debug bgp filters 1462
 - debug bgp fsm 1462
 - debug bgp keepalives 1462
 - debug bgp mpls 1611
 - debug bgp updates 1462
 - debug ip ospf graceful-restart 1779, 1896
 - debug ipv6 ospf 1916
 - ifsm 1919
 - packet 1923
 - debug ipv6 ospf lsa 1920
 - debug ipv6 ospf nfm 1921
 - debug ipv6 ospf nsm 1922
 - debug ipv6 ospf packet 1923
 - debug ipv6 ospf route 1926
 - debug ipv6 rip 2193
 - debug isis 2025
 - debug ospf 1782
 - packet 1790
 - debug ospf database-timer rate-limit 1784
 - debug ospf events 1785
 - debug ospf ifsm 1786
 - debug ospf lsa 1787
 - debug ospf nfm 1788
 - debug ospf nsm 1789
 - debug ospf packet 1790
 - debug ospf route 1792
 - debug ospf6 packet 1923

debug rib 1287
 debug vrrp 2484
 default-information originate 1793, 1927, 2027, 2149, 2195
 default-metric 1795, 1929, 2150, 2196
 default-metric command 1929
 description 1289
 disable VRRP session 2485, 2512
 displaying VLAN interface 998
 distance 1467, 1796, 1930, 2151, 2197
 distance (OSPF command) 1796
 distance in IS-IS 895
 distribute-list 840, 1932, 2152, 2198
 Domain Name System 2263
 domain-password 2030

E

eBGP peering 247
 enable db-summary-opt 1799, 1934
 enable eBGP peering 247
 enable ext-ospf-multi-inst 1800
 enable IS-IS 851
 enable multiple OSPF instances 657
 enable multiple OSPFv3 instances 805
 enable OSPFv3 769
 enable RIPng 2201
 enable routing between VLAN and routed port 1090
 enable VRRP sessions 2486, 2513
 enabling Load Balancing 993
 Ethernet address 2263
 exec command mode 41
 exit-address-family command 1468

F

fast-external-failover 1423
 fib retain 1290

G

graceful restart 2097
 graceful restart commands
 neighbor capability graceful-restart 1493, 1574
 restart bgp graceful 1551
 graceful restart in IS-IS 895

H

history 1674
 host area 1807
 how I-2 switches are used 1087
 how I-3 routers are used 1087
 how to disable VRRP session 2485, 2512
 how to enable
 authentication on an area 653
 authentication on an interface 653
 iBGP peering 241
 IS-IS 851
 Load Balancing 993

multiple OSPF instances 657
 multiple OSPFv3 instances 805
 OSPF on an interface 625, 751
 OSPFv3 769
 RIP 1033
 how to enable VRRP session 2486, 2513
 how to enable/disable Virtual MAC 2508
 how to enter router mode 2516
 how to redistribute routes 782
 how to redistribute routes into OSPF 639
 how to set priority in OSPF 629
 how to set priority in OSPFv3 772
 how to set priority-IS-IS 854
 how to set the Virtual IP address 2505
 how to set the Virtual IPv6 address 2519
 how to specify RIP version 1037
 hybrid L-2/ L-3 switch router 1088
 hybrid switch configuration 1087

I

iBGP peering 241
 IFNAME 36
 ignore-lsp-errors 2037
 integrated solution 1087
 interface mode 41
 Interior Gateway Protocol (IGP) 1367
 Intermediate System to Intermediate System (IS-IS) 1383
 Internet Protocol Version 6 2263
 ip bfd static all-interfaces 2412
 ip extcommunity-list
 expanded 1477
 extended 1476
 standard 1478
 ip extcommunity-list standard 1475
 ip ospf authentication 1808
 ip ospf authentication-key 1809
 ip ospf bfd 1811
 ip ospf cost 1812
 ip ospf database-filter 1813
 ip ospf dead-interval 1814
 ip ospf disable all 1816, 1818
 ip ospf hello-interval 1819
 ip ospf message-digest-key 1821
 ip ospf mtu 1823
 ip ospf mtu-ignore 1824
 ip ospf network 1825
 ip ospf priority 1826
 ip ospf resync-timeout 1827
 ip ospf retransmit-interval 1828
 ip ospf transmit-delay 1829
 ip rip authentication key-chain 2153
 ip rip authentication mode md5 2154
 ip rip authentication string 2155
 ip rip receive version 2157
 ip rip receive-packet 2156
 ip rip send version 2159
 ip rip send-packet 2158

- ip rip split-horizon 2160
- ip route 1291
- ip router isis 2038
- ip static bfd 2414
- ip static fall-over bfd 2413
- ip vrf 1298, 1614
- IPv4 address
 - command syntax 36
- IPv6 2263
- IPv6 address
 - command syntax 36
- ipv6 bfd static all-interfaces 2415
- IPv6 configuration 2467
- ipv6 nd current-hoplimit 2279
- ipv6 nd link-mtu 2280
- ipv6 nd managed-config-flag 2281
- ipv6 nd other-config-flag 2282
- ipv6 nd prefix 2283
- ipv6 nd ra-interval 2285
- ipv6 nd reachable-time 2287
- ipv6 nd retransmission-time 2288
- ipv6 nd suppress-ra 2289
- ipv6 ospf cost 1937
- ipv6 ospf dead-interval 1938
- ipv6 ospf display route single-line 1939
- ipv6 ospf link-lsa-suppression 1941
- ipv6 ospf mtu-ignore 1942, 1943
- ipv6 ospf neighbor 1944
- ipv6 ospf network 1946
- ipv6 ospf priority 1947
- ipv6 ospf restart grace-period 1987
- ipv6 ospf restart helper 1988
- ipv6 ospf retransmit-interval 1948
- ipv6 ospf6 transmit-delay 1949
- ipv6 rip split-horizon 2200
- ipv6 router mode 2516
- ipv6 router ospf 1950
- ipv6 router rip 2201
- ipv6 static bfd 2417
- ipv6 static fall-over bfd 2416
- ipv6 te-metric 1952
- isis authentication key-chain 2040
- isis authentication mode md5 2041
- isis authentication send-only 2042
- isis circuit-type 2044
- IS-IS commands 2024
 - accept-lifetime 2008
 - area-password 2012
 - authentication key-chain 2013
 - authentication mode md5 2014
 - authentication send-only 2015
 - clear clns is-neighbors 2019
 - clear clns neighbors 2018
 - clear isis interface counter 2023
 - clear isis route 2020
 - default-information originate 2027
 - distance (IPv4) 2029
 - isis authentication key-chain 2040
 - isis authentication mode md5 2041
 - isis authentication send-only 2042
 - isis csnp-interval 2045
 - isis hello-interval 2047
 - isis hello-multiplier 2048
 - isis metric 2052
 - isis network 2053
 - isis password 2054
 - isis priority 2055
 - isis restart grace-period 2093
 - isis restart helper 2095
 - isis restart-hello-interval 2094
 - isis retransmit-interval 2056
 - key 2064, 2161
 - key chain 2063
 - key-string 2065
 - max-area-address 2070
 - metric-style 2072
 - redistribute 2079
 - redistribute isis 2081
 - restart isis graceful 2097
 - send-lifetime 2084, 2086
 - set-overload-bit 2086
 - show clns is-neighbors 2106
 - show clns neighbors 2108
 - show cspf lsp 2111
 - show debugging isis 2111
 - show ip protocols 2117
 - show isis counter 2123
 - show isis counter command 2123
 - show isis database 2124
 - show isis interface 2127
 - show isis topology 2121, 2133
 - show running-config interface isis 2135
 - show running-config router isis 2136
 - summary-address 2088
- ISIS Configuration 1383
- IS-IS configuration 851
 - configuring distance 895
 - configuring metric 864
 - configuring passive interface 901
 - enabling IS-IS on an interface 851
 - graceful restart 895
 - L1 L2 area routing with multiple instances 879
 - L1 L2 area routing with single instance 872
 - pasive interface 901
 - redistributing routes into IS-IS 858
 - route leaking 884
 - route summarization 890
 - setting priority 854
- IS-IS configuration-IPv6 906
 - isis csnp-interval 2045
 - isis csnp-interval command 2045
 - isis hello-interval 2047
 - isis hello-interval command 2047
 - isis hello-multiplier 2048
 - isis hello-multiplier command 2048
 - isis metric 2052
 - isis metric command 2052
 - isis network command 2053

isis password 2054
 isis password command 2054
 isis priority 2055
 isis priority command 2055
 isis restart grace-period 2093
 isis restart helper 2095
 isis restart-hello-interval 2094
 isis retransmit-interval 2056
 isis retransmit-interval command 2056
 isis te-metric 2061
 is-type 2062

K

kernel patch MD5 authentication 81
 key chain 2063, 2162, 2383
 key command 2064, 2161
 key 2382
 key-string 2065, 2163

L

L1L2 area routing 872, 879
 L3_LAG Configuration 1001
 LINE 36
 link-local address 244
 log-neighbor-changes command 1429
 lsp-gen-interval 2067
 lsp-refresh-interval 2069

M

MAC address 2263
 command syntax 36
 MAC headers 1087
 Match and Set Commands
 match as-path 1323
 match community 1324
 match interface 1326
 match ip address 1327
 match ip address prefix-list 1328
 match ip next-hop 1329
 match ip next-hop prefix-list 1330
 match ipv6 address 1332
 match ipv6 address prefix-list 1333
 match ipv6 next-hop 1334
 match metric 1337
 match origin 1338
 match route-type 1339
 match tag 1340
 set as-path 1343
 set atomic-aggregate 1344
 set comm-list delete 1345
 set community 1346
 set dampening 1348
 set extcommunity 1349
 set ip next-hop 1352
 set ipv6 next-hop 1353
 set level 1354

 set metric 1356
 set metric-type 1357
 set origin 1358
 set originator-id 1359
 set tag 1360
 set vpnv4 next-hop 1361
 set weight 1362
 match as-path 1323
 match command
 origin 1338
 match community 1324
 match interface 1326
 match ip address 1327
 match ip address prefix-list 1328
 match ip next-hop 1329
 match ip next-hop prefix-list 1330
 match ipv6 address 1332
 match ipv6 address prefix-list 1333
 match ipv6 next-hop 1334
 match metric 1337
 match origin 1338
 match route-type 1339
 match tag 1340
 max-area-address 2070
 max-concurrent-dd 1831, 1954
 maximum-area 1832
 maximum-paths 1302
 maximum-prefix 2165
 max-lsp-lifetime 2071
 max-static-routes 1303
 MD5 authentication on BGP 81
 MD5 libraries 81
 MED 1402
 metric in IS-IS 864
 metric-style command 2072
 Multi Exit Discriminator 1402
 Multicast Commands
 show ipv6 rpf 1310

N

neighbor 1833, 2166
 passive 1517
 peer-group add 1518
 remove-private-AS 1527
 unsuppress-map 1540
 neighbor allow-egbp-vpn 1615
 neighbor as-override 1616
 neighbor attribute-unchanged 1490
 neighbor command 2202
 advertisement-interval 1486
 capability dynamic 1492
 capability graceful-restart 1493, 1574
 capability orf prefix-list 1494
 enforce-multihop 1505
 neighbor disallow-infinite-holdtime 1501
 Neighbor Discovery protocol 2263
 neighbor g-shut 1509, 1575
 neighbor g-shut-timer 1510, 1576

- neighbor send-community 1617
- neighbor soo 1618
- net 2076
- network 2167
- network area 1834
- network backdoor 1601
- network command 1546
- NSM Commands
 - ipv6 nd managed-config-flag 2281
 - ipv6 nd other-config-flag 2282
 - ipv6 nd prefix 2283
 - ipv6 nd ra-interval 2285
 - ipv6 nd ra-lifetime 2286
 - ipv6 nd reachable-time 2287
 - ipv6 nd suppress-ra 2289
 - show router-id 1312
- O**
- offset-list 2168, 2203
- Open Shortest Path First (OSPF) 1381
- origin codes 1674
- ospf abr-type 1836
- OSPF Commands
 - te-metric 1888
- OSPF commands
 - area authentication 1743
 - area default-cost 1744
 - area filter-list 1745
 - area nssa 1907
 - area range 1762
 - area shortcut 1764
 - area stub 1765
 - area virtual-link 1766
 - auto-cost reference-bandwidth 1769
 - bfd all-interfaces 1770
 - capability opaque 1773
 - capability restart 1895
 - clear ip ospf process 1776
 - compatible rfc1583 1777
 - debug ospf 1782
 - debug ospf database-timer rate-limit 1784
 - debug ospf events 1785
 - debug ospf ifsm 1786
 - debug ospf ism 1786
 - debug ospf lsa 1787
 - debug ospf nfsm 1788
 - debug ospf nsm 1789
 - debug ospf packet 1790
 - debug ospf route 1792
 - default-information originate 1793, 1927
 - default-metric 1795, 1929
 - distance 1796, 1930
 - distribute-list 1797
 - enable db-summary-opt 1799
 - enable ext-ospf-multi-inst 1800
 - host area 1807
 - ip ospf authentication 1808
 - ip ospf authentication-key 1809
 - ip ospf bfd 1811
 - ip ospf cost 1812
 - ip ospf database-filter 1813
 - ip ospf dead-interval 1814
 - ip ospf disable all 1816, 1818
 - ip ospf hello-interval 1819
 - ip ospf message-digest-key 1821
 - ip ospf mtu 1823
 - ip ospf mtu-ignore 1824
 - ip ospf network 1825
 - ip ospf priority 1826
 - ip ospf resync-timeout 1827
 - ip ospf retransmit-interval command 1828
 - ip ospf transmit-delay 1829
 - ipv6 ospf mtu-ignore 1942, 1943
 - max-concurrent-dd 1831
 - maximum-area 1832
 - neighbor 1833
 - network area 1834
 - ospf abr-type 1836
 - ospf router-id 1840
 - overflow database 1841
 - overflow database external 1842
 - passive-interface 1843, 1955
 - redistribute 1844
 - restart helper 1840, 1900
 - restart ospf graceful 1846, 1901
 - router ospf 1846
 - show debugging ospf 1848
 - show ip ospf 1849
 - show ip ospf brdr-routers 1853
 - show ip ospf igp-shortcut-lsp 1863
 - show ip ospf igp-shortcut-route 1864
 - show ip ospf interface 1865
 - show ip ospf neighbor 1870
 - show ip ospf route 1874
 - show ip ospf virtual-links 1879
 - show ip protocols ospf 1881
 - summary-address 1887
 - te-metric 1888
 - timers lsa arrival 1889
 - timers throttle lsa 1891
- OSPF Configuration 1381
- OSPF configuration 625
 - Area Border Router 634
 - configuring multiple OSPF instances on same subnet 667
 - configuring OSPF as PE-CE protocol for VPNs 174
 - enable multiple OSPF instances 657
 - enabling authentication 653
 - enabling OSPF on an interface 625, 751
 - OSPF cost 640
 - redistributing routes into OSPF 639
 - setting priority 629
- ospf router-id 1840
- OSPF VPN Commands
 - router ospf vrf 1993
- OSPFv3 commands
 - abr-type 1905

- area default-cost 1906
- area nssa 1907
- area range 1909
- area stub 1910
- area virtual-link 1911
- auto-cost reference bandwidth 1913
- capability restart graceful 1915, 1986
- clear ipv6 ospf process 1915
- debug ipv6 ospf 1916
- debug ipv6 ospf ifsm 1919
- debug ipv6 ospf lsa 1920
- debug ipv6 ospf nfsm 1921
- debug ipv6 ospf nsm 1922
- debug ipv6 ospf packet 1923
- debug ipv6 ospf route 1926
- default-metric 1929
- distribute-list 1932
- enable db-summary-opt 1934
- ipv6 ospf cost 1937
- ipv6 ospf dead-interval 1938
- ipv6 ospf display route single-line 1939
- ipv6 ospf link-lsa-suppression 1941
- ipv6 ospf neighbor 1944
- ipv6 ospf network 1946
- ipv6 ospf priority 1947
- ipv6 ospf restart grace-period 1987
- ipv6 ospf restart helper 1988
- ipv6 ospf retransmit-interval 1948
- ipv6 ospf transmit-delay 1949
- ipv6 ospf6 transmit-delay 1949
- ipv6 router ospf 1950
- ipv6 te-metric 1952
- max-concurrent-dd 1954
- passive-interface 1955
- redistribute 1956
- restart ipv6 ospf graceful 1958, 1990
- router ipv6 ospf 1959
- router-id 1958
- show debugging ipv6 ospf 1960
- show ipv6 ospf database 1963
- show ipv6 ospf interface 1967
- show ipv6 ospf neighbor 1969
- show ipv6 ospf route 1972
- show ipv6 ospf topology 1975
- show ipv6 ospf virtual-links 1977
- show ipv6 ospf6 interface 1967
- show ipv6 vrf 1979
- summary-address 1982
- OSPFv3 configuration 769
 - configuring Area Border Router 776
 - cost 788
 - enable multiple OSPFv3 instances 805
 - enable OSPFv3 on an interface 769
 - redistribute routes into OSPFv3 782
 - setting priority 772
 - virtual links 798
- overflow database 1841
- overflow database external 1842

P

- parentheses
 - command syntax 35
- parentheses
 - command syntax 35
- pasive interface 901
- passive interface in IS-IS 901
- passive-interface 1843, 1955, 2169, 2204
- period
 - command syntax 36
- Policy Based Routing Configuration 1093
- preempt-mode 2490, 2514
- priority 2515
- priority-delta 2435
- privileged exec mode 41
- Pv4 2263

Q

- question mark
 - command syntax 36

R

- rd (route distinguisher) 1619
- recv-buffer-size 2170, 2205
- redistribute 1956, 2079, 2171, 2206
- redistribute command 1844
- redistribute isis 2081
- redistribute routes 639
- redistribute routes in OSPFv3 782
- redistributing routes into IS-IS 858
- redistributing routes into OSPF 639
- redundancy using VRRP and OSPF 2445
- reflector-admin-state 2227
- removing Multi-Exit Disc attribute from update messages 130
- restart bgp graceful 1551
- restart helper 1840, 1900
- restart ipv6 ospf graceful 1958, 1990
- restart isis 2097
- restart isis graceful 2097
- restart ospf graceful 1846, 1901
- restart-time 1528, 1577
- rfc1771-path-select 1434
- rfc1771-strict 1435
- RIP Commands
 - accept-lifetime 2141
 - cisco-metric-behavior 2143
 - clear ip rip route 2144
 - debug rip 2147
 - default-information originate 2149
 - default-metric 2150
 - distance 2151
 - distribute-list 2152
 - ip rip authentication key-chain 2153
 - ip rip authentication mode md5 2154
 - ip rip authentication string 2155

- ip rip receive packet 2156
 - ip rip receive version 2157
 - ip rip send packet 2158
 - ip rip send version 2159
 - ip rip send-packet 2158
 - ip rip split-horizon 2160
 - key chain 2162
 - key-string 2163
 - maximum-prefix 2165
 - neighbor 2166
 - network 2167
 - offset-list 2168
 - passive-interface 2169
 - recv-buffer-size 2170
 - redistribute 2171, 2206
 - route 2173
 - router rip 2174
 - send-lifetime 2175
 - show debugging rip 2176
 - show ip protocols rip 2177
 - show ip rip 2179
 - show ip rip interface 2181
 - timers 2186
 - version 2187
 - RIP configuration
 - enabling RIP 1033
 - RIPv2 md5 authentication 1053
 - RIPv2 text authentication-multiple keys 1045
 - specifying the RIP version 1037
 - RIP PE-CE Commands
 - show ip rip database vrf 2218
 - RIP version 1037
 - RIP VPN commands
 - show ip rip database vrf 2218
 - RIPng commands
 - aggregate-address 2190
 - cisco-metric-behavior 2191
 - clear ipv6 rip route 2192
 - debug ipv6 rip 2193
 - default-information-originate 2195
 - default-metric 2196
 - distance 2197
 - distribute-list 2198
 - ipv6 rip split-horizon 2200
 - ipv6 router rip 2201
 - neighbor 2202
 - offset-list 2203
 - passive-interface 2204
 - recv-buffer-size 2205
 - route 2207
 - route-map 2208
 - router ipv6 rip 2209
 - show debugging ipv6 rip 2210
 - show ipv6 protocols rip 2211
 - show ipv6 rip interface 2213
 - show ipv6 rip show ipv6 rip 2212
 - timers basic 2214
 - RIPng configuration 1063
 - route 2173, 2207
 - route leaking in IS-IS 884
 - route reflector 254
 - route summarization in IS-IS 890
 - route-map 1341, 2208
 - route-map-BGP 250
 - Router Advertised Commands
 - ipv6 nd current-hoplimit 2279
 - ipv6 nd link-mtu 2280
 - ipv6 nd managed-config-flag 2281
 - ipv6 nd other-config-flag 2282
 - ipv6 nd prefix 2283
 - ipv6 nd ra-interval 2285
 - ipv6 nd ra-lifetime ipv6 nd ra-lifetime 2286
 - ipv6 nd reachable-time 2287
 - ipv6 nd retransmission time 2288
 - ipv6 nd suppress-ra 2289
 - router ipv6 ospf 1959
 - router ipv6 rip 2209
 - router isis 2083
 - router mode 41
 - router ospf 1846
 - router ospf vrf 1993
 - router rip 2174
 - router vrrp 2492
 - route-reflector 52
 - router-id 1958
 - route-target 1620
 - routing, switching or both 1087
- ## S
- scan-time 1437
 - send-lifetime 2084, 2086, 2175
 - send-lifetime 2386
 - set administrative distance 2197
 - set as-path 1343
 - set atomic-aggregate 1344
 - set comm-list delete 1345
 - set community 1346
 - set dampening 1348
 - set extcommunity 1349
 - set interface null0 1351
 - set ip next-hop 1352
 - set ipv6 next-hop 1353
 - set level 1354
 - set metric 1356
 - set metric-type 1357
 - set origin 1358
 - set originator-id 1359
 - set tag 1360
 - set vpnv4 next-hop 1361
 - set weight 1362
 - set-overload-bit 2086
 - setting priority 772
 - setting router priority 2515
 - setting-priority 854
 - show bfd 2387
 - show bfd interface 2388
 - show bfd session 2390

show bfd session A.B.C.D 2394
show bfd session ipv6 2397
show bgp ipv6 1640
show bgp neighbors received prefix-filter 1652
show bgp neighbors received-routes 1653
show bgp neighbors routes 1655
show bgp paths command 1660
show bgp prefix-list command 1661
show bgp quote-regexp command 1662
show bgp route-map command 1664
show clns is-neighbors 2106
show clns is-neighbors command 2106
show clns neighbors command 2108
show commands 38
 exclude modifier 39
 include modifier 39
 redirect modifier 40
show cspf lsp 2111
show debugging bfd 2400
show debugging ipv6 ospf 1960
show debugging ipv6 rip 2210
show debugging isis 2111
show debugging ospf 1848
show debugging rib 1305
show debugging rip 2176
show debugging vrrp 2493
show ip bgp rfilter all 1680
show ip extcommunity-list 1692
show ip ospf 1849
 border routers 1853
show ip ospf border-routers 1853
show ip ospf igp-shortcut-lsp 1863
show ip ospf igp-shortcut-route 1864
show ip ospf interface 1865
show ip ospf neighbor 1870
show ip ospf route 1874
show ip ospf virtual-links 1879
show ip protocols 2117
show ip protocols bgp 1693
show ip protocols ospf 1881
show ip protocols rip 2177
show ip rip command 2179
show ip rip database vrf 2218
show ip rip interface 2181
show ipv6 isis route 2123
show ipv6 ospf database 1963
show ipv6 ospf database, router 1958, 1990
show ipv6 ospf interface 1967
show ipv6 ospf neighbor 1969
show ipv6 ospf route 1972
show ipv6 ospf topology 1975
show ipv6 ospf virtual-links 1977
show ipv6 ospf6
 interface 1967
show ipv6 rip interface 2213
show ipv6 rpf 1310
show ipv6 vrf 1979
show isis counter 2123
show isis database command 2124
show isis interface 2127
show isis topology 2121, 2133
show router-id 1312
show running-config as-path access-list 1696
show running-config community-list 1697
show running-config interface isis 2135
show running-config route-map 1364
show running-config router isis 2136
show running-config router vrrp 2494, 2495
show running-config router-id 1314
show running-config twamp 2230
show running-config vrf 1316
show running-config vrrpv6 2494
show twamp statistics 2232
snmp restart bfd 2401
square brackets
 command syntax 36
stale route 1674
summary-address 1887, 1982, 2088
suppressed route 1674
synchronization command 1555

T

te-metric 1888
test-session-name 2235
time
 command syntax 36
timers 2186
timers basic 2214
timers lsa arrival 1889
timers throttle lsa 1891
transmit delay 1866
transmit-delay 1949
twamp start-test-session 2249
twamp stop-test-session 2250
twamp-light control 2237
twamp-light reflector 2238

U

update-delay 1440, 1573

V

valid route 1674
version 2187
vertical bars
 command syntax 35
virtual IP address 2505
virtual IPv6 address 2519
Virtual MAC command 2508
Virtual routing and forwarding (VRF) 1371
virtual-ip 2505
virtual-ip command 2519
VLAN interfaces 997
VRF 1993
VRF Configuration 1371, 1375
VRRP Commands 2479, 2509

circuit-failover 2511
debug vrrp 2484
disable 2485, 2512
enable 2486, 2513
preempt-mode 2490, 2514
priority 2515
show debugging vrrp 2493
show running-config router vrrp 2494, 2495
virtual-ip 2505
vrrp vmac 2508

VRRP process 2421
VRRPv6 Commands
 router ipv6 vrrp 2516
 virtual-ip 2519

W

WORD 36