



**OcNOS®**  
**Open Compute**  
**Network Operating System**  
**for Service Providers**  
**Version 6.3.5**

**Carrier Ethernet Guide**

**June 2024**

---

© 2024 IP Infusion Inc. All Rights Reserved.

This documentation is subject to change without notice. The software described in this document and this documentation are furnished under a license agreement or nondisclosure agreement. The software and documentation may be used or copied only in accordance with the terms of the applicable agreement. No part of this publication may be reproduced, stored in a retrieval system, or transmitted in any form or any means electronic or mechanical, including photocopying and recording for any purpose other than the purchaser's internal use without the written permission of IP Infusion Inc.

IP Infusion Inc.

3965 Freedom Circle, Suite 200

Santa Clara, CA 95054

+1 408-400-1900

<http://www.ipinfusion.com/>

For support, questions, or comments via E-mail, contact:

[support@ipinfusion.com](mailto:support@ipinfusion.com)

Trademarks:

IP Infusion and OcNOS are trademarks or registered trademarks of IP Infusion. All other trademarks, service marks, registered trademarks, or registered service marks are the property of their respective owners.

Use of certain software included in this equipment is subject to the IP Infusion, Inc. End User License Agreement at <http://www.ipinfusion.com/license>. By using the equipment, you accept the terms of the End User License Agreement.

# Contents

<b>Preface</b> .....	<b>ix</b>
IP Maestro Support .....	ix
Audience .....	ix
Conventions .....	ix
Chapter Organization .....	ix
Related Documentation .....	ix
Feature Availability .....	x
Migration Guide .....	x
Support .....	x
Comments .....	x
<b>Command Line Interface</b> .....	<b>11</b>
Overview .....	11
Command Line Interface Help .....	11
Command Completion .....	12
Command Abbreviations .....	12
Command Line Errors .....	12
Command Negation .....	13
Syntax Conventions .....	13
Variable Placeholders .....	14
Command Description Format .....	15
Keyboard Operations .....	15
Show Command Modifiers .....	16
String Parameters .....	19
Command Modes .....	19
Transaction-based Command-line Interface .....	21
<b>Carrier Ethernet Configuration Guide</b> .....	<b>23</b>
CHAPTER 1 Ethernet CFM Configurations .....	25
Continuity Check Message (CCM) .....	25
CHAPTER 2 Y.1731 Performance Monitoring Configurations .....	37
Synthetic Loss Measurement (SLM) over L2 Bridge .....	37
CHAPTER 3 Ethernet Linear Protection Switching Configuration .....	79
CHAPTER 4 G.8032 ERPS Version 2 .....	87
Topology .....	87
Validation .....	96
Sub-ring with Virtual Channel .....	99
Sub-ring without Virtual Channel on a LAG interface .....	121
ERPS Managing Non-Data VLAN's .....	140
CHAPTER 5 Ethernet in the First Mile Configuration .....	165
Topology .....	165

---

CHAPTER 6	Ethernet Test Signal Lock Configuration .....	171
	Topology .....	171
	ETH-TST Configuration .....	171
	ETH-LCK Configuration .....	174
CHAPTER 7	Ethernet Bandwidth Notification Configuration .....	177
	Topology .....	177
<b>Carrier Ethernet Command Reference .....</b>		<b>181</b>
CHAPTER 1	CFM and Y.1731 Commands .....	183
	abort delay-measurement .....	186
	abort loss-measurement .....	187
	abort test-signal domain .....	188
	ais interval .....	189
	ais status .....	190
	bins-per-fd-interval .....	191
	bins-per-ifdv-interval .....	192
	bin-type .....	193
	bn receive .....	194
	bw-mapped-interface .....	195
	cc interval .....	196
	cc multicast .....	197
	cfm snmp restart .....	198
	clear ethernet cfm delay-measurement history .....	199
	clear ethernet cfm dm history .....	200
	clear ethernet cfm lm history .....	201
	clear ethernet cfm loss-measurement history .....	202
	clear ethernet cfm maintenance-point remote .....	203
	clear ethernet cfm statistics .....	204
	clear ethernet cfm statistics bn .....	205
	clear ethernet cfm statistics lck .....	206
	clear ethernet cfm statistics test-signal .....	207
	clear ethernet cfm traceroute-cache .....	208
	csf receive .....	209
	debug ethernet cfm .....	210
	delay-measurement type on-demand .....	211
	delay-measurement type proactive .....	213
	ethernet cfm delay-measurement profile-name .....	214
	ethernet cfm delay-measurement reply .....	215
	ethernet cfm domain-type .....	216
	ethernet cfm loss-measurement profile-name .....	217
	ethernet cfm loss-measurement reply .....	218
	ethernet cfm mep .....	219
	ethernet cfm mip .....	220
	ethernet cfm statistics csf .....	221
	ethernet cfm test-signal profile-name .....	222
	evpn .....	223

---

ethernet cfm traceroute cache	224
exit-ether-ma-mep-mode	225
exit-ether-ma-mode	226
frame priority	227
hardware-profile filter cfm-domain-name-str	228
interval	229
intervals-stored	230
lck state	231
link-level	232
loss-measurement type on-demand	233
loss-measurement type proactive	235
measurement-interval	236
measurement-type slm	237
mep crosscheck	238
mep lowest-priority-defect	239
message level	240
message-period	241
mip-creation	242
intervals-stored	243
peer-port-id	244
ping ethernet mac	245
rmep auto-discovery	246
service ma-type	247
show ethernet cfm ais reception-status	248
show ethernet cfm bn	249
show ethernet cfm bn mep	250
show ethernet cfm csf	251
show ethernet cfm csf mep	252
show ethernet cfm delay-measurement mep	253
show ethernet cfm delay-measurement profile	256
show ethernet cfm dm sessions	258
show ethernet cfm errors	259
show ethernet cfm eth-bn status	260
show ethernet cfm frame-lm session	261
show ethernet cfm lck details domain	262
show ethernet cfm lck statistics	263
show ethernet cfm loss-measurement mep	264
show ethernet cfm loss-measurement profile	266
show ethernet cfm ma status	267
show ethernet cfm maintenance-points count	269
show ethernet cfm maintenance-points local mep	270
show ethernet cfm maintenance-points local mip	272
show ethernet cfm maintenance-points remote	273
show ethernet cfm statistics	274
show ethernet cfm statistics bn	276
show ethernet cfm statistics csf	277
show ethernet cfm test-signal domain	278

---

show ethernet cfm test-signal profile . . . . .	279
show ethernet cfm test-signal sessions . . . . .	280
show ethernet cfm traceroute-cache . . . . .	281
show running-config cfm . . . . .	282
test-signal frame-size . . . . .	283
test-signal mode . . . . .	284
test-signal pattern-type . . . . .	285
test-signal start-time . . . . .	286
test-signal test-type . . . . .	288
traceroute ethernet . . . . .	289
vlan . . . . .	290
vpws . . . . .	291
wait-to-restore-timer <0-86400> . . . . .	292
<b>CHAPTER 2 G8031 ELPS Commands . . . . .</b>	<b>293</b>
clear . . . . .	294
debug g8031 . . . . .	295
exercise . . . . .	296
force-switch . . . . .	297
g8031 eps-id . . . . .	298
instance . . . . .	299
level . . . . .	300
local-freeze . . . . .	301
lockout . . . . .	302
manual-switch . . . . .	303
mode . . . . .	304
primary-vlan . . . . .	305
protection-port . . . . .	306
revertive . . . . .	307
show g8031 eps-id . . . . .	308
show g8031 bridge . . . . .	310
show hsl g8031 debug . . . . .	312
timer hold-off-time . . . . .	314
timer wait-to-restore . . . . .	315
vlan . . . . .	316
working-port . . . . .	317
<b>CHAPTER 3 G.8032 ERPS Version 2 Commands . . . . .</b>	<b>319</b>
aps-channel level . . . . .	320
aps-channel vlan . . . . .	321
clear g8032 erp-instance . . . . .	322
data vlan . . . . .	323
debug g8032 . . . . .	324
east-interface . . . . .	325
enable-tcn-propagation . . . . .	326
erps-instance in subinterface . . . . .	327
g8032 erp-instance . . . . .	328
g8032 erp-instance force-switch . . . . .	329

---

g8032 erp-instance manual-switch	330
g8032 ring	331
g8032-profile	332
g8032 profile	333
non-virtual-channel	334
ring	335
ring-id	336
ring-type	337
rpl role	338
show g8032 all erp-instance	339
show g8032 erp-instance	340
show g8032 profile	341
show g8032 ring	342
switching mode	343
tcn-to-instance	344
timer	345
virtual-channel	346
west-interface	347
<b>CHAPTER 4 EFM OAM Commands</b>	<b>349</b>
clear ethernet oam statistics interface	350
debug ethernet oam	351
ethernet oam enable	352
ethernet oam link-monitor event-log-size	353
ethernet oam link-monitor on	354
ethernet oam link-monitor supported	355
ethernet oam max-rate	356
ethernet oam min-rate	357
ethernet oam mode	358
ethernet oam remote-failure	359
ethernet oam remote-loopback (start stop)	360
ethernet oam remote-loopback {supported timeout}	361
ethernet oam timeout	362
show ethernet oam	363
show ethernet oam discovery	365
show ethernet oam eventlog	366
show ethernet oam statistics	367
show ethernet oam status	368
show ethernet oam discovery brief	369
<b>Index</b>	<b>371</b>





---

# Preface

---

This guide describes how to configure OcNOS.

---

## IP Maestro Support

Monitor devices running OcNOS Release 6.3.4-70 and above using IP Maestro software.

---

## Audience

This guide is intended for network administrators and other engineering professionals who configure OcNOS.

---

## Conventions

[Table P-1](#) shows the conventions used in this guide.

**Table P-1: Conventions**

Convention	Description
Italics	Emphasized terms; titles of books
Note:	Special instructions, suggestions, or warnings
<code>monospaced type</code>	Code elements such as commands, parameters, files, and directories

---

## Chapter Organization

The chapters in command references are organized as described in [Command Description Format](#).

The chapters in configuration guides are organized into these major sections:

- An overview that explains a configuration in words
  - Topology with a diagram that shows the devices and connections used in the configuration
  - Configuration steps in a table for each device where the left-hand side shows the commands you enter and the right-hand side explains the actions that the commands perform
  - Validation which shows commands and their output that verify the configuration
- 

## Related Documentation

For information about installing OcNOS, see the *Installation Guide* for your platform.

---

## Feature Availability

The features described in this document that are available depend upon the OcNOS SKU that you purchased. See the *Feature Matrix* for a description of the OcNOS SKUs.

---

## Migration Guide

Check the *Migration Guide* for configuration changes to make when migrating from one version of OcNOS to another.

---

## Support

For support-related questions, contact [support@ipinfusion.com](mailto:support@ipinfusion.com).

---

## Comments

If you have comments, or need to report a problem with the content, contact [techpubs@ipinfusion.com](mailto:techpubs@ipinfusion.com).

---

# Command Line Interface

---

This chapter introduces the OcNOS Command Line Interface (CLI) and how to use its features.

---

## Overview

You use the CLI to configure, monitor, and maintain OcNOS devices. The CLI is text-based and each command is usually associated with a specific task.

You can give the commands described in this manual locally from the console of a device running OcNOS or remotely from a terminal emulator such as `putty` or `xterm`. You can also use the commands in scripts to automate configuration tasks.

---

## Command Line Interface Help

You access the CLI help by entering a full or partial command string and a question mark “?”. The CLI displays the command keywords or parameters along with a short description. For example, at the CLI command prompt, type:

```
> show ?
```

The CLI displays this keyword list with short descriptions for each keyword:

```
show ?
  application-priority      Application Priority
  arp                      Internet Protocol (IP)
  bfd                      Bidirectional Forwarding Detection (BFD)
  bgp                      Border Gateway Protocol (BGP)
  bi-lsp                   Bi-directional lsp status and configuration
  bridge                   Bridge group commands
  ce-vlan                  COS Preservation for Customer Edge VLAN
  class-map                Class map entry
  cli                      Show CLI tree of current mode
  clns                     Connectionless-Mode Network Service (CLNS)
  control-adjacency        Control Adjacency status and configuration
  control-channel          Control Channel status and configuration
  cspf                     CSPF Information
  customer                 Display Customer spanning-tree
  cvlan                    Display CVLAN information
  debugging                Debugging functions (see also 'undebug')
  etherchannel             LACP etherchannel
  ethernet                 Layer-2
  ...
```

If you type the ? in the middle of a keyword, the CLI displays help for that keyword only.

```
> show de?
debugging Debugging functions (see also 'undebug')
```

If you type the ? in the middle of a keyword, but the incomplete keyword matches several other keywords, OcNOS displays help for all matching keywords.

```
> show i? (CLI does not display the question mark).
interface Interface status and configuration
ip IP information
isis ISIS information
```

---

## Command Completion

The CLI can complete the spelling of a command or a parameter. Begin typing the command or parameter and then press the tab key. For example, at the CLI command prompt type `sh`:

```
> sh
```

Press the tab key. The CLI displays:

```
> show
```

If the spelling of a command or parameter is ambiguous, the CLI displays the choices that match the abbreviation. Type `show i` and press the tab key. The CLI displays:

```
> show i
  interface ip          ipv6      isis
> show i
```

The CLI displays the `interface` and `ip` keywords. Type `n` to select `interface` and press the tab key. The CLI displays:

```
> show in
> show interface
```

Type `?` and the CLI displays the list of parameters for the `show interface` command.

```
> show interface
  IFNAME  Interface name
  |       Output modifiers
  >      Output redirection
  <cr>
```

The CLI displays the only parameter associated with this command, the `IFNAME` parameter.

---

## Command Abbreviations

The CLI accepts abbreviations that uniquely identify a keyword in commands. For example:

```
> sh int xe0
```

is an abbreviation for:

```
> show interface xe0
```

---

## Command Line Errors

Any unknown spelling causes the CLI to display the error `Unrecognized command` in response to the `?`. The CLI displays the command again as last entered.

```
> show dd?
% Unrecognized command
> show dd
```

When you press the Enter key after typing an invalid command, the CLI displays:

```
(config)#router ospf here
                               ^
% Invalid input detected at '^' marker.
```

where the `^` points to the first character in error in the command.

If a command is incomplete, the CLI displays the following message:

```
> show
% Incomplete command.
```

Some commands are too long for the display line and can wrap mid-parameter or mid-keyword, as shown below. This does *not* cause an error and the command performs as expected:

```
area 10.10.0.18 virtual-link 10.10.0.19 authent
ication-key 57393
```

---

## Command Negation

Many commands have a `no` form that resets a feature to its default value or disables the feature. For example:

- The `ip address` command assigns an IPv4 address to an interface
- The `no ip address` command removes an IPv4 address from an interface

---

## Syntax Conventions

[Table P-2](#) describes the conventions used to represent command syntax in this reference.

**Table P-2: Syntax conventions**

Convention	Description	Example
monospaced font	Command strings entered on a command line	<code>show ip ospf</code>
lowercase	Keywords that you enter exactly as shown in the command syntax.	<code>show ip ospf</code>
UPPERCASE	See <a href="#">Variable Placeholders</a>	IFNAME
( )	Optional parameters, from which you must select one. Vertical bars delimit the selections. Do not enter the parentheses or vertical bars as part of the command.	<code>(A.B.C.D &lt;0-4294967295&gt;)</code>
( )	Optional parameters, from which you select one or none. Vertical bars delimit the selections. Do not enter the parentheses or vertical bars as part of the command.	<code>(A.B.C.D &lt;0-4294967295&gt; )</code>
( )	Optional parameter which you can specify or omit. Do not enter the parentheses or vertical bar as part of the command.	<code>(IFNAME )</code>
{ }	Optional parameters, from which you must select one or more. Vertical bars delimit the selections. Do not enter the braces or vertical bars as part of the command.	<code>{intra-area &lt;1-255&gt; inter-area &lt;1-255&gt; external &lt;1-255&gt;}</code>

**Table P-2: Syntax conventions (Continued)**

Convention	Description	Example
[ ]	Optional parameters, from which you select zero or more. Vertical bars delimit the selections. Do not enter the brackets or vertical bars as part of the command.	[<1-65535> AA:NN internet local-AS no-advertise no-export]
?	Nonrepeatable parameter. The parameter that follows a question mark can only appear once in a command string. Do not enter the question mark as part of the command.	?route-map WORD
.	Repeatable parameter. The parameter that follows a period can be repeated more than once. Do not enter the period as part of the command.	set as-path prepend .<1-65535>

---

## Variable Placeholders

Table P-3 shows the tokens used in command syntax use to represent variables for which you supply a value.

**Table P-3: Variable placeholders**

Token	Description
WORD	A contiguous text string (excluding spaces)
LINE	A text string, including spaces; no other parameters can follow this parameter
IFNAME	Interface name whose format varies depending on the platform; examples are: eth0, Ethernet0, ethernet0, xe0
A.B.C.D	IPv4 address
A.B.C.D/M	IPv4 address and mask/prefix
X:X::X:X	IPv6 address
X:X::X:X/M	IPv6 address and mask/prefix
HH:MM:SS	Time format
AA:NN	BGP community value
XX:XX:XX:XX:XX:XX	MAC address
<1-5> <1-65535> <0-2147483647> <0-4294967295>	Numeric range

---

## Command Description Format

Table P-4 explains the sections used to describe each command in this reference.

**Table P-4: Command descriptions**

Section	Description
<b>Command Name</b>	The name of the command, followed by what the command does and when should it be used
<b>Command Syntax</b>	The syntax of the command
<b>Parameters</b>	Parameters and options for the command
<b>Default</b>	The state before the command is executed
<b>Command Mode</b>	The mode in which the command runs; see <a href="#">Command Modes</a>
<b>Example</b>	An example of the command being executed

---

## Keyboard Operations

Table P-5 lists the operations you can perform from the keyboard.

**Table P-5: Keyboard operations**

Key combination	Operation
Left arrow or Ctrl+b	Moves one character to the left. When a command extends beyond a single line, you can press left arrow or Ctrl+b repeatedly to scroll toward the beginning of the line, or you can press Ctrl+a to go directly to the beginning of the line.
Right arrow or Ctrl-f	Moves one character to the right. When a command extends beyond a single line, you can press right arrow or Ctrl+f repeatedly to scroll toward the end of the line, or you can press Ctrl+e to go directly to the end of the line.
Esc, b	Moves back one word
Esc, f	Moves forward one word
Ctrl+e	Moves to end of the line
Ctrl+a	Moves to the beginning of the line
Ctrl+u	Deletes the line
Ctrl+w	Deletes from the cursor to the previous whitespace
Alt+d	Deletes the current word
Ctrl+k	Deletes from the cursor to the end of line
Ctrl+y	Pastes text previously deleted with Ctrl+k, Alt+d, Ctrl+w, or Ctrl+u at the cursor

**Table P-5: Keyboard operations (Continued)**

Key combination	Operation
Ctrl+t	Transposes the current character with the previous character
Ctrl+c	Ignores the current line and redisplay the command prompt
Ctrl+z	Ends configuration mode and returns to exec mode
Ctrl+l	Clears the screen
Up Arrow or Ctrl+p	Scroll backward through command history
Down Arrow or Ctrl+n	Scroll forward through command history

---

## Show Command Modifiers

You can use two tokens to modify the output of a `show` command. Enter a question mark to display these tokens:

```
# show users ?
  | Output modifiers
  > Output redirection
```

You can type the | (vertical bar character) to use output modifiers. For example:

```
> show rsvp | ?
begin      Begin with the line that matches
exclude    Exclude lines that match
include    Include lines that match
last       Last few lines
redirect   Redirect output
```

---

## Begin Modifier

The `begin` modifier displays the output beginning with the first line that contains the input string (everything typed after the `begin` keyword). For example:

```
# show running-config | begin xe1
...skipping
interface xe1
  ipv6 address fe80::204:75ff:fee6:5393/64
!
interface xe2
  ipv6 address fe80::20d:56ff:fe96:725a/64
!
line con 0
  login
!
end
```

You can specify a regular expression after the `begin` keyword. This example begins the output at a line with either “xe2” or “xe4”:

```
# show running-config | begin xe[3-4]
...skipping
```



```

interface xe3
 shutdown
!
interface xe4
 shutdown
!
interface svlan0.1
 no shutdown
!
route-map myroute permit 3
!
route-map mymap1 permit 10
!
route-map rmap1 permit 3
!
line con 0
 login
line vty 0 4
 login
!
end

```

---

## Include Modifier

The `include` modifier includes only those lines of output that contain the input string. In the output below, all lines containing the word “input” are included:

```

# show interface xe1 | include input
input packets 80434552, bytes 2147483647, dropped 0, multicast packets 0
input errors 0, length 0, overrun 0, CRC 0, frame 0, fifo 1, missed 0

```

You can specify a regular expression after the `include` keyword. This examples includes all lines with “input” or “output”:

```

#show interface xe0 | include (in|out)put
input packets 597058, bytes 338081476, dropped 0, multicast packets 0
input errors 0, length 0, overrun 0, CRC 0, frame 0, fifo 0, missed 0
output packets 613147, bytes 126055987, dropped 0
output errors 0, aborted 0, carrier 0, fifo 0, heartbeat 0, window 0

```

---

## Exclude Modifier

The `exclude` modifier excludes all lines of output that contain the input string. In the following output example, all lines containing the word “input” are excluded:

```

# show interface xe1 | exclude input
Interface xe1
Scope: both
Hardware is Ethernet, address is 0004.75e6.5393
index 3 metric 1 mtu 1500 <UP,BROADCAST,RUNNING,MULTICAST>
VRF Binding: Not bound
Administrative Group(s): None
DSTE Bandwidth Constraint Mode is MAM
inet6 fe80::204:75ff:fee6:5393/64
output packets 4438, bytes 394940, dropped 0
output errors 0, aborted 0, carrier 0, fifo 0, heartbeat 0, window 0
collisions 0

```

You can specify a regular expression after the `exclude` keyword. This example excludes lines with “output” or “input”:

```
# show interface xe0 | exclude (in|out)put
Interface xe0
  Scope: both
  Hardware is Ethernet Current HW addr: 001b.2139.6c4a
  Physical:001b.2139.6c4a Logical:(not set)
  index 2 metric 1 mtu 1500 duplex-full arp ageing timeout 3000
  <UP,BROADCAST,RUNNING,MULTICAST>
  VRF Binding: Not bound
  Bandwidth 100m
  DHCP client is disabled.
  inet 10.1.2.173/24 broadcast 10.1.2.255
  VRRP Master of : VRRP is not configured on this interface.
  inet6 fe80::21b:21ff:fe39:6c4a/64
  collisions 0
```

---

## Redirect Modifier

The `redirect` modifier writes the output into a file. The output is not displayed.

```
# show cli history | redirect /var/frame.txt
```

The output redirection token (`>`) does the same thing:

```
# show cli history >/var/frame.txt
```

---

## Last Modifier

The `last` modifier displays the output of last few number of lines (As per the user input). The last number ranges from 1 to 9999.

For example:

```
#show running-config | last 10
```

---

## String Parameters

The restrictions in [Table P-6](#) apply for all string parameters used in OcnOS commands, unless some other restrictions are noted for a particular command.

**Table P-6: String parameter restrictions**

Restriction	Description
Input length	1965 characters or less
Restricted special characters	“?”, “,”, “>”, “ ”, and “=” The “ ” character is allowed only for the <code>description</code> command in interface mode.

---

## Command Modes

Commands are grouped into modes arranged in a hierarchy. Each mode has its own set of commands. [Table P-7](#) lists the command modes common to all protocols.

**Table P-7: Common command modes**

Name	Description
Executive mode	Also called <i>view</i> mode, this is the first mode to appear after you start the CLI. It is a base mode from where you can perform basic commands such as <code>show</code> , <code>exit</code> , <code>quit</code> , <code>help</code> , and <code>enable</code> .
Privileged executive mode	Also called <i>enable</i> mode, in this mode you can run additional basic commands such as <code>debug</code> , <code>write</code> , and <code>show</code> .
Configure mode	Also called <i>configure terminal</i> mode, in this mode you can run configuration commands and go into other modes such as <code>interface</code> , <code>router</code> , <code>route map</code> , <code>key chain</code> , and <code>address family</code> .  Configure mode is single user. Only one user at a time can be in configure mode.
Interface mode	In this mode you can configure protocol-specific settings for a particular interface. Any setting you configure in this mode overrides a setting configured in router mode.
Router mode	This mode is used to configure router-specific settings for a protocol such as BGP or OSPF.

---

## Command Mode Tree

The diagram below shows the common command mode hierarchy.

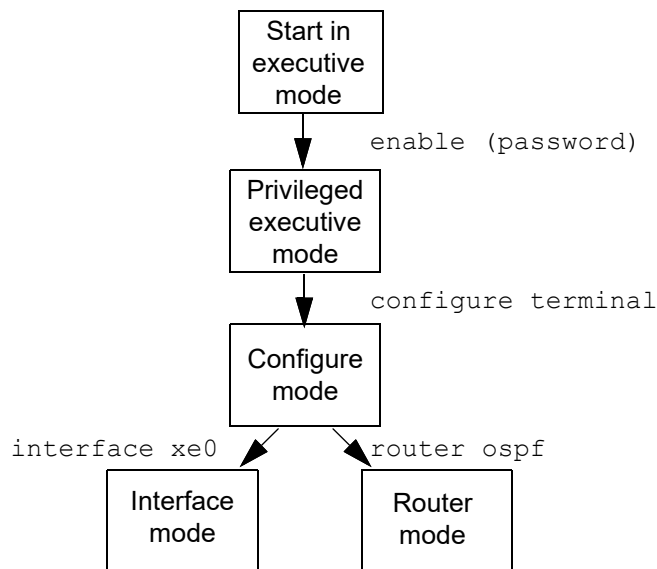

**Figure P-1: Common command modes**

To change modes:

1. Enter privileged executive mode by entering `enable` in Executive mode.
2. Enter configure mode by entering `configure terminal` in Privileged Executive mode.

The example below shows moving from executive mode to privileged executive mode to configure mode and finally to router mode:

```
> enable mypassword
# configure terminal
Enter configuration commands, one per line. End with CNTL/Z.
(config)# router ospf
(config-router)#
```

Note: Each protocol can have modes in addition to the common command modes. See the command reference for the respective protocol for details.

---

## Transaction-based Command-line Interface

The OcNOS command line interface is transaction based:

- Any changes done in configure mode are stored in a separate *candidate* configuration that you can view with the `show transaction current` command.
- When a configuration is complete, apply the candidate configuration to the running configuration with the `commit` command.
- If a `commit` fails, no configuration is applied as the entire transaction is considered failed. You can continue to change the candidate configuration and then retry the `commit`.
- Discard the candidate configuration with the `abort transaction` command.
- Check the last aborted transaction with the `show transaction last-aborted` command.
- Multiple configurations cannot be removed with a single `commit`. You must remove each configuration followed by a `commit`.

Note: All commands MUST be executed only in the default CML shell (`cmlsh`). If you log in as root and start `imish`, then the system configurations will go out of sync. The `imish` shell is not supported and should not be started manually.



# Carrier Ethernet Configuration Guide





# CHAPTER 1 Ethernet CFM Configurations

This chapter contains examples of Ethernet Operations and Management (OAM) configurations using the Connectivity Fault Management (CFM) protocol.

Connectivity Fault Management detects, verifies, isolates and notifies connectivity failures on a Virtual Bridged LAN (B-VLAN) based on the protocol standard specified in IEEE 802.1ag 2007. It provides discovery and verification of paths through 802.1 bridges and LANs and is part of the Operation, Administration and Management (OAM) module. CFM is transparent to customer data being transported by a network and is capable of providing maximum fault management.

## Continuity Check Message (CCM)

### Topology

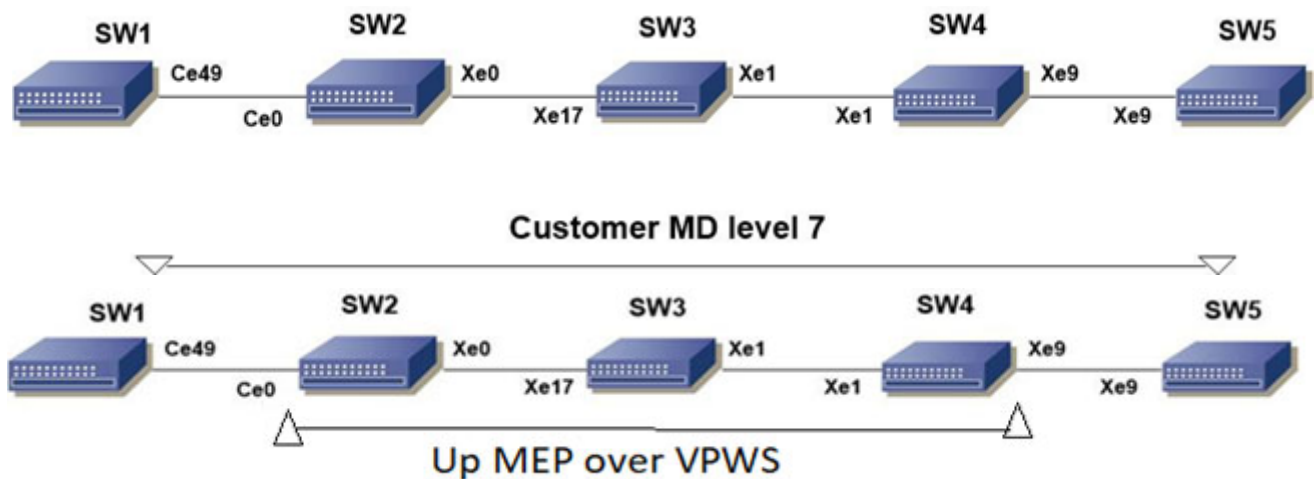

Figure 1-1: CFM Y.1731 Topology

### Prerequisite

Configure below hardware-profile commands related to CFM in configuration mode and reboot the nodes.

```
hardware-profile filter cfm-domain-name-str enable
hardware-profile statistics cfm-ccm enable
```

### SW1

SW1#configure terminal	Enter configure mode.
SW1(config)#bridge 1 protocol rstp vlan-bridge	Create bridge 1 as an RSTP VLAN-aware bridge.
SW1(config)#vlan database	Entering vlan database
SW1(config-vlan)#vlan 512 bridge 1 state enable	Create VLAN 512 on bridge 1.

## Ethernet CFM Configurations

SW1 (config-vlan) #exit	Exit vlan database
SW1 (config) #interface ce49	Configure interface ce49.
SW1 (config-if) #switchport	Configure the interface as switch port.
SW1 (config-if) #bridge-group 1	Configure interface in bridge group 1.
SW1 (config-if) #switchport mode trunk	Configure interface mode as trunk.
SW1 (config-if) #switchport trunk allowed vlan all	Allow all VLANs on interface ce49.
SW1 (config-if) #exit	Exit config mode.
SW1 (config) #ethernet cfm domain-type character-string domain-name mdnam level 7 mip-creation default	Create cfm domain with type as character string and set mip creation criteria to default.
SW1 (config-ether-cfm) #service ma-type string ma-name testtm	Create ma type as string and configure the ma
SW1 (config-ether-cfm-ma) #vlan 25 bridge 1	Configure vlan-id to associate the vlan to the MA
SW1 (config-ether-cfm-ma) #mip-creation default	Set the mip creation criteria to default for the MA
SW1 (config-ether-cfm-ma) #ethernet cfm mep down mpid 2 active true ce49	Create down mep on ce49.
SW1 (config-ether-cfm-ma-mep) #cc multicast state enable	Enable cc multicast.
SW1 (config-ether-cfm-ma-mep) #exit-ether-ma-mep-mode	Exit CFM MEP configuration mode.
SW1 (config-ether-cfm-ma) #mep crosscheck mpid 1	Configure crosscheck to remote MEP in VLAN 512.
SW1 (config-ether-cfm-ma) #cc interval 10ms	Enable cc interval for 10 millisecond.
SW1 (config-ether-cfm-ma) #exit-ether-ma-mode	Exit CFM MA configuration mode.
SW1 (config-ether-cfm) #exit	Exit ethernet CFM mode.
SW1 (config) #commit	Commit the configuration
SW1 (config) #exit	Exit the configure terminal mode

## SW2

SW2#configure terminal	Enter configure mode.
SW2 (config) #bridge 1 protocol rstp vlan-bridge	Create bridge 1 as an RSTP VLAN-aware bridge.
SW2 (config) #vlan database	Entering vlan database
SW2 (config-vlan) #vlan 512 bridge 1 state enable	Create VLAN 512 on bridge 1.
SW2 (config-vlan) #exit	Exit vlan database
SW2 (config) #interface ce0	Configure interface ce0.
SW2 (config-if) #switchport	Configure the interface as switch port.
SW2 (config-if) #bridge-group 1	Configure interface in bridge group 1.
SW2 (config-if) #switchport mode trunk	Configure interface mode as trunk.
SW2 (config-if) #switchport trunk allowed vlan all	Allow all VLANs on interface ce0.
SW2 (config-if) #exit	Exit config mode.

SW2(config)#interface xe0	Configure interface xe0.
SW2(config-if)#switchport	Configure the interface as switch port.
SW2(config-if)#bridge-group 1	Configure interface in bridge group 1.
SW2(config-if)#switchport mode trunk	Configure interface mode as trunk.
SW2(config-if)#switchport trunk allowed vlan all	Allow all VLANs on interface xe1.
SW2(config-if)#exit	Exit the interface mode
SW2(config)#commit	Commit the configuration
SW2(config)#exit	Exit the configure terminal mode

**SW3**

SW3#configure terminal	Enter configure mode.
SW3(config)#bridge 1 protocol rstp vlan-bridge	Create bridge 1 as an RSTP VLAN-aware bridge.
SW3(config)#vlan database	Entering vlan database
SW3(config-vlan)#vlan 512 bridge 1 state enable	Create VLAN 512 on bridge 1.
SW3(config-vlan)#exit	Exit vlan database
SW3(config)#interface xe17	Configure interface xe17
SW3(config-if)#switchport	Configure the interface as switch port.
SW3(config-if)#bridge-group 1	Configure interface in bridge group 1.
SW3(config-if)#switchport mode trunk	Configure interface mode as trunk.
SW3(config-if)#switchport trunk allowed vlan all	Allow all VLANs on interface xe17.
SW3(config-if)#exit	Exit config mode.
SW3(config)#interface xe1	Configure interface xe1.
SW3(config-if)#switchport	Configure the interface as switch port.
SW3(config-if)#bridge-group 1	Configure interface in bridge group 1.
SW3(config-if)#switchport mode trunk	Configure interface mode as trunk.
SW3(config-if)#switchport trunk allowed vlan all	Allow all VLANs on interface xe1.
SW3(config-if)#exit	Exit the interface mode
SW3(config)#commit	Commit the configuration
SW3(config)#exit	Exit the configure terminal mode

**SW4**

SW4#configure terminal	Enter configure mode.
SW4(config)#bridge 1 protocol rstp vlan-bridge	Create bridge 1 as an RSTP VLAN-aware bridge.
SW4(config)#vlan database	Entering vlan database
SW4(config-vlan)#vlan 512 bridge 1 state enable	Create VLAN 512 on bridge 1.

## Ethernet CFM Configurations

SW4 (config-vlan) #exit	Exit vlan database
SW4 (config) #interface xe1	Configure interface xe1.
SW4 (config-if) #switchport	Configure the interface as switch port.
SW4 (config-if) #bridge-group 1	Configure interface in bridge group 1.
SW4 (config-if) #switchport mode trunk	Configure interface mode as trunk.
SW4 (config-if) #switchport trunk allowed vlan all	Allow all VLANs on interface xe1.
SW4 (config-if) #exit	Exit config mode.
SW4 (config) #interface xe9	Configure interface xe9.
SW4 (config-if) #switchport	Configure the interface as switch port.
SW4 (config-if) #bridge-group 1	Configure interface in bridge group 1.
SW4 (config-if) #switchport mode trunk	Configure interface mode as trunk.
SW4 (config-if) #switchport trunk allowed vlan all	Allow all VLANs on interface xe9.
SW4 (config-if) #exit	Exit the interface mode
SW4 (config) #commit	Commit the configuration
SW4 (config) #exit	Exit the configure terminal mode

## SW5

SW5#configure terminal	Enter configure mode.
SW5 (config) #bridge 1 protocol rstp vlan-bridge	Create bridge 1 as an RSTP VLAN-aware bridge.
SW5 (config) #vlan database	Entering vlan database
SW5 (config-vlan) #vlan 512 bridge 1 state enable	Create VLAN 512 on bridge 1.
SW5 (config-vlan) #exit	Exit vlan database
SW5 (config) #interface xe9	Configure interface xe9.
SW5 (config-if) #switchport	Configure the interface as switch port.
SW5 (config-if) #bridge-group 1	Configure interface in bridge group 1.
SW5 (config-if) #switchport mode trunk	Configure interface mode as trunk.
SW5 (config-if) #switchport trunk allowed vlan all	Allow all VLANs on interface xe9.
SW5 (config-if) #exit	Exit config mode.
SW5 (config) #ethernet cfm domain-type character-string domain-name mdnam level 7 mip-creation default	Create cfm domain with type as character string and set mip creation criteria to default.
SW5 (config-ether-cfm) #service ma-type string ma-name testtm	Create ma type as string and set mip creation criteria to default.
SW5 (config-ether-cfm-ma) #vlan 25 bridge 1	Configure vlan-id to associate the vlan to the MA
SW5 (config-ether-cfm-ma) #mip-creation default	Set the mip creation criteria to default for the MA
SW5 (config-ether-cfm-ma) #ethernet cfm mep down mpid 1 active true xe9	Create down mep on xe9.

SW5(config-ether-cfm-ma-mep)#cc multicast state enable	Enable cc multicast.
SW5(config-ether-cfm-ma-mep)#exit-ether-ma-mep-mode	Exit CFM MEP configuration mode
SW5(config-ether-cfm-ma)#mep crosscheck mpid 2	Configure crosscheck to remote MEP in VLAN 512.
SW5(config-ether-cfm-ma)#cc interval 10ms	Enable cc interval for 10 millisecond.
SW5(config-ether-cfm-ma)#exit-ether-ma-mode	Exit CFM MA configuration mode.
SW5(config-ether-cfm)#exit	Exit ethernet CFM mode.
SW5(config)#commit	Commit the configuration
SW5(config)#exit	Exit the configure terminal mode

## Validation

```
SW1#ping ethernet mac 3c2c.9926.e683 unicast source 2 domain mdnam
```

```
SW1#traceroute ethernet 3c2c.9926.e683 mepid 2 domain mdnam
MP Mac Hops Relay-action    Ingress/Egress    Ingress/Egress    action
3c2c.9926.e683    1    RlyHit    Ingress    IngOK
```

```
SW1#show ethernet cfm statistics
Continuity Check Messages
CCM Sent      : 184876
CCM Received  : 21651
```

```
Loop Back Messages
LBM Sent      : 10
LBR Received(Valid)    : 10
LBR Received(Bad msdu) : 0
LBR Received(Out-of-Seq) : 0
```

```
Link Trace Messages
LTM Sent      : 1
LTR Sent      : 0
LTR Received(Valid)    : 1
LTR Received(unexpected) : 0
```

```
SW1#show ethernet cfm maintenance-points local mep domain mdnam
MPID Dir Lvl VLAN CC-Stat HW-Status    CC-Intvl MAC-Address    Def Port    MD Name
-----
--
2    Dn    7    512    Enable    Installed    10 ms    6cb9.c567.721d F    ce49
mdnam
```

```
SW1#show ethernet cfm maintenance-points remote domain mdnam
MEPID RMEPID LEVEL LAN Rx CCM RDI PEER-MAC TYPE
-----
-2    1    7    512    Yes    False    3c2c.9926.e683 Configured
```

```
SW1#show ethernet cfm ma status domain mdnam
MA NAME      VLAN      STATUS
-----
testtm       512       Active
```

## Continuity Check Message (CCM) Over VPWS

Note: The MEP should not be created on a network interface with L3 component (support is only for UpMep on VPWS).

### SW1

SW1#configure terminal	Enter configure mode.
SW1(config)#bridge 1 protocol rstp vlan-bridge	Create bridge 1 as an RSTP VLAN-aware bridge.
SW1(config)#vlan database	Entering VLAN database.
SW1(config-vlan)#vlan 512 bridge 1 state enable	Create VLAN 512 on bridge 1.
SW1(config-vlan)#exit	Exit config mode.
SW1(config)#interface ce49	Configure interface ce49.
SW1(config-if)#switchport	Configure the interface as switch port.
SW1(config-if)#bridge-group 1	Configure interface in bridge group 1.
SW1(config-if)#switchport mode trunk	Configure interface mode as trunk.
SW1(config-if)#switchport trunk allowed vlan all	Allow all VLANs on interface ce49.
SW1(config-if)#exit	Exit interface mode.
SW1(config)#commit	Commit the configuration
SW1(config)#exit	Exit the configure terminal mode

### SW2

SW2#configure terminal	Enter configure mode.
SW2(config)#interface ce0	Configure interface ce0.
SW2(config-if)#switchport	Configure interface as a switch port.
SW2(config-if)#exit	Exit interface mode.
SW2(config)#interface xe0	Configure interface xe0.
SW2(config-if)#no switchport	Configure interface as router port.
SW2(config-if)#ip address 10.0.0.1/24	Assign IP address to router port xe0
SW2(config-if)#no shutdown	Making the interface up
SW2(config-if)#exit	Exit interface mode.
SW2(config)#interface lo	Configure interface lo
SW2(config-if)#ip address 1.1.1.1/32 secondary	Configure secondary IP address to loopback interface .

SW2(config-if)#exit	Exit interface mode.
SW2(config)#router ospf 100	Configure ospf
SW2(config-router)#network 10.0.0.0/24 area 0	Advertising 10 network
SW2(config-router)#network 1.1.1.1/32 area 0	Advertising loopback IP
SW2(config-router)#exit	Exit router mode.
SW2(config)#router rsvp	Configuring rsvp
SW2(config-router)#hello-receipt	Configuring hello reception
SW2(config-router)#no php	Configuring device as not a PHP
SW2(config-router)#revert-timer 10	Configuring reversion time of RSVP
SW2(config-router)#exit	Exit router mode.
SW2(config)#rsvp-trunk to-1 ipv4	Configuring RSVP path
SW2(config-trunk)#to 2.2.2.2	Configuring first hop
SW2(config-trunk)#to 3.3.3.3	Configuring second hop
SW2(config-trunk)#exit	Exit trunk mode.
SW2(config)#interface xe0	Configuring interface
SW2(config-if)#enable-rsvp	Enabling RSVP in interface
SW2(config-if)#label-switching	Enabling MPLS labeling
SW2(config-if)#enable-ldp ipv4	Enabling ldp on interface
SW2(config-if)#exit	Exit interface mode.
SW2(config)#router ldp	Configuring LDP
SW2(config-router)#targeted-peer ipv4 3.3.3.3	Configuring LDP target peer for PW
SW2(config-router-targeted-peer)#exit-targeted-peer-mode	Exit target peer mode
SW2(config-router)#no multicast-hellos	Disabling LDP multicast
SW2(config-router)#exit	Exit router mode.
SW2(config)#mpls l2-circuit ETH-2001 1 3.3.3.3	Creating VPWS PW
(config-pseudowire)#exit	Exit pseudowire config mode.
SW2(config)#service-template ETH-2001	Configuring service template profile for PW
SW2(config-svc)#match outer-vlan 200	Configuring match condition
SW2(config-svc)#rewrite ingress push 2000	Configuring action for match
SW2(config-svc)#exit	Exit service template mode
SW2(config)#interface ce0	Configuring interface
SW2(config-if)#mpls-l2-circuit ETH-2001 service-template ETH-2001	Mapping VPWS in AC
SW2(config-if)#exit	Exit interface mode.
SW2(config)#hardware-profile filter cfm-domain-name-str enable	Enabling HW filter for character string domain name
SW2(config)#ethernet cfm domain-type character-string domain-name 12345 level 7 mip-creation none	Configuring CFM domain over VPWS

## Ethernet CFM Configurations

SW2(config-ether-cfm-mpls-md)#service ma-type string ma-name 43981 mip-creation none	Creating MA for domain
SW2(config-ether-cfm-mpls-md-ma)#cc interval 100ms	Configuring CFM interval
SW2(config-ether-cfm-mpls-md-ma)#mep crosscheck mpid 1	Configuring remote mep
SW2(config-ether-cfm-mpls-md-ma)#ethernet cfm mep up mpid 4001 active true vpws ETH-2001	Configuring local mep and mapping the same with vpws service
SW2(config-ether-cfm-mpls-ma-mep)#cc multicast state enable	Enabling the CFM multicast
SW2(config-ether-cfm-mpls-ma-mep)#exit-ether-ma-mep-mode	Exit CFM MEP configuration mode
SW2(config-ether-cfm-mpls-md-ma)# exit-ether-ma-mode	Exit Ethernet CFM MD configuration mode
SW2(config-ether-cfm-mpls-md)# exit	Configuring LM profile
SW2(config)#ethernet cfm loss-measurement profile-name lmm	Configuring LM profile
SW2(config-cfm-lm)#measurement-type lmm	Configuring measurement type as LMM
SW2(config-cfm-lm)#message-period 3	Configuring message period
SW2(config-cfm-lm)#measurement-interval 1	Configuring measurement interval
SW2(config-cfm-lm)#intervals-stored 3	Configuring number of interval to be stored
SW2(config-cfm-lm)#exit	Exit cfm loss measurement mode
SW2(config)#commit	Commit the configuration
SW2(config)#exit	Exit the configure terminal mode

## SW3

SW3#configure terminal	Enter configure mode.
SW3(config)#interface xe1	Configure interface
SW3(config-if)#no switchport	Configure interface as router port.
SW3(config-if)#ip address 20.0.0.1/24	Assign IP address to router port
SW3(config-if)#no shutdown	Making the interface up
SW3(config-if)#exit	Exit interface mode.
SW3(config)#interface xe17	Configure interface
SW3(config-if)#no switchport	Configure interface as router port.
SW3(config-if)#ip address 10.0.0.2/24	Assign IP address to router port
SW3(config-if)#no shutdown	Making the interface up
SW3(config-if)#exit	Exit interface mode.
SW3(config)#interface lo	Configure interface lo
SW3(config-if)#ip address 2.2.2.2/32 secondary	Configure secondary IP address to loopback interface .
SW3(config-if)#exit	Exit interface mode.
SW3(config)#router ospf 100	Configure ospf



SW3(config-router)#network 10.0.0.0/24 area 0	Advertising 10 network
SW3(config-router)#network 20.0.0.0/24 area 0	Advertising 10 network
SW3(config-router)#network 2.2.2.2/32 area 0	Advertising loopback IP
SW3(config-router)#exit	Exit router mode.
SW3(config)#router rsvp	Configuring rsvp
SW3(config-router)#hello-receipt	Configuring hello reception
SW3(config-router)#no php	Configuring device as not a PHP
SW3(config-router)#revert-timer 10	Configuring reversion time of RSVP
SW3(config-router)#exit	Exit router mode.
SW3(config)#interface xe1	Configuring interface
SW3(config-if)#enable-rsvp	Enabling RSVP in interface
SW3(config-if)#label-switching	Enabling MPLS labeling
SW3(config-if)#enable-ldp ipv4	Enabling ldp on interface
SW3(config-if)#exit	Exit interface mode.
SW3(config)#interface xe17	Configuring interface
SW3(config-if)#enable-rsvp	Enabling RSVP in interface
SW3(config-if)#label-switching	Enabling MPLS labeling
SW3(config-if)#enable-ldp ipv4	Enabling ldp on interface
SW3(config-if)#exit	Exit interface mode.
SW3(config)#commit	Commit the configuration
SW3(config)#exit	Exit configure terminal mode

## SW4

SW4#configure terminal	Enter configure mode.
SW4(config)#interface xe9	Configure interface
SW4(config-if)#switchport	Configure interface as switch port.
SW4(config-if)#exit	Exit interface mode.
SW4(config)#interface xe1	Configure interface
SW4(config-if)#no switchport	Configure interface as router port.
SW4(config-if)#ip address 20.0.0.2/24	Assign IP address to router port
SW4(config-if)#no shutdown	Making the interface up
SW4(config-if)#exit	Exit interface mode.
SW4(config)#interface lo	Configure interface lo
SW4(config-if)#ip address 3.3.3.3/32 secondary	Configure secondary IP address to loopback interface .
SW4(config-if)#exit	Exit interface mode.
SW4(config)#router ospf 100	Configure ospf
SW4(config-router)#network 20.0.0.0/24 area 0	Advertising 10 network
SW4(config-router)#network 3.3.3.3/32 area 0	Advertising loopback IP

## Ethernet CFM Configurations

SW4 (config-router) #exit	Exit router mode.
SW4 (config) #router rsvp	Configuring rsvp
SW4 (config-router) #hello-receipt	Configuring hello reception
SW4 (config-router) #no php	Configuring device as not a PHP
SW4 (config-router) #revert-timer 10	Configuring reversion time of RSVP
SW4 (config-router) #exit	Exit router mode.
SW4 (config) #rsvp-trunk to-1 ipv4	Configuring RSVP path
SW4 (config-trunk) #to 2.2.2.2	Configuring first hop
SW4 (config-trunk) #to 1.1.1.1	Configuring second hop
SW4 (config-trunk) #exit	Exit trunk mode.
SW4 (config) #interface xe1	Configuring interface
SW4 (config-if) #enable-rsvp	Enabling RSVP in interface
SW4 (config-if) #label-switching	Enabling MPLS labeling
SW4 (config-if) #enable-ldp ipv4	Enabling ldp on interface
SW4 (config-if) #exit	Exit interface mode.
SW4 (config) #router ldp	Configuring LDP
SW4 (config-router) #targeted-peer ipv4 1.1.1.1	Configuring LDP target peer for PW
SW4 (config-router-targeted-peer) #exit-targeted-peer-mode	Exit target peer mode
SW4 (config-router) #no multicast-hellos	Disabling LDP multicast
SW4 (config-router) #exit	Exit router mode.
SW4 (config) #mpls l2-circuit ETH-2001 1 1.1.1.1	Creating VPWS PW
(config-pseudowire) #exit	Exit pseudowire config mode.
SW4 (config) #service-template ETH-2001	Configuring service template profile for PW
SW4 (config-svc) # match outer-vlan 200	Configuring match condition
SW4 (config-svc) # rewrite ingress push 2000	Configuring action for match
SW4 (config-svc) #exit	Exit service template mode
SW4 (config) #interface xe9	Configuring interface
SW4 (config-if) #mpls-l2-circuit ETH-2001 service-template ETH-2001	Mapping VPWS in AC
SW4 (config-if) #exit	Exit interface mode.
SW4 (config) #hardware-profile filter cfm-domain-name-str enable	Enabling HW filter for character string domain name
SW4 (config) #ethernet cfm domain-type character-string domain-name 12345 level 7 mip-creation none	Configuring CFM domain over VPWS
SW4 (config-ether-cfm-mpls-md) #service ma-type string ma-name 43981 mip-creation none	Creating MA for domain
SW4 (config-ether-cfm-mpls-md-ma) #cc interval 100ms	Configuring CFM interval
SW4 (config-ether-cfm-mpls-md-ma) #mep crosscheck mpid 4001	Configuring remote mep

SW4(config-ether-cfm-mpls-md-ma)#ethernet cfm mep up mpid 1 active true vpws ETH-2001	Configuring local mep and mapping the same with vpws service
SW4(config-ether-cfm-mpls-ma-mep)#cc multicast state enable	Enabling the CFM multicast
SW4(config-ether-cfm-mpls-ma-mep)#ethernet cfm loss-measurement reply lmm	Configuring LMR
SW4(config-ether-cfm-mpls-ma-mep)#exit-ether-ma-mep-mode	Exit CFM MEP configuration mode
SW4(config-ether-cfm-mpls-md-ma)#exit-ether-ma-mode	Exit CFM MA configuration mode
SW4(config-ether-cfm-mpls-md)#exit	Exit Ethernet CFM MD configuration mode
SW4(config)#commit	Commit the configuration
SW4(config)#exit	Exit configure terminal mode

## SW5

SW5#configure terminal	Enter configure mode.
SW5(config)#bridge 1 protocol rstp vlan-bridge	Create bridge 1 as an RSTP VLAN-aware bridge.
SW5(config)#vlan database	Entering VLAN database.
SW5(config-vlan)#vlan 512 bridge 1 state enable	Create VLAN 512 on bridge 1.
SW5(config-vlan)#exit	Exit config mode.
SW5(config)#interface xe9	Configure interface ce49.
SW5(config-if)#switchport	Configure the interface as switch port.
SW5(config-if)#bridge-group 1	Configure interface in bridge group 1
SW5(config-if)#switchport mode trunk	Configure interface mode as trunk.
SW5(config-if)#switchport trunk allowed vlan all	Allow all VLANs on interface ce49.
SW5(config-if)#exit	Exit interface mode.
SW5(config)#commit	Commit the configuration
SW5(config)#exit	Exit configure terminal mode

## Validation

```
SW1#show ethernet cfm maintenance-points remote domain 12345
MEPID      RMEPID      LEVEL      Rx CCM      RDI      PEER-MAC      TYPE
-----
200        100         7          Yes         False    b86a.97d2.27d0 Configured
```

```
SW1#show ethernet cfm ma status domain 12345
MA NAME      STATUS
-----
43981        Active
```



## CHAPTER 2 Y.1731 Performance Monitoring Configurations

ITU-T Y.1731 supports Performance Monitoring feature for Ethernet. Loss and Delay measurement can be achieved which can be significantly used to identify network problems before they impact. SLM is used to calculate the frame loss between endpoints using synthetic frames. Transmit and received counters at endpoints for received vs dropped are used to measure frame loss. CCM and LMM are used to calculate the frame loss of data traffic between endpoints. On CCM, loss measurement is encapsulated as part of CFM packets and it's dual ended. For LMM, separate loss measurement message and reply is shared on configured interval between endpoints to calculate the data frame loss. CCM and LMM service frames will have the counters which maintain a count of transmitted and received data frames between a pair of MEPs. Ethernet frame delay measurement provides fine control to operators for triggering delay measurement on a given service and can be used to monitor SLAs. Ethernet frame delay measurement also collects other useful information, such as worst and best case delays, average delay, and average delay variation.

### Synthetic Loss Measurement (SLM) over L2 Bridge

#### Topology

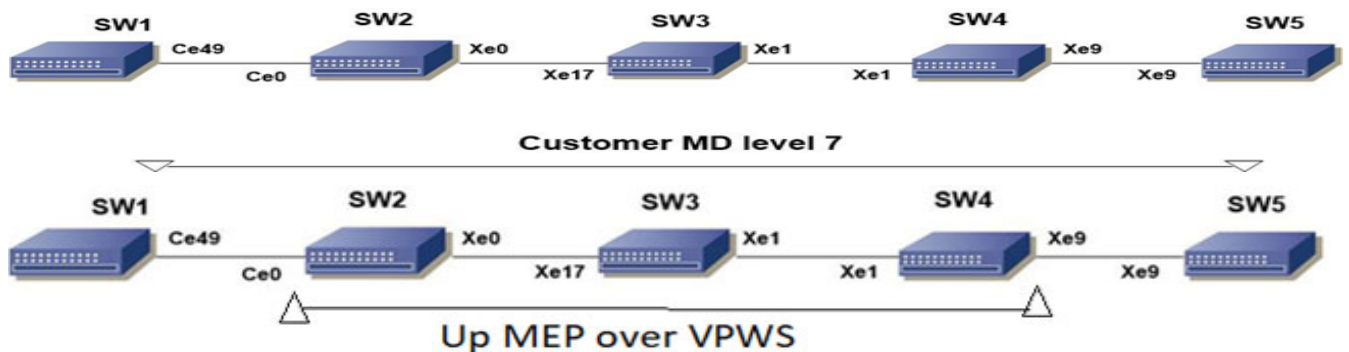

Figure 2-2: CFM Y.1731 SLM over L2 Bridge Topology

#### Prerequisite

Configure below hardware-profile commands related to CFM in configuration mode and reboot the nodes.

```
hardware-profile filter cfm-domain-name-str enable
hardware-profile statistics cfm-ccm enable
```

### Synthetic Loss Measurement (SLM) over L2 Bridge

#### SW1

SW1#configure terminal	Enter configure mode.
SW1(config)#bridge 1 protocol rstp vlan-bridge	Create bridge 1 as an RSTP VLAN-aware bridge.

## Y.1731 Performance Monitoring Configurations

SW1(config)#vlan database	Entering VLAN database.
SW1(config-vlan)#vlan 512 bridge 1 state enable	Create VLAN 512 on bridge 1.
SW1(config-vlan)#commit	Commit the candidate configuration to the running configuration.
SW1(config-vlan)#exit	Exit config mode.
SW1(config)#int ce49	Configure interface ce49.
SW1(config-if)#switchport	Configure the interface as switch port.
SW1(config-if)#bridge-group 1	Configure interface in bridge group 1.
SW1(config-if)#switchport mode trunk	Configure interface mode as trunk.
SW1(config-if)#switchport trunk allowed vlan all	Allow all VLANs on interface ce49.
SW1(config-vlan)#commit	Commit the candidate configuration to the running configuration.
SW1(config-if)#exit	Exit config mode.
SW1(config)#ethernet cfm domain-type character-string domain-name mdnam level 7 mip-creation default	Create cfm domain with type as character string and set mip creation criteria to default.
SW1(config-ether-cfm)#service ma-type string ma-name testtm	Create ma type as string and set mip creation criteria to default.
SW1(config-ether-cfm-ma)#vlan 512 bridge 1	Configure primary VLAN ID
SW1(config-ether-cfm-ma)#mip-creation default	Configure MIP creation permission
SW1(config-ether-cfm-ma)#ethernet cfm mep down mpid 2 active true ce49	Create down mep for local-vid on ce49.
SW1(config-ether-cfm-ma-mep)#cc multicast state enable	Enable cc multicast.
SW1(config-ether-cfm-ma-mep)#exit-ether-ma-mep-mode	Exit ethernet cfm ma-mep mode.
SW1(config-ether-cfm-ma)#mep crosscheck mpid 1	Configure crosscheck to remote MEP in VLAN 512.
SW1(config-ether-cfm-ma)#cc interval 10ms	Enable cc interval for 10 millisecond.
SW1(config-ether-cfm-ma)#exit-ether-ma-mode	Exit ethernet ma mode.
SW1(config-ether-cfm)#commit	Commit the candidate configuration to the running configuration.
SW1(config-ether-cfm)#exit	Exit ethernet CFM mode.
SW1(config)#ethernet cfm loss-measurement profile-name SLM	Creating loss-measurement profile for SLM
SW1(config-cfm-lm)#measurement-interval 1	Specify the measurement-interval in minutes
SW1(config)#intervals-stored 3	Specify the number of history interval to be stored
SW1(config)# message-period 1	Specify message period interval time
SW1(config)#commit	Commit the candidate configuration to the running configuration.

**SW2**

SW2#configure terminal	Enter configure mode.
SW2(config)#bridge 1 protocol rstp vlan-bridge	Create bridge 1 as an RSTP VLAN-aware bridge.
SW2(config)#vlan database	Entering VLAN database.
SW2(config-vlan)#vlan 512 type customer bridge 1 state enable	Create VLAN 512 for customer bridge.
SW2(config-vlan)#commit	Commit the candidate configuration to the running configuration.
SW2(config-vlan)#exit	Exit config mode.
SW2(config)#interface ce0	Configure interface ce0.
SW2(config)#commit	Commit the candidate configuration to the running configuration.
SW2(config-if)#switchport	Configure interface as a switch port.
SW2(config-if)#bridge-group 1	Configure interface in bridge group 1.
SW2(config-if)#switchport mode trunk	Configure interface mode as trunk.
SW2(config-if)#switchport trunk allowed vlan all	Allow all customer VLANs on interface ce0.
SW2(config-if)#commit	Commit the candidate configuration to the running configuration.
SW2(config-if)#exit	Exit interface mode.
SW2(config)#int xe0	Configure interface xe0
SW2(config-if)#switchport	Configure interface as switch port.
SW2(config-if)#bridge-group 1	Configure interface in bridge group 1.
SW2(config-if)#switchport mode trunk	Configure interface mode as trunk.
SW2(config-if)#switchport trunk allowed vlan all	Allow all VLANs on interface xe1
SW2(config-if)#commit	Commit the candidate configuration to the running configuration.
SW2(config-if)#exit	Exit config mode.

**SW3**

SW3#configure terminal	Enter configure mode.
SW3(config)#bridge 1 protocol rstp vlan-bridge	Create bridge 1 as an RSTP VLAN-aware bridge.
SW3(config)#vlan database	Entering VLAN database.
SW3(config-vlan)#vlan 512 bridge 1 state enable	Create VLAN 512 on bridge 1.
SW3(config-vlan)#commit	Commit the candidate configuration to the running configuration.
SW3(config-vlan)#exit	Exit config mode.
SW3(config)#int xe17	Configure interface xe17.
SW3(config-if)#switchport	Configure the interface as switch port.
SW3(config-if)#bridge-group 1	Configure interface in bridge group 1.

## Y.1731 Performance Monitoring Configurations

SW3(config-if)#switchport mode trunk	Configure interface mode as trunk.
SW3(config-if)#switchport trunk allowed vlan all	Allow all VLANs on interface xe17.
SW3(config-if)#commit	Commit the candidate configuration to the running configuration.
SW3(config-if)#exit	Exit config mode.
SW3(config)#int xe1	Configure interface xe1.
SW3(config-if)#switchport	Configure the interface as switch port.
SW3(config-if)#bridge-group 1	Configure interface in bridge group 1.
SW3(config-if)#switchport mode trunk	Configure interface mode as trunk.
SW3(config-if)#switchport trunk allowed vlan all	Allow all VLANs on interface xe1.
SW3(config-if)#exit	Exit config mode.

## SW4

SW4#configure terminal	Enter configure mode.
SW4(config)#bridge 1 protocol rstp vlan-bridge	Create bridge 1 as an RSTP VLAN-aware bridge.
SW4(config)#vlan database	Entering VLAN database.
SW4(config-vlan)#vlan 512 bridge 1 state enable	Create VLAN 512 on bridge 1.
SW4(config-vlan)#commit	Commit the candidate configuration to the running configuration.
SW4(config-vlan)#exit	Exit config mode.
SW4(config)#int xe1	Configure interface xe1.
SW4(config-if)#switchport	Configure the interface as switch port.
SW4(config-if)#bridge-group 1	Configure interface in bridge group 1.
SW4(config-if)#switchport mode trunk	Configure interface mode as trunk.
SW4(config-if)#switchport trunk allowed vlan all	Allow all VLANs on interface xe1.
SW4(config-if)#commit	Commit the candidate configuration to the running configuration.
SW4(config-if)#exit	Exit config mode.
SW4(config)#int xe9	Configure interface xe9.
SW4(config-if)#switchport	Configure the interface as switch port.
SW4(config-if)#bridge-group 1	Configure interface in bridge group 1.
SW4(config-if)#switchport mode trunk	Configure interface mode as trunk.
SW4(config-if)#switchport trunk allowed vlan all	Allow all VLANs on interface xe9.
SW4(config-if)#exit	Exit config mode.



**SW5**

SW5#configure terminal	Enter configure mode.
SW5 (config)#bridge 1 protocol rstp vlan-bridge	Create bridge 1 as an RSTP VLAN-aware bridge.
SW5 (config)#vlan database	Entering VLAN database.
SW5 (config-vlan)#vlan 512 bridge 1 state enable	Create VLAN 512 on bridge 1.
SW5 (config-vlan)#commit	Commit the candidate configuration to the running configuration.
SW5 (config-vlan)#exit	Exit config mode.
SW5 (config)#int xe9	Configure interface xe9.
SW5 (config-if)#switchport	Configure the interface as switch port.
SW5 (config-if)#bridge-group 1	Configure interface in bridge group 1.
SW5 (config-if)#switchport mode trunk	Configure interface mode as trunk.
SW5 (config-if)#switchport trunk allowed vlan all	Allow all VLANs on interface xe9.
SW5 (config-if)#commit	Commit the candidate configuration to the running configuration.
SW5 (config-if)#exit	Exit config mode.
SW5 (config)#ethernet cfm domain-type character-string domain-name mdnam level 7 mip-creation default	Create cfm domain with type as character string and set mip creation criteria to default.
SW5 (config-ether-cfm)#service ma-type string ma-name testtm	Create ma type as string and set mip creation criteria to default.
SW5 (config-ether-cfm-ma)#vlan 512 bridge 1	Configure primary VLAN ID
SW5 (config-ether-cfm-ma)#mip-creation default	Configure MIP creation permission
SW5 (config-ether-cfm-ma)#ethernet cfm mep down mpid 1 active true xe9	Create down mep for local-vid on xe9
SW5 (config-ether-cfm-ma-mep)#cc multicast state enable	Enable cc multicast.
SW5 (config-ether-cfm-ma-mep)#ethernet cfm loss-measurement reply slm	Generate and send SLR responses tacked
SW5 (config-ether-cfm-ma-mep)#exit-ether-ma-mep-mode	Exit ethernet cfm ma-mep mode.
SW5 (config-ether-cfm-ma)#mep crosscheck mpid 2	Configure crosscheck to remote MEP in VLAN 512.
SW5 (config-ether-cfm-ma)#cc interval 10ms	Enable cc interval for 10 millisecond.
SW5 (config-ether-cfm-ma)#exit-ether-ma-mode	Exit ethernet ma mode.
SW5 (config-ether-cfm)#commit	Commit the candidate configuration to the running configuration.
SW5 (config-ether-cfm)#exit	Exit ethernet CFM mode.

**Commands to initiate/abort loss measurement**

SW1#loss-measurement type proactive profile-name <WORD> rmep mac-address

```
<HHHH.HHHH.HHHH>mep <MEPID> domain < DOMAIN_NAME> ma <MA NAME>
```

```
SW1#abort loss-measurement mep <MEPID> domain <DOMAIN_NAME> MA <MA NAME>
```

## Validation

```
SW1#ping ethernet mac 3c2c.9926.e683 unicast source 2 domain mdnam ma
```

```
SW1#traceroute ethernet 3c2c.9926.e683 mepid 2 domain mdnam ma testtm
```

```
MP Mac           Hops  Relay-action      Ingress/Egress    Ingress/Egress ac-tion
3c2c.9926.e683   1    RlyHit           Ingress           IngOK
```

```
SW1#loss-measurement type proactive profile-name SLM rmap mac-address 3c2c.9926.e683
mep 2 domain mdnam ma testtm
```

```
SW1#show ethernet cfm loss-measurement mep 2 domain mdnam ma testtm
```

```
MEP: 2 MA: testtm
CURRENT:
Measurement ID           :1
Suspect                  :True
Measurement Type         :slm
Elapsed time(sec)        :7
Start Time                :2019 Apr 30 14:43:41
Near End loss            :0
Far End loss             :0
Near End accumulated loss : 0
Far End accumulated loss : 0
SW1# abort loss-measurement mep 2 domain mdnam
```

## Synthetic Loss Measurement (SLM) Over VPWS

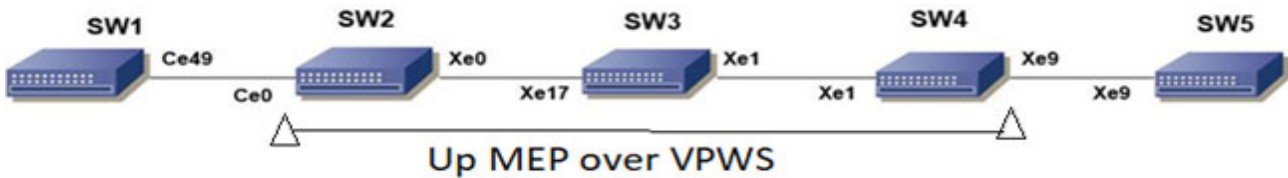

Figure 2-3: CFM Y.1731 SLM over VPWS Topology

### SW1

SW1#configure terminal	Enter configure mode.
SW1(config)#bridge 1 protocol rstp vlan-bridge	Create bridge 1 as an RSTP VLAN-aware bridge.
SW1(config)#vlan database	Entering VLAN database.
SW1(config-vlan)#vlan 512 bridge 1 state enable	Create VLAN 512 on bridge 1.

SW1 (config-vlan) #commit	Commit the candidate configuration to the running configuration.
SW1 (config-vlan) #exit	Exit config mode.
SW1 (config) #interface ce49	Configure interface ce49.
SW1 (config-if) #switchport	Configure the interface as switch port.
SW1 (config-if) #bridge-group 1	Configure interface in bridge group 1.
SW1 (config-if) #switchport mode trunk	Configure interface mode as trunk.
SW1 (config-if) #switchport trunk allowed vlan all	Allow all VLANs on interface ce49.
SW1 (config-if) #commit	Commit the candidate configuration to the running configuration.
SW1 (config-if) #exit	Exit config mode.

**SW2**

SW2#configure terminal	Enter configure mode.
SW2 (config) #interface ce0	Configure interface ce0.
SW2 (config-if) #switchport	Configure interface as a switch port.
SW2 (config-if) #commit	Commit the candidate configuration to the running configuration.
SW2 (config-if) #exit	Exit interface mode.
SW2 (config) #interface xe0	Configure interface xe1.
SW2 (config-if) #no switchport	Configure interface as router port.
SW2 (config-if) #ip address 10.0.0.1/24	Assign IP address to router port xe0
SW2 (config-if) #no shutdown	Making the interface up
SW2 (config-if) #commit	Commit the candidate configuration to the running configuration.
SW2 (config-if) #exit	Exit interface mode.
SW2 (config) #interface lo	Configure interface lo
SW2 (config-if) #ip address 1.1.1.1/32 secondary	Configure secondary IP address to loopback interface .
SW2 (config-if) #commit	Commit the candidate configuration to the running configuration.
SW2 (config-if) #exit	Exit interface mode.
SW2 (config) #router ospf 100	Configure ospf
SW2 (config-router) #network 10.0.0.0/24 area 0	Advertising 10 network
SW2 (config-router) #network 1.1.1.1/32 area 0	Advertising loopback IP
SW2 (config-router) #commit	Commit the candidate configuration to the running configuration.
SW2 (config-router) #exit	Exit router mode.
SW2 (config) #router rsvp	Configuring rsvp
SW2 (config-router) #hello-receipt	Configuring hello reception
SW2 (config-router) #no php	Configuring device as not a PHP
SW2 (config-router) #revert-timer 10	Configuring reversion time of RSVP

## Y.1731 Performance Monitoring Configurations

SW2 (config-router) #commit	Commit the candidate configuration to the running configuration.
SW2 (config-router) #exit	Exit router mode.
SW2 (config) #rsvp-trunk to-1 ipv4	Configuring RSVP path
SW2 (config-trunk) #to 2.2.2.2	Configuring first hop
SW2 (config-trunk) #to 3.3.3.3	Configuring second hop
SW2 (config-trunk) #exit	Exit trunk mode.
SW2 (config) #interface xe0	Configuring interface
SW2 (config-if) #enable-rsvp	Enabling RSVP in interface
SW2 (config-if) #label-switching	Enabling MPLS labeling
SW2 (config-if) #enable-ldp ipv4	Enabling ldp on interface
SW2 (config-if) #commit	Commit the candidate configuration to the running configuration.
SW2 (config-if) #exit	Exit interface mode.
SW2 (config) #router ldp	Configuring LDP
SW2 (config-router) #targeted-peer ipv4 3.3.3.3	Configuring LDP target peer for PW
SW2 (config-router-targeted-peer) #exit-targeted-peer-mode	Exit target peer mode
SW2 (config-router) #no multicast-hellos	Disabling LDP multicast
SW2 (config-router) #commit	Commit the candidate configuration to the running configuration.
SW2 (config-router) #exit	Exit router mode.
SW2 (config) #mpls l2-circuit ETH-2001 1 3.3.3.3	Creating VPWS PW
SW2 (config-pseudowire) #commit	Commit the candidate configuration to the running configuration.
SW2 (config-pseudowire) #exit	Exit pseudowire config mode.
SW2 (config) #service-template ETH-2001	Configuring service template profile for PW
SW2 (config-svc) #match outer-vlan 10	Configuring match condition
SW2 (config-svc) # rewrite ingress push 2000	Configuring action for match
SW2 (config-svc) #commit	Commit the candidate configuration to the running configuration.
SW2 (config-svc) #exit	Exit service template mode
SW2 (config) #interface ce0	Configuring interface
SW2 (config-if) #mpls-l2-circuit ETH-2001 service-template ETH-2001	Mapping VPWS in AC
SW2 (config-if) #commit	Commit the candidate configuration to the running configuration.
SW2 (config-if) #exit	Exit interface mode.
SW2 (config) #hardware-profile filter cfm-domain-name-str enable	Enabling HW filter for character string domain name
SW2 (config) #ethernet cfm domain-type character-string domain-name 12345 level 7 mip-creation none	Configuring CFM domain over VPWS

SW2(config-ether-cfm-mpls-md)#service ma-type string ma-name 43981 mip-creation none	Creating MA for domain
SW2(config-ether-cfm-mpls-md-ma)#cc interval 100ms	Configuring CFM interval
SW2(config-ether-cfm-mpls-md-ma)#mep cross-check mpid 1	Configuring remote mep
SW2(config-ether-cfm-mpls-md-ma)#ethernet cfm mep up mpid 4001 active true vpws ETH-2001	Configuring local mep and mapping the same with vpws service
SW2(config-ether-cfm-mpls-ma-mep)#cc multicast state enable	Enabling the CFM multicast
SW2(config-ether-cfm-mpls-ma-mep)#commit	Commit the candidate configuration to the running configuration.
SW2(config-ether-cfm-mpls-ma-mep)#exit	Exit CFM MEP configuration mode
SW2(config-ether-cfm-mpls-md-ma)#exit	Exit CFM MA configuration mode
SW2(config-ether-cfm-mpls-md)#exit	End current mode and down to previous mode
SW2(config)#ethernet cfm loss-measurement profile-name slm	Configuring LM profile
SW2(config-cfm-lm)#measurement-type slm	Configuring measurement type as SLM
SW2(config-cfm-lm)#message-period 3	Configuring message period
SW2(config-cfm-lm)#measurement-interval 1	Configuring measurement interval
SW2(config-cfm-lm)#intervals-stored 3	Configuring number of interval to be stored
SW2(config-cfm-lm)#commit	Commit the candidate configuration to the running configuration.
SW2(config-cfm-lm)#end	Exit config mode

### SW3

SW3#configure terminal	Enter configure mode.
SW3(config)#interface xe17	Configure interface
SW3(config-if)#no switchport	Configure interface as router port.
SW3(config-if)#ip address 20.0.0.1/24	Assign IP address to router port
SW3(config-if)#no shutdown	Making the interface up
SW3(config-if)#commit	Commit the candidate configuration to the running configuration.
SW3(config-if)#exit	Exit interface mode.
SW3(config)#interface xe1	Configure interface
SW3(config-if)#no switchport	Configure interface as router port.
SW3(config-if)#ip address 10.0.0.2/24	Assign IP address to router port
SW3(config-if)#no shutdown	Making the interface up
SW3(config-if)#commit	Commit the candidate configuration to the running configuration.
SW3(config-if)#exit	Exit interface mode.
SW3(config)#interface lo	Configure interface lo
SW3(config-if)#ip address 2.2.2.2/32 secondary	Configure secondary IP address to loopback interface .

## Y.1731 Performance Monitoring Configurations

SW3(config-if)#commit	Commit the candidate configuration to the running configuration.
SW3(config-if)#exit	Exit interface mode.
SW3(config)#router ospf 100	Configure ospf
SW3(config-router)#network 10.0.0.0/24 area 0	Advertising 10 network
SW3(config-router)#network 20.0.0.0/24 area 0	Advertising 10 network
SW3(config-router)#network 2.2.2.2/32 area 0	Advertising loopback IP
SW3(config-router)#commit	Commit the candidate configuration to the running configuration.
SW3(config-router)#exit	Exit router mode.
SW3(config)#router rsvp	Configuring rsvp
SW3(config-router)#hello-receipt	Configuring hello reception
SW3(config-router)#no php	Configuring device as not a PHP
SW3(config-router)#revert-timer 10	Configuring reversion time of RSVP
SW3(config-router)#commit	Commit the candidate configuration to the running configuration.
SW3(config-router)#exit	Exit router mode.
SW3(config)#interface xe1	Configuring interface
SW3(config-if)#enable-rsvp	Enabling RSVP in interface
SW3(config-if)#label-switching	Enabling MPLS labeling
SW3(config-if)#enable-ldp ipv4	Enabling ldp on interface
SW3(config-if)#commit	Commit the candidate configuration to the running configuration.
SW3(config-if)#exit	Exit interface mode.
SW3(config)#interface xe17	Configuring interface
SW3(config-if)#enable-rsvp	Enabling RSVP in interface
SW3(config-if)#label-switching	Enabling MPLS labeling
SW3(config-if)#enable-ldp ipv4	Enabling ldp on interface
SW3(config-if)#commit	Commit the candidate configuration to the running configuration.
SW3(config-if)#exit	Exit interface mode.

## SW4

SW4#configure terminal	Enter configure mode.
SW4(config)#interface xe9	Configure interface
SW4(config-if)#switchport	Configure interface as switch port.
SW4(config-if)#commit	Commit the candidate configuration to the running configuration.
SW4(config-if)#exit	Exit interface mode.
SW4(config)#interface xe1	Configure interface
SW4(config-if)#no switchport	Configure interface as router port.

SW4(config-if)#ip address 20.0.0.2/24	Assign IP address to router port
SW4(config-if)#no shutdown	Making the interface up
SW4(config-if)#commit	Commit the candidate configuration to the running configuration.
SW4(config-if)#exit	Exit interface mode.
SW4(config)#interface lo	Configure interface lo
SW4(config-if)#ip address 3.3.3.3/32 secondary	Configure secondary IP address to loopback interface .
SW4(config-if)#commit	Commit the candidate configuration to the running configuration.
SW4(config-if)#exit	Exit interface mode.
SW4(config)#router ospf 100	Configure ospf
SW4(config-router)#network 20.0.0.0/24 area 0	Advertising 10 network
SW4(config-router)#network 3.3.3.3/32 area 0	Advertising loopback IP
SW4(config-router)#commit	Commit the candidate configuration to the running configuration.
SW4(config-router)#exit	Exit router mode.
SW4(config)#router rsvp	Configuring rsvp
SW4(config-router)#hello-receipt	Configuring hello reception
SW4(config-router)#no php	Configuring device as not a PHP
SW4(config-router)#revert-timer 10	Configuring reversion time of RSVP
SW4(config-router)#commit	Commit the candidate configuration to the running configuration.
SW4(config-router)#exit	Exit router mode.
SW4(config)#rsvp-trunk to-1 ipv4	Configuring RSVP path
SW4(config-trunk)#to 2.2.2.2	Configuring first hop
SW4(config-trunk)#to 1.1.1.1	Configuring second hop
SW4(config-trunk)#commit	Commit the candidate configuration to the running configuration.
SW4(config-trunk)#exit	Exit trunk mode.
SW4(config)#interface xe1	Configuring interface
SW4(config-if)#enable-rsvp	Enabling RSVP in interface
SW4(config-if)#label-switching	Enabling MPLS labeling
SW4(config-if)#enable-ldp ipv4	Enabling ldp on interface
SW4(config-if)#commit	Commit the candidate configuration to the running configuration.
SW4(config-if)#exit	Exit interface mode.
SW4(config)#router ldp	Configuring LDP
SW4(config-router)#targeted-peer ipv4 1.1.1.1	Configuring LDP target peer for PW
SW4(config-router-targeted-peer)#exit-targeted-peer-mode	Exit target peer mode
SW4(config-router)#no multicast-hellos	Disabling LDP multicast

## Y.1731 Performance Monitoring Configurations

SW4 (config-router) #commit	Commit the candidate configuration to the running configuration.
SW4 (config-router) #exit	Exit router mode.
SW4 (config) #mpls l2-circuit ETH-2001 1 1.1.1.1	Creating VPWS PW
SW4 (config-pseudowire) #commit	Commit the candidate configuration to the running configuration.
SW4 (config-pseudowire) #exit	Exit pseudowire config mode.
SW4 (config) #service-template ETH-2001	Configuring service template profile for PW
SW4 (config-svc) # match outer-vlan 200	Configuring match condition
SW4 (config-svc) # rewrite ingress push 2000	Configuring action for match
SW4 (config-svc) #commit	Commit the candidate configuration to the running configuration.
SW4 (config-svc) #exit	Exit service template mode
SW4 (config) #interface xe9	Configuring interface
SW4 (config-if) #mpls-l2-circuit ETH-2001 service-template ETH-2001	Mapping VPWS in AC
SW4 (config-if) #commit	Commit the candidate configuration to the running configuration.
SW4 (config-if) #exit	Exit interface mode.
SW4 (config) #hardware-profile filter cfm-domain-name-str enable	Enabling HW filter for character string domain name
SW4 (config) #ethernet cfm domain-type character-string domain-name 12345 level 7 mip-creation none	Configuring CFM domain over VPWS
SW4 (config-ether-cfm-mpls-md) #service ma-type string ma-name 43981	Creating MA for domain
SW4 (config-ether-cfm-ma) #mip-creation none	Configuring MIP creation permission
SW4 (config-ether-cfm-mpls-md-ma) #cc interval 100ms	Configuring CFM interval
SW4 (config-ether-cfm-mpls-md-ma) #cc interval 3	Configuring CFM interval
SW4 (config-ether-cfm-mpls-md-ma) #mep cross-check mpid 4001	Configuring remote mep
SW4 (config-ether-cfm-mpls-md-ma) #ethernet cfm mep up mpid 1 active true vpws ETH-2001	Configuring local mep and mapping the same with vpws service
SW4 (config-ether-cfm-mpls-ma-mep) #cc multicast state enable	Enabling the CFM multicast
SW4 (config-ether-cfm-mpls-ma-mep) #ethernet cfm loss-measurement reply slm	Configuring SLR
SW4 (config-ether-cfm-mpls-ma-mep) #commit	Commit the candidate configuration to the running configuration.
SW4 (config-ether-cfm-mpls-ma-mep) #end	Exit config mode



**SW5**

SW5#configure terminal	Enter configure mode.
SW5(config)#bridge 1 protocol rstp vlan-bridge	Create bridge 1 as an RSTP VLAN-aware bridge.
SW5(config)#vlan database	Entering VLAN database.
SW5(config-vlan)#vlan 512 bridge 1 state enable	Create VLAN 512 on bridge 1.
SW5(config-vlan)#commit	Commit the candidate configuration to the running configuration.
SW5(config-vlan)#exit	Exit config mode.
SW5(config)#interface xe9	Configure interface ce49.
SW5(config-if)#switchport	Configure the interface as switch port.
SW5(config-if)#bridge-group 1	Configure interface in bridge group 1
SW5(config-if)#switchport mode trunk	Configure interface mode as trunk.
SW5(config-if)#switchport trunk allowed vlan all	Allow all VLANs on interface ce49.
SW5(config-vlan)#commit	Commit the candidate configuration to the running configuration.
SW5(config-if)#exit	Exit config mode.

**Commands to initiate/abort loss measurement**

```
SW2#loss-measurement type proactive profile-name <WORD> rmep mac-address
<HHHH.HHHH.HHHH>mep <MEPID> domain < DOMAIN_NAME>
```

```
SW2#abort loss-measurement mep <MEPID> domain <DOMAIN_NAME>
```

**Validation**

```
SW2#loss-measurement type proactive profile-name slm rmep mac-address 3c2c.9926.e683
mep 1 domain 12345
```

```
SW2#show ethernet cfm loss-measurement mep 1 domain 12345
```

```
MEP: 2 MA: 43981
```

```
CURRENT:
```

```
Measurement ID           : 1
Suspect                   : False
Measurement Type          : slm
Elapsed time(sec)        : 7
Start Time                : 2019 Apr 30 14:43:41
Near End loss             : 0
Far End loss              : 0
Near End accumulated loss : 0
Far End accumulated loss  : 0
```

```
SW2# abort loss-measurement mep 1 domain 12345
```

## Loss Measurement Message(LMM) over L2 Bridge

### Topology

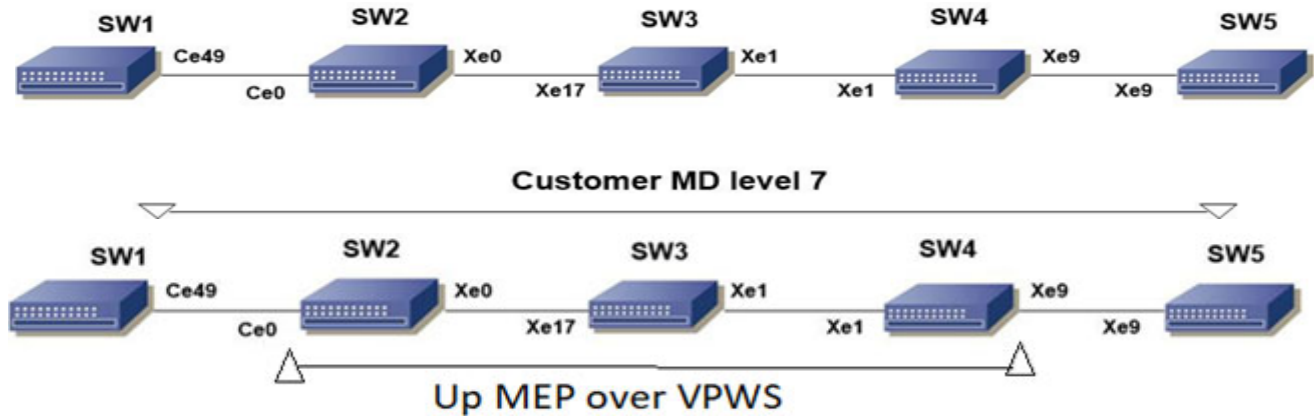

Figure 2-4: CFM Y.1731 LMM over L2 Bridge Topology

### Prerequisite

Configure below hardware-profile commands related to CFM in configuration mode and reboot the nodes.

```
hardware-profile filter cfm-domain-name-str enable
hardware-profile statistics cfm-lm enable
hardware-profile statistics cfm-ccm enable
```

### SW1

SW1#configure terminal	Enter configure mode.
SW1(config)#bridge 1 protocol rstp vlan-bridge	Create bridge 1 as an RSTP VLAN-aware bridge.
SW1(config)#vlan database	Entering vlan database
SW1(config-vlan)#vlan 512 bridge 1 state enable	Create VLAN 512 on bridge 1.
SW1(config-vlan)#commit	Commit the candidate configuration to the running configuration.
SW1(config-vlan)#exit	Exit vlan database
SW1(config)#int ce49	Configure interface ce49.
SW1(config-if)#switchport	Configure the interface as switch port.
SW1(config-if)#bridge-group 1	Configure interface in bridge group 1.
SW1(config-if)#switchport mode trunk	Configure interface mode as trunk.
SW1(config-if)#switchport trunk allowed vlan all	Allow all VLANs on interface ce49.
SW1(config-if)#commit	Commit the candidate configuration to the running configuration.
SW1(config-if)#exit	Exit config mode.

SW1(config)#ethernet cfm domain-type character-string domain-name mdnam level 7 mip-creation default	Create cfm domain with type as character string and set mip creation criteria to default.
SW1(config-ether-cfm)#service ma-type string ma-name testtm	Create ma type as string and set mip creation criteria to default.
SW1(config-ether-cfm)#vlan 512	Configure primary VLAN ID
SW1(config-ether-cfm-ma)#mip-creation default	Configure MIP creation permission
SW1(config-ether-cfm-ma)#ethernet cfm mep down mpid 2 active true local-vid 512 ce49	Create down mep for local-vid on ce49.
SW1(config-ether-cfm-ma-mep)#cc multicast state enable	Enable cc multicast.
SW1(config-ether-cfm-ma-mep)#exit-ether-ma-mep-mode	Exit ethernet cfm ma-mep mode.
SW1(config-ether-cfm-ma)#mep crosscheck mpid 1	Configure crosscheck to remote MEP in VLAN 512.
SW1(config-ether-cfm-ma)#cc interval 10ms	Enable cc interval for 10 millisecond.
SW1(config-ether-cfm-ma)#exit-ether-ma-mode	Exit ethernet ma mode.
SW1(config-ether-cfm)#commit	Commit the candidate configuration to the running configuration.
SW1(config-ether-cfm)#exit	Exit ethernet CFM mode.
SW1(config)# ethernet cfm loss-measurement profile-name LMM	Creating loss-measurement profile for LMM
SW1(config-cfm-lm)# measurement-type lmm	Specify the measurement type
SW1(config-cfm-lm)# measurement-interval 1	Specify the measurement-interval in minutes
SW1(config)# intervals-stored 3	Specify the number of history interval to be stored
SW1(config)# message-period 1s	Specify message period interval time
SW1(config)#commit	Commit the candidate configuration to the running configuration.

**SW2**

SW2#configure terminal	Enter configure mode.
SW2(config)#bridge 1 protocol rstp vlan-bridge	Create bridge 1 as an RSTP VLAN-aware bridge.
SW2(config)#vlan database	Entering vlan database
SW2(config-vlan)#vlan 512 bridge 1 state enable	Create VLAN 512 on bridge 1.
SW2(config-vlan)#commit	Commit the candidate configuration to the running configuration.
SW2(config-vlan)#exit	Exit vlan database
SW2(config)#int ce0	Configure interface ce0.
SW2(config-if)#switchport	Configure the interface as switch port.
SW2(config-if)#bridge-group 1	Configure interface in bridge group 1.
SW2(config-if)#switchport mode trunk	Configure interface mode as trunk.
SW2(config-if)#switchport trunk allowed vlan all	Allow all VLANs on interface ce0.

## Y.1731 Performance Monitoring Configurations

SW2 (config-if) #commit	Commit the candidate configuration to the running configuration.
SW2 (config-if) #exit	Exit config mode.
SW2 (config) #int xe0	Configure interface xe0.
SW2 (config-if) #switchport	Configure the interface as switch port.
SW2 (config-if) #bridge-group 1	Configure interface in bridge group 1.
SW2 (config-if) #switchport mode trunk	Configure interface mode as trunk.
SW2 (config-if) #switchport trunk allowed vlan all	Allow all VLANs on interface xe1.
SW2 (config-if) #commit	Commit the candidate configuration to the running configuration.
SW2 (config-if) #exit	Exit config mode.

### SW3

SW3#configure terminal	Enter configure mode.
SW3 (config) #bridge 1 protocol rstp vlan-bridge	Create bridge 1 as an RSTP VLAN-aware bridge.
SW3 (config) #vlan database	Entering vlan database
SW3 (config-vlan) #vlan 512 bridge 1 state enable	Create VLAN 512 on bridge 1.
SW3 (config-vlan) #commit	Commit the candidate configuration to the running configuration.
SW3 (config-vlan) #exit	Exit vlan database
SW3 (config) #int xe17	Configure interface xe17.
SW3 (config-if) #switchport	Configure the interface as switch port.
SW3 (config-if) #bridge-group 1	Configure interface in bridge group 1.
SW3 (config-if) #switchport mode trunk	Configure interface mode as trunk.
SW3 (config-if) #switchport trunk allowed vlan all	Allow all VLANs on interface xe17.
SW3 (config-if) #commit	Commit the candidate configuration to the running configuration.
SW3 (config-if) #exit	Exit config mode.
SW3 (config) #int xe1	Configure interface xe1.
SW3 (config-if) #switchport	Configure the interface as switch port.
SW3 (config-if) #bridge-group 1	Configure interface in bridge group 1.
SW3 (config-if) #switchport mode trunk	Configure interface mode as trunk.
SW3 (config-if) #switchport trunk allowed vlan all	Allow all VLANs on interface xe1.
SW3 (config-if) #commit	Commit the candidate configuration to the running configuration.
SW3 (config-if) #exit	Exit config mode.

**SW4**

SW4#configure terminal	Enter configure mode.
SW4(config)#bridge 1 protocol rstp vlan-bridge	Create bridge 1 as an RSTP VLAN-aware bridge.
SW4(config)#vlan database	Entering vlan database
SW4(config-vlan)#vlan 512 bridge 1 state enable	Create VLAN 512 on bridge 1.
SW4(config-vlan)#commit	Commit the candidate configuration to the running configuration.
SW4(config-vlan)#exit	Exit vlan database
SW4(config)#int xe1	Configure interface xe1.
SW4(config-if)#switchport	Configure the interface as switch port.
SW4(config-if)#bridge-group 1	Configure interface in bridge group 1.
SW4(config-if)#switchport mode trunk	Configure interface mode as trunk.
SW4(config-if)#switchport trunk allowed vlan all	Allow all VLANs on interface xe1.
SW4(config-if)#commit	Commit the candidate configuration to the running configuration.
SW4(config-if)#exit	Exit config mode.
SW4(config)#int xe9	Configure interface xe9.
SW4(config-if)#switchport	Configure the interface as switch port.
SW4(config-if)#bridge-group 1	Configure interface in bridge group 1.
SW4(config-if)#switchport mode trunk	Configure interface mode as trunk.
SW4(config-if)#switchport trunk allowed vlan all	Allow all VLANs on interface xe9.
SW4(config-if)#commit	Commit the candidate configuration to the running configuration.
SW4(config-if)#exit	Exit config mode.

**SW5**

SW5#configure terminal	Enter configure mode.
SW5(config)#bridge 1 protocol rstp vlan-bridge	Create bridge 1 as an RSTP VLAN-aware bridge.
SW5(config)#vlan database	Entering vlan database
SW5(config-vlan)#vlan 512 bridge 1 state enable	Create VLAN 512 on bridge 1.
SW5(config-if)#commit	Commit the candidate configuration to the running configuration.
SW5(config-vlan)#exit	Exit vlan database
SW5(config)#int xe9	Configure interface xe9.
SW5(config-if)#switchport	Configure the interface as switch port.
SW5(config-if)#bridge-group 1	Configure interface in bridge group 1.
SW5(config-if)#switchport mode trunk	Configure interface mode as trunk.

SW5(config-if)#switchport trunk allowed vlan all	Allow all VLANs on interface xe9.
SW5(config-if)#commit	Commit the candidate configuration to the running configuration.
SW5(config-if)#exit	Exit config mode.
SW5(config)#ethernet cfm domain-type character-string domain-name mdnam level 7 mip-creation default	Create cfm domain with type as character string and set mip creation criteria to default.
SW5(config-ether-cfm)#service ma-type string ma-name testtm	Create ma type as string and set mip creation criteria to default.
SW5(config-ether-cfm-ma)#vlan 512 bridge 1	Configure primary VLAN ID
SW5(config-ether-cfm-ma)#mip-creation default	Configure MIP creation permission
SW5(config-ether-cfm-ma)#ethernet cfm mep down mpid 1 active true xe9	Create down mep for local-vid on xe9
SW5(config-ether-cfm-ma-mep)#cc multicast state enable	Enable cc multicast.
SW5(config-ether-cfm-ma-mep)#ethernet cfm loss-measurement reply lmm	Generate and send LMR responses tacked
SW5(config-ether-cfm-ma-mep)#exit-ether-ma-mep-mode	Exit ethernet cfm ma-mep mode.
SW5(config-ether-cfm-ma)#mep crosscheck mpid 2	Configure crosscheck to remote MEP in VLAN 512.
SW5(config-ether-cfm-ma)#cc interval 10ms	Enable cc interval for 10 millisecond.
SW5(config-ether-cfm-ma)#exit-ether-ma-mode	Exit ethernet ma mode.
SW5(config-ether-cfm-ma)#commit	Commit the candidate configuration to the running configuration.
SW5(config-ether-cfm)#exit	Exit ethernet CFM mode.

## Commands to initiate/abort loss measurement

```
loss-measurement type on-demand profile-name <WORD> rmep mac-address <HHHH.HHHH.HHHH>
start-time <immediate|relative|absolute> stop-time <none|absolute|relative> repetition-
period <REP-TIME> mep <MEPID> domain <DOMAIN_NAME> ma <MA_NAME>
```

```
loss-measurement type proactive profile-name <WORD> rmep mac-address
<HHHH.HHHH.HHHH>mep <MEPID> domain <DOMAIN_NAME> ma <MA_NAME>
```

```
abort loss-measurement mep <MEPID> domain <DOMAIN_NAME> ma <MA_NAME>
```

```
clear ethernet cfm loss-measurement mep <MEPID> domain <DOMAIN_NAME> ma <MA_NAME>
```

## Validation

```
SW1#ping ethernet mac 3c2c.9926.e683 unicast source 2 domain mdnam ma
```

```
SW1#traceroute ethernet 3c2c.9926.e683 mepid 2 domain mdnam ma testtm
MP Mac          Hops  Relay-action          Ingress/Egress  Ingress/Egress action
3c2c.9926.e683  1     RlyHit                Ingress         IngOK
```

```
SW1# loss-measurement type proactive profile-name LMM rmap mac-address 3c2c.9926.e683
mep 2 domain mdnam ma testtm
```

```
SW1# show ethernet cfm loss-measurement mep 2 domain mdnam ma testtm
```

```
MEP: 2 MA: testtm
```

```
CURRENT:
```

```
Measurement ID           : 1
Suspect                  : False
Measurement Type         : lmm
Elapsed time(sec)        : 24
Start Time               : 2019 Jul 21 00:10:36
Near End loss            : 0
Far End loss             : 0
Near End accumulated loss : 0
Far End accumulated loss  : 0
```

```
SW1# abort loss-measurement mep 2 domain mdnam ma testtm
```

## Loss Measurement Message (LMM) Over VPWS

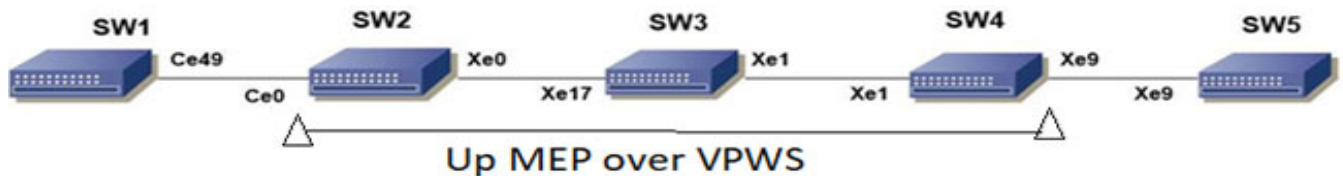

Figure 2-5: CFM Y.1731 LMM over VPWS Topology

### SW1

SW1#configure terminal	Enter configure mode.
SW1(config)#bridge 1 protocol rstp vlan-bridge	Create bridge 1 as an RSTP VLAN-aware bridge.
SW1(config)#vlan database	Entering VLAN database.
SW1(config-vlan)#vlan 512 bridge 1 state enable	Create VLAN 512 on bridge 1.
SW1(config-vlan)#commit	Commit the candidate configuration to the running configuration.
SW1(config-vlan)#exit	Exit config mode.
SW1(config)#interface ce49	Configure interface ce49.
SW1(config-if)#switchport	Configure the interface as switch port.
SW1(config-if)#bridge-group 1	Configure interface in bridge group 1.
SW1(config-if)#switchport mode trunk	Configure interface mode as trunk.
SW1(config-if)#switchport trunk allowed vlan all	Allow all VLANs on interface ce49.
SW1(config-if)#commit	Commit the candidate configuration to the running configuration.
SW1(config-if)#exit	Exit config mode.

**SW2**

SW2#configure terminal	Enter configure mode.
SW2 (config)#interface ce0	Configure interface ce0.
SW2 (config-if)#switchport	Configure interface as a switch port.
SW2 (config-if)#commit	Commit the candidate configuration to the running configuration.
SW2 (config-if)#exit	Exit interface mode.
SW2 (config)#interface xe0	Configure interface xe0.
SW2 (config-if)#no switchport	Configure interface as router port.
SW2 (config-if)#ip address 10.0.0.1/24	Assign IP address to router port xe0
SW2 (config-if)#no shutdown	Making the interface up
SW2 (config-if)#commit	Commit the candidate configuration to the running configuration.
SW2 (config-if)#exit	Exit interface mode.
SW2 (config)#interface lo	Configure interface lo
SW2 (config-if)#ip address 1.1.1.1/32 secondary	Configure secondary IP address to loopback interface .
SW2 (config-if)#commit	Commit the candidate configuration to the running configuration.
SW2 (config-if)#exit	Exit interface mode.
SW2 (config)#router ospf 100	Configure ospf
SW2 (config-router)#network 10.0.0.0/24 area 0	Advertising 10 network
SW2 (config-router)#network 1.1.1.1/32 area 0	Advertising loopback IP
SW2 (config-router)#commit	Commit the candidate configuration to the running configuration.
SW2 (config-router)#exit	Exit router mode.
SW2 (config)#router rsvp	Configuring rsvp
SW2 (config-router)#hello-receipt	Configuring hello reception
SW2 (config-router)#no php	Configuring device as not a PHP
SW2 (config-router)#revert-timer 10	Configuring reversion time of RSVP
SW2 (config-router)#commit	Commit the candidate configuration to the running configuration.
SW2 (config-router)#exit	Exit router mode.
SW2 (config)#rsvp-trunk to-1 ipv4	Configuring RSVP path
SW2 (config-trunk)#to 2.2.2.2	Configuring first hop
SW2 (config-trunk)#to 3.3.3.3	Configuring second hop
SW2 (config-trunk)#commit	Commit the candidate configuration to the running configuration.
SW2 (config-trunk)#exit	Exit trunk mode.
SW2 (config)#interface xe0	Configuring interface
SW2 (config-if)#enable-rsvp	Enabling RSVP in interface
SW2 (config-if)#label-switching	Enabling MPLS labeling



SW2 (config-if) #enable-ldp ipv4	Enabling ldp on interface
SW2 (config-if) #commit	Commit the candidate configuration to the running configuration.
SW2 (config-if) #exit	Exit interface mode.
SW2 (config) #router ldp	Configuring LDP
SW2 (config-router) #targeted-peer ipv4 3.3.3.3	Configuring LDP target peer for PW
SW2 (config-router-targeted-peer) #exit-targeted-peer-mode	Exit target peer mode
SW2 (config-router) #no multicast-hellos	Disabling LDP multicast
SW2 (config-vlan) #commit	Commit the candidate configuration to the running configuration.
SW2 (config-router) #exit	Exit router mode.
SW2 (config) #mpls l2-circuit ETH-2001 1 3.3.3.3	Creating VPWS PW
SW2 (config-pseudowire) #commit	Commit the candidate configuration to the running configuration.
SW2 (config-pseudowire) #exit	Exit pseudowire config mode.
SW2 (config) #service-template ETH-2001	Configuring service template profile for PW
SW2 (config-svc) #match outer-vlan 200	Configuring match condition
SW2 (config-svc) # rewrite ingress push 2000	Configuring action for match
SW2 (config-svc) #commit	Commit the candidate configuration to the running configuration.
SW2 (config-svc) #exit	Exit service template mode
SW2 (config) #interface ce0	Configuring interface
SW2 (config-if) #mpls-l2-circuit ETH-2001 service-template ETH-2001	Mapping VPWS in AC
SW2 (config-if) #commit	Commit the candidate configuration to the running configuration.
SW2 (config-if) #exit	Exit interface mode.
SW2 (config) #hardware-profile filter cfm-domain-name-str enable	Enabling HW filter for character string domain name
SW2 (config) #ethernet cfm domain-type character-string domain-name 12345 level 7 mip-creation none	Configuring CFM domain over VPWS
SW2 (config-ether-cfm-mpls-md) #service ma-type string ma-name 43981 mip-creation none	Creating MA for domain
SW2 (config-ether-cfm-mpls-md-ma) #cc interval 100ms	Configuring CFM interval
SW2 (config-ether-cfm-mpls-md-ma) #mep cross-check mpid 1	Configuring remote mep
SW2 (config-ether-cfm-mpls-md-ma) #ethernet cfm mep up mpid 4001 active true vpws ETH-2001	Configuring local mep and mapping the same with vpws service
SW2 (config-ether-cfm-mpls-ma-mep) #cc multicast state enable	Enabling the CFM multicast
SW2 (config-ether-cfm-mpls-ma-mep) #commit	Commit the candidate configuration to the running configuration.

## Y.1731 Performance Monitoring Configurations

SW2 (config-ether-cfm-mpls-ma-mep) #exit	Exit CFM MEP configuration mode
SW2 (config-ether-cfm-mpls-md-ma) #exit	Exit CFM MA configuration mode
SW2 (config-ether-cfm-mpls-md) #exit	End current mode and down to previous mode
SW2 (config) #ethernet cfm loss-measurement profile-name lmm	Configuring LM profile
SW2 (config-cfm-lm) #measurement-type lmm	Configuring measurement type as LMM
SW2 (config-cfm-lm) #message-period 3	Configuring message period
SW2 (config-cfm-lm) #measurement-interval 1	Configuring measurement interval
SW2 (config-cfm-lm) #intervals-stored 3	Configuring number of interval to be stored
SW2 (config-cfm-lm) #commit	Commit the candidate configuration to the running configuration.
SW2 (config-cfm-lm) #end	Exit config mode

### SW3

SW3#configure terminal	Enter configure mode.
SW3 (config) #interface xe17	Configure interface
SW3 (config-if) #no switchport	Configure interface as router port.
SW3 (config-if) #ip address 20.0.0.1/24	Assign IP address to router port
SW3 (config-if) #no shutdown	Making the interface up
SW3 (config-if) #commit	Commit the candidate configuration to the running configuration.
SW3 (config-if) #exit	Exit interface mode.
SW3 (config) #interface xe1	Configure interface
SW3 (config-if) #no switchport	Configure interface as router port.
SW3 (config-if) #ip address 10.0.0.2/24	Assign IP address to router port
SW3 (config-if) #no shutdown	Making the interface up
SW3 (config-if) #commit	Commit the candidate configuration to the running configuration.
SW3 (config-if) #exit	Exit interface mode.
SW3 (config) #interface lo	Configure interface lo
SW3 (config-if) #ip address 2.2.2.2/32 secondary	Configure secondary IP address to loopback interface.
SW3 (config-if) #commit	Commit the candidate configuration to the running configuration.
SW3 (config-if) #exit	Exit interface mode.
SW3 (config) #router ospf 100	Configure ospf
SW3 (config-router) #network 10.0.0.0/24 area 0	Advertising 10 network
SW3 (config-router) #network 20.0.0.0/24 area 0	Advertising 10 network
SW3 (config-router) #network 2.2.2.2/32 area 0	Advertising loopback IP
SW3 (config-router) #commit	Commit the candidate configuration to the running configuration.
SW3 (config-router) #exit	Exit router mode.

SW3(config)#router rsvp	Configuring rsvp
SW3(config-router)#hello-receipt	Configuring hello reception
SW3(config-router)#no php	Configuring device as not a PHP
SW3(config-router)#revert-timer 10	Configuring reversion time of RSVP
SW3(config-router)#commit	Commit the candidate configuration to the running configuration.
SW3(config-router)#exit	Exit router mode.
SW3(config)#interface xe1	Configuring interface
SW3(config-if)#enable-rsvp	Enabling RSVP in interface
SW3(config-if)#label-switching	Enabling MPLS labeling
SW3(config-if)#enable-ldp ipv4	Enabling ldp on interface
SW3(config-if)#commit	Commit the candidate configuration to the running configuration.
SW3(config-if)#exit	Exit interface mode.
SW3(config)#interface xe17	Configuring interface
SW3(config-if)#enable-rsvp	Enabling RSVP in interface
SW3(config-if)#label-switching	Enabling MPLS labeling
SW3(config-if)#enable-ldp ipv4	Enabling ldp on interface
SW3(config-if)#commit	Commit the candidate configuration to the running configuration.
SW3(config-if)#exit	Exit interface mode.

## SW4

SW4#configure terminal	Enter configure mode.
SW4(config)#interface xe9	Configure interface
SW4(config-if)#switchport	Configure interface as switch port.
SW4(config-if)#commit	Commit the candidate configuration to the running configuration.
SW4(config-if)#exit	Exit interface mode.
SW4(config)#interface xe1	Configure interface
SW4(config-if)#no switchport	Configure interface as router port.
SW4(config-if)#ip address 20.0.0.2/24	Assign IP address to router port
SW4(config-if)#no shutdown	Making the interface up
SW4(config-if)#commit	Commit the candidate configuration to the running configuration.
SW4(config-if)#exit	Exit interface mode.
SW4(config)#interface lo	Configure interface lo
SW4(config-if)#ip address 3.3.3.3/32 secondary	Configure secondary IP address to loopback interface .
SW4(config-if)#commit	Commit the candidate configuration to the running configuration.
SW4(config-if)#exit	Exit interface mode.
SW4(config)#router ospf 100	Configure ospf

## Y.1731 Performance Monitoring Configurations

SW4 (config-router) #network 20.0.0.0/24 area 0	Advertising 10 network
SW4 (config-router) #network 3.3.3.3/32 area 0	Advertising loopback IP
SW4 (config-router) #commit	Commit the candidate configuration to the running configuration.
SW4 (config-router) #exit	Exit router mode.
SW4 (config) #router rsvp	Configuring rsvp
SW4 (config-router) #hello-receipt	Configuring hello reception
SW4 (config-router) #no php	Configuring device as not a PHP
SW4 (config-router) #revert-timer 10	Configuring reversion time of RSVP
SW4 (config-router) #exit	Exit router mode.
SW4 (config) #rsvp-trunk to-1 ipv4	Configuring RSVP path
SW4 (config-trunk) #to 2.2.2.2	Configuring first hop
SW4 (config-trunk) #to 1.1.1.1	Configuring second hop
SW4 (config-trunk) #commit	Commit the candidate configuration to the running configuration.
SW4 (config-trunk) #exit	Exit trunk mode.
SW4 (config) #interface xe1	Configuring interface
SW4 (config-if) #enable-rsvp	Enabling RSVP in interface
SW4 (config-if) #label-switching	Enabling MPLS labeling
SW4 (config-if) #enable-ldp ipv4	Enabling ldp on interface
SW4 (config-if) #commit	Commit the candidate configuration to the running configuration.
SW4 (config-if) #exit	Exit interface mode.
SW4 (config) #router ldp	Configuring LDP
SW4 (config-router) #targeted-peer ipv4 1.1.1.1	Configuring LDP target peer for PW
SW4 (config-router-targeted-peer) #exit-targeted-peer-mode	Exit target peer mode
SW4 (config-router) #no multicast-hellos	Disabling LDP multicast
SW4 (config-router) #commit	Commit the candidate configuration to the running configuration.
SW4 (config-router) #exit	Exit router mode.
SW4 (config) #mpls l2-circuit ETH-2001 1 1.1.1.1	Creating VPWS PW
SW4 (config-pseudowire) #commit	Commit the candidate configuration to the running configuration.
SW4 (config-pseudowire) #exit	Exit pseudowire config mode.
SW4 (config) #service-template ETH-2001	Configuring service template profile for PW
SW4 (config-svc) # match outer-vlan 200	Configuring match condition
SW4 (config-svc) # rewrite ingress push 2000	Configuring action for match
SW4 (config-svc) #commit	Commit the candidate configuration to the running configuration.
SW4 (config-svc) #exit	Exit service template mode

SW4(config)#interface xe9	Configuring interface
SW4(config-if)#mpls-l2-circuit ETH-2001 service-template ETH-2001	Mapping VPWS in AC
SW4(config-if)#commit	Commit the candidate configuration to the running configuration.
SW4(config-if)#exit	Exit interface mode.
SW4(config)#hardware-profile filter cfm-domain-name-str enable	Enabling HW filter for character string domain name
SW4(config)#ethernet cfm domain-type character-string domain-name 12345 level 7 mip-creation none	Configuring CFM domain over VPWS
SW4(config-ether-cfm-mpls-md)#service ma-type string ma-name 43981	Creating MA for domain
SW4(config-ether-cfm-ma)#mip-creation none	Configuring MIP creation permission
SW4(config-ether-cfm-mpls-md-ma)#cc interval 100ms	Configuring CFM interval
SW4(config-ether-cfm-mpls-md-ma)#mep cross-check mpid 4001	Configuring remote mep
SW4(config-ether-cfm-mpls-md-ma)#ethernet cfm mep up mpid 1 active true vpws ETH-2001	Configuring local mep and mapping the same with vpws service
SW4(config-ether-cfm-mpls-ma-mep)#cc multicast state enable	Enabling the CFM multicast
SW4(config-ether-cfm-mpls-ma-mep)#ethernet cfm loss-measurement reply lmm	Configuring LMR
SW4(config-ether-cfm-mpls-ma-mep)#commit	Commit the candidate configuration to the running configuration.
SW4(config-ether-cfm-mpls-ma-mep)#end	Exit config mode

**SW5**

SW5#configure terminal	Enter configure mode.
SW5(config)#bridge 1 protocol rstp vlan-bridge	Create bridge 1 as an RSTP VLAN-aware bridge.
SW5(config)#vlan database	Entering VLAN database.
SW5(config-vlan)#vlan 512 bridge 1 state enable	Create VLAN 512 on bridge 1.
SW5(config-vlan)#commit	Commit the candidate configuration to the running configuration.
SW5(config-vlan)#exit	Exit config mode.
SW5(config)#interface xe9	Configure interface ce49.
SW5(config-if)#switchport	Configure the interface as switch port.
SW5(config-if)#bridge-group 1	Configure interface in bridge group 1
SW5(config-if)#switchport mode trunk	Configure interface mode as trunk.
SW5(config-if)#switchport trunk allowed vlan all	Allow all VLANs on interface ce49.
SW5(config-if)#commit	Commit the candidate configuration to the running configuration.
SW5(config-if)#exit	Exit config mode.

---

## Commands to initiate/abort loss measurement

```
SW2#loss-measurement type proactive profile-name <WORD> rmep mac-address  
<HHHH.HHHH.HHHH>mep <MEPID> domain < DOMAIN_NAME>
```

```
SW2#abort loss-measurement mep <MEPID> domain <DOMAIN_NAME>
```

---

## Validation

```
SW2#loss-measurement type proactive profile-name lmm rmep mac-address 3c2c.9926.e683  
mep 1 domain 12345
```

```
SW2#show ethernet cfm loss-measurement mep 1 domain 12345
```

```
MEP: 2 MA: 43981
```

```
CURRENT:
```

```
Measurement ID           : 1  
Suspect                   : False  
Measurement Type         : lmm  
Elapsed time(sec)        : 7  
Start Time                : 2019 Apr 30 14:43:41  
Near End loss             : 0  
Far End loss              : 0  
Near End accumulatedloss : 0  
Far End accumulated loss : 0
```

```
SW2# abort loss-measurement mep 1 domain 12345
```

## Delay Measurement (DM) over L2 Bridge

### Topology

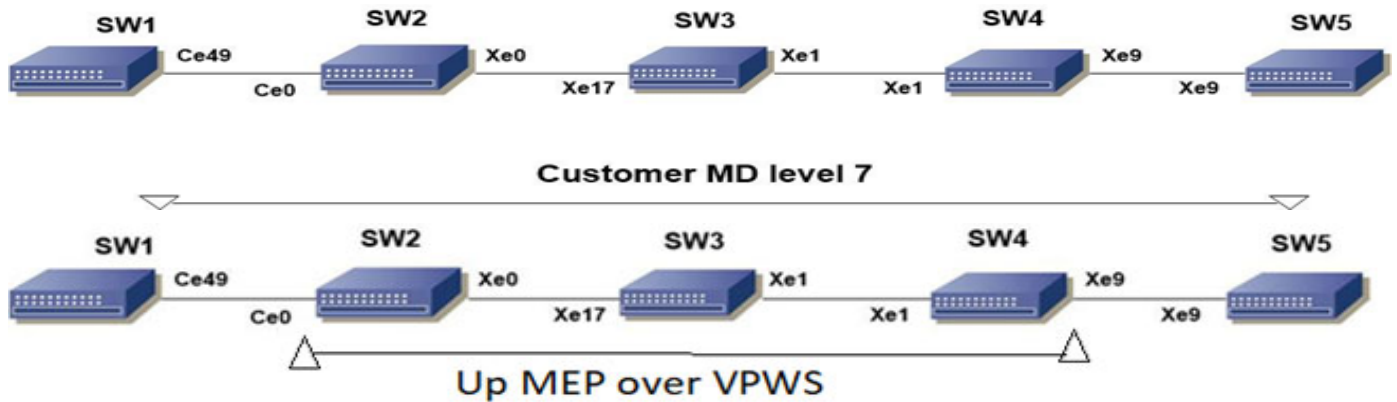

Figure 2-6: CFM Y.1731 DM over L2 Bridge Topology

### Prerequisite

Configure below hardware-profile commands related to CFM in configuration mode and reboot the nodes.

```
hardware-profile filter cfm-domain-name-str enable
hardware-profile statistics ingress-acl enable
hardware-profile statistics cfm-lm enable
hardware-profile statistics cfm-ccm enable
```

### SW1

SW1#configure terminal	Enter configure mode.
SW1(config)#bridge 1 protocol rstp vlan-bridge	Create bridge 1 as an RSTP VLAN-aware bridge.
SW1(config)#vlan database	Entering vlan database
SW1(config-vlan)#vlan 512 bridge 1 state enable	Create VLAN 512 on bridge 1.
SW1(config-vlan)#commit	Commit the candidate configuration to the running configuration.
SW1(config-vlan)#exit	Exit vlan database
SW1(config)#int ce49	Configure interface ce49.
SW1(config-if)#switchport	Configure the interface as switch port.
SW1(config-if)#bridge-group 1	Configure interface in bridge group 1.
SW1(config-if)#switchport mode trunk	Configure interface mode as trunk.
SW1(config-if)#switchport trunk allowed vlan all	Allow all VLANs on interface ce49.
SW1(config-if)#commit	Commit the candidate configuration to the running configuration.
SW1(config-if)#exit	Exit config mode.

## Y.1731 Performance Monitoring Configurations

SW1(config)#ethernet cfm domain-type character-string domain-name mdnam level 7 mip-creation default	Create cfm domain with type as character string and set mip creation criteria to default.
SW1(config-ether-cfm)#service ma-type string ma-name testtm	Create ma type as string and set mip creation criteria to default.
SW1(config-ether-cfm-ma)#vlan 512 bridge 1	Configure primary VLAN ID
SW1(config-ether-cfm-ma)#mip-creation default	Configure MIP creation permission
SW1(config-ether-cfm-ma)#ethernet cfm mep down mpid 2 active true ce49	Create down mep for local-vid on ce49.
SW1(config-ether-cfm-ma-mep)#cc multicast state enable	Enable cc multicast.
SW1(config-ether-cfm-ma-mep)#exit-ether-ma-mep-mode	Exit ethernet cfm ma-mep mode.
SW1(config-ether-cfm-ma)#mep crosscheck mpid 1	Configure crosscheck to remote MEP in VLAN 512.
SW1(config-ether-cfm-ma)#cc interval 10ms	Enable cc interval for 10 millisecond.
SW1(config-ether-cfm-ma)#exit-ether-ma-mode	Exit ethernet ma mode.
SW1(config-ether-cfm)#commit	Commit the candidate configuration to the running configuration.
SW1(config-ether-cfm)#exit	Exit ethernet CFM mode.
SW1(config)# ethernet cfm delay-measurement profile-name DM	Creating loss-measurement profile for DM
SW1(config-cfm-dm)# measurement-interval 1	Specify the measurement-interval in minutes
SW1(config-cfm-dm)# intervals-stored 3	Specify the number of history interval to be stored
SW1(config-cfm-dm)# message-period 1s	Specify message period interval time
SW1(config-cfm-dm)# bins-per-fd-interval 4	Specify the number of measurement bins per Measurement Interval for Frame Delay measurements.
SW1(config-cfm-dm)# bins-per-ifdv-interval 3	Specify the number of measurement bins per Measurement Interval for Inter-Frame Delay Variation measurements.
SW1(config-cfm-dm)#commit	Commit the candidate configuration to the running configuration.

## SW2

SW2#configure terminal	Enter configure mode.
SW2(config)#bridge 1 protocol rstp vlan-bridge	Create bridge 1 as an RSTP VLAN-aware bridge.
SW2(config)#vlan database	Entering vlan database
SW2(config-vlan)#vlan 512 bridge 1 state enable	Create VLAN 512 on bridge 1.
SW2(config-vlan)#commit	Commit the candidate configuration to the running configuration.
SW2(config-vlan)#exit	Exit vlan database
SW2(config)#int ce0	Configure interface ce0.
SW2(config-if)#switchport	Configure the interface as switch port.
SW2(config-if)#bridge-group 1	Configure interface in bridge group 1.



SW2(config-if)#switchport mode trunk	Configure interface mode as trunk.
SW2(config-if)#switchport trunk allowed vlan all	Allow all VLANs on interface ce0.
SW2(config-if)#commit	Commit the candidate configuration to the running configuration.
SW2(config-if)#exit	Exit config mode.
SW2(config)#int xe0	Configure interface xe0.
SW2(config-if)#switchport	Configure the interface as switch port.
SW2(config-if)#bridge-group 1	Configure interface in bridge group 1.
SW2(config-if)#switchport mode trunk	Configure interface mode as trunk.
SW2(config-if)#switchport trunk allowed vlan all	Allow all VLANs on interface xe1.
SW2(config-if)#commit	Commit the candidate configuration to the running configuration.
SW2(config-if)#exit	Exit config mode.

**SW3**

SW3#configure terminal	Enter configure mode.
SW3(config)#bridge 1 protocol rstp vlan-bridge	Create bridge 1 as an RSTP VLAN-aware bridge.
SW3(config)#vlan database	Entering vlan database
SW3(config-vlan)#vlan 512 bridge 1 state enable	Create VLAN 512 on bridge 1.
SW3(config-vlan)#commit	Commit the candidate configuration to the running configuration.
SW3(config-vlan)#exit	Exit vlan database
SW3(config)#int xe17	Configure interface xe17.
SW3(config-if)#switchport	Configure the interface as switch port.
SW3(config-if)#bridge-group 1	Configure interface in bridge group 1.
SW3(config-if)#switchport mode trunk	Configure interface mode as trunk.
SW3(config-if)#switchport trunk allowed vlan all	Allow all VLANs on interface xe17.
SW3(config-if)#commit	Commit the candidate configuration to the running configuration.
SW3(config-if)#exit	Exit config mode.
SW3(config)#int xe1	Configure interface xe1.
SW3(config-if)#switchport	Configure the interface as switch port.
SW3(config-if)#bridge-group 1	Configure interface in bridge group 1.
SW3(config-if)#switchport mode trunk	Configure interface mode as trunk.
SW3(config-if)#switchport trunk allowed vlan all	Allow all VLANs on interface xe1.
SW3(config-if)#commit	Commit the candidate configuration to the running configuration.
SW3(config-if)#exit	Exit config mode.

**SW4**

SW4#configure terminal	Enter configure mode.
SW4(config)#bridge 1 protocol rstp vlan-bridge	Create bridge 1 as an RSTP VLAN-aware bridge.
SW4(config)#vlan database	Entering vlan database
SW4(config-vlan)#vlan 512 bridge 1 state enable	Create VLAN 512 on bridge 1.
SW4(config-vlan)#commit	Commit the candidate configuration to the running configuration.
SW4(config-vlan)#exit	Exit vlan database
SW4(config)#int xe1	Configure interface xe1.
SW4(config-if)#switchport	Configure the interface as switch port.
SW4(config-if)#bridge-group 1	Configure interface in bridge group 1.
SW4(config-if)#switchport mode trunk	Configure interface mode as trunk.
SW4(config-if)#switchport trunk allowed vlan all	Allow all VLANs on interface xe1.
SW4(config-if)#commit	Commit the candidate configuration to the running configuration.
SW4(config-if)#exit	Exit config mode.
SW4(config)#int xe9	Configure interface xe9.
SW4(config-if)#switchport	Configure the interface as switch port.
SW4(config-if)#bridge-group 1	Configure interface in bridge group 1.
SW4(config-if)#switchport mode trunk	Configure interface mode as trunk.
SW4(config-if)#switchport trunk allowed vlan all	Allow all VLANs on interface xe9.
SW4(config-if)#commit	Commit the candidate configuration to the running configuration.
SW4(config-if)#exit	Exit config mode.

**SW5**

SW5#configure terminal	Enter configure mode.
SW5(config)#bridge 1 protocol rstp vlan-bridge	Create bridge 1 as an RSTP VLAN-aware bridge.
SW5(config)#vlan database	Entering vlan database
SW5(config-vlan)#vlan 512 bridge 1 state enable	Create VLAN 512 on bridge 1.
SW5(config-vlan)#commit	Commit the candidate configuration to the running configuration.
SW5(config-vlan)#exit	Exit vlan database
SW5(config)#int xe9	Configure interface xe9.
SW5(config-if)#switchport	Configure the interface as switch port.
SW5(config-if)#bridge-group 1	Configure interface in bridge group 1.
SW5(config-if)#switchport mode trunk	Configure interface mode as trunk.

SW5(config-if)#switchport trunk allowed vlan all	Allow all VLANs on interface xe9.
SW5(config-if)#commit	Commit the candidate configuration to the running configuration.
SW5(config-if)#exit	Exit config mode.
SW5(config)#ethernet cfm domain-type character-string domain-name mdnam level 7 mip-creation default	Create cfm domain with type as character string and set mip creation criteria to default.
SW5(config-ether-cfm)#service ma-type string ma-name testtm	Create ma type as string and set mip creation criteria to default.
SW5(config-ether-cfm)#vlan 512 bridge 1	Configure primary VLAN ID
SW5(config-ether-cfm-ma)#mip-creation default	Configure MIP creation permission
SW5(config-ether-cfm-ma)#ethernet cfm mep down mpid 1 active true xe9	Create down mep for local-vid on xe9
SW5(config-ether-cfm-ma-mep)#cc multicast state enable	Enable cc multicast.
SW5(config-ether-cfm-ma-mep)# ethernet cfm delay-measurement reply dmm	Generate and send DMM responses tacked
SW5(config-ether-cfm-ma-mep)#exit-ether-ma-mep-mode	Exit ethernet cfm ma-mep mode.
SW5(config-ether-cfm-ma)#mep crosscheck mpid 2	Configure crosscheck to remote MEP in VLAN 512.
SW5(config-ether-cfm-ma)#cc interval 10ms	Enable cc interval for 10 millisecond.
SW5(config-ether-cfm-ma)#exit-ether-ma-mode	Exit ethernet ma mode.
SW5(config-ether-cfm)#commit	Commit the candidate configuration to the running configuration.
SW5(config-ether-cfm)#exit	Exit ethernet CFM mode.

## Commands to initiate/abort on-demand delay measurement

```
delay-measurement type on-demand profile-name WORD rmep (mac-address MAC|RMEPID) start-time (immediate|relative HH:MM:SS|absolute HH:MM:SS <1-31> MONTH <1993-2035>) repetition-period <6000-4294967295> mep MEPID domain DOMAIN_NAME ma <MA_NAME>
```

```
abort delay-measurement mep <MEPID> domain <DOMAIN_NAME> ma <MA_NAME>
```

## Validation

```
SW1#ping ethernet mac 3c2c.9926.e683 unicast source 2 domain mdnam ma
```

```
SW1#traceroute ethernet 3c2c.9926.e683 mepid 2 domain mdnam ma testtm
MP Mac           Hops  Relay-action           Ingress/Egress  Ingress/Egress action
3c2c.9926.e683   1     RlyHit                 Ingress         IngOK
```

```
SW1# delay-measurement type proactive profile-name DM rmep mac-address 3c2c.9926.e683 mep 2 domain mdnam ma testtm
```

```
SW1#show ethernet cfm delay-measurement mep 2 domain mdnam ma testtm
MEP                : 2
```

## Y.1731 Performance Monitoring Configurations

---

MA : testtm  
VLAN ID : 512  
Peer MAC Address : 3c2c.9926.e683

### CURRENT:

=====  
RMEP ID : 1  
Measurement ID : 12  
Measurement Type : DMM  
Elapsed time(sec) : 24  
Start Time : 2019 Aug 06 13:23:53  
Suspect Flag : FALSE  
Min Frame Delay(usec) : 13  
Max Frame Delay(usec) : 13  
Avg Frame Delay(usec) : 13  
Min Inter FD Variation(usec) : 0  
Max Inter FD Variation(usec) : 0  
Avg Inter FD Variation(usec) : 0

#### FRAME DELAY BINS

Bin Number	Bin Threshold(usec)	Bin Counter
1	0 - < 4999	3
2	5000 - < 9999	0
3	10000 - < 14999	0
4	15000 - < Inf	0

#### INTER-FRAME DELAY BINS

Bin Number	Bin Threshold(usec)	Bin Counter
1	0 - < 4999	2
2	5000 - < 9999	0
3	10000 - < Inf	0

### HISTORY STATISTICS

=====  
MD : mdnam  
MA : testtm  
MEP : 2  
VLAN ID : 512  
RMEP ID : 1  
Measurement ID : 10  
Measurement Type : DMM  
Elapsed time(sec) : 60  
End Time : 2019 Aug 06 13:22:52  
Suspect Flag : FALSE  
Min Frame Delay(usec) : 13  
Max Frame Delay(usec) : 13  
Avg Frame Delay(usec) : 13

Min Inter FD Variation(usec): 0  
 Max Inter FD Variation(usec): 0  
 Avg Inter FD Variation(usec): 0

FRAME DELAY BINS

Bin Number	Bin Threshold(usec)	Bin Counter
1	0 - < 4999	6
2	5000 - < 9999	0
3	10000 - < 14999	0
4	15000 - < Inf	0

INTER-FRAME DELAY BINS

Bin Number	Bin Threshold(usec)	Bin Counter
1	0 - < 4999	5
2	5000 - < 9999	0
3	10000 - < Inf	0

RMEP ID : 1  
 Measurement ID : 11  
 Measurement Type : DMM  
 Elapsed time(sec) : 60  
 End Time : 2019 Aug 06 13:23:52  
 Suspect Flag : FALSE  
 Min Frame Delay(usec) : 13  
 Max Frame Delay(usec) : 13  
 Avg Frame Delay(usec) : 13  
 Min Inter FD Variation(usec): 0  
 Max Inter FD Variation(usec): 0  
 Avg Inter FD Variation(usec): 0

FRAME DELAY BINS

Bin Number	Bin Threshold(usec)	Bin Counter
1	0 - < 4999	6
2	5000 - < 9999	0
3	10000 - < 14999	0
4	15000 - < Inf	0

INTER-FRAME DELAY BINS

Bin Number	Bin Threshold(usec)	Bin Counter
1	0 - < 4999	5
2	5000 - < 9999	0
3	10000 - < Inf	0

SW1# abort delay-measurement mep 2 domain mdnam ma testtm

## Delay Measurement Message (DMM) Over VPWS

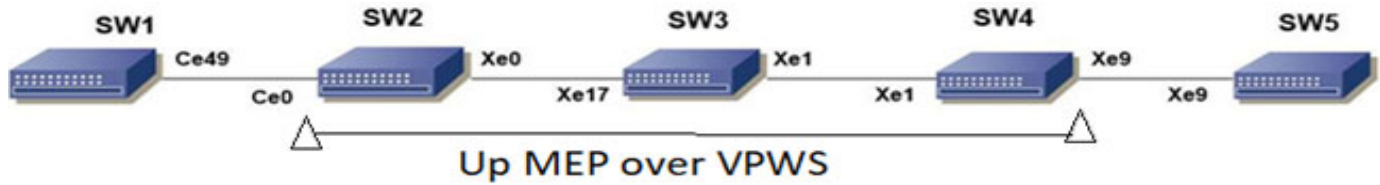

Figure 2-7: CFM Y.1731 DMM over VPWS Topology

### SW1

SW1#configure terminal	Enter configure mode.
SW1(config)#bridge 1 protocol rstp vlan-bridge	Create bridge 1 as an RSTP VLAN-aware bridge.
SW1(config)#vlan database	Entering VLAN database.
SW1(config-vlan)#vlan 512 bridge 1 state enable	Create VLAN 512 on bridge 1.
SW1(config-vlan)#commit	Commit the candidate configuration to the running configuration.
SW1(config-vlan)#exit	Exit config mode.
SW1(config)#interface ce49	Configure interface ce49.
SW1(config-if)#switchport	Configure the interface as switch port.
SW1(config-if)#bridge-group 1	Configure interface in bridge group 1.
SW1(config-if)#switchport mode trunk	Configure interface mode as trunk.
SW1(config-if)#switchport trunk allowed vlan all	Allow all VLANs on interface ce49.
SW1(config-vlan)#commit	Commit the candidate configuration to the running configuration.
SW1(config-if)#exit	Exit config mode.

### SW2

SW2#configure terminal	Enter configure mode.
SW2(config)#interface ce0	Configure interface ce0.
SW2(config-if)#switchport	Configure interface as a switch port.
SW2(config-if)#commit	Commit the candidate configuration to the running configuration.
SW2(config-if)#exit	Exit interface mode.
SW2(config)#interface xe0	Configure interface xe0.
SW2(config-if)#no switchport	Configure interface as router port.
SW2(config-if)#ip address 10.0.0.1/24	Assign IP address to router port xe0
SW2(config-if)#no shutdown	Making the interface up
SW2(config-if)#commit	Commit the candidate configuration to the running configuration.

SW2 (config-if) #exit	Exit interface mode.
SW2 (config) #interface lo	Configure interface lo
SW2 (config-if) #ip address 1.1.1.1/32 secondary	Configure secondary IP address to loopback interface.
SW2 (config-if) #commit	Commit the candidate configuration to the running configuration.
SW2 (config-if) #exit	Exit interface mode.
SW2 (config) #router ospf 100	Configure ospf
SW2 (config-router) #network 10.0.0.0/24 area 0	Advertising 10 network
SW2 (config-router) #network 1.1.1.1/32 area 0	Advertising loopback IP
SW2 (config-router) #commit	Commit the candidate configuration to the running configuration.
SW2 (config-router) #exit	Exit router mode.
SW2 (config) #router rsvp	Configuring rsvp
SW2 (config-router) #hello-receipt	Configuring hello reception
SW2 (config-router) #no php	Configuring device as not a PHP
SW2 (config-router) #revert-timer 10	Configuring reversion time of RSVP
SW2 (config-router) #commit	Commit the candidate configuration to the running configuration.
SW2 (config-router) #exit	Exit router mode.
SW2 (config) #rsvp-trunk to-1 ipv4	Configuring RSVP path
SW2 (config-trunk) #to 2.2.2.2	Configuring first hop
SW2 (config-trunk) #to 3.3.3.3	Configuring second hop
SW2 (config-trunk) #commit	Commit the candidate configuration to the running configuration.
SW2 (config-trunk) #exit	Exit trunk mode.
SW2 (config) #interface xe0	Configuring interface
SW2 (config-if) #enable-rsvp	Enabling RSVP in interface
SW2 (config-if) #label-switching	Enabling MPLS labeling
SW2 (config-if) #enable-ldp ipv4	Enabling ldp on interface
SW2 (config-if) #commit	Commit the candidate configuration to the running configuration.
SW2 (config-if) #exit	Exit interface mode.
SW2 (config) #router ldp	Configuring LDP
SW2 (config-router) #targeted-peer ipv4 3.3.3.3	Configuring LDP target peer for PW
SW2 (config-router-targeted-peer) #exit-targeted-peer-mode	Exit target peer mode
SW2 (config-router) #no multicast-hellos	Disabling LDP multicast
SW2 (config-router) #commit	Commit the candidate configuration to the running configuration.
SW2 (config-router) #exit	Exit router mode.
SW2 (config) #mpls l2-circuit ETH-2001 1 3.3.3.3	Creating VPWS PW

## Y.1731 Performance Monitoring Configurations

SW2(config-pseudowire)#commit	Commit the candidate configuration to the running configuration.
SW2(config-pseudowire)#exit	Exit pseudowire config mode.
SW2(config)#service-template ETH-2001	Configuring service template profile for PW
SW2(config-svc)#match outer-vlan 200	Configuring match condition
SW2(config-svc)#rewrite ingress push 2000	Configuring action for match
SW2(config-svc)#commit	Commit the candidate configuration to the running configuration.
SW2(config-svc)#exit	Exit service template mode
SW2(config)#interface ce0	Configuring interface
SW2(config-if)#mpls-l2-circuit ETH-2001 service-template ETH-2001	Mapping VPWS in AC
SW2(config-if)#commit	Commit the candidate configuration to the running configuration.
SW2(config-if)#exit	Exit interface mode.
SW2(config)#hardware-profile filter cfm-domain-name-str enable	Enabling HW filter for character string domain name
SW2(config)#ethernet cfm domain-type character-string domain-name 12345 level 7 mip-creation none	Configuring CFM domain over VPWS
SW2(config-ether-cfm-mpls-md)#service ma-type string ma-name 43981 mip-creation none	Creating MA for domain
SW2(config-ether-cfm-mpls-md-ma)#cc interval 100ms	Configuring CFM interval
SW2(config-ether-cfm-mpls-md-ma)#mep cross-check mpid 1	Configuring remote mep
SW2(config-ether-cfm-mpls-md-ma)#ethernet cfm mep up mpid 4001 active true vpws ETH-2001	Configuring local mep and mapping the same with vpws service
SW2(config-ether-cfm-mpls-ma-mep)#cc multicast state enable	Enabling the CFM multicast
SW2(config-ether-cfm-mpls-ma-mep)#commit	Commit the candidate configuration to the running configuration.
SW2(config-ether-cfm-mpls-ma-mep)#exit	Exit CFM MEP configuration mode
SW2(config-ether-cfm-mpls-md-ma)#exit	Exit CFM MA configuration mode
SW2(config-ether-cfm-mpls-md)#exit	End current mode and down to previous mode
SW2(config)#ethernet cfm delay-measurement profile-name DM	Configuring DM profile
SW2(config-cfm-dm)#measurement interval	Configuring measurement interval
SW2(config-cfm-dm)#intervals-stored 3	Configuring the number of history interval to be stored
SW2(config-cfm-dm)#message-period 1s	Configuring message period interval time
SW2(config-cfm-dm)#bins-per-fd-interval 4	Configuring the number of measurement bins per Measurement Interval for Frame Delay measurements.
SW2(config-cfm-dm)#bins-per-ifdv-interval 3	Configuring the number of measurement bins per Measurement Interval for Inter-Frame Delay Variation measurements.



SW2 (config-cfm-dm) #commit	Commit the candidate configuration to the running configuration.
SW2 (config-cfm-dm) #end	Exit config mode

**SW3**

SW3#configure terminal	Enter configure mode.
SW3 (config) #interface xe17	Configure interface
SW3 (config-if) #no switchport	Configure interface as router port.
SW3 (config-if) #ip address 20.0.0.1/24	Assign IP address to router port
SW3 (config-if) #no shutdown	Making the interface up
SW3 (config-if) #commit	Commit the candidate configuration to the running configuration.
SW3 (config-if) #exit	Exit interface mode.
SW3 (config) #interface xe1	Configure interface
SW3 (config-if) #no switchport	Configure interface as router port.
SW3 (config-if) #ip address 10.0.0.2/24	Assign IP address to router port
SW3 (config-if) #no shutdown	Making the interface up
SW3 (config-if) #commit	Commit the candidate configuration to the running configuration.
SW3 (config-if) #exit	Exit interface mode.
SW3 (config) #interface lo	Configure interface lo
SW3 (config-if) #ip address 2.2.2.2/32 secondary	Configure secondary IP address to loopback interface .
SW3 (config-if) #commit	Commit the candidate configuration to the running configuration.
SW3 (config-if) #exit	Exit interface mode.
SW3 (config) #router ospf 100	Configure ospf
SW3 (config-router) #network 10.0.0.0/24 area 0	Advertising 10 network
SW3 (config-router) #network 20.0.0.0/24 area 0	Advertising 10 network
SW3 (config-router) #network 2.2.2.2/32 area 0	Advertising loopback IP
SW3 (config-router) #exit	Exit router mode.
SW3 (config) #router rsvp	Configuring rsvp
SW3 (config-router) #hello-receipt	Configuring hello reception
SW3 (config-router) #no php	Configuring device as not a PHP
SW3 (config-router) #revert-timer 10	Configuring reversion time of RSVP
SW3 (config-router) #commit	Commit the candidate configuration to the running configuration.
SW3 (config-router) #exit	Exit router mode.
SW3 (config) #interface xe1	Configuring interface
SW3 (config-if) #enable-rsvp	Enabling RSVP in interface
SW3 (config-if) #label-switching	Enabling MPLS labeling

## Y.1731 Performance Monitoring Configurations

SW3(config-if)#enable-ldp ipv4	Enabling ldp on interface
SW3(config-if)#commit	Commit the candidate configuration to the running configuration.
SW3(config-if)#exit	Exit interface mode.
SW3(config)#interface xe17	Configuring interface
SW3(config-if)#enable-rsvp	Enabling RSVP in interface
SW3(config-if)#label-switching	Enabling MPLS labeling
SW3(config-if)#enable-ldp ipv4	Enabling ldp on interface
SW3(config-if)#commit	Commit the candidate configuration to the running configuration.
SW3(config-if)#exit	Exit interface mode.

### SW4

SW4#configure terminal	Enter configure mode.
SW4(config)#interface xe9	Configure interface
SW4(config-if)#switchport	Configure interface as switch port.
SW4(config-if)#commit	Commit the candidate configuration to the running configuration.
SW4(config-if)#exit	Exit interface mode.
SW4(config)#interface xe1	Configure interface
SW4(config-if)#no switchport	Configure interface as router port.
SW4(config-if)#ip address 20.0.0.2/24	Assign IP address to router port
SW4(config-if)#no shutdown	Making the interface up
SW4(config-if)#commit	Commit the candidate configuration to the running configuration.
SW4(config-if)#exit	Exit interface mode.
SW4(config)#interface lo	Configure interface lo
SW4(config-if)#ip address 3.3.3.3/32 secondary	Configure secondary IP address to loopback interface .
SW4(config-if)#commit	Commit the candidate configuration to the running configuration.
SW4(config-if)#exit	Exit interface mode.
SW4(config)#router ospf 100	Configure ospf
SW4(config-router)#network 20.0.0.0/24 area 0	Advertising 10 network
SW4(config-router)#network 3.3.3.3/32 area 0	Advertising loopback IP
SW4(config-router)#commit	Commit the candidate configuration to the running configuration.
SW4(config-router)#exit	Exit router mode.
SW4(config)#router rsvp	Configuring rsvp
SW4(config-router)#hello-receipt	Configuring hello reception
SW4(config-router)#no php	Configuring device as not a PHP
SW4(config-router)#revert-timer 10	Configuring reversion time of RSVP

SW4 (config-router) #exit	Exit router mode.
SW4 (config) #rsvp-trunk to-1 ipv4	Configuring RSVP path
SW4 (config-trunk) #to 2.2.2.2	Configuring first hop
SW4 (config-trunk) #to 1.1.1.1	Configuring second hop
SW4 (config-trunk) #commit	Commit the candidate configuration to the running configuration.
SW4 (config-trunk) #exit	Exit trunk mode.
SW4 (config) #interface xe1	Configuring interface
SW4 (config-if) #enable-rsvp	Enabling RSVP in interface
SW4 (config-if) #label-switching	Enabling MPLS labeling
SW4 (config-if) #enable-ldp ipv4	Enabling ldp on interface
SW4 (config-if) #commit	Commit the candidate configuration to the running configuration.
SW4 (config-if) #exit	Exit interface mode.
SW4 (config) #router ldp	Configuring LDP
SW4 (config-router) #targeted-peer ipv4 1.1.1.1	Configuring LDP target peer for PW
SW4 (config-router-targeted-peer) #exit-targeted-peer-mode	Exit target peer mode
SW4 (config-router) #no multicast-hellos	Disabling LDP multicast
SW4 (config-router) #commit	Commit the candidate configuration to the running configuration.
SW4 (config-router) #exit	Exit router mode.
SW4 (config) #mpls l2-circuit ETH-2001 1 1.1.1.1	Creating VPWS PW
SW4 (config-pseudowire) #commit	Commit the candidate configuration to the running configuration.
SW4 (config-pseudowire) #exit	Exit pseudowire config mode.
SW4 (config) #service-template ETH-2001	Configuring service template profile for PW
SW4 (config-svc) # match outer-vlan 200	Configuring match condition
SW4 (config-svc) # rewrite ingress push 2000	Configuring action for match
SW4 (config-svc) #commit	Commit the candidate configuration to the running configuration.
SW4 (config-svc) #exit	Exit service template mode
SW4 (config) #interface xe9	Configuring interface
SW4 (config-if) #mpls-l2-circuit ETH-2001 service-template ETH-2001	Mapping VPWS in AC
SW4 (config-if) #commit	Commit the candidate configuration to the running configuration.
SW4 (config-if) #exit	Exit interface mode.
SW4 (config) #hardware-profile filter cfm-domain-name-str enable	Enabling HW filter for character string domain name
SW4 (config) #ethernet cfm domain-type character-string domain-name 12345 level 7 mip-creation none	Configuring CFM domain over VPWS

## Y.1731 Performance Monitoring Configurations

SW4 (config-ether-cfm-mpls-md) #service ma-type string ma-name 43981	Creating MA for domain
SW4 (config-ether-cfm-ma) #mip-creation none	Configuring MIP creation permission
SW4 (config-ether-cfm-mpls-md-ma) #cc interval 100ms	Configuring CFM interval
SW4 (config-ether-cfm-mpls-md-ma) #mep cross-check mpid 4001	Configuring remote mep
SW4 (config-ether-cfm-mpls-md-ma) #ethernet cfm mep up mpid 1 active true vpws ETH-2001	Configuring local mep and mapping the same with vpws service
SW4 (config-ether-cfm-mpls-ma-mep) #cc multicast state enable	Enabling the CFM multicast
SW4 (config-ether-cfm-mpls-ma-mep) #ethernet cfm delay-measurement reply dmm	Configuring DMR
SW4 (config-ether-cfm-mpls-ma-mep) #commit	Commit the candidate configuration to the running configuration.
SW4 (config-ether-cfm-mpls-ma-mep) #end	Exit config mode

### SW5

SW5#configure terminal	Enter configure mode.
SW5 (config) #bridge 1 protocol rstp vlan-bridge	Create bridge 1 as an RSTP VLAN-aware bridge.
SW5 (config) #vlan database	Entering VLAN database.
SW5 (config-vlan) #vlan 512 bridge 1 state enable	Create VLAN 512 on bridge 1.
SW5 (config-vlan) #commit	Commit the candidate configuration to the running configuration.
SW5 (config-vlan) #exit	Exit config mode.
SW5 (config) #interface xe9	Configure interface ce49.
SW5 (config-if) #switchport	Configure the interface as switch port.
SW5 (config-if) #bridge-group 1	Configure interface in bridge group 1
SW5 (config-if) #switchport mode trunk	Configure interface mode as trunk.
SW5 (config-if) #switchport trunk allowed vlan all	Allow all VLANs on interface ce49.
SW5 (config-if) #commit	Commit the candidate configuration to the running configuration.
SW5 (config-if) #exit	Exit config mode.

### Commands to initiate/abort delay measurement

```
delay-measurement type proactive profile-name WORD rmp (mac-address MAC|mep-id MEPID) mep MEPID domain DOMAIN_NAME ma <MA_NAME>
```

```
abort delay-measurement mep MEPID domain DOMAIN_NAME ma <MA_NAME>
```

---

## Validation

```

SW2# delay-measurement type proactive profile-name DM rmeop mac-address 3c2c.9926.e683
mep 200 domain 12345
SW2# show ethernet cfm delay-measurement mep 200 domain 12345
MD : 12345
MA : 43981
MEP : 200
VLAN ID : 0
VC Name : ETH-2001
Peer MAC Address : b86a.97d2.27d0
CURRENT:
=====
RMEP ID                : 100
Measurement ID         : 3
Measurement Type       : DMM
Elapsed time(sec)      : 25
Start Time             : 2019 Nov 06 10:57:33
Suspect Flag          : TRUE
Min Frame Delay(usec)  : 37
Max Frame Delay(usec)  : 65
Avg Frame Delay(usec)  : 51
Min Inter FD Variation(usec): 13
Max Inter FD Variation(usec): 15
Avg Inter FD Variation(usec): 14
FRAME DELAY BINS
Bin Number Bin Threshold(usec) Bin Counter
=====
1 0 - < 4999 3
2 5000 - < 9999 0
3 10000 - < 14999 0
4 15000 - < Inf 0
INTER-FRAME DELAY BINS
Bin Number Bin Threshold(usec) Bin Counter
=====
1 0 - < 4999 2
2 5000 - < 9999 0
3 10000 - < Inf 0
HISTORY STATISTICS
=====
MD : 12345
MA : 43981
MEP : 200
VLAN ID : 0
VC Name : ETH-2001
RMEP ID : 100
Measurement ID : 1
Measurement Type : DMM
Elapsed time(sec) : 60
End Time : 2019 Nov 06 10:50:19
Suspect Flag : FALSE

```

## Y.1731 Performance Monitoring Configurations

---

```
Min Frame Delay(usec) : 14
Max Frame Delay(usec) : 75
Avg Frame Delay(usec) : 47
Min Inter FD Variation(usec): 53
Max Inter FD Variation(usec): 53
Avg Inter FD Variation(usec): 24
FRAME DELAY BINS
Bin Number Bin Threshold(usec) Bin Counter
=====
1 0 - < 4999 5
2 5000 - < 9999 0
3 10000 - < 14999 0
4 15000 - < Inf 0
INTER-FRAME DELAY BINS
Bin Number Bin Threshold(usec) Bin Counter
=====
1 0 - < 4999 4
2 5000 - < 9999 0
3 10000 - < Inf 0
RMEP ID : 100
Measurement ID : 2
Measurement Type : DMM
Elapsed time(sec) : 60
End Time : 2019 Nov 06 10:51:20
Suspect Flag : FALSE
Min Frame Delay(usec) : 13
Max Frame Delay(usec) : 70
Avg Frame Delay(usec) : 37
Min Inter FD Variation(usec): 52
Max Inter FD Variation(usec): 52
Avg Inter FD Variation(usec): 21
FRAME DELAY BINS
Bin Number Bin Threshold(usec) Bin Counter
=====
1 0 - < 4999 6
2 5000 - < 9999 0
3 10000 - < 14999 0
4 15000 - < Inf 0
INTER-FRAME DELAY BINS
Bin Number Bin Threshold(usec) Bin Counter
=====
1 0 - < 4999 5
2 5000 - < 9999 0
3 10000 - < Inf 0
```

```
SW1# abort delay-measurement mep 2 domain mdnam
```

## CHAPTER 3 Ethernet Linear Protection Switching Configuration

The feature Ethernet Linear Protection Switching (ELPS) adds a fast mechanism to switch from a failing Ethernet transport entity to a working Ethernet transport entity, thereby restoring node to node link up condition.

The objective of fast protection switching is achieved by integrating mature Ethernet operations, administration, and maintenance (OAM) functions and a simple automatic protection switching (APS) protocol for Ethernet linear networks. Since protection switching requires monitoring of both working and protection transport entities, it is required that MEPs be activated for the purpose of monitoring the working and protection transport entities. Both transport entities are monitored individually by exchanging Continuity Check Messages (CCMs).

ELPS protocol is optimized to provide Protection Switching between two distinct endpoints on a point to point vlan-based Ethernet network. It can be used as an alternative to spanning tree protocol (STP) for fast transiting the port status without complex computation, provisioning overhead, and excessive information exchange, to thus achieve much faster (i.e., 50ms) protection switching. With ELPS, it is much convenient for network operator to grasp the status of network (eg. Active network topology) with protection switching than with other survivability mechanisms, such as STP.

### Topology

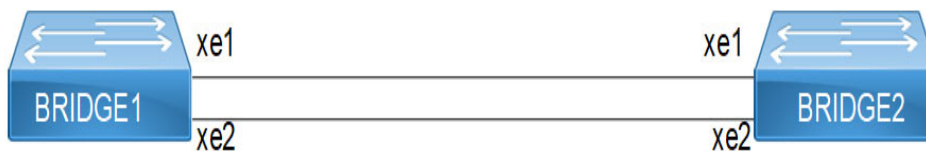

Figure 3-8: ELPS Topology

### Configuration

#### Prerequisite

Configure below hardware-profile commands related to CFM in configuration mode and reboot the nodes.

```
hardware-profile filter cfm-domain-name-str enable
hardware-profile statistics cfm-ccm enable
```

#### Bridge 1

Bridgel#configure terminal	Enter configure mode
Bridgel(config)#bridge 1 protocol rstp vlan-bridge	Create bridge 1 as an RSTP VLAN-aware bridge
Bridgel(config)#vlan 10-100 bridge 1 state enable	Create VLAN 10-100 on bridge 1
Bridgel(config)#commit	Commit transaction
Bridgel(config)#interface xe1	Configure interface xe1
Bridgel(config-if)# switchport	Configure xe1 as a layer 2 port
Bridgel(config-if)# bridge-group 1	Configure interface in bridge group 1

## Ethernet Linear Protection Switching Configuration

Bridgel(config-if)# switchport mode trunk	Configure port as trunk port
Bridgel(config-if)# switchport trunk allowed vlan add 10-100	Allow vlan 10-100 on xe1 interface
Bridgel(config)#interface xe2	Configure interface xe2
Bridgel(config-if)# switchport	Configure xe2 as a layer 2 port
Bridgel(config-if)# bridge-group 1	Configure interface in bridge group 1
Bridgel(config-if)# switchport mode trunk	Configure port as trunk port
Bridgel(config-if)# switchport trunk allowed vlan add 10-100	Allow vlan 10-100 on xe1 interface
Bridgel(config-if)#exit	Exit interface mode
Bridgel(config)#commit	Commit transaction
Bridgel(config)#ethernet cfm domain-type character-string domain-name 12345 level 5 mip-creation none	Create cfm domain with type as character string with name 12345 and set mip creation criteria to default with level 5 on bridge 1
Bridgel(config-ether-cfm)#service ma-type string ma-name 54321	Create ma type as string with name 54321
Bridgel(config-ether-cfm-ma)# vlan 10 bridge 1	Add vlan 10
Bridgel(config-ether-cfm-ma)#mip-creation none	Set mip-creation creation criteria to none
Bridgel(config-ether-cfm-ma)#ethernet cfm mep down mpid 111 active true xe1	Create down mep 111 for xe1 interface
Bridgel(config-ether-cfm-ma-mep)#cc multicast state enable	Enable cc multicast
Bridgel(config-ether-cfm-ma-mep)#exit-ether-ma-mep-mode	Exit ethernet cfm ma-mep mode
Bridgel(config-ether-cfm-ma)#mep crosscheck mpid 222	Configure crosscheck to remote MEP with value 222
Bridgel(config-ether-cfm-ma)#cc interval 3ms	Enable cc interval with 3ms
Bridgel(config-ether-cfm-ma)#exit-ether-ma-mode	Exit Ethernet ma mode
Bridgel(config-ether-cfm)#exit	Exit Ethernet cfm mode
Bridgel(config)#ethernet cfm domain-type character-string domain-name 56789 level 5 mip-creation none	Create cfm domain with type as character string with name 56789 and set mip creation criteria to default with level 5 on bridge 1
Bridgel(config-ether-cfm)#service ma-type string ma-name 98765	Create ma type as string with name 98765.
Bridgel(config-ether-cfm-ma)# vlan 10 bridge 1	Add vlan 10
Bridgel(config-ether-cfm-ma)#mip-creation none	Set mip-creation creation criteria to none
Bridgel(config-ether-cfm-ma)#ethernet cfm mep down mpid 333 active true xe2	Create down mep 333 for xe2 interface
Bridgel(config-ether-cfm-ma-mep)#cc multicast state enable	Enable cc multicast
Bridgel(config-ether-cfm-ma-mep)#exit-ether-ma-mep-mode	Exit ethernet cfm ma-mep mode



Bridge1(config-ether-cfm-ma)#mep crosscheck mpid 444	Configure crosscheck to remote MEP with value 444
Bridge1(config-ether-cfm-ma)#cc interval 3ms	Enable cc interval with 3ms
Bridge1(config-ether-cfm-ma)#exit-ether-ma-mode	Exit Ethernet ma mode
Bridge1(config-ether-cfm)#exit	Exit Ethernet cfm mode
Bridge1(config)#commit	Commit transaction
Bridge1(config)#g8031 eps-id 1 bridge 1	Create g8031 with eps-id 1 on bridge 1
Bridge1(g8031-config-switching)# working-port xe2	Associate xe2 interface as working port
Bridge1(g8031-config-switching)# protection-port xe1	Associate xe1 interface as protection port
Bridge1(g8031-config-switching)# instance 1	Create ELPS instance 1
Bridge1(g8031-config-switching)# vlan 20	Add data-vlan 20
Bridge1(g8031-config-switching)# vlan 30	Add data-vlan 30
Bridge1(g8031-config-switching)# primary-vlan 10	Associate management vlan 10
Bridge1(g8031-config-switching)# mode one-plus-one-bidirectional	Associate elps mode one-plus-one-bidirectional
Bridge1(g8031-config-switching)# revertive	Set switchover type revertive
Bridge1(g8031-config-switching)# level 5	Associate cfm to PG
Bridge1(g8031-config-switching)#exit	Exit g8031 config mode
Bridge1(config)#commit	Commit transaction
Bridge1(config)#end	Exit config terminal

## Bridge 2

Bridge2#configure terminal	Enter configure mode
Bridge2(config)#bridge 1 protocol rstp vlan-bridge	Create bridge 1 as an RSTP VLAN-aware bridge
Bridge2(config)#vlan 10-100 bridge 1 state enable	Create VLAN 10-100 on bridge 1
Bridge2(config)#commit	Commit transaction
Bridge2(config)#interface xe1	Configure interface xe1
Bridge2(config-if)# switchport	Configure xe1 as a layer 2 port
Bridge2(config-if)# bridge-group 1	Configure interface in bridge group 1
Bridge2(config-if)# switchport mode trunk	Configure port as trunk port
Bridge2(config-if)# switchport trunk allowed vlan add 10-100	Allow vlan 10-100 on xe1 interface
Bridge2(config)#interface xe2	Configure interface xe2
Bridge2(config-if)# switchport	Configure xe2 as a layer 2 port
Bridge2(config-if)# bridge-group 1	Configure interface in bridge group 1
Bridge2(config-if)# switchport mode trunk	Configure port as trunk port
Bridge2(config-if)# switchport trunk allowed vlan add 10-100	Allow vlan 10-100 on xe1 interface

## Ethernet Linear Protection Switching Configuration

Bridge2 (config-if) #exit	Exit interface mode
Bridge2 (config) #commit	Commit transaction
Bridge2 (config) #ethernet cfm domain-type character-string domain-name 12345 level 5 mip-creation none	Create cfm domain with type as character string with name 12345 and set mip creation criteria to default with level 5 on bridge 1
Bridge2 (config-ether-cfm) #service ma-type string ma-name 54321	Create ma type as string with name 54321
Bridge2 (config-ether-cfm-ma) # vlan 10 bridge 1	Add vlan 10
Bridge2 (config-ether-cfm-ma) #mip-creation none	Set mip-creation creation criteria to none
Bridge2 (config-ether-cfm-ma) #ethernet cfm mep down mpid 222 active true xe1	Create down mep 222 for xe1 interface
Bridge2 (config-ether-cfm-ma-mep) #cc multicast state enable	Enable cc multicast
Bridge2 (config-ether-cfm-ma-mep) #exit-ether-ma-mep-mode	Exit ethernet cfm ma-mep mode
Bridge2 (config-ether-cfm-ma) #mep crosscheck mpid 111	Configure crosscheck to remote MEP with value 111
Bridge2 (config-ether-cfm-ma) #cc interval 3ms	Enable cc interval with 3ms
Bridge2 (config-ether-cfm-ma) #exit-ether-ma-mode	Exit Ethernet ma mode
Bridge2 (config-ether-cfm) #exit	Exit Ethernet cfm mode
Bridge2 (config) #ethernet cfm domain-type character-string domain-name 56789 level 5 mip-creation none	Create cfm domain with type as character string with name 56789 and set mip creation criteria to default with level 5 on bridge 1
Bridge2 (config-ether-cfm) #service ma-type string ma-name 98765	Create ma type as string with name 98765.
Bridge2 (config-ether-cfm-ma) # vlan 10 bridge 1	Add vlan 10
Bridge2 (config-ether-cfm-ma) #mip-creation none	Set mip-creation creation criteria to none
Bridge2 (config-ether-cfm-ma) #ethernet cfm mep down mpid 444 active true xe2	Create down mep 444 for xe2 interface
Bridge2 (config-ether-cfm-ma-mep) #cc multicast state enable	Enable cc multicast
Bridge2 (config-ether-cfm-ma-mep) #exit-ether-ma-mep-mode	Exit ethernet cfm ma-mep mode
Bridge2 (config-ether-cfm-ma) #mep crosscheck mpid 333	Configure crosscheck to remote MEP with value 333
Bridge2 (config-ether-cfm-ma) #cc interval 3ms	Enable cc interval with 3ms
Bridge2 (config-ether-cfm-ma) #exit-ether-ma-mode	Exit Ethernet ma mode
Bridge2 (config-ether-cfm) #exit	Exit Ethernet cfm mode
Bridge2 (config) #commit	Commit transaction
Bridge2 (config) g8031 eps-id 1 bridge 1	Create g8031 with eps-id 1 on bridge 1
Bridge2 (g8031-config-switching) # working-port xe2	Associate xe2 interface as working port

Bridge2(g8031-config-switching)# protection-port xe1	Associate xe1 interface as protection port
Bridge2(g8031-config-switching)# instance 1	Create ELPS instance 1
Bridge2(g8031-config-switching)# vlan 20	Add data-vlan 20
Bridge2(g8031-config-switching)# vlan 30	Add data-vlan 30
Bridge2(g8031-config-switching)# primary-vlan 10	Associate management vlan 10
Bridge2(g8031-config-switching)# mode one-plus-one-bidirectional	Associate elps mode one-plus-one-bidirectional
Bridge2(g8031-config-switching)# revertive	Set switchover type revertive
Bridge2(g8031-config-switching)# level 5	Associate cfm to PG
Bridge2(g8031-config-switching)#exit	Exit g8031 config mode
Bridge2(config)#commit	Commit transaction
Bridge2(config)#end	Exit config terminal

## Validation

### 1. Verify ELPS on Bridge1

Bridge1#show g8031 bridge 1

```
===== Bridge:1 Eps-id:1
=====
```

Bridge	Direction	Revertive	PVID	Total-Vlans	Working-Path	Protection-Path
1+1	Bi	Yes	10	3	xe2	xe1
Active-Path	Local-Freeze	Cfm-Attached	Request-Signal	Current-State		
Working	No	Yes	Null	No Request		

dFOP State: Not in defect mode

L-APS Rx count: 30

L-APS Tx count: 33

Bridge1#

Bridge1#show g8031 eps-id 1 bridge 1

```
===== Bridge:1 Eps-id:1
=====
```

Bridge	Direction	Revertive	PVID	Total-Vlans	Working-Path	Protection-Path
1+1	Bi	Yes	10	3	xe2	xe1

## Ethernet Linear Protection Switching Configuration

---

```
Active-Path  Local-Freeze  Cfm-Attached  Request-Signal  Current-State
-----
--
Working      No                Yes           Null            No Request
```

dFOP State: Not in defect mode

### APS Statistics

```
-----
L-APS Rx count: 33
L-APS Tx count: 36
```

Bridge1#

## 2. Verify ELPS on Bridge2

Bridge2#show g8031 bridge 1

```
===== Bridge:1 Eps-id:1
=====
```

```
Bridge  Direction  Revertive  PVID  Total-Vlans  Working-Path  Protection-Path
-----
1+1     Bi             Yes       10    3             xe2           xe1
```

```
Active-Path  Local-Freeze  Cfm-Attached  Request-Signal  Current-State
-----
--
Working      No                Yes           Null            No Request
```

dFOP State: Not in defect mode

L-APS Rx count: 39

L-APS Tx count: 43

Bridge2#show g8031 eps-id 1 bridge 1

```
===== Bridge:1 Eps-id:1
=====
```

```
Bridge  Direction  Revertive  PVID  Total-Vlans  Working-Path  Protection-Path
-----
1+1     Bi             Yes       10    3             xe2           xe1
```

```
Active-Path  Local-Freeze  Cfm-Attached  Request-Signal  Current-State
-----
--
Working      No                Yes           Null            No Request
```

dFOP State: Not in defect mode

APS Statistics

-----

L-APS Rx count: 40

L-APS Tx count: 44

Bridge2#



## CHAPTER 4 G.8032 ERPS Version 2

---

G.8032 is an International Telecommunication Union (ITU) standard for ERPS. It prevents loops on a per-VLAN basis with networks that are wired in a simple ring topology. The loops are prevented by blocking traffic on either a predetermined link or a failed link.

G.8032 Version 2 provides enhancements in support of multiple ring and ladder topologies. G.8032 offers a rapid detection and recovery time if a link or node.

This guide contains topologies and examples on how to configure g8032 ERPS configuration.

---

### Topology

Figure 4-9 displays a sample Ring Protection topology on which protection switching is configured with four bridges. The Ring Protection Link (RPL) owner is the link between Bridge 3 and Bridge 4 (xe16), on which one side of the link is defined explicitly as RPL owner (Bridge 4) and RPL neighbor (Bridge 3). The rest of the bridges are explicitly configured RPL non owner to enable ERPS in the ring.

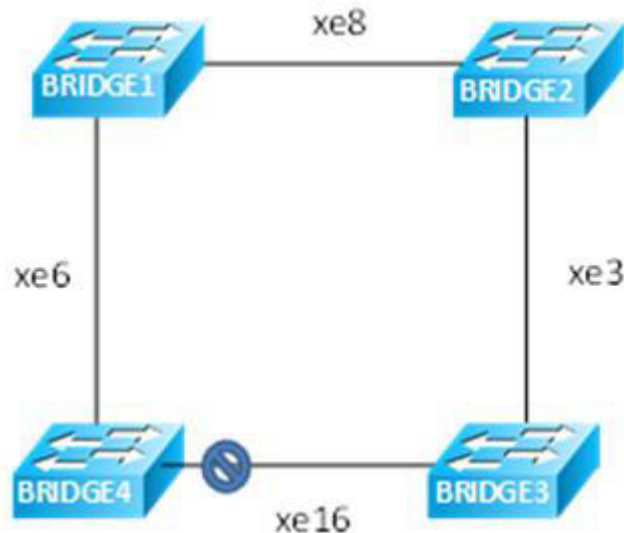

Figure 4-9: Major Ring Topology

---

### Prerequisite

Configure below hardware-profile commands related to CFM in configuration mode and reboot the nodes.

```
hardware-profile filter cfm-domain-name-str enable
hardware-profile statistics cfm-ccm enable
```

**Bridge 1**

Bridgel#configure terminal	Enter configure mode
Bridgel(config)#bridge 1 protocol rstp vlan-bridge	Create bridge 1 as an RSTP VLAN-aware bridge.
Bridgel(config)#hardware-profile filter cfm-domain-name-str enable	Enable CFM domain name as string
Bridgel(config)#vlan database	Configure VLAN database
Bridgel(config-vlan)#vlan 200-205 bridge 1 state enable	Create VLAN 200-205 on bridge 1
Bridgel(config-vlan)#interface xe6	Configure interface xe6
Bridgel(config-if)#switchport	Configure xe6 as a layer 2 port
Bridgel(config-if)#bridge-group 1	Configure interface in bridge group 1
Bridgel(config-if)#bridge-group 1 spanning-tree disable	Disable spanning tree for bridge group 1 on that interface
Bridgel(config-if)#switchport mode trunk	Configure port as trunk port
Bridgel(config-if)#switchport trunk allowed vlan add 200-205	Allow vlan 200-205 on xe6 interface
Bridgel(config-if)#interface xe8	Configure interface xe8
Bridgel(config-if)#switchport	Configure xe8 as a layer 2 port
Bridgel(config-if)#bridge-group 1	Configure interface in bridge group 1
Bridgel(config-if)#bridge-group 1 spanning-tree disable	Disable spanning tree for bridge group 1 on that interface
Bridgel(config-if)#switchport mode trunk	Configure port as trunk port
Bridgel(config-if)#switchport trunk allowed vlan add 200-205	Allow vlan 200-205 on xe8 interface
Bridgel(config-if)#ethernet cfm domain- type character-string domain-name nod12 level 7 mip-creation none	Create cfm domain with type as character string with name nod12 and set MIP creation criteria to default with level 7
Bridgel(config-ether-cfm)#service ma-type string ma-name 43982	Create MA type as string with name 43982
Bridgel(config-ether-cfm-ma)# vlan 200 bridge 1	Add VLAN 200
Bridgel(config-ether-cfm-ma)# mip-creation none	Set MIP-creation criteria to none
Bridgel(config-ether-cfm-ma)#ethernet cfm mep down mpid 12 active true xe8	Create down MEP 12 for xe8 interface
Bridgel(config-ether-cfm-ma-mep)#cc multicast state enable	Enable CC multicast
Bridgel(config-ether-cfm-ma-mep)#exit- ether-ma-mep-mode	Exit ethernet CFM MA-MEP mode



Bridgel (config-ether-cfm-ma) #mep crosscheck mpid 21	Configure crosscheck to remote MEP with value 21
Bridgel (config-ether-cfm-ma) #cc interval 100ms	Enable cc interval with 100ms
Bridgel (config-ether-cfm-ma) #exit-ether-ma-mode	Exit Ethernet ma mode
Bridgel (config-ether-cfm) #ethernet cfm domain-type character-string domain-name nod41 level 7 mip-creation none	Create cfm domain with type as character string with name nod41 and set mip creation criteria to default with level 7
Bridgel (config-ether-cfm) #service ma-type string ma-name 43982	Create MA type as string with name 43982.
Bridgel (config-ether-cfm-ma) # vlan 200 bridge 1	Add VLAN 200
Bridgel (config-ether-cfm-ma) # mip-creation none	Set MIP-creation criteria to none
Bridgel (config-ether-cfm-ma) #ethernet cfm mep down mpid 14 active true xe6	Create down MEP 14 for xe6 interface
Bridgel (config-ether-cfm-ma-mep) #cc multicast state enable	Enable CC multicast
Bridgel (config-ether-cfm-ma-mep) #exit-ether-ma-mep-mode	Exit ethernet CFM MA-MEP mode
Bridgel (config-ether-cfm-ma) #mep crosscheck mpid 41	Configure crosscheck to remote MEP with value 41
Bridgel (config-ether-cfm-ma) #cc interval 100ms	Enable CC interval with 100ms
Bridgel (config-ether-cfm-ma) #exit-ether-ma-mode	Exit Ethernet ma mode
Bridgel (config-ether-cfm) #g8032 ring RING1	Create g8032 ring with name RING1
Bridgel (g8032-ring-config) #east-interface xe6	Associate xe6 interface as east-interface
Bridgel (g8032-ring-config) #west-interface xe8	Associate xe8 interface as west-interface
Bridgel (g8032-ring-config) #g8032 profile profile1	Create g8032 profile with profile name profile1
Bridgel (g8032-profile-config) #timer wait-to-restore 1	Configure wait to restore time as 1 min
Bridgel (g8032-profile-config) #timer hold-off 0	Configure hold-off timer value as 0
Bridgel (g8032-profile-config) #timer guard-timer 10	Configure guard-timer value as 10ms
Bridgel (g8032-profile-config) #switching mode revertive	Configure Switching mode as revertive Switching mode
Bridgel (g8032-profile-config) #g8032 erp-instance erp1	Create g8032 erp instance erp1

Bridge1(g8032-config-switch)#ring RING1	Associate ring RING1 to erp1 instance
Bridge1(g8032-config-switch)#rpl role non-owner	Configure the node as non-owner node
Bridge1(g8032-config-switch)#g8032-profile profile1	Associate Profile profile1 to erp1 instance
Bridge1(g8032-config-switch)#aps-channel level 7	Configure level as 7
Bridge1(g8032-config-switch)#aps-channel vlan 200	Configure RAPS channel vlan as 200
Bridge1(g8032-config-switch)#data vlan 201-205	Configure traffic vlan from 201-205
Bridge1(g8032-config-switch)#ring-id 1	Configure ring-id as 1
Bridge1(g8032-config-switch)#commit	Commit the candidate configuration to the running configuration
Bridge1(g8032-config-switch)#end	Exit g8032 erp instance mode

## Bridge 2

Bridge2#config terminal	Enter configure mode
Bridge2(config)#bridge 1 protocol rstp vlan-bridge	Create bridge 1 as an RSTP VLAN-aware bridge.
Bridge2(config)#hardware-profile filter cfm-domain-name-str enable	Enable CFM domain name as string
Bridge2(config)#vlan database	Configure VLAN database
Bridge2(config-vlan)#vlan 200-205 bridge 1 state enable	Create VLAN 200-205 on bridge 1
Bridge2(config-vlan)#interface xe3	Configure interface xe3
Bridge2(config-if)#switchport	Configure xe3 as a layer 2 port
Bridge2(config-if)#bridge-group 1	Configure interface in bridge group 1
Bridge2(config-if)#bridge-group 1 spanning-tree disable	Disable spanning tree for bridge group 1 on that interface
Bridge2(config-if)#switchport mode trunk	Configure port as trunk port
Bridge2(config-if)#switchport trunk allowed vlan add 200-205	Allow vlan 200-205 on xe3 interface
Bridge2(config-if)#interface xe8	Configure interface xe8
Bridge2(config-if)#switchport	Configure xe8 as a layer 2 port
Bridge2(config-if)#bridge-group 1	Configure interface in bridge group 1
Bridge2(config-if)#bridge-group 1 spanning-tree disable	Disable spanning tree for bridge group 1 on that interface
Bridge2(config-if)#switchport mode trunk	Configure port as trunk port
Bridge2(config-if)#switchport trunk allowed vlan add 200-205	Allow vlan 200-205 on xe8 interface
Bridge2(config-if)#ethernet cfm domain-type character-string domain-name nod23 level 7 mip-creation none	Create cfm domain with type as character string with name nod23 and set mip creation criteria to default with level 7

Bridge2(config-ether-cfm)#service ma-type string ma-name 43982	Create MA type as string with name 43982.
Bridge2(config-ether-cfm-ma)# vlan 200 bridge 1	Add VLAN 200
Bridge2(config-ether-cfm-ma)# mip-creation none	Set MIP-creation criteria to none
Bridge2(config-ether-cfm-ma)#ethernet cfm mep down mpid 23 active true local-vid 200 xe3	Create down MEP 23 with local VID 200 for xe3 interface
Bridge2(config-ether-cfm-ma-mep)#cc multicast state enable	Enable CC multicast
Bridge2(config-ether-cfm-ma-mep)#exit-ether-ma-mep-mode	Exit ethernet CFM MA-MEP mode
Bridge2(config-ether-cfm-ma)#mep crosscheck mpid 32	Configure crosscheck to remote MEP with value 32
Bridge2(config-ether-cfm-ma)#cc interval 100ms	Enable CC interval with 100ms
Bridge2(config-ether-cfm-ma)#exit-ether-ma-mode	Exit Ethernet MA mode
Bridge2(config-ether-cfm)#ethernet cfm domain-type character-string domain-name nod12 level 7 mip-creation none	Create CFM domain with type as character string with name nod12 and set mip creation criteria to default with level 7
Bridge2(config-ether-cfm)#service ma-type string ma-name 43982	Create MA type as string with name 43982.
Bridge2(config-ether-cfm-ma)# vlan 200 bridge 1	Add VLAN 200
Bridge2(config-ether-cfm-ma)# mip-creation none	Set MIP-creation criteria to none
Bridge2(config-ether-cfm-ma)#ethernet cfm mep down mpid 21 active true xe8	Create down MEP 21 for xe8 interface
Bridge2(config-ether-cfm-ma-mep)#cc multicast state enable	Enable CC multicast
Bridge2(config-ether-cfm-ma-mep)#exit-ether-ma-mep-mode	Exit ethernet CFM MA-MEP mode
Bridge2(config-ether-cfm-ma)#mep crosscheck mpid 12	Configure crosscheck to remote MEP with value 12
Bridge2(config-ether-cfm-ma)#cc interval 100ms	Enable CC interval with 100ms
Bridge2(config-ether-cfm-ma)#exit-ether-ma-mode	Exit Ethernet MA mode
Bridge2(config-ether-cfm)#g8032 ring RING1	Create g8032 ring with name RING1
Bridge2(g8032-ring-config)#east-interface xe8	Associate xe8 interface as east-interface
Bridge2(g8032-ring-config)#west-interface xe3	Associate xe3 interface as west-interface
Bridge2(g8032-ring-config)#g8032 profile profile1	Create g8032 profile with profile name profile1
Bridge2(g8032-profile-config)#timer wait-to-restore 1	Configure wait to restore time as 1 min

Bridge2(g8032-profile-config)#timer hold-off 0	Configure hold-off timer value as 0
Bridge2(g8032-profile-config)#timer guard-timer 10	Configure guard-timer value as 10ms
Bridge2(g8032-profile-config)#switching mode revertive	Configure Switching mode as revertive Switching mode
Bridge2(g8032-profile-config)#g8032 erp-instance erp1	Create g8032 erp instance erp1
Bridge2(g8032-config-switch)#ring RING1	Associate ring RING1 to erp1 instance
Bridge2(g8032-config-switch)#rpl role non-owner	Configure the node as non-owner node
Bridge2(g8032-config-switch)#g8032-profile profile1	Associate Profile profile1 to erp1 instance
Bridge2(g8032-config-switch)#aps-channel level 7	Configure level as 7
Bridge2(g8032-config-switch)#aps-channel vlan 200	Configure RAPS channel vlan as 200
Bridge2(g8032-config-switch)#data vlan 201-205	Configure traffic vlan from 201-205
Bridge2(g8032-config-switch)#ring-id 1	Configure ring-id as 1
Bridge2(g8032-config-switch)#commit	Commit the candidate configuration to the running configuration
Bridge2(g8032-config-switch)#end	Exit g8032 erp instance mode

### Bridge 3

Bridge3#config terminal	Enter configure mode
Bridge3(config)#bridge 1 protocol rstp vlan-bridge	Create bridge 1 as an RSTP VLAN-aware bridge.
Bridge3(config)#hardware-profile filter cfm-domain-name-str enable	Enable CFM domain name as string
Bridge3(config)#vlan database	Configure VLAN database
Bridge3(config-vlan)#vlan 200-205 bridge 1 state enable	Create VLAN 200-205 on bridge 1
Bridge3(config-vlan)#interface xe3	Configure interface xe3
Bridge3(config-if)#switchport	Configure xe3 as a layer 2 port
Bridge3(config-if)#bridge-group 1	Configure interface in bridge group 1
Bridge3(config-if)#bridge-group 1 spanning-tree disable	Disable spanning tree for bridge group 1 on that interface
Bridge3(config-if)#switchport mode trunk	Configure port as trunk port
Bridge3(config-if)#switchport trunk allowed vlan add 200-205	Allow vlan 200-205 on xe3 interface
Bridge3(config-if)#interface xe16	Configure interface xe16
Bridge3(config-if)#switchport	Configure xe16 as a layer 2 port
Bridge3(config-if)#bridge-group 1	Configure interface in bridge group 1

Bridge3(config-if)#bridge-group 1 spanning-tree disable	Disable spanning tree for bridge group 1 on that interface
Bridge3(config-if)#switchport mode trunk	Configure port as trunk port
Bridge3(config-if)#switchport trunk allowed vlan add 200-205	Allow vlan 200-205 on xe16 interface
Bridge3(config-if)#ethernet cfm domain-type character-string domain-name nod23 level 7 mip-creation none	Create cfm domain with type as character string with name nod23 and set mip creation criteria to default with level 7
Bridge3(config-ether-cfm)#service ma-type string ma-name 43982	Create MA type as string with name 43982.
Bridge3(config-ether-cfm-ma)# vlan 200 bridge 1	Add VLAN 200
Bridge3(config-ether-cfm-ma)# mip-creation none	Set mip-creation criteria to none
Bridge3(config-ether-cfm-ma)#ethernet cfm mep down mpid 32 active true xe3	Create down MEP 32 for xe3 interface
Bridge3(config-ether-cfm-ma-mep)#cc multicast state enable	Enable CC multicast
Bridge3(config-ether-cfm-ma-mep)#exit-ether-ma-mep-mode	Exit ethernet CFM MA-MEP mode
Bridge3(config-ether-cfm-ma)#mep crosscheck mpid 23	Configure crosscheck to remote MEP with value 23
Bridge3(config-ether-cfm-ma)#cc interval 100ms	Enable CC interval with 100ms
Bridge3(config-ether-cfm-ma)#exit-ether-ma-mode	Exit Ethernet ma mode
Bridge3(config-ether-cfm)#ethernet cfm domain-type character-string domain-name nod34 level 7 mip-creation none	Create cfm domain with type as character string with name nod34 and set mip creation criteria to default with level 7
Bridge3(config-ether-cfm)#service ma-type string ma-name 43982	Create MA type as string with name 43982.
Bridge3(config-ether-cfm-ma)# vlan 200 bridge 1	Add VLAN 200
Bridge3(config-ether-cfm-ma)# mip-creation none	Set MIP-creation criteria to none
Bridge3(config-ether-cfm-ma)#ethernet cfm mep down mpid 34 active true xe16	Create down MEP 34 for xe16 interface
Bridge3(config-ether-cfm-ma-mep)#cc multicast state enable	Enable CC multicast
Bridge3(config-ether-cfm-ma-mep)#exit-ether-ma-mep-mode	Exit ethernet CFM MA-MEP mode
Bridge3(config-ether-cfm-ma)#mep crosscheck mpid 43	Configure crosscheck to remote MEP with value 43
Bridge3(config-ether-cfm-ma)#cc interval 100ms	Enable CC interval with 100ms
Bridge3(config-ether-cfm-ma)#exit-ether-ma-mode	Exit Ethernet MA mode
Bridge3(config-ether-cfm)#g8032 ring RING1	Create g8032 ring with name RING1
Bridge3(g8032-ring-config)#east-interface xe3	Associate xe3 interface as east-interface

Bridge3(g8032-ring-config)#west-interface xe16	Associate xe16 interface as west-interface
Bridge3(g8032-ring-config)#g8032 profile profile1	Create g8032 profile with profile name profile1
Bridge3(g8032-profile-config)#timer wait-to-restore 1	Configure wait to restore time as 1 min
Bridge3(g8032-profile-config)#timer hold-off 0	Configure hold-off timer value as 0
Bridge3(g8032-profile-config)#timer guard-timer 10	Configure guard-timer value as 10ms
Bridge3(g8032-profile-config)#switching mode revertive	Configure Switching mode as revertive Switching mode
Bridge3(g8032-profile-config)#g8032 erp-instance erp1	Create g8032 erp instance erp1
Bridge3(g8032-config-switch)#ring RING1	Associate ring RING1 to erp1 instance
Bridge3(g8032-config-switch)#rpl role neighbor west-interface	Configure RPL node as neighbor node on west-interface
Bridge3(g8032-config-switch)#g8032-profile profile1	Associate profile profile1 to erp1 instance
Bridge3(g8032-config-switch)#aps-chanel level 7	Configure level as 7
Bridge3(g8032-config-switch)#aps-channel vlan 200	Configure RAPS channel vlan as 200
Bridge3(g8032-config-switch)#data vlan 201-205	Configure traffic vlan from 201-205
Bridge3(g8032-config-switch)#ring-id 1	Configure ring-id as 1
Bridge3(g8032-config-switch)#commit	Commit the candidate configuration to the running configuration
Bridge3(g8032-config-switch)#end	Exit g8032 erp instance mode

## Bridge 4

Bridge4#config term	Enter configure mode
Bridge4(config)#bridge 1 protocol rstp vlan-bridge	Create bridge 1 as an RSTP VLAN-aware bridge.
Bridge4(config)#hardware-profile filter cfm-domain-name-str enable	Enable CFM domain name as string
Bridge4(config)#vlan database	Configure VLAN database
Bridge4(config-vlan)#vlan 200-205 bridge 1 state enable	Create VLAN 200-205 on bridge 1
Bridge4(config-vlan)#interface xe6	Configure interface xe6
Bridge4(config-if)#switchport	Configure xe6 as a layer 2 port
Bridge4(config-if)#bridge-group 1	Configure interface in bridge group 1
Bridge4(config-if)#bridge-group 1 spanning-tree disable	Disable spanning tree for bridge group 1 on that interface
Bridge4(config-if)#switchport mode trunk	Configure port as trunk port

Bridge4(config-if)#switchport trunk allowed vlan add 200-205	Allow vlan 200-205 on xe6 interface
Bridge4(config-if)#interface xe16	Configure interface xe16
Bridge4(config-if)#switchport	Configure xe16 as a layer 2 port
Bridge4(config-if)#bridge-group 1	Configure interface in bridge group 1
Bridge4(config-if)#bridge-group 1 spanning-tree disable	Disable spanning tree for bridge group 1 on that interface
Bridge4(config-if)#switchport mode trunk	Configure port as trunk port
Bridge4(config-if)#switchport trunk allowed vlan add 200-205	Allow vlan 200-205 on xe16 interface
Bridge4(config-if)#ethernet cfm domain-type character-string domain-name nod34 level 7 mip-creation none	Create cfm domain with type as character string with name nod34 and set mip creation criteria to default with level 7
Bridge4(config-ether-cfm)#service ma-type string ma-name 43982	Create ma type as string with name 43982
Bridge4(config-ether-cfm-ma)# vlan 200 bridge 1	Add VLAN 200
Bridge4(config-ether-cfm-ma)# mip-creation none	Set mip-creation criteria to none
Bridge4(config-ether-cfm-ma)#ethernet cfm mep down mpid 43 active true xe16	Create down MEP 43 for xe16 interface
Bridge4(config-ether-cfm-ma-mep)#cc multicast state enable	Enable CC multicast
Bridge4(config-ether-cfm-ma-mep)#exit-ether-ma-mep-mode	Exit ethernet CFM MA-MEP mode
Bridge4(config-ether-cfm-ma)#mep crosscheck mpid 34	Configure crosscheck to remote MEP with value 34
Bridge4(config-ether-cfm-ma)#cc interval 100ms	Enable CC interval with 100ms
Bridge4(config-ether-cfm-ma)#exit-ether-ma-mode	Exit Ethernet MA mode
Bridge4(config-ether-cfm)#ethernet cfm domain-type character-string domain-name nod41 level 7 mip-creation none	Create CFM domain with type as character string with name nod41 and set mip creation criteria to default with level 7
Bridge4(config-ether-cfm)#service ma-type string ma-name 43982	Create MA type as string with name 43982.
Bridge4(config-ether-cfm-ma)# vlan 200 bridge 1	Add VLAN 200
Bridge4(config-ether-cfm-ma)# mip-creation none	Set MIP-creation criteria to none
Bridge4(config-ether-cfm-ma)#ethernet cfm mep down mpid 41 active true xe6	Create down MEP 41 for xe6 interface
Bridge4(config-ether-cfm-ma-mep)#cc multicast state enable	Enable CC multicast
Bridge4(config-ether-cfm-ma-mep)#exit-ether-ma-mep-mode	Exit ethernet CFM MA-MEP mode
Bridge4(config-ether-cfm-ma)#mep crosscheck mpid 14	Configure crosscheck to remote MEP with value 14
Bridge4(config-ether-cfm-ma)#cc interval 100ms	Enable CC interval with 100ms

Bridge4 (config-ether-cfm-ma) #exit-ether-ma-mode	Exit Ethernet ma mode
Bridge4 (config-ether-cfm) #g8032 ring RING1	Create g8032 physical ring with name RING1
Bridge4 (g8032-ring-config) #east-interface xe16	Associate xe16 interface as east-interface
Bridge4 (g8032-ring-config) #west-interface xe6	Associate xe6 interface as west-interface
Bridge4 (g8032-ring-config) #g8032 profile profile1	Create g8032 profile with profile name profile1
Bridge4 (g8032-profile-config) #timer wait-to-restore 1	Configure wait to restore time as 1 min
Bridge4 (g8032-profile-config) #timer hold-off 0	Configure hold-off timer value as 0
Bridge4 (g8032-profile-config) #timer guard-timer 10	Configure guard-timer value as 10ms
Bridge4 (g8032-profile-config) #switching mode revertive	Configure Switching mode as revertive Switching mode
Bridge4 (g8032-profile-config) #g8032 erp-instance erp1	Create g8032 erp instance erp1
Bridge4 (g8032-config-switch) #ring RING1	Associate ring RING1 to erp1 instance
Bridge4 (g8032-config-switch) #rpl role owner east-interface	Configure the node as owner node on east-interface
Bridge4 (g8032-config-switch) #g8032-profile profile1	Associate Profile profile1 to erp1 instance
Bridge4 (g8032-config-switch) #aps-channel level 7	Configure level as 7
Bridge4 (g8032-config-switch) #aps-channel vlan 200	Configure RAPS channel vlan as 200
Bridge4 (g8032-config-switch) #data vlan 201-205	Configure traffic vlan from 201-205
Bridge4 (g8032-config-switch) #ring-id 1	Configure ring-id as 1
Bridge4 (g8032-config-switch) #commit	Commit the candidate configuration to the running configuration
Bridge4 (g8032-config-switch) #end	Exit g8032 erp instance mode

## Validation

```
Bridge1:
show g8032 aps-statistics erp1
```

```
Instance      : erp1
=====
Tx           : 3205
Rx           : 27
```

```
show g8032 ring RING1
```

```
Ring          : RING1
=====
```



```

Description   :
East          : xe16
West         : xe6
ERP Inst     : erp1

```

```
show g8032 profile profile1
```

```
Profile : profile1
```

```
=====
```

```

Wait-To-Restore : 1 mins
Hold Off Timer  : 0.00 secs
Guard Timer     : 10 ms
Wait-To-Block   : 5010 ms
Protection Type : Revertive

```

```
Bridge1:
```

```
show g8032 erp-instance erp1
```

```

Inst Name      : erp7
Description    :
State         : G8032_ST_IDLE
Phy Ring      : RING1
Ring Type     : MAJOR-RING
Role          : NON-OWNER
Node ID       : 3c:2c:99:26:e6:80

```

```

-----
                        East Link                West Link
=====
Interface         : xe6                          xe8
State             : Unblocked                    Unblocked
Remote NodeId    : 34:17:eb:e4:af:11             -
Remote BPR       : 1                             -
Endpoint Info
-----
Domain Name      : nod41                          nod12
MEP ID           : 14                             12
MA Name          : 43982                          43982
=====

```

```

-----
Channel          |
(LABEL, VLAN, RING ID) |
=====
(7, 200, 1)      |
=====

```

```
DataTraffic vlan: 201-205
```

```
Profile : profile1
```

```
Bridge2:
```

```
show g8032 erp-instance erp1
```

```

Inst Name      : erp1
Description    :
State         : G8032_ST_IDLE
Phy Ring      : RING1
Ring Type     : MAJOR-RING
Role          : NON-OWNER

```

Node ID : d8:9e:f3:5e:f8:29

```

-----
                        East Link                West Link
=====
Interface       : xe8                          xe3
State           : Unblocked                    Unblocked
Remote NodeId   : 34:17:eb:e4:af:11           -
Remote BPR      : 1                            -
Endpoint Info
-----
Domain Name     : nod12                        nod23
MEP ID          : 21                          23
MA Name         : 43982                       43982
=====

```

```

-----
Channel         |
(LLEVEL, VLAN, RING ID) |
=====
(7, 200, 1)    |
=====

```

DataTraffic vlan: 201-205  
Profile : profile1

```

sBridge3:
show g8032 erp-instance erp1
Inst Name      : erp1
Description    :
State         : G8032_ST_IDLE
Phy Ring      : RING1
Ring Type     : MAJOR-RING
Role          : NEIGHBOR (WEST)
Node ID       : 3c:2c:99:1a:da:7d

```

```

-----
                        East Link                West Link
=====
Interface       : xe3                          xe16
State           : Unblocked                    Blocked
Remote NodeId   : 34:17:eb:e4:af:11           34:17:eb:e4:af:11
Remote BPR      : 1                            1
Endpoint Info
-----
Domain Name     : nod23                        nod34
MEP ID          : 32                          34
MA Name         : 43982                       43982
=====

```

```

-----
Channel         |
(LLEVEL, VLAN, RING ID) |
=====
(7, 200, 1)    |
=====

```

DataTraffic vlan: 201-205  
Profile : profile1

Bridge4:

```
show g8032 erp-instance erp1
```

```
Inst Name       : erp1
Description     :
State          : G8032_ST_IDLE
Phy Ring       : RING1
Ring Type      : MAJOR-RING
Role           : OWNER (EAST)
Node ID        : 34:17:eb:e4:af:11
```

```
-----
                        East Link          West Link
=====
Interface       : xe16                    xe6
State           : Blocked                 Unblocked
Remote NodeId   : -                      -
Remote BPR      : -                      -
Endpoint Info
-----
Domain Name     : nod34                   nod41
MEP ID         : 43                      41
MA Name        : 43982                   43982
=====
-----
Channel         |
(LABEL, VLAN, RING ID) |
=====
(7, 200, 1)    |
=====
```

```
DataTraffic vlan: 201-205
Profile : profile1
```

---

## Sub-ring with Virtual Channel

An ethernet ring that is connected to a Major Ring at the Interconnection Nodes. By itself, the Sub-Ring does not constitute a closed ring. A Sub-Ring is connected to the Interconnection nodes on only one port which is configured as east-interface.

---

### Topology

[Figure 4-10](#) displays a sample Ring Protection topology on which protection switching is configured with six bridges. This constitutes of one major ring (Bridge2, Bridge3, Bridge4 and Bridge 5) and one sub-ring (Bridge2, Bridge1, Bridge6 and Bridge5).

Major ring's RPL is enabled between Bridge 3(owner node) and Bridge 4(neighbor node) on xe4 and other devices are non-owner nodes for that ring. Sub-ring's RPL is enabled between bridge 1(owner node) and bridge 2 (neighbor node) on link xe2 and other devices on the non-owner nodes. Bridge 2 and Bridge 5 are called interconnected nodes since they are common node between major ring and subring. Virtual channel is enabled for this Subring on interconnected nodes on vlan 100 and tcnp propagation is enabled.

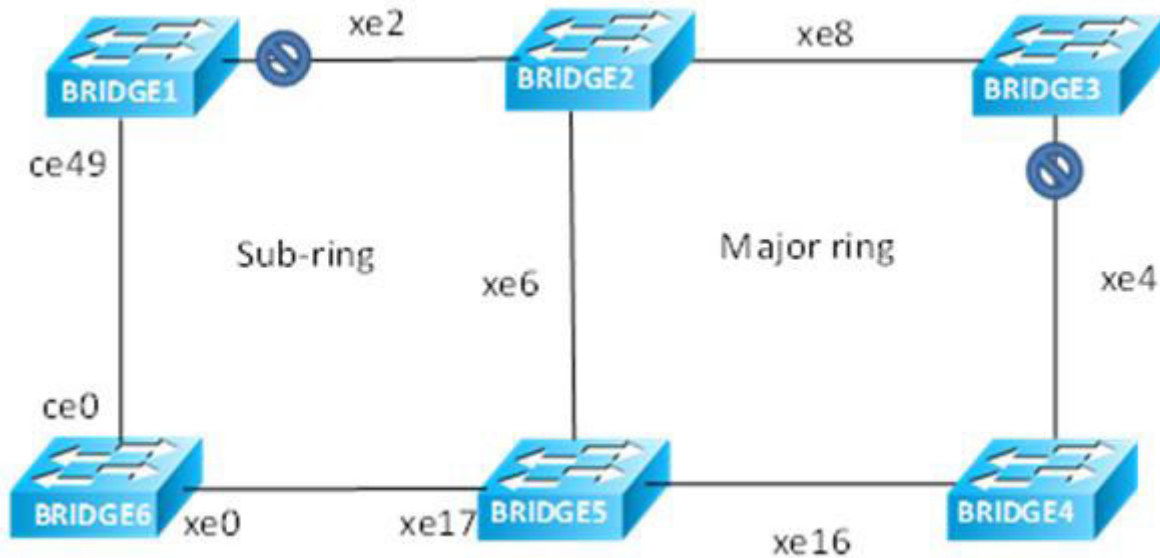

Figure 4-10: Major ring and Sub-ring with Virtual Channel Topology

## Configuration

### Bridge 1

Bridg1#config term	Enter configure mode
Bridg1(config)#bridge 1 protocol rstp vlan-bridge	Create bridge 1 as an RSTP VLAN-aware bridge.
Bridg1(config)#vlan database	Configure VLAN database
Bridg1(config-vlan)#vlan 200-205 bridge 1 state enable	Create VLAN 200-205 on bridge 1
Bridg1(config)#interface ce49	Configure interface ce49
Bridg1(config-if)#switchport	Configure ce49 as a layer 2 port
Bridg1(config-if)#bridge-group 1	Configure interface in bridge group 1
Bridg1(config-if)#bridge-group 1 spanning- tree disable	Disable spanning tree for bridge group 1 on that interface
Bridg1(config-if)#switchport mode trunk	Configure port as trunk port
Bridg1(config-if)#switchport trunk allowed vlan add 200-205	Allow vlan 200-205 on ce49 interface
Bridg1(config-if)#interface xe2	Configure interface xe2
Bridg1(config-if)#switchport	Configure xe2 as a layer 2 port
Bridg1(config-if)#bridge-group 1	Configure interface in bridge group 1
Bridg1(config-if)#bridge-group 1 spanning- tree disable	Disable spanning tree for bridge group 1 on that interface
Bridg1(config-if)#switchport mode trunk	Configure port as trunk port
Bridg1(config-if)#switchport trunk allowed vlan add 200-205	Allow vlan 200-205 on xe2 interface

Bridgel (config-if) #ethernet cfm domain-type character-string domain-name 00061 level 7 mip-creation none	Create cfm domain with type as character string with name 00061 and set mip creation criteria to default with level 7
Bridgel (config-ether-cfm) #service ma-type string ma-name 43982	Create ma type as string with name 43982.
Bridgel (config-ether-cfm-ma) # vlan 201 bridge 1	Add VLAN 201
Bridgel (config-ether-cfm-ma) # mip-creation none	Set MIP-creation criteria to none
Bridgel (config-ether-cfm-ma) #ethernet cfm mep down mpid 16 active true ce49	Create down MEP 16 for ce49 interface
Bridgel (config-ether-cfm-ma-mep) #cc multicast state enable	Enable CC multicast
Bridgel (config-ether-cfm-ma-mep) #exit-ether-ma-mep-mode	Exit ethernet CFM MA-MEP mode
Bridgel (config-ether-cfm-ma) #mep crosscheck mpid 61	Configure crosscheck to remote MEP with value 61
Bridgel (config-ether-cfm-ma) #cc interval 100ms	Enable CC interval with 100ms
Bridgel (config-ether-cfm-ma) #exit-ether-ma-mode	Exit Ethernet MA mode
Bridgel (config-ether-cfm) #ethernet cfm domain-type character-string domain-name 00012 level 7 mip-creation none	Create CFM domain with type as character string with name 00012 and set mip creation criteria to default with level 7
Bridgel (config-ether-cfm) #service ma-type string ma-name 43982	Create MA type as string with name 43982
Bridgel (config-ether-cfm-ma) # vlan 201 bridge 1	Add VLAN 201
Bridgel (config-ether-cfm-ma) # mip-creation none	Set MIP-creation criteria to none
Bridgel (config-ether-cfm-ma) #ethernet cfm mep down mpid 12 active true xe2	Create down MEP 12 for xe2 interface
Bridgel (config-ether-cfm-ma-mep) #cc multicast state enable	Enable CC multicast
Bridgel (config-ether-cfm-ma-mep) #exit-ether-ma-mep-mode	Exit ethernet CFM MA-MEP mode
Bridgel (config-ether-cfm-ma) #mep crosscheck mpid 21	Configure crosscheck to remote MEP with value 21
Bridgel (config-ether-cfm-ma) #cc interval 100ms	Enable CC interval with 100ms
Bridgel (config-ether-cfm-ma) #exit-ether-ma-mode	Exit Ethernet ma mode
Bridgel (config-ether-cfm) #g8032 ring subring	Create g8032 ring with name subring
Bridgel (g8032-ring-config) #east-interface ce49	Associate ce49 interface as east-interface
Bridgel (g8032-ring-config) #west-interface xe2	Associate xe2 interface as west-interface
Bridgel (g8032-ring-config) #g8032 profile profile1	Create g8032 profile with profile name profile1

Bridgel (g8032-profile-config) #timer wait-to-restore 1	Configure wait to restore time as 1 min
Bridgel (g8032-profile-config) #timer hold-off 0	Configure hold-off timer value as 0
Bridgel (g8032-profile-config) #timer guard-timer 10	Configure guard-timer value as 10ms
Bridgel (g8032-profile-config) #switching mode revertive	Configure Switching mode as revertive Switching mode
Bridgel (g8032-profile-config) #g8032 erp-instance erp2	Create g8032 erp instance erp2
Bridgel (g8032-config-switch) #ring-type subring-vc	Configure ring type as subring virtual channel
Bridgel (g8032-config-switch) #ring subring	Associate ring subring to erp2 instance
Bridgel (g8032-config-switch) #rpl role owner west-interface	Configure the node as owner node on west-interface
Bridgel (g8032-config-switch) #g8032-profile profile1	Associate Profile profile1 to erp2 instance
Bridgel (g8032-config-switch) #aps-channel level 7	Configure level as 7
Bridgel (g8032-config-switch) #aps-channel vlan 201	Configure RAPS channel vlan as 201
Bridgel (g8032-config-switch) #data vlan 202-205	Configure traffic vlan from 202-205
Bridgel (g8032-config-switch) #ring-id 1	Configure ring-id as 1
Bridgel (g8032-config-switch) #commit	Commit the candidate configuration to the running configuration
Bridgel (g8032-config-switch) #end	Exit g8032 erp instance mode

## Bridge 2

Bridge2#config term	Enter configure mode
Bridge2 (config) #bridge 1 protocol rstp vlan-bridge	Create bridge 1 as an RSTP VLAN-aware bridge.
Bridgel (config) #vlan database	Configure VLAN database
Bridge2 (config-vlan) #vlan 100 bridge 1 state enable	Create VLAN 100 on bridge 1
Bridge2 (config-vlan) #vlan 200-205 bridge 1 state enable	Create VLAN 200-205 on bridge 1
Bridge2 (config) #interface xe2	Configure interface xe2
Bridge2 (config-if) #switchport	Configure xe2 as a layer 2 port
Bridge2 (config-if) #bridge-group 1	Configure interface in bridge group 1
Bridge2 (config-if) #bridge-group 1 spanning-tree disable	Disable spanning tree for bridge group 1 on that interface
Bridge2 (config-if) #switchport mode trunk	Configure port as trunk port
Bridge2 (config-if) #switchport trunk allowed vlan add 100,200-205	Allow vlan 100,200-205 on xe2 interface
Bridge2 (config-if) #interface xe6	Configure interface xe6

Bridge2(config-if)#switchport	Configure xe6 as a layer 2 port
Bridge2(config-if)#bridge-group 1	Configure interface in bridge group 1
Bridge2(config-if)#bridge-group 1 spanning-tree disable	Disable spanning tree for bridge group 1 on that interface
Bridge2(config-if)#switchport mode trunk	Configure port as trunk port
Bridge2(config-if)#switchport trunk allowed vlan add 100,200-205	Allow vlan 100,200-205 on xe6 interface
Bridge2(config-if)#interface xe8	Configure interface xe8
Bridge2(config-if)#switchport	Configure xe8 as a layer 2 port
Bridge2(config-if)#bridge-group 1	Configure interface in bridge group 1
Bridge2(config-if)#bridge-group 1 spanning-tree disable	Disable spanning tree for bridge group 1 on that interface
Bridge2(config-if)#switchport mode trunk	Configure port as trunk port
Bridge2(config-if)#switchport trunk allowed vlan add 100,200-205	Allow vlan 100,200-205 on xe8 interface
Bridge2(config-if)#ethernet cfm domain-type character-string domain-name 00012 level 7 mip-creation none	Create cfm domain with type as character string with name 00012 and set mip creation criteria to default with level 7
Bridge2(config-ether-cfm)#service ma-type string ma-name 43982	Create ma type as string with name 43982
Bridge2(config-ether-cfm-ma)# vlan 201 bridge 1	Add VLAN 201
Bridge2(config-ether-cfm-ma)# mip-creation none	Set mip-creation criteria to none
Bridge2(config-ether-cfm-ma)#ethernet cfm mep down mpid 21 active true xe2	Create down MEP 21 for xe2 interface
Bridge2(config-ether-cfm-ma-mep)#cc multicast state enable	Enable CC multicast
Bridge2(config-ether-cfm-ma-mep)#exit-ether-ma-mep-mode	Exit ethernet CFM MA-MEP mode
Bridge2(config-ether-cfm-ma)#mep crosscheck mpid 12	Configure crosscheck to remote MEP with value 12
Bridge2(config-ether-cfm-ma)#cc interval 100ms	Enable CC interval with 100ms
Bridge2(config-ether-cfm-ma)#exit-ether-ma-mode	Exit Ethernet ma mode
Bridge2(config-ether-cfm)#ethernet cfm domain-type character-string domain-name 00052 level 7 mip-creation none	Create cfm domain with type as character string with name 00052 and set mip creation criteria to default with level 7
Bridge2(config-ether-cfm)#service ma-type string ma-name 43982	Create ma type as string with name 43982
Bridge2(config-ether-cfm-ma)# vlan 200 bridge 1	Add VLAN 200
Bridge2(config-ether-cfm-ma)# mip-creation none	Set MIP-creation criteria to none
Bridge2(config-ether-cfm-ma)#ethernet cfm mep down mpid 25 active true xe6	Create down MEP 25 for xe6 interface
Bridge2(config-ether-cfm-ma-mep)#cc multicast state enable	Enable CC multicast

Bridge2 (config-ether-cfm-ma-mep) #exit-ether-ma-mep-mode	Exit ethernet CFM MA-MEP mode
Bridge2 (config-ether-cfm-ma) #mep crosscheck mpid 52	Configure crosscheck to remote MEP with value 52
Bridge2 (config-ether-cfm-ma) #cc interval 100ms	Enable CC interval with 100ms
Bridge2 (config-ether-cfm-ma) #exit-ether-ma-mode	Exit Ethernet ma mode
Bridge2 (config-ether-cfm) #ethernet cfm domain-type character-string domain-name 00023 level 7 mip-creation none	Create CFM domain with type as character string with name 00023 and set mip creation criteria to default with level 7
Bridge2 (config-ether-cfm) #service ma-type string ma-name 43982	Create MA type as string with name 43982
Bridge2 (config-ether-cfm-ma) # vlan 200 bridge 1	Add VLAN 200
Bridge2 (config-ether-cfm-ma) # mip-creation none	Set MIP-creation criteria to none
Bridge2 (config-ether-cfm-ma) #ethernet cfm mep down mpid 23 active true xe8	Create down MEP 23 for xe8 interface
Bridge2 (config-ether-cfm-ma-mep) #cc multicast state enable	Enable CC multicast
Bridge2 (config-ether-cfm-ma-mep) #exit-ether-ma-mep-mode	Exit ethernet CFM MA-MEP mode
Bridge2 (config-ether-cfm-ma) #mep crosscheck mpid 32	Configure crosscheck to remote MEP with value 32
Bridge2 (config-ether-cfm-ma) #cc interval 100ms	Enable CC interval with 100ms
Bridge2 (config-ether-cfm-ma) #exit-ether-ma-mode	Exit Ethernet MA mode
Bridge2 (config-ether-cfm) #g8032 ring ring	Create g8032 ring with name ring on bridge 1
Bridge2 (g8032-ring-config) #east-interface xe6	Associate xe6 interface as east-interface
Bridge2 (g8032-ring-config) #west-interface xe8	Associate xe8 interface as west-interface
Bridge2 (g8032-ring-config) #g8032 profile profile1	Create g8032 profile with profile name profile1
Bridge2 (g8032-profile-config) #timer wait-to-restore 1	Configure wait to restore time as 1 min
Bridge2 (g8032-profile-config) #timer hold-off 0	Configure hold-off timer value as 0
Bridge2 (g8032-profile-config) #timer guard-timer 10	Configure guard-timer value as 10ms
Bridge2 (g8032-profile-config) #switching mode revertive	Configure Switching mode as revertive Switching mode
Bridge2 (g8032-profile-config) #g8032 erp-instance erp1	Create g8032 erp instance erp1
Bridge2 (g8032-config-switch) #ring ring	Associate ring RING1 to erp1 instance
Bridge2 (g8032-config-switch) #ring-type major-ring	Configure ring-type as major ring



Bridge2(g8032-config-switch)#rpl role non-owner	Configure the node as non-owner node
Bridge2(g8032-config-switch)#g8032-profile profile1	Associate Profile profile1 to erp1 instance
Bridge2(g8032-config-switch)#aps-channel level 7	Configure level as 7
Bridge2(g8032-config-switch)#aps-channel vlan 200	Configure RAPS channel vlan as 200
Bridge2(g8032-config-switch)#data vlan 202-205, 100	Configure traffic vlan from 202-205, 100
Bridge2(g8032-config-switch)#ring-id 1	Configure ring-id as 1
Bridge2(g8032-config-switch)#g8032 ring subring	Create g8032 ring with name subring
Bridge2(g8032-ring-config)#east-interface xe2	Associate xe2 interface as east-interface
Bridge2(g8032-ring-config)#g8032 erp-instance erp2	Create g8032 erp instance erp2
Bridge2(g8032-config-switch)#ring-type sub-ring-vc	Configure ring-type as sub-ring virtual channel
Bridge2(g8032-config-switch)#ring subring	Associate ring RING1 to erp2 instance
Bridge2(g8032-config-switch)#rpl role neighbor east-interface	Configure the node as neighbor node on east interface
Bridge2(g8032-config-switch)#g8032-profile profile1	Associate Profile profile1 to erp2 instance
Bridge2(g8032-config-switch)#aps-channel level 7	Configure level as 7
Bridge2(g8032-config-switch)#aps-channel vlan 201	Configure RAPS channel vlan as 201
Bridge2(g8032-config-switch)#data vlan 202-205	Configure traffic vlan from 202-205
Bridge2(g8032-config-switch)#ring-id 1	Configure ring-id as 1
Bridge2(g8032-config-switch)#virtual-channel 100 attached-to-instance erp1	Configure virtual channel with vlan 100 and attach erp2 to erp1
Bridge1(g8032-config-switch)# enable-tcn-propagation	Enable tcn propagation
Bridge2(g8032-config-switch)#commit	Commit the candidate configuration to the running configuration
Bridge2(g8032-config-switch)#end	Exit g8032 erp instance mode

### Bridge 3

Bridge3#config term	Enter configure mode
Bridge3(config)#bridge 1 protocol rstp vlan-bridge	Create bridge 1 as an RSTP VLAN-aware bridge.
Bridge3(config)#vlan database	Configure VLAN database
Bridge3(config-vlan)#vlan 100 bridge 1 state enable	Create VLAN 100 on bridge 1

Bridge3(config-vlan)#vlan 200-205 bridge 1 state enable	Create VLAN 200-205 on bridge 1
Bridge3(config)#interface xe8	Configure interface xe8
Bridge3(config-if)#switchport	Configure xe8 as a layer 2 port
Bridge3(config-if)#bridge-group 1	Configure interface in bridge group 1
Bridge3(config-if)#bridge-group 1 spanning- tree disable	Disable spanning tree for bridge group 1 on that interface
Bridge3(config-if)#switchport mode trunk	Configure port as trunk port
Bridge3(config-if)#switchport trunk allowed vlan add 100,200-205	Allow vlan 100,200-205 on xe8 interface
Bridge3(config-if)#interface xe4	Configure interface xe4
Bridge3(config-if)#switchport	Configure xe4 as a layer 2 port
Bridge3(config-if)#bridge-group 1	Configure interface in bridge group 1
Bridge3(config-if)#bridge-group 1 spanning- tree disable	Disable spanning tree for bridge group 1 on that interface
Bridge3(config-if)#switchport mode trunk	Configure port as trunk port
Bridge3(config-if)#switchport trunk allowed vlan add 100,200-205	Allow VLAN 100,200-205 on xe4 interface
Bridge3(config-if)#ethernet cfm domain-type character-string domain-name 00023 level 7 mip-creation none	Create CFM domain with type as character string with name 00023 and set mip creation criteria to default with level 7
Bridge3(config-ether-cfm)#service ma-type string ma-name 43982	Create MA type as string with name 43982
Bridge3(config-ether-cfm-ma)# vlan 200 bridge 1	Add VLAN 200
Bridge3(config-ether-cfm-ma)# mip-creation none	Set MIP-creation criteria to none
Bridge3(config-ether-cfm-ma)#ethernet cfm mep down mpid 32 active true xe8	Create down MEP 32 for xe8 interface
Bridge3(config-ether-cfm-ma-mep)#cc multicast state enable	Enable CC multicast
Bridge3(config-ether-cfm-ma-mep)#exit- ether-ma-mep-mode	Exit ethernet CFM MA-MEP mode
Bridge3(config-ether-cfm-ma)#mep crosscheck mpid 23	Configure crosscheck to remote MEP with value 23
Bridge3(config-ether-cfm-ma)#cc interval 100ms	Enable CC interval with 100ms
Bridge3(config-ether-cfm-ma)#exit-ether-ma- mode	Exit Ethernet MA mode
Bridge3(config-ether-cfm)#ethernet cfm domain-type character-string domain-name 00034 level 7 mip-creation none	Create cfm domain with type as character string with name 00034 and set mip creation criteria to default with level 7
Bridge3(config-ether-cfm)#service ma-type string ma-name 43982	Create ma type as string with name 43982
Bridge3(config-ether-cfm-ma)# vlan 200 bridge 1	Add VLAN 200
Bridge3(config-ether-cfm-ma)# mip-creation none	Set MIP-creation criteria to none

Bridge3(config-ether-cfm-ma)#ethernet cfm mep down mpid 34 active true xe4	Create down MEP 34 for xe4 interface
Bridge3(config-ether-cfm-ma-mep)#cc multicast state enable	Enable CC multicast
Bridge3(config-ether-cfm-ma-mep)#exit-ether-ma-mep-mode	Exit ethernet CFM MA-MEP mode
Bridge3(config-ether-cfm-ma)#mep crosscheck mpid 43	Configure crosscheck to remote MEP with value 43
Bridge3(config-ether-cfm-ma)#cc interval 100ms	Enable CC interval with 100ms
Bridge3(config-ether-cfm-ma)#exit-ether-ma-mode	Exit Ethernet ma mode
Bridge3(config-ether-cfm)#g8032 ring ring	Create g8032 ring with name ring
Bridge3(g8032-ring-config)#east-interface xe8	Associate xe8 interface as east-interface
Bridge3(g8032-ring-config)#west-interface xe4	Associate xe4 interface as west-interface
Bridge3(g8032-ring-config)#g8032 profile profile1	Create g8032 profile with profile name profile1
Bridge3(g8032-profile-config)#timer wait-to-restore 1	Configure wait to restore time as 1 min
Bridge3(g8032-profile-config)#timer hold-off 0	Configure hold-off timer value as 0
Bridge3(g8032-profile-config)#timer guard-timer 10	Configure guard-timer value as 10ms
Bridge3(g8032-profile-config)#switching mode revertive	Configure Switching mode as revertive Switching mode
Bridge3(g8032-profile-config)#g8032 erp-instance erp1	Create g8032 erp instance erp1
Bridge3(g8032-config-switch)#ring ring	Associate ring ring to erp1 instance
Bridge3(g8032-config-switch)#ring-type major-ring	Configure ring-type as major ring
Bridge3(g8032-config-switch)#rpl role owner west-interface	Configure the node as owner node on west interface
Bridge3(g8032-config-switch)#g8032-profile profile1	Associate Profile profile1 to erp1 instance
Bridge3(g8032-config-switch)#aps-channel level 7	Configure level as 7
Bridge3(g8032-config-switch)#aps-channel vlan 200	Configure RAPS channel vlan as 200
Bridge3(g8032-config-switch)#data vlan 202-205,100	Configure traffic vlan from 202-205, 100
Bridge3(g8032-config-switch)#ring-id 1	Configure ring-id as 1
Bridge3(g8032-config-switch)#commit	Commit the candidate configuration to the running configuration
Bridge3(g8032-config-switch)#end	Exit g8032 erp instance mode

**Bridge 4**

Bridge4#config term	Enter configuration mode
Bridge4(config)#bridge 1 protocol rstp vlan-bridge	Create bridge 1 as an RSTP VLAN-aware bridge.
Bridge4(config)#vlan database	Configure VLAN database
Bridge5(config-vlan)#vlan 100 bridge 1 state enable	Create VLAN 100 on bridge 1
Bridge4(config-vlan)#vlan 200-205 bridge 1 state enable	Create VLAN 200-205 on bridge 1
Bridge4(config)#interface xe4	Configure interface xe4
Bridge4(config-if)#switchport	Configure xe4 as a layer 2 port
Bridge4(config-if)#bridge-group 1	Configure interface in bridge group 1
Bridge4(config-if)#bridge-group 1 spanning- tree disable	Disable spanning tree for bridge group 1 on that interface
Bridge4(config-if)#switchport mode trunk	Configure port as trunk port
Bridge4(config-if)#switchport trunk allowed vlan add 100,200-205	Allow vlan 100,200-205 on xe4 interface
Bridge4(config-if)#interface xe16	Configure interface xe16
Bridge4(config-if)#switchport	Configure xe4 as a layer 2 port
Bridge4(config-if)#bridge-group 1	Configure interface in bridge group 1
Bridge4(config-if)#bridge-group 1 spanning- tree disable	Disable spanning tree for bridge group 1 on that interface
Bridge4(config-if)#switchport mode trunk	Configure port as trunk port
Bridge4(config-if)#switchport trunk allowed vlan add 100,200-205	Allow vlan 100,200-205 on xe16 interface
Bridge4(config-if)#ethernet cfm domain-type character-string domain-name 00034 level 7 mip-creation none	Create cfm domain with type as character string with name 00023 and set mip creation criteria to default with level 7
Bridge4(config-ether-cfm)#service ma-type string ma-name 43982	Create ma type as string with name 43982
Bridge4(config-ether-cfm-ma)# vlan 200 bridge 1	Add VLAN 200
Bridge4(config-ether-cfm-ma)# mip-creation none	Set mip-creation criteria to none
Bridge4(config-ether-cfm-ma)#ethernet cfm mep down mpid 43 active true xe4	Create down MEP 43 for xe4 interface
Bridge4(config-ether-cfm-ma-mep)#cc multicast state enable	Enable CC multicast
Bridge4(config-ether-cfm-ma-mep)#exit- ether-ma-mep-mode	Exit ethernet CFM MA-MEP mode
Bridge4(config-ether-cfm-ma)#mep crosscheck mpid 34	Configure crosscheck to remote MEP with value 34
Bridge4(config-ether-cfm-ma)#cc interval 100ms	Enable CC interval with 100ms
Bridge4(config-ether-cfm-ma)#exit-ether-ma- mode	Exit Ethernet ma mode

Bridge4(config-ether-cfm)#ethernet cfm domain-type character-string domain-name 00045 level 7 mip-creation none	Create cfm domain with type as character string with name 00045 and set mip creation criteria to default with level 7
Bridge4(config-ether-cfm)#service ma-type string ma-name 43982	Create ma type as string with name 43982
Bridge4(config-ether-cfm-ma)# vlan 200 bridge 1	Add VLAN 200
Bridge4(config-ether-cfm-ma)# mip-creation none	Set mip-creation criteria to none
Bridge4(config-ether-cfm-ma)#ethernet cfm mep down mpid 45 active true xe16	Create down MEP 45 for xe16 interface
Bridge4(config-ether-cfm-ma-mep)#cc multicast state enable	Enable CC multicast
Bridge4(config-ether-cfm-ma-mep)#exit-ether-ma-mep-mode	Exit ethernet CFM MA-MEP mode
Bridge4(config-ether-cfm-ma)#mep crosscheck mpid 54	Configure crosscheck to remote MEP with value 54
Bridge4(config-ether-cfm-ma)#cc interval 100ms	Enable CC interval with 100ms
Bridge4(config-ether-cfm-ma)#exit-ether-ma-mode	Exit Ethernet MA mode
Bridge4(config-ether-cfm)#g8032 ring ring	Create g8032 ring with name ring
Bridge4(g8032-ring-config)#east-interface xe4	Associate xe4 interface as east-interface
Bridge4(g8032-ring-config)#west-interface xe16	Associate xe16 interface as west-interface
Bridge4(g8032-ring-config)#g8032 profile profile1	Create g8032 profile with profile name profile1
Bridge4(g8032-profile-config)#timer wait-to-restore 1	Configure wait to restore time as 1 min
Bridge4(g8032-profile-config)#timer hold-off 0	Configure hold-off timer value as 0
Bridge4(g8032-profile-config)#timer guard-timer 10	Configure guard-timer value as 10ms
Bridge4(g8032-profile-config)#switching mode revertive	Configure Switching mode as revertive Switching mode
Bridge4(g8032-profile-config)#g8032 erp-instance erp1	Create g8032 erp instance erp1
Bridge4(g8032-config-switch)#ring-type major-ring	Configure ring-type as major ring
Bridge4(g8032-config-switch)#ring ring	Associate ring ring to erp1 instance
Bridge4(g8032-config-switch)#rpl role neighbor east-interface	Configure the node as neighbor node on east interface
Bridge4(g8032-config-switch)#g8032-profile profile1	Associate Profile profile1 to erp1 instance
Bridge4(g8032-config-switch)#aps-channel level 7	Configure level as 7
Bridge4(g8032-config-switch)#aps-channel vlan 200	Configure RAPS channel vlan as 200

Bridge4(g8032-config-switch)#data vlan 202-205, 100	Configure traffic vlan from 202-205, 100
Bridge4(g8032-config-switch)#ring-id 1	Configure ring-id as 1
Bridge4(g8032-config-switch)#commit	Commit the candidate configuration to the running configuration
Bridge4(g8032-config-switch)#end	Exit g8032 erp instance mode

## Bridge 5

Bridge5#config term	Enter configure mode
Bridge5(config)#bridge 1 protocol rstp vlan-bridge	Create bridge 1 as an RSTP VLAN-aware bridge.
Bridge1(config)#vlan database	Configure VLAN database
Bridge5(config-vlan)#vlan 100 bridge 1 state enable	Create VLAN 100 on bridge 1
Bridge5(config-vlan)#vlan 200-205 bridge 1 state enable	Create VLAN 200-205 on bridge 1
Bridge5(config)#interface xe16	Configure interface xe16
Bridge5(config-if)#switchport	Configure xe16 as a layer 2 port
Bridge5(config-if)#bridge-group 1	Configure interface in bridge group 1
Bridge5(config-if)#bridge-group 1 spanning-tree disable	Disable spanning tree for bridge group 1 on that interface
Bridge5(config-if)#switchport mode trunk	Configure port as trunk port
Bridge5(config-if)#switchport trunk allowed vlan add 100,200-205	Allow vlan 100,200-205 on xe16 interface
Bridge5(config-if)#interface xe6	Configure interface xe6
Bridge5(config-if)#switchport	Configure xe6 as a layer 2 port
Bridge5(config-if)#bridge-group 1	Configure interface in bridge group 1
Bridge5(config-if)#bridge-group 1 spanning-tree disable	Disable spanning tree for bridge group 1 on that interface
Bridge5(config-if)#switchport mode trunk	Configure port as trunk port
Bridge5(config-if)#switchport trunk allowed vlan add 100,200-205	Allow vlan 100,200-205 on xe6 interface
Bridge5(config-if)#interface xe17	Configure interface xe17
Bridge5(config-if)#switchport	Configure xe17 as a layer 2 port
Bridge5(config-if)#bridge-group 1	Configure interface in bridge group 1
Bridge5(config-if)#bridge-group 1 spanning-tree disable	Disable spanning tree for bridge group 1 on that interface
Bridge5(config-if)#switchport mode trunk	Configure port as trunk port
Bridge5(config-if)#switchport trunk allowed vlan add 100,200-205	Allow vlan 100,200-205 on xe17 interface
Bridge5(config-if)#ethernet cfm domain-type character-string domain-name 00045 level 7 mip-creation none	Create cfm domain with type as character string with name 00045 and set mip creation criteria to default with level 7
Bridge5(config-ether-cfm)#service ma-type string ma-name 43982	Create ma type as string with name 43982

Bridge5(config-ether-cfm-ma)# vlan 200 bridge 1	Add VLAN 200
Bridge5(config-ether-cfm-ma)# mip- creation none	Set mip-creation criteria to none
Bridge5(config-ether-cfm-ma)#ethernet cfm mep down mpid 54 active true xe16	Create down MEP 54 for xe16 interface
Bridge5(config-ether-cfm-ma-mep)#cc multicast state enable	Enable CC multicast
Bridge5(config-ether-cfm-ma-mep)#exit- ether-ma-mep-mode	Exit ethernet CFM ma-mep mode
Bridge5(config-ether-cfm-ma)#mep crosscheck mpid 45	Configure crosscheck to remote MEP with value 45
Bridge5(config-ether-cfm-ma)#cc interval 100ms	Enable CC interval with 100ms
Bridge5(config-ether-cfm-ma)#exit-ether- ma-mode	Exit Ethernet ma mode
Bridge5(config-ether-cfm)#ethernet cfm domain-type character-string domain-name 00052 level 7 mip-creation none	Create cfm domain with type as character string with name 00052 and set mip creation criteria to default with level 7
Bridge5(config-ether-cfm)#service ma-type string ma-name 43982	Create MA type as string with name 43982
Bridge5(config-ether-cfm-ma)# vlan 200 bridge 1	Add VLAN 200
Bridge5(config-ether-cfm-ma)# mip- creation none	Set mip-creation criteria to none
Bridge5(config-ether-cfm-ma)#ethernet cfm mep down mpid 52 active true xe6	Create down MEP 52 for xe6 interface
Bridge5(config-ether-cfm-ma-mep)#cc multicast state enable	Enable CC multicast
Bridge5(config-ether-cfm-ma-mep)#exit- ether-ma-mep-mode	Exit ethernet CFM MA-MEP mode
Bridge5(config-ether-cfm-ma)#mep crosscheck mpid 25	Configure crosscheck to remote MEP with value 25
Bridge5(config-ether-cfm-ma)#cc interval 100ms	Enable CC interval with 100ms
Bridge5(config-ether-cfm-ma)#exit-ether- ma-mode	Exit Ethernet ma mode
Bridge5(config-ether-cfm)#ethernet cfm domain-type character-string domain-name 00056 level 7 mip-creation none	Create cfm domain with type as character string with name 00056 and set mip creation criteria to default with level 7
Bridge5(config-ether-cfm)#service ma-type string ma-name 43982	Create ma type as string with name 43982
Bridge5(config-ether-cfm-ma)# vlan 201 bridge 1	Add VLAN 201
Bridge5(config-ether-cfm-ma)# mip- creation none	Set mip-creation criteria to none
Bridge5(config-ether-cfm-ma)#ethernet cfm mep down mpid 56 active true xe17	Create down MEP 56 for xe17 interface
Bridge5(config-ether-cfm-ma-mep)#cc multicast state enable	Enable cc multicast

Bridge5 (config-ether-cfm-ma-mep) #exit-ether-ma-mep-mode	Exit ethernet cfm ma-mep mode
Bridge5 (config-ether-cfm-ma) #mep crosscheck mpid 65	Configure crosscheck to remote MEP with value 65
Bridge5 (config-ether-cfm-ma) #cc interval 100ms	Enable CC interval with 100ms
Bridge5 (config-ether-cfm-ma) #exit-ether-ma-mode	Exit Ethernet ma mode
Bridge5 (config-ether-cfm) #g8032 ring ring	Create g8032 ring with name ring
Bridge5 (g8032-ring-config) #east-interface xe16	Associate xe16 interface as east-interface
Bridge5 (g8032-ring-config) #west-interface xe6	Associate xe6 interface as west-interface
Bridge5 (g8032-ring-config) #g8032 profile profile1	Create g8032 profile with profile name profile1
Bridge5 (g8032-profile-config) #timer wait-to-restore 1	Configure wait to restore time as 1 min
Bridge5 (g8032-profile-config) #timer hold-off 0	Configure hold-off timer value as 0
Bridge5 (g8032-profile-config) #timer guard-timer 10	Configure guard-timer value as 10ms
Bridge5 (g8032-profile-config) #switching mode revertive	Configure Switching mode as revertive Switching mode
Bridge5 (g8032-profile-config) #g8032 erp-instance erp1	Create g8032 erp instance erp1
Bridge5 (g8032-config-switch) #ring ring	Associate ring ring to erp1 instance
Bridge5 (g8032-config-switch) #ring-type major-ring	Configure ring-type as major ring
Bridge5 (g8032-config-switch) #rpl role non-owner	Configure the node as non-owner node
Bridge5 (g8032-config-switch) #g8032-profile profile1	Associate Profile profile1 to erp1 instance
Bridge5 (g8032-config-switch) #aps-channel level 7	Configure level as 7
Bridge5 (g8032-config-switch) #aps-channel vlan 200	Configure RAPS channel vlan as 200
Bridge5 (g8032-config-switch) #data vlan 202-205,100	Configure traffic vlan from 202-205, 100
Bridge5 (g8032-config-switch) #ring-id 1	Configure ring-id as 1
Bridge5 (g8032-config-switch) #g8032 ring subring	Create g8032 physical ring with name subring
Bridge5 (g8032-ring-config) #east-interface xe17	Associate xe17 interface as east-interface
Bridge5 (g8032-profile-config) #g8032 erp-instance erp2	Create g8032 erp instance erp2
Bridge5 (g8032-config-switch) #ring-type sub-ring-vc	Configure ring-type as sub-ring virtual channel
Bridge5 (g8032-config-switch) #ring subring	Associate ring subring to erp2 instance



Bridge5(g8032-config-switch)#rpl role non-owner	Configure the node as non-owner node
Bridge5(g8032-config-switch)#g8032-profile profile1	Associate Profile profile1 to erp2 instance
Bridge5(g8032-config-switch)#aps-channel level 7	Configure level as 7
Bridge5(g8032-config-switch)#aps-channel vlan 201	Configure RAPS channel vlan as 201
Bridge5(g8032-config-switch)#data vlan 202-205	Configure traffic vlan from 202-205
Bridge5(g8032-config-switch)#ring-id 1	Configure ring-id as 1
Bridge5(g8032-config-switch)#virtual-channel 100 attached-to-instance erp1	Configure virtual channel with vlan 100 and attach erp2 to erp1
Bridge5(g8032-config-switch)# enable-tcn-propagation	Enable tcn propagation
Bridge5(g8032-config-switch)#commit	Commit the candidate configuration to the running configuration
Bridge5(g8032-config-switch)#end	Exit g8032 erp instance mode

## Bridge 6

Bridge6#config term	Enter configuration mode
Bridge6(config)#bridge 1 protocol rstp vlan-bridge	Create bridge 1 as an RSTP VLAN-aware bridge.
Bridge1(config)#vlan database	Configure VLAN database
Bridge6(config-vlan)#vlan 200-205 bridge 1 state enable	Create VLAN 200-205 on bridge 1
Bridge6(config-vlan)#hardware-profile filter cfm-domain-name-str enable	Enable CFM domain name as string
Bridge6(config)#interface xe0	Configure interface xe0
Bridge6(config-if)#switchport	Configure xe0 as a layer 2 port
Bridge6(config-if)#bridge-group 1	Configure interface in bridge group 1
Bridge6(config-if)#bridge-group 1 spanning-tree disable	Disable spanning tree for bridge group 1 on that interface
Bridge6(config-if)#switchport mode trunk	Configure port as trunk port
Bridge6(config-if)#switchport trunk allowed vlan add 200-205	Allow vlan 200-205 on xe0 interface
Bridge6(config-if)#interface ce0	Configure interface ce0
Bridge6(config-if)#switchport	Configure ce0 as a layer 2 port
Bridge6(config-if)#bridge-group 1	Configure interface in bridge group 1
Bridge6(config-if)#bridge-group 1 spanning-tree disable	Disable spanning tree for bridge group 1 on that interface
Bridge6(config-if)#switchport mode trunk	Configure port as trunk port
Bridge6(config-if)#switchport trunk allowed vlan add 200-205	Allow vlan 200-205 on ce0 interface

Bridge6(config-if)#ethernet cfm domain-type character-string domain-name 00056 level 7 mip-creation none	Create cfm domain with type as character string with name 00056 and set mip creation criteria to default with level 7
Bridge6(config-ether-cfm)#service ma-type string ma-name 43982	Create MA type as string with name 43982.
Bridge6(config-ether-cfm-ma)# vlan 201 bridge 1	Add VLAN 201
Bridge6(config-ether-cfm-ma)# mip-creation none	Set MIP-creation criteria to none
Bridge6(config-ether-cfm-ma)#ethernet cfm mep down mpid 65 active true xe0	Create down MEP 65 for xe0 interface
Bridge6(config-ether-cfm-ma-mep)#cc multicast state enable	Enable CC multicast
Bridge6(config-ether-cfm-ma-mep)#exit-ether-ma-mep-mode	Exit ethernet cfm ma-mep mode
Bridge6(config-ether-cfm-ma)#mep crosscheck mpid 56	Configure crosscheck to remote MEP with value 56
Bridge6(config-ether-cfm-ma)#cc interval 100ms	Enable CC interval with 100ms
Bridge6(config-ether-cfm-ma)#exit-ether-ma-mode	Exit Ethernet ma mode
Bridge6(config-ether-cfm)#ethernet cfm domain-type character-string domain-name 00061 level 7 mip-creation none	Create cfm domain with type as character string with name 00061 and set mip creation criteria to default with level 7
Bridge6(config-ether-cfm)#service ma-type string ma-name 43982	Create ma type as string with name 43982
Bridge6(config-ether-cfm-ma)# vlan 201 bridge 1	Add VLAN 201
Bridge6(config-ether-cfm-ma)# mip-creation none	Set MIP-creation criteria to none
Bridge6(config-ether-cfm-ma)#ethernet cfm mep down mpid 61 active true ce0	Create down MEP 61 for ce0 interface
Bridge6(config-ether-cfm-ma-mep)#cc multicast state enable	Enable CC multicast
Bridge6(config-ether-cfm-ma-mep)#exit-ether-ma-mep-mode	Exit ethernet cfm ma-mep mode
Bridge6(config-ether-cfm-ma)#mep crosscheck mpid 16	Configure crosscheck to remote MEP with value 16
Bridge6(config-ether-cfm-ma)#cc interval 100ms	Enable CC interval with 100ms
Bridge6(config-ether-cfm-ma)#exit-ether-ma-mode	Exit Ethernet ma mode
Bridge6(config-ether-cfm)#g8032 ring subring	Create g8032 physical ring with name subring
Bridge6(g8032-ring-config)#east-interface xe0	Associate xe0 interface as east-interface
Bridge6(g8032-ring-config)#west-interface ce0	Associate ce0 interface as west-interface
Bridge6(g8032-ring-config)#g8032 profile profile1	Create g8032 profile with profile name profile1

Bridge6(g8032-profile-config)#timer wait-to-restore 1	Configure wait to restore time as 1 min
Bridge6(g8032-profile-config)#timer hold-off 0	Configure hold-off timer value as 0
Bridge6(g8032-profile-config)#timer guard-timer 10	Configure guard-timer value as 10ms
Bridge6(g8032-profile-config)#switching mode revertive	Configure Switching mode as revertive Switching mode
Bridge6(g8032-profile-config)#g8032 erp-instance erp2	Create g8032 erp instance erp2
Bridge6(g8032-config-switch)#ring-type subring-vc	Configure ring type as subring virtual channel
Bridge6(g8032-config-switch)#ring subring	Associate ring subring to erp2 instance
Bridge6(g8032-config-switch)#rpl role non-owner	Configure the node as non-owner node
Bridge6(g8032-config-switch)#g8032-profile profile1	Associate Profile profile1 to erp2 instance
Bridge6(g8032-config-switch)#aps-channel level 7	Configure level as 7
Bridge6(g8032-config-switch)#aps-channel vlan 201	Configure RAPS channel vlan as 201
Bridge6(g8032-config-switch)#data-traffic-vlan 202-205	Configure traffic vlan from 202-205
Bridge6(g8032-config-switch)#ring-id 1	Configure ring-id as 1
Bridge6(g8032-config-switch)#commit	Commit the candidate configuration to the running configuration
Bridge6(g8032-config-switch)#end	Exit g8032 erp instance mode

## Validation

```
Bridge1#show g8032 erp-instance erp2
```

```

Inst Name       : erp2
Description     :
State          : G8032_ST_IDLE
Phy Ring       : subring
Ring Type      : SUB-RING (VIRTUAL)
Role           : OWNER (WEST)
Node ID        : 6c:b9:c5:67:72:1d
-----
                East Link           West Link
=====
Interface      : ce49                xe2
State          : Unblocked           Blocked
Remote NodeId  : -                   -
Remote BPR     : -                   -
Endpoint Info
-----
Domain Name    : 00061                00012
MEP ID         : 16                   12
MA Name        : 43982                43982
=====
-----

```

```

      Channel          |
    (LEVEL, VLAN, RING ID) |
    =====
    (7,      201,    1)      |
    =====

```

DataTraffic vlan: 202-205  
Profile : profile1

Bridge2#show g8032 erp-instance erp2

```

Inst Name       : erp2
Description     :
State          : G8032_ST_IDLE
Phy Ring       : subring
Ring Type      : SUB-RING (VIRTUAL)
Role           : NEIGHBOR (EAST)
Node ID        : 3c:2c:99:26:e6:7c

```

```

-----
                East Link          West Link
    =====
Interface       : xe2              -
State           : Blocked          -
Remote NodeId   : 6c:b9:c5:67:72:1d -
Remote BPR      : 0                -
Endpoint Info
-----
Domain Name     : 00012            -
MEP ID         : 21                -
MA Name        : 43982            -
    =====
TCN Propagation : Enabled
Attached        : -
Attached To     : erp1,
Virtual ID      : 100 : 1

```

```

      Channel          |
    (LEVEL, VLAN, RING ID) |
    =====
    (7,      201,    1)      |
    =====

```

DataTraffic vlan: 202-205  
Profile : profile1

Bridge2#show g8032 erp-instance erp1

```

Inst Name       : erp1
Description     :
State          : G8032_ST_IDLE
Phy Ring       : ring
Ring Type      : MAJOR-RING
Role           : NON-OWNER
Node ID        : 3c:2c:99:26:e6:80

```

```

                                East Link          West Link
=====
Interface      : xe6                xe8
State          : Unblocked          Unblocked
Remote NodeId  : -                  d8:9e:f3:5e:f8:29
Remote BPR     : -                  0
Endpoint Info
-----
Domain Name    : 00052              00023
MEP ID         : 25                 23
MA Name        : 43982              43982
=====
TCN Propagation : Disabled
Attached        : erp2,
Attached To     : -
Virtual ID      : -:-
-----
Channel        |
(LEVEL, VLAN, RING ID) |
=====
(7, 200, 1)   |
=====

```

```
DataTraffic vlan: 202-205,100
Profile : profile1
```

```
Bridge3#show g8032 erp-instance erp1
```

```

Inst Name      : erp1
Description    :
State          : G8032_ST_IDLE
Phy Ring       : ring
Ring Type      : MAJOR-RING
Role           : OWNER (WEST)
Node ID        : d8:9e:f3:5e:f8:29
-----
                                East Link          West Link
=====
Interface      : xe8                xe4
State          : Unblocked          Blocked
Remote NodeId  : -                  -
Remote BPR     : -                  -
Endpoint Info
-----
Domain Name    : 00023              00034
MEP ID         : 32                 34
MA Name        : 43982              43982
=====
-----
Channel        |
(LEVEL, VLAN, RING ID) |
=====
(7, 200, 1)   |
=====

```

```
DataTraffic vlan: 202-205,100
```

Profile : profile1

Bridge4#show g8032 erp-instance erp1

```

Inst Name       : erp1
Description     :
State          : G8032_ST_IDLE
Phy Ring       : ring
Ring Type      : MAJOR-RING
Role           : NEIGHBOR (EAST)
Node ID        : 3c:2c:99:1a:da:7e

```

```

-----
                        East Link                West Link
=====
Interface        : xe4                          xe16
State            : Blocked                      Unblocked
Remote NodeId    : d8:9e:f3:5e:f8:29           d8:9e:f3:5e:f8:29
Remote BPR       : 0                            0
Endpoint Info
-----
Domain Name      : 00034                        00045
MEP ID          : 43                            45
MA Name         : 43982                        43982
=====

```

```

-----
Channel          |
(LABEL, VLAN, RING ID) |
=====
(7, 200, 1)      |
=====

```

DataTraffic vlan: 202-205,100  
Profile : profile1

Bridge5#show g8032 erp-instance erp2

```

Inst Name       : erp2
Description     :
State          : G8032_ST_IDLE
Phy Ring       : subring
Ring Type      : SUB-RING (VIRTUAL)
Role           : NON-OWNER
Node ID        : 34:17:eb:e4:af:12

```

```

-----
                        East Link                West Link
=====
Interface        : xe17                          -
State            : Unblocked                      -
Remote NodeId    : 6c:b9:c5:67:72:1d           -
Remote BPR       : 0                            -
Endpoint Info
-----
Domain Name      : 00056                        -
MEP ID          : 56                            -
MA Name         : 43982                        -
=====

```

```

=====
TCN Propagation : Enabled
Attached       : -
Attached To    : erp1,
Virtual ID     : 100 : 1
-----

```

```

      Channel      |
  (LEVEL, VLAN, RING ID) |
=====
  (7,    201,    1)      |
=====

```

```

DataTraffic vlan: 202-205
Profile : profile1

```

```

Bridge5#show g8032 erp-instance erp1

```

```

Inst Name      : erp1
Description    :
State         : G8032_ST_IDLE
Phy Ring      : ring
Ring Type     : MAJOR-RING
Role          : NON-OWNER
Node ID       : 34:17:eb:e4:af:11
-----

```

	East Link	West Link
Interface	: xe16	xe6
State	: Unblocked	Unblocked
Remote NodeId	: -	d8:9e:f3:5e:f8:29
Remote BPR	: -	0
Endpoint Info		
-----		
Domain Name	: 00045	00052
MEP ID	: 54	52
MA Name	: 43982	43982

```

=====
TCN Propagation : Disabled
Attached       : erp2,
Attached To    : -
Virtual ID     : :-
-----

```

```

      Channel      |
  (LEVEL, VLAN, RING ID) |
=====
  (7,    200,    1)      |
=====

```

```

DataTraffic vlan: 202-205,100
Profile : profile1

```

```

Bridge6#show g8032 erp-instance erp2

```

```

Inst Name      : erp2
Description    :

```

State : G8032\_ST\_IDLE  
Phy Ring : subring (VIRTUAL)  
Ring Type : SUB-RING  
Role : NON-OWNER  
Node ID : b8:6a:97:d2:27:c6

-----  
East Link West Link  
=====

Interface	: xe0	ce0
State	: Unblocked	Unblocked
Remote NodeId	: -	6c:b9:c5:67:72:1d
Remote BPR	: -	0
Endpoint Info		
-----		
Domain Name	: 00056	00061
MEP ID	: 65	61
MA Name	: 43982	43982

=====

-----  
Channel |  
(LEVEL, VLAN, RING ID) |  
=====

(7, 201, 1)	
-------------	--

=====

DataTraffic vlan: 202-205  
Profile : profile1



## Sub-ring without Virtual Channel on a LAG interface

Figure 3 displays a sample Ring Protection topology on which protection switching is configured with 5 bridges on lag interfaces. The topology contains one major ring and one subring with non-virtual channel. The Ring Protection Link (RPL) for major ring is the link between Bridge 4 (owner) and Bridge 3 (neighbor) on lag interface po3. The subring is configured with no virtual channel and it's RPL link is configured between bridge 1 (neighbor) and bridge 5 (owner) on lag interface po6. The rest of the bridges are explicitly configured RPL non owner to enable ERPS in the ring in both major and subring.

### Topology

Figure 4-11 displays a sample Ethernet Ring Protection Switching topology.

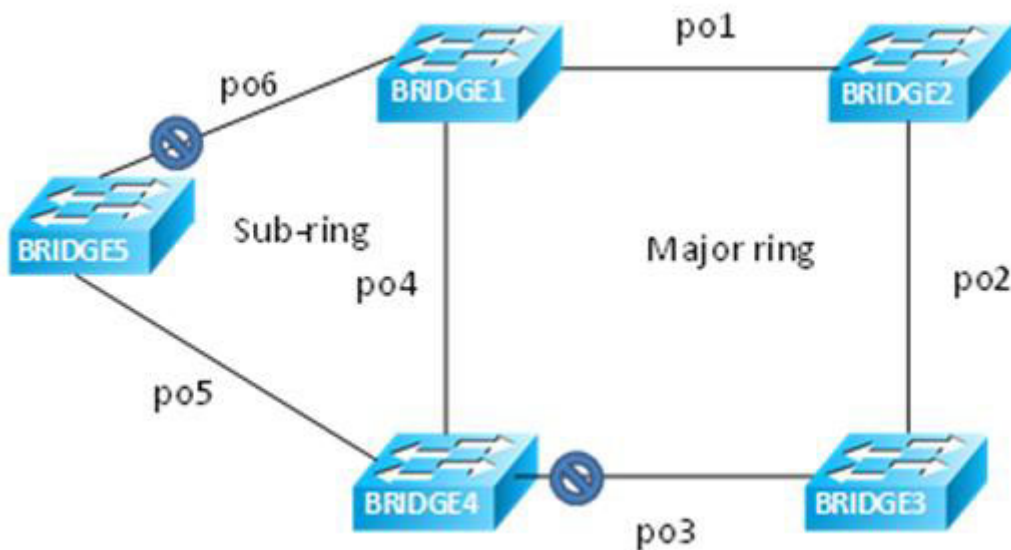

Figure 4-11: Major ring and sub-ring topology using LAG interface without a virtual channel

### Configuration

#### Bridge 1

Bridgel#config term	Enter configure mode
Bridgel(config)#bridge 1 protocol rstp vlan-bridge	Create bridge 1 as an RSTP VLAN-aware bridge.
Bridgel(config)#hardware-profile filter cfm-domain-name-str enable	Enable CFM domain name as string
Bridgel(config)#vlan database	Configure VLAN database
Bridgel(config-vlan)#vlan 200-205 bridge 1 state enable	Create VLAN 200-205 on bridge 1
Bridgel(config-vlan)#interface po1	Configure lag interface po1
Bridgel(config-if)#switchport	Configure po1 as a layer 2 port

Bridgell(config-if)#bridge-group 1	Configure interface in bridge group 1
Bridgell(config-if)#bridge-group 1 spanning-tree disable	Disable spanning tree for bridge group 1 on that interface
Bridgell(config-if)#switchport mode trunk	Configure port as trunk port
Bridgell(config-if)#switchport trunk allowed vlan add 200-205	Allow vlan 200-205 on po1 interface
Bridgell(config-if)#interface po4	Configure lag interface po4
Bridgell(config-if)#switchport	Configure po4 as a layer 2 port
Bridgell(config-if)#bridge-group 1 spanning-tree disable	Configure interface in bridge group 1
Bridgell(config-if)#switchport mode trunk	Disable spanning tree for bridge group 1 on that interface
Bridgell(config-if)#switchport trunk allowed vlan add 200-205	Allow vlan 200-205 on po4 interface
Bridgell(config-if)#interface po6	Configure lag interface po6
Bridgell(config-if)#switchport	Configure po6 as a layer 2 port
Bridgell(config-if)#bridge-group 1	Configure interface in bridge group 1
Bridgell(config-if)#bridge-group 1 spanning-tree disable	Disable spanning tree for bridge group 1 on that interface
Bridgell(config-if)#switchport mode trunk	Configure port as trunk port
Bridgell(config-if)#switchport trunk allowed vlan add 200-205	Allow vlan 200-205 on po6 interface
Bridgell(config-if)#interface xe1	Configure interface xe1
Bridgell(config-if)#channel-group 6 mode active	Configure xe1 as part of po6
Bridgell(config-if)#interface xe2	Configure interface xe2
Bridgell(config-if)#channel-group 6 mode active	Configure xe2 as part of po6
Bridgell(config-if)#interface xe6	Configure interface xe6
Bridgell(config-if)#channel-group 4 mode active	Configure xe6 as part of po4
Bridgell(config-if)#interface xe7	Configure interface xe7
Bridgell(config-if)#channel-group 4 mode active	Configure xe7 as part of po4
Bridgell(config-if)#interface xe8	Configure interface xe8
Bridgell(config-if)#channel-group 1 mode active	Configure xe8 as part of po1
Bridgell(config-if)#interface xe9	Configure interface xe9
Bridgell(config-if)#channel-group 1 mode active	Configure xe9 as part of po1
Bridgell(config-if)#ethernet cfm domain-type character-string domain-name nod12 level 7 mip-creation none	Create cfm domain with type as character string with name nod12 and set mip creation criteria to default with level 7
Bridgell(config-ether-cfm)#service ma-type string ma-name 43982	Create ma type as string with name 43982
Bridgell(config-ether-cfm-ma)# vlan 200 bridge 1	Add vlan 200

Bridgell(config-ether-cfm-ma)#mip-creation none	Set mip-creation criteria to none
Bridgell(config-ether-cfm-ma)#ethernet cfm mep down mpid 12 active true po1	Create down mep 12 for po1 interface
Bridgell(config-ether-cfm-ma-mep)#cc multicast state enable	Enable cc multicast
Bridgell(config-ether-cfm-ma-mep)#exit-ether-ma-mep-mode	Exit ethernet cfm ma-mep mode
Bridgell(config-ether-cfm-ma)#mep crosscheck mpid 21	Configure crosscheck to remote MEP with value 21
Bridgell(config-ether-cfm-ma)#cc interval 100ms	Enable CC interval with 100ms
Bridgell(config-ether-cfm-ma)#exit-ether-ma-mode	Exit Ethernet ma mode
Bridgell(config-ether-cfm)#ethernet cfm domain-type character-string domain-name nod41 level 7 mip-creation none	Create cfm domain with type as character string with name nod41 and set mip creation criteria to default with level 7
Bridgell(config-ether-cfm)#service ma-type string ma-name 43982	Create ma type as string with name 43982
Bridgell(config-ether-cfm-ma)# vlan 200 bridge 1	Add VLAN 200
Bridgell(config-ether-cfm-ma)#mip-creation none	Set mip-creation criteria to none
Bridgell(config-ether-cfm-ma)#ethernet cfm mep down mpid 14 active true po4	Create down MEP 14 for po4 interface
Bridgell(config-ether-cfm-ma-mep)#cc multicast state enable	Enable CC multicast
Bridgell(config-ether-cfm-ma-mep)#exit-ether-ma-mep-mode	Exit ethernet CFM ma-mep mode
Bridgell(config-ether-cfm-ma)#mep crosscheck mpid 41	Configure crosscheck to remote MEP with value 41
Bridgell(config-ether-cfm-ma)#cc interval 23ms	Enable CC interval with 100ms
Bridgell(config-ether-cfm-ma)#exit-ether-ma-mode	Exit Ethernet ma mode
Bridgell(config-ether-cfm)#ethernet cfm domain-type character-string domain-name nod15 level 7 mip-creation none	Create cfm domain with type as character string with name nod15 and set mip creation criteria to default with level 7
Bridgell(config-ether-cfm)#service ma-type string ma-name 43982	Create ma type as string with name 43982
Bridgell(config-ether-cfm-ma)# vlan 200 bridge 1	Add VLAN 200
Bridgell(config-ether-cfm-ma)#mip-creation none	Set mip-creation creation criteria to none
Bridgell(config-ether-cfm-ma)#ethernet cfm mep down mpid 51 active true po6	Create down mep 51 for po6 interface
Bridgell(config-ether-cfm-ma-mep)#cc multicast state enable	Enable cc multicast
Bridgell(config-ether-cfm-ma-mep)#exit-ether-ma-mep-mode	Exit ethernet cfm ma-mep mode

Bridgel (config-ether-cfm-ma) #mep crosscheck mpid 15	Configure crosscheck to remote MEP with value 15
Bridgel (config-ether-cfm-ma) #cc interval 100ms	Enable CC interval with 100ms
Bridgel (config-ether-cfm-ma) #exit-ether-ma-mode	Exit Ethernet ma mode
Bridgel (config-ether-cfm) #g8032 ring lagring	Create g8032 ring with name lagring
Bridgel (g8032-ring-config) #east-interface po4	Associate po4 interface as east-interface
Bridgel (g8032-ring-config) #west-interface po1	Associate po1 interface as west-interface
Bridgel (g8032-ring-config) #g8032 profile profile1	Create g8032 profile with profile name profile1
Bridgel (g8032-profile-config) #timer wait-to-restore 1	Configure wait to restore time as 1 min
Bridgel (g8032-profile-config) #timer hold-off 0	Configure hold-off timer value as 0
Bridgel (g8032-profile-config) #timer guard-timer 10	Configure guard-timer value as 10ms
Bridgel (g8032-profile-config) #switching mode revertive	Configure Switching mode as revertive Switching mode
Bridgel (g8032-profile-config) #g8032 erp-instance erp1	Create g8032 erp instance erp1
Bridgel (g8032-config-switch) #ring lagring	Associate ring lagring to erp1 instance
Bridgel (g8032-config-switch) #rpl role non-owner	Configure the node as non-owner node
Bridgel (g8032-config-switch) #g8032-profile profile1	Associate Profile profile1 to erp1 instance
Bridgel (g8032-config-switch) #aps-channel level 7	Configure level as 7
Bridgel (g8032-config-switch) #aps-channel vlan 200	Configure RAPS channel vlan as 200
Bridgel (g8032-config-switch) #data vlan 201-205	Configure traffic vlan from 201-205
Bridgel (g8032-config-switch) #ring-id 1	Configure ring-id as 1
Bridgel (g8032-config-switch) #g8032 ring lagsubring	Create g8032 ring with name lagsubring
Bridgel (g8032-ring-config) #east-interface po6	Associate po6 interface as east-interface
Bridgel (g8032-ring-config) #g8032 erp-instance erp2	Create g8032 erp instance erp2
Bridgel (g8032-config-switch) #ring-type sub-ring	Configure ring-type as sub-ring
Bridgel (g8032-config-switch) #ring lagsubring	Associate ring lagsubring to erp2 instance
Bridgel (g8032-config-switch) #rpl role neighbor east-interface	Configure the node as neighbor node on east interface
Bridgel (g8032-config-switch) #g8032-profile profile1	Associate Profile profile1 to erp2 instance

Bridge1(g8032-config-switch)#aps-channel level 7	Configure level as 7
Bridge1(g8032-config-switch)#aps-channel vlan 200	Configure RAPS channel vlan as 200
Bridge1(g8032-config-switch)#data vlan 201-205	Configure traffic vlan from 201-205
Bridge1(g8032-config-switch)#ring-id 2	Configure ring-id as 2
Bridge1(g8032-config-switch)#non-virtual-channel	Enable Non Virtual Channel
Bridge1(g8032-config-switch)# enable-tcn-propagation	Enable tcn propagation
Bridge1(g8032-config-switch)# tcn-to-instance erp1	Attach erp1 instance to erp2 instance to notify any changes in subring to major ring
Bridge1(g8032-config-switch)#commit	Commit the candidate configuration to the running configuration
Bridge1(g8032-config-switch)#end	Exit g8032 erp instance mode

## Bridge 2

Bridge2#config term	Enter configure mode
Bridge2(config)#hardware-profile filter cfm-domain-name-str enable	Create bridge 1 as an RSTP VLAN-aware bridge.
Bridge2(config)#bridge 1 protocol rstp vlan-bridge	Enable CFM domain name as string
Bridge1(config)#vlan database	Configure VLAN database
Bridge2(config-vlan)#vlan 200-205 bridge 1 state enable	Create VLAN 200-205 on bridge 1
Bridge2(config-vlan)#interface po1	Configure lag interface po1
Bridge2(config-if)#switchport	Configure po1 as a layer 2 port
Bridge2(config-if)#bridge-group 1	Configure interface in bridge group 1
Bridge2(config-if)#bridge-group 1 spanning-tree disable	Disable spanning tree for bridge group 1 on that interface
Bridge2(config-if)#switchport mode trunk	Configure port as trunk port
Bridge2(config-if)#switchport trunk allowed vlan add 200-205	Allow vlan 200-205 on po1 interface
Bridge2(config-if)#interface po2	Configure lag interface po2
Bridge2(config-if)#switchport	Configure po2 as a layer 2 port
Bridge2(config-if)#bridge-group 1	Configure interface in bridge group 1
Bridge2(config-if)#bridge-group 1 spanning-tree disable	Disable spanning tree for bridge group 1 on that interface
Bridge2(config-if)#switchport mode trunk	Configure port as trunk port
Bridge2(config-if)#switchport trunk allowed vlan add 200-205	Allow vlan 200-205 on po2 interface
Bridge2(config-if)#interface xe8	Configure interface xe8
Bridge2(config-if)#channel-group 1 mode active	Configure xe8 as part of po1
Bridge2(config-if)#interface xe9	Configure interface xe9

Bridge2(config-if)#channel-group 1 mode active	Configure xe9 as part of po1
Bridge2(config-if)#interface xe3	Configure interface xe3
Bridge2(config-if)#channel-group 2 mode active	Configure xe3 as part of po2
Bridge2(config-if)#interface xe4	Configure interface xe4
Bridge2(config-if)#channel-group 2 mode active	Configure xe4 as part of po2
Bridge2(config-if)#ethernet cfm domain-type character-string domain-name nod12 level 7 mip-creation none	Create cfm domain with type as character string with name nod12 and set mip creation criteria to default with level 7
Bridge2(config-ether-cfm)#service ma-type string ma-name 43982	Create ma type as string with name 43982
Bridge2(config-ether-cfm-ma)# vlan 200 bridge 1	Add VLAN 200
Bridge2(config-ether-cfm-ma)#mip-creation none	Set mip-creation creation criteria to none
Bridge2(config-ether-cfm-ma)#ethernet cfm mep down mpid 21 active true po1	Create down mep 21 for po1 interface
Bridge2(config-ether-cfm-ma-mep)#cc multicast state enable	Enable cc multicast
Bridge2(config-ether-cfm-ma-mep)#exit-ether-ma-mep-mode	Exit ethernet cfm ma-mep mode
Bridge2(config-ether-cfm-ma)#mep crosscheck mpid 12	Configure crosscheck to remote MEP with value 12
Bridge2(config-ether-cfm-ma)#cc interval 100ms	Enable CC interval with 100ms
Bridge2(config-ether-cfm-ma)#exit-ether-ma-mode	Exit Ethernet ma mode
Bridge2(config-ether-cfm)#ethernet cfm domain-type character-string domain-name nod23 level 7 mip-creation none	Create cfm domain with type as character string with name nod23 and set mip creation criteria to default with level 7
Bridge2(config-ether-cfm)#service ma-type string ma-name 43982	Create ma type as string with name 43982
Bridge2(config-ether-cfm-ma)# vlan 200 bridge 1	Add VLAN 200
Bridge2(config-ether-cfm-ma)#mip-creation none	Set mip-creation creation criteria to none
Bridge2(config-ether-cfm-ma)#ethernet cfm mep down mpid 23 active true po2	Create down mep 23 for po2 interface
Bridge2(config-ether-cfm-ma-mep)#cc multicast state enable	Enable cc multicast
Bridge2(config-ether-cfm-ma-mep)#exit-ether-ma-mep-mode	Exit ethernet cfm ma-mep mode
Bridge2(config-ether-cfm-ma)#mep crosscheck mpid 32	Configure crosscheck to remote MEP with value 32
Bridge2(config-ether-cfm-ma)#cc interval 100ms	Enable CC interval with 100ms
Bridge2(config-ether-cfm-ma)#exit-ether-ma-mode	Exit Ethernet ma mode

Bridge2(config-ether-cfm)#g8032 ring lagring	Create g8032 ring with name lagring
Bridge2(g8032-ring-config)#east-interface po1	Associate po1 interface as east-interface
Bridge2(g8032-ring-config)#west-interface po2	Associate po2 interface as west-interface
Bridge2(g8032-ring-config)#g8032 profile profile1	Create g8032 profile with profile name profile1
Bridge2(g8032-profile-config)#timer wait-to-restore 1	Configure wait to restore time as 1 min
Bridge2(g8032-profile-config)#timer hold-off 0	Configure hold-off timer value as 0
Bridge2(g8032-profile-config)#timer guard-timer 10	Configure guard-timer value as 10ms
Bridge2(g8032-profile-config)#switching mode revertive	Configure Switching mode as revertive Switching mode
Bridge2(g8032-profile-config)#g8032 erp-instance erp1	Create g8032 erp instance erp1
Bridge2(g8032-config-switch)#ring lagring	Associate ring lagring to erp1 instance
Bridge2(g8032-config-switch)#rpl role non-owner	Configure the node as non-owner node
Bridge2(g8032-config-switch)#g8032-profile profile1	Associate Profile profile1 to erp1 instance
Bridge2(g8032-config-switch)#aps-channel level 7	Configure level as 7
Bridge2(g8032-config-switch)#aps-channel vlan 200	Configure RAPS channel vlan as 200
Bridge2(g8032-config-switch)#data van 201-205	Configure traffic vlan from 201-205
Bridge2(g8032-config-switch)#ring-id 1	Configure ring-id as 1
Bridge2(g8032-config-switch)#commit	Commit the candidate configuration to the running configuration
Bridge2(g8032-config-switch)#end	Exit g8032 erp instance mode

### Bridge 3

Bridge3#config term	Enter configuration mode
Bridge3(config)#bridge 1 protocol rstp vlan-bridge	Create bridge 1 as an RSTP VLAN-aware bridge.
Bridge3(config)#hardware-profile filter cfm-domain-name-str enable	Enable CFM domain name as string
Bridge1(config)#vlan database	Configure VLAN database
Bridge3(config-vlan)#vlan 200-205 bridge 1 state enable	Create VLAN 200-205 on bridge 1
Bridge3(config-vlan)#interface po2	Configure lag interface po2
Bridge3(config-if)#switchport	Configure po2 as a layer 2 port
Bridge3(config-if)#bridge-group 1	Configure interface in bridge group 1

Bridge3(config-if)#bridge-group 1 spanning-tree disable	Disable spanning tree for bridge group 1 on that interface
Bridge3(config-if)#switchport mode trunk	Configure port as trunk port
Bridge3(config-if)#switchport trunk allowed vlan add 200-205	Allow vlan 200-205 on po2 interface
Bridge3(config-if)#interface po3	Configure lag interface po3
Bridge3(config-if)#switchport	Configure po3 as a layer 2 port
Bridge3(config-if)#bridge-group 1	Configure interface in bridge group 1
Bridge3(config-if)#bridge-group 1 spanning-tree disable	Disable spanning tree for bridge group 1 on that interface
Bridge3(config-if)#switchport mode trunk	Configure port as trunk port
Bridge3(config-if)#switchport trunk allowed vlan add 200-205	Allow vlan 200-205 on po3 interface
Bridge3(config-if)#interface xe3	Configure interface xe3
Bridge3(config-if)#channel-group 2 mode active	Configure xe3 as part of po2
Bridge3(config-if)#interface xe4	Configure interface xe4
Bridge3(config-if)#channel-group 2 mode active	Configure xe4 as part of po2
Bridge3(config-if)#interface xe15	Configure interface xe3
Bridge3(config-if)#channel-group 3 mode active	Configure xe3 as part of po3
Bridge3(config-if)#interface xe16	Configure interface xe16
Bridge3(config-if)#channel-group 3 mode active	Configure xe16 as part of po3
Bridge3(config-if)#ethernet cfm domain-type character-string domain-name nod23 level 7 mip-creation none	Create cfm domain with type as character string with name nod23 and set mip creation criteria to default with level 7
Bridge3(config-ether-cfm)#service ma-type string ma-name 43982	Create ma type as string with name 43982
Bridge3(config-ether-cfm-ma)# vlan 200 bridge 1	Add VLAN 200
Bridge3(config-ether-cfm-ma)#mip-creation none	Set mip-creation creation criteria to none
Bridge3(config-ether-cfm-ma)#ethernet cfm mep down mpid 32 active true po2	Create down mep 32 for po2 interface
Bridge3(config-ether-cfm-ma-mep)#cc multicast state enable	Enable cc multicast
Bridge3(config-ether-cfm-ma-mep)#exit-ether-ma-mep-mode	Exit ethernet cfm ma-mep mode
Bridge3(config-ether-cfm-ma)#mep crosscheck mpid 23	Configure crosscheck to remote MEP with value 23
Bridge3(config-ether-cfm-ma)#cc interval 100ms	Enable CC interval with 100ms
Bridge3(config-ether-cfm-ma)#exit-ether-ma-mode	Exit Ethernet ma mode



Bridge3(config-ether-cfm)#ethernet cfm domain-type character-string domain-name nod34 level 7 mip-creation none	Create cfm domain with type as character string with name nod34 and set mip creation criteria to default with level 7
Bridge3(config-ether-cfm)#service ma-type string ma-name 43982	Create ma type as string with name 43982
Bridge3(config-ether-cfm-ma)# vlan 200 bridge 1	Add VLAN 200
Bridge3(config-ether-cfm-ma)#mip-creation none	Set mip-creation creation criteria to none
Bridge3(config-ether-cfm-ma)#ethernet cfm mep down mpid 34 active true po3	Create down mep 34 for po3 interface
Bridge3(config-ether-cfm-ma-mep)#cc multicast state enable	Enable cc multicast
Bridge3(config-ether-cfm-ma-mep)#exit-ether-ma-mep-mode	Exit ethernet cfm ma-mep mode
Bridge3(config-ether-cfm-ma)#mep crosscheck mpid 43	Configure crosscheck to remote MEP with value 43
Bridge3(config-ether-cfm-ma)#cc interval 100ms	Enable CC interval with 100ms
Bridge3(config-ether-cfm-ma)#exit-ether-ma-mode	Exit Ethernet ma mode
Bridge3(config-ether-cfm)#g8032 ring lagring	Create g8032 physical ring with name lagring
Bridge3(g8032-ring-config)#east-interface po2	Associate po2 interface as east-interface
Bridge3(g8032-ring-config)#west-interface po3	Associate po3 interface as west-interface
Bridge3(g8032-ring-config)#g8032 profile profile1	Create g8032 profile with profile name profile1
Bridge3(g8032-profile-config)#timer wait-to-restore 1	Configure wait to restore time as 1 min
Bridge3(g8032-profile-config)#timer hold-off 0	Configure hold-off timer value as 0
Bridge3(g8032-profile-config)#timer guard-timer 10	Configure guard-timer value as 10ms
Bridge3(g8032-profile-config)#switching mode revertive	Configure Switching mode as revertive Switching mode
Bridge3(g8032-profile-config)#g8032 erp-instance erp1	Create g8032 erp instance erp1
Bridge3(g8032-config-switch)#ring lagring	Associate ring lagring to erp1 instance
Bridge3(g8032-config-switch)#rpl role neighbor west-interface	Configure the node as neighbor node on west interface
Bridge3(g8032-config-switch)#g8032-profile profile1	Associate Profile profile1 to erp1 instance
Bridge3(g8032-config-switch)#aps-channel level 7	Configure level as 7
Bridge3(g8032-config-switch)#aps-channel vlan 200	Configure RAPS channel vlan as 200
Bridge3(g8032-config-switch)#data vlan 201-205	Configure traffic vlan from 201-205

Bridge3(g8032-config-switch)#ring-id 1	Configure ring-id as 1
Bridge3(g8032-config-switch)#commit	Commit the candidate configuration to the running configuration
Bridge3(g8032-config-switch)#end	Exit g8032 erp instance mode

## Bridge 4

Bridge4#config term	Enter configure mode
Bridge4(config)#bridge 1 protocol rstp vlan-bridge	Create bridge 1 as an RSTP VLAN-aware bridge.
Bridge4(config)#hardware-profile filter cfm-domain-name-str enable	Enable CFM domain name as string
Bridge1(config)#vlan database	Configure VLAN database
Bridge4(config-vlan)#vlan 200-205 bridge 1 state enable	Create VLAN 200-205 on bridge 1
Bridge4(config-vlan)#interface po3	Configure lag interface po3
Bridge4(config-if)#switchport	Configure po3 as a layer 2 port
Bridge4(config-if)#bridge-group 1	Configure interface in bridge group 1
Bridge4(config-if)#bridge-group 1 spanning- tree disable	Disable spanning tree for bridge group 1 on that interface
Bridge4(config-if)#switchport mode trunk	Configure port as trunk port
Bridge4(config-if)#switchport trunk allowed vlan add 200-205	Allow vlan 200-205 on po3 interface
Bridge4(config-if)#interface po4	Configure lag interface po4
Bridge4(config-if)#switchport	Configure po4 as a layer 2 port
Bridge4(config-if)#bridge-group 1	Configure interface in bridge group 1
Bridge4(config-if)#bridge-group 1 spanning- tree disable	Disable spanning tree for bridge group 1 on that interface
Bridge4(config-if)#switchport mode trunk	Configure port as trunk port
Bridge4(config-if)#switchport trunk allowed vlan add 200-205	Allow vlan 200-205 on po4 interface
Bridge4(config-if)#interface po5	Configure lag interface po5
Bridge4(config-if)#switchport	Configure po5 as a layer 2 port
Bridge4(config-if)#bridge-group 1	Configure interface in bridge group 1
Bridge4(config-if)#bridge-group 1 spanning- tree disable	Disable spanning tree for bridge group 1 on that interface
Bridge4(config-if)#switchport mode trunk	Configure port as trunk port
Bridge4(config-if)#switchport trunk allowed vlan add 200-205	Allow vlan 200-205 on po5 interface
Bridge4(config-if)#interface xe6	Configure interface xe6
Bridge4(config-if)#channel-group 4 mode active	Configure xe6 as part of po4
Bridge4(config-if)#interface xe7	Configure interface xe7
Bridge4(config-if)#channel-group 4 mode active	Configure xe7 as part of po4
Bridge4(config-if)#interface xe10	Configure interface xe10

Bridge4 (config-if) #channel-group 5 mode active	Configure xe10 as part of po5
Bridge4 (config-if) #interface xe11	Configure interface xe11
Bridge4 (config-if) #channel-group 5 mode active	Configure xe11 as part of po5
Bridge4 (config-if) #interface xe15	Configure interface xe15
Bridge4 (config-if) #channel-group 3 mode active	Configure xe15 as part of po3
Bridge4 (config-if) #interface xe16	Configure interface xe16
Bridge4 (config-if) #channel-group 3 mode active	Configure xe16 as part of po3
Bridge4 (config-if) #ethernet cfm domain-type character-string domain-name nod34 level 7 mip-creation none	Create cfm domain with type as character string with name nod34 and set mip creation criteria to default with level 7
Bridge4 (config-ether-cfm) #service ma-type string ma-name 43982	Create ma type as string with name 43982
Bridge4 (config-ether-cfm-ma) # vlan 200 bridge 1	Add VLAN 200
Bridge4 (config-ether-cfm-ma) #mip-creation none	Set mip-creation creation criteria to none
Bridge4 (config-ether-cfm-ma) #ethernet cfm mep down mpid 43 active true po3	Create down mep 43 for po3 interface
Bridge4 (config-ether-cfm-ma-mep) #cc multicast state enable	Enable cc multicast
Bridge4 (config-ether-cfm-ma-mep) #exit-ether-ma-mep-mode	Exit ethernet cfm ma-mep mode
Bridge4 (config-ether-cfm-ma) #mep crosscheck mpid 34	Configure crosscheck to remote MEP with value 34
Bridge4 (config-ether-cfm-ma) #cc interval 100ms	Enable CC interval with 100ms
Bridge4 (config-ether-cfm-ma) #exit-ether-ma-mode	Exit Ethernet ma mode
Bridge4 (config-ether-cfm) #ethernet cfm domain-type character-string domain-name nod41 level 7 mip-creation none	Create cfm domain with type as character string with name nod41 and set mip creation criteria to default with level 7
Bridge4 (config-ether-cfm) #service ma-type string ma-name 43982	Create ma type as string with name 43982
Bridge4 (config-ether-cfm-ma) # vlan 200 bridge 1	Add VLAN 200
Bridge4 (config-ether-cfm-ma) #mip-creation none	Set mip-creation creation criteria to none
Bridge4 (config-ether-cfm-ma) #ethernet cfm mep down mpid 41 active true po4	Create down mep 41 for po4 interface
Bridge4 (config-ether-cfm-ma-mep) #cc multicast state enable	Enable cc multicast
Bridge4 (config-ether-cfm-ma-mep) #exit-ether-ma-mep-mode	Exit ethernet cfm ma-mep mode
Bridge4 (config-ether-cfm-ma) #mep crosscheck mpid 14	Configure crosscheck to remote MEP with value 14

Bridge4 (config-ether-cfm-ma) #cc interval 100ms	Enable CC interval with 100ms
Bridge4 (config-ether-cfm-ma) #exit-ether-ma-mode	Exit Ethernet ma mode
Bridge4 (config-ether-cfm) #ethernet cfm domain-type character-string domain-name nod45 level 7 mip-creation none	Create cfm domain with type as character string with name nod45 and set mip creation criteria to default with level 7
Bridge4 (config-ether-cfm) #service ma-type string ma-name 43982	Create ma type as string with name 43982
Bridge4 (config-ether-cfm-ma) # vlan 200 bridge 1	Add VLAN 200
Bridge4 (config-ether-cfm-ma) #mip-creation none	Set mip-creation creation criteria to none
Bridge4 (config-ether-cfm-ma) #ethernet cfm mep down mpid 54 active true po5	Create down mep 54 for po5 interface
Bridge4 (config-ether-cfm-ma-mep) #cc multicast state enable	Enable cc multicast
Bridge4 (config-ether-cfm-ma-mep) #exit-ether-ma-mep-mode	Exit ethernet cfm ma-mep mode
Bridge4 (config-ether-cfm-ma) #mep crosscheck mpid 45	Configure crosscheck to remote MEP with value 45
Bridge4 (config-ether-cfm-ma) #cc interval 100ms	Enable CC interval with 100ms
Bridge4 (config-ether-cfm-ma) #exit-ether-ma-mode	Exit Ethernet ma mode
Bridge4 (config-ether-cfm) #g8032 ring lagring	Create g8032 ring with name lagring
Bridge4 (g8032-ring-config) #east-interface po3	Associate po3 interface as east-interface
Bridge4 (g8032-ring-config) #west-interface po4	Associate po4 interface as west-interface
Bridge4 (g8032-ring-config) #g8032 ring lagsubring	Create g8032 ring with name lagsubring
Bridge4 (g8032-ring-config) #east-interface po5	Associate po5 interface as east-interface
Bridge4 (g8032-ring-config) #g8032 profile profile1	Create g8032 profile with profile name profile1
Bridge4 (g8032-profile-config) #timer wait-to-restore 1	Configure wait to restore time as 1 min
Bridge4 (g8032-profile-config) #timer hold-off 0	Configure hold-off timer value as 0
Bridge4 (g8032-profile-config) #timer guard-timer 10	Configure guard-timer value as 10ms
Bridge4 (g8032-profile-config) #switching mode revertive	Configure Switching mode as revertive Switching mode
Bridge4 (g8032-profile-config) #g8032 erp-instance erp1	Create g8032 erp instance erp1
Bridge4 (g8032-config-switch) #ring lagring	Associate ring lagring to erp1 instance
Bridge4 (g8032-config-switch) #rpl role owner east-interface	Configure the node as owner node on east interface

Bridge4(g8032-config-switch)#g8032-profile profile1	Associate Profile profile1 to erp1 instance
Bridge4(g8032-config-switch)#aps-channel level 7	Configure level as 7
Bridge4(g8032-config-switch)#aps-channel vlan 200	Configure RAPS channel vlan as 200
Bridge4(g8032-config-switch)#data vlan 201-205	Configure traffic vlan from 201-205
Bridge4(g8032-config-switch)#ring-id 1	Configure ring-id as 1
Bridge4(g8032-config-switch)#g8032 erp-instance erp2	Create g8032 erp instance erp2
Bridge4(g8032-config-switch)#ring-type sub-ring	Configure ring-type as sub-ring
Bridge4(g8032-config-switch)#ring lagsubring	Associate ring lagsubring to erp2 instance
Bridge4(g8032-config-switch)#rpl role non-owner	Configure the node as neighbor node on east interface
Bridge4(g8032-config-switch)#g8032-profile profile1	Associate Profile profile1 to erp2 instance
Bridge4(g8032-config-switch)#aps-channel level 7	Configure level as 7
Bridge4(g8032-config-switch)#aps-channel vlan 200	Configure RAPS channel vlan as 200
Bridge4(g8032-config-switch)#data vlan 201-205	Configure traffic vlan from 201-205
Bridge4(g8032-config-switch)#ring-id 2	Configure ring-id as 2
Bridge4(g8032-config-switch)#non-virtual-channel	Enable Non Virtual Channel
Bridge4(g8032-config-switch)# enable-tcn-propagation	Enable tcn propagation
Bridge4(g8032-config-switch)# tcn-to-instance erp1	Attach erp1 instance to erp2 instance to notify any changes in subring to major ring
Bridge4(g8032-config-switch)#commit	Commit the candidate configuration to the running configuration
Bridge4(g8032-config-switch)#end	Exit g8032 erp instance mode

## Bridge 5

Bridge5#config term	Enter config mode
Bridge5(config)#bridge 1 protocol rstp vlan-bridge	Create bridge 1 as an RSTP VLAN-aware bridge.
Bridge5(config)#hardware-profile filter cfm-domain-name-str enable	Enable CFM domain name as string
Bridge1(config)#vlan database	Configure VLAN database
Bridge5(config-vlan)#vlan 200-205 bridge 1 state enable	Create VLAN 200-205 on bridge 1
Bridge5(config-vlan)#interface po5	Configure lag interface po5
Bridge5(config-if)#switchport	Configure po5 as a layer 2 port

Bridge5(config-if)#bridge-group 1	Configure interface in bridge group 1
Bridge5(config-if)#bridge-group 1 spanning-tree disable	Disable spanning tree for bridge group 1 on that interface
Bridge5(config-if)#switchport mode trunk	Configure port as trunk port
Bridge5(config-if)#switchport trunk allowed vlan add 200-205	Allow vlan 200-205 on po3 interface
Bridge5(config-if)#interface po6	Configure lag interface po3
Bridge5(config-if)#switchport	Configure po3 as a layer 2 port
Bridge5(config-if)#bridge-group 1	Configure interface in bridge group 1
Bridge5(config-if)#bridge-group 1 spanning-tree disable	Disable spanning tree for bridge group 1 on that interface
Bridge5(config-if)#switchport mode trunk	Configure port as trunk port
Bridge5(config-if)#switchport trunk allowed vlan add 200-205	Allow vlan 200-205 on po3 interface
Bridge5(config-if)#interface xe1	Configure interface xe1
Bridge5(config-if)#channel-group 6 mode active	Configure xe1 as part of po6
Bridge5(config-if)#interface xe2	Configure interface xe2
Bridge5(config-if)#channel-group 6 mode active	Configure xe2 as part of po6
Bridge5(config-if)#interface xe10	Configure interface xe10
Bridge5(config-if)#channel-group 5 mode active	Configure xe10 as part of po5
Bridge5(config-if)#interface xe11	Configure interface xe11
Bridge5(config-if)#channel-group 5 mode active	Configure xe11 as part of po5
Bridge5(config-if)#ethernet cfm domain-type character-string domain-name nod15 level 7 mip-creation none	Create cfm domain with type as character string with name nod15 and set mip creation criteria to default with level 7
Bridge5(config-ether-cfm)#service ma-type string ma-name 43982	Create ma type as string with name 43982
Bridge5(config-ether-cfm-ma)# vlan 200 bridge 1	Add VLAN 200
Bridge5(config-ether-cfm-ma)#mip-creation none	Set mip-creation creation criteria to none
Bridge5(config-ether-cfm-ma)#ethernet cfm mep down mpid 15 active true po6	Create down mep 15 for po6 interface
Bridge5(config-ether-cfm-ma-mep)#cc multicast state enable	Enable cc multicast
Bridge5(config-ether-cfm-ma-mep)#exit-ether-ma-mep-mode	Exit ethernet cfm ma-mep mode
Bridge5(config-ether-cfm-ma)#mep crosscheck mpid 51	Configure crosscheck to remote MEP with value 51
Bridge5(config-ether-cfm-ma)#cc interval 100ms	Enable CC interval with 100ms
Bridge5(config-ether-cfm-ma)#exit-ether-ma-mode	Exit Ethernet ma mode

Bridge5(config-ether-cfm)#ethernet cfm domain-type character-string domain-name nod45 level 7 mip-creation none	Create cfm domain with type as character string with name nod45 and set mip creation criteria to default with level 7
Bridge5(config-ether-cfm)#service ma-type string ma-name 43982	Create ma type as string with name 43982
Bridge5(config-ether-cfm-ma)# vlan 200 bridge 1	Add VLAN 200
Bridge5(config-ether-cfm-ma)#mip-creation none	Set mip-creation criteria to none
Bridge5(config-ether-cfm-ma)#ethernet cfm mep down mpid 45 active true po5	Create down mep 45 for po5 interface
Bridge5(config-ether-cfm-ma-mep)#cc multicast state enable	Enable cc multicast
Bridge5(config-ether-cfm-ma-mep)#exit-ether-ma-mep-mode	Exit ethernet cfm ma-mep mode
Bridge5(config-ether-cfm-ma)#mep crosscheck mpid 54	Configure crosscheck to remote MEP with value 54
Bridge5(config-ether-cfm-ma)#cc interval 100ms	Enable CC interval with 100ms
Bridge5(config-ether-cfm-ma)#exit-ether-ma-mode	Exit Ethernet ma mode
Bridge5(config-ether-cfm)#g8032 ring lagsubring	Create g8032 ring with name lagsubring
Bridge5(g8032-ring-config)#east-interface po5	Associate po5 interface as east-interface
Bridge5(g8032-ring-config)#west-interface po6	Associate po6 interface as west-interface
Bridge5(g8032-ring-config)#g8032 profile profile1	Create g8032 profile with profile name profile1
Bridge5(g8032-profile-config)#timer wait-to-restore 1	Configure wait to restore time as 1 min
Bridge5(g8032-profile-config)#timer hold-off 0	Configure hold-off timer value as 0
Bridge5(g8032-profile-config)#timer guard-timer 10	Configure guard-timer value as 10ms
Bridge5(g8032-profile-config)#switching mode revertive	Configure Switching mode as revertive Switching mode
Bridge5(g8032-profile-config)#g8032 erp-instance erp2	Create g8032 erp instance erp2
Bridge5(g8032-config-switch)#ring lagsubring	Associate Physical ring lagsubring to erp2 instance
Bridge5(g8032-config-switch)#ring-type subring	Configure ring-type as subring
Bridge5(g8032-config-switch)#rpl role owner west-interface	Configure the node as owner node on west interface
Bridge5(g8032-config-switch)#g8032-profile profile1	Associate Profile profile1 to erp2 instance
Bridge5(g8032-config-switch)#aps-channel level 7	Configure level as 7

Bridge5(g8032-config-switch)#aps-channel vlan 200	Configure RAPS channel vlan as 200
Bridge5(g8032-config-switch)#data vlan 201- 205	Configure traffic vlan from 201-205
Bridge5(g8032-config-switch)#ring-id 2	Configure ring-id as 2
Bridge5(g8032-config-switch)#commit	Commit the candidate configuration to the running configuration
Bridge5(g8032-config-switch)#end	Exit g8032 erp instance mode

## Validation

```

Bridgel#show g8032 erp-instance erp2
Inst Name       : erp2
Description     :
State          : G8032_ST_IDLE
Phy Ring       : lagsubring
Ring Type      : SUB-RING (NON VIRTUAL)
Role           : NEIGHBOR (EAST)
Node ID        : 3c:2c:99:26:e6:7b
-----
                        East Link           West Link
=====
Interface       : po6                     -
State          : Blocked                   -
Remote NodeId  : 6c:b9:c5:67:72:f6        -
Remote BPR     : 0                         -
Endpoint Info
-----
Domain Name    : nod15                     -
MEP ID        : 51                         -
MA Name       : 43982                       -
=====
TCN Propagation : Enabled
TCN Propagation List: erp1,

    Channel          |
  (LEVEL, VLAN, RING ID) |
=====
  (7,    200,    2)    |
=====

```

```

Bridgel#show g8032 erp-instance erp1

Inst Name       : erp
Description     :
State          : G8032_ST_IDLE
Phy Ring       : lagring
Ring Type      : MAJOR-RING
Role           : NON-OWNER
Node ID        : 3c:2c:99:26:e6:80
-----
                        East Link           West Link
=====
Interface       : po4                     po1

```



```

State           : Unblocked           Unblocked
Remote NodeId   : 34:17:eb:e4:af:10    -
Remote BPR      : 1                   -
Endpoint Info
-----

```

```

Domain Name     : nod41                nod12
MEP ID         : 14                   12
MA Name        : 43982                43982
=====

```

```

-----
Channel         |
(LABEL, VLAN, RING ID) |
=====
(7, 200, 1)   |
=====

```

```

DataTraffic vlan: 201-205
Profile : profile1

```

```

Bridge2#show g8032 erp-instance erp1

```

```

Description     :
State           : G8032_ST_IDLE
Phy Ring        : lagring
Ring Type       : MAJOR-RING
Role            : NON-OWNER
Node ID         : d8:9e:f3:5e:f8:29
-----

```

```

-----
                        East Link           West Link
=====
Interface           : po1                 po2
State               : Unblocked           Unblocked
Remote NodeId       : 34:17:eb:e4:af:10    -
Remote BPR          : 1                   -
Endpoint Info
-----
Domain Name         : nod12                nod23
MEP ID              : 21                   23
MA Name             : 43982                43982
=====

```

```

-----
Channel         |
(LABEL, VLAN, RING ID) |
=====
(7, 200, 1)   |
=====

```

```

DataTraffic vlan: 201-205
Profile : profile1

```

```

Bridge3#show g8032 erp-instance erp1

```

```

Inst Name        : erp1
Description      :
State           : G8032_ST_IDLE
Phy Ring        : lagring
Ring Type       : MAJOR-RING

```

Role : NEIGHBOR (WEST)  
 Node ID : 3c:2c:99:1a:da:7d

```

-----
                        East Link                West Link
=====
Interface       : po2                          po3
State           : Unblocked                    Blocked
Remote NodeId   : 34:17:eb:e4:af:10            34:17:eb:e4:af:10
Remote BPR      : 1                            1
Endpoint Info
-----
Domain Name     : nod23                        nod34
MEP ID         : 32                            34
MA Name        : 43982                        43982
=====
  
```

```

-----
Channel         |
(LABEL, VLAN, RING ID) |
=====
(7, 200, 1)    |
=====
  
```

DataTraffic vlan: 201-205  
 Profile : profile1

Bridge4#show g8032 erp-instance erp2

Inst Name : erp2  
 Description :  
 State : G8032\_ST\_IDLE  
 Phy Ring : lagsubring  
 Ring Type : SUB-RING (NON VIRTUAL)  
 Role : NON-OWNER  
 Node ID : 34:17:eb:e4:af:0b

```

-----
                        East Link                West Link
=====
Interface       : po5                          -
State           : Unblocked                    -
Remote NodeId   : 6c:b9:c5:67:72:f6            -
Remote BPR      : 0                            -
Endpoint Info
-----
Domain Name     : nod45                        -
MEP ID         : 54                            -
MA Name        : 43982                        -
=====
  
```

TCN Propagation : Enabled  
 TCN Propagation List: erp1,

```

-----
Channel         |
(LABEL, VLAN, RING ID) |
=====
(7, 200, 2)    |
=====
  
```

DataTraffic vlan: 201-205

Profile : profile1

Bridge4#show g8032 erp-instance erp1

```

Inst Name      : erp1
Description    :
State          : G8032_ST_IDLE
Phy Ring       : lagring
Ring Type      : MAJOR-RING
Role           : OWNER (EAST)
Node ID        : 34:17:eb:e4:af:10

```

```

-----
                        East Link                West Link
=====
Interface       : po3                          po4
State           : Blocked                      Unblocked
Remote NodeId   : -                          -
Remote BPR      : -                          -
Endpoint Info
-----
Domain Name     : nod34                        nod41
MEP ID          : 43                          41
MA Name         : 43982                       43982
=====

```

```

-----
Channel         |
(LABEL, VLAN, RING ID) |
=====
(7, 200, 1)    |
=====

```

DataTraffic vlan: 201-205

Profile : profile1

Bridge5#show g8032 erp-instance erp2

```

Inst Name      : erp2
Description    :
State          : G8032_ST_IDLE
Phy Ring       : lagsubring
Ring Type      : SUB-RING
Role           : OWNER (WEST)
Node ID        : 6c:b9:c5:67:72:f6

```

```

-----
                        East Link                West Link
=====
Interface       : po5                          po6
State           : Unblocked                    Blocked
Remote NodeId   : -                          -
Remote BPR      : -                          -
Endpoint Info
-----
Domain Name     : nod45                        nod15
MEP ID          : 45                          15
MA Name         : 43982                       43982
=====

```

```

      Channel      |
    (LEVEL, VLAN, RING ID) |
    =====
    (7,      200,   2)      |
    =====

```

```

DataTraffic vlan: 201-205
Profile : profile1

```

```

Bridge3#show g8032 erp-instance erp1

```

```

Inst Name       : erp1
Description     :
State           : G8032_ST_IDLE
Phy Ring        : lagring
Ring Type       : MAJOR-RING
Role            : NEIGHBOR (WEST)
Node ID         : 3c:2c:99:1a:da:7d

```

```

-----
                East Link                West Link
    =====
Interface       : po2                    po3
State           : Unblocked              Blocked
Remote NodeId   : 34:17:eb:e4:af:10      34:17:eb:e4:af:10
Remote BPR      : 1                      1
Endpoint Info
-----
Domain Name     : nod23                  nod34
MEP ID          : 32                    34
MA Name         : 43982                  43982
    =====

```

```

      Channel      |
    (LEVEL, VLAN, RING ID) |
    =====
    (7,      200,   1)      |
    =====

```

```

DataTraffic vlan: 201-205
Profile : profile1

```

---

## ERPS Managing Non-Data VLAN's

An Ethernet ring that is connected to a Major Ring at the Interconnection Nodes. Non-Bridged AC-VLAN's should follow the port state (block/forward) as ERPS data VLAN's.

User can give control for non-bridged AC\_Vlans by configuring "erps-instance <id|none>". In sub-interface, user can add "erps-instance (NAME | none)" CLI. This will exclude the sub-intf/lif's to be processed by ERPS.

Erps-instance <name>, this sub-interface will follow specified erps-instance state for non-data vlan's.

This is useful in case of multiple instances, where one instance is in forward and another is block. So non-data vlan's has to follow specific instance configured by user. Default is lower instance id, if not configured.

Erps-instance none, this sub-interface will not managed by ERPS. (It will be always in forward state with ERPS not controlling it).

No command specified in sub-intf mode, this sub-intf/lif will be managed by ERPS and default erps-instance id will be used for LIF/sub-intf to follow the ERPS block/forward state. Default value is lower configured instance-id

## Topology

displays a sample Ring Protection topology on which protection switching is configured with five bridges. This constitutes of one major ring (Bridge1, Bridge2, Bridge3, Bridge4 and Bridge 5) and MPLS/VPLS is running between Bridge4, Bridge5 and Bridge6)

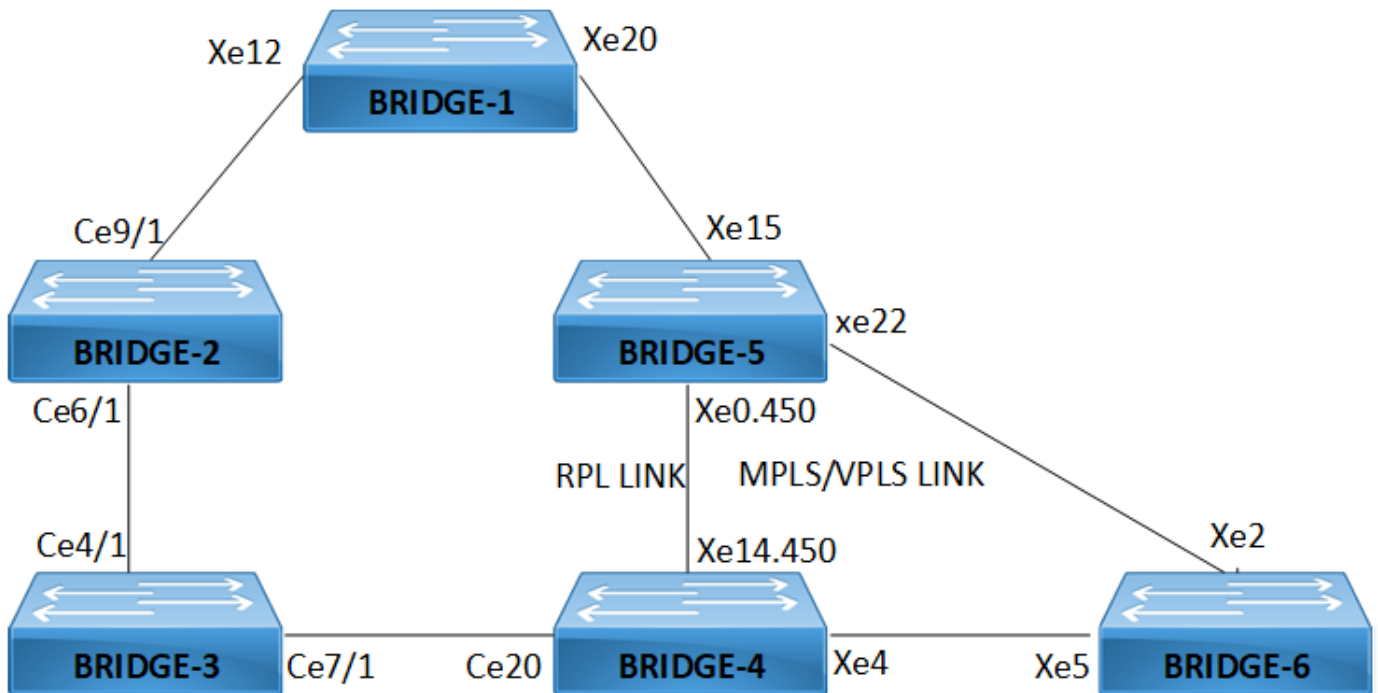

Figure 4-12: Major ring running both ERPS and MPLS/VPLS between Bridge-4 and Bridge-5.

### Bridge 1

Bridgel#configure terminal	Enter configure mode
Bridgel(config)#bridge 1 protocol rstp vlan-bridge	Create bridge 1 as an RSTP VLAN-aware bridge.
Bridgel(config)#hardware-profile filter cfm-domain-name-str enable	Enable CFM domain name as string
Bridgel(config)#vlan database	Configure VLAN database
Bridgel(config-vlan)# vlan 450 bridge 1 state enable	Create VLAN 450 on bridge 1
Bridgel(config-vlan)# vlan 900-1010 bridge 1 state enable	Create VLAN 900-1010 on bridge 1
Bridgel(config-vlan)#interface xe12	Configure interface xe12

Bridgel (config-if) #switchport	Configure xe12 as a layer 2 port
Bridgel (config-if) #bridge-group 1	Configure interface in bridge group 1
Bridgel (config-if) #bridge-group 1 spanning-tree disable	Disable spanning tree for bridge group 1 on that interface
Bridgel (config-if) #switchport mode trunk	Configure port as trunk port
Bridgel (config-if) #switchport trunk allowed vlan add 450,900-1010	Allow vlan 450,900-1010 on xe12 interface
Bridgel (config-if) #interface xe20	Configure interface xe20
Bridgel (config-if) #switchport	Configure xe20 as a layer 2 port
Bridgel (config-if) #bridge-group 1	Configure interface in bridge group 1
Bridgel (config-if) #bridge-group 1 spanning-tree disable	Disable spanning tree for bridge group 1 on that interface
Bridgel (config-if) #switchport mode trunk	Configure port as trunk port
Bridgel (config-if) #switchport trunk allowed vlan add 450,900-1010	Allow vlan 450,900-1010 on xe20 interface
Bridgel (config-if) #interface xe24	Configure interface xe24
Bridgel (config-if) #switchport	Configure xe24 as a layer 2 port
Bridgel (config-if) #bridge-group 1	Configure interface in bridge group 1
Bridgel (config-if) #bridge-group 1 spanning-tree disable	Disable spanning tree for bridge group 1 on that interface
Bridgel (config-if) #switchport mode trunk	Configure port as trunk port
Bridgel (config-if) #switchport trunk allowed vlan add 450,900-1010	Allow vlan 450,900-1010 on xe24 interface
Bridgel (config-if) # ethernet cfm domain- type character-string domain-name mdna1 level 7 mip-creation default	Create cfm domain with type as character string with name mdna1 and set MIP creation criteria to default with level 7
Bridgel (config-ether-cfm) #service ma-type string ma-name n27	Create MA type as string with name n27
Bridgel (config-ether-cfm-ma) # vlan 900 bridge 1	Add VLAN 900
Bridgel (config-ether-cfm-ma) # mip-creation default	Set MIP-creation criteria to default
Bridgel (config-ether-cfm-ma) # ethernet cfm mep down mpid 2027 active true xe12	Create down MEP 2027 for xe12 interface
Bridgel (config-ether-cfm-ma-mep) #cc multicast state enable	Enable CC multicast
Bridgel (config-ether-cfm-ma-mep) #exit- ether-ma-mep-mode	Exit ethernet CFM MA-MEP mode
Bridgel (config-ether-cfm-ma) #mep crosscheck mpid 27	Configure crosscheck to remote MEP with value 27

Bridgel (config-ether-cfm-ma) #cc interval 10s	Enable cc interval with 10s
Bridgel (config-ether-cfm-ma) # exit-ether-ma-mode	Exit Ethernet ma mode
Bridgel (config-if) # ethernet cfm domain-type character-string domain-name mdna2 level 7 mip-creation default	Create cfm domain with type as character string with name mdna2 and set MIP creation criteria to default with level 7
Bridgel (config-ether-cfm) #service ma-type string ma-name n27	Create MA type as string with name n27
Bridgel (config-ether-cfm-ma) # vlan 900 bridge 1	Add VLAN 900
Bridgel (config-ether-cfm-ma) # mip-creation default	Set MIP-creation criteria to default
Bridgel (config-ether-cfm-ma) # ethernet cfm mep down mpid 3037 active true xe20	Create down MEP 3037 for xe20 interface
Bridgel (config-ether-cfm-ma-mep) #cc multicast state enable	Enable CC multicast
Bridgel (config-ether-cfm-ma-mep) #exit-ether-ma-mep-mode	Exit ethernet CFM MA-MEP mode
Bridgel (config-ether-cfm-ma) #mep crosscheck mpid 37	Configure crosscheck to remote MEP with value 37
Bridgel (config-ether-cfm-ma) #cc interval 10s	Enable cc interval with 10s
Bridgel (config-ether-cfm-ma) # exit-ether-ma-mode	Exit Ethernet ma mode
Bridgel (config-ether-cfm) #g8032 ring RING1	Create g8032 ring with name RING1
Bridgel (g8032-ring-config) #east-interface xe20	Associate xe20 interface as east-interface
Bridgel (g8032-ring-config) #west-interface xe12	Associate xe12 interface as west-interface
Bridgel (g8032-ring-config) #g8032 profile profile1	Create g8032 profile with profile name profile1
Bridgel (g8032-profile-config) #timer wait-to-restore 1	Configure wait to restore time as 1 min
Bridgel (g8032-profile-config) #timer hold-off 0	Configure hold-off timer value as 0
Bridgel (g8032-profile-config) #timer guard-timer 10	Configure guard-timer value as 10ms
Bridgel (g8032-profile-config) #switching mode revertive	Configure Switching mode as revertive Switching mode
Bridgel (g8032-profile-config) #g8032 erp-instance erp1	Create g8032 erp instance erp1

Bridge1(g8032-config-switch)#ring RING1	Associate ring RING1 to erp1 instance
Bridge1(g8032-config-switch)#rpl role non-owner	Configure the node as non-owner node
Bridge1(g8032-config-switch)#g8032-profile profile1	Associate Profile profile1 to erp1 instance
Bridge1(g8032-config-switch)#aps-channel level 7	Configure level as 7
Bridge1(g8032-config-switch)#aps-channel vlan 900	Configure RAPS channel vlan as 900
Bridge1(g8032-config-switch)#data vlan 950	Configure traffic vlan 950
Bridge1(g8032-config-switch)#ring-id 1	Configure ring-id as 1
Bridge1(g8032-config-switch)#commit	Commit the candidate configuration to the running configuration
Bridge1(g8032-config-switch)#end	Exit g8032 erp instance mode

## Bridge 2

Bridge2#configure terminal	Enter configure mode
Bridge2(config)#bridge 1 protocol rstp vlan-bridge	Create bridge 1 as an RSTP VLAN-aware bridge.
Bridge2(config)#hardware-profile filter cfm-domain-name-str enable	Enable CFM domain name as string
Bridge2(config)#vlan database	Configure VLAN database
Bridge2(config-vlan)# vlan 450 bridge 1 state enable	Create VLAN 450 on bridge 1
Bridge2(config-vlan)# vlan 900-1010 bridge 1 state enable	Create VLAN 900-1010 on bridge 1
Bridge2(config-vlan)#interface ce9/1	Configure interface ce9/1
Bridge2(config-if)#switchport	Configure ce9/1 as a layer 2 port
Bridge2(config-if)#bridge-group 1	Configure interface in bridge group 1
Bridge2(config-if)#bridge-group 1 spanning-tree disable	Disable spanning tree for bridge group 1 on that interface
Bridge2(config-if)#switchport mode trunk	Configure port as trunk port
Bridge2(config-if)#switchport trunk allowed vlan add 450,900-1010	Allow vlan 450,900-1010 on ce9/1 interface
Bridge2(config-if)#interface ce6/1	Configure interface ce6/1
Bridge2(config-if)#switchport	Configure ce6/1 as a layer 2 port
Bridge2(config-if)#bridge-group 1	Configure interface in bridge group 1
Bridge2(config-if)#bridge-group 1 spanning-tree disable	Disable spanning tree for bridge group 1 on that interface
Bridge2(config-if)#switchport mode trunk	Configure port as trunk port



Bridge2(config-if)#switchport trunk allowed vlan add 450,900-1010	Allow vlan 450,900-1010 on ce6/1 interface
Bridge2(config-if)# ethernet cfm domain- type character-string domain-name mdna1 level 7 mip-creation default	Create cfm domain with type as character string with name mdna1 and set MIP creation criteria to default with level 7
Bridge2(config-ether-cfm)#service ma-type string ma-name n27	Create MA type as string with name n27
Bridge2(config-ether-cfm-ma)# vlan 900 bridge 1	Add VLAN 900
Bridge2(config-ether-cfm-ma)# mip-creation default	Set MIP-creation criteria to default
Bridge2(config-ether-cfm-ma)# ethernet cfm mep down mpid 27 active true ce9/1	Create down MEP 27 for ce9/1 interface
Bridge2(config-ether-cfm-ma-mep)#cc multicast state enable	Enable CC multicast
Bridge2(config-ether-cfm-ma-mep)#exit- ether-ma-mep-mode	Exit ethernet CFM MA-MEP mode
Bridge2(config-ether-cfm-ma)#mep crosscheck mpid 2027	Configure crosscheck to remote MEP with value 2027
Bridge2(config-ether-cfm-ma)#cc interval 10s	Enable cc interval with 10s
Bridge2(config-ether-cfm-ma)# exit-ether- ma-mode	Exit Ethernet ma mode
Bridge2(config-if)# ethernet cfm domain- type character-string domain-name mdna5 level 7 mip-creation default	Create cfm domain with type as character string with name mdna5 and set MIP creation criteria to default with level 7
Bridge2(config-ether-cfm)#service ma-type string ma-name n27	Create MA type as string with name n27
Bridge2(config-ether-cfm-ma)# vlan 900 bridge 1	Add VLAN 900
Bridge2(config-ether-cfm-ma)# mip-creation default	Set MIP-creation criteria to default
Bridge2(config-ether-cfm-ma)# ethernet cfm mep down mpid 6067 active true ce6/1	Create down MEP 3037 for xe20 interface
Bridge2(config-ether-cfm-ma-mep)#cc multicast state enable	Enable CC multicast
Bridge2(config-ether-cfm-ma-mep)#exit- ether-ma-mep-mode	Exit ethernet CFM MA-MEP mode
Bridge2(config-ether-cfm-ma)#mep crosscheck mpid 67	Configure crosscheck to remote MEP with value 67

Bridge2 (config-ether-cfm-ma) #cc interval 10s	Enable cc interval with 10s
Bridge2 (config-ether-cfm-ma) # exit-ether-ma-mode	Exit Ethernet ma mode
Bridge2 (config-ether-cfm) #g8032 ring RING1	Create g8032 ring with name RING1 on bridge 1
Bridge2 (g8032-ring-config) #east-interface ce9/1	Associate ce9/1 interface as east-interface
Bridge2 (g8032-ring-config) #west-interface ce6/1	Associate ce6/1 interface as west-interface
Bridge2 (g8032-ring-config) #g8032 profile profile1	Create g8032 profile with profile name profile1
Bridge2 (g8032-profile-config) #timer wait-to-restore 1	Configure wait to restore time as 1 min
Bridge2 (g8032-profile-config) #timer hold-off 0	Configure hold-off timer value as 0
Bridge2 (g8032-profile-config) #timer guard-timer 10	Configure guard-timer value as 10ms
Bridge2 (g8032-profile-config) #switching mode revertive	Configure Switching mode as revertive Switching mode
Bridge2 (g8032-profile-config) #g8032 erp-instance erp1	Create g8032 erp instance erp1
Bridge2 (g8032-config-switch) #ring RING1	Associate ring RING1 to erp1 instance
Bridge2 (g8032-config-switch) #rpl role non-owner	Configure the node as non-owner node
Bridge2 (g8032-config-switch) #g8032-profile profile1	Associate Profile profile1 to erp1 instance
Bridge2 (g8032-config-switch) #aps-channel level 7	Configure level as 7
Bridge2 (g8032-config-switch) #aps-channel vlan 900	Configure RAPS channel vlan as 900
Bridge2 (g8032-config-switch) #data vlan 950	Configure traffic vlan 950
Bridge2 (g8032-config-switch) #ring-id 1	Configure ring-id as 1
Bridge2 (g8032-config-switch) #commit	Commit the candidate configuration to the running configuration
Bridge2 (g8032-config-switch) #end	Exit g8032 erp instance mode

### Bridge 3

Bridge3#configure terminal	Enter configure mode
Bridge3(config) #bridge 1 protocol rstp vlan-bridge	Create bridge 1 as an RSTP VLAN-aware bridge.

Bridge3(config)#hardware-profile filter cfm-domain-name-str enable	Enable CFM domain name as string
Bridge3(config)#vlan database	Configure VLAN database
Bridge3(config-vlan)# vlan 450 bridge 1 state enable	Create VLAN 450 on bridge 1
Bridge3(config-vlan)# vlan 900-1010 bridge 1 state enable	Create VLAN 900-1010 on bridge 1
Bridge3(config-vlan)#interface ce4/1	Configure interface ce4/1
Bridge3(config-if)#switchport	Configure ce4/1 as a layer 2 port
Bridge3(config-if)#bridge-group 1	Configure interface in bridge group 1
Bridge3(config-if)#bridge-group 1 spanning-tree disable	Disable spanning tree for bridge group 1 on that interface
Bridge3(config-if)#switchport mode trunk	Configure port as trunk port
Bridge3(config-if)#switchport trunk allowed vlan add 450,900-1010	Allow vlan 450,900-1010 on ce4/1 interface
Bridge3(config-if)#interface ce7/1	Configure interface ce7/1
Bridge3(config-if)#switchport	Configure ce7/1 as a layer 2 port
Bridge3(config-if)#bridge-group 1	Configure interface in bridge group 1
Bridge3(config-if)#bridge-group 1 spanning-tree disable	Disable spanning tree for bridge group 1 on that interface
Bridge3(config-if)#switchport mode trunk	Configure port as trunk port
Bridge3(config-if)#switchport trunk allowed vlan add 450,900-1010	Allow vlan 450,900-1010 on ce7/1 interface
Bridge3(config-if)# ethernet cfm domain- type character-string domain-name mdna4 level 7 mip-creation default	Create cfm domain with type as character string with name mdna4 and set MIP creation criteria to default with level 7
Bridge3(config-ether-cfm)#service ma-type string ma-name n27	Create MA type as string with name n27
Bridge3(config-ether-cfm-ma)# vlan 900 bridge 1	Add VLAN 900
Bridge3(config-ether-cfm-ma)# mip-creation default	Set MIP-creation criteria to default
Bridge3(config-ether-cfm-ma)# ethernet cfm mep down mpid 5057 active true ce7/1	Create down MEP 5057 for ce7/1 interface
Bridge3(config-ether-cfm-ma-mep)#cc multicast state enable	Enable CC multicast
Bridge3(config-ether-cfm-ma-mep)#exit- ether-ma-mep-mode	Exit ethernet CFM MA-MEP mode
Bridge3(config-ether-cfm-ma)#mep crosscheck mpid 57	Configure crosscheck to remote MEP with value 57

Bridge3(config-ether-cfm-ma)#cc interval 10s	Enable cc interval with 10s
Bridge3(config-ether-cfm-ma)# exit-ether-ma-mode	Exit Ethernet ma mode
Bridge3(config-if)# ethernet cfm domain-type character-string domain-name mdna5 level 7 mip-creation default	Create cfm domain with type as character string with name mdna5 and set MIP creation criteria to default with level 7
Bridge3(config-ether-cfm)#service ma-type string ma-name n27	Create MA type as string with name n27
Bridge3(config-ether-cfm-ma)# vlan 900 bridge 1	Add VLAN 900
Bridge3(config-ether-cfm-ma)# mip-creation default	Set MIP-creation criteria to default
Bridge3(config-ether-cfm-ma)# ethernet cfm mep down mpid 67 active true ce4/1	Create down MEP 67 for ce4/1 interface
Bridge3(config-ether-cfm-ma-mep)#cc multicast state enable	Enable CC multicast
Bridge3(config-ether-cfm-ma-mep)#exit-ether-ma-mep-mode	Exit ethernet CFM MA-MEP mode
Bridge3(config-ether-cfm-ma)#mep crosscheck mpid 6067	Configure crosscheck to remote MEP with value 6067
Bridge3(config-ether-cfm-ma)#cc interval 10s	Enable cc interval with 10s
Bridge3(config-ether-cfm-ma)# exit-ether-ma-mode	Exit Ethernet ma mode
Bridge3(config-ether-cfm)#g8032 ring RING1	Create g8032 physical ring with name RING1
Bridge3(g8032-ring-config)#east-interface ce4/1	Associate ce4/1 interface as east-interface
Bridge3(g8032-ring-config)#west-interface ce7/1	Associate ce7/1 interface as west-interface
Bridge3(g8032-ring-config)#g8032 profile profile1	Create g8032 profile with profile name profile1
Bridge3(g8032-profile-config)#timer wait-to-restore 1	Configure wait to restore time as 1 min
Bridge3(g8032-profile-config)#timer hold-off 0	Configure hold-off timer value as 0
Bridge3(g8032-profile-config)#timer guard-timer 10	Configure guard-timer value as 10ms
Bridge3(g8032-profile-config)#switching mode revertive	Configure Switching mode as revertive Switching mode
Bridge3(g8032-profile-config)#g8032 erp-instance erp1	Create g8032 erp instance erp1

Bridge3(g8032-config-switch)#ring RING1	Associate ring RING1 to erp1 instance
Bridge3(g8032-config-switch)#rpl role non-owner	Configure the node as non-owner node
Bridge3(g8032-config-switch)#g8032-profile profile1	Associate Profile profile1 to erp1 instance
Bridge3(g8032-config-switch)#aps-channel level 7	Configure level as 7
Bridge3(g8032-config-switch)#aps-channel vlan 900	Configure RAPS channel vlan as 900
Bridge1(g8032-config-switch)#data vlan 950	Configure traffic vlan 950
Bridge3(g8032-config-switch)#ring-id 1	Configure ring-id as 1
Bridge3(g8032-config-switch)#commit	Commit the candidate configuration to the running configuration
Bridge3(g8032-config-switch)#end	Exit g8032 erp instance mode

## Bridge 4s

Bridge4#configure terminal	Enter configure mode
Bridge4(config)#ip router isis 1	Enable routing process - Intermediate System (IS-IS)
Bridge4(config-router)#net 49.3600.3600.0001.00	Configure net
Bridge4(config-router)#exit	End current mode and down to previous mode
Bridge4(config)#interface lo	Configure interface loopback
Bridge4(config-if)#ip address 1.1.1.1/32 secondary	Configure secondary ip address
Bridge4(config-if)#ip router isis 1	Enable routing process - Intermediate System (IS-IS)
Bridge4(config-if)#commit	Commit the candidate configuration to the running configuration
Bridge4(config-if)#exit	End current mode and down to previous mode
Bridge4(config)#router ldp	Enable LDP protocol
Bridge4(config-router)#router-id 1.1.1.1	Set router id
Bridge4(config-router)#targeted-peer ipv4 2.2.2.2	Configure targeted peer
Bridge4(config-router)#exit-targeted-peer-mode	Exit Targeted Peer configuration mode
Bridge4(config-router)#targeted-peer ipv4 3.3.3.3	Configure targeted peer
Bridge4(config-router)#exit-targeted-peer-mode	Exit Targeted Peer configuration mode
Bridge4(config-router)#transport-address ipv4 1.1.1.1	Configure a transport address for a label space

Bridge4 (config-router) #commit	Commit the candidate configuration to the running configuration
Bridge4 (config-router) #exit	End current mode and down to previous mode
Bridge4 (config) #mpls vpls vpls450 450	Create an instance of MPLS based Virtual Private Lan Service (VPLS)
Bridge4 (config-vpls) #signaling ldp	Establishing pseudowires with other PE routers using ldp protocol
Bridge4 (config-vpls-sig) #vpls-peer 2.2.2.2	Add a peer to VPLS domain
Bridge4 (config-vpls-sig) #vpls-peer 3.3.3.3	Add a peer to VPLS domain
Bridge4 (config-vpls-sig) #exit-signaling	Exit from Signaling configuration mode and start signaling
Bridge4 (config-vpls) # exit-vpls	Exit from vpls mode
Bridge4 (config) #bridge 1 protocol rstp vlan-bridge	Create bridge 1 as an RSTP VLAN-aware bridge.
Bridge4 (config) #hardware-profile filter cfm-domain-name-str enable	Enable CFM domain name as string
Bridge4 (config) #vlan database	Configure VLAN database
Bridge4 (config-vlan) # vlan 900-1010 bridge 1 state enable	Create VLAN 900-1010 on bridge 1
Bridge4 (config-vlan) #interface ce20	Configure interface ce20
Bridge4 (config-if) #switchport	Configure ce20 as a layer 2 port
Bridge4 (config-if) #bridge-group 1	Configure interface in bridge group 1
Bridge4 (config-if) #bridge-group 1 spanning-tree disable	Disable spanning tree for bridge group 1 on that interface
Bridge4 (config-if) #switchport mode trunk	Configure port as trunk port
Bridge4 (config-if) #switchport trunk allowed vlan add 900-1010	Allow vlan 900-1010 on ce20 interface
Bridge4 (config-if) #interface interface ce20.450 switchport	Configure interface ce20.450 as L2 subinterface
Bridge4 (config-if) #encapsulation dot1q 450	Configure dotq encapsulation for vlan 450 packets
Bridge4 (config-if) #access-if-vpls	Enter to VPLS MPLS Access interface mode
Bridge4 (config-acc-if-vpls) #mpls-vpls vpls450	Attach VPLS instance
Bridge4 (config-acc-if-vpls) #exit	End current mode and down to previous mode
Bridge4 (config-if) #interface xe14	Configure interface xe14
Bridge4 (config-if) #switchport	Configure xe14 as a layer 2 port
Bridge4 (config-if) #bridge-group 1	Configure interface in bridge group 1
Bridge4 (config-if) #bridge-group 1 spanning-tree disable	Disable spanning tree for bridge group 1 on that interface
Bridge4 (config-if) #switchport mode trunk	Configure port as trunk port

Bridge4(config-if)#switchport trunk allowed vlan add 900-1010	Allow vlan 900-1010 on xe14 interface
Bridge4(config-if)#interface xe14.450	Configure sub-interface of xe14
Bridge4(config-if)#encapsulation dot1q 450	Configure dotq encapsulation for vlan 450 packets
Bridge4(config-if)#ip address 10.1.1.2/30	Configure ip address
Bridge4(config-if)#label-switching	Enable label-switching on interface
Bridge4(config-if)#ip router isis 1	Enable routing process - Intermediate System (IS-IS)
Bridge4(config-if)#enable-ldp ipv4	Enable LDP protocol
Bridge4(config-if)#erps-instance none	Configure erps-instance in this subinterface
Bridge4(config-if)#interface xe4	Configure interface xe24
Bridge4(config-if)#ip address 30.1.1.2/30	Configure ip address
Bridge4(config-if)#label-switching	Enable label-switching on interface
Bridge4(config-if)#ip router isis 1	Enable routing process - Intermediate System (IS-IS)
Bridge4(config-if)#enable-ldp ipv4	Enable LDP protocol
Bridge1(config-if)# ethernet cfm domain- type character-string domain-name mdna3 level 7 mip-creation default	Create cfm domain with type as character string with name mdna3 and set MIP creation criteria to default with level 7
Bridge4(config-ether-cfm)#service ma-type string ma-name n27	Create MA type as string with name n27
Bridge4(config-ether-cfm-ma)#vlan 900 bridge 1	Add VLAN 900
Bridge4(config-ether-cfm-ma)# mip-creation default	Set MIP-creation criteria to default
Bridge4(config-ether-cfm-ma)# ethernet cfm mep down mpid 4047 active true xe14	Create down MEP 4047 for xe14 interface
Bridge4(config-ether-cfm-ma-mep)#cc multicast state enable	Enable CC multicast
Bridge4(config-ether-cfm-ma-mep)#exit- ether-ma-mep-mode	Exit ethernet CFM MA-MEP mode
Bridge4(config-ether-cfm-ma)#mep crosscheck mpid 47	Configure crosscheck to remote MEP with value 47
Bridge4(config-ether-cfm-ma)#cc interval 10s	Enable cc interval with 10s
Bridge4(config-ether-cfm-ma)# exit-ether- ma-mode	Exit Ethernet ma mode
Bridge4(config-if)# ethernet cfm domain- type character-string domain-name mdna4 level 7 mip-creation default	Create cfm domain with type as character string with name mdna4 and set MIP creation criteria to default with level 7

Bridge4(config-ether-cfm)#service ma-type string ma-name n27	Create MA type as string with name n27
Bridge4(config-ether-cfm-ma)# vlan 900 bridge 1	Add VLAN 900
Bridge4(config-ether-cfm-ma)# mip-creation default	Set MIP-creation criteria to default
Bridge4(config-ether-cfm-ma)# ethernet cfm mep down mpid 57 active true ce20	Create down MEP 57 for ce20 interface
Bridge4(config-ether-cfm-ma-mep)#cc multicast state enable	Enable CC multicast
Bridge4(config-ether-cfm-ma-mep)#exit-ether-ma-mep-mode	Exit ethernet CFM MA-MEP mode
Bridge4(config-ether-cfm-ma)#mep crosscheck mpid 5057	Configure crosscheck to remote MEP with value 5057
Bridge4(config-ether-cfm-ma)#cc interval 10s	Enable cc interval with 10s
Bridge4(config-ether-cfm-ma)# exit-ether-ma-mode	Exit Ethernet ma mode
Bridge4(config-ether-cfm)#g8032 ring RING1	Create g8032 ring with name RING1
Bridge4(g8032-ring-config)#east-interface ce20	Associate ce20 interface as east-interface
Bridge4(g8032-ring-config)#west-interface xe14	Associate xe14 interface as west-interface
Bridge4(g8032-ring-config)#g8032 profile profile1	Create g8032 profile with profile name profile1
Bridge4(g8032-profile-config)#timer wait-to-restore 1	Configure wait to restore time as 1 min
Bridge4(g8032-profile-config)#timer hold-off 0	Configure hold-off timer value as 0
Bridge4(g8032-profile-config)#timer guard-timer 10	Configure guard-timer value as 10ms
Bridge4(g8032-profile-config)#switching mode revertive	Configure Switching mode as revertive Switching mode
Bridge4(g8032-profile-config)#g8032 erp-instance erp1	Create g8032 erp instance erp1
Bridge4(g8032-config-switch)#ring RING1	Associate ring RING1 to erp1 instance
Bridge4(g8032-config-switch)#rpl role neighbor west-interface	Configure the node as neighbor towards west-interface
Bridge4(g8032-config-switch)#g8032-profile profile1	Associate Profile profile1 to erp1 instance



Bridge4(g8032-config-switch)#aps-channel level 7	Configure level as 7
Bridge4(g8032-config-switch)#aps-channel vlan 900	Configure RAPS channel vlan as 900
Bridge4(g8032-config-switch)#data vlan 950	Configure traffic vlan 950
Bridge4(g8032-config-switch)#ring-id 1	Configure ring-id as 1
Bridge4(g8032-config-switch)#commit	Commit the candidate configuration to the running configuration
Bridge4(g8032-config-switch)#end	Exit g8032 erp instance mode

## Bridge 5

Bridge5#configure terminal	Enter configure mode
Bridge5(config)#ip router isis 1	Enable routing process - Intermediate System (IS-IS)
Bridge5(config-router)# net 49.3600.3600.0002.00	Configure net
Bridge5(config-router)#exit	End current mode and down to previous mode
Bridge5(config)#interface lo	Configure interface loopback
Bridge5(config-if)# ip address 2.2.2.2/32 secondary	Configure secondary ip address
Bridge5(config-if)#ip router isis 1	Enable routing process - Intermediate System (IS-IS)
Bridge5(config-if)#commit	Commit the candidate configuration to the running configuration
Bridge5(config-if)#exit	End current mode and down to previous mode
Bridge5(config)#router ldp	Enable LDP protocol
Bridge5(config-router)#router-id 2.2.2.2	Set router id
Bridge5(config-router)#targeted-peer ipv4 1.1.1.1	Configure targeted peer
Bridge5(config-router)#exit-targeted-peer-mode	Exit Targeted Peer configuration mode
Bridge5(config-router)#targeted-peer ipv4 3.3.3.3	Configure targeted peer
Bridge5(config-router)#exit-targeted-peer-mode	Exit Targeted Peer configuration mode
Bridge5(config-router)#transport-address ipv4 2.2.2.2	Configure a transport address for a label space
Bridge5(config-router)#commit	Commit the candidate configuration to the running configuration
Bridge5(config-router)#exit	End current mode and down to previous mode
Bridge5(config)#mpls vpls vpls450 450	Create an instance of MPLS based Virtual Private Lan Service (VPLS)

Bridge5(config-vpls)#signaling ldp	Establishing pseudowires with other PE routers using ldp protocol
Bridge5(config-vpls-sig)#vpls-peer 1.1.1.1	Add a peer to VPLS domain
Bridge5(config-vpls-sig)#vpls-peer 3.3.3.3	Add a peer to VPLS domain
Bridge5(config-vpls-sig)#exit-signaling	Exit from Signaling configuration mode and start signaling
Bridge5(config-vpls)# exit-vpls	Exit from vpls mode
Bridge5(config)#bridge 1 protocol rstp vlan-bridge	Create bridge 1 as an RSTP VLAN-aware bridge.
Bridge5(config)#hardware-profile filter cfm-domain-name-str enable	Enable CFM domain name as string
Bridge5(config)#vlan database	Configure VLAN database
Bridge5(config-vlan)# vlan 900-1010 bridge 1 state enable	Create VLAN 900-1010 on bridge 1
Bridge5(config-vlan)#interface xe15	Configure interface xe15
Bridge5(config-if)#switchport	Configure xe15 as a layer 2 port
Bridge5(config-if)#bridge-group 1	Configure interface in bridge group 1
Bridge5(config-if)#bridge-group 1 spanning-tree disable	Disable spanning tree for bridge group 1 on that interface
Bridge5(config-if)#switchport mode trunk	Configure port as trunk port
Bridge5(config-if)#switchport trunk allowed vlan add 900-1010	Allow vlan 900-1010 on xe15 interface
Bridge5(config-if)#interface interface xe15.450 switchport	Configure interface xe15.450 as L2 subinterface
Bridge5(config-if)#encapsulation dot1q 450	Configure dotq encapsulation for vlan 450 packets
Bridge5(config-if)#access-if-vpls	Enter to VPLS MPLS Access interface mode
Bridge5(config-acc-if-vpls)#mpls-vpls vpls450	Attach VPLS instance
Bridge5(config-acc-if-vpls)#exit	End current mode and down to previous mode
Bridge5(config-if)#interface xe0	Configure interface xe0
Bridge5(config-if)#switchport	Configure xe0 as a layer 2 port
Bridge5(config-if)#bridge-group 1	Configure interface in bridge group 1
Bridge5(config-if)#bridge-group 1 spanning-tree disable	Disable spanning tree for bridge group 1 on that interface
Bridge5(config-if)#switchport mode trunk	Configure port as trunk port
Bridge5(config-if)#switchport trunk allowed vlan add 900-1010	Allow vlan 900-1010 on xe0 interface
Bridge5(config-if)#interface xe0.450	Configure sub-interface of xe0
Bridge5(config-if)#encapsulation dot1q 450	Configure dotq encapsulation for vlan 450 packets
Bridge5(config-if)#ip address 10.1.1.1/30	Configure ip address

Bridge5(config-if)#label-switching	Enable label-switching on interface
Bridge5(config-if)#ip router isis 1	Enable routing process - Intermediate System (IS-IS)
Bridge5(config-if)#enable-ldp ipv4	Enable LDP protocol
Bridge5(config-if)#erps-instance none	Configure erps-instance in this subinterface
Bridge5(config-if)#interface xe22	Configure interface xe24
Bridge5(config-if)#ip address 20.1.1.1/30	Configure ip address
Bridge5(config-if)#label-switching	Enable label-switching on interface
Bridge5(config-if)#ip router isis 1	Enable routing process - Intermediate System (IS-IS)
Bridge5(config-if)#enable-ldp ipv4	Enable LDP protocol
Bridge5(config-if)# ethernet cfm domain-type character-string domain-name mdna2 level 7 mip-creation default	Create cfm domain with type as character string with name mdna2 and set MIP creation criteria to default with level 7
Bridge5(config-ether-cfm)#service ma-type string ma-name n27	Create MA type as string with name n27
Bridge5(config-ether-cfm-ma)#vlan 900 bridge 1	Add VLAN 900
Bridge5(config-ether-cfm-ma)# mip-creation default	Set MIP-creation criteria to default
Bridge5(config-ether-cfm-ma)# ethernet cfm mep down mpid 37 active true xe15	Create down MEP 37 for xe15 interface
Bridge5(config-ether-cfm-ma-mep)#cc multicast state enable	Enable CC multicast
Bridge5(config-ether-cfm-ma-mep)#exit-ether-ma-mep-mode	Exit ethernet CFM MA-MEP mode
Bridge5(config-ether-cfm-ma)#mep crosscheck mpid 3037	Configure crosscheck to remote MEP with value 3037
Bridge5(config-ether-cfm-ma)#cc interval 10s	Enable cc interval with 10s
Bridge5(config-ether-cfm-ma)# exit-ether-ma-mode	Exit Ethernet ma mode
Bridge5(config-if)# ethernet cfm domain-type character-string domain-name mdna3 level 7 mip-creation default	Create cfm domain with type as character string with name mdna3 and set MIP creation criteria to default with level 7
Bridge5(config-ether-cfm)#service ma-type string ma-name n27	Create MA type as string with name n27
Bridge5(config-ether-cfm-ma)# vlan 900 bridge 1	Add VLAN 900

Bridge5(config-ether-cfm-ma)# mip-creation default	Set MIP-creation criteria to default
Bridge5(config-ether-cfm-ma)# ethernet cfm mep down mpid 47 active true xe0	Create down MEP 47 for xe0 interface
Bridge5(config-ether-cfm-ma-mep)#cc multicast state enable	Enable CC multicast
Bridge5(config-ether-cfm-ma-mep)#exit-ether-ma-mep-mode	Exit ethernet CFM MA-MEP mode
Bridge5(config-ether-cfm-ma)#mep crosscheck mpid 4047	Configure crosscheck to remote MEP with value 4047
Bridge5(config-ether-cfm-ma)#cc interval 10s	Enable cc interval with 10s
Bridge5(config-ether-cfm-ma)# exit-ether-ma-mode	Exit Ethernet ma mode
Bridge5(config-ether-cfm)#g8032 ring RING1	Create g8032 ring with name RING1
Bridge5(g8032-ring-config)#east-interface xe0	Associate ce20 interface as east-interface
Bridge5(g8032-ring-config)#west-interface xe15	Associate xe14 interface as west-interface
Bridge5(g8032-ring-config)#g8032 profile profile1	Create g8032 profile with profile name profile1
Bridge5(g8032-profile-config)#timer wait-to-restore 1	Configure wait to restore time as 1 min
Bridge5(g8032-profile-config)#timer hold-off 0	Configure hold-off timer value as 0
Bridge5(g8032-profile-config)#timer guard-timer 10	Configure guard-timer value as 10ms
Bridge5(g8032-profile-config)#switching mode revertive	Configure Switching mode as revertive Switching mode
Bridge5(g8032-profile-config)#g8032 erp-instance erp1	Create g8032 erp instance erp1
Bridge5(g8032-config-switch)#ring RING1	Associate ring RING1 to erp1 instance
Bridge5(g8032-config-switch)#rpl role owner east-interface	Configure the node as owner towards east-interface
Bridge5(g8032-config-switch)#g8032-profile profile1	Associate Profile profile1 to erp1 instance
Bridge5(g8032-config-switch)#aps-channel level 7	Configure level as 7
Bridge5(g8032-config-switch)#aps-channel vlan 900	Configure RAPS channel vlan as 900
Bridge5(g8032-config-switch)#data vlan 950	Configure traffic vlan 950

Bridge5(g8032-config-switch)#ring-id 1	Configure ring-id as 1
Bridge5(g8032-config-switch)#commit	Commit the candidate configuration to the running configuration
Bridge5(g8032-config-switch)#end	Exit g8032 erp instance mode

## Bridge 6

Bridge6#configure terminal	Enter configure mode
Bridge6(config)#ip router isis 1	Enable routing process - Intermediate System (IS-IS)
Bridge6(config-router)# net 49.3600.3600.0003.00	Configure net
Bridge6(config-router)#exit	End current mode and down to previous mode
Bridge6(config)#interface lo	Configure interface loopback
Bridge6(config-if)# ip address 3.3.3.3/32 secondary	Configure secondary ip address
Bridge6(config-if)#ip router isis 1	Enable routing process - Intermediate System (IS-IS)
Bridge6(config-if)#commit	Commit the candidate configuration to the running configuration
Bridge6(config-if)#exit	End current mode and down to previous mode
Bridge6(config)#router ldp	Enable LDP protocol
Bridge6(config-router)#router-id 3.3.3.3	Set router id
Bridge6(config-router)#targeted-peer ipv4 1.1.1.1	Configure targeted peer
Bridge6(config-router)#exit-targeted-peer- mode	Exit Targeted Peer configuration mode
Bridge6(config-router)#targeted-peer ipv4 2.2.2.2	Configure targeted peer
Bridge6(config-router)#exit-targeted-peer- mode	Exit Targeted Peer configuration mode
Bridge6(config-router)#transport-address ipv4 3.3.3.3	Configure a transport address for a label space
Bridge6(config-router)#commit	Commit the candidate configuration to the running configuration
Bridge6(config-router)#exit	End current mode and down to previous mode
Bridge6(config)#mpls vpls vpls450 450	Create an instance of MPLS based Virtual Private Lan Service (VPLS)
Bridge6(config-vpls)#signaling ldp	Establishing pseudowires with other PE routers using ldp protocol
Bridge6(config-vpls-sig)#vpls-peer 1.1.1.1	Add a peer to VPLS domain
Bridge6(config-vpls-sig)#vpls-peer 2.2.2.2	Add a peer to VPLS domain
Bridge6(config-vpls-sig)#exit-signaling	Exit from Signaling configuration mode and start signaling

Bridge6(config-vpls)# exit-vpls	Exit from vpls mode
Bridge6(config)#bridge 1 protocol rstp vlan-bridge	Create bridge 1 as an RSTP VLAN-aware bridge.
Bridge6(config)#hardware-profile filter cfm-domain-name-str enable	Enable CFM domain name as string
Bridge6(config)#vlan database	Configure VLAN database
Bridge6(config-vlan)# vlan 450 bridge 1 state enable	Create VLAN 450 on bridge 1
Bridge6(config-vlan)# vlan 900-1010 bridge 1 state enable	Create VLAN 900-1010 on bridge 1
Bridge6(config-vlan)#interface xe4	Configure interface xe4
Bridge6(config-if)#switchport	Configure xe4 as a layer 2 port
Bridge6(config-if)#bridge-group 1	Configure interface in bridge group 1
Bridge6(config-if)#bridge-group 1 spanning-tree disable	Disable spanning tree for bridge group 1 on that interface
Bridge6(config-if)#switchport mode trunk	Configure port as trunk port
Bridge6(config-if)#switchport trunk allowed vlan add 900-1010	Allow vlan 900-1010 on xe4 interface
Bridge6(config-if)#interface interface xe4.450 switchport	Configure interface xe4.450 as L2 subinterface
Bridge6(config-if)#encapsulation dot1q 450	Configure dotq encapsulation for vlan 450 packets
Bridge6(config-if)#access-if-vpls	Enter to VPLS MPLS Access interface mode
Bridge6(config-acc-if-vpls)#mpls-vpls vpls450	Attach VPLS instance
Bridge6(config-acc-if-vpls)#exit	End current mode and down to previous mode
Bridge6(config-if)#interface xe2	Configure sub-interface of xe2
Bridge6(config-if)#ip address 20.1.1.2/30	Configure ip address
Bridge6(config-if)#label-switching	Enable label-switching on interface
Bridge6(config-if)#ip router isis 1	Enable routing process - Intermediate System (IS-IS)
Bridge6(config-if)#enable-ldp ipv4	Enable LDP protocol
Bridge6(config-if)#interface xe5	Configure interface xe24
Bridge6(config-if)#ip address 30.1.1.1/30	Configure ip address
Bridge6(config-if)#label-switching	Enable label-switching on interface
Bridge6(config-if)#ip router isis 1	Enable routing process - Intermediate System (IS-IS)
Bridge6(config-if)#enable-ldp ipv4	Enable LDP protocol
Bridge6(config-if)#commit	Commit the candidate configuration to the running configuration
Bridge6(config-if)#end	Exit g8032 erp instance mode

---

## Validation

**Bridge1:**

```
show g8032 erp-instance erp1
```

```
Inst Name       : erp1
Description     :
State          : G8032_ST_IDLE
Phy Ring       : RING1
Ring Type      : MAJOR-RING
Role           : NON-OWNER
Node ID        : 14:44:8f:9c:20:dd
```

```
-----
                        East Link          West Link
=====
Interface        : xe20                    xe12
Protocol State   : Unblocked                Unblocked
Link Status      : UP                      UP
Remote NodeId    : f8:8e:a1:f3:25:42        -
Remote BPR       : 1                       -
Endpoint Info
-----
Domain Name      : mdna2                    mdna1
MEP ID           : 3037                     2027
MA Name          : n27                      n27
=====
```

```
-----
Channel          |
(LABEL, VLAN, RING ID) |
=====
(7, 900, 1)      |
=====
```

```
DataTraffic vlan: 950
Profile : profile1
```

**Bridge2:**

```
show g8032 erp-instance erp1
```

```
Inst Name       : erp1
Description     :
State          : G8032_ST_IDLE
Phy Ring       : RING1
Ring Type      : MAJOR-RING
Role           : NON-OWNER
Node ID        : 34:ef:b6:2f:45:86
```

```

                                East Link          West Link
=====
Interface      : ce9/1                ce6/1
Protocol State : Unblocked            Unblocked
Link Status    : UP                  UP
Remote NodeId  : f8:8e:a1:f3:25:42    -
Remote BPR     : 1                    -
Endpoint Info
-----
Domain Name    : mdna1                mdna5
MEP ID         : 27                   6067
MA Name        : n27                  n27
=====

```

```

-----
Channel        |
(Level, VLAN, RING ID) |
=====
(7, 900, 1)   |
=====

```

```

DataTraffic vlan: 950
Profile : profile1

```

**Bridge3:**

```
show g8032 erp-instance erp1
```

```

Inst Name      : erp1
Description    :
State          : G8032_ST_IDLE
Phy Ring       : RING1
Ring Type      : MAJOR-RING
Role           : NON-OWNER
Node ID        : 34:ef:b6:3c:55:c6

```

```

                                East Link          West Link
=====
Interface      : ce4/1                ce7/1
Protocol State : Unblocked            Unblocked
Link Status    : UP                  UP
Remote NodeId  : f8:8e:a1:f3:25:42    -
Remote BPR     : 1                    -
Endpoint Info
-----
Domain Name    : mdna5                mdna4
MEP ID         : 67                   5057
MA Name        : n27                  n27
=====

```



```

Channel |
(LEVEL, VLAN, RING ID) |
=====
(7, 900, 1) |
=====

```

```

DataTraffic vlan: 950
Profile : profile1

```

#### Bridge4:

```
show g8032 erp-instance erp1
```

```

Inst Name      : erp1
Description    :
State         : G8032_ST_IDLE
Phy Ring      : RING1
Ring Type     : MAJOR-RING
Role          : NEIGHBOR (WEST)
Node ID       : e8:c5:7a:47:c8:37

```

```

-----
                        East Link          West Link
=====
Interface       : ce20                    xe14
Protocol State  : Unblocked                Blocked
Link Status     : UP                      UP
Remote NodeId   : f8:8e:a1:f3:25:42       f8:8e:a1:f3:25:42
Remote BPR      : 1                       1
Endpoint Info
-----
Domain Name     : mdna4                    mdna3
MEP ID         : 57                       4047
MA Name        : n27                      n27
=====

```

```

Channel |
(LEVEL, VLAN, RING ID) |
=====
(7, 900, 1) |
=====

```

```

DataTraffic vlan: 950
Profile : profile1

```

#### Bridge4:

```

show mpls vpls mesh
(m) - Service mapped over multipath transport

```

(e) - Service mapped over LDP ECMP

VPLS-ID	Peer Addr	Tunnel-Label	In-Label	Network-Intf	Out-Label	Lkps/St
PW-INDEX	SIG-Protocol	Status				
450	2.2.2.2	3	26240	xe14.450	26241	2/Up
1	LDP	Active				
450	3.3.3.3	3	26241	xe4	26241	2/Up
2	LDP	Active				

**Bridge4:**

```
show hsl ifmgr l3 xe14.450
Interface: xe14.450 Ifindex: 164331970 Type: IP [mpls] Oper Count 1 Ref Count 2
FIB: 0 Status : UP/RUNNING
Ethertype : 0x8100 (NOT CONFIGURED)
L3 Info | Ifindex : 4150 VID : 4150 : HW FIB_ID : 0L3 egress
ID : 536875008
lport: 0x800000f
Lif Id : 0x44802018 Encap Id : 0x2018
Configured ERPS Instance : NONE <0>
Current ERPS Instance : NONE <0>
Current ERPS Port State : Forward
```

```
Total number of Children port count : 1
IPv4 Address (Count: 1):
Pfx: 10.1.1.2/30 flags: 0 int_flags: 16
IPv6 Address (Count: 1):
Pfx: fe80::eac5:7aff:fe47:c831/64 flags: 0 int_flags: 16
```

**Bridge4:**

```
show hsl hw unit 0 ac-lif | grep 450
```

16	0x4480200f	0x200f	none	0x0	0	4149	450
0x1b	0x2011		Forward				
25	0x44802018	0x2018	port*vlan	0x241c00e4	450	4150	450
0x11	0x201a		Forward				

**Bridge5:**

```
show g8032 erp-instance erp1
```

```
Inst Name      : erp1
Description    :
State          : G8032_ST_IDLE
Phy Ring       : RING1
Ring Type      : MAJOR-RING
Role           : OWNER (EAST)
Node ID        : f8:8e:a1:f3:25:42
```

```
-----
```

	East Link	West Link
Interface	: xe0	xe15

```
=====
```

```

Protocol State : Blocked          Unblocked
Link Status   : UP              UP
Remote NodeId : -              -
Remote BPR    : -              -

```

## Endpoint Info

```

-----
Domain Name   : mdna3          mdna2
MEP ID       : 47             37
MA Name      : n27            n27
=====

```

```

-----
Channel      |
(LEVEL, VLAN, RING ID) |
=====
(7, 900, 1) |
=====

```

```

DataTraffic vlan: 950
Profile : profile1

```

**Bridge5:**

```

show mpls vpls mesh
(m) - Service mapped over multipath transport
(e) - Service mapped over LDP ECMP

```

VPLS-ID	Peer Addr	Tunnel-Label	In-Label	Network-Intf	Out-Label	Lkps/St
PW-INDEX	SIG-Protocol	Status				
450	1.1.1.1	3	26241	xe0.450	26240	2/Up
1	LDP	Active				
450	3.3.3.3	3	26240	xe22	26240	2/Up
2	LDP	Active				

**Bridge6:**

```

show mpls vpls mesh
(m) - Service mapped over multipath transport
(e) - Service mapped over LDP ECMP

```

VPLS-ID	Peer Addr	Tunnel-Label	In-Label	Network-Intf	Out-Label	Lkps/St
PW-INDEX	SIG-Protocol	Status				
450	1.1.1.1	3	26241	xe5	26241	2/Up
1	LDP	Active				
450	2.2.2.2	3	26240	xe2	26240	2/Up
2	LDP	Active-				



## CHAPTER 5 Ethernet in the First Mile Configuration

This chapter contains a complete sample Ethernet 802.3ah (EFM) configuration.

EFM stands for Ethernet in the First Mile and it is an Ethernet link-layer OAM, which works over direct/with ethernet repeaters point-to-point ethernet links. OAM PDUs (Protocol Data Units) uses slow protocol destination MAC address 0180.c200.0002. These frames are single-hop and can not be forwarded beyond a single hop. The transmission rate is limited to a maximum of 10 frames per second to avoid impact on normal operations. Following are the OAM features supported by EFM.

- Discovery
- Link Monitoring
- Remote Fault Detection
- Remote Loopback

Note: Ethernet OAM is a layer 2 interface feature. So switchport configuration on interface is required. Configure the OAM Mode as Active or Passive. Both switch can be configured Active-Active or Active-Passive. But Passive-Passive on both switch won't work.

Note: Remote-loopback & link monitor supported is configured by default when ethernet oam is enabled.

Note: `shut/no-shut` should be performed to bring up the interface which becomes down after dying-gasp event.

### Topology

Figure 5-13 displays a sample EFM topology.



Figure 5-13: EFM Topology

### Configuration

All configuration commands in the table below should be followed for each switch.

<code>#configure terminal</code>	Enter configure mode.
<code>(config)#interface xe3</code>	Enter interface mode.
<code>(config-if)#switchport</code>	Set switching characteristics on the port.
<code>(config-if)#ethernet oam enable</code>	Configure EFM on interface
<code>(config-if)#ethernet oam mode passive</code>	Configure EFM mode Passive. Default is Active
<code>(config-if)#ethernet oam mode active</code>	Configure EFM mode Active
<code>(config-if)# ethernet oam remote-loopback start</code>	Configure remote-loopback start
<code>(config-if)# ethernet oam remote-loopback stop</code>	Configure remote-loopback stop

(config-if)#commit	Commit the configuration
(config-if)# exit	Exit from interface mode

---

## Validation

### 1. Verify OAM discovery

```
show ethernet oam discovery interface xe3
```

```
Local client:
```

```
-----
```

```
Administrative configurations:
```

```
Mode: active
Unidirection: not supported
Link monitor: supported(on)
Remote Loopback: supported
MIB retrieval: not supported
MTU Size : 1518
```

```
Operational status:
```

```
Port status: operational
Loopback status: no loopback
PDU revision: 0
```

```
Remote client:
```

```
-----
```

```
MAC address: 80a2.356c.21ff
Vendor(oui): 0 0 0
```

```
Administrative configurations:
```

```
Mode: passive
Unidirection: not supported
Link monitor: supported
Remote Loopback: supported
MIB retrieval: not supported
MTU Size : 1518
```

### 2. Verify the Discovery State Machine Details

```
show ethernet oam xe3
```

```
Discovery State Machine Details:
```

```
-----
```

```
EFM Discovery Machine State: Send Any
Local Parser State: Forward
Local Multiplexer State: Forward
Remote Parser State: Forward
Remote Multiplexer State: Forward
```

```
Local Client:
```

```
-----
```

## Symbol Period Error:

Window: 100000000 Symbol(s)  
Threshold: 1 Symbol(s)  
Last Window Symbols Errors: 0 Symbol(s)  
Total Symbols Errors: 0 Symbol(s)  
Total Symbols Errors Events: 0 Events(s)  
Relative Timestamp of the Event: 0 x 100 milliseconds

## Frame Error:

Window: 100 x 10 milliseconds  
Threshold: 1 Error Frame(s)  
Last Window Frame Errors: 0 Frame(s)  
Total Frame Errors: 0 Frames(s)  
Total Frame Errors Events: 0 Events(s)  
Relative Timestamp of the Event: 0 x 100 milliseconds

## Frame Period Error:

Window: 100000000 Frames  
Threshold: 1 Error Frame(s)  
Last Window Frame Errors: 0 Frame(s)  
Total Frame Errors: 0 Frames(s)  
Total Frame Period Errors Events: 0 Events(s)  
Relative Timestamp of the Event: 0 x 100 milliseconds

## Frame Seconds Error:

Window: 1000 x 10 milliseconds  
Threshold: 1 Error Second(s)  
Last Window Frame Second Errors: 0 Frame(s)  
Total Frame Second Errors: 0 Frames(s)  
Total Frame Second Errors Events: 0 Events(s)  
Relative Timestamp of the Event: 0 x 100 milliseconds

## Remote Client:

-----

## Symbol Period Error:

Window: 0 Symbol(s)  
Threshold: 0 Symbol(s)  
Last Window Symbols Errors: 0 Symbol(s)  
Total Symbols Errors: 0 Symbol(s)  
Total Symbols Errors Events: 0 Events(s)  
Relative Timestamp of the Event: 0 x 100 milliseconds

## Frame Error:

Window: 0 x 100 milliseconds  
Threshold: 0 Error Frame(s)  
Last Window Frame Errors: 0 Frame(s)  
Total Frame Errors: 0 Frames(s)  
Total Frame Errors Events: 0 Events(s)  
Relative Timestamp of the Event: 0 x 100 milliseconds

```
Frame Period Error:
  Window:                0 Frames
  Threshold:             0 Error Frame(s)
  Last Window Frame Errors: 0 Frame(s)
  Total Frame Errors:    0 Frames(s)
  Total Frame Period Errors Events: 0 Events(s)
  Relative Timestamp of the Event: 0 x 100 milliseconds
```

```
Frame Seconds Error:
  Window:                0 x 100 milliseconds
  Threshold:             0 Error Second(s)
  Last Window Frame Second Errors: 0 Frame(s)
  Total Frame Second Errors: 0 Frames(s)
  Total Frame Second Errors Events: 0 Events(s)
  Relative Timestamp of the Event: 0 x 100 milliseconds
```

### 3. Verify the oam statistics

```
show ethernet oam statistics interface xe3
```

Counters:

```
-----
Information OAMPDU Tx           : 331
Information OAMPDU Rx           : 323
Event Notification OAMPDU Tx    : 0
Event Notification OAMPDU Rx    : 0
Loopback Control OAMPDU Tx     : 0
Loopback Control OAMPDU Rx     : 0
Unsupported OAMPDU Rx          : 0
```

Local event logs:

```
-----
0 Errored Symbol Period records
0 Errored Frame records
0 Errored Frame Period records
0 Errored Frame Seconds records
```

Remote event logs:

```
-----
0 Errored Symbol Period records
0 Errored Frame records
0 Errored Frame Period records
0 Errored Frame Seconds records
```

### 4. Verify the oam status

```
show ethernet oam status interface xe3
```

General:



```
-----
Mode: active
PDU max rate: 10 packets per second
PDU min rate: 1 packet per 1 second
Link timeout: 5 seconds
High threshold action: no action

Link Monitoring:
-----
Status: supported(on)

Event log size: 20 Entries

Symbol Period Error:
Window: 100 million symbols
Low threshold: 1 error symbol(s)
High threshold: none

Frame Error:
Window: 100 x 10 milliseconds
Low threshold: 1 error frame(s)
High threshold: none

Frame Period Error:
Window: 1000 x 100,000 frames
Low threshold: 1 error frame(s)
High threshold: none

Frame Seconds Error:
Window: 1000 x 10 milliseconds
Low threshold: 1 error second(s)
High threshold: none
```



## CHAPTER 6 Ethernet Test Signal Lock Configuration

ETH-TST (Ethernet Test Signal) and ETH-LCK (Ethernet Lock Signal) protocols are defined in Y.1731. ETH-TST is used to perform one-way on-demand in-service or out-of-service diagnostics tests. This includes verifying bandwidth throughput, frame loss, bit errors, etc.

ETH-LCK is used to communicate the administrative locking of a MEP and consequential interruption of data traffic forwarding towards the MEP expecting this traffic. It allows a MEP receiving frames with ETH-LCK information to differentiate between a defect condition and an administrative locking action at lower level MEP.

### Topology

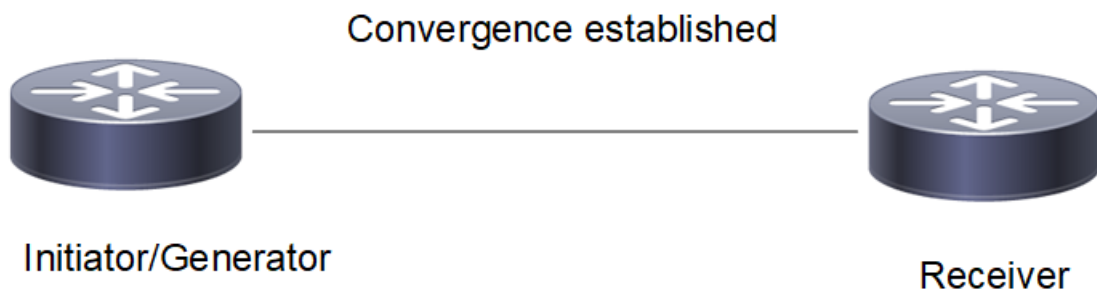

Figure 6-14: ETH Test Signal Topology

### ETH-TST Configuration

#### Initiator/generator

#configure terminal	Enter configure mode.
(config)#hardware-profile filter cfm-domain-name-str enable	Configure Hardware profile filter.
(config)#hardware-profile statistics ingress-acl enable	Configure hardware profile statistics ingress-acl.
(config)#vlan database	Enter Vlan config mode.
(config-vlan)#vlan 2-100 bridge 1 state enable	Configure Vlans.
(config-vlan)#exit	Exit Vlan config mode.
(config)#interface xe15	Enter Interface config mode.
(config-if)#switchport	Configure Interface as switchport.
(config-if)#bridge-group 1	Configure bridge-group.
(config-if)#switchport mode trunk	Configure switchport mode as trunk.
(config-if)#switchport trunk allowed vlan all	Configure all vlans as part of switchport trunk.
(config-if)#no shutdown	Bring the interface into operation.
(config-if)#exit	Exit interface mode.

## Ethernet Test Signal Lock Configuration

(config)#ethernet cfm domain-type character-string domain-name test1 level 7 mip-creation none	Enter ethernet cfm mode by specifying domain name and bridge.
(config-ether-cfm)#service ma-type string ma-name test1	Configure service ma.
(config-ether-cfm-ma)#vlan 10 bridge 1	Configure service Vlan.
(config-ether-cfm-ma)#mip-creation none	Configure mip-creation type.
(config-ether-cfm-ma)#ethernet cfm mep down mpid 200 active true xe15	Configure ethernet cfm mep.
(config-ether-cfm-ma-mep)#cc multicast state enable	Enable multicast state.
(config-ether-cfm-ma-mep)#exit-ether-ma-mep-mode	Exit Ethernet ma mep mode.
(config-ether-cfm-ma)#mep crosscheck mpid 100	Configure RMEP.
(config-ether-cfm-ma)#cc interval 5	Configure interval in ma mode.
(config-ether-cfm-ma)#exit-ether-ma-mode	Exit ma mode.
(config-ether-cfm)#exit	Exit Ethernet cfm mode.
(config)#ethernet cfm test-signal profile-name test	Configure Ethernet cfm test-signal profile.
(config-cfm-tst)#mode both	Configure test-signal mode as both(generator and receiver).
(config-cfm-tst)#frame-size 1500	Configure test-signal frame-size.
(config-cfm-tst)#commit	Commit the candidate configuration to the running configuration.
(config-cfm-tst)#exit	Exit Ethernet cfm test-signal mode.

## Receiver

#configure terminal	Enter configure mode.
(config)#hardware-profile filter cfm-domain-name-str enable	Configure Hardware profile filter.
(config)#hardware-profile statistics ingress-acl enable	Configure hardware profile statistics ingress-acl.
(config)#vlan database	Enter Vlan config mode.
(config-vlan)#vlan 2-100 bridge 1 state enable	Configure Vlans.
(config-vlan)#exit	Exit Vlan config mode.
(config)#interface xe15	Enter Interface config mode.
(config-if)#switchport	Configure Interface as switchport.
(config-if)#bridge-group 1	Configure bridge-group.
(config-if)#switchport mode trunk	Configure switchport mode as trunk.
(config-if)#switchport trunk allowed vlan all	Configure all vlans as part of switchport trunk.
(config-if)#no shutdown	Bring the interface into operation.
(config-if)#exit	Exit interface mode.

(config)#ethernet cfm domain-type character-string domain-name test1 level 7 mip-creation none	Enter ethernet cfm mode by specifying domain name and bridge.
(config-ether-cfm)#service ma-type string ma-name test1	Configure service ma.
(config-ether-cfm-ma)#vlan 10 bridge 1	Configure service Vlan.
(config-ether-cfm-ma)#mip-creation none	Configure mip-creation type.
(config-ether-cfm-ma)#ethernet cfm mep down mpid 100 active true xe15	Configure ethernet cfm mep.
(config-ether-cfm-ma-mep)#cc multicast state enable	Enable multicast state.
(config-ether-cfm-ma-mep)#exit-ether-ma-mep-mode	Exit Ethernet ma mep mode.
(config-ether-cfm-ma)#mep crosscheck mpid 200	Configure RMEP.
(config-ether-cfm-ma)#cc interval 3ms	Configure interval in ma mode.
(config-ether-cfm-ma)#exit-ether-ma-mode	Exit ma mode.
(config-ether-cfm)#exit	Exit Ethernet cfm mode.
(config)#ethernet cfm test-signal profile-name sample_tst	Configure Ethernet cfm test-signal profile.
(config-cfm-tst)#mode receiver	Configure test-signal mode as receiver.
(config-cfm-tst)#commit	Commit the candidate configuration to the running configuration.
(config-cfm-tst)#exit	Exit Ethernet cfm test-signal mode.

## Validation

Before the ETH-TST signal is started, convergence needs to be established. Convergence is checked as mentioned below:

```
CE1#sh ethernet cfm errors domain test1 bridge 1
Domain Name          Level      Vlan      MEPID      Defects
-----
test1                7         10       200        .....
1. defRDICCM        2. defMACstatus  3. defRemoteCCM
4. defErrorCCM      5. defXconCCM
```

After the above convergence is established with the receiver node, ETH-TST signal is started from the exec mode as mentioned below.

### Generator node

```
#test-signal start-time relative 0 stop-time relative 4 tst-profile-name test domain
test1 ma test1 mep 200 target mac-address 0018.236c.5cca bridge 1
```

### Receiver node

```
#test-signal start-time relative 0 stop-time relative 4 tst-profile-name sample_tst
domain test1 ma test1 mep 100 target mac-address e8c5.7a78.712d bridge 1
```

ETH-TST Signal initiated is checked as mentioned below :

### Generator node

```
#show ethernet cfm test-signal sessions
```

MEP-Id	Status	StartTime	Tst-Profile	Peer MAC-Address
200	Active	2019/02/15 16:32:59	test	0018.236c.5cca

```
#show ethernet cfm test-signal domain test1 ma test1 mep 200 bridge 1 stats gtf
```

```
TST Session status      : In-Progress
Elapsed Time(sec)      : 77
MD                      : test1
MA                      : test1
MEP                    : 200
Peer MAC Address       : 0018.236c.5cca
RMEP ID                : 100
Start Time              : 2019 Feb 15 16:32:59
Transmitted Packet Count : 509767
```

### Receiver Node

```
#show ethernet cfm test-signal domain test1 ma test1 mep 100 bridge 1 stats ctf
```

```
TST Session status      : In-Progress
Elapsed Time(sec)      : 83
MD                      : test1
MA                      : test1
MEP                    : 100
Peer MAC Address       : e8c5.7a78.712d
RMEP ID                : 200
Start Time              : 2020 Dec 16 16:34:21
Received Packet Count  : 545827
Out-of-Order Packet Count : 0
Error Packet Count     : 0
Last Packet Sequence Number : 664967
```

---

## ETH-LCK Configuration

Eth-Lck configuration is performed at the MEP Level as shown below :

#configure terminal	Enter configure mode
(config)# ethernet cfm domain-type character-string domain-name test1 level 7 mip-creation none	Enter ethernet cfm mode by specifying domain name and bridge.
(config-ether-cfm)#service ma-type string ma-name test1	Configure service ma
(config-ether-cfm-ma)#vlan 10 bridge 1	Configure service Vlan.
(config-ether-cfm-ma)#mip-creation none	Configure mip-creation type.
(config-ether-cfm-ma)#ethernet cfm mep down mpid 200 active true xe15	Configure ethernet cfm mep
(config-ether-cfm-ma-mep)#exit	Eth Lck configuration is performed in MEP Mode

---

## Validation

Default state of the Ethernet cfm Lck details is as mentioned below:

```
#show ethernet cfm lck details domain test1 ma test1 mep 200 bridge 1
```

```
Maintenance Domain      : test1
Maintenance Association  : test1
MEP ID                  : 200
LCK PDU state           : Unlocked
LCK Message Level       : 0
LCK PDU Interval        : 1 sec
LCK PDU Priority         : 3
```

```
(config-ether-cfm-ma-mep)#state ?
lock      Enable administrative locking state
unlock    Disable administrative locking state
```

```
(config-ether-cfm-ma-mep)#state lock
```

```
#show ethernet cfm lck details domain test1 ma test1 mep 200 bridge 1
```

```
Maintenance Domain      : test1
Maintenance Association  : test1
MEP ID                  : 200
LCK PDU state           : Locked
LCK Message Level       : 0
LCK PDU Interval        : 1 sec
LCK PDU Priority         : 3
```

```
(config-ether-cfm-ma-mep)#message level ?
<0-7>    Enter the level for LCK transmission
```

```
(config-ether-cfm-ma-mep)#message level 3
```

```
#show ethernet cfm lck details domain test1 ma test1 mep 200 bridge 1
```

```
Maintenance Domain      : test1
Maintenance Association  : test1
MEP ID                  : 200
LCK PDU state           : Locked
LCK Message Level       : 3
LCK PDU Interval        : 1 sec
LCK PDU Priority         : 3
```

```
(config-ether-cfm-ma-mep)#interval ?
1min     PDU transmit interval is one minute
1s       PDU transmit interval is one second(default)
```

```
(config-ether-cfm-ma-mep)#interval 1min
```

```
#show ethernet cfm lck details domain test1 ma test1 mep 200 bridge 1
```

```
Maintenance Domain      : test1
Maintenance Association  : test1
MEP ID                  : 200
```

## Ethernet Test Signal Lock Configuration

---

```
LCK PDU state           : Locked
LCK Message Level      : 3
LCK PDU Interval       : 1 min
LCK PDU Priority        : 3
```

```
(config-ether-cfm-ma-mep)#frame priority ?
```

```
<0-7> Enter the priority for LCK transmission PDU.Default is 3
```

```
(config-ether-cfm-ma-mep)#frame priority 7
```

```
#show ethernet cfm lck details domain test1 ma test1 mep 200 bridge 1
```

```
Maintenance Domain      : test1
Maintenance Association  : test1
MEP ID                  : 200
LCK PDU state           : Locked
LCK Message Level      : 3
LCK PDU Interval       : 1 min
LCK PDU Priority        : 7
```



## CHAPTER 7 Ethernet Bandwidth Notification Configuration

This chapter contains a configuration example of Ethernet Bandwidth Notification (ETH-BN).

ETH-BN protocol is defined in ITU-T Y.1731. ETH-BN is used by a server MEP to signal the server layer link bandwidth in the transmit direction to a MEP at the client layer, for example when the server layer runs over a microwave link which has the capability to adapt its bandwidth according to the prevailing atmospheric conditions.

On receiving frames with ETH-BN information, the client layer MEP can use bandwidth information to adjust service policies, e.g., to reduce the rate of traffic being directed towards the degraded link.

A client MEP continues to receive periodic frames with ETH-BN information including currently available bandwidth until the full bandwidth is restored at server MEP. In addition, periodic frames with ETH-BN information may optionally be received when there is no degradation or when the bandwidth degrades to 0.

OcNOS supports only ETH-BN PDU reception and received PDU is processed as per below FSM:

Note: ETH-BN transmission is not supported by OcNOS.

Note: ETH-BN session shall be initiated on pre-configured active MEP. MD, MA and MEP details shall be metadata or prerequisite for this feature.

### Topology

Figure 7-15 displays a sample FSM topology.

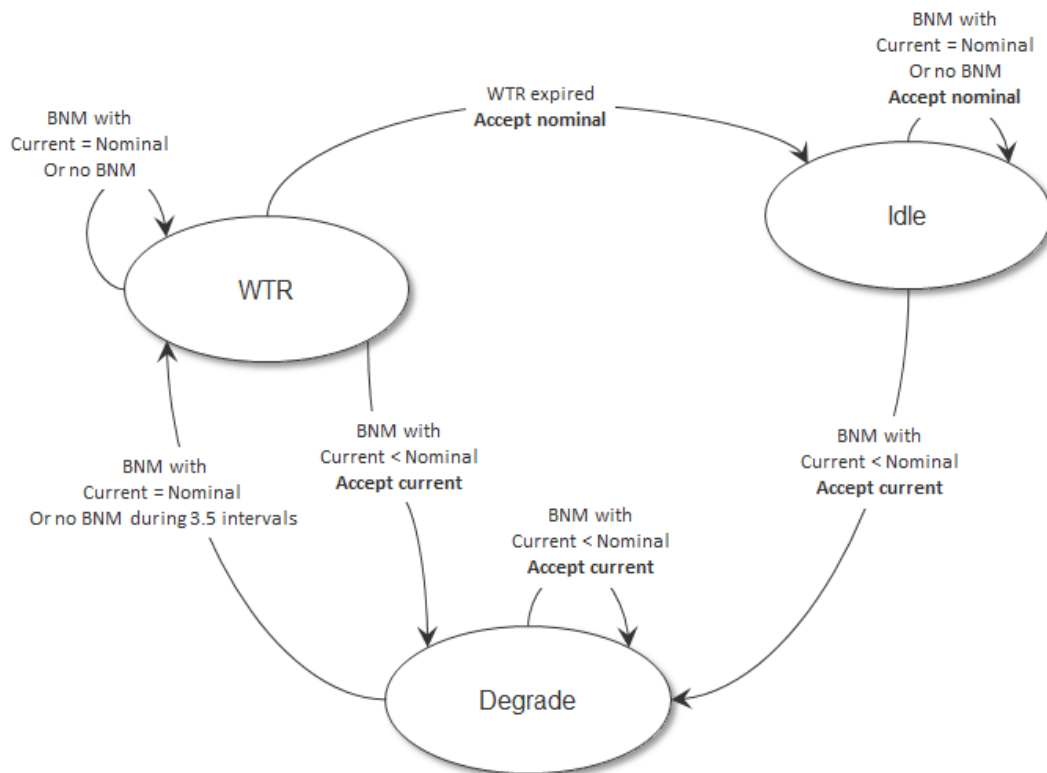

Figure 7-15: FSM Topology

Figure 7-16 displays a sample ETH-BN topology.

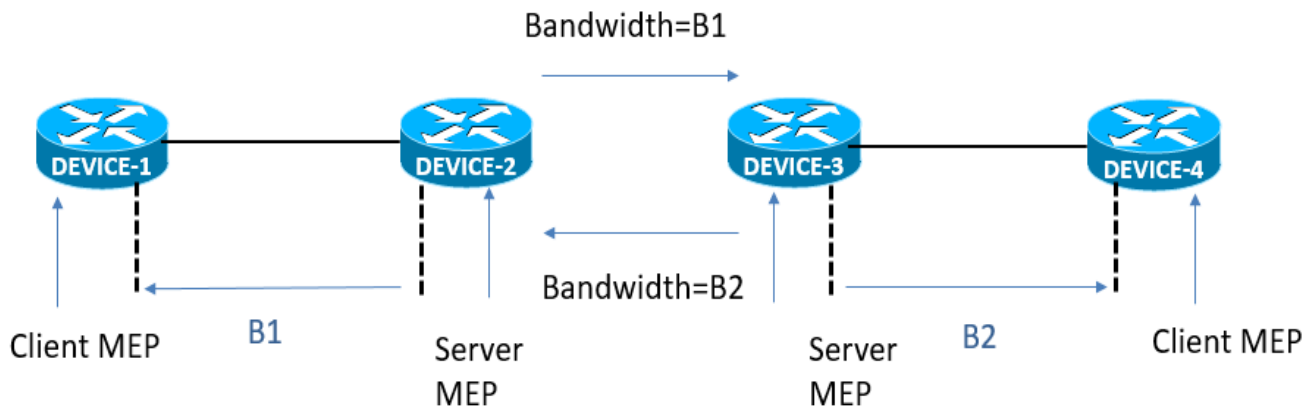

Figure 7-16: ETH-BN Topology

## Prerequisite

Configure below hardware-profile commands related to CFM in configuration mode and reboot the nodes.

```
hardware-profile filter cfm-domain-name-str enable
hardware-profile statistics cfm-ccm enable (optional)
```

## ETH-BN Configuration

Eth-Bn configuration is performed at the MEP Level as shown below.

Client-mep#configure terminal	Enter configure mode
Client-mep(config)#bridge 1 protocol rstp vlan-bridge	Create bridge 1 as an RSTP VLAN-aware bridge.
Client-mep (config)#vlan database	Entering vlan database
Client-mep (config-vlan)#vlan 10 bridge 1 state enable	Create VLAN 10 on bridge 1.
Client-mep (config-vlan)#exit	Exit vlan database
Client-mep (config)#int ce49	Configure interface ce49.
Client-mep (config-if)#bridge-group 1	Configure interface in bridge group 1.
Client-mep (config-if)#switchport mode trunk	Configure interface mode as trunk.
Client-mep (config-if)#switchport trunk allowed vlan all	Allow all VLANs on interface ce49.
Client-mep (config-if)#exit	Exit config mode.
Client-mep (config)#ethernet cfm domain-type character-string domain-name 12345 level 7 mip-creation none	Create cfm domain with type as character string and set mip creation criteria to none.
Client-mep (config-ether-cfm)#service ma- type string ma-name 54321	Create ma type as string and set mip creation criteria to none.
Client-mep (config-ether-cfm-ma)#vlan 10 bridge 1	Configure service Vlan
Client-mep (config-ether-cfm-ma)# mip- creation none	Configure mip-creation type.

Client-mep (config-ether-cfm-ma)#ethernet cfm mep down mpid 34 active true ce49	Create down mep for local-vid on ce49.
Client-mep (config-ether-cfm-ma-mep)#cc multicast state enable	Enable cc multicast.
Client-mep (config-ether-cfm-ma-mep)#bn receive	Enabling the eth-bn status
Client-mep (config-ether-cfm-ma-mep)#wait-to-restore-timer 50	Configure the eth-bn wait-too-restore-timer 50secs
Client-mep (config-ether-cfm-ma-mep)#exit-ether-ma-mep-mode	Exit Ethernet ma mep mode.
Client-mep (config-ether-cfm-ma)#mep crosscheck mpid 35	Enable MEP crosscheck
Client-mep (config-ether-cfm-ma)#cc interval 3ms	Enable cc interval in ms
Client-mep (config-ether-cfm-ma)#exit-ether-ma-mode	Exit ma mode.
Client-mep (config-ether-cfm)#commit	Commit the candidate configuration to the running configuration.
Client-mep (config-ether-cfm)#exit	Exit Ethernet cfm mode.

## Validation

```
client-mep#show running-config cfm
!
!
ethernet cfm domain-type character-string domain-name 12345 level 7 mip-creation none
service ma-type string ma-name 54321
mip-creation none
ethernet cfm mep down mpid 34 active true ce49
bn receive
wait-to-restore-timer 50
exit-ether-ma-mep-mode
mep crosscheck mpid 35
    cc interval 3ms
exit-ether-ma-mode

!
```

```
client-mep#show ethernet cfm bn status
```

```
BNM status for interface xe26
```

```
-----
State                : SIGNAL_PENDING
Restore Time         : 50 seconds
Total BNM Receive Count : 2
Sender Address       : 3c2c.99d6.16a9
Elapsed time in this state: 00:01:38
```

## Ethernet Bandwidth Notification Configuration

---

Nominal Bandwidth : 16 Mbps  
Current Bandwidth : 16 Mbps  
Lowest Bandwidth : 16 Mbps  
Last BNM Received : 2019 Mar 14 15:09:50  
BNM Period : 60 seconds  
Wait-to-Restore Timer : 45 second(s) remaining

Client-mep#show ethernet cfm bn mep 2 domain mdnam ma testtm

Ethernet BN MEP informations

-----  
MA-Name : testtm  
MEL : 2  
Admin Status: ENABLE  
Interface : ce49  
VLAN : 25  
Source Address : 3c2c.99d6.16a9  
Wait to Restore Timer : 50 seconds  
State : SIGNAL\_NORMAL  
Elapsed time in this state: 00:00:01  
Last BNM Received : 2019 Mar 14 15:09:50  
Nominal Bandwidth : 16 Mbps  
Current Bandwidth : 16 Mbps  
Port-ID : -1412628480  
BNM Period : 60 seconds

Client-mep#show ethernet cfm statistics bn

MEPID	Domain	MA-Name	RX-Frames	Dropped-Frames	WR-time-left(sec)
2	mdnam	testtm	2	0	44

# Carrier Ethernet Command Reference



---

## CHAPTER 1 CFM and Y.1731 Commands

---

This chapter describes the commands used to manage the Connectivity Fault Management (CFM). CFM refers to the service OAM of Ethernet used to manage individual Layer 2 Ethernet services. The CFM protocol can discover and verify the path through 802.1 bridges and LANs. OcnOS adheres to the IEEE 802.1ag 2007 standard.

CFM includes the features required by ITU Y.1731 standard *OAM Functions and Mechanisms for Ethernet Based Networks*. This recommendation identifies the functions required to enable fault management (such as fault localization and defect detection) and performance monitoring in an Ethernet network.

- [abort delay-measurement](#)
- [abort loss-measurement](#)
- [abort test-signal domain](#)
- [ais interval](#)
- [ais status](#)
- [bins-per-fd-interval](#)
- [bins-per-ifdv-interval](#)
- [bin-type](#)
- [bn receive](#)
- [bw-mapped-interface](#)
- [cc interval](#)
- [cc multicast](#)
- [cfm snmp restart](#)
- [clear ethernet cfm delay-measurement history](#)
- [clear ethernet cfm dm history](#)
- [clear ethernet cfm lm history](#)
- [clear ethernet cfm lm history](#)
- [clear ethernet cfm maintenance-point remote](#)
- [clear ethernet cfm statistics](#)
- [clear ethernet cfm statistics bn](#)
- [clear ethernet cfm statistics lck](#)
- [clear ethernet cfm statistics test-signal](#)
- [clear ethernet cfm traceroute-cache](#)
- [csf receive](#)
- [debug ethernet cfm](#)
- [delay-measurement type on-demand](#)
- [delay-measurement type proactive](#)
- [ethernet cfm delay-measurement profile-name](#)
- [ethernet cfm delay-measurement reply](#)
- [ethernet cfm domain-type](#)
- [ethernet cfm loss-measurement profile-name](#)

- `ethernet cfm loss-measurement reply`
- `ethernet cfm mep`
- `ethernet cfm mip`
- `ethernet cfm statistics csf`
- `ethernet cfm test-signal profile-name`
- `ethernet cfm traceroute cache`
- `evpn`
- `exit-ether-ma-mep-mode`
- `exit-ether-ma-mode`
- `frame priority`
- `hardware-profile filter cfm-domain-name-str`
- `interval`
- `intervals-stored`
- `lck state`
- `link-level`
- `loss-measurement type on-demand`
- `loss-measurement type proactive`
- `measurement-interval`
- `measurement-type slm`
- `mep crosscheck`
- `mep lowest-priority-defect`
- `message level`
- `message-period`
- `mip-creation`
- `intervals-stored`
- `peer-port-id`
- `ping ethernet mac`
- `rmep auto-discovery`
- `service ma-type`
- `show ethernet cfm ais reception-status`
- `show ethernet cfm bn`
- `show ethernet cfm bn mep`
- `show ethernet cfm csf`
- `show ethernet cfm csf mep`
- `show ethernet cfm delay-measurement mep`
- `show ethernet cfm delay-measurement profile`
- `show ethernet cfm dm sessions`
- `show ethernet cfm errors`
- `show ethernet cfm eth-bn status`



- `show ethernet cfm frame-lm session`
- `show ethernet cfm lck details domain`
- `show ethernet cfm lck statistics`
- `show ethernet cfm loss-measurement mep`
- `show ethernet cfm loss-measurement profile`
- `show ethernet cfm ma status`
- `show ethernet cfm maintenance-points count`
- `show ethernet cfm maintenance-points local mep`
- `show ethernet cfm maintenance-points local mip`
- `show ethernet cfm maintenance-points remote`
- `show ethernet cfm statistics`
- `show ethernet cfm statistics bn`
- `show ethernet cfm statistics csf`
- `show ethernet cfm test-signal domain`
- `show ethernet cfm test-signal profile`
- `show ethernet cfm test-signal sessions`
- `show ethernet cfm traceroute-cache`
- `show running-config cfm`
- `test-signal frame-size`
- `test-signal mode`
- `test-signal pattern-type`
- `test-signal start-time`
- `test-signal test-type`
- `traceroute ethernet`
- `vlan`
- `vpws`
- `wait-to-restore-timer <0-86400>`

---

## abort delay-measurement

Use this command to stop the ongoing or scheduled CFM frame delay measurement session.

### Command Syntax

```
abort delay-measurement mep MEPID domain DOMAIN_NAME ma MA_NAME
```

### Parameters

mep	Local MEP identifier
MEPID	MEP identifier <1-8191>
domain	Specify domain.
DOMAIN_NAME	Enter the name of the domain. Name must be of 5 characters if type is character-string otherwise no_name if domain-type is no-name1
ma	Specify Maintenance association name
MA_NAME	Enter maintenance association name. If ma-type is character string then maximum length of ma-name is 6 else if it's integer then maximum is 2-octets.

### Command Mode

Exec mode and Privileged Exec mode

### Applicability

This command was introduced in OcnOS version 3.0.

### Example

```
#abort delay-measurement mep 123 domain 12345 ma 1234
```

---

## abort loss-measurement

Use this command to stop the ongoing CFM frame loss measurement session.

### Command Syntax

```
abort loss-measurement mep MEPID domain DOMAIN_NAME ma MA_NAME
```

### Parameters

mep	Local MEP identifier
MEPID	MEP identifier <1-8191>
domain	Specify domain.
DOMAIN_NAME	Enter the name of the domain. Name must be of 5 characters if type is character-string otherwise no_name if domain-type is no-name1
ma	Specify Maintenance association name
MA_NAME	Enter maintenance association name. If ma-type is character string then maximum length of ma-name is 6 else if it's integer then maximum is 2-octets.

### Command Mode

Exec mode

### Applicability

This command was introduced in OcNOS version 3.0.

### Example

```
#abort loss-measurement mep 201 domain 12345 ma 1234
```

---

## abort test-signal domain

Use this command to abort pre-configured test session.

### Command Syntax

```
abort test-signal domain DOMAIN_NAME ma MA_NAME mep MEPID
```

### Parameters

domain	Specify domain.
DOMAIN_NAME	Enter the name of the domain. Name must be of 5 characters if type is character-string otherwise no_name if domain-type is no-name1
ma	Specify Maintenance association name
MA_NAME	Enter maintenance association name. If ma-type is character string then maximum length of ma-name is 6 else if it's integer then maximum is 2-octets.
mep	Specify mep
MEPID	Enter the MEPID ranging from <1-8191>

### Command Mode

Exec mode

### Default

None

### Applicability

This command was introduced in OcNOS version 4.0.

### Example

```
#abort test-signal domain 12345 ma 43982 mep 21
```

---

## ais interval

Use this command to set the AIS (Alarm Indication Signal) transmission interval.

### Command Syntax

```
ais interval (1min|1s)
```

### Parameters

1min	AIS transmission interval in packets per second
1s	AIS transmission interval in packets per minute

### Default

one-second

### Command Mode

Ethernet CFM MA MEP mode

### Applicability

This command was introduced in OcNOS version 3.0.

### Examples

```
#configure terminal
(config)#ethernet cfm domain-type character-string domain-name 12345 level 7
(config-ether-cfm)#service ma-type string ma-name 43982
(config-ether-cfm-ma)#ethernet cfm mep down mpid 201 active true local-vid 10 xe2
(config-ether-cfm-ma-mep)#ais interval 1m
```

---

## ais status

Use this command to enable or disable AIS (Alarm Indication Signal) transmission and set the CFM MD level to transmit in AIS PDUs.

### Command Syntax

```
ais status (enable|disable) level <0-7>
```

### Parameters

enable	Enable AIS
disable	Disable AIS
<0-7>	CFM MD level

### Default

disable

### Command Mode

Ethernet CFM MA MEP mode

### Applicability

This command was introduced in OcnOS version 3.0.

### Examples

```
#configure terminal
(config)#ethernet cfm domain-type character-string domain-name 12345 level 7
(config-ether-cfm)# service ma-type string ma-name testtm
(config-ether-cfm-ma)#vlan 5 bridge 10
(config-ether-cfm-ma)#ethernet cfm mep down mpid 201 active true xe2
(config-ether-cfm-ma-mep)#ais status enable level 7
```

---

## bins-per-fd-interval

Use this command to set the number of measurement bins per measurement interval for a two-way performance monitoring frame delay measurement on a specific MEP.

Use the no form to set the number of measurement bins per measurement interval for a two-way performance monitoring frame delay measurement on a specific MEP to its default (3).

### Command Syntax

```
bins-per-fd-interval <2-10>
no bins-per-fd-interval
```

### Parameters

<2-10>                      Number of frame delay bins to be created

### Default

3

### Command Mode

Ethernet CFM delay measurement mode

### Applicability

This command was introduced in OcNOS version 3.0.

### Example

```
#configure terminal
(config)#ethernet cfm delay-measurement profile-name PROF1
(config-cfm-dm)# bins-per-fd-interval 4
```

---

## bins-per-ifdv-interval

Use this command to set the number of measurement bins per measurement interval for an inter-frame delay for a two-way performance monitoring frame delay measurements on a specific MEP.

Use the no form to set the number of measurement bins per measurement interval for an inter-frame delay for a two-way performance monitoring frame delay measurements on a specific MEP to its default (2).

### Command Syntax

```
bins-per-ifdv-interval <2-10>
no bins-per-ifdv-interval
```

### Parameters

<2-10>	Number of inter-frame delay bins to be created
--------	--

### Default

2

### Command Mode

Ethernet CFM delay measurement mode

### Applicability

This command was introduced in OcnOS version 3.0.

### Example

```
#configure terminal
(config)#ethernet cfm delay-measurement profile-name PROF1
(config-cfm-dm)# bins-per-ifdv-interval 3
```



## bin-type

Use this command to set the threshold value for a particular bin for a two-way performance monitoring frame delay measurements on a specific MEP.

Use the no form to set threshold value for a particular bin for a two-way performance monitoring frame delay measurements on a specific MEP to its default.

### Command Syntax

```
bin-type frame-delay bin 2 threshold 200
no bin-type frame-delay bin 2 threshold
bin-type inter-frame-delay-variation bin 2 threshold 1000
no bin-type inter-frame-delay-variation bin 2 threshold
```

### Parameters

frame-delay	Frame delay bin type
inter-frame-delay-variation	Inter frame delay variation bin type
<2-10>	Bin number for which the threshold will be changed.
<1- 4294967295>	Threshold value for that bin.

### Default

Incremental of 5000 microseconds from bin 2, that is bin 2's threshold will be 5000, bin 3's will be 10000, bin 4 will be 15000, so on and so forth.

### Command Mode

Ethernet CFM delay measurement mode

### Applicability

This command was introduced in OcNOS version 3.0.

### Example

```
#configure terminal
(config)#ethernet cfm delay-measurement profile-name PROF1
(config-cfm-dm)# bin-type frame-delay bin 2 threshold 200
(config-cfm-dm)# bin-type inter-frame-delay-variation bin 2 threshold 1000
```

---

## bn receive

Use this command to create EBN configuration and to enable/disable Eth-BN for the Mep.

### Command Syntax

```
bn receive
no bn receive
```

### Parameters

None

### Default

ETH-BN is disabled by default

### Command Mode

Ethernet CFM MEP mode

### Applicability

This command was introduced in OcNOS version 5.0

### Examples

```
OcNOS(config)#ethernet cfm domain-type character-string domain-name abcde
level 5
OcNOS(config-ether-cfm)#service ma-type string ma-name 7
OcNOS(config-ether-cfm-ma)#vlan 10 bridge 1
OcNOS(config-ether-cfm-ma)#ethernet cfm mep down mpid 100 active true xe9
OcNOS(config-ether-cfm-ma-mep)#bn receive
OcNOS(config-ether-cfm-ma-mep-bn)#commit
```

---

## bw-mapped-interface

Use this command to configure modem interface where the shapers has to be applied. When Eth-BNM and Eth-CSF PDUs are received on Out-Of-Band interface, shapper will be updated on corresponding modem interface if this CLI is configured. Use <no> version of CLI to unconfigure modem interface mapping.

### Command Syntax

```
bw-mapped-interface IFNAME
no bw-mapped-interface
```

### Parameters

IFNAME                      Specify the interface name where bandwidth shapers can be applied

### Command Mode

Ethernet CFM MEP mode

### Applicability

This command was introduced in OcNOS version 5.2

### Examples

```
OcNOS(config)#ethernet cfm domain-type character-string domain-name abcde
level 5
OcNOS(config-ether-cfm)#service ma-type string ma-name 7
OcNOS(config-ether-cfm-ma)#vlan 10 bridge 1
OcNOS(config-ether-cfm-ma)#ethernet cfm mep down mpid 100 active true xe9
OcNOS(config-ether-cfm-ma-mep)# bw-mapped-interface modem1
OcNOS(config-ether-cfm-ma-mep)#commit
```

---

## cc interval

Use this command to set the continuity checking (CC) message interval.

### Command Syntax

```
cc interval (3ms|10ms|100ms|1s|10s)
```

### Parameters

3ms	3 milliseconds
10ms	10 milliseconds
100ms	100 milliseconds
1s	1 seconds
10s	10 seconds

### Command Mode

Ethernet CFM MA mode

### Applicability

This command was introduced in OcnOS version 3.0.

### Examples

```
(config)#ethernet cfm domain-type character-string domain-name 12345 level 7
(config-ether-cfm)#service ma-type string ma-name 43982
OcnOS(config-ether-cfm-ma)#vlan 10 bridge 1
(config-ether-cfm-ma)#ethernet cfm mep down mpid 2331 active true xe2
OcnOS(config-ether-cfm-ma-mep)cc interval 3ms
OcnOS(config-ether-cfm-ma-mep)#cc multicast state enable
```

---

## cc multicast

Use this command to start or stop multicast continuity checking messages (CCMs) on a MEP.

### Command Syntax

```
cc multicast state (enable|disable)
```

### Parameters

enable	Start sending CCMs
disable	Stop sending CCMs

### Command Mode

Ethernet CFM MA MEP mode

### Applicability

This command was introduced in OcNOS version 3.0.

### Examples

```
(config)#ethernet cfm domain-type character-string domain-name 12345 level 7
(config-ether-cfm)#service ma-type string ma-name 43982
(config-ether-cfm-ma)#vlan 10 bridge 1
(config-ether-cfm-ma)#ethernet cfm mep down mpid 2331 active true xe2 OcnOS(config-ether-cfm-ma-mep)#cc multicast state enable
```

---

## cfm snmp restart

Use this command to restart SNMP in CFM Protocol.

### Command Syntax

```
cfm snmp restart
```

### Parameters

None

### Command Mode

Exec mode

### Applicability

This command was introduced in OcNOS version 3.0.

### Examples

```
OcNOS#cfm snmp restart
```

---

## clear ethernet cfm delay-measurement history

Use this command to clear the CFM frame delay measurement history statistics from CFM\_MEP DB.

### Command Syntax

```
clear ethernet cfm delay-measurement history mep <1-8191> domain DOMAIN_NAME ma
    MA_NAME
```

### Parameters

MEPID	Local MEP identifier <1-8191>
DOMAIN_NAME	Enter the name of the domain. Name must be of 5 characters if type is character-string otherwise no_name if domain-type is no-name1
MA_NAME	Enter maintenance association name. If ma-type is character string then maximum length of ma-name is 6 else if it's integer then maximum is 2-octets.

### Command Mode

Exec mode and Privileged Exec mode

### Applicability

This command was introduced in OcNOS version 3.0.

### Example

```
#clear ethernet cfm delay-measurement history mep 123 domain no_name ma 53322
```

---

## clear ethernet cfm dm history

Use this command to clear the CFM frame delay measurement history statistics from CFM\_MEP DB.

### Command Syntax

```
clear ethernet cfm dm history mep MEPID domain DOMAIN_NAME ma MA_NAME
```

### Parameters

MEPID	Local MEP identifier <1-8191>
DOMAIN_NAME	Enter the name of the domain. Name must be of 5 characters if type is character-string otherwise no_name if domain-type is no-name1
MA_NAME	Enter maintenance association name. If ma-type is character string then maximum length of ma-name is 6 else if it's integer then maximum is 2-octets.

### Command Mode

Exec mode and Privileged Exec mode

### Applicability

This command was introduced in OcNOS version 3.0.

### Example

```
#clear ethernet cfm dm history mep 123 domain no_name ma 123
```



---

## clear ethernet cfm lm history

Use this command to clear the CFM frame loss measurement history statistics.

### Command Syntax

```
clear ethernet cfm lm history mep MEPID domain DOMAIN_NAME ma MA_NAME s
```

### Parameters

MEPID	Local MEP identifier <1-8191>
DOMAIN_NAME	Enter the name of the domain. Name must be of 5 characters if type is character-string otherwise no_name if domain-type is no-name1
MA_NAME	Enter maintenance association name. If ma-type is character string then maximum length of ma-name is 6 else if it's integer then maximum is 2-octets.

### Command Mode

Exec mode and Privileged Exec mode

### Applicability

This command was introduced in OcNOS version 3.0.

### Example

```
#clear ethernet cfm lm history mep 201 domain 12345 ma 123
```

---

## clear ethernet cfm loss-measurement history

Use this command to clear the CFM frame loss measurement history statistics.

### Command Syntax

```
clear ethernet cfm loss-measurement history mep <1-8191> domain DOMAIN_NAME ma
MA_NAME
```

### Parameters

MEPID	Local MEP identifier <1-8191>
DOMAIN_NAME	Enter the name of the domain. Name must be of 5 characters if type is character-string otherwise no_name if domain-type is no-name1
MA_NAME	Enter maintenance association name. If ma-type is character string then maximum length of ma-name is 6 else if it's integer then maximum is 2-octets.

### Command Mode

Exec mode and Privileged Exec mode

### Applicability

This command was introduced in OcNOS version 3.0.

### Example

```
#clear ethernet cfm loss-measurement history mep 201 domain 12345 ma 4327
```

---

## clear ethernet cfm maintenance-point remote

Use this command to remove a dynamically learned RMEP.

The RMEP is relearned if [rmep auto-discovery](#) is enabled and a CCM (Continuity Checking Message) is received.

### Command Syntax

```
clear ethernet cfm maintenance-points remote domain <DOMAIN-NAME>
```

### Parameters

DOMAIN_NAME	Enter the name of the domain. Name must be of 5 characters if type is character-string otherwise no_name if domain-type is no-name1
-------------	---

### Command Mode

Exec mode

### Applicability

This command was introduced in OcNOS version 3.0.

### Example

```
#clear ethernet cfm maintenance-points remote domain
```

---

## clear ethernet cfm statistics

Use this command to clear the CFM statistics.

### Command Syntax

```
clear ethernet cfm statistics
clear ethernet cfm statistics mep <MEPID> domain <DOMAIN_NAME> ma <MA_NAME>
```

### Parameters

MEPID	MEP identifier <1-8191>
DOMAIN_NAME	Enter the name of the domain. Name must be of 5 characters if type is character-string otherwise no_name if domain-type is no-name1
MA_NAME	Enter maintenance association name. If ma-type is character string then maximum length of ma-name is 6 else if it's integer then maximum is 2-octets.

### Command Mode

Exec mode

### Applicability

This command was introduced in OcNOS version 3.0.

### Example

```
OcNOS#clear ethernet cfm statistics
```

---

## clear ethernet cfm statistics bn

Use this command to clear the CFM Eth-BNM statistics.

### Command Syntax

```
clear ethernet cfm statistics bn mep <MEPID> domain <DOMAIN_NAME> ma <MA_NAME>
```

### Parameters

MEPID	MEP identifier <1-8191>
DOMAIN_NAME	Enter the name of the domain. Name must be of 5 characters if type is character-string otherwise no_name if domain-type is no-name1
MA_NAME	Enter maintenance association name. If ma-type is character string then maximum length of ma-name is 6 else if it's integer then maximum is 2-octets.

### Command Mode

Exec mode

### Applicability

This command was introduced in OcNOS version 5.2.

### Example

```
OcNOS#clear ethernet cfm statistics bn mep 123 domain 12345 ma 123
```

---

## clear ethernet cfm statistics lck

Use this command to clear the CFM Eth-LCK statistics.

### Command Syntax

```
clear ethernet cfm statistics lck mep <MEPID> domain <DOMAIN_NAME> ma <MA_NAME>
```

### Parameters

MEPID	MEP identifier <1-8191>
DOMAIN_NAME	Enter the name of the domain. Name must be of 5 characters if type is character-string otherwise no_name if domain-type is no-name1
MA_NAME	Enter maintenance association name. If ma-type is character string then maximum length of ma-name is 6 else if it's integer then maximum is 2-octets.

### Command Mode

Exec mode

### Applicability

This command was introduced in OcNOS version 6.3.0.

### Example

```
OcNOS#clear ethernet cfm statistics lck mep 1 domain md001 ma ma01
```

---

## clear ethernet cfm statistics test-signal

Use this command to clear the CFM ETH-Test receiver or generator statistics.

### Command Syntax

```
clear ethernet cfm statistics test-signal domain <DOMAIN_NAME> ma <MANAME> mep
<MEPID> stats (CTF|GTF)
```

### Parameters

MEPID	MEP identifier <1-8191>
DOMAIN_NAME	Enter the name of the domain. Name must be of 5 characters if type is character-string otherwise no_name if domain-type is no-name1
MA_NAME	Enter maintenance association name. If ma-type is character string then maximum length of ma-name is 6 else if it's integer then maximum is 2-octets.
CTF	ETH Test Frame Collector statistics
GTF	ETH Test Frame Generator statistics

### Command Mode

Exec mode

### Applicability

This command was introduced in OcNOS version 6.3.0.

### Example

```
OcNOS#clear ethernet cfm statistics test-signal domain md001 ma ma01 mep 1
stats gtf
OcNOS#clear ethernet cfm statistics test-signal domain md001 ma ma01 mep 2
stats ctf
```

---

## clear ethernet cfm traceroute-cache

Use this command to clear the CFM traceroute cache entry.

### Command Syntax

```
clear ethernet cfm traceroute-cache
```

### Parameters

None

### Command Mode

Exec mode

### Applicability

This command was introduced in OcNOS version 3.0.

### Example

```
#clear ethernet cfm traceroute-cache
```



---

## csf receive

Use this command to create Eth-CSF configuration and to enable/disable Eth-CSF for the Mep.

### Command Syntax

```
csf receive
no csf receive
```

### Parameters

None

### Default

Eth-CSF is disabled by default.

### Command Mode

Exec mode

### Applicability

This command was introduced in OcNOS version 5.2.

### Example

```
OcNOS(config)#ethernet cfm domain-type character-string domain-name abcde level 5
OcNOS(config-ether-cfm)#service ma-type string ma-name testtm
OcNOS(config-ether-cfm-ma)#vlan 5 bridge 10
OcNOS(config-ether-cfm-ma)#ethernet cfm mep down mpid 201 active true xe2
OcNOS(config-ether-cfm-ma-mep)#csf receive
OcNOS(config-ether-cfm-ma-mep-csf)#commit
```

## debug ethernet cfm

Use this command to enable debug for ethernet cfm .

Use `no` from of this command to disable debug for ethernet cfm

### Command Syntax

```
debug ethernet cfm (all|events|rx|tx|loopback|traceroute)
no debug ethernet cfm (all|events|rx|tx|loopback|traceroute)
```

### Parameters

<code>all</code>	Enable all debugs
<code>events</code>	Enable event debugs
<code>loopback</code>	Enable loopback debugs
<code>rx</code>	Enable receive debugs
<code>traceroute</code>	Enable traceroute debugs
<code>tx</code>	Enable transmit debugs

### Default

None

### Command Mode

Configure mode

### Applicability

This command was introduced in OcNOS version 5.0 and option `all` is introduced in OcNOS version 6.3.0.

### Examples

```
OcNOS(config)#debug ethernet cfm events
OcNOS(config)#debug ethernet cfm loopback
OcNOS(config)#debug ethernet cfm rx
OcNOS(config)#debug ethernet cfm tx
OcNOS(config)#debug ethernet cfm traceroute
OcNOS(config)#no debug ethernet cfm events
OcNOS(config)#no debug ethernet cfm loopback
OcNOS(config)#no debug ethernet cfm rx
OcNOS(config)#no debug ethernet cfm tx
OcNOS(config)#no debug ethernet cfm traceroute
OcNOS(config)#debug ethernet cfm all
OcNOS(config)#no debug ethernet cfm all
```

---

## delay-measurement type on-demand

Use this command to schedule an on-demand CFM delay measurement session.

### Command Syntax

```
delay-measurement type on-demand profile-name WORD rmep (mac-address MAC|RMEPID)
  start-time (immediate|relative HH:MM:SS|absolute HH:MM:SS <1-31> MONTH <1993-
  2035>) repetition-period <6000-4294967295> mep MEPID domain DOMAIN_NAME
```

### Parameters

WORD	Delay measurement profile name
MAC	Destination MAC address in HHHH.HHHH.HHHH format
RMEPID	Destination peer MEP identifier <1-8191>
start-time	Measurement session start time
immediate	Start immediately
relative HH:MM:SS	Relative time to start from the current system time
absolute HH:MM:SS <1-31> MONTH <1993-2035>	Scheduled date and time to start; for the month, specify the first three letters
stop-time	Measurement session stop time
none	Never stop
relative HH:MM:SS	Relative time to stop from the current system time
absolute HH:MM:SS <1-31> MONTH <1993-2035>	Scheduled date and time to stop; for the month, specify the first three letters
<6000-4294967295>	Repetition time in centiseconds
MEPID	Local MEP identifier <1-8191>
DOMAIN_NAME	Enter the name of the domain. Name must be of 5 characters if type is character-string otherwise no_name if domain-type is no-name1
MA_NAME	Enter maintenance association name. If ma-type is character string then maximum length of ma-name is 6 else if it's integer then maximum is 2-octets.

### Command Mode

Exec mode and Privileged Exec mode

### Applicability

This command was introduced in OcNOS version 3.0.

### Example

```
#delay-measurement type on-demand profile-name PROF1 rmep 101 start-time relative
00:00:03 stop-time relative 00:03:00 repetition-period 7000 mep 123 domain no_name ma
123
```



---

## delay-measurement type proactive

Use this command to configure and start a proactive CFM delay measurement session.

### Command Syntax

```
delay-measurement type proactive profile-name WORD rmep (mac-address MAC|RMEPID)
mep MEPID domain DOMAIN_NAME ma MA_NAME
```

### Parameters

WORD	Delay measurement profile name
MAC	Destination MAC address in HHHH.HHHH.HHHH format
RMEPID	Remote MEP identifier <1-8191>
MEPID	Local MEP identifier <1-8191>
DOMAIN_NAME	Enter the name of the domain. Name must be of 5 characters if type is character-string otherwise no_name if domain-type is no-name1
MA_NAME	Enter maintenance association name. If ma-type is character string then maximum length of ma-name is 6 else if it's integer then maximum is 2-octets.

### Command Mode

Exec mode and Privileged Exec mode

### Applicability

This command was introduced in OcNOS version 3.0.

### Example

```
#delay-measurement type proactive profile-name 123 rmep 101 mep 123 domain no_name ma
123
```

---

## ethernet cfm delay-measurement profile-name

Use this command to create a CFM frame delay measurement profile and enter Ethernet CFM delay measurement mode.

Use the no form of this command to remove a CFM delay measurement profile.

### Command Syntax

```
ethernet cfm delay-measurement profile-name WORD
no ethernet cfm delay-measurement profile-name WORD
```

### Parameters

WORD	Profile name
------	--------------

### Command Mode

Configure mode

### Applicability

This command was introduced in OcNOS version 3.0.

### Example

```
#configure terminal
(config)#ethernet cfm delay-measurement profile-name PROF1
(config-cfm-dm)#
```

---

## ethernet cfm delay-measurement reply

Use this command to enable transmission of DMR (Delay Measurement Reply) PDUs for received DMMs (Delay Measurement Messages).

After this command is given, a delay measurement session cannot be configured to send DMMs. In that case, the device can only generate DMRs for received DMM PDUs.

Use the no form of this command to disable sending DMR PDUs. After no command is given we can thereby configure a delay measurement session to send DMMs if we need.

### Command Syntax

```
ethernet cfm delay-measurement reply dmm
no ethernet cfm delay-measurement reply dmm
```

### Parameters

None

### Command Mode

Ethernet CFM MA MEP mode

### Applicability

This command was introduced in OcNOS version 3.0.

### Example

```
OcNOS#configure terminal
OcNOS(config)# ethernet cfm domain-type no-name domain-name no_name level 4
OcNOS(config-ether-cfm)#service ma-type string ma-name 7
OcNOS(config-ether-cfm-ma)#vlan 10 bridge 10
OcNOS(config-ether-cfm-ma)#ethernet cfm mep down mpid 100 active true xe9
OcNOS(config-ether-cfm-ma-mep)#ethernet cfm delay-measurement reply dmm
```

---

## ethernet cfm domain-type

Use this command to create a CFM Maintenance Domain (MD) in a bridge and enter Ethernet CFM mode.

Use the `no` form of this command to remove a domain.

Note: You can create up to 15 MDs in a bridge.

Only one domain can be created without any domain name in a bridge.

A domain name of type `character-string` can only be created only after the [hardware-profile filter cfm-domain-name-str](#) command is executed.

### Command Syntax

```
ethernet cfm domain-type (no-name|character-string) domain-name DOMAIN_NAME level
<0-7> mip-creation (none|default|explicit) |
no ethernet cfm domain-name DOMAIN_NAME
```

### Parameters

<code>domain-type</code>	Domain type (must match <a href="#">service ma-type</a> setting)
<code>no-name</code>	No MD name. The <code>ma-type</code> must be integer or <code>itu-t</code> carrier code (ICC) format defined by Y.1731.
<code>character-string</code>	Character string name. The <code>ma-type</code> must be string.
<code>DOMAIN_NAME</code>	Enter the name of the domain. Name must be of 5 characters if type is <code>character-string</code> otherwise <code>no_name</code> if <code>domain-type</code> is <code>no-name1</code>
<code>&lt;0-7&gt;</code>	MD level
<code>mip-creation</code>	Maintenance Intermediate Point (MIP) creation permission for this domain
<code>none</code>	No MIP can be created for this VLAN identifier
<code>default</code>	MIP can be created if no lower active level or MEP at next lower active level
<code>explicit</code>	Maintenance End Point (MEP) is needed at the next lower active level

### Command Mode

Configure mode

### Applicability

This command was introduced in OcnOS version 3.0.

### Examples

```
OcNOS (config) #
OcNOS (config) # ethernet cfm domain-type character-string domain-name 12347
level 7 mip-creation none
OcNOS (config-ether-cfm) #
```



---

## ethernet cfm loss-measurement profile-name

Use this command to create a CFM frame loss measurement profile and enter Ethernet CFM loss measurement mode. Use the `no` form of this command to remove a CFM loss measurement profile.

### Command Syntax

```
ethernet cfm loss-measurement profile-name WORD
no ethernet cfm loss-measurement profile-name WORD
```

### Parameters

WORD	Profile name
------	--------------

### Command Mode

Configure mode

### Applicability

This command was introduced in OcNOS version 3.0.

### Example

```
#configure terminal
(config)#ethernet cfm loss-measurement profile-name PROF1
(config-cfm-lm)#
```

---

## ethernet cfm loss-measurement reply

Use this command to enable transmission of SLR (Synthetic Loss Reply) PDUs for received SLMs (Synthetic Loss Messages) and to enable transmission of LMR (Loss Measurement Reply) PDUs for received LMMs (Loss Measurement Messages).

After this command is given, a loss measurement session cannot be configured to send SLMs. In that case, the device can only generate SLRs for received SLM PDUs. The same is true for LMM/LMR also.

Use the `no` form of this command to disable sending SLR/LMR PDUs.

### Command Syntax

```
ethernet cfm loss-measurement reply (slm | lmm)
no ethernet cfm loss-measurement reply (slm | lmm)
```

### Parameters

<code>slm</code>	Synthetic Loss Messages
<code>lmm</code>	Loss Measurement Messages

### Command Mode

Ethernet CFM MA MEP mode

### Applicability

This command was introduced in OcNOS version 3.0.

### Example

```
#configure terminal
(config)# ethernet cfm domain-type no-name domain-name no_name level 4 mip-creation none
OcNOS(config-ether-cfm)#service ma-type string ma-name 7
OcNOS(config-ether-cfm-ma)#vlan 10 bridge 1
OcNOS(config-ether-cfm-ma)#mip-creation none
OcNOS(config-ether-cfm-ma)#ethernet cfm mep down mpid 100 active true xe9
OcNOS(config-ether-cfm-ma-mep)#ethernet cfm loss-measurement reply slm
```

---

## ethernet cfm mep

Use this command to create a Maintenance End Point (MEP), make it active or inactive and enter Ethernet CFM MA MEP mode.

A MEP created with the `active false` option remains inactive and CFM functionality is suspended for such a MEP.

Note: For a VPWS instance, only an up MEP can be created; a down MEP cannot be created for VPWS.

Use the `no` form of this command to delete a MEP.

### Command Syntax

```
ethernet cfm mep (down|up) mpid <1-8191> active (false|true) (IFNAME|vpws VCNAME |
  evpn <1-16777215>)
no ethernet cfm mpid <1-8191>
```

### Parameters

<code>down</code>	Down MEP
<code>up</code>	Up MEP
<code>active</code>	Administrative state of the MEP
<code>true</code>	Make the MEP active
<code>false</code>	Make the MEP inactive
<code>IFNAME</code>	Interface name
<code>VCNAME</code>	Virtual circuit name
<code>evpn &lt;ID&gt;</code>	EVPN instance ID

### Command Mode

Ethernet CFM MA mode

### Applicability

This command was introduced in OcNOS version 3.0.

### Example

```
OcNOS(config)#ethernet cfm domain-type character-string domain-name 12345
level 7
OcNOS(config-ether-cfm)#service ma-type string ma-name 43982
OcNOS(config-ether-cfm-ma)#vlan 10 bridge 10
OcNOS(config-ether-cfm-ma)#ethernet cfm mep down mpid 81 active true xe2
```

## ethernet cfm mip

Use this command to create a static MIP on an interface.

Use the `no` form of this command to remove a static MIP from an interface.

### Command Syntax

```
ethernet cfm mip interface IFNAME
no ethernet cfm mip interface IFNAME
```

### Parameters

IFNAME	Interface name of MIP
--------	-----------------------

### Command Mode

Ethernet CFM MA mode

### Applicability

This command was introduced in OcNOS version 3.0.

### Example

```
OcNOS#con term
Enter configuration commands, one per line. End with CNTL/Z.
OcNOS(config)#ethernet cfm domain-type character-string domain-name 12345
level 7 mip-creation default
OcNOS(config-ether-cfm)# service ma-type string ma-name ma1
OcNOS(config-ether-cfm-ma)# vlan 25 bridge 1
OcNOS(config-ether-cfm-ma)# mip-creation default
OcNOS(config-ether-cfm-ma)# ethernet cfm mip interface ge5
OcNOS(config-ether-cfm-ma)#no ethernet cfm mip interface ge5
```

---

## ethernet cfm statistics csf

Use this command to clear the CFM Eth-CSF statistics.

### Command Syntax

```
clear ethernet cfm statistics csf mep <MEPID> domain <DOMAIN_NAME> ma <MA_NAME>
```

### Parameters

MEPID	MEP identifier <1-8191>
DOMAIN_NAME	Enter the name of the domain. Name must be of 5 characters if type is character-string otherwise no_name if domain-type is no-name1
MA_NAME	Enter maintenance association name. If ma-type is character string then maximum length of ma-name is 6 else if it's integer then maximum is 2-octets.

### Command Mode

Exec mode

### Applicability

This command was introduced in OcNOS version 5.2.

### Example

```
OcNOS#clear ethernet cfm statistics csf mep 123 domain 12345 ma 123
```

---

## ethernet cfm test-signal profile-name

Use this command to create a test signal configuration profile associated with a specific MEP.

Use `no` form of this command to delete a test signal configuration profile.

### Command Syntax

```
ethernet cfm test-signal profile-name WORD
no ethernet cfm test-signal profile-name WORD
```

### Parameters

<code>profile-name</code>	Specify a profile-name
<code>WORD</code>	Specify the test signal profile name with max length of 64 characters

### Command Mode

Configure mode

### Applicability

This command was introduced in OcNOS version 4.0.

### Example

```
#configure terminal
(config)#ethernet cfm test-signal profile-name 123
(config-cfm-eth-tst)#

(config)#no ethernet cfm test-signal profile-name 123
```

## evpn

Use this command to create a service Maintenance Association (MA), with EVPN.

### Command Syntax

```
evpn <ID>
```

### Parameters

<1-16777215> Enter the EVPN ID. Range(1-16777215)

### Command Mode

Ethernet CFM MA mode

### Applicability

This command was introduced in OcNOS-SP version 6.1.0

### Example

```
#configure terminal
OcNOS(config)#ethernet cfm domain-type character-string domain-name 12345 level 7
OcNOS(config-ether-cfm)#service ma-type string ma-name 43982
OcNOS(config-ether-cfm-ma)#evpn 100
OcNOS(config-ether-cfm-ma)#ethernet cfm mep up mpid 103 active true evpn 100
```

---

## ethernet cfm traceroute cache

Use this command to set the cache size for traceroute output.

Use the `no` form of this command to set the cache size to its default (100).

### Command Syntax

```
ethernet cfm traceroute cache size <1-4095>
no ethernet cfm traceroute cache size <1-4095>
```

### Parameters

<1-4095>	Number of entries in cache
----------	----------------------------

### Default

100 entries

### Command Mode

Configure mode

### Applicability

This command was introduced in OcNOS version 3.0.

### Example

```
#configure terminal
(config)#ethernet cfm traceroute cache size 1
```



---

## exit-ether-ma-mep-mode

Use this command to exit Ethernet CFM MA MEP mode and go back to Ethernet CFM MA mode.

### Command Syntax

```
exit-ether-ma-mep-mode
```

### Parameters

None

### Command Mode

Ethernet CFM MA MEP mode

### Applicability

This command was introduced in OcNOS version 3.0.

### Examples

```
OcNOS#configure terminal
OcNOS(config)#ethernet cfm domain-type character-string domain-name 12345 level 7
OcNOS(config-ether-cfm)# service ma-type string ma-name testtm
OcNOS(config-ether-cfm-ma)#vlan 5 bridge 10
OcNOS(config-ether-cfm-ma)#ethernet cfm mep down mpid 201 active true xe2
OcNOS(config-ether-cfm-ma-mep)#exit-ether-ma-mep-mode
```

---

## exit-ether-ma-mode

Use this command to exit Ethernet CFM MA mode and go back to Ethernet CFM mode.

### Command Syntax

```
exit-ether-ma-mode
```

### Parameters

None

### Command Mode

Ethernet CFM MA mode

### Applicability

This command was introduced in OcnOS version 3.0.

### Examples

```
OcnOS#configure terminal
OcnOS(config)#ethernet cfm domain-type character-string domain-name 12345
level 7
OcnOS(config-ether-cfm)#service ma-type string ma-name testtm
OcnOS(config-ether-cfm-ma)#exit-ether-ma-mode
```

## frame priority

Use this command to set/reset the PDU frame priority in the Eth-lock.

### Command Syntax

```
frame priority <0-7>
no frame priority
```

### Parameters

<0-7>                   Set the PDU priority range.

### Command Mode

Ethernet CFM MA MEP LCK mode

### Applicability

This command was introduced in OcNOS version 4.0.

### Example

```
OcNOS#configure terminal
OcNOS(config)#ethernet cfm domain-type character-string domain-name 12345
level 7
OcNOS(config-ether-cfm)# service ma-type string ma-name ma1
OcNOS(config-ether-cfm-ma)# vlan 25 bridge 10
OcNOS(config-ether-cfm-ma)#ethernet cfm mep down mpid 201 active true xe2
OcNOS(config-ether-cfm-ma-mep)#lck state
OcNOS(config-ether-cfm-ma-mep-lck)#frame priority 3
```

---

## hardware-profile filter cfm-domain-name-str

Use this command to enable or disable setting the CFM domain name as a character string.

**Note:** The `hardware-profile filter cfm-domain-name-str enable` command is only applicable for Qumran platforms and not J2C platforms.

### Command Syntax

```
hardware-profile filter cfm-domain-name-str (enable|disable)
```

### Parameters

<code>enable</code>	Enable CFM domain name as a character string
<code>disable</code>	Disable CFM domain name as a character string

### Default

Disabled

### Command Mode

Configure mode

### Applicability

This command was introduced in OcNOS version 3.0.

### Example

```
#configure terminal  
(config)#hardware-profile filter cfm-domain-name-str enable
```

## interval

Use this command to set/reset the PDU interval for Eth-lock.

### Command Syntax

```
interval (1s|1m)
no interval
```

### Parameters

1m	Transmit interval one minute.
1s	Transmit interval one second

### Command Mode

Ethernet CFM MA MEP LCK mode

### Applicability

This command was introduced in OcNOS version 4.0.

### Example

```
OcNOS#configure terminal
```

Enter configuration commands, one per line. End with CNTL/Z.

```
OcNOS(config)#ethernet cfm domain-type character-string domain-name mdnam
level 7
OcNOS(config-ether-cfm)# service ma-type string ma-name testtm
OcNOS(config-ether-cfm-ma)#vlan 5 bridge 10
OcNOS(config-ether-cfm-ma)#ethernet cfm mep down mpid 2 active true xe14
OcNOS(config-ether-cfm-ma-mep)lck state
OcNOS(config-ether-cfm-ma-mep-lck)#interval 1m
OcNOS(config-ether-cfm-ma-mep-lck)#interval 1s
```

---

## intervals-stored

Use this command to set the number of frame loss measurement intervals to store in the history table.

Use the no form to set the number of measurement intervals to its default (32).

### Command Syntax

```
intervals-stored <2-1000>
no intervals-stored
```

### Parameters

<2-1000>            Time intervals

### Default

32

### Command Mode

Ethernet CFM loss measurement mode

### Applicability

This command was introduced in OcNOS version 3.0.

### Example

```
#configure terminal
(config)#ethernet cfm loss-measurement profile-name PROF1
(config-cfm-lm)#intervals-stored 50
```

## lck state

Use this command to enable or disable ETH-Lock PDU transmission.

Use no form to remove the command.

### Command Syntax

```
lck state (unlock|lock)
no lck state
```

### Parameters

unlock	Display ethernet lock PDU transmission
lock	Enable ethernet lock PDU transmission

### Command Mode

Ethernet CFM MA MEP mode.

Default lock state is Unlock.

### Applicability

This command was introduced in OcNOS version 4.0.

### Example

```
OcNOS#configure terminal
OcNOS(config)#ethernet cfm domain-type character-string domain-name 12345
level 7
OcNOS(config-ether-cfm)# service ma-type string ma-name testtm
OcNOS(config-ether-cfm-ma)#vlan 5 bridge 10
OcNOS(config-ether-cfm-ma)#ethernet cfm mep down mpid 201 active true xe2
OcNOS(config-ether-cfm-ma-mep)#lck state lock
OcNOS(config-ether-cfm-ma-mep-lck)#
```

---

## link-level

Use this command to create a maintenance association for link-level MEPs (level 0) which do not listen on a VLAN.

### Command Syntax

```
link-level (bridge <1-32>|)
```

### Parameters

<1-32>	Bridge id
--------	-----------

### Command Mode

Ethernet CFM MA mode

### Applicability

This command was introduced in OcNOS-SP version 5.1.

### Example

```
OcNOS#configure terminal
OcNOS(config)#ethernet cfm domain-type character-string domain-name 12345 level 0
OcNOS(config-ether-cfm)#service ma-type string ma-name ma1
OcNOS(config-ether-cfm-ma)#link-level
OcNOS(config-ether-cfm-ma)#ethernet cfm mep down mpid 2331 active true xe2
```



---

## loss-measurement type on-demand

Use this command to schedule an on-demand CFM loss measurement session.

### Command Syntax

```
loss-measurement type on-demand profile-name WORD rmep (mac-address MAC|mep-id
  MEPID) start-time (immediate|relative HH:MM:SS|absolute HH:MM:SS <1-31> MONTH
  <1993-2035>) stop-time (none|relative HH:MM:SS|absolute HH:MM:SS <1-31> MONTH
  <1993-2035>) repetition-period <6000-4294967295> mep MEPID domain DOMAIN_NAME
  ma MA_NAME
```

### Parameters

WORD	Loss measurement profile name
MAC	Destination MAC address in HHHH.HHHH.HHHH format
MEPID	Remote MEP identifier <1-8191> to which to send the service OAM loss measurement frame
start-time	Measurement session start time
immediate	Start immediately
relative HH:MM:SS	Relative time to start from the current system time
absolute HH:MM:SS <1-31> MONTH <1993-2035>	Scheduled date and time to start; for the month, specify the first three letters
stop-time	Measurement session stop time
none	Never stop
relative HH:MM:SS	Relative time to stop from the current system time
absolute HH:MM:SS <1-31> MONTH <1993-2035>	Scheduled date and time to stop; for the month, specify the first three letters
repetition-period	Repetition time between measurement intervals
<0-4294967295>	Repetition time in seconds
MEPID	Remote MEP identifier <1-8191> to which to send the service OAM loss measurement frame
DOMAIN_NAME	Enter the name of the domain. Name must be of 5 characters if type is character-string otherwise no_name if domain-type is no-name1
MA_NAME	MA name

### Command Mode

Exec mode and Privileged Exec mode

## Applicability

This command was introduced in OcnOS version 3.0.

## Example

```
#loss-measurement type on-demand profile-name slm rmep mac-address 0018.2323.1234  
start-time immediate stop-time none repetition-period 9000 mep 201 domain 12345 ma 123
```

---

## loss-measurement type proactive

Use this command to configure and start a proactive CFM loss measurement session.

### Command Syntax

```
loss-measurement type proactive profile-name WORD rmep (mac-address MAC) mep MEPID
domain DOMAIN_NAME ma MA_NAME
```

### Parameters

WORD	Loss measurement profile name
rmep	Remote MEP
MAC	Destination MAC address in HHHH.HHHH.HHHH format
MEPID	Remote MEP identifier <1-8191> to which to send the service OAM loss measurement frame
mep	MEP
MEPID	MEP identifier <1-8191>
DOMAIN_NAME	Enter the name of the domain. Name must be of 5 characters if type is character-string otherwise no_name if domain-type is no-name1
MA_NAME	MA name

### Command Mode

Exec mode and Privileged Exec mode

### Applicability

This command was introduced in OcNOS version 3.0.

### Example

```
#loss-measurement type proactive profile-name slm rmep mac-address
0018.2323.1234 mep 201 domain 12345 ma 123
```

## measurement-interval

Use this command to set the measurement interval for frame loss or delay measurement session.

Use the no form of this command to set the measurement interval to its default value (15 minutes).

### Command Syntax

Loss measurement:

```
measurement-interval <1-525600>
no measurement-interval
```

Delay measurement:

```
measurement-interval <1-1440>
no measurement-interval
```

### Parameters

For frame loss measurement:

<1-525600>            Measurement interval in minutes

For frame delay measurement:

<1-1440>             Measurement interval in minutes

### Default

15 minutes

### Command Mode

Ethernet CFM loss measurement mode and Ethernet CFM delay measurement mode

### Applicability

This command was introduced in OcNOS version 3.0.

### Example

Loss measurement:

```
#configure terminal
(config)#ethernet cfm loss-measurement profile-name PROF1
(config-cfm-lm)#measurement-interval 500
```

Delay measurement:

```
#configure terminal
(config)#ethernet cfm delay-measurement profile-name PROF1
(config-cfm-dm)# measurement-interval 1
```

---

## measurement-type slm

Use this command to generate Frame Loss Message (SLM/LMM) service OAM PDUs and track replies (SLR/LMR).

The measurement-type CCM is a dual-ended frame loss method in which generated CCM PDUs carry frame loss measurement information (TxFCf, RxFCb and TxFCb).

Use the no form of this command to set the measurement type to its default value (slm).

SLM and LMM cannot be enabled at the same time. All MEPs can use either LMM or SLM for frame loss measurement.

### Command Syntax

```
measurement-type (slm | lmm | ccm)
no measurement-type
```

### Parameters

slm	SLM service PDUs are generated and SLRs is tracked for frame loss measurement.
lmm	LMM service PDUs are generated and LMRs is tracked for frame loss measurement.
ccm	CCM PDUs are used for frame loss measurement which carries frame loss measurement information.

### Command Mode

Ethernet CFM loss measurement mode

### Applicability

This command was introduced in OcNOS version 3.0.

### Example

```
#configure terminal
(config)#ethernet cfm loss-measurement profile-name PROF1
(config-cfm-lm)#measurement-type slm
```

---

## mep crosscheck

Use this command to configure a remote MEP crosscheck.

Use the `no` form of this command to delete a crosscheck MEP.

### Command Syntax

```
mep crosscheck mpid MEPID
no mep crosscheck mpid MEPID
```

### Parameters

MEPID	Remote host MEP identifier <1-8191>
-------	-------------------------------------

### Command Mode

Ethernet CFM MA mode

### Applicability

This command was introduced in OcNOS version 3.0.

### Example

```
OcNOS#configure terminal
OcNOS(config)#ethernet cfm domain-type character-string domain-name 12345 level 7
OcNOS(config-ether-cfm)# service ma-type string ma-name testtm
OcNOS(config-ether-cfm-ma)#vlan 5 bridge 10
OcNOS(config-ether-cfm-ma)#mep crosscheck mpid 51
```

---

## mep lowest-priority-defect

Use this command to set the lowest-priority defect that can generate a fault alarm.

Use the `no` form of this command to set the lowest-priority defect to its default (`defMACstatus`).

### Command Syntax

```
mep lowest-priority-defect
    (defRDICCM|defMACstatus|defRemoteCCM|defErrorCCM|defXconCCM)
no mep lowest-priority-defect
```

### Parameters

<code>defRDICCM</code>	1 (lowest): At least one of the Remote MEP state machines is receiving valid CCMs from its remote MEP that has the Remote Defect Indication (RDI) bit set.
<code>defMACstatus</code>	2: One or more of the remote MEPs is reporting a failure in its Port Status Type-Length-Value (TLV) or Interface Status TLV: MEP Down.
<code>defRemoteCCM</code>	3: At least one of the remote MEP state machines is not receiving valid CCMs from its remote MEP.
<code>defErrorCCM</code>	4: One or more invalid CCMs has been received, and 3.5 times the CCMs' transmission interval has not yet expired.
<code>defXconCCM</code>	5: (highest): One or more cross-connect continuity check messages (CCMs) has been received, and 3.5 times at least one of those CCMs' transmission interval has not yet expired.

### Default Value

`defMACstatus`

### Command Mode

Ethernet CFM MA MEP mode

### Applicability

This command was introduced in OcNOS version 3.0.

### Example

```
OcNOS#configure terminal
OcNOS(config)#ethernet cfm domain-type character-string domain-name 12345 level 7
OcNOS(config-ether-cfm)#service ma-type string ma-name testtm
OcNOS(config-ether-cfm-ma)#vlan 5 bridge 10
OcNOS(config-ether-cfm-ma)#ethernet cfm mep down mpid 201 active true xe2
OcnOS(config-ether-cfm-ma-mep)#mep lowest-priority-defect defRemoteCCM
```

---

## message level

Use this command to set the PDU MD level for Eth-lock.

### Command Syntax

```
message level <0-7>
no message level
```

### Parameters

<0-7>                   Set the level of the MD PDU.

### Command Mode

Ethernet CFM MA MEP LCK mode

### Applicability

This command was introduced in OcNOS version 4.0.

### Example

```
OcNOS#configure terminal
OcNOS(config)#ethernet cfm domain-type character-string domain-name 12345
level 7
OcNOS(config-ether-cfm)# service ma-type string ma-name testtm
OcNOS(config-ether-cfm-ma)#vlan 5 bridge 10
OcNOS(config-ether-cfm-ma)#ethernet cfm mep down mpid 201 active true xe2
OcNOS(config-ether-cfm-ma-mep)#lck state
OcNOS(config-ether-cfm-ma-mep-lck)#message level 2
```



---

## message-period

Use this command to set the interval between loss or delay measurement OAM message transmission.

Use the no form of this command to set the interval between loss or delay measurement messages to its default value (1 second).

### Command Syntax

```
message-period (3ms|10ms|100ms|1s|10s)
no message-period
```

### Parameters

3ms	3 milliseconds
10ms	10 milliseconds
100ms	100 milliseconds
1s	1 second
10s	10 seconds

### Default Value

1 second

### Command Mode

Ethernet CFM loss measurement mode

Ethernet CFM delay measurement mode

### Applicability

This command was introduced in OcNOS version 3.0.

### Example

Loss measurement:

```
#configure terminal
(config)#ethernet cfm loss-measurement profile-name PROF1
(config-cfm-lm)#message-period 3ms
```

Delay measurement:

```
#configure terminal
(config)#ethernet cfm delay-measurement profile-name PROF1
(config-cfm-dm)#message-period 10s
```

---

## mip-creation

Use this command for Maintenance domain Intermediate Point (MIP) creation permission for this domain.

### Command Syntax

```
(mip-creation (none|default|explicit|defer)) |
```

### Parameters

mip-creation	Maintenance domain Intermediate Point (MIP) creation permission for this domain
none	No MIP can be created for this VLAN identifier
default	MIP can be created if no lower active level or MEP at the next lower active level
explicit	MEP is needed at the next lower active level
defer	Use the MIP creation permissions of the MD to which this MA belongs

### Command Mode

Ethernet CFM MA mode

### Applicability

This command was introduced in OcnOS-SP version 5.1.

### Example

```
OcnOS#configure terminal
OcnOS(config)#ethernet cfm domain-type character-string domain-name 12345 level 7 mip-
creation none
OcnOS(config-ether-cfm)#service ma-type string ma-name 43982
OcnOS(config-ether-cfm-ma)#vlan 10 bridge 10
OcnOS(config-ether-cfm-ma)#mip-creation none
OcnOS(config-ether-cfm-ma)#ethernet cfm mep down mpid 2331 active true xe2
```

---

## intervals-stored

Use this command to set the number of completed measurement intervals to store in the history statistic table for a two-way performance monitoring frame delay measurements on a specific MEP.

Use the no form to set the number of completed measurement intervals to store in the history statistic table for a two-way performance monitoring frame delay measurements on a specific MEP to its default (32).

### Command Syntax

```
intervals-stored <2-1000>
no intervals-stored
```

### Parameters

<2-1000>            Number of records to store in history

### Default

32

### Command Mode

Ethernet CFM delay measurement mode

### Applicability

This command was introduced in OcNOS version 3.0.

### Example

```
#configure terminal
(config)#ethernet cfm delay-measurement profile-name PROF1
(config-cfm-dm)# intervals-stored 4
```

---

## peer-port-id

Use this command to specify peer port-id for Eth-BNM. When this CLI is configured, received BNM PDU will be processed only if peer port-id value in PDU is same as configured peer-port-id. When this CLI is not configured, received BNM PDU is processed without peer port-id validation.

Use `no` form of CLI to unconfigure peer port id.

### Command Syntax

```
peer-port-id <1-4294967295>
no peer-port-id
```

### Parameters

<1-4294967295> Enter the peer port-id.Default is 0.

### Command Mode

Ethernet CFM MEP BNM mode

### Applicability

This command was introduced in OcnOS version 5.2.

### Examples

```
OcnOS#configure terminal
OcnOS(config)#ethernet cfm domain-type character-string domain-name 12345 level 7 m
OcnOS(config-ether-cfm)#service ma-type string ma-name 43982
OcnOS(config-ether-cfm-ma)#vlan 10 bridge 10
OcnOS(config-ether-cfm-ma)#ethernet cfm mep down mpid 2331 active true xe2
OcnOS(config-ether-cfm-ma-mep)# bn receive
OcnOS(config-ether-cfm-ma-mep-bn) peer-port-id 1234
```

---

## ping ethernet mac

Use this command to send a loopback message for a MAC address to a remote MEP for fault verification. Use either the `domain` or the `level` parameter with the `vlan` or `bridge` parameter to target a specific device.

### Command Syntax

```
ping ethernet mac MACADDRESS unicast source MEPID domain DOMAIN_NAME ma MA_NAME
```

### Parameters

MACADDRESS	Destination MAC address in HHHH.HHHH.HHHH format
MEPID	Source host MEP ID <1-8191>
DOMAIN_NAME	Enter the name of the domain. Name must be of 5 characters if type is character-string otherwise no_name if domain-type is no-name1
MA_NAME	MA name

### Command Mode

Exec mode and Privileged Exec mode

### Applicability

This command was introduced in OcNOS version 3.0.

### Examples

```
#ping ethernet mac 0018.236e.5eb5 unicast source 201 domain 12345 ma 123
```

---

## rmep auto-discovery

Use this command to enable or disable whether MEPs are discovered automatically based on received CCMs (Continuity Checking Messages).

On disabling RMEP auto-discovery, a previously learned RMEP is removed.

### Command Syntax

```
rmep auto-discovery enable|disable
```

### Parameters

enable	Enable automatic RMEP discovery
disable	Disable automatic RMEP discovery

### Default

disable

### Command Mode

Ethernet CFM MA mode

### Applicability

This command was introduced in OcnOS version 3.0.

### Examples

```
OcnOS#configure terminal
OcnOS(config)#ethernet cfm domain-type character-string domain-name 12345 level 7
OcnOS(config-ether-cfm)# service ma-type string ma-name testtm
OcnOS(config-ether-cfm-ma)#vlan 5 bridge 10
OcnOS(config-ether-cfm-ma)#rmep auto-discovery enable
```

---

## service ma-type

Use this command to create a service Maintenance Association (MA), and enter Ethernet CFM MA mode. This command allows creation of a maintenance association for link-level MEPs (level 0) which do not listen on a VLAN.

A VID can be associated with an MA after MA is created.

Use the `no` form of this command to remove an MA.

### Command Syntax

Ethernet CFM mode

```
service ma-type (string|integer|itu-t) ma-name MA_NAME
no service ma-name MA_NAME
```

### Command Mode

Ethernet CFM mode

### Applicability

This command was introduced in OcnOS version 3.0.

### Example

OcnOS#con term

Enter configuration commands, one per line. End with CNTL/Z.

```
OcnOS(config)#ethernet cfm domain-type character-string domain-name mdnam level 7
```

```
OcnOS(config-ether-cfm)#service ma-type string ma-name testtm
```

---

## show ethernet cfm ais reception-status

Use this command to display information about the AIS (Alarm Indication Signal) frames received on a MEP.

### Command Syntax

```
show ethernet cfm ais reception-status mep MEPID domain DOMAIN_NAME (ma-name MA_NAME
```

### Parameters

MEPID	Source host MEP ID <1-8191>
DOMAIN_NAME	Enter the name of the domain. Name must be of 5 characters if type is character-string otherwise no_name if domain-type is no-name1
MA_NAME	Maintenance association name (if type is character string maximum length of ma-name is 6. If type is integer maximum is 2-octets)
<1-32>	Bridge identifier

### Command Mode

Exec mode and Privileged Exec mode

### Applicability

This command was introduced in OcNOS version 3.0.

### Example

```
#show ethernet cfm ais reception-status mep 100 domain 12345
```



---

## show ethernet cfm bn

Use this command to display information about Eth-BNM.

### Command Syntax

```
show ethernet cfm bn
```

### Parameters

None

### Command Mode

Exec mode and Privileged Exec mode

### Applicability

This command was introduced in OcNOS version 5.2.

### Example

```
#show ethernet cfm bn
```

MEPID BW (Mbps)	Domain Current-BW (mbps)	MA-Name	Interface	VLAN	S-Addr	Port-ID	Nominal-
100 100	12345	123	xe2	100	00:00:11:11:11:11	100	200
200 300	12345	124	xe1	200	00:00:11:11:11:12	200	100
300 400	12445	123	xe3	300	00:00:11:11:11:13	100	300

---

## show ethernet cfm bn mep

Use this command to display detail information about Eth-BNM configured on MEP.

### Command Syntax

```
show ethernet cfm bn mep MEPID domain DOMAIN_NAME ma MA_NAME
```

### Parameters

MEPID	Source host MEP ID <1-8191>
DOMAIN_NAME	Enter the name of the domain. Name must be of 5 characters if type is character-string otherwise no_name if domain-type is no-name1
MA_NAME	Maintenance association name (if type is character string maximum length of ma-name is 6. If type is integer maximum is 2-octets)

### Command Mode

Exec mode and Privileged Exec mode

### Applicability

This command was introduced in OcNOS version 5.2.

### Example

```
#show ethernet cfm bn mep 100 domain 12345 ma 123
MA-Name : 223
MEL: 4
Admin Status : Enable
Interface : xe1
VLAN : 100
Source address : 00:00:11:11:11:11
Wait to Restore timer: 200 sec
  State : SIGNAL_DEGRADED
  Elapsed time in this state : 00:00:02
  Last BNM Received : 2022 Mar 03 17:19:23
  Nominal Bandwidth : 800 Mbps
  Current Bandwidth : 600 Mbps
  Port-Id : 2
  BNM Period : 1 sec
```

---

## show ethernet cfm csf

Use this command to display information about Eth-CSF.

### Command Syntax

```
show ethernet cfm csf
```

### Parameters

None

### Command Mode

Exec mode and Privileged Exec mode

### Applicability

This command was introduced in OcNOS version 5.2.

### Example

```
#show ethernet cfm csf
```

MEPID	Domain	MA-Name	Interface	VLAN	S-Addr
100	12345	123	xe2	100	00:00:11:11:11:11
200	12345	124	xe1	200	00:00:11:11:11:12
300	12445	123	xe3	300	00:00:11:11:11:13

---

## show ethernet cfm csf mep

Use this command to display detail information about Eth-CSF configured on MEP.

### Command Syntax

```
show ethernet cfm csf mep MEPID domain DOMAIN_NAME ma MA_NAME
```

### Parameters

MEPID	Source host MEP ID <1-8191>
DOMAIN_NAME	Enter the name of the domain. Name must be of 5 characters if type is character-string otherwise no_name if domain-type is no-name1
MA_NAME	Maintenance association name (if type is character string maximum length of ma-name is

6. If type is integer maximum is 2-octets)

### Command Mode

Exec mode and Privileged Exec mode

### Applicability

This command was introduced in OcNOS version 5.2.

### Example

```
#show ethernet cfm csf mep 100 domain 12345 ma 123
MA-Name : 123
MEL: 4
Admin Status : Enable
Interface : xel
VLAN : 100
Source address : 00:00:11:11:11:11
Wait to Restore timer: 200 sec
  State : SIGNAL_DEGRADED
  Elapsed time in this state : 00:00:04
  Last CSF Received : 2022 Mar 03 17:19:23
  CSF Period : 1 sec
  CFS Type : LOS
```

---

## show ethernet cfm delay-measurement mep

Use this command to display delay measurement statistics for a MEP both for current and history or individually.

### Command Syntax

```
show ethernet cfm delay-measurement mep MEPID domain DOMAIN_NAME (ma-name MA_NAME)
((current-stats|history-stats)|)
```

### Parameters

MEPID	Local MEP identifier<1-8191>
DOMAIN_NAME	Enter the name of the domain. Name must be of 5 characters if type is character-string otherwise no_name if domain-type is no-name1
MA_NAME	MA name
current-stats	Current session DB statistics.
history-stats	History DB statistics.

### Command Mode

Exec mode and Privileged Exec mode

### Applicability

This command was introduced in OcNOS version 3.0.

### Example

```
#show ethernet cfm delay-measurement mep 123 domain no_name ma 200
MEP : 123
MA : 200
```

```
VLANID : 10
PeerMAC Address:0000.0010.0000
```

CURRENT:

```
=====
Measurement ID : 2
Measurement Type:DMM
Elapsed time(sec):30
Start Time:2019 May 24 04:52:37
Min Frame Delay(usec):4
Max Frame Delay(usec):105
Avg Frame Delay(usec):81
Min Inter FD Variation(usec):34
Max Inter FD Variation(usec):34
Avg Inter FD Variation(usec):19
```

FRAME DELAY BINS

```
Bin NumberBin Threshold(usec)Bin Counter
```

```

=====
1  0  - <49993
2  5000- <99990
3  10000- <Inf0

INTER-FRAME DELAY BINS
Bin NumberBin Threshold(usec)Bin Counter
=====
1  0  - <49992
2  5000- <Inf0

HISTORY STATISTICS
=====
MD : no_name
MA : 200
MEP : 123
VLAN ID: 10
Measurement ID : 1
Measurement Type: DMM
Elapsed time(sec): 60
End Time: 2019 May 24 04:52:37
Min Frame Delay(usec): 56
Max Frame Delay(usec): 87
Avg Frame Delay(usec): 67 Min Inter FD Variation(usec): 1 Max Inter FD Variation(usec):
31 Avg Inter FD Variation(usec): 12

FRAME DELAY BINS
Bin NumberBin Threshold(usec)Bin Counter
=====
1  0  - <49995
2  5000- <99990
3  10000- <Inf0

INTER-FRAME DELAY BINS
Bin NumberBin Threshold(usec)Bin Counter
=====
1  0  - <49994
2  5000- <Inf0

```

[Table 1-1](#) explains the output fields.

**Table 1-1: show ethernet cfm dm sessions**

Field	Description
MEP	Local Maintenance End Point identifier
MA	Maintenance Association name

**Table 1-1: show ethernet cfm dm sessions**

<b>Field</b>	<b>Description</b>
Vlan Id	Primary vlan identifier of MA
DM-Profile	delay measurement profile name
Peer MAC Address	Peer's MAC address
Measurement ID	Id of the current or history session for that particular measurement interval
Measurement Type	One way or two way DM
Elapsed time	Time still left to complete the measurement interval
Start time	Time when DM session started
Min frame delay	Minimum delay recorded
Max frame delay	Max delay recorded
Avg frame delay	Average delay calculated
Min Inter FD Variation	Minimum inter frame delay variation calculated
Max Inter FD Variation	Maximum inter frame delay variation calculated
Avg Inter FD Variation	Average inter frame delay variation calculated
FRAME DELAY BINS	Frame delay bin configuration
INTER-FRAME DELAY BINS	Inter frame delay bin configuration
Bin Number	Bin number for which the threshold and counter is configured
Bin Threshold	A bin's configured threshold value
Bin counter	The number of delays recorded in this range
RMEP Id	Peer's MEP Id
End time	The time when the Measurement Interval was completed.
MD	Maintenance domain name

---

## show ethernet cfm delay-measurement profile

Use this command to display information about a specified delay measurement profile or all configured delay measurement profiles.

### Command Syntax

```
show ethernet cfm delay-measurement profile (WORD|)
```

### Parameters

WORD                      Profile name.

### Command Mode

Exec mode and Privileged Exec mode

### Applicability

This command was introduced in OcNOS version 3.0.

### Example

```
#sh ethernet cfm delay-measurement profile dmm
```

```
Profile Name: dmm
```

```
Measurement-type      -  DMM
Measurement-interval  -  1
Message-period        -  10s
Number of intervals stored -  4
Bins per FD Interval  -  4
Bins per IFDV Interval -  3
```

#### Frame Delay Bins

Bin Number	Bin Threshold
1	0
2	1
3	4

#### Inter-Frame Delay Bins

Bin Number	Bin Threshold
1	0
2	5000

[Table 1-2](#) explains the output fields.

**Table 1-2: show ethernet cfm delay-measurement profile**

Field	Description
Profile Name	Loss measurement profile name
Measurement-type	DM session is one way or two way



**Table 1-2: show ethernet cfm delay-measurement profile**

Field	Description
Measurement-interval	See <a href="#">measurement-interval</a>
message-period	See <a href="#">message-period</a>
Number of intervals stored	See <a href="#">intervals-stored</a>
Bins per FD Interval	See <a href="#">bins-per-fd-interval</a>
Bins per IFDV Interval	See <a href="#">bins-per-ifdv-interval</a>
Frame Delay Bins	Number of Frame Delay bins configured
Inter-Frame Delay Bins	Number of Inter-Frame Delay bins configured
Bin number	See <a href="#">bin-type</a>
Bin threshold	See <a href="#">bin-type</a>

---

## show ethernet cfm dm sessions

Use this command to display information about the delay measurement session.

### Command Syntax

```
show ethernet cfm dm sessions
```

### Parameters

None

### Command Mode

Exec mode and Privileged Exec mode

### Applicability

This command was introduced in OcnOS version 3.0.

### Example

```
#show ethernet cfm dm sessions
```

```
MEP-Id  Status  StartTime          DM-Profile  Mac-address  Repetition Period(sec)
-----
123     Active  2019/06/01 13:14:46  123        0018.236e.5eb5  60
```

[Table 1-3](#) explains the output fields.

**Table 1-3: show ethernet cfm dm sessions**

Field	Description
MEP-Id	Local Maintenance End Point identifier
Status	Inactive: if delay measurement session is not started Active: if delay measurement session is started
StartTime	Time when delay measurement session is started
DM-Profile	delay measurement profile name
Mac-address	MAC address
Repetition Period	Repetition time between measurement intervals in seconds

---

## show ethernet cfm errors

Use this command to verify the defects present in a MEP.

### Command Syntax

```
show ethernet cfm errors (domain DOMAIN_NAME)
```

### Parameters

`DOMAIN_NAME` Enter the name of the domain. Name must be of 5 characters if type is character-string otherwise `no_name` if domain-type is `no-name1`

### Command Mode

Exec mode and Privileged Exec mode

### Applicability

This command was introduced in OcNOS version 3.0.

### Example

```
#show ethernet cfm errors domain 12345
Domain Name      Level      Vlan      MEPID      Defects
-----
12345            7         10       100       .....
```

[Table 1-4](#) explains the output fields

**Table 1-4: show ethernet cfm errors**

Field	Description
Domain Name	Maintenance Domain name
Level	MD Level
Vlan	Vlan identifier
MEPID	Maintenance End Point identifier
Defects	Defects in current MEP

---

## show ethernet cfm eth-bn status

Display ETH-BN status for the MEP.

### Command Syntax

```
show ethernet cfm eth-bn status
```

### Parameters

None

### Default

NA

### Command Mode

Exec mode

### Applicability

This command was introduced in OcNOS version 5.0

### Examples

```
OcNOS#show ethernet cfm eth-bn status

BNM status for interface xe9
-----

state                : SIGNAL_NORMAL
Hold Time             : 60
Restore Time         : 90
Total BNM Receive Count : 0
Sender Address       : 0000.0000.0000
Elapsed time in this state: 00:17:54
Nominal Bandwidth    : 0
Current Bandwidth    : 0
Lowest Bandwidth     : 1250000000
Last BNM Received    : NIL
BNM Period           : 1
Hold Timer           : Not Running
Wait-to-Restore Timer : Not Running
OcNOS#
```

---

## show ethernet cfm frame-lm session

Use this command to display information about the frame loss measurement session.

### Command Syntax

```
show ethernet cfm frame-lm session
```

### Parameters

None

### Command Mode

Exec mode and Privileged Exec mode

### Applicability

This command was introduced in OcNOS version 3.0.

### Example

```
#show ethernet cfm frame-lm session
MEPID  Status  StartTime          Lm-profile  Mac-address  Repetition Period(sec)
-----
201    Active  2018/10/01 00:18:46  slm        0018.236e.5eb5  60
```

[Table 1-5](#) explains the output fields.

**Table 1-5: show ethernet cfm frame-lm session**

Field	Description
MEPID	Maintenance End Point identifier
Status	Inactive: if loss measurement is not in progress Active: otherwise
StartTime	When loss measurement started
Lm-profile	Loss measurement profile name
Mac-address	MAC address
Repetition Period	Repetition time between measurement intervals in seconds

---

## show ethernet cfm lck details domain

Use this command to display a CFM lock user configuration.

### Command Syntax

```
show ethernet cfm lck details domain DOMAIN_NAME ma MA_NAME mep MEPID
```

### Parameters

domain	Specify domain.
DOMAIN_NAME	Enter the name of the domain. Name must be of 5 characters if type is character-string otherwise no_name if domain-type is no-name1
ma	Specify Maintenance association name
MA_NAME	Enter maintenance association name. If ma-type is character string then maximum length of ma-name is 6 else if it's integer then maximum is 2-octets.
mep	Specify mep
MEPID	Enter the MEPID ranging from <1-8191>

### Command Mode

Exec mode

### Default

None

### Applicability

This command was introduced in OcnOS version 4.0.

### Example

```
#show ethernet cfm lck details domain 12345 ma 200 mep 151
```

```
Maintenance Domain           : 12345
Maintenance Association       : 200
MEP ID                        : 151
LCK PDU state                 : Locked
LCK Message Level            : 7
LCK PDU Interval              : 1 min
LCK PDU Priority               : 3
```

---

## show ethernet cfm lck statistics

Use this command to display a CFM lock statistics for a MEP.

### Command Syntax

```
show ethernet cfm lck statistics mep MEPID domain DOMAIN_NAME
```

### Parameters

domain	Specify domain.
DOMAIN_NAME	Enter the name of the domain. Name must be of 5 characters if type is character-string otherwise no_name if domain-type is no-name1
mep	Specify mep
MEPID	Enter the MEPID ranging from <1-8191>

### Command Mode

Exec mode

### Default

None

### Applicability

This command was introduced in OcNOS version 4.0.

### Example

```
#show ethernet cfm lck statistics mep 151 domain 12345
MPID MD Name MA Name Lck State Rx Status Tx Rx
-----
151 12345 200 True False 7 0
```

---

## show ethernet cfm loss-measurement mep

Use this command to display frame loss measurement statistics for a MEP.

### Command Syntax

```
show ethernet cfm loss-measurement mep MEPID domain DOMAIN_NAME (ma-name MA_NAME)
```

### Parameters

MEPID	Host MEP identifier <1-8191>
DOMAIN_NAME	Enter the name of the domain. Name must be of 5 characters if type is character-string otherwise no_name if domain-type is no-name1
MA_NAME	MA name

### Command Mode

Exec mode and Privileged Exec mode

### Applicability

This command was introduced in OcNOS version 3.0.

### Example

```
#show ethernet cfm loss-measurement mep 201 domain 12345 ma 43982
MEP: 201 MA: 43982 CURRENT:
Measurement ID : 3
Measurement Type: slm
Elapsed time(sec): 51
Start Time: 2018 Nov 19 22:37:31
Near End loss: 0
Far End loss: 0
Near End accumulated loss : 0 Far End accumulated loss: 0
```

#### HISTORY:

```
Measurement ID : 1
Measurement Type      : slm
Elapsed time(sec)    : 60
End Time             : 2018 Nov 19 22:36:31
Near End loss        : 0
Far End loss         : 0
Near End accumulated loss : 0
Far End accumulated loss : 0
```

```
Measurement ID : 2
Measurement Type      : slm
Elapsed time(sec)    : 60
End Time             : 2018 Nov 19 22:37:31
Near End loss        : 0
Far End loss         : 0
```



Near End accumulated loss : 0

Far End accumulated loss : 0

Table 1-6 explains the output fields.

**Table 1-6: show ethernet cfm loss-measurement mep**

Field	Description
MEP	Maintenance End Point identifier
MA	Maintenance Association name
CURRENT:	Current loss measurement statistics
HISTORY:	Historic loss measurement statistics
Measurement ID	Sequence number
Measurement Type	See <a href="#">measurement-type slm</a>
Elapsed time	Elapsed time in seconds
Start Time	Start time
End Time	End time
Near End loss	Near end loss
Far End loss	Far end loss
Near End accumulated loss	Near end accumulated loss
Far End accumulated loss	Far end accumulated loss

---

## show ethernet cfm loss-measurement profile

Use this command to display information about a given loss measurement profile or all loss measurement profiles.

### Command Syntax

```
show ethernet cfm loss-measurement profile WORD
```

### Parameters

WORD                      Profile name.

### Command Mode

Exec mode and Privileged Exec mode

### Applicability

This command was introduced in OcNOS version 3.0.

### Example

```
#show ethernet cfm loss-measurement profile slm
Profile Name:slm
measurement-type      -  slm
measurement-interval -  1
intervals-stored      -  3
message-period        -  1
```

[Table 1-7](#) explains the output fields.

**Table 1-7: show ethernet cfm loss-measurement profile**

Field	Description
Profile Name	Loss measurement profile name
measurement-type	See <a href="#">measurement-type slm</a>
measurement-interval	See <a href="#">measurement-interval</a>
intervals-stored	See <a href="#">intervals-stored</a>
message-period	See <a href="#">message-period</a>

## show ethernet cfm ma status

Use this command to display the connectivity status of Maintenance Associations (MAs) in a domain.

### Command Syntax

```
show ethernet cfm ma status domain DOMAIN_NAME (mep <1-8191>| mep all|) (ma-name
  MA_NAME)
```

### Parameters

DOMAIN_NAME	Enter the name of the domain. Name must be of 5 characters if type is character-string otherwise no_name if domain-type is no-name1
<2-4094>	VLAN identifier
mep	Host MEP
<1-8191>	Host MEP identifier
all	All host MEPs
MA_NAME	Maintenance association name. If ma-type is character string then maximum length of ma-name is 6 else if it's integer then maximum is 2-octets

### Command Mode

Exec mode and Privileged Exec mode

### Applicability

This command was introduced in OcNOS version 3.0.

### Example

```
#show ethernet cfm ma status domain 12345 ma 43982
MA NAME          VLAN          STATUS
-----
 43982           10            Active
```

```
#show ethernet cfm ma status domain 12345
```

```
MA NAME          STATUS
-----
 43981           Active
```

[Table 1-8](#) explains the output fields.

**Table 1-8: show ethernet cfm ma status**

Field	Description
MA NAME	Maintenance Association name

**Table 1-8: show ethernet cfm ma status (Continued)**

Field	Description
VLAN	VLAN identifier
STATUS	Active: All connected MEPs in MA are receiving the CCM with no defect or alarm present Partially Active: One or more connected MEPs in MA is not receiving CCM or it is receiving CCM with defect or alarm present Not Active: None of the connected MEPS in MA are receiving CCM or it is receiving CCM with defect or alarm present

---

## show ethernet cfm maintenance-points count

Use this command to display information about the Total CFM sessions Count on a given interface.

### Command Syntax

```
show ethernet cfm maintenance-points count IFNAME
```

### Parameters

IFNAME	Interface name
--------	----------------

### Command Mode

Exec mode and Privileged Exec mode

### Applicability

This command was introduced in OcNOS version 6.3.0.

### Example

```
OcNOS#show ethernet cfm maintenance-points count xe6
```

```
-----  
Total No of MIPs           : 3  
Total No of MEPs           : 3  
Total No of UP MEPs        : 0  
Total No of Down MEPs      : 3  
Total No of Active CCM sessions : 3  
Total No of UP CCM sessions : 2  
Total No of Active Test sessions : 0  
Total No of Active LM sessions : 0  
Total No of Active DM sessions : 0  
-----
```

## show ethernet cfm maintenance-points local mep

Use this command to display information about the Maintenance End Points (MEPs) on a local interface.

### Command Syntax

```
show ethernet cfm maintenance-points local (mep) (interface IFNAME|) (domain
  DOMAIN_NAME) (ma-name MA_NAME)
```

### Parameters

IFNAME	Interface name. This token can be used only for Down MEPs on L2 bridge.
DOMAIN_NAME	Enter the name of the domain. Name must be of 5 characters if type is character-string otherwise no_name if domain-type is no-name1
MA_NAME	Maintenance association name.

### Command Mode

Exec mode and Privileged Exec mode

### Applicability

This command was introduced in OcNOS version 3.0.

### Example

```
#show ethernet cfm maintenance-points local mep domain 12345 ma 123
MPID Dir Lvl VLAN CC-Stat HW-Status CC-Intvl MAC-AddressDef Port MD Name
100 Dn 7 10 EnableInstalled 100 ms3c2c.99f0.b0c1 Fxe212345
```

```
#show ethernet cfm maintenance-points local mep domain 12345 ma 123
MPID Dir Lvl CC-Stat HW-Status CC-Intvl MAC-AddressDef Port MD Name
200 Up 7Enable Installed 3 ms0018.23c8.f822 Fxe15 12345
```

[Table 1-9](#) explains the output fields.

**Table 1-9: show ethernet cfm maintenance-points local mep**

Field	Description
MPID	MEP identifier
Dir	Up MEP or Down MEP
Lvl	MD level
Vlan	VLAN identifier
CC-Stat	Whether continuity checking (CC) is enabled or disabled
HW-Status	Installed or pending to install in hardware
CC-Intvl	CCM Interval

**Table 1-9: show ethernet cfm maintenance-points local mep**

<b>Field</b>	<b>Description</b>
MAC-Address	MAC address
Def	Defect present
Port	CFM interface
MD Name	MD name

## show ethernet cfm maintenance-points local mip

Use this command to display information about the Maintenance Intermediate Points (MIPs) on a local interface.

### Command Syntax

```
show ethernet cfm maintenance-points local (mip) (interface IFNAME| (level <0-7>)
(ma-name MA_NAME|))
```

### Parameters

IFNAME	Interface name.
<0-7>	Maintenance level.
MA_NAME	Maintenance association name. If ma-type is character string then maximum length of ma-name is 6 else if it's integer then maximum is 2-octets

### Command Mode

Exec mode and Privileged Exec mode

### Applicability

This command was introduced in OcNOS version 3.0.

### Example

```
#show ethernet cfm maintenance-points local mip level 7 ma 123
Level  VID   Type  Port  MAC-Address
-----
7      10    MIP   xe3   0018.23ea.da36
7      10    MIP   xe5   0018.23ea.da38
```

[Table 1-10](#) explains the output fields.

**Table 1-10: show ethernet cfm maintenance-points local mip**

Field	Description
Level	MD level
VID	VLAN identifier
Type	MIP
Port	Interface name
MAC-Address	MAC address



## show ethernet cfm maintenance-points remote

Use this command to display information about a remote MEP.

### Command Syntax

```
show ethernet cfm maintenance-points remote (mpid MEP_ID|) (domain DOMAIN_NAME) (ma-
name MA_NAME)
```

### Parameters

MEP_ID	Remote MEP identifier <1-8191>
DOMAIN_NAME	Enter the name of the domain. Name must be of 5 characters if type is character-string otherwise no_name if domain-type is no-name1
MA_NAME	MA name

### Command Mode

Exec mode and Privileged Exec mode

### Applicability

This command was introduced in OcNOS version 3.0.

### Example

```
#show ethernet cfm maintenance-points remote domain 12345
MEPIDRMEPIDLEVELVLANRx CCMRDIPEER-MACTYPE

100 200 7 10 Yes Falsea82b.b579.fd2aConfigured
```

[Table 1-11](#) explains the output fields.

**Table 1-11: show ethernet cfm maintenance-points remote**

Field	Description
MEPID	MEP identifier
RMEPID	Remote MEP identifier
LEVEL	MD level
VLAN	VLAN identifier
Rx CCM	Yes if CCM receives, no if CCM doesn't receive.
RDI	Whether Remote Defect Indication (RDI) is on or off
PEER-MAC	Remote MEP mac address
TYPE	Configured or auto learned

## show ethernet cfm statistics

Use this command to display CFM statistics: CCM sent and received, LBM sent and LBR received, LTM sent and LTR received.

### Command Syntax

```
show ethernet cfm statistics mep MEPID domain DOMAIN_NAME ma-name MA_NAME
```

### Parameters

MEPID	Host MEP identifier <1-8191>
MA_NAME	Maintenance association name. If ma-type is character string then maximum length of ma-name is 6 else if it's integer then maximum is 2-octets
DOMAIN_NAME	Enter the name of the domain. Name must be of 5 characters if type is character-string otherwise no_name if domain-type is no-name1

### Command Mode

Exec mode

### Applicability

This command was introduced in OcNOS version 3.0.

### Example

```
#show ethernet cfm statistics
```

```
Continuity Check Messages
```

```
CCM Sent           : 168164
CCM Received       : 165460
```

```
Loop Back Messages
```

```
LBM Sent           : 5
LBR Received(Valid) : 5
LBR Received(Bad msdu) : 0
LBR Received(Out-of-Seq) : 0
```

```
Link Trace Messages
```

```
LTM Sent           : 1
LTR Sent           : 0
LTR Received(Valid) : 3
LTR Received(unexpected) : 0
```

[Table 1-12](#) explains the output fields.

**Table 1-12: show ethernet cfm statistics**

Field	Description
<b>Continuity Check Messages</b>	
CCM Sent	Number of continuity check messages (CCMs) sent

**Table 1-12: show ethernet cfm statistics**

<b>Field</b>	<b>Description</b>
CCM Received	Number of CCMs received
<b>Loop Back Messages</b>	
LBM Sent	Number of loopback messages (LBMs) sent
LBR Received(Valid)	Number of valid LBRs received
LBR Received(Bad msdu)	Number of LBRs received with bad MAC service data unit
LBR Received(Out-of-Seq)	Number of out-of-sequence LBRs received
<b>Link Trace Messages</b>	
LTM Sent	Number of link trace messages (LTMs) sent
LTR Received(Valid)	Number of link trace replies (LTRs) received
LTR Received(unexpected)	Number of unexpected LTRs received

---

## show ethernet cfm statistics bn

Use this command to display CFM Eth-BNM statistics.

### Command Syntax

```
show ethernet cfm statistics bn
```

### Parameters

None

### Command Mode

Exec mode

### Applicability

This command was introduced in OcnOS version 5.2.

### Example

```
#show ethernet cfm statistics bn
```

MEPID	Domain	MA-Name	RX-Frames	Dropped-Frames	WR-time-left
100	12334	123	10001	11 sec	
200	12341	234	12000	off	
300	12421	123	13000	12 sec	

---

## show ethernet cfm statistics csf

Use this command to display CFM Eth-CSF statistics.

### Command Syntax

```
show ethernet cfm statistics csf
```

### Parameters

None

### Command Mode

Exec mode

### Applicability

This command was introduced in OcNOS version 5.2.

### Example

```
#show ethernet cfm statistics csf
```

MEPID	Domain	MA-Name	RX-Frames	Dropped-Frames	WR-time-left
100	12334	123	10001	11 sec	
200	12341	234	12000	off	
300	12421	123	13000	12 sec	

---

## show ethernet cfm test-signal domain

Use this command to display ETH-Test receiver or generator statistics.

### Command Syntax

```
show ethernet cfm test-signal domain DOMAIN_NAME ma MA_NAME mep MEPID stats
(ctf|gtf)
```

### Parameters

DOMAIN_NAME	Enter the name of the domain. Name must be of 5 characters if type is character-string otherwise no_name if domain-type is no-name1
ma	Specify Maintenance association name
MA_NAME	Enter maintenance association name. If ma-type is character string then maximum length of ma-name is 6 else if it's integer then maximum is 2-octets.
mep	Specify mep
MEPID	Enter the MEPID ranging from <1-8191>
stats	Display the statistics
ctf	Display ETH Test Frame Collector statistics
gtf	Display ETH Test Frame Generator statistics

### Command Mode

Exec mode

### Applicability

This command was introduced in OcNOS version 4.0.

### Example

```
#show ethernet cfm test-signal domain 12345 ma 43982 mep 21 stats gtf
TST Session status          : In-Progress
Elapsed Time(sec)           : 36
MD                           : 12345
MA                           : 43982
MEP                          : 21
Peer MAC Address            : 6cb9.c557.42d0
RMEP ID                     : 12
Start Time                  : 2019 Mar 01 10:23:11
Transmitted Packet Count    : 2854713
```

---

## show ethernet cfm test-signal profile

Use this command to display ETH-Test signal profile configuration.

### Command Syntax

```
show ethernet cfm test-signal profile (WORD|)
```

### Parameters

WORD Specify the test signal profile name with max length of 64 characters

### Command Mode

Exec mode

### Applicability

This command was introduced in OcNOS version 4.0.

### Example

```
#show ethernet cfm test-signal profile 123
Profile Name      : 123
Is Receiver       : False
Is Generator      : True
Test-Signal Type  : In-Service
Frame Size(bytes) : 124
Test Pattern Type : Null-Signal-Without-CRC-32
```

---

## show ethernet cfm test-signal sessions

Use this command to display CFM test-signal session.

### Command Syntax

```
show ethernet cfm test-signal sessions
```

### Parameters

None

### Command Mode

Exec mode

### Applicability

This command was introduced in OcNOS version 4.0.

### Example

```
OcNOS#show ethernet cfm test-signal sessions
MEP-Id  Status      StartTime          Tst-Profile        Peer MAC-Address
-----
```

-



---

## show ethernet cfm traceroute-cache

Use this command to display the ethernet cfm traceroute cache

### Command Syntax

```
show ethernet cfm traceroute-cache
```

### Parameters

None

### Command Mode

Exec mode and Privileged Exec mode

### Applicability

This command was introduced in OcNOS version 4.0.

### Example

```
OcNOS#show ethernet cfm traceroute-cache bridge 1
MEPID      Dest mac          Hops      Relay-action
2          e8c5.7a91.f8c4   1         RlyHit
2          e8c5.7a91.f8c4   1         RlyHit
```

---

## show running-config cfm

Use this command to display CFM running configuration alone.

### Command Syntax

```
show running-config cfm
```

### Parameters

None

### Command Mode

Exec mode and Privileged Exec mode

### Applicability

This command was introduced in OcNOS version 3.0.

### Example

```
#show running-config cfm
ethernet cfm domain-type character-string domain-name 12347 level 2 mip-
creation none
  service ma-type string ma-name 123
    vlan 10 bridge 10
    mip-creation default
    ethernet cfm mep down mpid 14 active true xe4
      lck state lock
        message level 2
        interval 1s
        frame priority 3
        exit-ether-ma-mep-lck-mode
      ethernet cfm loss-measurement reply lmm
      exit-ether-ma-mep-mode
    mep crosscheck mpid 41
    exit-ether-ma-mode
  !
```

---

## test-signal frame-size

Use this command to configure an ETH test signal frame size which is applicable only for generator test signal mode. Use `no` form of this command to delete the configured ETH test signal frame size.

### Command Syntax

```
test-signal frame-size <68-9600>
no test-signal frame-size
```

### Parameters

<68-9600> Specify the frame size within the range

### Command Mode

Configure CFM ETH test mode

### Default

None

### Applicability

This command was introduced in OcNOS version 4.0.

### Example

```
#configure terminal
(config)#ethernet cfm test-signal profile-name 123
(config-cfm-eth-tst)#test-signal frame-size 124

(config-cfm-eth-tst)#no test-signal frame-size
```

---

## test-signal mode

Use this command to enable an ETH test signal mode as generator or receiver or both.

### Command Syntax

```
test-signal mode (generator|receiver|both)
```

### Parameters

generator	The node will act as a ETH-TST frame generator
receiver	The node will act as a ETH-TST frame receiver
both	The node will act as both ETH-TST frame generator and receiver

### Command Mode

Configure CFM ETH test mode

### Default

The default test signal mode is receiver.

### Applicability

This command was introduced in OcNOS version 4.0.

### Example

```
#configure terminal
(config)#ethernet cfm test-signal profile-name 123
(config-cfm-eth-tst)#test-signal mode generator
```

## test-signal pattern-type

Use this command to configure the TLV type to be encoded in ETH-Test PDU.

Use `no` form of this command to reset the TLV pattern type to default.

### Command Syntax

```
test-signal pattern-type (null-sig|null-sig-crc32|prbs|prbs-crc32)
no test-signal pattern-type
```

### Parameters

<code>null-sig</code>	Specify test pattern as a Null signal without CRC-32
<code>null-sig-crc32</code>	Specify test pattern as a Null signal with CRC-32
<code>prbs</code>	Specify test pattern as a PRBS 2 <sup>31</sup> -1 without CRC-32
<code>prbs-crc32</code>	Specify test pattern as a PRBS 2 <sup>31</sup> -1 with CRC-32

### Command Mode

Configure CFM ETH test mode

### Default

Default TLV pattern type is Null signal.

### Applicability

This command was introduced in OcNOS version 4.0.

### Example

```
#configure terminal
(config)#ethernet cfm test-signal profile-name 123
(config-cfm-eth-tst)#test-signal pattern-type null-signal

(config-cfm-eth-tst)#no test-signal pattern-type
```

---

## test-signal start-time

Use this command to start the ETH-Test session.

### Command Syntax

```
test-signal start-time (relative START-TIME | absolute START-TIME ) stop-time
(relative STOP-TIME | absolute STOP-TIME) tst-profile-name WORD domain
DOMAIN_NAME ma MA_NAME mep MEPID target (mac-address MAC|RMEPID)
```

### Parameters

start-time	Specify Test session start time
relative	Specify Test session start time as relative
absolute	Specify Test session start time as absolute
START-TIME	Test session start time in minutes
stop-time	Specify Test session stop time
STOP-TIME	Test session stop time in minutes
tst-profile-name	Test session profile name
WORD	Specify test session profile name
domain	Specify domain.
DOMAIN_NAME	Enter the name of the domain. Name must be of 5 characters if type is character-string otherwise no_name if domain-type is no-name1
ma	Specify Maintenance association name
MA_NAME	Enter maintenance association name. If ma-type is character string then maximum length of ma-name is 6 else if it's integer then maximum is 2-octets.
mep	Specify mep
MEPID	Enter the MEPID ranging from <1-8191>
target	Specify target
mac-address	Unicast destination MAC address
MAC	MAC address in HHHH.HHHH.HHHH format
RMEPID	Enter the RMEP ID ranging from 1-8191

### Command Mode

Exec mode

### Default

None

### Applicability

This command was introduced in OcNOS version 4.0.

**Example**

```
#test-signal start-time relative 0 stop-time relative 30 tst-profile-name 123  
domain 12345 ma 43982 mep 21 target mac-address 6cb9.c557.42d0
```

---

## test-signal test-type

Use this command to configure an ETH test signal test type is service interrupting or not.

Use `no` form of this command to delete the configured ETH test signal test type.

### Command Syntax

```
test-signal test-type (in-service|out-of-service)
no test-signal test-type
```

### Parameters

<code>in-service</code>	This indicates the ETH-Test is in-service and normal client service traffic is not interrupted
<code>out-of-service</code>	This indicates the ETH-Test is out-of-service and normal client service traffic is not disrupted

### Command Mode

Configure CFM ETH test mode

### Default

None

### Applicability

This command was introduced in OcNOS version 4.0.

### Example

```
#configure terminal
(config)#ethernet cfm test-signal profile-name 123
(config-cfm-eth-tst)#test-signal test-type in-service
(config-cfm-eth-tst)#no test-signal test-type
```



---

## traceroute ethernet

Use this command to start traceroute messages on a remote MEP.

### Command Syntax

```
traceroute ethernet MAC mepid MEPID domain DOMAIN (ma MA_NAME)
```

### Parameters-

MAC	MAC address of the remote MEP or MIP in HHHH.HHHH.HHHH format.
MEPID	Host MEP identifier <1-8191>.
DOMAIN_NAME	Enter the name of the domain. Name must be of 5 characters if type is character-string otherwise no_name if domain-type is no-name1
MA_NAME	Enter maintenance association name. If ma-type is character string then maximum length of ma-name is 6 else if it's integer then maximum is 2-octets.

### Command Mode

Exec mode and Privileged Exec mode

### Applicability

This command was introduced in OcNOS version 3.0.

### Example

```
#traceroute ethernet 0018.236e.5eb8 mepid 201 domain 12345 ma 123
MP Mac          Hops  Relay-action          Ingress/Egress  Ingress/Egress
action
0018.23ea.da36  1     RlyFDB                Ingress         IngOK
0018.23ea.da38  2     RlyFDB                Egress          EgrOK
0018.236e.5eb8  3     RlyHit                Ingress         IngOK

#traceroute ethernet 0018.236e.5eb8 mepid 201 domain 12345 vpws ETH-2001
MP Mac          Hops  Relay-action          Ingress/Egress  Ingress/Egress
action
0018.23ea.da36  1     RlyFDB                Ingress         IngOK
0018.23ea.da38  2     RlyFDB                Egress          EgrOK
0018.236e.5eb8  3     RlyHit                Ingress         IngOK
```

---

## vlan

Use this command to create a service Maintenance Association (MA), with a VLAN.

### Command Syntax

```
vlan VLAN_ID (bridge <1-32> | inner-vlan VLAN_ID|)
```

### Parameters

<1-32>	Bridge id
VLAN_ID	Inner VLAN identifier <1-4094>

### Command Mode

Ethernet CFM MA mode

### Applicability

This command was introduced in OcNOS-SP version 5.1

### Example

```
#configure terminal
OcNOS(config)#ethernet cfm domain-type character-string domain-name 12345 level 7
OcNOS(config-ether-cfm)#service ma-type string ma-name 43982
OcNOS(config-ether-cfm-ma)#vlan 10 bridge 10
OcNOS(config-ether-cfm-ma)#ethernet cfm mep down mpid 2331 active true xe2
```

## vpws

Use this command to create a service Maintenance Association (MA), with VPWS.

### Command Syntax

```
vpws VCNAME
```

### Parameters

VCNAME                      Virtual circuit name with maximum length being 30

### Command Mode

Ethernet CFM MA mode

### Applicability

This command was introduced in OcNOS-SP version 6.1.0

### Example

```
#configure terminal
OcNOS(config)#ethernet cfm domain-type character-string domain-name 12345 level 7
OcNOS(config-ether-cfm)#service ma-type string ma-name 43982
OcNOS(config-ether-cfm-ma)#vpws ETH-2001
OcNOS(config-ether-cfm-ma)#ethernet cfm mep up mpid 103 active true vpws ETH-2001
```

---

## wait-to-restore-timer <0-86400>

Use this command to configure/unconfigure Wait-to-restore timer for Eth-BNM and Eth-CSF. For Eth-BNM, nominal bandwidth will be set after the wait-to-restore timer expiry. When this command is enabled for Eth-CSF 'DCI' state is restored after wait-to-restore timer expiry.

### Command Syntax

```
wait-to-restore-timer <TIME>
no wait-to-restore-timer <TIME>
```

### Parameters

TIME	Wait-to-restore-timer <0-86400>
------	---------------------------------

### Default

Default is 10 seconds.

### Command Mode

Ethernet CFM MEP BN and CFM MEP CSF mode

### Applicability

This command was introduced in OcNOS version 5.0

### Examples

```
OcNOS(config)#ethernet cfm domain-type character-string domain-name abcde
level 5
OcNOS(config-ether-cfm)#service ma-type string ma-name 7
OcNOS(config-ether-cfm-ma)#vlan 10 bridge 10
OcNOS(config-ether-cfm-ma)#ethernet cfm mep down mpid 100 active true xe9
OcNOS(config-ether-cfm-ma-mep)#bn receive
OcNOS(config-ether-cfm-ma-mep-bn)#wait-to-restore-timer 90
OcNOS(config-ether-cfm-ma-mep-bn)#
```

---

## CHAPTER 2 G8031 ELPS Commands

---

This chapter describes the G8031 Ethernet Linear Protection Switching (ELPS) commands

- `clear`
- `debug g8031`
- `exercise`
- `force-switch`
- `g8031 eps-id`
- `instance`
- `level`
- `local-freeze`
- `lockout`
- `manual-switch`
- `mode`
- `primary-vlan`
- `protection-port`
- `revertive`
- `show g8031 eps-id`
- `show g8031 bridge`
- `show hsl g8031 debug`
- `timer hold-off-time`
- `timer wait-to-restore`
- `vlan`
- `working-port`

---

## clear

Use this command to perform clear operation on g8031 protection group.

### Command Syntax

```
clear bridge <1-32> g8031 eps-id <1-32>
```

### Parameters

<1-32>	Bridge name
<1-32>	Protection group id

### Command Mode

Exec mode.

### Applicability

This command was introduced before OcNOS version 5.0.

### Examples

```
# clear bridge 1 g8031 eps-id 10
```

## debug g8031

Use this command to debug configuration.

### Command Syntax

```
debug g8031 (all|events|fsm|hal|rx|tx)
no debug g8031 (all|events|fsm|hal|rx|tx)
```

### Parameters

all	All debugging options.
events	Protocol related events.
fsm	Instance Finite State Machine updates.
hal	HAL events.
rx	Received PDUs.
tx	Transmitted PDUs.

### Command Mode

Exec mode.

### Applicability

This command was introduced in OcNOS version 6.0.0.

### Examples

```
# debug g8031 tx

# debug g8031 all
```

---

## exercise

Use this command to perform exercise operation on g8031 protection group.

### Command Syntax

```
exercise bridge <1-32> g8031 eps-id <1-32>
```

### Parameters

<1-32>	Bridge name
<1-32>	Protection group id

### Command Mode

Exec mode.

### Applicability

This command was introduced before OcNOS version 5.0.

### Examples

```
# exercise bridge 1 g8031 eps-id 10
```



---

## force-switch

Use this command to perform force-switch on g8031 protection group.

### Command Syntax

```
force-switch bridge <1-32> g8031 eps-id <1-32>
```

### Parameters

<1-32>	Bridge name
<1-32>	Protection group id

### Command Mode

Exec mode

### Applicability

This command was introduced before OcnOS version 5.0.

### Examples

```
# force-switch bridge 1 g8031 eps-id 10
```

---

## g8031 eps-id

Use this command to configure a g8031 protection group.

Use the `no` form of this command to delete a g8031 protection group.

### Command Syntax

```
g8031 eps-id <1-32> bridge <1-32>
no g8031 eps-id <1-32>
```

### Parameters

<1-32>	Protection group id.
<1-32>	Bridge group for bridging.

### Command Mode

Config mode

### Applicability

This command was introduced before OcNOS version 5.0.

### Examples

```
#configure terminal
(config)#g8031 eps-id 10 bridge 1
(g8031-config-switching)#
```

---

## instance

Use this command to set instance-id for a particular g8031 protection group.

Use the `no` form of this command to remove instance-id for a g8031 protection group.

Note: Once instance is configured, working and protection ports can not be modified.

### Command Syntax

```
instance <1-63>
no instance
```

### Parameters

```
<1-63>          instance-id
```

### Command Mode

G8031 Switching Mode.

### Applicability

This command was introduced before OcnOS version 5.0.

### Examples

```
#configure terminal
(config)#g8031 eps-id 10 bridge 1
(g8031-config-switching)#instance 3
```

---

## level

Use this command to associate CFM with g8031 protection group.

Use the `no` form of this command to disassociate CFM from g8031 protection group.

Note: It is mandatory for Working-port MEP and Protection-Port MEP to be in different Maintenance Domain but in same Maintenance Level. Moreover, Maintenance Association Vlan-id should be same as g8031 primary-vlan id. If both the conditions are met then, g8031 protection group can be associated to using the 'level' command.

### Command Syntax

```
level <0-7>
no level
```

### Parameters

<0-7> domain level.

### Command Mode

G8031 Switching Mode.

### Applicability

This command was introduced before OcNOS version 5.0.

### Examples

```
#configure terminal
(config)#g8031 eps-id 10 bridge 1
(g8031-config-switching)#mode one-and-one-bidirectional
(g8031-config-switching)#level 3
```

## local-freeze

Use this command to locally freeze the g8031 protection group.

Use the `no` form of this command to remove local-freeze from g8031 protection group.

### Command Syntax

```
local-freeze
no local-freeze
```

### Parameters

None.

### Command Mode

G8031 Switching Mode.

### Applicability

This command was introduced before OcNOS version 5.0.

### Examples

```
#configure terminal
(config)#g8031 eps-id 10 bridge 1
(g8031-config-switching)#mode one-and-one-bidirectional
(g8031-config-switching)#local-freeze
```

---

## lockout

Use this command to lockout the g8031 protection group.

### Command Syntax

```
lockout bridge <1-32> g8031 eps-id <1-32>
```

### Parameters

<1-32>	Bridge name.
<1-32>	Protection group id.

### Command Mode

Exec mode.

### Applicability

This command was introduced before OcNOS version 5.0.

### Examples

```
# lockout bridge 1 g8031 eps-id 10
```

---

## manual-switch

Use this command to perform manual-switch on g8031 protection group.

### Command Syntax

```
manual-switch bridge <1-32> g8031 eps-id <1-32>
```

### Parameters

<1-32>	Bridge name
<1-32>	Protection group id

### Command Mode

Exec mode.

### Applicability

This command was introduced before OcnOS version 5.0.

### Examples

```
# manual-switch bridge 1 g8031 eps-id 10
```

---

## mode

Use this command to configure mode for g8031 protection group.

Use the `no` form of this command to mode for g8031 protection group.

Note: Once mode is configured, it can not be changed. Administrator has to explicitly delete and re-configure a new mode.

### Command Syntax

```
mode (one-and-one-bidirectional| one-plus-one-bidirectional| one-plus-one-  
    unidirectional)  
no mode
```

### Parameters

```
one-and-one-bidirectional1:1 Bidirectional mode  
one-plus-one-bidirectional 1+1 Bidirectional mode  
one-plus-one-unidirectional1+1 Unidirectional mode
```

### Command Mode

G8031 Switching Mode.

### Applicability

This command was introduced before OcNOS version 5.0.

### Examples

```
#configure terminal  
(config)##g8031 eps-id 10 bridge 1  
(g8031-config-switching)#mode one-and-one-bidirectional
```



---

## primary-vlan

Use this command to configure a primary-vlan for g8031 protection group.

Use the `no` form of this command to delete primary-vlan for a g8031 protection group.

Note: Once mode is configured, primary-vlan can not be modified.

### Command Syntax

```
primary-vlan <2-4094>
no primary-vlan
```

### Parameters

<2-4094>           vlan id

### Command Mode

G8031 Switching Mode.

### Applicability

This command was introduced before OcnOS version 5.0.

### Examples

```
#configure terminal
(config)#g8031 eps-id 10 bridge 1
(g8031-config-switching)#primary-vlan 3
```

---

## protection-port

Use this command to configure a protection-port for a g8031 protection group.

Use the `no` form of this command to delete protection-port for a g8031 protection group.

Note: When both working and protection ports are in Signal-Failure state, Working Port will be treated as Active port i.e Protection group will be in Signal-Failure-Protection State.

Note: Working and Protection Paths between two ELPS end nodes should not coincide i.e When having intermediate nodes it is required that the working path and protection path are configured via different intermediate nodes.

Note: Working port should be Layer-2 Physical or LAG interface. Command is not applicable for subinterface.

Note: Protection port should be Layer-2 Physical or LAG interface. Command is not applicable for subinterface.

### Command Syntax

```
protection-port IFNAME
no protection-port
```

### Parameters

IFNAME                    Interface name.

### Command Mode

G8031 Switching Mode.

### Applicability

This command was introduced before OcNOS version 5.0.

### Examples

```
#configure terminal
(config)#g8031 eps-id 10 bridge 1
(g8031-config-switching)#protection-port xe10
```

---

## revertive

Use this command to configure revertive switchover-type for g8031 protection group.

Use the `no` form of this command to set default switchover-type for g8031 protection group.

### Command Syntax

```
revertive
no revertive
```

### Parameters

None.

### Default

Non-revertive.

### Command Mode

G8031 Switching Mode.

### Applicability

This command was introduced before OcNOS version 5.0.

### Examples

```
#configure terminal
(config)#g8031 eps-id 10 bridge 1
(g8031-config-switching)#mode one-and-one-bidirectional
(g8031-config-switching)#revertive
```

## show g8031 eps-id

Use this command to display the status of a particular g8031 protection group.

### Command Syntax

```
show g8031 eps-id <1-32> bridge <1-32>
```

### Parameters

<1-32>                    Protection group id.  
<1-32>                    Bridge name.

### Command Mode

Exec mode.

### Applicability

This command was introduced before OcNOS version 5.0.

### Examples

```
# show g8031 eps-id 10 bridge 1
```

```
===== Bridge:1 Eps-id:10
=====

Bridge  Direction  Revertive  PVID  Total-Vlans  Working-Path  Protection-Path
-----
1+1    Bi             Yes       10    7             xe7           xe8

Active-Path  Local-Freeze  -Attached  Request-Signal  Current-State
-----
--
Working      No             Yes        Null             Signal Fail for Protection

dFOP State: Not in defect mode

APS Statistics
-----
L-APS Rx count: 0
L-APS Tx count: 0
```

[Table 2-13](#) explains the output fields:

**Table 2-13: show g8031 eps-id output fields**

Field	Description
Bridge	Bridge id
Eps-id	Protection group id

<b>Field</b>	<b>Description</b>
Bridge	Architecture type - 1+1 or 1:1
Direction	Switching type - Bidirectional or Unidirectional
Revertive	Switchover type revertive
PVID	Primary vlan
Total-vlans	Total number of g8031 vlans
Working-path	Working port name
Protection-path	Protection port name
Active-path	Current active path
Local-freeze	Protection group locally freezed or not
-attached	Protection group attached to Meps or not
Request Signal	Null or Normal Signal
Current state	Protection group State as per State Machine
dFop State	Defect type
L-APS Rx count	Number of received g8031 L-APS control pkts
L-APS Tx count	Number of transmitted g8031 L-APS control pkts

---

## show g8031 bridge

Use this command to display the status of all configured g8031 protection groups.

### Command Syntax

```
show g8031 bridge <1-32>
```

### Parameters

<1-32>                      Bridge name

### Command Mode

Exec mode

### Applicability

This command was introduced before OcNOS version 5.0.

### Examples

```
# show g8031 bridge 1
```

```
===== Bridge:1 Eps-id:10
=====

Bridge  Direction  Revertive  PVID  Total-Vlans  Working-Path  Protection-Path
-----
1+1    Bi             Yes       10    7             xe7           xe8

Active-Path  Local-Freeze  -Attached  Request-Signal  Current-State
-----
Working      No            Yes        Null            Signal Fail for
Protection

dFOP State: Not in defect mode

APS Statistics
-----
L-APS Rx count: 0
L-APS Tx count: 0

===== Bridge:1 Eps-id:11
=====

Bridge  Direction  Revertive  PVID  Total-Vlans  Working-Path  Protection-Path
-----
1:1    Bi             Yes       11    7             xe12          xe11

Active-Path  Local-Freeze  -Attached  Request-Signal  Current-State
-----
Working      No            Yes        Null            Signal Fail for
Working
```

dFOP State: Not in defect mode

APS Statistics

-----

L-APS Rx count: 1

L-APS Tx count: 2

Table 2-14 explains the output fields:

**Table 2-14: show g8031 bridge output fields**

Field	Description
Bridge	Bridge id
Eps-id	Protection group id
Bridge	Architecture type - 1+1 or 1:1
Direction	Switching type - Bidirectional or Unidirectional
Revertive	Switchover type revertive
PVID	Primary vlan
Total-vlans	Total number of g8031 vlans
Working-path	Working port name
Protection-path	Protection port name
Active-path	Current active path
Local-freeze	Protection group locally freezed or not
Cfm-attached	Protection group attached to Meps or not
Request Signal	Null or Normal Signal
Current state	Protection group State as per State Machine
dFop State	Defect type
L-APS Rx count	Number of received g8031 L-APS control pkts
L-APS Tx count	Number of transmitted g8031 L-APS control pkts

---

## show hsl g8031 debug

Use this command to display debugging related information of a particular g8031 protection group.

### Command Syntax

```
show hsl g8031 debug <1-32>
```

### Parameters

<1-32>                    Protection group id

### Command Mode

Exec mode

### Applicability

This command was introduced before OcNOS version 5.0.

### Examples

```
# show hsl g8031 debug 10
=====
G8031 PG:10 Debug Details
=====
Mode                : 1+1 Bidir (Revertive)
Working Port        : 5007
Protection Port     : 5008
Active Port         : Working-Port
-----
Ingress Group-ID    : 112
  Cfm-Allow entry-id : 78 [InPort:5008]
  Data-Block entry-id : 79 [InPort:5008]
Egress Group-ID     : 115
  Split-H entry-id   : 80 [SrcPort:5007 DstPort:5008]
-----
Stp States
Working-Port        : Forward
Protection-Port     : Forward
-----
```

[Table 2-15](#) explains the output fields:

**Table 2-15: show hsl g8031 output fields**

Field	Description
PG	Protection group id
Mode	Configured g8031 mode on protection group
Working-Port	Working port ifindex



---

<b>Field</b>	<b>Description</b>
Protection port	Protection port ifindex
Active port	Current active port
Ingress group id	Ingress bcm field group id. Valid for 1+1 only
Cfm-allow entry id	Cfm related bcm entry is added in Ingress bcm field group. This displays entry-id of that field entry
Data-block entry-id	Data traffic related bcm entry is added in Ingress bcm field group. This displays entry-id of that field entry
Egress group id	Egress bcm field group id. Valid for 1+1 only
Split-H entry-id	Split-Horizon related entry is added in Egress field group. This displays entry-id of that field entry
Working-Port	Stp state of working port
Protection-port	Stp state of protection port

---

## timer hold-off-time

Use this command to configure hold-off timer for g8031 protection group.

Use the `no` form of this command to set default hold-off timer value for a g8031 protection group.

### Command Syntax

```
timer hold-off-time <0-10>
no timer hold-off-time
```

### Parameters

<0-10>                    Timer value in seconds.

### Default

0 seconds.

### Command Mode

Config mode.

### Applicability

This command was introduced before OcNOS version 5.0.

### Examples

```
#configure terminal
(config)#g8031 eps-id 10 bridge 1
(g8031-config-switching)#mode one-and-one-bidirectional
(g8031-config-switching)#revertive
(g8031-config-switching)#timer hold-off-time 3
```

---

## timer wait-to-restore

Use this command to configure wait-to-restore timer for a g8031 protection group.

Use the `no` form of this command to set default wait-to-restore value for a g8031 protection group.

This command is only applicable for revertive mode.

### Command Syntax

```
timer wait-to-restore <300-720>
no timer wait-to-restore
```

### Parameters

<300-720>           Timer value in seconds.

### Default

300 seconds.

### Command Mode

G8031 Switching Mode.

### Applicability

This command was introduced before OcnOS version 5.0.

### Examples

```
#configure terminal
(config)#g8031 eps-id 10 bridge 1
(g8031-config-switching)#mode one-and-one-bidirectional
(g8031-config-switching)#revertive
(g8031-config-switching)#timer wait-to-restore 360
```

---

## vlan

Use this command to configure protected data vlans for g8031 protection group.

Use the `no` form of this command to delete a data vlan for g8031 protection group.

Note: Once mode is configured, data vlans can not be modified.

Note: Data vlans have to be configured individually using `vlan` command i.e Range of vlans not accepted with `vlan` command.

Note: This command has no impact on data-plane i.e Unprotected vlans are not blocked by g8031 working and protection-ports. It is left upto the administrator to configure only protected vlans with bridge-port configuration of working and protection g8031 ports.

### Command Syntax

```
vlan <2-4094>
no vlan <2-4094>
```

### Parameters

<2-4094>            vlan-id.

### Command Mode

G8031 Switching Mode.

### Applicability

This command was introduced before OcNOS version 5.0.

### Examples

```
#configure terminal
(config)#g8031 eps-id 10 bridge 1
(g8031-config-switching)#vlan 4
```

---

## working-port

Use this command to configure a working-port for a g8031 protection group.

Use the `no` form of this command to delete working-port for a g8031 protection group.

### Command Syntax

```
working-port IFNAME
no working-port
```

### Parameters

IFNAME                    Interface name.

### Command Mode

G8031 Switching Mode.

### Applicability

This command was introduced before OcnOS version 5.0.

### Examples

```
#configure terminal
(config)#g8031 eps-id 10 bridge 1
(g8031-config-switching)#working-port xe10
```



## CHAPTER 3 G.8032 ERPS Version 2 Commands

---

This chapter contains the G.8032 (2012) Ethernet Ring Protection Switching (ERPS) version 2 commands.

- `aps-channel level`
- `aps-channel vlan`
- `clear g8032 erp-instance`
- `data vlan`
- `debug g8032`
- `east-interface`
- `enable-tcn-propagation`
- `erps-instance in subinterface`
- `g8032 erp-instance`
- `g8032 erp-instance force-switch`
- `g8032 erp-instance manual-switch`
- `g8032 ring`
- `g8032-profile`
- `g8032 profile`
- `non-virtual-channel`
- `ring`
- `ring-id`
- `ring-type`
- `rpl role`
- `show g8032 all erp-instance`
- `show g8032 erp-instance`
- `show g8032 profile`
- `show g8032 ring`
- `switching mode`
- `tcn-to-instance`
- `timer`
- `virtual-channel`
- `west-interface`

---

## aps-channel level

Use this command to set the maintenance entity group (MEG) level (MEL) to carry in R-APS messages.

### Command Syntax

```
aps-channel level <0-7>
```

### Parameters

<0-7>                    Level.

### Command Mode

G.8032 configure switch mode

### Examples

```
(g8032-config-switch)#aps-channel level 2
```



---

## aps-channel vlan

Use this command to configure APS channel VLAN-ID for this ERP instance.

### Command Syntax

```
aps-channel vlan <2-4094> (inner-vlan <2-4094>|)  
no aps-channel vlan
```

### Parameters

<2-4094>	VLANID
inner-vlan	Inner vlan
<2-4094>	VLANID

### Command Mode

G.8032 configure switch mode.

### Applicability

This command was introduced before OcNOS version 5.0.

### Examples

- (g8032-config-switch)#aps-channel vlan 10 inner-vlan 5

---

## clear g8032 erp-instance

Use this command at the Ethernet ring node for the following operations:

1. Clearing an active local administrative command (forced switch or manual switch).
2. Triggering reversion before the wait to restore (WTR) or wait to block (WTB) timer expires in the case of revertive operation.
3. Triggering reversion in the case of non-revertive operation.

### Command Syntax

```
#clear g8032 erp-instance INSTANCENAME
```

### Parameters

`INSTANCENAME` Instance name (maximum 32 characters).

### Command Mode

Exec mode.

### Applicability

This command was introduced before OcnOS version 5.0.

### Examples

```
#clear g8032 erp-instance INST1
```

---

## data vlan

Use this command to configure VLANs as data channels.

Use the `no` form of this command to remove the same.

### Command Syntax

```
data vlan VLAN_RANGE
no data vlan VLAN_RANGE
```

### Parameters

VLAN_RANGE	Enter VLAN ID 2-4094 or list of VLAN ID's separated by commas. Eg 2 or 2,4,5 or 50,51,52 etc.
------------	---

### Command Mode

G.8032 configure switch mode.

### Applicability

This command was introduced before OcnOS version 5.0.

### Examples

```
(g8032-config-switch)#data vlan 201,202,203
```

---

## debug g8032

Use this command to debug configuration.

### Command Syntax

```
debug g8032 (all|tx|rx|fsm|timers|events|external|hal)
no debug g8032 (all|tx|rx|fsm|timers|events|external|hal)
```

### Parameters

all	All debugging options.
events	Protocol event.
external	External CFM and NSM events.
fsm	Instance Finite State Machine updates.
hal	HAL events.
rx	Received PDUs.
timers	Protocol timer events.
tx	Transmitted PDUs.

### Command Mode

Configure mode.

Exec mode.

### Applicability

This command was introduced in OcNOS version 6.0.0.

### Examples

```
(config)#debug g8032 tx
(config)#debug g8032 all
```

---

## east-interface

Use this command to set the east port associated to the protection ring.

### Command Syntax

```
east-interface IFNAME
no east-interface
```

### Parameters

IFNAME                    Interface name, such as xe1.

### Command Mode

G8032 ring config mode.

### Applicability

This command was introduced before OcnOS version 5.0.

### Examples

```
(config-if)#g8032 ring RING1
(g8032-ring-config)# east-interface ce1
```

---

## enable-tcn-propagation

Use this command to enable or disable TCN (topology change notification) propagation for an interconnected ring.

### Command Syntax

```
enable-tcn-propagation
no enable-tcn-propagation
```

### Parameters

None.

### Command Mode

G.8032 configure switch mode.

### Applicability

This command was introduced in OcNOS version 6.0.0.

### Examples

```
(g8032-config-switch) #enable-tcn-propagation
```

---

## erps-instance in subinterface

Use this command to set the erps-instance in subinterface.

### Command Syntax

```
erps-instance (INSTANCENAME | none)
no erps-instance
```

### Parameters

INSTANCENAME	Instance name
none	No ERPS instance will protect this subinterface

### Command Mode

Subinterface mode.

### Applicability

This command was introduced in OcNOS version 6.2.0.

### Examples

```
OcNOS (config) #interface xe2.1
OcNOS (config-if) #erps-instance ?
INSTANCENAME Instance name
none          No ERPS instance will protect this subinterface
OcNOS (config-if) #erps-instance erp1
OcNOS (config-if) #commit
OcNOS (config-if) #
```

---

## **g8032 erp-instance**

Use this command to create an ERP instance and change to G.8032 configure switch mode.

Use the `no` form of this command to delete an ERP instance.

### **Command Syntax**

```
g8032 erp-instance INSTANCENAME
no g8032 erp-instance INSTANCENAME
```

### **Parameters**

`INSTANCENAME` Instance name (maximum 32 characters).

### **Command Mode**

Configure mode

### **Examples**

```
#configure terminal
(config)#g8032 erp-instance instance1
(g8032-config-switch)#
```



---

## g8032 erp-instance force-switch

Use this command to configure administrative commands.

### Command Syntax

```
g8032 erp-instance INSTANCE-NAME force-switch (east-interface | west-interface)
```

### Parameters

`INSTANCENAME` Instance name (maximum 32 characters).

`east-interface` Apply command to east interface.

`west-interface` Apply command to west interface.

### Command Mode

Exec mode.

### Applicability

This command was introduced before OcnOS version 5.0.

### Examples

```
#g8032 erp-instance example force-switch east-interface
```

---

## **g8032 erp-instance manual-switch**

Use this command to configure administrative commands.

### **Command Syntax**

```
g8032 erp-instance INSTANCE-NAME manual-switch (east-interface | west-interface)
```

### **Parameters**

`INSTANCENAME` Instance name (maximum 32 characters).

`east-interface` Apply command to east interface.

`west-interface` Apply command to west interface.

### **Command Mode**

Exec mode.

### **Applicability**

This command was introduced before OcnOS version 5.0.

### **Examples**

```
#g8032 erp-instance example manual-switch west-interface
```

---

## g8032 ring

Use this command to create a ring and associate east and west interfaces with it. All ERP instances on this ring have the same east and west interfaces,

Use the `no` form of this command to delete a ring.

### Command Syntax

```
g8032 ring RINGNAME
no g8032 ring RINGNAME
```

### Parameters

<code>ring</code>	Ring.
<code>RINGNAME</code>	Ring name (maximum 37 characters).

### Command Mode

Configure mode

### Examples

```
#configure terminal
(config)#g8032 ring ERPS123
(config)#no g8032 ring ERPS123
```

---

## g8032-profile

Use this command to associate the ERP instance to a profile.

### Command Syntax

```
g8032-profile PROFILENAME
```

### Parameters

PROFILENAME      Profile name.

### Command Mode

G.8032 configure switch mode

### Examples

```
(g8032-config-switch)g8032-profile prof_1
```

---

## g8032 profile

Use this command to associate the ERPS profile to an instance.

Use the `no` form of this command to delete the ERPS profile from an instance.

### Command Syntax

```
g8032 profile PROFILENAME
```

### Parameters

PROFILENAME      Profile name.

### Command Mode

G.8032 configure switch mode

### Examples

```
(g8032-config-switch)g8032-profile prof_1
```

---

## non-virtual-channel

Use this command to make a sub-ring function without a virtual channel.

Use the `no` form of this command to delete a non-virtual channel.

### Command Syntax

```
non-virtual-channel
no non-virtual-channel
```

### Parameters

None.

### Command Mode

G.8032 configure switch mode.

### Applicability

This command was introduced before OcNOS version 5.0.

### Examples

```
(g8032-config-switch) #non-virtual-channel
```

## ring

Use this command to associate the ERP instance to a ring.

### Command Syntax

```
ring RINGNAME
```

### Parameters

RINGNAME	Ring name.
----------	------------

### Command Mode

G.8032 configure switch mode

### Examples

```
(g8032-config-switch)#ring ring1
```

---

## ring-id

Use this command to set the ring identifier.

### Command Syntax

```
ring-id <1-239>
```

### Parameters

<1-239>            Ring identifier.

### Command Mode

G.8032 configure switch mode.

### Applicability

This command was introduced before OcnOS version 5.0.

### Examples

```
(g8032-config-switch)#ring-id 1
```



## ring-type

Use this command to specify the type of the ethernet ring for this ERP instance.

### Command Syntax

```
ring-type (major-ring | sub-ring | sub-ring-vc)
no ring-type
```

### Parameters

major-ring	G.8032 major ring. In this type of rings nodes are connected in full circular topology
sub-ring	G.8032 sub-ring without virtual channel
sub-ring-vc	G.8032 sub-ring with virtual channel

### Command Mode

G.8032 configure switch mode.

### Applicability

This command was introduced before OcnOS version 5.0.

### Examples

```
(g8032-config-switch)#ring-type major-ring
(g8032-config-switch)#ring-type sub-ring-vc
```

---

## rpl role

Use this command to set the RPL (Ring Protection Link) role of the ring node.

### Command Syntax

```
rpl role ((owner | neighbor | next-neighbor) (east-interface | west-interface) |
non-owner )
```

### Parameters

owner	Ring node is the RPL owner.
neighbor	Ring node is neighbor to the RPL owner.
next-neighbor	Ring node is neighbor to the neighbor of the RPL owner.
east-interface	Role assigned to east interface.
west-interface	Role assigned to west interface.
non-owner	Ring node does not own the RPL.

### Command Mode

G.8032 configure switch mode.

### Applicability

This command was introduced before OcNOS version 5.0.

### Examples

```
(g8032-config-switch)#rpl role owner east-interface
```

---

## show g8032 all erp-instance

Use this command to display details about **all** ERP instances.

### Command Syntax

```
show g8032 all erp-instance
```

### Parameters

None

### Command Mode

EXEC mode.

### Applicability

This command was introduced in OcNOS version 6.0.0.

### Example

```
(config)#show g8032 all erp-instance
Inst Name   : instance1
State       : G8032_ST_INIT
Phy Ring    : -
Role        : -
East Link   : -
West Link   : -
Attached    : -
Attached To : -
Virt Chan   : -
```

```
-----
          Channel          |      Interface          | Profile
(LEVL, VID, RID)         | (east,ver), (west,ver) |
=====
(7, 4065, 135)           | (eth11,1), (eth2,2)    | PROF1
=====
Data Traffic: 1,2,3,10,12...
```

## show g8032 erp-instance

Use this command to display details about an ERP instance.

### Command Syntax

```
show g8032 erp-instance INSTANCENAME
```

### Parameters

INSTANCENAME Instance name.

### Command Mode

Exec mode.

### Applicability

This command was introduced before OcnOS version 5.0.

### Example

```
(config)#show g8032 erp-instance instancel
Inst Name   : instancel
State      : G8032_ST_INIT
Phy Ring   : -
Role       : -
East Link  : -
West Link  : -
Attached   : -
Attached To: -
Virt Chan  : -
```

```
-----
      Channel      |      Interface      | Profile
(LEVL, VID, RID) | (east,ver), (west,ver) |
=====
(7, 4065, 135)   | (eth11,1), (eth2,2) | PROF1
=====
```

```
Data Traffic: 1,2,3,10,12...
```

---

## show g8032 profile

Use this command to display details about a profile.

### Command Syntax

```
show g8032 profile PROFILENAME
```

### Parameters

PROFILENAME      Profile name.

### Command Mode

Exec mode.

### Applicability

This command was introduced before OcnOS version 5.0.

### Examples

```
(config)#show g8032 profile profile1
Profile : profile1
=====
Wait-To-Restore : 5 mins
Hold Off Timer  : 0 secs
Guard Timer     : 500 ms
Wait-To-Block   : 5500 ms
Protection Type : Revertive
```

---

## show g8032 ring

Use this command to display details about a ring.

### Command Syntax

```
show g8032 ring RINGNAME
```

### Parameters

RINGNAME	Ring name.
----------	------------

### Command Mode

Exec mode.

### Applicability

This command was introduced before OcnOS version 5.0.

### Examples

```
(config)#show g8032 ring ring1
Ring      : ring1
=====
East     : eth1
West     : eth2
ERP Inst : inst1, inst2, inst3
```

---

## switching mode

Use this command to set the revertive behavior of the ring node.

### Command Syntax

```
switching mode (non-revertive | revertive)
```

### Parameters

<code>revertive</code>	Represents revertive mode operation of a G.8032 ethernet ring.
<code>non-revertive</code>	Represents non-revertive mode operation of a G.8032 ethernet ring.

### Command Mode

G.8032 profile configure mode.

### Applicability

This command was introduced before OcnOS version 5.0.

### Examples

```
(g8032-profile-config)# switching mode revertive
```

---

## tcn-to-instance

Use this command to associate TCN instance (topology change notification) propagation for an interconnected ring when configured in non-virtual mode.

### Command Syntax

```
tcn-to-instance INSTANCENAME
```

### Parameters

`INSTANCENAME` Instance name.

### Command Mode

G.8032 configure switch mode.

### Applicability

This command was introduced before OcNOS version 5.0.

### Examples

```
(config)#tcn-to-instance erp1
```



## timer

Use this command to set timers.

### Command Syntax

```
timer (wait-to-restore <1-12> | hold-off <0-10000> | guard-time <10-2000>)
```

### Parameters

wait-to-restore

Wait-to-restore timer used to verify that a signal failure is not intermittent.

<1-12>

Timer value in minutes.

hold-off

Hold-off timer used to filter intermittent link faults.

<0-10000>

Timer value in a multiple of 100 milliseconds.

guard-time

Guard timer that blocks latent outdated messages from causing unnecessary state changes.

<1-20000>

Timer value in a multiple of 10 milliseconds.

### Command Mode

G.8032 profile configure mode

### Examples

```
(g8032-profile-config)#timer wait-to-restore 7
(g8032-profile-config)#timer hold-off 50
(g8032-profile-config)#timer guard-time 300
s(g8032-profile-config)#timer guard-time 30
```

---

## virtual-channel

Use this command on a sub-ring to attach it to a major instance.

Use the `no` form of this command to delete a virtual channel.

### Command Syntax

```
virtual-channel (<2-4094>|) attached-to-instance INSTANCENAME  
no virtual-channel
```

### Parameters

<code>&lt;2-4094&gt;</code>	VLAN identifier.
<code>INSTANCENAME</code>	Major instance name.

### Command Mode

G.8032 configure switch mode.

### Applicability

This command was introduced before OcNOS version 5.0.

### Examples

```
(g8032-config-switch)#virtual-channel 3 attached-to-instance inst1
```

---

## west-interface

Use this command to set the west port associated to the protection ring.

### Command Syntax

```
west-interface IFNAME
no west-interface
```

### Parameters

IFNAME	Interface name
--------	----------------

### Command Mode

G8032 ring config mode.

### Applicability

This command was introduced before OcNOS version 5.0.

### Examples

```
(config-if)#g8032 ring RING1
(g8032-ring-config)# west-interface cel
```



---

## CHAPTER 4 EFM OAM Commands

---

Ethernet to the First Mile (EFM) provides a minimal extension to the MAC layer Operations, Administration and Maintenance (OAM) module. EFM supplies a mechanism for monitoring link operations, such as remote fault detection and remote loopback control.

This chapter includes the following commands:

- `clear ethernet oam statistics interface`
- `debug ethernet oam`
- `ethernet oam enable`
- `ethernet oam link-monitor event-log-size`
- `ethernet oam link-monitor on`
- `ethernet oam link-monitor supported`
- `ethernet oam max-rate`
- `ethernet oam min-rate`
- `ethernet oam mode`
- `ethernet oam remote-failure`
- `ethernet oam remote-loopback (start|stop)`
- `ethernet oam remote-loopback {supported|timeout}`
- `ethernet oam timeout`
- `show ethernet oam`
- `show ethernet oam discovery`
- `show ethernet oam eventlog`
- `show ethernet oam statistics`
- `show ethernet oam status`
- `show ethernet oam discovery brief`

---

## clear ethernet oam statistics interface

Use this command to reset the OAM statistics to zero.

### Command Syntax

```
clear ethernet oam statistics interface <IFNAME>
```

### Parameter

None

### Config Mode

Exec mode

### Applicability

Ethernet OAM (EFM) supported platforms

### Example

```
#clear ethernet oam statistics interface xe2
```

---

## debug ethernet oam

Use this command to set the debugging functions for OAM.

Use the `no` form of this command to disable OAM debugging.

### Command Syntax

```
debug ethernet oam (event|rx|tx|all)
no debug ethernet oam (event|rx|tx|all)
```

### Parameters

<code>event</code>	Enable event debugging.
<code>rx</code>	Enable RX debugging.
<code>tx</code>	Enable TX debugging.
<code>all</code>	Enable Event, RX and TX debugging

### Command Mode

Exec mode and Config mode

### Example

```
#debug ethernet oam event
```

---

## ethernet oam enable

Use this command to enable or disable Ethernet OAM functionality on a port.

Use the `no` form of this command to disable Ethernet OAM functionality on a port.

### Command Syntax

```
ethernet oam enable
no ethernet oam enable
```

### Parameters

None

### Default

Ethernet OAM is disabled.

### Command Mode

Interface mode

### Applicability

This command was introduced in OcNOS version 5.0.

### Examples

```
#configure terminal
(config)#interface xe1
(config-if)#ethernet oam enable
```



---

## ethernet oam link-monitor event-log-size

Use this command to set the maximum number of entries in the event log.

### Command Syntax

```
ethernet oam link-monitor event-log-size <1-100>
```

### Parameters

<code>event-log-size</code>	Set a log size
<code>&lt;1-100&gt;</code>	Set a log size

### Command Mode

Interface mode

### Default

The default size is 20 entries

### Example

```
#configure terminal
(config)#interface eth1
(config-if)#ethernet oam link-monitor event-log-size 100
```

---

## ethernet oam link-monitor on

Use this command to turn on link monitoring on a interface.

Use the `no` form of this command to turn link monitoring off.

### Command Syntax

```
ethernet oam link-monitor on
no ethernet oam link-monitor on
```

### Parameters

None

### Default

When link monitor is supported, link monitoring is automatically turned on.

### Command Mode

Interface mode

### Applicability

This command was introduced in OcNOS version 5.0.

### Examples

```
#configure terminal
(config)#interface xe1
(config-if)#ethernet oam link-monitor on
```

---

## ethernet oam link-monitor supported

Use this command to configure link monitoring on an interface.

Use the `no` form of this command to remove support for link monitoring on an interface.

### Command Syntax

```
ethernet oam link-monitor supported
no ethernet oam link-monitor supported
```

### Parameters

None

### Command Mode

Interface mode

### Default

The default state of the link monitor is supported.

### Applicability

This command was introduced in OcNOS version 5.0.

### Examples

```
#configure terminal
(config)#interface xe1
(config-if)#ethernet oam link-monitor supported
```

---

## ethernet oam max-rate

Use this command to set the maximum number of PDUs per second.

This command ensures that the sublayer adheres to the maximum number of OAMPDUs per second. The minimum is 1 OAMPDU per second and the maximum is 10 OAMPDUs per second.

Use the `no` form of this command to reset the maximum rate to its default.

### Command Syntax

```
ethernet oam max-rate <1-10>
no ethernet oam max-rate
```

### Parameter

<1-10>                    Maximum number of PDUs per second.

### Default

The default maximum rate is 10 PDUs per second.

### Command Mode

Interface mode

### Applicability

This command was introduced in OcnOS version 5.0.

### Examples

```
#configure terminal
(config)#interface xe1
(config-if)#ethernet oam max-rate 10
```

---

## ethernet oam min-rate

Use this command to set the minimum number of PDUs per second.

This command ensures that the sublayer adheres to the maximum number of OAMPDUs per second. The minimum is 1 OAMPDU per second and the maximum is 10 OAMPDUs per second.

Use the `no` form of this command to reset the minimum to its default.

### Command Syntax

```
ethernet oam min-rate <1-10>
no ethernet oam min-rate
```

### Parameter

<1-10>                    Minimum number of PDUs per second.

### Default

The default minimum rate is 1 PDU per second.

### Command Mode

Interface mode

### Applicability

This command was introduced in OcNOS version 5.0.

### Examples

```
#configure terminal
(config)#interface xe1
(config-if)#ethernet oam min-rate 1
```

---

## ethernet oam mode

Use this command to set data terminal equipment (DTE) to either active or passive mode.

### Command Syntax

```
ethernet oam mode (active|passive)
```

### Parameters

active	Set DTE to active mode.
passive	Set DTE to passive mode.

### Default

The default mode for the DTE is active.

### Command Mode

Interface mode

### Applicability

This command was introduced in OcNOS version 5.0.

### Example

```
#configure terminal
(config)#interface xe1
(config-if)#ethernet oam mode active

#configure terminal
(config)#interface xe1
(config-if)#ethernet oam mode passive
```

---

## ethernet oam remote-failure

Use this command to define an action when a remote failure is detected.

Use `no` form of this command to remove an action.

### Command Syntax

```
ethernet oam remote-failure {critical-event|dying-gasp|link-fault} action error-  
disable-interface
```

```
no ethernet oam remote-failure {critical-event|dying-gasp|link-fault} action error-  
disable-interface
```

### Parameters

`critical-event` Critical link event.

`dying-gasp` Dying-gasp event.

`link-fault` Link-fault event.

`action` Action on a remote failure.

`error-disable-interface`

Disable the interface when a remote failure event is detected.

### Default

A remote failure does not trigger any interface events by default.

### Command Mode

Interface mode

### Applicability

This command was introduced in OcNOS version 5.0.

### Examples

```
#configure terminal  
(config)#interface xe1  
(config-if)#ethernet oam remote-failure critical-event action error-disable-  
interface
```

## ethernet oam remote-loopback (start|stop)

Use this command to start or stop remote loopback.

### Command Syntax

```
ethernet oam remote-loopback start
ethernet oam remote-loopback stop
```

### Parameters

start	Specify to start remote loopback.
stop	Specify to stop remote loopback.

### Command Mode

Interface mode

### Applicability

This command was introduced in OcNOS version 5.0.

### Examples

```
#configure terminal
(config)#interface xe1
(config-if)#ethernet oam remote-loopback start

#configure terminal
(config)#interface xe1
(config-if)#ethernet oam remote-loopback stop
```



---

## ethernet oam remote-loopback {supported|timeout}

Use this command to configure remote loopback on an interface.

Use the `no` form of this command to remove remote-loopback support from the interface.

### Command Syntax

```
ethernet oam remote-loopback {supported|timeout <1-10>}
no ethernet oam remote-loopback {supported|timeout}
```

### Parameters

<code>supported</code>	Configure remote loopback support.
<code>timeout</code>	Remote loopback timeout.
<code>&lt;1-10&gt;</code>	Number of seconds the DTE waits for the remote DTE to respond to the <code>ethernet oam remote-loopback start</code> command.

### Default

The default state for remote loopback is supported. If a timeout is not set, the local DTE remains in remote loopback state until the remote DTE responds or the user stops remote loopback administratively.

### Command Mode

Interface mode

### Applicability

This command was introduced in OcNOS version 5.0.

### Examples

```
#configure terminal
(config)#interface xe1
(config-if)#ethernet oam remote-loopback supported

#configure terminal
(config)#interface xe1
(config-if)#ethernet oam remote-loopback timeout 2

#configure terminal
(config)#interface xe1
(config-if)#no ethernet oam remote-loopback supported

#configure terminal
(config)#interface xe1
(config-if)#no ethernet oam remote-loopback timeout
```

## ethernet oam timeout

Use this command to set the OAM timeout.

Use the `no` form of this command to reset the timeout to its default.

### Command Syntax

```
ethernet oam timeout <2-30>
no ethernet oam timeout
```

### Parameter

<2-30>                    Number of seconds for the link timeout

### Command Mode

Interface mode

### Default

The default timeout is 5 seconds

### Applicability

This command was introduced in OcNOS version 5.0.

### Examples

```
#configure terminal
(config)#interface xe1
(config-if)#ethernet oam timeout 5

(config)#interface xe1
(config-if)#no ethernet oam timeout
```

---

## show ethernet oam

Use this command to show the discovery state machine state and link event statistics on the interface.

### Command Syntax

```
show ethernet oam IFNAME
```

### Parameter

IFNAME                      Specify the interface name.

### Command Mode

Exec mode and Privileged Exec mode

### Examples

The following sample output from this command displays the operational discovery state machine and link event statistics of the interface.

```
#show ethernet oam eth0

eth0
Discovery State Machine Details:
-----
EFM Discovery Machine State:          Send Any
Local Parser State:                  Forward
Local Multiplexer State:             Forward
Remote Parser State:                 Forward
Remote Multiplexer State:            Forward

Local Client:
-----
Symbol Period Error:
  Window:                            05f5e100 Symbol(s)
  Threshold:                          00 Symbol(s)
  Last Window Symbols Errors:         00 Symbol(s)
  Total Symbols Errors:               00 Symbol(s)
  Total Symbols Errors Events:        0 Events(s)
  Relative Timestamp of the Event:    0 x 100 milliseconds

Frame Error:
  Window:                            100 x 100 milliseconds
  Threshold:                          1 Error Frame(s)
  Last Window Frame Errors:           0 Frame(s)
  Total Frame Errors:                 00 Frames(s)
  Total Frame Errors Events:          0 Events(s)
  Relative Timestamp of the Event:    0 x 100 milliseconds

Frame Period Error:
  Window:                            989680 Frames
  Threshold:                          1 Error Frame(s)
  Last Window Frame Errors:           0 Frame(s)
  Total Frame Errors:                 00 Frames(s)
  Total Frame Period Errors Events:   0 Events(s)
  Relative Timestamp of the Event:    0 x 100 milliseconds
```

Frame Seconds Error:  
Window: 1000 x 100 milliseconds  
Threshold: 1 Error Second(s)  
Last Window Frame Second Errors: 0 Frame(s)  
Total Frame Second Errors: 00 Frames(s)  
Total Frame Second Errors Events: 0 Events(s)  
Relative Timestamp of the Event: 0 x 100 milliseconds

Remote Client:  
-----

Symbol Period Error:  
Window: 00 Symbol(s)  
Threshold: 00 Symbol(s)  
Last Window Symbols Errors: 00 Symbol(s)  
Total Symbols Errors: 00 Symbol(s)  
Total Symbols Errors Events: 0 Events(s)  
Relative Timestamp of the Event: 0 x 100 milliseconds

Frame Error:  
Window: 0 x 100 milliseconds  
Threshold: 0 Error Frame(s)  
Last Window Frame Errors: 0 Frame(s)  
Total Frame Errors: 00 Frames(s)  
Total Frame Errors Events: 0 Events(s)  
Relative Timestamp of the Event: 0 x 100 milliseconds

Frame Period Error:  
Window: 0 Frames  
Threshold: 0 Error Frame(s)  
Last Window Frame Errors: 0 Frame(s)  
Total Frame Errors: 00 Frames(s)  
Total Frame Period Errors Events: 0 Events(s)  
Relative Timestamp of the Event: 0 x 100 milliseconds

---

## show ethernet oam discovery

Use this command to display the Ethernet OAM administrative and operation configuration for local and remote DTE.

### Command Syntax

```
show ethernet oam discovery interface IFNAME
```

### Parameter

interface	Specify the interface.
IFNAME	Specify the interface name.

### Command Mode

Exec mode and Privileged Exec mode

### Example

The following output displays ethernet OAM administrative and operation configurations for local and remote DTE.

```
#show ethernet oam discovery interface eth0
eth0
Local client:
-----
Administrative configurations:
Mode: passive
Unidirection: supported
Link monitor: supported(on)
Remote Loopback: supported
MIB retrieval: not supported
MTU Size : 1518
Operational status:
Port status: operational
Loopback status: no loopback
PDU revision: 1
Remote client:
-----
MAC address: 0002.b3d5.93b7
Vendor(oui): 3 0 50

Administrative configurations:
Mode: active
Unidirection: supported
Link monitor: supported
Remote Loopback: supported
MIB retrieval: not supported
MTU Size : 1518
```

---

## show ethernet oam eventlog

Use this command to display all event logs for an interface within given range.

### Command Syntax

```
show ethernet oam eventlog IFNAME range-start <1-100> range-end <1-100>
```

### Parameters

IFNAME	The name of the interface.
range-start	Starting range of log index.
<1-100>	Starting range of log index. This should not exceed the maximum log size.
range-end	Ending range of log index.
<1-100>	Ending range of log index. This should not exceed the maximum log size.

### Command Mode

Exec mode and Privileged Exec mode

### Example

The following displays an example of this command:

```
#show ethernet oam eventlog eth1 range-start 10
```

---

## show ethernet oam statistics

Use this command to see the Ethernet OAM statistics.

### Command Syntax

```
show ethernet oam statistics interface IFNAME
```

### Parameter

interface	Specify the interface.
IFNAME	Specify the interface name.

### Command Mode

Privileged Exec mode

### Example

The following sample output from this command displays Ethernet OAM statistics for the interface named eth0.

```
#show ethernet oam statistics interface eth0
eth0
Counters:
-----
Information OAMPDU Tx           : 39
Information OAMPDU Rx           : 39
Event Notification OAMPDU Tx    : 0
Event Notification OAMPDU Rx    : 0
Loopback Control OAMPDU Tx     : 0
Loopback Control OAMPDU Rx     : 0
Unsupported OAMPDU Rx          : 0
Local event logs:
-----
 0 Errored Symbol Period records
 0 Errored Frame records
 0 Errored Frame Period records
 0 Errored Frame Seconds records
Remote event logs:
-----
 0 Errored Symbol Period records
 0 Errored Frame records
 0 Errored Frame Period records
 0 Errored Frame Seconds records
```

---

## show ethernet oam status

Use this command to display the ethernet OAM and link monitoring status of the interface.

### Command Syntax

```
show ethernet oam status interface IFNAME
```

### Parameter

interface	Specify the interface.
IFNAME	Specify the interface name.

### Command Mode

Privileged Exec mode

### Example

The following sample output displays the operational discovery state machine and link event statistics of the interface.

```
#show ethernet oam status interface eth0
eth0
General:
  Mode: passive
  PDU max rate: 10 packets per second
  PDU min rate: 1 packet per 1 second
  Link timeout: 5 seconds
  High threshold action: no action
Link Monitoring:
  Status: supported(on)
  Symbol Period Error:
    Window: 100 million symbols
    Low threshold: 0 error symbol(s)
    High threshold: none
  Frame Error:
    Window: 100 x 100 milliseconds
    Low threshold: 1 error frame(s)
    High threshold: none
  Frame Period Error:
    Window: 1000 x 100,000 frames
    Low threshold: 1 error frame(s)
    High threshold: none
  Frame Seconds Error:
    Window: 1000 x 100 milliseconds
    Low threshold: 1 error second(s)
    High threshold: none
```



---

## show ethernet oam discovery brief

Use this command to list the brief overview of ethernet oam (EFM) across all the interfaces.

### Command Syntax

```
show ethernet oam discovery brief
```

### Parameter

None

### Config Mode

Exec mode

### Applicability

Ethernet OAM (EFM) supported platforms

### Example

```
#show ethernet oam discovery brief
```

```
Flags : L - Link Monitoring support M - MIB Retrieval support  
R - Remote Loopback support U - Unidirectional detection support
```

```
data is unavailable
```

Local Interface	Remote MAC	Remote Capability	Local Capability
xe0	0000.0000.0000	Passive LR	Active LR
xe1	*	*	Active LR



# Index

## B

begin modifier 16  
 BGP community value  
   command syntax 14  
 braces  
   command syntax 13

## C

cc interval 189, 190  
 cc multicast 197  
 CFM commands  
   cc interval 189, 190  
   cc multicast 197  
   mep crosscheck mpid 238  
   show ethernet cfm ma status 267  
 command abbreviations 12  
 command completion 12  
 command line  
   errors 12  
   help 11  
   keyboard operations 15  
 command modes 19  
   configure 19  
   exec 19  
   interface 19  
   privileged exec 19  
   router 19  
 command negation 13  
 command syntax  
   ? 14  
   . 14  
   () 13  
   {} 13  
   | 13  
   A.B.C.D/M 14  
   AA:NN 14  
   BGP community value 14  
   braces 13  
   conventions 13  
   curly brackets 13  
   HH:MM:SS 14  
   IFNAME 14  
   interface name 14  
   IPv4 address 14  
   IPv6 address 14  
   LINE 14  
   lowercase 13  
   MAC address 14  
   monospaced font 13  
   numeric range 14  
   parantheses 13  
   parentheses 13  
   period 14

question mark 14  
 square brackets 14  
 time 14  
 uppercase 13  
 variable placeholders 14  
 vertical bars 13  
 WORD 14  
 X:X::X:X 14  
 X:X::X:X/M 14  
 XX:XX:XX:XX:XX:XX 14  
 configure  
   EFM OAM  
     Ethernet to the First Mile 165  
 configure mode 19  
 curly brackets  
   command syntax 13

## E

Ethernet OAM CLI  
   ethernet oam disable 352  
   ethernet oam enable 352  
   ethernet oam link-monitor on 354  
   ethernet oam link-monitor remote-failure 359  
   ethernet oam link-monitor supported 355  
   ethernet oam max-rate 356  
   ethernet oam remote-loopback 360  
   show ethernet oam discovery interface 365  
   show ethernet oam interface statistics 367  
   show ethernet oam status interface 368  
 ethernet oam disable 352  
 ethernet oam enable 352  
 ethernet oam link-monitor on 354  
 ethernet oam link-monitor remote-failure 359  
 ethernet oam link-monitor supported 355  
 ethernet oam max-rate 356  
 ethernet oam remote-loopback 360  
 Ethernet Ring Protection Switching (ERPS)  
   configuration 87  
 exec command mode 19

## I

IFNAME 14  
 interface mode 19  
 IPv4 address  
   command syntax 14  
 IPv6 address  
   command syntax 14

## L

LINE 14  
 link Monitoring  
   validation 165, 178

## M

MAC address

command syntax 14

## **P**

parentheses

command syntax 13

parentheses

command syntax 13

period

command syntax 14

privileged exec mode 19

## **Q**

question mark

command syntax 14

## **R**

remote failure detection 166, 179

router mode 19

## **S**

show commands 16

exclude modifier 17

include modifier 17

redirect modifier 18

show ethernet oam discovery interface 365

show ethernet oam interface statistics 367

show ethernet oam status interface 368

square brackets

command syntax 14

## **T**

time

command syntax 14

## **V**

validation 166, 179

vertical bars

command syntax 13

## **W**

WORD 14