



**OcNOS®**  
**Open Compute**  
**Network Operating System**  
**for Routed Optical Networking**  
**Version 6.4.2**

**Layer 2 Guide**  
June 2024

---

© 2024 IP Infusion Inc. All Rights Reserved.

This documentation is subject to change without notice. The software described in this document and this documentation are furnished under a license agreement or nondisclosure agreement. The software and documentation may be used or copied only in accordance with the terms of the applicable agreement. No part of this publication may be reproduced, stored in a retrieval system, or transmitted in any form or any means electronic or mechanical, including photocopying and recording for any purpose other than the purchaser's internal use without the written permission of IP Infusion Inc.

IP Infusion Inc.  
3965 Freedom Circle, Suite 200  
Santa Clara, CA 95054  
+1 408-400-1900  
<http://www.ipinfusion.com/>

For support, questions, or comments via E-mail, contact:  
[support@ipinfusion.com](mailto:support@ipinfusion.com)

Trademarks:

IP Infusion and OcNOS are trademarks or registered trademarks of IP Infusion. All other trademarks, service marks, registered trademarks, or registered service marks are the property of their respective owners.

Use of certain software included in this equipment is subject to the IP Infusion, Inc. End User License Agreement at <http://www.ipinfusion.com/license>. By using the equipment, you accept the terms of the End User License Agreement.

# Contents

<b>Preface</b> .....	<b>xiii</b>
IP Maestro Support .....	.xiii
Audience .....	.xiii
Conventions .....	.xiii
Chapter Organization .....	.xiii
Related Documentation .....	.xiii
Migration Guide .....	xiv
Feature Availability .....	xiv
Support .....	xiv
Comments .....	xiv
<b>Command Line Interface</b> .....	<b>15</b>
Overview .....	15
Command Line Interface Help .....	15
Command Completion .....	16
Command Abbreviations .....	16
Command Line Errors .....	16
Command Negation .....	17
Syntax Conventions .....	17
Variable Placeholders .....	18
Command Description Format .....	19
Keyboard Operations .....	19
Show Command Modifiers .....	20
String Parameters .....	23
Command Modes .....	23
Transaction-based Command-line Interface .....	25
<b>Layer 2 Configuration Guide</b> .....	<b>27</b>
CHAPTER 1 VLAN Configuration .....	27
Configuring VLAN Tags .....	27
CHAPTER 2 Disabling Native VLAN Configuration on Trunk mode .....	27
Topology .....	27
Configuration .....	27
Configuring Disable-Native-VLAN on Trunk mode .....	29
CHAPTER 3 Spanning Tree Protocol Configuration .....	27
Configurations .....	27
CHAPTER 4 RSTP Configuration .....	27
Configuration .....	27
CHAPTER 5 MSTP Configuration .....	27
Configuration .....	27

CHAPTER 6	Disable Spanning Tree Configuration	27
	Disabling MSTP Configuration	27
	STP Configuration	32
	RSTP Configuration	35
CHAPTER 7	RPVST+ Configuration	27
	Topology	27
	Configuration	27
CHAPTER 8	Link Aggregation Configuration	27
	Topology	27
	Dynamic LAG Configuration	27
	Static LAG Configuration	29
	Static LAG Minimum Link Configuration	32
	Static-LAG Minimum Bandwidth Configuration	34
	Dynamic-LAG Minimum Link Configuration	37
	Dynamic LAG Minimum Bandwidth Configuration	41
	LACP Minimum-Link, Minimum-Bandwidth on Dynamic and Static Channel-Groups with MC-LAG	44
	LACP Force-Up	57
	Validation	59
CHAPTER 9	MLAG Configuration	27
	Dynamic Configuration	27
	Static Configuration	35
	ARP ACL Configuration	43
	Disabling STP for MLAG	49
CHAPTER 10	802.1X Configuration	27
	Switch Configuration	27
CHAPTER 11	Port Security Configuration	27
	Secured MACs Learned Dynamically	27
	Secured MAC Addresses Learned Statically	29
	Static Mode	30
	Port Security using MC-LAG	32
CHAPTER 12	Port Breakout Configuration	27
	Overview	27
	Terminology	27
	Pre-Requisite	28
	Configuring vlan-reservation	28
	Unconfiguring vlan-reservation	28
	Validation	28
	Configuring Port Breakout 40G to 4x10G	29
	Removing Port Breakout	29
	Configuring Port Breakout (100G to 4x10G)	38
	Configuring Port Breakout (100G to 4x25G)	39
	Configuring Port Breakout (100G to 2x50G)	40

---

CHAPTER 13	Layer 2 Control Protocols Tunneling	27
	Overview	27
	L2CP Tunneling for Provider Bridging	27
	L2CP Tunneling for VPLS/VPWS/Hybrid (Bridge+VPWS)	28
	L2CP Tunneling for VXLAN	28
	L2CP Behavior	29
	Default L2CP configuration	30
	Operational Concepts and Scenarios	31
CHAPTER 14	Provider Bridging Configuration	27
	Single Provider Bridge Configuration	27
	Two Provider Bridge Configuration	30
	Layer 2 Protocol Tunneling (L2PT/L2CP Tunneling)	35
	Provider Bridging with VLAN Translation	37
	Provider Bridging QoS Configuration	47
	Provider Bridging Untagged-pep Configuration	56
CHAPTER 15	Provider Bridging Configuration (SVLAN)	27
	Customer-Network Port (CNP)	27
	STAG-based Interface	27
	Port-based Interface	27
	Topology	28
	Configuration	28
	Validation	30
CHAPTER 16	Link Layer Discovery Protocol Configuration	27
	Topology	27
	Interface Mode TLV	27
	Global Mode TLV	36
	LLDP-MED	39
<b>Data Center Bridging Configuration Guide</b>		<b>251</b>
CHAPTER 1	Priority-based Flow Control Configuration	251
	Configuring a Bridge and Interface for PFC	251
	Configuring Priorities and Link Delay Allowance for PFC	251
CHAPTER 2	DCBx Configuration	251
	Configuring ETS Parameter Exchange	251
	Configuring PFC Parameter Exchange	253
CHAPTER 3	PFC with QOS Configuration	251
	Topology	251
<b>Layer 2 Command Reference</b>		<b>257</b>
CHAPTER 1	Fundamental Layer 2 Commands	259
	errdisable cause	260
	errdisable link-flap-setting	261
	errdisable timeout	262
	show errdisable details	263

---

show interface errdisable status .....	264
show running-config switch .....	265
show tcp .....	267
watch static-mac-movement .....	269
CHAPTER 2 Bridge Commands .....	271
bridge acquire .....	272
bridge address .....	273
bridge ageing .....	274
bridge forward-time .....	275
bridge hello-time .....	276
bridge mac-priority-override .....	277
bridge max-age .....	278
bridge max-hops .....	279
bridge priority .....	280
bridge shutdown .....	281
bridge transmit-holdcount .....	282
bridge-group .....	283
bridge-group path-cost .....	284
bridge-group priority .....	285
clear allowed-ethertype .....	286
clear mac address-table .....	287
mac ageing display .....	289
show allowed-ethertype .....	290
show bridge .....	291
show interface switchport .....	292
show mac address-table count bridge .....	294
show mac address-table bridge .....	295
switchport .....	297
switchport allowed ethertype .....	298
CHAPTER 3 Spanning Tree Protocol Commands .....	299
bridge cisco-interoperability .....	301
bridge instance .....	302
bridge instance priority .....	303
bridge instance vlan .....	304
bridge multiple-spanning-tree .....	305
bridge protocol ieee .....	306
bridge protocol mstp .....	307
bridge protocol rstp .....	308
bridge provider-rstp .....	309
bridge rapid-spanning-tree .....	310
bridge region .....	311
bridge revision .....	312
bridge spanning-tree .....	313
bridge spanning-tree errdisable-timeout .....	314
bridge spanning-tree force-version .....	315
bridge spanning-tree pathcost .....	316

---

bridge spanning-tree portfast .....	317
bridge te-msti .....	318
bridge te-msti vlan .....	319
bridge-group instance .....	320
bridge-group instance path-cost .....	321
bridge-group instance priority .....	322
bridge-group path-cost .....	323
bridge-group priority .....	324
bridge-group spanning-tree .....	325
clear spanning-tree detected protocols .....	326
clear spanning-tree statistics .....	327
customer-spanning-tree customer-edge path-cost .....	328
customer-spanning-tree customer-edge priority .....	329
customer-spanning-tree forward-time .....	330
customer-spanning-tree hello-time .....	331
customer-spanning-tree max-age .....	332
customer-spanning-tree priority .....	333
customer-spanning-tree provider-edge path-cost .....	334
customer-spanning-tree provider-edge priority .....	335
customer-spanning-tree transmit-holdcount .....	336
debug mstp .....	337
show debugging mstp .....	339
show spanning-tree .....	340
show spanning-tree mst .....	344
show spanning-tree statistics .....	346
snmp restart mstp .....	349
spanning-tree autoedge .....	350
spanning-tree edgeport .....	351
spanning-tree guard .....	352
spanning-tree instance restricted-role .....	353
spanning-tree instance restricted-tcn .....	354
spanning-tree link-type .....	355
spanning-tree mst configuration .....	356
spanning-tree bpdu-filter .....	357
spanning-tree bpdu-guard .....	358
spanning-tree restricted-domain-role .....	359
spanning-tree restricted-role .....	360
spanning-tree restricted-tcn .....	361
spanning-tree te-msti configuration .....	362
storm-control .....	363
show storm-control .....	366
.....	367
<b>CHAPTER 4 RPVST+ Commands .....</b>	<b>369</b>
bridge vlan .....	370
bridge vlan priority .....	371
bridge-group vlan .....	372

bridge protocol rpvst+ . . . . .	373
bridge rapid-pervlan-spanning-tree . . . . .	374
show spanning-tree rpvst+ . . . . .	375
spanning-tree rpvst+ configuration . . . . .	379
spanning-tree vlan restricted-role . . . . .	380
spanning-tree vlan restricted-tcn . . . . .	381
<b>CHAPTER 5 Link Aggregation Commands . . . . .</b>	<b>383</b>
channel-group mode . . . . .	384
clear lacp . . . . .	386
debug lacp . . . . .	387
interface po . . . . .	388
interface sa . . . . .	389
lacp destination-mac . . . . .	390
lacp force-up . . . . .	391
lacp port-priority . . . . .	392
lacp system-priority . . . . .	393
lacp timeout . . . . .	394
port-channel load-balance . . . . .	395
port-channel min-bandwidth - dynamic LAG min-bandwidth . . . . .	396
port-channel min-links - dynamic LAG min-links . . . . .	397
port-channel min-bandwidth - static LAG min-bandwidth . . . . .	398
port-channel min-links - static LAG min-links . . . . .	399
show debugging lacp . . . . .	400
show etherchannel . . . . .	401
show lacp sys-id . . . . .	404
show lacp-counter . . . . .	405
show port etherchannel . . . . .	406
show static-channel-group . . . . .	409
show static-channel load-balance . . . . .	410
snmp restart lacp . . . . .	411
static-channel-group . . . . .	412
<b>CHAPTER 6 Multi-Chassis Link Aggregation Commands . . . . .</b>	<b>415</b>
clear mcec statistics . . . . .	416
debug mcec . . . . .	417
domain-address . . . . .	418
domain hello timeout . . . . .	419
domain priority . . . . .	420
domain-system-number . . . . .	421
intra-domain-link . . . . .	422
intra-domain-peer . . . . .	423
mcec domain configuration . . . . .	424
mlag . . . . .	425
mode . . . . .	426
show mcec statistics . . . . .	427
show mlag detail . . . . .	429
show mlag domain . . . . .	431



---

show spanning-tree mlag operational-config	434
show spanning-tree mlag sync-detail	435
switchover type	436
<b>CHAPTER 7 VLAN and Private VLAN Commands</b>	<b>437</b>
show dtag vlan	438
show vlan access-map	439
show vlan	440
show vlan brief	442
show vlan classifier	443
show vlan-reservation	445
switchport access	447
switchport hybrid	448
switchport mode	450
switchport mode access ingress-filter	451
switchport mode hybrid acceptable-frame-type	452
switchport mode hybrid ingress-filter	453
switchport mode trunk ingress-filter	454
switchport trunk allowed	455
switchport trunk allowed vlan dtag	457
switchport trunk native	458
vlan classifier activate	459
vlan classifier group	460
vlan classifier rule ipv4	461
vlan classifier rule mac	462
vlan classifier rule proto	463
vlan database	465
vlan dtag	466
vlan-reservation	467
vlan state	468
vlan VLAN_RANGE bridge	469
<b>CHAPTER 8 802.1x Commands</b>	<b>471</b>
auth-mac auth-fail-action	472
auth-mac disable	473
auth-mac dynamic-vlan-creation	474
auth-mac enable	475
auth-mac mac-aging	476
auth-mac system-auth-ctrl	477
debug dot1x	478
dot1x initialize	479
dot1x keytxenabled	480
dot1x port-control	481
dot1x protocol-version	482
dot1x quiet-period	483
dot1x reauthMax	484
dot1x reauthentication	485
dot1x system-auth-ctrl	486

---

dot1x timeout re-authperiod	487
dot1x timeout server-timeout	488
dot1x timeout supp-timeout	489
dot1x timeout tx-period	490
ip radius source-interface	491
radius-server dot1x deadtime	492
radius-server dot1x host	493
radius-server dot1x key	495
radius-server dot1x retransmit	496
radius-server dot1x timeout	497
show debugging dot1x	498
show dot1x	499
snmp restart auth	502
<b>CHAPTER 9 Port Security Commands</b>	<b>503</b>
show port-security	504
switchport port-security	505
switchport port-security logging enable	506
switchport port-security mac-address	507
switchport port-security maximum	508
<b>CHAPTER 10 Layer 2 Control Protocols Tunneling Commands</b>	<b>509</b>
clear l2protocol interface counters	510
l2protocol	511
l2protocol encapsulation dest-mac	512
show l2protocol interface counters	513
show l2protocol processing interface	514
<b>CHAPTER 11 Provider Bridging Commands</b>	<b>515</b>
bridge protocol provider-mstp	516
bridge protocol provider-rstp	517
cvlan registration table	518
cvlan svlan	519
dotad	521
show cvlan registration table	522
switchport customer-edge	523
switchport customer-edge hybrid	524
switchport customer-edge trunk	525
switchport customer-edge vlan registration	526
switchport customer-network allowed vlan	527
switchport customer-network vlan	528
switchport mode	529
switchport mode customer-edge	530
switchport mode customer-edge hybrid acceptable-frame-type	531
switchport provider-network	532
switchport provider-network isolated-vlan	533
switchport provider-network vlan translation	534
vlan type	536

vlan type customer . . . . .	537
CHAPTER 12 Link Layer Discovery Protocol v2 Commands . . . . .	539
clear lldp counters . . . . .	540
lldp-agent . . . . .	541
debug lldp . . . . .	542
lldp run . . . . .	543
lldp tlv basic-mgmt . . . . .	544
lldp tlv med . . . . .	545
lldp tlv ieee-8021-org-specific . . . . .	546
lldp tlv ieee-8023-org-specific . . . . .	547
lldp tlv-select basic-mgmt . . . . .	548
lldp tlv-select ieee-8021-org-specific . . . . .	549
lldp tlv-select ieee-8023-org-specific . . . . .	550
set lldp agt-circuit-id . . . . .	551
set lldp chassis-id-tlv . . . . .	552
set lldp chassis locally-assigned . . . . .	553
set lldp disable . . . . .	554
set lldp enable . . . . .	555
set lldp locally-assigned . . . . .	556
set lldp management-address-tlv . . . . .	557
set lldp med-devtype . . . . .	558
set lldp msg-tx-hold . . . . .	559
set lldp port-id-tlv . . . . .	560
set lldp timer . . . . .	561
set lldp too-many-neighbors . . . . .	563
set lldp tx-fast-init . . . . .	564
set lldp tx-max-credit . . . . .	565
show debugging lldp . . . . .	566
show lldp neighbors . . . . .	567
show lldp interface . . . . .	570
snmp restart lldp . . . . .	572
<b>Data Center Bridging Command Reference . . . . .</b>	<b>573</b>
CHAPTER 1 Priority-based Flow Control Commands . . . . .	575
priority-flow-control accept-peer-config . . . . .	576
priority-flow-control advertise-local-config . . . . .	577
priority-flow-control enable . . . . .	578
priority-flow-control cap . . . . .	579
priority-flow-control enable priority . . . . .	580
priority-flow-control link-delay-allowance . . . . .	581
priority-flow-control mode . . . . .	582
show priority-flow-control details . . . . .	583
show priority-flow-control statistics . . . . .	585
<b>Index . . . . .</b>	<b>587</b>



---

# Preface

This guide describes how to configure OcNOS.

---

## IP Maestro Support

Monitor devices running OcNOS Release 6.3.4-70 and above using IP Maestro software.

---

## Audience

This guide is intended for network administrators and other engineering professionals who configure OcNOS.

---

## Conventions

[Table 1](#) shows the conventions used in this guide.

**Table 1: Conventions**

Convention	Description
Italics	Emphasized terms; titles of books
Note:	Special instructions, suggestions, or warnings
<code>monospaced type</code>	Code elements such as commands, parameters, files, and directories

---

## Chapter Organization

The chapters in command references are organized as described in [Command Description Format](#).

The chapters in configuration guides are organized into these major sections:

- An overview that explains a configuration in words
- Topology with a diagram that shows the devices and connections used in the configuration
- Configuration steps in a table for each device where the left-hand side shows the commands you enter and the right-hand side explains the actions that the commands perform
- Validation which shows commands and their output that verify the configuration

---

## Related Documentation

For information about installing of OcNOS, see the *Installation Guide* for your platform.

---

## Migration Guide

Check the *Migration Guide* for configuration changes to make when migrating from one version of OcNOS to another.

---

## Feature Availability

The features described in this document that are available depend upon the OcNOS SKU that you purchased. See the *Feature Matrix* for a description of the OcNOS SKUs.

---

## Support

For support-related questions, contact [support@ipinfusion.com](mailto:support@ipinfusion.com).

---

## Comments

If you have comments, or need to report a problem with the content, contact [techpubs@ipinfusion.com](mailto:techpubs@ipinfusion.com).

# Command Line Interface

This chapter introduces the OcNOS Command Line Interface (CLI) and how to use its features.

---

## Overview

You use the CLI to configure, monitor, and maintain OcNOS devices. The CLI is text-based and each command is usually associated with a specific task.

You can give the commands described in this manual locally from the console of a device running OcNOS or remotely from a terminal emulator such as `putty` or `xterm`. You can also use the commands in scripts to automate configuration tasks.

---

## Command Line Interface Help

You access the CLI help by entering a full or partial command string and a question mark “?”. The CLI displays the command keywords or parameters along with a short description. For example, at the CLI command prompt, type:

```
> show ?
```

The CLI displays this keyword list with short descriptions for each keyword:

```
show ?
  application-priority      Application Priority
  arp                      Internet Protocol (IP)
  bfd                      Bidirectional Forwarding Detection (BFD)
  bgp                      Border Gateway Protocol (BGP)
  bi-lsp                   Bi-directional lsp status and configuration
  bridge                   Bridge group commands
  ce-vlan                  COS Preservation for Customer Edge VLAN
  class-map                Class map entry
  cli                     Show CLI tree of current mode
  clns                    Connectionless-Mode Network Service (CLNS)
  control-adjacency       Control Adjacency status and configuration
  control-channel         Control Channel status and configuration
  cspf                    CSPF Information
  customer                Display Customer spanning-tree
  cvlan                   Display CVLAN information
  debugging               Debugging functions (see also 'undebug')
  etherchannel            LACP etherchannel
  ethernet                Layer-2
  ...
```

If you type the ? in the middle of a keyword, the CLI displays help for that keyword only.

```
> show de?
debugging Debugging functions (see also 'undebug')
```

If you type the ? in the middle of a keyword, but the incomplete keyword matches several other keywords, OcNOS displays help for all matching keywords.

```
> show i? (CLI does not display the question mark).
interface Interface status and configuration
ip IP information
isis ISIS information
```

---

## Command Completion

The CLI can complete the spelling of a command or a parameter. Begin typing the command or parameter and then press the tab key. For example, at the CLI command prompt type `sh`:

```
> sh
```

Press the tab key. The CLI displays:

```
> show
```

If the spelling of a command or parameter is ambiguous, the CLI displays the choices that match the abbreviation. Type `show i` and press the tab key. The CLI displays:

```
> show i
  interface ip          ipv6          isis
> show i
```

The CLI displays the `interface` and `ip` keywords. Type `n` to select `interface` and press the tab key. The CLI displays:

```
> show in
> show interface
```

Type `?` and the CLI displays the list of parameters for the `show interface` command.

```
> show interface
  IFNAME  Interface name
  |       Output modifiers
  >       Output redirection
  <cr>
```

The CLI displays the only parameter associated with this command, the `IFNAME` parameter.

---

## Command Abbreviations

The CLI accepts abbreviations that uniquely identify a keyword in commands. For example:

```
> sh int xe0
```

is an abbreviation for:

```
> show interface xe0
```

---

## Command Line Errors

Any unknown spelling causes the CLI to display the error `Unrecognized command` in response to the `?`. The CLI displays the command again as last entered.

```
> show dd?
% Unrecognized command
> show dd
```

When you press the Enter key after typing an invalid command, the CLI displays:

```
(config)#router ospf here
                               ^
% Invalid input detected at '^' marker.
```

where the `^` points to the first character in error in the command.



If a command is incomplete, the CLI displays the following message:

```
> show
% Incomplete command.
```

Some commands are too long for the display line and can wrap mid-parameter or mid-keyword, as shown below. This does *not* cause an error and the command performs as expected:

```
area 10.10.0.18 virtual-link 10.10.0.19 authent
ication-key 57393
```

---

## Command Negation

Many commands have a `no` form that resets a feature to its default value or disables the feature. For example:

- The `ip address` command assigns an IPv4 address to an interface
- The `no ip address` command removes an IPv4 address from an interface

---

## Syntax Conventions

[Table 1](#) describes the conventions used to represent command syntax in this reference.

**Table 1: Syntax conventions**

Convention	Description	Example
monospaced font	Command strings entered on a command line	<code>show ip ospf</code>
lowercase	Keywords that you enter exactly as shown in the command syntax.	<code>show ip ospf</code>
UPPERCASE	See <a href="#">Variable Placeholders</a>	<code>IFNAME</code>
( )	Optional parameters, from which you must select one. Vertical bars delimit the selections. Do not enter the parentheses or vertical bars as part of the command.	<code>(A.B.C.D &lt;0-4294967295&gt;)</code>
( )	Optional parameters, from which you select one or none. Vertical bars delimit the selections. Do not enter the parentheses or vertical bars as part of the command.	<code>(A.B.C.D &lt;0-4294967295&gt; )</code>
( )	Optional parameter which you can specify or omit. Do not enter the parentheses or vertical bar as part of the command.	<code>(IFNAME )</code>
{ }	Optional parameters, from which you must select one or more. Vertical bars delimit the selections. Do not enter the braces or vertical bars as part of the command.	<code>{intra-area &lt;1-255&gt; inter-area &lt;1-255&gt; external &lt;1-255&gt;}</code>

**Table 1: Syntax conventions (Continued)**

Convention	Description	Example
[ ]	Optional parameters, from which you select zero or more. Vertical bars delimit the selections. Do not enter the brackets or vertical bars as part of the command.	[<1-65535> AA:NN internet local-AS no-advertise no-export]
?	Nonrepeatable parameter. The parameter that follows a question mark can only appear once in a command string. Do not enter the question mark as part of the command.	?route-map WORD
.	Repeatable parameter. The parameter that follows a period can be repeated more than once. Do not enter the period as part of the command.	set as-path prepend .<1-65535>

---

## Variable Placeholders

Table 2 shows the tokens used in command syntax use to represent variables for which you supply a value.

**Table 2: Variable placeholders**

Token	Description
WORD	A contiguous text string (excluding spaces)
LINE	A text string, including spaces; no other parameters can follow this parameter
IFNAME	Interface name whose format varies depending on the platform; examples are: eth0, Ethernet0, ethernet0, xe0
A.B.C.D	IPv4 address
A.B.C.D/M	IPv4 address and mask/prefix
X:X::X:X	IPv6 address
X:X::X:X/M	IPv6 address and mask/prefix
HH:MM:SS	Time format
AA:NN	BGP community value
XX:XX:XX:XX:XX:XX	MAC address
<1-5> <1-65535> <0-2147483647> <0-4294967295>	Numeric range

---

## Command Description Format

[Table 3](#) explains the sections used to describe each command in this reference.

**Table 3: Command descriptions**

Section	Description
<b>Command Name</b>	The name of the command, followed by what the command does and when should it be used
<b>Command Syntax</b>	The syntax of the command
<b>Parameters</b>	Parameters and options for the command
<b>Default</b>	The state before the command is executed
<b>Command Mode</b>	The mode in which the command runs; see <a href="#">Command Modes</a>
<b>Example</b>	An example of the command being executed

---

## Keyboard Operations

[Table 4](#) lists the operations you can perform from the keyboard.

**Table 4: Keyboard operations**

Key combination	Operation
Left arrow or Ctrl+b	Moves one character to the left. When a command extends beyond a single line, you can press left arrow or Ctrl+b repeatedly to scroll toward the beginning of the line, or you can press Ctrl+a to go directly to the beginning of the line.
Right arrow or Ctrl-f	Moves one character to the right. When a command extends beyond a single line, you can press right arrow or Ctrl+f repeatedly to scroll toward the end of the line, or you can press Ctrl+e to go directly to the end of the line.
Esc, b	Moves back one word
Esc, f	Moves forward one word
Ctrl+e	Moves to end of the line
Ctrl+a	Moves to the beginning of the line
Ctrl+u	Deletes the line
Ctrl+w	Deletes from the cursor to the previous whitespace
Alt+d	Deletes the current word
Ctrl+k	Deletes from the cursor to the end of line
Ctrl+y	Pastes text previously deleted with Ctrl+k, Alt+d, Ctrl+w, or Ctrl+u at the cursor

**Table 4: Keyboard operations (Continued)**

Key combination	Operation
Ctrl+t	Transposes the current character with the previous character
Ctrl+c	Ignores the current line and redisplay the command prompt
Ctrl+z	Ends configuration mode and returns to exec mode
Ctrl+l	Clears the screen
Up Arrow or Ctrl+p	Scroll backward through command history
Down Arrow or Ctrl+n	Scroll forward through command history

---

## Show Command Modifiers

You can use two tokens to modify the output of a `show` command. Enter a question mark to display these tokens:

```
# show users ?
  | Output modifiers
  > Output redirection
```

You can type the | (vertical bar character) to use output modifiers. For example:

```
> show rsvp | ?
begin      Begin with the line that matches
exclude    Exclude lines that match
include    Include lines that match
last       Last few lines
redirect   Redirect output
```

---

## Begin Modifier

The `begin` modifier displays the output beginning with the first line that contains the input string (everything typed after the `begin` keyword). For example:

```
# show running-config | begin xe1
...skipping
interface xe1
  ipv6 address fe80::204:75ff:fee6:5393/64
!
interface xe2
  ipv6 address fe80::20d:56ff:fe96:725a/64
!
line con 0
  login
!
end
```

You can specify a regular expression after the `begin` keyword. This example begins the output at a line with either “xe2” or “xe4”:

```
# show running-config | begin xe[3-4]
...skipping
```

```

interface xe3
 shutdown
!
interface xe4
 shutdown
!
interface svlan0.1
 no shutdown
!
route-map myroute permit 3
!
route-map mymap1 permit 10
!
route-map rmap1 permit 3
!
line con 0
 login
line vty 0 4
 login
!
end

```

---

## Include Modifier

The `include` modifier includes only those lines of output that contain the input string. In the output below, all lines containing the word “input” are included:

```

# show interface xe1 | include input
input packets 80434552, bytes 2147483647, dropped 0, multicast packets 0
input errors 0, length 0, overrun 0, CRC 0, frame 0, fifo 1, missed 0

```

You can specify a regular expression after the `include` keyword. This examples includes all lines with “input” or “output”:

```

#show interface xe0 | include (in|out)put
input packets 597058, bytes 338081476, dropped 0, multicast packets 0
input errors 0, length 0, overrun 0, CRC 0, frame 0, fifo 0, missed 0
output packets 613147, bytes 126055987, dropped 0
output errors 0, aborted 0, carrier 0, fifo 0, heartbeat 0, window 0

```

---

## Exclude Modifier

The `exclude` modifier excludes all lines of output that contain the input string. In the following output example, all lines containing the word “input” are excluded:

```

# show interface xe1 | exclude input
Interface xe1
Scope: both
Hardware is Ethernet, address is 0004.75e6.5393
index 3 metric 1 mtu 1500 <UP,BROADCAST,RUNNING,MULTICAST>
VRF Binding: Not bound
Administrative Group(s): None
DSTE Bandwidth Constraint Mode is MAM
inet6 fe80::204:75ff:fee6:5393/64
output packets 4438, bytes 394940, dropped 0
output errors 0, aborted 0, carrier 0, fifo 0, heartbeat 0, window 0
collisions 0

```

You can specify a regular expression after the `exclude` keyword. This example excludes lines with “output” or “input”:

```
# show interface xe0 | exclude (in|out)put
Interface xe0
  Scope: both
  Hardware is Ethernet Current HW addr: 001b.2139.6c4a
  Physical:001b.2139.6c4a Logical:(not set)
  index 2 metric 1 mtu 1500 duplex-full arp ageing timeout 3000
  <UP,BROADCAST,RUNNING,MULTICAST>
  VRF Binding: Not bound
  Bandwidth 100m
  DHCP client is disabled.
  inet 10.1.2.173/24 broadcast 10.1.2.255
  VRRP Master of : VRRP is not configured on this interface.
  inet6 fe80::21b:21ff:fe39:6c4a/64
  collisions 0
```

---

## Redirect Modifier

The `redirect` modifier writes the output into a file. The output is not displayed.

```
# show cli history | redirect /var/frame.txt
```

The output redirection token (`>`) does the same thing:

```
# show cli history >/var/frame.txt
```

---

## Last Modifier

The `last` modifier displays the output of last few number of lines (As per the user input). The last number ranges from 1 to 9999.

For example:

```
#show running-config | last 10
```

---

## String Parameters

The restrictions in [Table 5](#) apply for all string parameters used in OcnOS commands, unless some other restrictions are noted for a particular command.

**Table 5: String parameter restrictions**

Restriction	Description
Input length	1965 characters or less
Restricted special characters	“?”, “,”, “>”, “ ”, and “=” The “ ” is allowed only for <code>description</code> CLI in interface mode.

---

## Command Modes

Commands are grouped into modes arranged in a hierarchy. Each mode has its own set of commands. [Table 6](#) lists the command modes common to all protocols.

**Table 6: Common command modes**

Name	Description
Executive mode	Also called <i>view</i> mode, this is the first mode to appear after you start the CLI. It is a base mode from where you can perform basic commands such as <code>show</code> , <code>exit</code> , <code>quit</code> , <code>help</code> , and <code>enable</code> .
Privileged executive mode	Also called <i>enable</i> mode, in this mode you can run additional basic commands such as <code>debug</code> , <code>write</code> , and <code>show</code> .
Configure mode	Also called <i>configure terminal</i> mode, in this mode you can run configuration commands and go into other modes such as <code>interface</code> , <code>router</code> , <code>route map</code> , <code>key chain</code> , and <code>address family</code> .  Configure mode is single user. Only one user at a time can be in configure mode.
Interface mode	In this mode you can configure protocol-specific settings for a particular interface. Any setting you configure in this mode overrides a setting configured in <code>router</code> mode.
Router mode	This mode is used to configure router-specific settings for a protocol such as BGP or OSPF.

## Command Mode Tree

The diagram below shows the common command mode hierarchy.

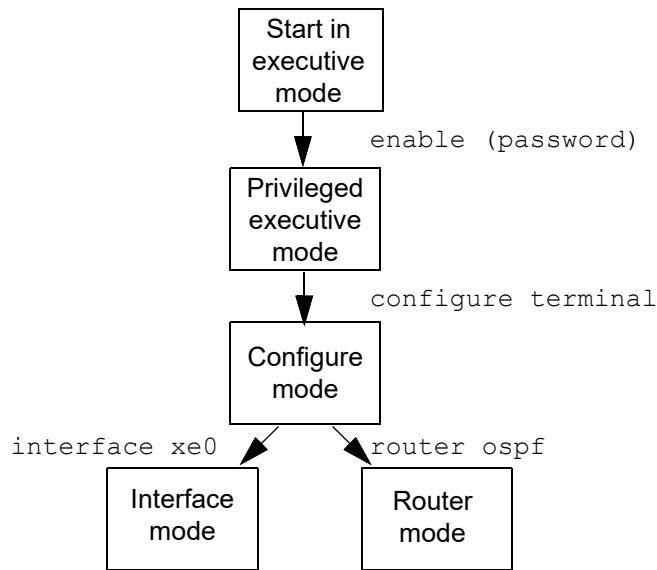

**Figure 4-1: Common command modes**

To change modes:

1. Enter privileged executive mode by entering `enable` in Executive mode.
2. Enter configure mode by entering `configure terminal` in Privileged Executive mode.

The example below shows moving from executive mode to privileged executive mode to configure mode and finally to router mode:

```

> enable mypassword
# configure terminal
Enter configuration commands, one per line. End with CNTL/Z.
(config)# router ospf
(config-router)#
  
```

Note: Each protocol can have modes in addition to the common command modes. See the command reference for the respective protocol for details.



---

## Transaction-based Command-line Interface

The OcNOS command line interface is transaction based:

- Any changes done in configure mode are stored in a separate *candidate* configuration that you can view with the `show transaction current` command.
- When a configuration is complete, apply the candidate configuration to the running configuration with the `commit` command.
- If a `commit` fails, no configuration is applied as the entire transaction is considered failed. You can continue to change the candidate configuration and then retry the `commit`.
- Discard the candidate configuration with the `abort transaction` command.
- Check the last aborted transaction with the `show transaction last-aborted` command.
- Multiple configurations cannot be removed with a single `commit`. You must remove each configuration followed by a `commit`.

Note: All commands MUST be executed only in the default CML shell (`cmlsh`). If you log in as `root` and start `imish`, then the system configurations will go out of sync. The `imish` shell is not supported and should not be started manually.



# Layer 2 Configuration Guide



## CHAPTER 1 VLAN Configuration

This chapter contains a complete VLAN configuration.

### Configuring VLAN Tags

#### Topology

This shows configuring a VLAN bridge with VLAN tags on forwarding frames. Link between Bridge 1 and Bridge 2 is configured as VLAN 5 and link between Bridge 3 and Bridge 1 is configured as VLAN 10. Link between Bridge 2 and Bridge 3 is configured with VLAN 5 and VLAN 10.

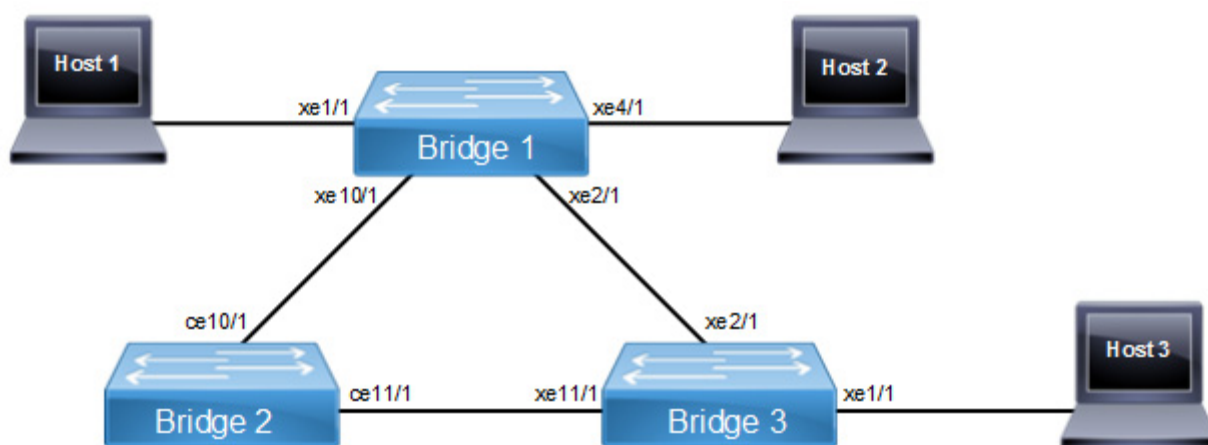

Figure 6-1: VLAN Topology

Note: Run the `switchport` command on each port to change to Layer-2 mode.

#### Bridge 1

<code>Bridgel#configure terminal</code>	Enter configuration mode
<code>Bridgel(config)#bridge 1 protocol ieee vlan-bridge</code>	Specify VLAN for bridge 1.
<code>Bridgel(config)#vlan database</code>	Enter the VLAN configuration mode.
<code>Bridgel(config-vlan)#vlan 5 bridge 1 state enable</code>	Enable VLAN (5) on bridge 1. Specifying the enable state allows forwarding of frames on this VLAN-aware bridge.
<code>Bridgel(config-vlan)#vlan 10 bridge 1 state enable</code>	Enable VLAN (10) on bridge 1. Specifying the enable state allows forwarding of frames on this VLAN-aware bridge.
<code>Bridgel(config-vlan)#exit</code>	Exit the VLAN configuration mode.
<code>Bridgel(config)#interface xe1/1</code>	Enter interface mode.
<code>Bridgel(config-if)#switchport</code>	Configure port as L2.
<code>Bridgel(config-if)#bridge-group 1</code>	Associate the interface with bridge group 1.
<code>Bridgel(config-if)#switchport mode access</code>	Set the switching characteristics of this interface to access mode.
<code>Bridgel(config-if)#switchport access vlan 5</code>	Enable VLAN ID 5 on this port.

## VLAN Configuration

<code>Bridge1(config-if)#exit</code>	Exit the interface mode and go config mode.
<code>Bridge1(config)#interface xe2/1</code>	Enter interface mode.
<code>Bridge1(config-if)#switchport</code>	Configure port as L2.
<code>Bridge1(config-if)#bridge-group 1</code>	Associate the interface with bridge group 1.
<code>Bridge1(config-if)#switchport mode trunk</code>	Set the switching characteristics of this interface to trunk mode.
<code>Bridge1(config-if)#switchport trunk allowed vlan add 10</code>	Enable VLAN ID 10 on this port.
<code>Bridge1(config-if)#exit</code>	Exit from the interface mode and go config mode.
<code>Bridge1(config)#interface xe4/1</code>	Enter interface mode.
<code>Bridge1(config-if)#switchport</code>	Configure port as L2.
<code>Bridge1(config-if)#bridge-group 1</code>	Associate the interface with bridge group 1.
<code>Bridge1(config-if)#switchport mode access</code>	Set the switching characteristics of this interface to access mode.
<code>Bridge1(config-if)#switchport access vlan 10</code>	Enable VLAN ID 10 on this port.
<code>Bridge1(config-if)#exit</code>	Exit from the interface mode and go config mode.
<code>Bridge1(config)#interface xe10/1</code>	Enter interface mode.
<code>Bridge1(config-if)#switchport</code>	Configure port as L2.
<code>Bridge1(config-if)#bridge-group 1</code>	Associate the interface with bridge group 1.
<code>Bridge1(config-if)#switchport mode trunk</code>	Set the switching characteristics of this interface to trunk mode.
<code>Bridge1(config-if)#switchport trunk allowed vlan add 5</code>	Enable VLAN ID 5 on this port.
<code>Bridge1(config-if)#exit</code>	Exit from the interface mode and go config mode.

## Bridge 2

<code>Bridge2#configure terminal</code>	Enter configure mode.
<code>Bridge2(config)#bridge 2 protocol ieee vlan-bridge</code>	Specify VLAN for bridge 2.
<code>Bridge2(config)#vlan database</code>	Enter the VLAN configuration mode.
<code>Bridge2(config-vlan)#vlan 5 bridge 2 state enable</code>	Enable VLAN (5) on bridge 2. Specifying the enable state allows forwarding of frames on this VLAN-aware bridge.
<code>Bridge2(config-vlan)#vlan 10 bridge 2 state enable</code>	Specifying the enable state allows forwarding of frames on this VLAN-aware bridge.
<code>Bridge2(config-vlan)#exit</code>	Exit the VLAN configuration mode.
<code>Bridge2(config)#interface ce10/1</code>	Enter interface mode.
<code>Bridge2(config-if)#switchport</code>	
<code>Bridge2(config-if)#bridge-group 2</code>	Associate the interface with bridge group 2.
<code>Bridge2(config-if)#switchport mode trunk</code>	Set the switching characteristics of this interface to trunk mode.
<code>Bridge2(config-if)#switchport access vlan 5</code>	Enable VLAN port access by specifying the VLAN ID 5 on this interface.
<code>Bridge2(config-if)#switchport trunk allowed vlan add 10</code>	Enable VLAN ID 10 on this port.

Bridge2(config-if)#switchport	Configure port as L2.
Bridge2(config-if)#bridge-group 2	Associate the interface with bridge group 2.
Bridge2(config-if)#switchport mode trunk	Set the switching characteristics of this interface to trunk mode.
Bridge2(config-if)#switchport trunk allowed vlan add 5	Enable VLAN ID 5 on this port.
Bridge2(config-if)#switchport trunk allowed vlan add 10	Enable VLAN ID 10 on this port.
Bridge2(config-if)#exit	Exit from the interface mode and go config mode.
Bridge2(config)#interface cell1/1	Enter interface mode.
Bridge2(config-if)#switchport	Configure port as L2.
Bridge2(config-if)#bridge-group 2	Associate the interface with bridge group 2.
Bridge2(config-if)#switchport mode trunk	Set the switching characteristics of this interface to trunk mode.
Bridge2(config-if)#switchport trunk allowed vlan add 5	Enable VLAN ID 5 on this port.
Bridge2(config-if)#switchport trunk allowed vlan add 10	Enable VLAN ID 10 on this port.
Bridge1(config-if)#exit	Exit from the interface mode and go config mode.

### Bridge 3

Bridge3#configure terminal	Enter configure mode.
Bridge3(config)#bridge 3 protocol ieee vlan-bridge	Specify VLAN for bridge 3.
Bridge3(config)#vlan database	Enter the VLAN configuration mode.
Bridge3(config-vlan)#vlan 5 bridge 3 state enable	Enable VLAN (5) on bridge 3. Specifying the enable state allows forwarding of frames on this VLAN-aware bridge.
Bridge3(config-vlan)#vlan 10 bridge 3 state enable	Enable VLAN (10) on bridge 3. Specifying the enable state allows forwarding of frames on this VLAN-aware bridge.
Bridge3(config-vlan)#exit	Exit the VLAN configuration mode.
Bridge3(config)#interface xe1/1	Enter interface mode.
Bridge3(config-if)#switchport	Configure port as L2.
Bridge3(config-if)#bridge-group 3	Associate the interface with bridge group 3.
Bridge3(config-if)#switchport mode access	Set the switching characteristics of this interface to access mode.
Bridge3(config-if)#switchport access vlan 5	Enable VLAN ID 5 on this port.
Bridge3(config-if)#switchport access vlan 10	Enable VLAN ID 10 on this port.
Bridge3(config-if)#exit	Exit from the interface mode and go config mode.
Bridge3(config)#interface xe2/1	Enter interface mode.
Bridge3(config-if)#switchport	Configure port as L2.
Bridge3(config-if)#bridge-group 3	Associate the interface with bridge group 3.
Bridge3(config-if)#switchport mode trunk	Set the switching characteristics of this interface to trunk mode.

## VLAN Configuration

---

Bridge3(config-if)#switchport trunk allowed vlan add 10	Enable VLAN ID 10 on this port.
Bridge3(config-if)#exit	Exit from the interface mode and go config mode.
Bridge3(config)#interface xe11/1	Enter interface mode.
Bridge3(config-if)#switchport	Configure port as L2.
Bridge3(config-if)#bridge-group 3	Associate the interface with bridge group 3.
Bridge3(config-if)#switchport mode trunk	Set the switching characteristics of this interface to trunk mode.
Bridge3(config-if)#switchport trunk allowed vlan add 5	Enable VLAN ID 5 on this port.
Bridge3(config-if)#exit	Exit from the interface mode and go config mode.

---

## Validation

### Bridge 1

```
Bridge1#show spanning-tree
% 1: Bridge up - Spanning Tree Enabled
% 1: Root Path Cost 1 - Priority 32768
% 1: Forward Delay 15 - Hello Time 2 - Max Age 20 - Transmit Hold Count 6 - Root port 909
% 1: Root Id 8000001823304db6
% 1: Bridge Id 8000001823305244
% 1: 6 topology changes - last topology change Fri Apr 19 12:32:26 2019
% 1: portfast bpdu-filter disabled
% 1: portfast bpdu-guard disabled
% 1: portfast errdisable timeout disabled
% 1: portfast errdisable timeout interval 300 sec
% xe1/1: Port Number 905 - Ifindex 5001 - Port Id 0x8389 - path cost 4 - designated cost 1
% xe1/1: Designated Port Id 0x8389 - state Forwarding -Priority 128
% xe1/1: Designated root 8000001823304db6
% xe1/1: Designated Bridge 8000001823305244
% xe1/1: Message Age 1 - Max Age 20
% xe1/1: Hello Time 2 - Forward Delay 15
% xe1/1: Forward Timer 0 - Msg Age Timer 0 - Hello Timer 0 - topo change timer 0
% xe1/1: forward-transitions 1
% xe1/1: No portfast configured - Current portfast off
% xe1/1: bpdu-guard default - Current bpdu-guard off
% xe1/1: bpdu-filter default - Current bpdu-filter off
% xe1/1: no root guard configured - Current root guard off
%
% xe2/1: Port Number 909 - Ifindex 5005 - Port Id 0x838d - path cost 1 - designated cost 0
% xe2/1: Designated Port Id 0x838d - state Forwarding -Priority 128
% xe2/1: Designated root 8000001823304db6
% xe2/1: Designated Bridge 8000001823304db6
% xe2/1: Message Age 0 - Max Age 20
% xe2/1: Hello Time 2 - Forward Delay 15
% xe2/1: Forward Timer 0 - Msg Age Timer 19 - Hello Timer 0 - topo change timer 0
% xe2/1: forward-transitions 2
```



```

% xe2/1: No portfast configured - Current portfast off
% xe2/1: bpdu-guard default - Current bpdu-guard off
% xe2/1: bpdu-filter default - Current bpdu-filter off
% xe2/1: no root guard configured - Current root guard off
%
% xe4/1: Port Number 917 - Ifindex 5013 - Port Id 0x8395 - path cost 4 - designated
cost 1
% xe4/1: Designated Port Id 0x8395 - state Forwarding -Priority 128
% xe4/1: Designated root 8000001823304db6
% xe4/1: Designated Bridge 8000001823305244
% xe4/1: Message Age 1 - Max Age 20
% xe4/1: Hello Time 2 - Forward Delay 15
% xe4/1: Forward Timer 0 - Msg Age Timer 0 - Hello Timer 1 - topo change timer 0
% xe4/1: forward-transitions 1
% xe4/1: No portfast configured - Current portfast off
% xe4/1: bpdu-guard default - Current bpdu-guard off
% xe4/1: bpdu-filter default - Current bpdu-filter off
% xe4/1: no root guard configured - Current root guard off
%
% xe10/1: Port Number 941 - Ifindex 5037 - Port Id 0x83ad - path cost 2 - designated
cost 1
% xe10/1: Designated Port Id 0x83ad - state Forwarding -Priority 128
% xe10/1: Designated root 8000001823304db6
% xe10/1: Designated Bridge 8000001823305244
% xe10/1: Message Age 1 - Max Age 20
% xe10/1: Hello Time 2 - Forward Delay 15
% xe10/1: Forward Timer 0 - Msg Age Timer 0 - Hello Timer 0 - topo change timer 0
% xe10/1: forward-transitions 2
% xe10/1: No portfast configured - Current portfast off
% xe10/1: bpdu-guard default - Current bpdu-guard off
% xe10/1: bpdu-filter default - Current bpdu-filter off
% xe10/1: no root guard configured - Current root guard off
%

```

B1#show bridge

Ageout time is global and if something is configured for vxlan then it will be affected here also

Bridge	CVLAN	SVLAN	BVLAN	Port	MAC Address	FWD	Time-out
1	1			xe2/1	0018.23cb.fbcb	1	300
1	1			xe10/1	cc37.ab97.37d8	1	300
1	5			xe1/1	0000.11bc.5dec	1	300
1	10			xe4/1	0000.2d50.205c	1	300

Bridgel#

Bridgel#show vlan all bridge 1

Bridge	VLAN ID	Name	State	H/W Status	Member ports
					(u)-Untagged, (t)-Tagged
1	1	default	ACTIVE	Success	xe1/1(u) xe2/1(u) xe4/1(u) xe10/1(u)

## VLAN Configuration

```
1      5      VLAN0005      ACTIVE  Success  xe1/1(t) xe10/1(t)
1      10     VLAN0010      ACTIVE  Success  xe2/1(t) xe4/1(t)
```

Bridge1#show bridge

Ageout time is global and if something is configured for vxlan then it will be affected here also

Bridge	CVLAN	SVLAN	BVLAN	Port	MAC Address	FWD	Time-out
1	1			xe2/1	0018.23cb.fbcb	1	300
1	1			xe10/1	cc37.ab97.37d8	1	300
1	5			xe1/1	0000.11bc.5dec	1	300
1	10			xe4/1	0000.2d50.205c	1	300

Bridge1#

### Bridge 2

Bridge2#show bridge

Ageout time is global and if something is configured for vxlan then it will be affected here also

Bridge	CVLAN	SVLAN	BVLAN	Port	MAC Address	FWD	Time-out
2	1			ce10/1	0018.2326.166a	1	300
2	1			ce11/1	0018.23cb.fbe0	1	300
2	1			ce11/1	cc37.ab97.37d8	1	300
2	5			ce10/1	0000.11bc.5dec	1	300

Bridge2#show vlan all bridge 2

Bridge	VLAN ID	Name	State	H/W Status	Member ports
					(u)-Untagged, (t)-Tagged
2	1	default	ACTIVE	Success	ce10/1(u) ce11/1(u)
2	5	VLAN0005	ACTIVE	Success	ce10/1(t) ce11/1(t)
2	10	VLAN0010	ACTIVE	Success	ce10/1(t) ce11/1(t)

Bridge2#show bridge

Ageout time is global and if something is configured for vxlan then it will be affected here also

Bridge	CVLAN	SVLAN	BVLAN	Port	MAC Address	FWD	Time-out
2	1			ce10/1	0018.2326.166a	1	300
2	1			ce11/1	0018.23cb.fbe0	1	300
2	1			ce11/1	cc37.ab97.37d8	1	300
2	5			ce10/1	0000.11bc.5dec	1	300

### Bridge 3

Bridge3#show bridge

Ageout time is global and if something is configured for vxlan then it will be affected here also

Bridge	CVLAN	SVLAN	BVLAN	Port	MAC Address	FWD	Time-out
--------	-------	-------	-------	------	-------------	-----	----------

```

-----+-----+-----+-----+-----+-----+-----+
3      1      xe2/1      cc37.ab97.37d8      1      300
3      5      xe11/1     0000.11bc.5dec      1      300
3     10     xe2/1      0000.2d50.205c      1      300

```

Bridge3#show vlan all bridge 3

```

Bridge  VLAN ID      Name          State  H/W Status      Member ports
                               (u)-Untagged, (t)-Tagged
=====  =====  =====
3      1      default      ACTIVE  Success      xe1/1(u) xe2/1(u) xe11/1(u)
3      5      VLAN0005     ACTIVE  Success      xe1/1(t) xe11/1(t)
3     10     VLAN0010     ACTIVE  Success      xe1/1(t) xe2/1(t)

```

Bridge3#show bridge

Ageout time is global and if something is configured for vxlan then it will be affected here also

```

Bridge  CVLAN  SVLAN  BVLAN  Port          MAC Address      FWD  Time-out
-----+-----+-----+-----+-----+-----+-----+
3      1      xe2/1      cc37.ab97.37d8      1      300
3      5      xe11/1     0000.11bc.5dec      1      300
3     10     xe2/1      0000.2d50.205c      1      300

```

Bridge3#



## CHAPTER 2 Disabling Native VLAN Configuration on Trunk mode

This chapter contains sample configurations to check the functionality to drop the untagged traffic by disabling the native VLAN by configuring acceptable-frame-type VLAN-tagged.

### Topology

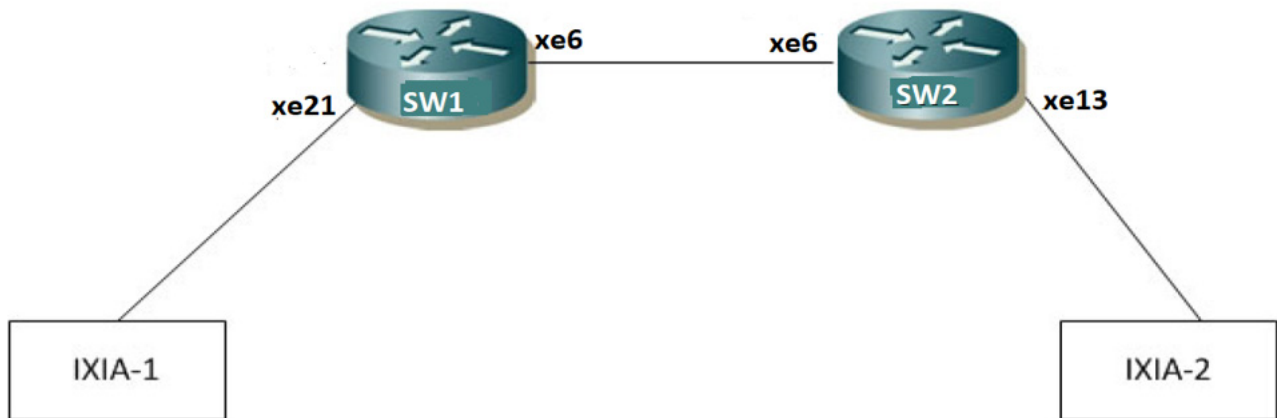

Figure 2-2: Native VLAN Topology

### Configuration

#### SW1

SW1#configure terminal	Enter configuration mode
SW1(config)#bridge 1 protocol mstp	Create bridge
SW1(config)#vlan database	Enter VLAN configuration mode
SW1(config-vlan)#vlan 2-10 bridge 1 state enable	Create 2-10 vlans
SW1(config-vlan)#exit	Exit VLAN configuration mode
SW1(config)#interface xe21	Enter interface configuration mode for xe21
SW1(config-if)#switchport	Configure switchport
SW1(config-if)#bridge-group 1	Associate interface with bridge-group 1
SW1(config-if)#switchport mode trunk	Configure port mode as trunk
SW1(config-if)#switchport trunk allowed vlan all	Allow all the VLANs on the xe21 port
SW1(config-if)#exit	Exit from interface mode
SW1(config)#interface xe6	Enter interface configuration mode for xe6
SW1(config-if)#switchport	Configure switchport
SW1(config-if)#bridge-group 1	Associate interface with bridge-group 1

## Disabling Native VLAN Configuration on Trunk mode

SW1(config-if)#switchport mode trunk	Configure port mode as trunk
SW1(config-if)#switchport trunk allowed vlan all	Allow all the VLANs on the xe6 port
SW1(config-if)#exit	Exit from interface mode
SW1(config)#commit	Commit the candidate configuration to the running configuration

## SW2

SW2#configure terminal	Enter configuration mode
SW2(config)#bridge 1 protocol rstp vlan-bridge	Create bridge
SW2(config)#vlan database	Enter VLAN configuration mode
SW2(config-vlan)#vlan 2-10 bridge 1 state enable	Create 2-10 vlans
SW2(config-vlan)#exit	Exit VLAN configuration mode
SW2(config)#interface xe6	Enter interface configuration mode for xe6
SW2(config-if)#switchport	Configure switchport
SW2(config-if)#bridge-group 1	Associate interface with bridge-group 1
SW2(config-if)#switchport mode trunk	Configure port mode as trunk
SW2(config-if)#switchport trunk allowed vlan all	Allow all the VLANs on the xe6 port
SW2(config-if)#exit	Exit from interface mode
SW2(config)#interface xe13	Enter interface configuration mode for xe13
SW2(config-if)#switchport	Configure switchport
SW2(config-if)#bridge-group 1	Associate interface with bridge-group 1
SW2(config-if)#switchport mode trunk	Configure port mode as trunk
SW2(config-if)#switchport trunk allowed vlan all	Allow all the VLANs on the xe13 port
SW2(config-if)#exit	Exit from interface mode
SW2(config)#commit	Commit the candidate configuration to the running configuration

## Validation

Sending untagged, VLAN-5 and VLAN-6 traffic from IXIA-1 to IXIA-2. In the show bridge o/p we can see all the MAC entries learnt for all the traffics.

In the show vlan brief output for default VLAN interface xe21 is having port type as untagged (u).

```
SW1#show bridge
bridge 1 is running on mstp
Ageout time is global and if something is configured for vxlan then it will be affected here also
```

Bridge	CVLAN	SVLAN	BVLAN	Port	MAC Address	FWD	Time-out
1	1			ce2/2	0010.9400.0001	1	300

```
SW1#show interface counters rate mbps
```

Interface	Rx mbps	Rx pps	Tx mbps	Tx pps
xe21	621.21	606650	0.00	0
xe6	0.00	0	621.21	606651

```
SW1#show vlan brief
```

Bridge	VLAN ID	Name	State	H/W Status	Member ports (u)-Untagged, (t)-Tagged
1	1	default	ACTIVE	Success	xe21 (u) xe6 (u)
1	2	VLAN0002	ACTIVE	Success	xe21 (t) xe6 (t)
1	3	VLAN0003	ACTIVE	Success	xe21 (t) xe6 (t)
1	4	VLAN0004	ACTIVE	Success	xe21 (t) xe6 (t)
1	5	VLAN0005	ACTIVE	Success	xe21 (t) xe6 (t)
1	6	VLAN0006	ACTIVE	Success	xe21 (t) xe6 (t)
1	7	VLAN0007	ACTIVE	Success	xe21 (t) xe6 (t)
1	8	VLAN0008	ACTIVE	Success	xe21 (t) xe6 (t)
1	9	VLAN0009	ACTIVE	Success	xe21 (t) xe6 (t)
1	10	VLAN0010	ACTIVE	Success	xe21 (t) xe6 (t)

## Configuring Disable-Native-VLAN on Trunk mode

### SW1

SW1(config)#interface xe21	Enter interface configuration mode for xe21
SW1(config-if)#switchport mode trunk disable-native-vlan	Configure disable native VLAN on trunk mode
SW1(config-if)#exit	Exit from interface mode
SW1(config)#commit	Commit the candidate configuration to the running configuration

### Validation

After configuring disable-native-vlan, show vlan brief output we can see that xe21 interface is having port type as tagged (t).

```
SW1#show bridge
```

```
bridge 1 is running on mstp
```

Ageout time is global and if something is configured for vxlan then it will be affected here also

Bridge	CVLAN	SVLAN	BVLAN	Port	MAC Address	FWD	Time-out
-----+-----+-----+-----+-----+-----+-----+-----							

```
SW1#sh vlan brief
```

```
bridge 1 is running on rstp vlan-bridge
```

Ageout time is global and if something is configured for vxlan then it will be a

## Disabling Native VLAN Configuration on Trunk mode

---

affected here also

Bridge	CVLAN	SVLAN	BVLAN	Port	MAC Address	FWD	Time-out
1	1			xe21	0000.0000.0001	1	300
1	5			xe21	0000.0000.0005	1	300

SW1#show interface counters rate mbps

Interface	Rx mbps	Rx pps	Tx mbps	Tx pps
xe21	864.88	844613	0.00	0
xe6	0.00	0	0.00	0

SW1#show interface counters drop-stats

Interface ce2/2

Rx Policy Discards: 454522965

Rx EGR Port Unavail: 454522967



## CHAPTER 3 Spanning Tree Protocol Configuration

This chapter contains a complete sample STP configuration. STP prevents duplication of packets by eliminating loops in the network.

### Topology

The following example is a simple multi-bridge topology.

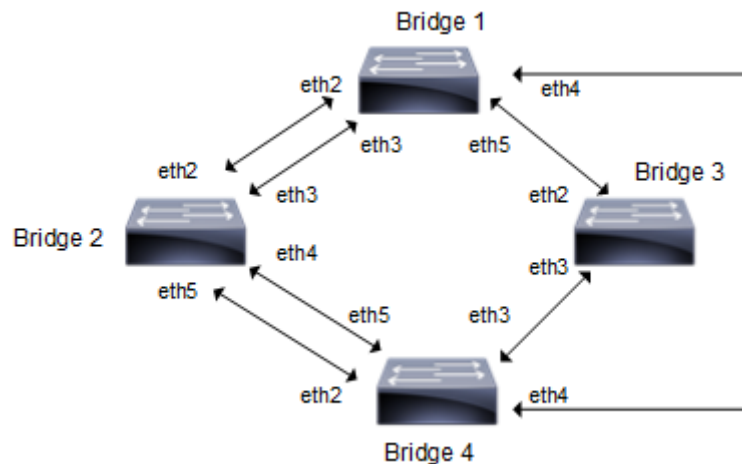

Figure 3-3: STP Topology

Note: Run the `switchport` command on each port to change to Layer-2 mode.

## Configurations

### Bridge 1

<code>Bridge1#configure terminal</code>	Enter configure mode.
<code>Bridge1(config)#bridge 1 protocol ieee</code>	Add a bridge (1) to the spanning tree table
<code>Bridge1(config)#interface eth2</code>	Enter interface mode.
<code>Bridge1(config-if)#bridge-group 1</code>	Associate the interface with bridge group 1.
<code>Bridge1(config-if)#exit</code>	Exit interface mode.
<code>Bridge1(config)#interface eth3</code>	Enter interface mode.
<code>Bridge1(config-if)#bridge-group 1</code>	Associate the interface with bridge group 1.
<code>Bridge1(config-if)#exit</code>	Exit interface mode.
<code>Bridge1(config)#interface eth4</code>	Enter interface mode.
<code>Bridge1(config-if)#bridge-group 1</code>	Associate the interface with bridge group 1.
<code>Bridge1(config-if)#exit</code>	Exit interface mode.
<code>Bridge1(config)#interface eth5</code>	Enter interface mode
<code>Bridge1(config-if)#bridge-group 1</code>	Associate the interface with bridge group 1.

### Bridge 2

Bridge2#configure terminal	Enter configure mode.
Bridge2(config)#bridge 2 protocol ieee	Add a bridge (2) to the spanning tree table
Bridge2(config)#interface eth2	Enter interface mode.
Bridge2(config-if)#bridge-group 2	Associate the interface with bridge group 2.
Bridge2(config-if)#exit	Exit interface mode.
Bridge2(config)#interface eth3	Enter interface mode.
Bridge2(config-if)#bridge-group 2	Associate the interface with bridge group 2.
Bridge2(config-if)#exit	Exit interface mode.
Bridge2(config)#interface eth4	Enter interface mode.
Bridge2(config-if)#bridge-group 2	Associate the interface with bridge group 2.
Bridge2(config-if)#exit	Exit interface mode.
Bridge2(config)#interface eth5	Enter interface mode
Bridge2(config-if)#bridge-group 2	Associate the interface with bridge group 2.

### Bridge 4

Bridge4#configure terminal	Enter configure mode.
Bridge4(config)#bridge 4 protocol ieee	Add a bridge (4) to the spanning tree table
Bridge4(config)#interface eth2	Enter interface mode.
Bridge4(config-if)#bridge-group 4	Associate the interface with bridge group 4.
Bridge4(config-if)#exit	Exit interface mode.
Bridge4(config)#interface eth3	Enter interface mode.
Bridge4(config-if)#bridge-group 4	Associate the interface with bridge group 4.
Bridge4(config-if)#exit	Exit interface mode.
Bridge4(config)#interface eth4	Enter interface mode.
Bridge4(config-if)#bridge-group 4	Associate the interface with bridge group 4.
Bridge4(config-if)#exit	Exit interface mode.
Bridge4(config)#interface eth5	Enter interface mode
Bridge4(config-if)#bridge-group 4	Associate the interface with bridge group 4.

### Bridge 3

Bridge3#configure terminal	Enter configure mode.
Bridge3(config)#bridge 3 protocol ieee	Add a bridge (3) to the spanning tree table
Bridge3(config)#interface eth2	Enter interface mode.
Bridge3(config-if)#bridge-group 3	Associate the interface with bridge group 3.
Bridge3(config-if)#exit	Exit interface mode.
Bridge3(config)#interface eth3	Enter interface mode.
Bridge3(config-if)#bridge-group 3	Associate the interface with bridge group 3.

---

## Validation

show spanning-tree, show spanning-tree interface <if-name>

### Bridge 1

```
#show spanning-tree
% 1: Bridge up - Spanning Tree Enabled - topology change detected
% 1: Root Path Cost 0 - Root Port 0 - Bridge Priority 32768
% 1: Forward Delay 15 - Hello Time 2 - Max Age 20 - Transmit Hold Count 6
% 1: Root Id 8000525400244323
% 1: Bridge Id 8000525400244323
% 1: last topology change Mon Mar  4 11:40:41 2019
% 1: 20 topology change(s) - last topology change Mon Mar  4 11:40:41 2019

% 1: portfast bpdu-filter disabled
% 1: portfast bpdu-guard disabled
% 1: portfast errdisable timeout disabled
% 1: portfast errdisable timeout interval 300 sec
% eth1: Port Number 3 - Ifindex 3 - Port Id 0x8003 - Role Designated - State
Forwarding
% eth1: Designated Path Cost 0
% eth1: Configured Path Cost 20000 - Add type Explicit ref count 1
% eth1: Designated Port Id 0x8003 - Priority 128 -
% eth1: Root 8000525400244323
% eth1: Designated Bridge 8000525400244323
% eth1: Message Age 0 - Max Age 20
% eth1: Hello Time 2 - Forward Delay 15
% eth1: Forward Timer 0 - Msg Age Timer 0 - Hello Timer 0 - topo change
timer 0
% eth1: forward-transitions 1
% eth1: Version Rapid Spanning Tree Protocol - Received RSTP - Send RSTP
% eth1: No portfast configured - Current portfast off
% eth1: bpdu-guard default - Current bpdu-guard off
% eth1: bpdu-filter default - Current bpdu-filter off
% eth1: no root guard configured - Current root guard off
% eth1: Configured Link Type point-to-point - Current point-to-point
% eth1: No auto-edge configured - Current port Auto Edge off
%
% eth2: Port Number 4 - Ifindex 4 - Port Id 0x8004 - Role Designated - State
Forwarding
% eth2: Designated Path Cost 0
% eth2: Configured Path Cost 20000 - Add type Explicit ref count 1
% eth2: Designated Port Id 0x8004 - Priority 128 -
% eth2: Root 8000525400244323
% eth2: Designated Bridge 8000525400244323
% eth2: Message Age 0 - Max Age 20
% eth2: Hello Time 2 - Forward Delay 15
% eth2: Forward Timer 0 - Msg Age Timer 0 - Hello Timer 1 - topo change
timer 0
% eth2: forward-transitions 1
% eth2: Version Rapid Spanning Tree Protocol - Received None - Send RSTP
% eth2: No portfast configured - Current portfast off
% eth2: bpdu-guard default - Current bpdu-guard off
% eth2: bpdu-filter default - Current bpdu-filter off
% eth2: no root guard configured - Current root guard off
% eth2: Configured Link Type point-to-point - Current point-to-point
```

## Spanning Tree Protocol Configuration

---

```
% eth2: No auto-edge configured - Current port Auto Edge off
%
% eth3: Port Number 5 - Ifindex 5 - Port Id 0x8005 - Role Designated - State
Forwarding
% eth3: Designated Path Cost 0
% eth3: Configured Path Cost 20000 - Add type Explicit ref count 1
% eth3: Designated Port Id 0x8005 - Priority 128 -
% eth3: Root 8000525400244323
% eth3: Designated Bridge 8000525400244323
% eth3: Message Age 0 - Max Age 20
% eth3: Hello Time 2 - Forward Delay 15
% eth3: Forward Timer 0 - Msg Age Timer 0 - Hello Timer 1 - topo change
timer 0
% eth3: forward-transitions 1
% eth3: Version Rapid Spanning Tree Protocol - Received None - Send RSTP
% eth3: No portfast configured - Current portfast off
% eth3: bpdu-guard default - Current bpdu-guard off
% eth3: bpdu-filter default - Current bpdu-filter off
% eth3: no root guard configured - Current root guard off
% eth3: Configured Link Type point-to-point - Current point-to-point
% eth3: No auto-edge configured - Current port Auto Edge off
%
% eth4: Port Number 6 - Ifindex 6 - Port Id 0x8006 - Role Designated - State
Forwarding
% eth4: Designated Path Cost 0
% eth4: Configured Path Cost 20000 - Add type Explicit ref count 1
% eth4: Designated Port Id 0x8006 - Priority 128 -
% eth4: Root 8000525400244323
% eth4: Designated Bridge 8000525400244323
% eth4: Message Age 0 - Max Age 20
% eth4: Hello Time 2 - Forward Delay 15
% eth4: Forward Timer 0 - Msg Age Timer 0 - Hello Timer 0 - topo change
timer 0
% eth4: forward-transitions 1
% eth4: Version Rapid Spanning Tree Protocol - Received None - Send RSTP
% eth4: No portfast configured - Current portfast off
% eth4: bpdu-guard default - Current bpdu-guard off
% eth4: bpdu-filter default - Current bpdu-filter off
% eth4: no root guard configured - Current root guard off
% eth4: Configured Link Type point-to-point - Current point-to-point
% eth4: No auto-edge configured - Current port Auto Edge off
%
#
#show spanning-tree interface eth1
% 1: Bridge up - Spanning Tree Enabled - topology change detected
% 1: Root Path Cost 0 - Root Port 0 - Bridge Priority 32768
% 1: Forward Delay 15 - Hello Time 2 - Max Age 20 - Transmit Hold Count 6
% 1: Root Id 8000525400244323
% 1: Bridge Id 8000525400244323
% 1: last topology change Mon Mar 4 11:40:41 2019
% 1: 20 topology change(s) - last topology change Mon Mar 4 11:40:41 2019

% 1: portfast bpdu-filter disabled
% 1: portfast bpdu-guard disabled
% 1: portfast errdisable timeout disabled
% 1: portfast errdisable timeout interval 300 sec
```

```
% eth1: Port Number 3 - Ifindex 3 - Port Id 0x8003 - Role Designated - State Forwarding
% eth1: Designated Path Cost 0
% eth1: Configured Path Cost 20000 - Add type Explicit ref count 1
% eth1: Designated Port Id 0x8003 - Priority 128 -
% eth1: Root 8000525400244323
% eth1: Designated Bridge 8000525400244323
% eth1: Message Age 0 - Max Age 20
% eth1: Hello Time 2 - Forward Delay 15
% eth1: Forward Timer 0 - Msg Age Timer 0 - Hello Timer 1 - topo change timer 0
% eth1: forward-transitions 1
% eth1: Version Rapid Spanning Tree Protocol - Received RSTP - Send RSTP
% eth1: No portfast configured - Current portfast off
% eth1: bpdu-guard default - Current bpdu-guard off
% eth1: bpdu-filter default - Current bpdu-filter off
% eth1: no root guard configured - Current root guard off
% eth1: Configured Link Type point-to-point - Current point-to-point
% eth1: No auto-edge configured - Current port Auto Edge off
#
```

## Bridge 2

```
#show spanning-tree
% 2: Bridge up - Spanning Tree Enabled - topology change detected
% 2: Root Path Cost 20000 - Root Port 3 - Bridge Priority 32768
% 2: Forward Delay 15 - Hello Time 2 - Max Age 20 - Transmit Hold Count 6
% 2: Root Id 8000525400244323
% 2: Bridge Id 8000525400d15789
% 2: last topology change Mon Mar 4 11:40:43 2019
% 2: 11 topology change(s) - last topology change Mon Mar 4 11:40:43 2019

% 2: portfast bpdu-filter disabled
% 2: portfast bpdu-guard disabled
% 2: portfast errdisable timeout disabled
% 2: portfast errdisable timeout interval 300 sec
% eth1: Port Number 3 - Ifindex 3 - Port Id 0x8003 - Role Rootport - State Forwarding
% eth1: Designated Path Cost 0
% eth1: Configured Path Cost 20000 - Add type Explicit ref count 1
% eth1: Designated Port Id 0x8003 - Priority 128 -
% eth1: Root 8000525400244323
% eth1: Designated Bridge 8000525400244323
% eth1: Message Age 0 - Max Age 20
% eth1: Hello Time 2 - Forward Delay 15
% eth1: Forward Timer 0 - Msg Age Timer 4 - Hello Timer 0 - topo change timer 0
% eth1: forward-transitions 1
% eth1: Version Rapid Spanning Tree Protocol - Received RSTP - Send RSTP
% eth1: No portfast configured - Current portfast off
% eth1: bpdu-guard default - Current bpdu-guard off
% eth1: bpdu-filter default - Current bpdu-filter off
% eth1: no root guard configured - Current root guard off
% eth1: Configured Link Type point-to-point - Current point-to-point
% eth1: No auto-edge configured - Current port Auto Edge off
%
% eth2: Port Number 4 - Ifindex 4 - Port Id 0x8004 - Role Alternate - State Discarding
```

## Spanning Tree Protocol Configuration

---

```
% eth2: Designated Path Cost 0
% eth2: Configured Path Cost 20000 - Add type Explicit ref count 1
% eth2: Designated Port Id 0x8004 - Priority 128 -
% eth2: Root 8000525400244323
% eth2: Designated Bridge 8000525400244323
% eth2: Message Age 0 - Max Age 20
% eth2: Hello Time 2 - Forward Delay 15
% eth2: Forward Timer 0 - Msg Age Timer 4 - Hello Timer 1 - topo change
timer 0
% eth2: forward-transitions 0
% eth2: Version Rapid Spanning Tree Protocol - Received RSTP - Send RSTP
% eth2: No portfast configured - Current portfast off
% eth2: bpdu-guard default - Current bpdu-guard off
% eth2: bpdu-filter default - Current bpdu-filter off
% eth2: no root guard configured - Current root guard off
% eth2: Configured Link Type point-to-point - Current point-to-point
% eth2: No auto-edge configured - Current port Auto Edge off
%
% eth3: Port Number 5 - Ifindex 5 - Port Id 0x8005 - Role Designated - State
Forwarding
% eth3: Designated Path Cost 20000
% eth3: Configured Path Cost 20000 - Add type Explicit ref count 1
% eth3: Designated Port Id 0x8005 - Priority 128 -
% eth3: Root 8000525400244323
% eth3: Designated Bridge 8000525400d15789
% eth3: Message Age 1 - Max Age 20
% eth3: Hello Time 2 - Forward Delay 15
% eth3: Forward Timer 0 - Msg Age Timer 0 - Hello Timer 0 - topo change
timer 0
% eth3: forward-transitions 1
% eth3: Version Rapid Spanning Tree Protocol - Received RSTP - Send RSTP
% eth3: No portfast configured - Current portfast off
% eth3: bpdu-guard default - Current bpdu-guard off
% eth3: bpdu-filter default - Current bpdu-filter off
% eth3: no root guard configured - Current root guard off
% eth3: Configured Link Type point-to-point - Current point-to-point
% eth3: No auto-edge configured - Current port Auto Edge off
%
% eth4: Port Number 6 - Ifindex 6 - Port Id 0x8006 - Role Designated - State
Forwarding
% eth4: Designated Path Cost 20000
% eth4: Configured Path Cost 20000 - Add type Explicit ref count 1
% eth4: Designated Port Id 0x8006 - Priority 128 -
% eth4: Root 8000525400244323
% eth4: Designated Bridge 8000525400d15789
% eth4: Message Age 1 - Max Age 20
% eth4: Hello Time 2 - Forward Delay 15
% eth4: Forward Timer 0 - Msg Age Timer 0 - Hello Timer 0 - topo change
timer 0
% eth4: forward-transitions 1
% eth4: Version Rapid Spanning Tree Protocol - Received None - Send RSTP
% eth4: No portfast configured - Current portfast off
% eth4: bpdu-guard default - Current bpdu-guard off
% eth4: bpdu-filter default - Current bpdu-filter off
% eth4: no root guard configured - Current root guard off
% eth4: Configured Link Type point-to-point - Current point-to-point
% eth4: No auto-edge configured - Current port Auto Edge off
%
```

**Bridge 3**

```
#show spanning-tree
% 3: Bridge up - Spanning Tree Enabled - topology change detected
% 3: Root Path Cost 0 - Root Port 0 - Bridge Priority 32768
% 3: Forward Delay 15 - Hello Time 2 - Max Age 20 - Transmit Hold Count 6
% 3: Root Id 80005254000835af
% 3: Bridge Id 80005254000835af
% 3: last topology change Mon Mar  4 11:39:11 2019
% 3: 2 topology change(s) - last topology change Mon Mar  4 11:39:11 2019

% 3: portfast bpdu-filter disabled
% 3: portfast bpdu-guard disabled
% 3: portfast errdisable timeout disabled
% 3: portfast errdisable timeout interval 300 sec
% eth1: Port Number 3 - Ifindex 3 - Port Id 0x8003 - Role Designated - State
Forwarding
% eth1: Designated Path Cost 0
% eth1: Configured Path Cost 20000 - Add type Explicit ref count 1
% eth1: Designated Port Id 0x8003 - Priority 128 -
% eth1: Root 80005254000835af
% eth1: Designated Bridge 80005254000835af
% eth1: Message Age 0 - Max Age 20
% eth1: Hello Time 2 - Forward Delay 15
% eth1: Forward Timer 0 - Msg Age Timer 0 - Hello Timer 0 - topo change
timer 0
% eth1: forward-transitions 1
% eth1: Version Rapid Spanning Tree Protocol - Received None - Send RSTP
% eth1: No portfast configured - Current portfast off
% eth1: bpdu-guard default - Current bpdu-guard off
% eth1: bpdu-filter default - Current bpdu-filter off
% eth1: no root guard configured - Current root guard off
% eth1: Configured Link Type point-to-point - Current point-to-point
% eth1: No auto-edge configured - Current port Auto Edge off
%
% eth2: Port Number 4 - Ifindex 4 - Port Id 0x8004 - Role Designated - State
Forwarding
% eth2: Designated Path Cost 0
% eth2: Configured Path Cost 20000 - Add type Explicit ref count 1
% eth2: Designated Port Id 0x8004 - Priority 128 -
% eth2: Root 80005254000835af
% eth2: Designated Bridge 80005254000835af
% eth2: Message Age 0 - Max Age 20
% eth2: Hello Time 2 - Forward Delay 15
% eth2: Forward Timer 0 - Msg Age Timer 0 - Hello Timer 0 - topo change
timer 0
% eth2: forward-transitions 1
% eth2: Version Rapid Spanning Tree Protocol - Received None - Send RSTP
% eth2: No portfast configured - Current portfast off
% eth2: bpdu-guard default - Current bpdu-guard off
% eth2: bpdu-filter default - Current bpdu-filter off
% eth2: no root guard configured - Current root guard off
% eth2: Configured Link Type point-to-point - Current point-to-point
% eth2: No auto-edge configured - Current port Auto Edge off
%
```

## Bridge 4

```
#show spanning-tree
% 4: Bridge up - Spanning Tree Enabled - topology change detected
% 4: Root Path Cost 40000 - Root Port 3 - Bridge Priority 32768
% 4: Forward Delay 15 - Hello Time 2 - Max Age 20 - Transmit Hold Count 6
% 4: Root Id 8000525400244323
% 4: Bridge Id 8000525400b83253
% 4: last topology change Mon Mar  4 11:40:40 2019
% 4: 3 topology change(s) - last topology change Mon Mar  4 11:40:40 2019

% 4: portfast bpdu-filter disabled
% 4: portfast bpdu-guard disabled
% 4: portfast errdisable timeout disabled
% 4: portfast errdisable timeout interval 300 sec
% eth1: Port Number 3 - Ifindex 3 - Port Id 0x8003 - Role Rootport - State
Forwarding
% eth1: Designated Path Cost 20000
% eth1: Configured Path Cost 20000 - Add type Explicit ref count 1
% eth1: Designated Port Id 0x8005 - Priority 128 -
% eth1: Root 8000525400244323
% eth1: Designated Bridge 8000525400d15789
% eth1: Message Age 1 - Max Age 20
% eth1: Hello Time 2 - Forward Delay 15
% eth1: Forward Timer 0 - Msg Age Timer 5 - Hello Timer 1 - topo change
timer 0
% eth1: forward-transitions 1
% eth1: Version Rapid Spanning Tree Protocol - Received RSTP - Send RSTP
% eth1: No portfast configured - Current portfast off
% eth1: bpdu-guard default - Current bpdu-guard off
% eth1: bpdu-filter default - Current bpdu-filter off
% eth1: no root guard configured - Current root guard off
% eth1: Configured Link Type point-to-point - Current point-to-point
% eth1: No auto-edge configured - Current port Auto Edge off
%
% eth2: Port Number 4 - Ifindex 4 - Port Id 0x8004 - Role Alternate - State
Discarding
% eth2: Designated Path Cost 20000
% eth2: Configured Path Cost 20000 - Add type Explicit ref count 1
% eth2: Designated Port Id 0x8006 - Priority 128 -
% eth2: Root 8000525400244323
% eth2: Designated Bridge 8000525400d15789
% eth2: Message Age 1 - Max Age 20
% eth2: Hello Time 2 - Forward Delay 15
% eth2: Forward Timer 0 - Msg Age Timer 5 - Hello Timer 0 - topo change
timer 0
% eth2: forward-transitions 0
% eth2: Version Rapid Spanning Tree Protocol - Received RSTP - Send RSTP
% eth2: No portfast configured - Current portfast off
% eth2: bpdu-guard default - Current bpdu-guard off
% eth2: bpdu-filter default - Current bpdu-filter off
% eth2: no root guard configured - Current root guard off
% eth2: Configured Link Type point-to-point - Current point-to-point
% eth2: No auto-edge configured - Current port Auto Edge off
%
% eth3: Port Number 5 - Ifindex 5 - Port Id 0x8005 - Role Designated - State
Forwarding
% eth3: Designated Path Cost 40000
```



```
% eth3: Configured Path Cost 20000 - Add type Explicit ref count 1
% eth3: Designated Port Id 0x8005 - Priority 128 -
% eth3: Root 8000525400244323
% eth3: Designated Bridge 8000525400b83253
% eth3: Message Age 2 - Max Age 20
% eth3: Hello Time 2 - Forward Delay 15
% eth3: Forward Timer 0 - Msg Age Timer 0 - Hello Timer 1 - topo change
timer 0
% eth3: forward-transitions 1
% eth3: Version Rapid Spanning Tree Protocol - Received None - Send RSTP
% eth3: No portfast configured - Current portfast off
% eth3: bpdu-guard default - Current bpdu-guard off
% eth3: bpdu-filter default - Current bpdu-filter off
% eth3: no root guard configured - Current root guard off
% eth3: Configured Link Type point-to-point - Current point-to-point
% eth3: No auto-edge configured - Current port Auto Edge off
%
% eth4: Port Number 6 - Ifindex 6 - Port Id 0x8006 - Role Designated - State
Forwarding
% eth4: Designated Path Cost 40000
% eth4: Configured Path Cost 20000 - Add type Explicit ref count 1
% eth4: Designated Port Id 0x8006 - Priority 128 -
% eth4: Root 8000525400244323
% eth4: Designated Bridge 8000525400b83253
% eth4: Message Age 2 - Max Age 20
% eth4: Hello Time 2 - Forward Delay 15
% eth4: Forward Timer 0 - Msg Age Timer 0 - Hello Timer 0 - topo change
timer 0
% eth4: forward-transitions 1
% eth4: Version Rapid Spanning Tree Protocol - Received None - Send RSTP
% eth4: No portfast configured - Current portfast off
% eth4: bpdu-guard default - Current bpdu-guard off
% eth4: bpdu-filter default - Current bpdu-filter off
% eth4: no root guard configured - Current root guard off
% eth4: Configured Link Type point-to-point - Current point-to-point
% eth4: No auto-edge configured - Current port Auto Edge off
%
#
```



## CHAPTER 4 RSTP Configuration

This chapter contains a complete sample Rapid Spanning Tree Protocol (RSTP) configuration. RSTP provides rapid convergence of a spanning tree. It speeds up the reconfiguration of the tree after a change by using alternate ports.

### Topology

The following example is a simple multi-bridge topology.

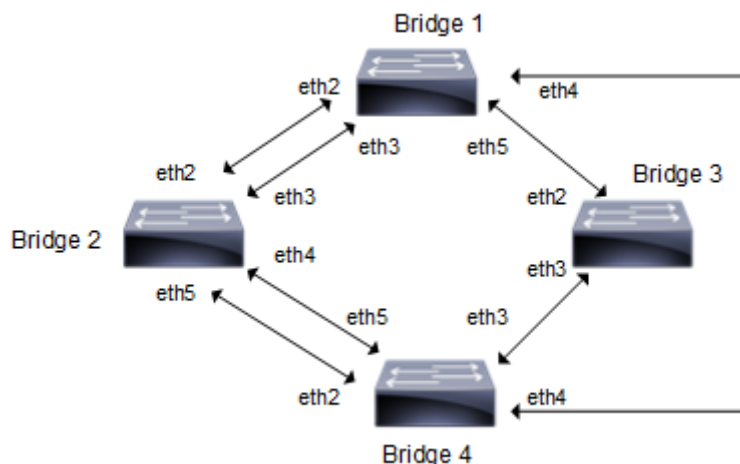

Figure 4-4: RSTP Topology

Note: Run the `switchport` command on each port to change to Layer-2 mode.

## Configuration

### Bridge 1

<code>Bridgel#configure terminal</code>	Enter configure mode.
<code>Bridgel(config)#bridge 1 protocol rstp</code>	Add a bridge (1) to the rapid spanning tree table
<code>Bridgel(config)#interface eth2</code>	Enter interface mode.
<code>Bridgel(config-if)#bridge-group 1</code>	Associate the interface with bridge group 1.
<code>Bridgel(config-if)#exit</code>	Exit interface mode.
<code>Bridgel(config)#interface eth3</code>	Enter interface mode.
<code>Bridgel(config-if)#bridge-group 1</code>	Associate the interface with bridge group 1.
<code>Bridgel(config-if)#exit</code>	Exit interface mode.
<code>Bridgel(config)#interface eth4</code>	Enter interface mode.
<code>Bridgel(config-if)#bridge-group 1</code>	Associate the interface with bridge group 1.
<code>Bridgel(config-if)#exit</code>	Exit interface mode.
<code>Bridgel(config)#interface eth5</code>	Enter interface mode
<code>Bridgel(config-if)#bridge-group 1</code>	Associate the interface with bridge group 1.

**Bridge 2**

Bridge2#configure terminal	Enter configure mode.
Bridge2(config)#bridge 2 protocol rstp	Add a bridge (2) to the rapid spanning tree table
Bridge2(config)#interface eth2	Enter interface mode.
Bridge2(config-if)#bridge-group 2	Associate the interface with bridge group 2.
Bridge2(config-if)#exit	Exit interface mode.
Bridge2(config)#interface eth3	Enter interface mode.
Bridge2(config-if)#bridge-group 2	Associate the interface with bridge group 2.
Bridge2(config-if)#exit	Exit interface mode.
Bridge2(config)#interface eth4	Enter interface mode.
Bridge2(config-if)#bridge-group 2	Associate the interface with bridge group 2.
Bridge2(config-if)#exit	Exit interface mode.
Bridge2(config)#interface eth5	Enter interface mode
Bridge2(config-if)#bridge-group 2	Associate the interface with bridge group 2.

**Bridge 3**

Bridge3#configure terminal	Enter configure mode.
Bridge3(config)#bridge 3 protocol rstp	Add a bridge (3) to the rapid spanning tree table
Bridge3(config)#interface eth2	Enter interface mode.
Bridge3(config-if)#bridge-group 3	Associate the interface with bridge group 3.
Bridge3(config-if)#exit	Exit interface mode.
Bridge3(config)#interface eth3	Enter interface mode.
Bridge3(config-if)#bridge-group 3	Associate the interface with bridge group 3.

**Bridge 4**

Bridge4#configure terminal	Enter configure mode.
Bridge4(config)#bridge 4 protocol rstp	Add a bridge (4) to the rapid spanning tree table
Bridge4(config)#interface eth2	Enter interface mode.
Bridge4(config-if)#bridge-group 4	Associate the interface with bridge group 4.
Bridge4(config-if)#exit	Exit interface mode.
Bridge4(config)#interface eth3	Enter interface mode.
Bridge4(config-if)#bridge-group 4	Associate the interface with bridge group 4.
Bridge4(config-if)#exit	Exit interface mode.
Bridge4(config)#interface eth4	Enter interface mode.
Bridge4(config-if)#bridge-group 4	Associate the interface with bridge group 4.
Bridge4(config-if)#exit	Exit interface mode.
Bridge4(config)#interface eth5	Enter interface mode
Bridge4(config-if)#bridge-group 4	Associate the interface with bridge group 4.

---

## Validation

show spanning-tree, show spanning-tree interface <if-name>

### Bridge 1

```
#show spanning-tree
% 1: Bridge up - Spanning Tree Enabled - topology change detected
% 1: Root Path Cost 0 - Root Port 0 - Bridge Priority 32768
% 1: Forward Delay 15 - Hello Time 2 - Max Age 20 - Transmit Hold Count 6
% 1: Root Id 8000525400244323
% 1: Bridge Id 8000525400244323
% 1: last topology change Mon Mar  4 11:40:41 2019
% 1: 20 topology change(s) - last topology change Mon Mar  4 11:40:41 2019

% 1: portfast bpdu-filter disabled
% 1: portfast bpdu-guard disabled
% 1: portfast errdisable timeout disabled
% 1: portfast errdisable timeout interval 300 sec
% eth1: Port Number 3 - Ifindex 3 - Port Id 0x8003 - Role Designated - State
Forwarding
% eth1: Designated Path Cost 0
% eth1: Configured Path Cost 20000 - Add type Explicit ref count 1
% eth1: Designated Port Id 0x8003 - Priority 128 -
% eth1: Root 8000525400244323
% eth1: Designated Bridge 8000525400244323
% eth1: Message Age 0 - Max Age 20
% eth1: Hello Time 2 - Forward Delay 15
% eth1: Forward Timer 0 - Msg Age Timer 0 - Hello Timer 0 - topo change
timer 0
% eth1: forward-transitions 1
% eth1: Version Rapid Spanning Tree Protocol - Received RSTP - Send RSTP
% eth1: No portfast configured - Current portfast off
% eth1: bpdu-guard default - Current bpdu-guard off
% eth1: bpdu-filter default - Current bpdu-filter off
% eth1: no root guard configured - Current root guard off
% eth1: Configured Link Type point-to-point - Current point-to-point
% eth1: No auto-edge configured - Current port Auto Edge off
%
% eth2: Port Number 4 - Ifindex 4 - Port Id 0x8004 - Role Designated - State
Forwarding
% eth2: Designated Path Cost 0
% eth2: Configured Path Cost 20000 - Add type Explicit ref count 1
% eth2: Designated Port Id 0x8004 - Priority 128 -
% eth2: Root 8000525400244323
% eth2: Designated Bridge 8000525400244323
% eth2: Message Age 0 - Max Age 20
% eth2: Hello Time 2 - Forward Delay 15
% eth2: Forward Timer 0 - Msg Age Timer 0 - Hello Timer 1 - topo change
timer 0
% eth2: forward-transitions 1
% eth2: Version Rapid Spanning Tree Protocol - Received None - Send RSTP
% eth2: No portfast configured - Current portfast off
% eth2: bpdu-guard default - Current bpdu-guard off
% eth2: bpdu-filter default - Current bpdu-filter off
% eth2: no root guard configured - Current root guard off
% eth2: Configured Link Type point-to-point - Current point-to-point
```

## RSTP Configuration

---

```
% eth2: No auto-edge configured - Current port Auto Edge off
%
% eth3: Port Number 5 - Ifindex 5 - Port Id 0x8005 - Role Designated - State
Forwarding
% eth3: Designated Path Cost 0
% eth3: Configured Path Cost 20000 - Add type Explicit ref count 1
% eth3: Designated Port Id 0x8005 - Priority 128 -
% eth3: Root 8000525400244323
% eth3: Designated Bridge 8000525400244323
% eth3: Message Age 0 - Max Age 20
% eth3: Hello Time 2 - Forward Delay 15
% eth3: Forward Timer 0 - Msg Age Timer 0 - Hello Timer 1 - topo change
timer 0
% eth3: forward-transitions 1
% eth3: Version Rapid Spanning Tree Protocol - Received None - Send RSTP
% eth3: No portfast configured - Current portfast off
% eth3: bpdu-guard default - Current bpdu-guard off
% eth3: bpdu-filter default - Current bpdu-filter off
% eth3: no root guard configured - Current root guard off
% eth3: Configured Link Type point-to-point - Current point-to-point
% eth3: No auto-edge configured - Current port Auto Edge off
%
% eth4: Port Number 6 - Ifindex 6 - Port Id 0x8006 - Role Designated - State
Forwarding
% eth4: Designated Path Cost 0
% eth4: Configured Path Cost 20000 - Add type Explicit ref count 1
% eth4: Designated Port Id 0x8006 - Priority 128 -
% eth4: Root 8000525400244323
% eth4: Designated Bridge 8000525400244323
% eth4: Message Age 0 - Max Age 20
% eth4: Hello Time 2 - Forward Delay 15
% eth4: Forward Timer 0 - Msg Age Timer 0 - Hello Timer 0 - topo change
timer 0
% eth4: forward-transitions 1
% eth4: Version Rapid Spanning Tree Protocol - Received None - Send RSTP
% eth4: No portfast configured - Current portfast off
% eth4: bpdu-guard default - Current bpdu-guard off
% eth4: bpdu-filter default - Current bpdu-filter off
% eth4: no root guard configured - Current root guard off
% eth4: Configured Link Type point-to-point - Current point-to-point
% eth4: No auto-edge configured - Current port Auto Edge off
%
#
#show spanning-tree interface eth1
% 1: Bridge up - Spanning Tree Enabled - topology change detected
% 1: Root Path Cost 0 - Root Port 0 - Bridge Priority 32768
% 1: Forward Delay 15 - Hello Time 2 - Max Age 20 - Transmit Hold Count 6
% 1: Root Id 8000525400244323
% 1: Bridge Id 8000525400244323
% 1: last topology change Mon Mar 4 11:40:41 2019
% 1: 20 topology change(s) - last topology change Mon Mar 4 11:40:41 2019

% 1: portfast bpdu-filter disabled
% 1: portfast bpdu-guard disabled
% 1: portfast errdisable timeout disabled
% 1: portfast errdisable timeout interval 300 sec
```

```

% eth1: Port Number 3 - Ifindex 3 - Port Id 0x8003 - Role Designated - State
Forwarding
% eth1: Designated Path Cost 0
% eth1: Configured Path Cost 20000 - Add type Explicit ref count 1
% eth1: Designated Port Id 0x8003 - Priority 128 -
% eth1: Root 8000525400244323
% eth1: Designated Bridge 8000525400244323
% eth1: Message Age 0 - Max Age 20
% eth1: Hello Time 2 - Forward Delay 15
% eth1: Forward Timer 0 - Msg Age Timer 0 - Hello Timer 1 - topo change
timer 0
% eth1: forward-transitions 1
% eth1: Version Rapid Spanning Tree Protocol - Received RSTP - Send RSTP
% eth1: No portfast configured - Current portfast off
% eth1: bpdu-guard default - Current bpdu-guard off
% eth1: bpdu-filter default - Current bpdu-filter off
% eth1: no root guard configured - Current root guard off
% eth1: Configured Link Type point-to-point - Current point-to-point
% eth1: No auto-edge configured - Current port Auto Edge off
%
%
#

```

## Bridge 2

```

#show spanning-tree
% 2: Bridge up - Spanning Tree Enabled - topology change detected
% 2: Root Path Cost 20000 - Root Port 3 - Bridge Priority 32768
% 2: Forward Delay 15 - Hello Time 2 - Max Age 20 - Transmit Hold Count 6
% 2: Root Id 8000525400244323
% 2: Bridge Id 8000525400d15789
% 2: last topology change Mon Mar 4 11:40:43 2019
% 2: 11 topology change(s) - last topology change Mon Mar 4 11:40:43 2019

% 2: portfast bpdu-filter disabled
% 2: portfast bpdu-guard disabled
% 2: portfast errdisable timeout disabled
% 2: portfast errdisable timeout interval 300 sec
% eth1: Port Number 3 - Ifindex 3 - Port Id 0x8003 - Role Rootport - State
Forwarding
% eth1: Designated Path Cost 0
% eth1: Configured Path Cost 20000 - Add type Explicit ref count 1
% eth1: Designated Port Id 0x8003 - Priority 128 -
% eth1: Root 8000525400244323
% eth1: Designated Bridge 8000525400244323
% eth1: Message Age 0 - Max Age 20
% eth1: Hello Time 2 - Forward Delay 15
% eth1: Forward Timer 0 - Msg Age Timer 4 - Hello Timer 0 - topo change
timer 0
% eth1: forward-transitions 1
% eth1: Version Rapid Spanning Tree Protocol - Received RSTP - Send RSTP
% eth1: No portfast configured - Current portfast off
% eth1: bpdu-guard default - Current bpdu-guard off
% eth1: bpdu-filter default - Current bpdu-filter off
% eth1: no root guard configured - Current root guard off
% eth1: Configured Link Type point-to-point - Current point-to-point
% eth1: No auto-edge configured - Current port Auto Edge off
%

```

## RSTP Configuration

---

```
% eth2: Port Number 4 - Ifindex 4 - Port Id 0x8004 - Role Alternate - State
Discarding
% eth2: Designated Path Cost 0
% eth2: Configured Path Cost 20000 - Add type Explicit ref count 1
% eth2: Designated Port Id 0x8004 - Priority 128 -
% eth2: Root 8000525400244323
% eth2: Designated Bridge 8000525400244323
% eth2: Message Age 0 - Max Age 20
% eth2: Hello Time 2 - Forward Delay 15
% eth2: Forward Timer 0 - Msg Age Timer 4 - Hello Timer 1 - topo change
timer 0
% eth2: forward-transitions 0
% eth2: Version Rapid Spanning Tree Protocol - Received RSTP - Send RSTP
% eth2: No portfast configured - Current portfast off
% eth2: bpdu-guard default - Current bpdu-guard off
% eth2: bpdu-filter default - Current bpdu-filter off
% eth2: no root guard configured - Current root guard off
% eth2: Configured Link Type point-to-point - Current point-to-point
% eth2: No auto-edge configured - Current port Auto Edge off
%
% eth3: Port Number 5 - Ifindex 5 - Port Id 0x8005 - Role Designated - State
Forwarding
% eth3: Designated Path Cost 20000
% eth3: Configured Path Cost 20000 - Add type Explicit ref count 1
% eth3: Designated Port Id 0x8005 - Priority 128 -
% eth3: Root 8000525400244323
% eth3: Designated Bridge 8000525400d15789
% eth3: Message Age 1 - Max Age 20
% eth3: Hello Time 2 - Forward Delay 15
% eth3: Forward Timer 0 - Msg Age Timer 0 - Hello Timer 0 - topo change
timer 0
% eth3: forward-transitions 1
% eth3: Version Rapid Spanning Tree Protocol - Received RSTP - Send RSTP
% eth3: No portfast configured - Current portfast off
% eth3: bpdu-guard default - Current bpdu-guard off
% eth3: bpdu-filter default - Current bpdu-filter off
% eth3: no root guard configured - Current root guard off
% eth3: Configured Link Type point-to-point - Current point-to-point
% eth3: No auto-edge configured - Current port Auto Edge off
%
% eth4: Port Number 6 - Ifindex 6 - Port Id 0x8006 - Role Designated - State
Forwarding
% eth4: Designated Path Cost 20000
% eth4: Configured Path Cost 20000 - Add type Explicit ref count 1
% eth4: Designated Port Id 0x8006 - Priority 128 -
% eth4: Root 8000525400244323
% eth4: Designated Bridge 8000525400d15789
% eth4: Message Age 1 - Max Age 20
% eth4: Hello Time 2 - Forward Delay 15
% eth4: Forward Timer 0 - Msg Age Timer 0 - Hello Timer 0 - topo change
timer 0
% eth4: forward-transitions 1
% eth4: Version Rapid Spanning Tree Protocol - Received None - Send RSTP
% eth4: No portfast configured - Current portfast off
% eth4: bpdu-guard default - Current bpdu-guard off
% eth4: bpdu-filter default - Current bpdu-filter off
% eth4: no root guard configured - Current root guard off
% eth4: Configured Link Type point-to-point - Current point-to-point
```



```
% eth4: No auto-edge configured - Current port Auto Edge off
%
#
```

### Bridge 3

```
#show spanning-tree
% 3: Bridge up - Spanning Tree Enabled - topology change detected
% 3: Root Path Cost 0 - Root Port 0 - Bridge Priority 32768
% 3: Forward Delay 15 - Hello Time 2 - Max Age 20 - Transmit Hold Count 6
% 3: Root Id 80005254000835af
% 3: Bridge Id 80005254000835af
% 3: last topology change Mon Mar  4 11:39:11 2019
% 3: 2 topology change(s) - last topology change Mon Mar  4 11:39:11 2019

% 3: portfast bpdu-filter disabled
% 3: portfast bpdu-guard disabled
% 3: portfast errdisable timeout disabled
% 3: portfast errdisable timeout interval 300 sec
% eth1: Port Number 3 - Ifindex 3 - Port Id 0x8003 - Role Designated - State
Forwarding
% eth1: Designated Path Cost 0
% eth1: Configured Path Cost 20000 - Add type Explicit ref count 1
% eth1: Designated Port Id 0x8003 - Priority 128 -
% eth1: Root 80005254000835af
% eth1: Designated Bridge 80005254000835af
% eth1: Message Age 0 - Max Age 20
% eth1: Hello Time 2 - Forward Delay 15
% eth1: Forward Timer 0 - Msg Age Timer 0 - Hello Timer 0 - topo change
timer 0
% eth1: forward-transitions 1
% eth1: Version Rapid Spanning Tree Protocol - Received None - Send RSTP
% eth1: No portfast configured - Current portfast off
% eth1: bpdu-guard default - Current bpdu-guard off
% eth1: bpdu-filter default - Current bpdu-filter off
% eth1: no root guard configured - Current root guard off
% eth1: Configured Link Type point-to-point - Current point-to-point
% eth1: No auto-edge configured - Current port Auto Edge off
%
% eth2: Port Number 4 - Ifindex 4 - Port Id 0x8004 - Role Designated - State
Forwarding
% eth2: Designated Path Cost 0
% eth2: Configured Path Cost 20000 - Add type Explicit ref count 1
% eth2: Designated Port Id 0x8004 - Priority 128 -
% eth2: Root 80005254000835af
% eth2: Designated Bridge 80005254000835af
% eth2: Message Age 0 - Max Age 20
% eth2: Hello Time 2 - Forward Delay 15
% eth2: Forward Timer 0 - Msg Age Timer 0 - Hello Timer 0 - topo change
timer 0
% eth2: forward-transitions 1
% eth2: Version Rapid Spanning Tree Protocol - Received None - Send RSTP
% eth2: No portfast configured - Current portfast off
% eth2: bpdu-guard default - Current bpdu-guard off
% eth2: bpdu-filter default - Current bpdu-filter off
% eth2: no root guard configured - Current root guard off
% eth2: Configured Link Type point-to-point - Current point-to-point
% eth2: No auto-edge configured - Current port Auto Edge off
```

%  
#

### Bridge 4

```
#show spanning-tree
% 4: Bridge up - Spanning Tree Enabled - topology change detected
% 4: Root Path Cost 40000 - Root Port 3 - Bridge Priority 32768
% 4: Forward Delay 15 - Hello Time 2 - Max Age 20 - Transmit Hold Count 6
% 4: Root Id 8000525400244323
% 4: Bridge Id 8000525400b83253
% 4: last topology change Mon Mar  4 11:40:40 2019
% 4: 3 topology change(s) - last topology change Mon Mar  4 11:40:40 2019

% 4: portfast bpdu-filter disabled
% 4: portfast bpdu-guard disabled
% 4: portfast errdisable timeout disabled
% 4: portfast errdisable timeout interval 300 sec
% eth1: Port Number 3 - Ifindex 3 - Port Id 0x8003 - Role Rootport - State
Forwarding
% eth1: Designated Path Cost 20000
% eth1: Configured Path Cost 20000 - Add type Explicit ref count 1
% eth1: Designated Port Id 0x8005 - Priority 128 -
% eth1: Root 8000525400244323
% eth1: Designated Bridge 8000525400d15789
% eth1: Message Age 1 - Max Age 20
% eth1: Hello Time 2 - Forward Delay 15
% eth1: Forward Timer 0 - Msg Age Timer 5 - Hello Timer 1 - topo change
timer 0
% eth1: forward-transitions 1
% eth1: Version Rapid Spanning Tree Protocol - Received RSTP - Send RSTP
% eth1: No portfast configured - Current portfast off
% eth1: bpdu-guard default - Current bpdu-guard off
% eth1: bpdu-filter default - Current bpdu-filter off
% eth1: no root guard configured - Current root guard off
% eth1: Configured Link Type point-to-point - Current point-to-point
% eth1: No auto-edge configured - Current port Auto Edge off
%
% eth2: Port Number 4 - Ifindex 4 - Port Id 0x8004 - Role Alternate - State
Discarding
% eth2: Designated Path Cost 20000
% eth2: Configured Path Cost 20000 - Add type Explicit ref count 1
% eth2: Designated Port Id 0x8006 - Priority 128 -
% eth2: Root 8000525400244323
% eth2: Designated Bridge 8000525400d15789
% eth2: Message Age 1 - Max Age 20
% eth2: Hello Time 2 - Forward Delay 15
% eth2: Forward Timer 0 - Msg Age Timer 5 - Hello Timer 0 - topo change
timer 0
% eth2: forward-transitions 0
% eth2: Version Rapid Spanning Tree Protocol - Received RSTP - Send RSTP
% eth2: No portfast configured - Current portfast off
% eth2: bpdu-guard default - Current bpdu-guard off
% eth2: bpdu-filter default - Current bpdu-filter off
% eth2: no root guard configured - Current root guard off
% eth2: Configured Link Type point-to-point - Current point-to-point
% eth2: No auto-edge configured - Current port Auto Edge off
%
```

---

```
% eth3: Port Number 5 - Ifindex 5 - Port Id 0x8005 - Role Designated - State
Forwarding
% eth3: Designated Path Cost 40000
% eth3: Configured Path Cost 20000 - Add type Explicit ref count 1
% eth3: Designated Port Id 0x8005 - Priority 128 -
% eth3: Root 8000525400244323
% eth3: Designated Bridge 8000525400b83253
% eth3: Message Age 2 - Max Age 20
% eth3: Hello Time 2 - Forward Delay 15
% eth3: Forward Timer 0 - Msg Age Timer 0 - Hello Timer 1 - topo change
timer 0
% eth3: forward-transitions 1
% eth3: Version Rapid Spanning Tree Protocol - Received None - Send RSTP
% eth3: No portfast configured - Current portfast off
% eth3: bpdu-guard default - Current bpdu-guard off
% eth3: bpdu-filter default - Current bpdu-filter off
% eth3: no root guard configured - Current root guard off
% eth3: Configured Link Type point-to-point - Current point-to-point
% eth3: No auto-edge configured - Current port Auto Edge off
%
% eth4: Port Number 6 - Ifindex 6 - Port Id 0x8006 - Role Designated - State
Forwarding
% eth4: Designated Path Cost 40000
% eth4: Configured Path Cost 20000 - Add type Explicit ref count 1
% eth4: Designated Port Id 0x8006 - Priority 128 -
% eth4: Root 8000525400244323
% eth4: Designated Bridge 8000525400b83253
% eth4: Message Age 2 - Max Age 20
% eth4: Hello Time 2 - Forward Delay 15
% eth4: Forward Timer 0 - Msg Age Timer 0 - Hello Timer 0 - topo change
timer 0
% eth4: forward-transitions 1
% eth4: Version Rapid Spanning Tree Protocol - Received None - Send RSTP
% eth4: No portfast configured - Current portfast off
% eth4: bpdu-guard default - Current bpdu-guard off
% eth4: bpdu-filter default - Current bpdu-filter off
% eth4: no root guard configured - Current root guard off
% eth4: Configured Link Type point-to-point - Current point-to-point
% eth4: No auto-edge configured - Current port Auto Edge off
%
#
```



## CHAPTER 5 MSTP Configuration

This chapter contains a complete sample Multiple Spanning Tree Protocol (MSTP) configuration. MSTP allows multiple VLANs to be grouped into one spanning-tree instance. Every MST instance has a spanning-tree that is independent of other spanning-tree instances providing multiple forwarding paths for data traffic.

### Topology

This example gives a simple multi-bridge topology and its configuration.

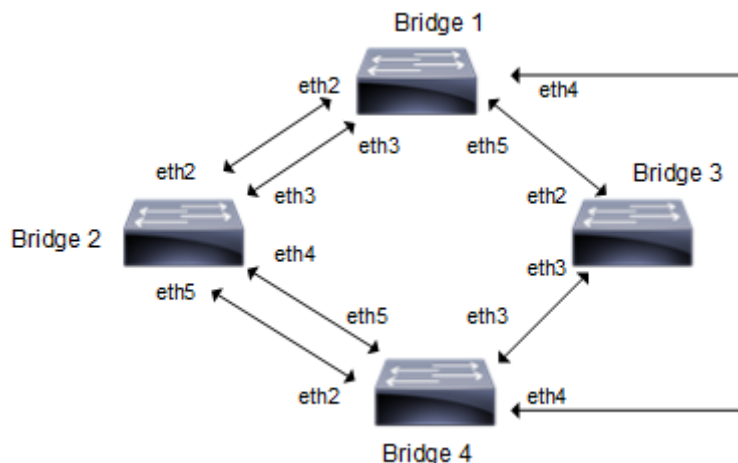

Figure 5-5: MSTP Topology

Note: Run the `switchport` command on each port to change to Layer-2 mode.

## Configuration

### Bridge 1

<code>Bridge1#configure terminal</code>	Enter configure mode.
<code>Bridge1(config)#bridge 1 protocol mstp</code>	Add a bridge (1) to the multiple spanning tree table.
<code>Bridge1(config)#vlan database</code>	Enter the VLAN configuration mode.
<code>Bridge1(config-vlan)#vlan 2 bridge 1 state enable</code>	Enable the state of VLAN 2 on bridge 1. Specifying an enable state allows forwarding of frames over VLAN 2 on bridge 1.
<code>Bridge1(config-vlan)#vlan 3 bridge 1 state enable</code>	Enable the state of VLAN 3 on bridge 1. Specifying an enable state allows forwarding of frames over VLAN 3 on bridge 1.
<code>Bridge1(config-vlan)#vlan 4 bridge 1 state enable</code>	Enable the state of VLAN 4 on bridge 1. Specifying an enable state allows forwarding of frames over VLAN 4 on bridge 1.
<code>Bridge1(config-vlan)#vlan 5 bridge 1 state enable</code>	Enable the state of VLAN 5 on bridge 1. Specifying an enable state allows forwarding of frames over VLAN 5 on bridge 1.
<code>Bridge1(config-vlan)#exit</code>	Exit the VLAN configuration mode.
<code>Bridge1(config)#spanning-tree mst configuration</code>	Enter the Multiple Spanning Tree

## MSTP Configuration

<code>Bridgel(config-mst)#bridge 1 instance 2 vlan 2</code>	Create an instance of VLAN. The VLANs must be created before being associating with an MST instance (MSTI). If the VLAN range is not specified the MSTI will not be created.
<code>Bridgel(config-mst)#bridge 1 instance 3 vlan 3</code>	Create another instance of VLAN. The VLANs must be created before being associating with an MST instance (MSTI). If the VLAN range is not specified the MSTI will not be created.
<code>Bridgel(config-mst)#bridge 1 instance 4 vlan 4</code>	same as mention above.
<code>Bridgel(config-mst)#bridge 1 instance 5 vlan 5</code>	same as mention above.
<code>Bridgel(config-mst)#exit</code>	Exit MST Configuration mode.
<code>Bridgel(config)#interface eth2</code>	Enter interface mode for eth2
<code>Bridgel(config-if)#bridge-group 1</code>	Associating the interface to bridge-group 1
<code>Bridgel(config-if)#bridge-group 1 instance 2</code>	Assigning bridge-group 1 to this instance
<code>Bridgel(config-if)#bridge-group 1 instance 3</code>	Assigning bridge-group 1 to this instance
<code>Bridgel(config-if)#bridge-group 1 instance 4</code>	Assigning bridge-group 1 to this instance
<code>Bridgel(config-if)#bridge-group 1 instance 5</code>	Assigning bridge-group 1 to this instance
<code>Bridgel(config-if)#exit</code>	Exit interface mode.
<code>Bridgel(config)#interface eth3</code>	Enter interface mode for eth3.
<code>Bridgel(config-if)#bridge-group 1</code>	Associating the interface to bridge-group 1
<code>Bridgel(config-if)#bridge-group 1 instance 2</code>	Assigning bridge-group 1 to this instance
<code>Bridgel(config-if)#bridge-group 1 instance 3</code>	Assigning bridge-group 1 to this instance
<code>Bridgel(config-if)#bridge-group 1 instance 4</code>	Assigning bridge-group 1 to this instance
<code>Bridgel(config-if)#bridge-group 1 instance 5</code>	Assigning bridge-group 1 to this instance
<code>Bridgel(config-if)#exit</code>	Exit interface mode.
<code>Bridgel(config)#interface eth4</code>	Enter interface mode for eth4.
<code>Bridgel(config-if)#bridge-group 1</code>	Associating the interface to bridge-group 1
<code>Bridgel(config-if)#bridge-group 1 instance 2</code>	Assigning bridge-group 1 to this instance
<code>Bridgel(config-if)#bridge-group 1 instance 3</code>	Assigning bridge-group 1 to this instance
<code>Bridgel(config-if)#bridge-group 1 instance 4</code>	Assigning bridge-group 1 to this instance
<code>Bridgel(config-if)#bridge-group 1 instance 5</code>	Assigning bridge-group 1 to this instance
<code>Bridgel(config-if)#exit</code>	Exit interface mode.
<code>Bridgel(config)#interface eth5</code>	Enter interface mode for eth5.
<code>Bridgel(config-if)#bridge-group 1</code>	Associating the interface to bridge-group 1

Bridge1 (config-if) #bridge-group 1 instance 2	Assigning bridge-group 1 to this instance
Bridge1 (config-if) #bridge-group 1 instance 3	Assigning bridge-group 1 to this instance
Bridge1 (config-if) #bridge-group 1 instance 4	Assigning bridge-group 1 to this instance
Bridge1 (config-if) #bridge-group 1 instance 5	Assigning bridge-group 1 to this instance
Bridge1 (config-if) #exit	Exit interface mode.

## Bridge 2

Bridge2#configure terminal	Enter configure mode.
Bridge2 (config) #bridge 2 protocol mstp	Add a bridge (2) to the multiple spanning
Bridge2 (config) #bridge 2 priority 4096	Assign priority to this bridge.
Bridge2 (config) #vlan database	Enter the VLAN configuration mode.
Bridge2 (config-vlan) #vlan 2 bridge 2 state enable	Enable the state of VLAN 2 on bridge 2. Specifying an enable state allows forwarding of frames over VLAN 2 on bridge 2.
Bridge2 (config-vlan) #vlan 3 bridge 2 state enable	Enable the state of VLAN 3 on bridge 2. Specifying an enable state allows forwarding of frames over VLAN 3 on bridge 2
Bridge2 (config-vlan) #vlan 4 bridge 2 state enable	Enable the state of VLAN 4 on bridge 2. Specifying an enable state allows forwarding of frames over VLAN 4 on bridge 2
Bridge2 (config-vlan) #vlan 5 bridge 2 state enable	Enable the state of VLAN 5 on bridge 2. Specifying an enable state allows forwarding of frames over VLAN 5 on bridge 2
Bridge2 (config-vlan) #exit	Exit the VLAN configuration mode.
Bridge2 (config) #spanning-tree mst configuration	Enter the Multiple Spanning Tree configuration mode
Bridge2 (config-mst) #bridge 2 instance 2 vlan 2	Create an instance of VLAN. The VLANs must be created before being associating with an MST instance (MSTI). If the VLAN range is not specified the MSTI will not be created.
Bridge2 (config-mst) #bridge 2 instance 3 vlan 3	same as mention above.
Bridge2 (config-mst) #bridge 2 instance 4 vlan 4	same as mention above.
Bridge2 (config-mst) #bridge 2 instance 5 vlan 5	same as mention above.
Bridge2 (config-mst) #exit	Exit MST Configuration mode.
Bridge2 (config) #interface eth2	Enter interface mode for eth2
Bridge2 (config-if) #bridge-group 2	Associating the interface to bridge-group 2
Bridge2 (config-if) #bridge-group 2 instance 2	Assigning bridge-group 2 to this instance
Bridge2 (config-if) #bridge-group 2 instance 3	Assigning bridge-group 2 to this instance
Bridge2 (config-if) #bridge-group 2 instance 4	Assigning bridge-group 2 to this instance
Bridge2 (config-if) #bridge-group 2 instance 5	Assigning bridge-group 2 to this instance

## MSTP Configuration

Bridge2 (config-if) #exit	Exit interface mode.
Bridge2 (config) #interface eth3	Enter interface mode for eth3
Bridge2 (config-if) #bridge-group 2	Associating the interface to bridge-group 2
Bridge2 (config-if) #bridge-group 2 instance 2	Assigning bridge-group 2 to this instance
Bridge2 (config-if) #bridge-group 2 instance 3	Assigning bridge-group 2 to this instance
Bridge2 (config-if) #bridge-group 2 instance 3 priority 16	Assign bridge-group 2 to this instance and set a port priority in order of 16 for it. MSTP uses port priority as a tiebreaker to determine which port should forward frames for a particular instance on a LAN, or which port should be the root port for an instance. A lower value implies better priority.
Bridge2 (config-if) #bridge-group 2 instance 4	Assigning bridge-group 2 to this instance
Bridge2 (config-if) #bridge-group 2 instance 4 priority 16	Assign bridge-group 2 to this instance and set a port priority in order of 16 for it. MSTP uses port priority as a tiebreaker to determine which port should forward frames for a particular instance on a LAN, or which port should be the root port for an instance. A lower value implies better priority
Bridge2 (config-if) #bridge-group 2 instance 5	Assigning bridge-group 2 to this instance
Bridge2 (config-if) #exit	Exit interface mode
Bridge2 (config) #interface eth4	Enter interface mode for eth4
Bridge2 (config-if) #bridge-group 2	Associating the interface to bridge-group 2
Bridge2 (config-if) #bridge-group 2 instance 2	Assigning bridge-group 2 to this instance
Bridge2 (config-if) #bridge-group 2 instance 3	Assigning bridge-group 2 to this instance
Bridge2 (config-if) #bridge-group 2 instance 4	Assigning bridge-group 2 to this instance
Bridge2 (config-if) #bridge-group 2 instance 5	Assigning bridge-group 2 to this instance
Bridge2 (config-if) #exit	Exit interface mode.
Bridge2 (config) #interface eth5	Enter interface mode for eth5
Bridge2 (config-if) #bridge-group 2	Associating the interface to bridge-group 2
Bridge2 (config-if) #bridge-group 2 instance 2	Assigning bridge-group 2 to this instance
Bridge2 (config-if) #bridge-group 2 instance 3	Assigning bridge-group 2 to this instance
Bridge2 (config-if) #bridge-group 2 instance 4	Assigning bridge-group 2 to this instance
Bridge2 (config-if) #bridge-group 2 instance 5	Assigning bridge-group 2 to this instance
Bridge2 (config-if) #exit	Exit interface mode.



## Bridge 3

Bridge3#configure terminal	Enter configure mode.
Bridge3(config)#bridge 3 protocol mstp	Add a bridge (3) to the multiple spanning tree table
Bridge3(config)#vlan database	Enter the VLAN configuration mode.
Bridge3(config-vlan)#vlan 2 bridge 3 state enable	Enable the state of VLAN 2 on bridge 3. Specifying an enable state allows forwarding of frames over VLAN 2 on bridge 3.
Bridge3(config-vlan)#vlan 3 bridge 3 state enable	Enable the state of VLAN 3 on bridge 3. Specifying an enable state allows forwarding of frames over VLAN 3 on bridge 3.
Bridge3(config-vlan)#vlan 4 bridge 3 state enable	Enable the state of VLAN 4 on bridge 3. Specifying an enable state allows forwarding of frames over VLAN 4 on bridge 3.
Bridge3(config-vlan)#vlan 5 bridge 3 state enable	Enable the state of VLAN 5 on bridge 3. Specifying an enable state allows forwarding of frames over VLAN 5 on bridge 3.
Bridge3(config-vlan)#exit	Exit the VLAN configuration mode.
Bridge3(config)#spanning-tree mst configuration	Enter the Multiple Spanning Tree Configuration mode.
Bridge3(config-mst)#bridge 3 instance 2 vlan 2	Create an instance of VLAN. The VLANs must be created before being associating with an MST instance (MSTI). If the VLAN range is not specified the MSTI will not be created.
Bridge3(config-mst)#bridge 3 instance 3 vlan 3	same as mention above.
Bridge3(config-mst)#bridge 3 instance 4 vlan 4	same as mention above.
Bridge3(config-mst)#bridge 3 instance 5 vlan 5	same as mention above.
Bridge3(config-mst)#exit	Exit MST Configuration mode.
Bridge3(config)#interface eth2	Enter interface mode for eth2
Bridge3(config-if)#bridge-group 3	Associating the interface to bridge-group 3
Bridge3(config-if)#bridge-group 3 instance 2	Assigning bridge-group 3 to this instance
Bridge3(config-if)#bridge-group 3 instance 3	Assigning bridge-group 3 to this instance
Bridge3(config-if)#bridge-group 3 instance 4	Assigning bridge-group 3 to this instance
Bridge3(config-if)#bridge-group 3 instance 5	Assigning bridge-group 3 to this instance
Bridge3(config-if)#exit	Exit interface mode.
Bridge3(config)#interface eth3	Enter interface mode for eth3
Bridge3(config-if)#bridge-group 3	Associating the interface to bridge-group 3

## MSTP Configuration

Bridge3(config-if)#bridge-group 3 instance 2	Assigning bridge-group 3 to this instance
Bridge3(config-if)#bridge-group 3 instance 3	Assigning bridge-group 3 to this instance
Bridge3(config-if)#bridge-group 3 instance 4	Assigning bridge-group 3 to this instance
Bridge3(config-if)#bridge-group 3 instance 5	Assigning bridge-group 3 to this instance
Bridge3(config-if)#exit	Exit interface mode.

## Bridge 4

Bridge4#configure terminal	Enter configure mode.
Bridge4(config)#bridge 4 protocol mstp	Add a bridge (4) to the multiple spanning tree table
Bridge4(config)#vlan database	Enter the VLAN configuration mode.
Bridge4(config-vlan)#vlan 2 bridge 4 state enable	Enable the state of VLAN 2 on bridge 4. Specifying an enable state allows forwarding of frames over VLAN 2 on bridge 4.
Bridge4(config-vlan)#vlan 3 bridge 4 state enable	Enable the state of VLAN 3 on bridge 4. Specifying an enable state allows forwarding of frames over VLAN 3 on bridge 4.
Bridge4(config-vlan)#vlan 4 bridge 4 state enable	Enable the state of VLAN 4 on bridge 4. Specifying an enable state allows forwarding of frames over VLAN 4 on bridge 4.
Bridge4(config-vlan)#vlan 5 bridge 4 state enable	Enable the state of VLAN 5 on bridge 4. Specifying an enable state allows forwarding of frames over VLAN 5 on bridge 4.
Bridge4(config-vlan)#exit	Exit the VLAN configuration mode.
Bridge4(config)#spanning-tree mst configuration	Enter the Multiple Spanning Tree Configuration mode.
Bridge4(config-mst)#bridge 4 instance 2 vlan 2	Create an instance of VLAN. The VLANs must be created before being associating with an MST instance (MSTI). If the VLAN range is not specified the MSTI will not be created.
Bridge4(config-mst)#bridge 4 instance 3 vlan 3	same as mention above.
Bridge4(config-mst)#bridge 4 instance 4 vlan 4	same as mention above.
Bridge4(config-mst)#bridge 4 instance 5 vlan 5	same as mention above.
Bridge4(config-mst)#exit	Exit MST Configuration mode.
Bridge4(config)#interface eth2	Enter interface mode for eth2
Bridge4(config-if)#bridge-group 4	Associating the interface to bridge-group 4
Bridge4(config-if)#bridge-group 4 instance 2	Assigning bridge-group 4 to this instance
Bridge4(config-if)#bridge-group 4 instance 3	Assigning bridge-group 4 to this instance
Bridge4(config-if)#bridge-group 4 instance 4	Assigning bridge-group 4 to this instance
Bridge4(config-if)#bridge-group 4 instance 5	Assigning bridge-group 4 to this instance
Bridge4(config-if)#exit	Exit interface mode.
Bridge4(config)#interface eth3	Enter interface mode for eth3

Bridge4 (config-if) #bridge-group 4	Associating the interface to bridge-group 4
Bridge4 (config-if) #bridge-group 4 instance 2	Assigning bridge-group 4 to this instance
Bridge4 (config-if) #bridge-group 4 instance 3	Assigning bridge-group 4 to this instance
Bridge4 (config-if) #bridge-group 4 instance 4	Assigning bridge-group 4 to this instance
Bridge4 (config-if) #bridge-group 4 instance 5	Assigning bridge-group 4 to this instance
Bridge4 (config-if) #exit	Exit interface mode.
Bridge4 (config) #interface eth4	Enter interface mode for eth4
Bridge4 (config-if) #bridge-group 4	Associating the interface to bridge-group 4
Bridge4 (config-if) #bridge-group 4 instance 2	Assigning bridge-group 4 to this instance
Bridge4 (config-if) #bridge-group 4 instance 3	Assigning bridge-group 4 to this instance
Bridge4 (config-if) #bridge-group 4 instance 4	Assigning bridge-group 4 to this instance
Bridge4 (config-if) #bridge-group 4 instance 5	Assigning bridge-group 4 to this instance
Bridge4 (config-if) #exit	Exit interface mode.
Bridge4 (config) #interface eth5	Enter interface mode for eth5
Bridge4 (config-if) #bridge-group 4	Associating the interface to bridge-group 4
Bridge4 (config-if) #bridge-group 4 instance 2	Assigning bridge-group 4 to this instance
Bridge4 (config-if) #bridge-group 4 instance 3	Assigning bridge-group 4 to this instance
Bridge4 (config-if) #bridge-group 4 instance 4	Assigning bridge-group 4 to this instance
Bridge4 (config-if) #bridge-group 4 instance 5	Assigning bridge-group 4 to this instance
Bridge4 (config-if) #exit	Exit interface mode.

## Validation

show spanning-tree, show spanning-tree mst detail

```
#show spanning-tree mst detail
% 1: Bridge up - Spanning Tree Enabled - topology change detected
% 1: CIST Root Path Cost 0 - CIST Root Port 3 - CIST Bridge Priority 32768
% 1: Forward Delay 15 - Hello Time 2 - Max Age 20 - Transmit Hold Count 6 -
Max-hops 20
% 1: CIST Root Id 1000525400d15789
% 1: CIST Reg Root Id 1000525400d15789
% 1: CIST Bridge Id 8000525400244323
% 1: 26 topology change(s) - last topology change Mon Mar 4 12:58:35 2019

% 1: portfast bpdu-filter disabled
% 1: portfast bpdu-guard disabled
% 1: portfast errdisable timeout disabled
```

## MSTP Configuration

---

```
% 1: portfast errdisable timeout interval 300 sec
% eth1: Port Number 3 - Ifindex 3 - Port Id 0x8003 - Role Rootport - State
Forwarding
% eth1: Designated External Path Cost 0 -Internal Path Cost 20000
% eth1: Configured Path Cost 20000 - Add type Explicit ref count 5
% eth1: Designated Port Id 0x8003 - CIST Priority 128 -
% eth1: CIST Root 1000525400d15789
% eth1: Regional Root 1000525400d15789
% eth1: Designated Bridge 1000525400d15789
% eth1: Message Age 0 - Max Age 20
% eth1: CIST Hello Time 2 - Forward Delay 15
% eth1: CIST Forward Timer 0 - Msg Age Timer 5 - Hello Timer 0 - topo change
timer 0
% eth1: forward-transitions 1
% eth1: Version Multiple Spanning Tree Protocol - Received MSTP - Send MSTP
% eth1: No portfast configured - Current portfast off
% eth1: bpdu-guard default - Current bpdu-guard off
% eth1: bpdu-filter default - Current bpdu-filter off
% eth1: no root guard configured - Current root guard off
% eth1: Configured Link Type point-to-point - Current point-to-point
% eth1: No auto-edge configured - Current port Auto Edge off
%
% eth2: Port Number 4 - Ifindex 4 - Port Id 0x8004 - Role Alternate - State
Discarding
% eth2: Designated External Path Cost 0 -Internal Path Cost 20000
% eth2: Configured Path Cost 20000 - Add type Explicit ref count 5
% eth2: Designated Port Id 0x8004 - CIST Priority 128 -
% eth2: CIST Root 1000525400d15789
% eth2: Regional Root 1000525400d15789
% eth2: Designated Bridge 1000525400d15789
% eth2: Message Age 0 - Max Age 20
% eth2: CIST Hello Time 2 - Forward Delay 15
% eth2: CIST Forward Timer 0 - Msg Age Timer 5 - Hello Timer 1 - topo change
timer 0
% eth2: forward-transitions 2
% eth2: Version Multiple Spanning Tree Protocol - Received MSTP - Send MSTP
% eth2: No portfast configured - Current portfast off
% eth2: bpdu-guard default - Current bpdu-guard off
% eth2: bpdu-filter default - Current bpdu-filter off
% eth2: no root guard configured - Current root guard off
% eth2: Configured Link Type point-to-point - Current point-to-point
% eth2: No auto-edge configured - Current port Auto Edge off
%
% eth3: Port Number 5 - Ifindex 5 - Port Id 0x8005 - Role Designated - State
Forwarding
% eth3: Designated External Path Cost 0 -Internal Path Cost 20000
% eth3: Configured Path Cost 20000 - Add type Explicit ref count 5
% eth3: Designated Port Id 0x8005 - CIST Priority 128 -
% eth3: CIST Root 1000525400d15789
% eth3: Regional Root 1000525400d15789
% eth3: Designated Bridge 8000525400244323
% eth3: Message Age 0 - Max Age 20
% eth3: CIST Hello Time 2 - Forward Delay 15
% eth3: CIST Forward Timer 0 - Msg Age Timer 0 - Hello Timer 1 - topo change
timer 0
% eth3: forward-transitions 3
% eth3: Version Multiple Spanning Tree Protocol - Received None - Send MSTP
% eth3: No portfast configured - Current portfast off
```

```
% eth3: bpdu-guard default - Current bpdu-guard off
% eth3: bpdu-filter default - Current bpdu-filter off
% eth3: no root guard configured - Current root guard off
% eth3: Configured Link Type point-to-point - Current point-to-point
% eth3: No auto-edge configured - Current port Auto Edge off
%
% eth4: Port Number 6 - Ifindex 6 - Port Id 0x8006 - Role Designated - State
Forwarding
% eth4: Designated External Path Cost 0 -Internal Path Cost 20000
% eth4: Configured Path Cost 20000 - Add type Explicit ref count 5
% eth4: Designated Port Id 0x8006 - CIST Priority 128 -
% eth4: CIST Root 1000525400d15789
% eth4: Regional Root 1000525400d15789
% eth4: Designated Bridge 8000525400244323
% eth4: Message Age 0 - Max Age 20
% eth4: CIST Hello Time 2 - Forward Delay 15
% eth4: CIST Forward Timer 0 - Msg Age Timer 0 - Hello Timer 1 - topo change
timer 0
% eth4: forward-transitions 3
% eth4: Version Multiple Spanning Tree Protocol - Received None - Send MSTP
% eth4: No portfast configured - Current portfast off
% eth4: bpdu-guard default - Current bpdu-guard off
% eth4: bpdu-filter default - Current bpdu-filter off
% eth4: no root guard configured - Current root guard off
% eth4: Configured Link Type point-to-point - Current point-to-point
% eth4: No auto-edge configured - Current port Auto Edge off
%
% Instance 2: Vlans: 2
%
% 1: MSTI Root Path Cost 0 -MSTI Root Port 0 - MSTI Bridge Priority 32768
% 1: MSTI Root Id 8002525400244323
% 1: MSTI Bridge Id 8002525400244323
% eth1: Port Number 3 - Ifindex 3 - Port Id 0x8003 - Role Designated - State
Forwarding
% eth1: Designated Internal Path Cost 0 - Designated Port Id 0x8003
% eth1: Configured Internal Path Cost 20000
% eth1: Configured CST External Path cost 20000
% eth1: CST Priority 128 - MSTI Priority 128
% eth1: Designated Root 8002525400244323
% eth1: Designated Bridge 8002525400244323
% eth1: Message Age 0
% eth1: Hello Time 2 - Forward Delay 15
% eth1: Forward Timer 0 - Msg Age Timer 0 - Hello Timer 0
%
% eth2: Port Number 4 - Ifindex 4 - Port Id 0x8004 - Role Designated - State
Forwarding
% eth2: Designated Internal Path Cost 0 - Designated Port Id 0x8004
% eth2: Configured Internal Path Cost 20000
% eth2: Configured CST External Path cost 20000
% eth2: CST Priority 128 - MSTI Priority 128
% eth2: Designated Root 8002525400244323
% eth2: Designated Bridge 8002525400244323
% eth2: Message Age 0
% eth2: Hello Time 2 - Forward Delay 15
% eth2: Forward Timer 0 - Msg Age Timer 0 - Hello Timer 1
```

## MSTP Configuration

---

```
% eth3: Port Number 5 - Ifindex 5 - Port Id 0x8005 - Role Designated - State
Forwarding
% eth3: Designated Internal Path Cost 0 - Designated Port Id 0x8005
% eth3: Configured Internal Path Cost 20000
% eth3: Configured CST External Path cost 20000
% eth3: CST Priority 128 - MSTI Priority 128
% eth3: Designated Root 8002525400244323
% eth3: Designated Bridge 8002525400244323
% eth3: Message Age 0
% eth3: Hello Time 2 - Forward Delay 15
% eth3: Forward Timer 0 - Msg Age Timer 0 - Hello Timer 1

% eth4: Port Number 6 - Ifindex 6 - Port Id 0x8006 - Role Designated - State
Forwarding
% eth4: Designated Internal Path Cost 0 - Designated Port Id 0x8006
% eth4: Configured Internal Path Cost 20000
% eth4: Configured CST External Path cost 20000
% eth4: CST Priority 128 - MSTI Priority 128
% eth4: Designated Root 8002525400244323
% eth4: Designated Bridge 8002525400244323
% eth4: Message Age 0
% eth4: Hello Time 2 - Forward Delay 15
% eth4: Forward Timer 0 - Msg Age Timer 0 - Hello Timer 1

% Instance 3: Vlans: 3

% 1: MSTI Root Path Cost 0 -MSTI Root Port 0 - MSTI Bridge Priority 32768
% 1: MSTI Root Id 8003525400244323
% 1: MSTI Bridge Id 8003525400244323
% eth1: Port Number 3 - Ifindex 3 - Port Id 0x8003 - Role Masterport - State
Forwarding
% eth1: Designated Internal Path Cost 0 - Designated Port Id 0x8003
% eth1: Configured Internal Path Cost 20000
% eth1: Configured CST External Path cost 20000
% eth1: CST Priority 128 - MSTI Priority 128
% eth1: Designated Root 8003525400244323
% eth1: Designated Bridge 8003525400244323
% eth1: Message Age 0
% eth1: Hello Time 2 - Forward Delay 15
% eth1: Forward Timer 0 - Msg Age Timer 0 - Hello Timer 0

% eth2: Port Number 4 - Ifindex 4 - Port Id 0x8004 - Role Designated - State
Forwarding
% eth2: Designated Internal Path Cost 0 - Designated Port Id 0x8004
% eth2: Configured Internal Path Cost 20000
% eth2: Configured CST External Path cost 20000
% eth2: CST Priority 128 - MSTI Priority 128
% eth2: Designated Root 8003525400244323
% eth2: Designated Bridge 8003525400244323
% eth2: Message Age 0
% eth2: Hello Time 2 - Forward Delay 15
% eth2: Forward Timer 0 - Msg Age Timer 0 - Hello Timer 1

% eth3: Port Number 5 - Ifindex 5 - Port Id 0x8005 - Role Designated - State
Forwarding
% eth3: Designated Internal Path Cost 0 - Designated Port Id 0x8005
% eth3: Configured Internal Path Cost 20000
```

---

```
% eth3: Configured CST External Path cost 20000
% eth3: CST Priority 128 - MSTI Priority 128
% eth3: Designated Root 8003525400244323
% eth3: Designated Bridge 8003525400244323
% eth3: Message Age 0
% eth3: Hello Time 2 - Forward Delay 15
% eth3: Forward Timer 0 - Msg Age Timer 0 - Hello Timer 1

% eth4: Port Number 6 - Ifindex 6 - Port Id 0x8006 - Role Designated - State
Forwarding
% eth4: Designated Internal Path Cost 0 - Designated Port Id 0x8006
% eth4: Configured Internal Path Cost 20000
% eth4: Configured CST External Path cost 20000
% eth4: CST Priority 128 - MSTI Priority 128
% eth4: Designated Root 8003525400244323
% eth4: Designated Bridge 8003525400244323
% eth4: Message Age 0
% eth4: Hello Time 2 - Forward Delay 15
% eth4: Forward Timer 0 - Msg Age Timer 0 - Hello Timer 1

% Instance 4: Vlans: 4

% 1: MSTI Root Path Cost 0 -MSTI Root Port 0 - MSTI Bridge Priority 32768
% 1: MSTI Root Id 8004525400244323
% 1: MSTI Bridge Id 8004525400244323
% eth1: Port Number 3 - Ifindex 3 - Port Id 0x8003 - Role Masterport - State
Forwarding
% eth1: Designated Internal Path Cost 0 - Designated Port Id 0x8003
% eth1: Configured Internal Path Cost 20000
% eth1: Configured CST External Path cost 20000
% eth1: CST Priority 128 - MSTI Priority 128
% eth1: Designated Root 8004525400244323
% eth1: Designated Bridge 8004525400244323
% eth1: Message Age 0
% eth1: Hello Time 2 - Forward Delay 15
% eth1: Forward Timer 0 - Msg Age Timer 0 - Hello Timer 0

% eth2: Port Number 4 - Ifindex 4 - Port Id 0x8004 - Role Designated - State
Forwarding
% eth2: Designated Internal Path Cost 0 - Designated Port Id 0x8004
% eth2: Configured Internal Path Cost 20000
% eth2: Configured CST External Path cost 20000
% eth2: CST Priority 128 - MSTI Priority 128
% eth2: Designated Root 8004525400244323
% eth2: Designated Bridge 8004525400244323
% eth2: Message Age 0
% eth2: Hello Time 2 - Forward Delay 15
% eth2: Forward Timer 0 - Msg Age Timer 0 - Hello Timer 1

% eth3: Port Number 5 - Ifindex 5 - Port Id 0x8005 - Role Designated - State
Forwarding
% eth3: Designated Internal Path Cost 0 - Designated Port Id 0x8005
% eth3: Configured Internal Path Cost 20000
% eth3: Configured CST External Path cost 20000
% eth3: CST Priority 128 - MSTI Priority 128
% eth3: Designated Root 8004525400244323
```

## MSTP Configuration

---

```
% eth3: Designated Bridge 8004525400244323
% eth3: Message Age 0
% eth3: Hello Time 2 - Forward Delay 15
% eth3: Forward Timer 0 - Msg Age Timer 0 - Hello Timer 1

% eth4: Port Number 6 - Ifindex 6 - Port Id 0x8006 - Role Designated - State
Forwarding
% eth4: Designated Internal Path Cost 0 - Designated Port Id 0x8006
% eth4: Configured Internal Path Cost 20000
% eth4: Configured CST External Path cost 20000
% eth4: CST Priority 128 - MSTI Priority 128
% eth4: Designated Root 8004525400244323
% eth4: Designated Bridge 8004525400244323
% eth4: Message Age 0
% eth4: Hello Time 2 - Forward Delay 15
% eth4: Forward Timer 0 - Msg Age Timer 0 - Hello Timer 1

% Instance 5: Vlans: 5

% 1: MSTI Root Path Cost 0 -MSTI Root Port 0 - MSTI Bridge Priority 32768
% 1: MSTI Root Id 8005525400244323
% 1: MSTI Bridge Id 8005525400244323
% eth1: Port Number 3 - Ifindex 3 - Port Id 0x8003 - Role Masterport - State
Forwarding
% eth1: Designated Internal Path Cost 0 - Designated Port Id 0x8003
% eth1: Configured Internal Path Cost 20000
% eth1: Configured CST External Path cost 20000
% eth1: CST Priority 128 - MSTI Priority 128
% eth1: Designated Root 8005525400244323
% eth1: Designated Bridge 8005525400244323
% eth1: Message Age 0
% eth1: Hello Time 2 - Forward Delay 15
% eth1: Forward Timer 0 - Msg Age Timer 0 - Hello Timer 0

% eth2: Port Number 4 - Ifindex 4 - Port Id 0x8004 - Role Designated - State
Forwarding
% eth2: Designated Internal Path Cost 0 - Designated Port Id 0x8004
% eth2: Configured Internal Path Cost 20000
% eth2: Configured CST External Path cost 20000
% eth2: CST Priority 128 - MSTI Priority 128
% eth2: Designated Root 8005525400244323
% eth2: Designated Bridge 8005525400244323
% eth2: Message Age 0
% eth2: Hello Time 2 - Forward Delay 15
% eth2: Forward Timer 0 - Msg Age Timer 0 - Hello Timer 1

% eth3: Port Number 5 - Ifindex 5 - Port Id 0x8005 - Role Designated - State
Forwarding
% eth3: Designated Internal Path Cost 0 - Designated Port Id 0x8005
% eth3: Configured Internal Path Cost 20000
% eth3: Configured CST External Path cost 20000
% eth3: CST Priority 128 - MSTI Priority 128
% eth3: Designated Root 8005525400244323
% eth3: Designated Bridge 8005525400244323
% eth3: Message Age 0
% eth3: Hello Time 2 - Forward Delay 15
```



```
% eth3: Forward Timer 0 - Msg Age Timer 0 - Hello Timer 1

% eth4: Port Number 6 - Ifindex 6 - Port Id 0x8006 - Role Designated - State
Forwarding
% eth4: Designated Internal Path Cost 0 - Designated Port Id 0x8006
% eth4: Configured Internal Path Cost 20000
% eth4: Configured CST External Path cost 20000
% eth4: CST Priority 128 - MSTI Priority 128
% eth4: Designated Root 8005525400244323
% eth4: Designated Bridge 8005525400244323
% eth4: Message Age 0
% eth4: Hello Time 2 - Forward Delay 15
% eth4: Forward Timer 0 - Msg Age Timer 0 - Hello Timer 1

#show spanning-tree
% 1: Bridge up - Spanning Tree Enabled - topology change detected
% 1: CIST Root Path Cost 0 - CIST Root Port 3 - CIST Bridge Priority 32768
% 1: Forward Delay 15 - Hello Time 2 - Max Age 20 - Transmit Hold Count 6 -
Max-hops 20
% 1: CIST Root Id 1000525400d15789
% 1: CIST Reg Root Id 1000525400d15789
% 1: CIST Bridge Id 8000525400244323
% 1: 26 topology change(s) - last topology change Mon Mar 4 12:58:35 2019

% 1: portfast bpdu-filter disabled
% 1: portfast bpdu-guard disabled
% 1: portfast errdisable timeout disabled
% 1: portfast errdisable timeout interval 300 sec
% eth1: Port Number 3 - Ifindex 3 - Port Id 0x8003 - Role Rootport - State
Forwarding
% eth1: Designated External Path Cost 0 -Internal Path Cost 20000
% eth1: Configured Path Cost 20000 - Add type Explicit ref count 5
% eth1: Designated Port Id 0x8003 - CIST Priority 128 -
% eth1: CIST Root 1000525400d15789
% eth1: Regional Root 1000525400d15789
% eth1: Designated Bridge 1000525400d15789
% eth1: Message Age 0 - Max Age 20
% eth1: CIST Hello Time 2 - Forward Delay 15
% eth1: CIST Forward Timer 0 - Msg Age Timer 5 - Hello Timer 1 - topo change
timer 0
% eth1: forward-transitions 1
% eth1: Version Multiple Spanning Tree Protocol - Received MSTP - Send MSTP
% eth1: No portfast configured - Current portfast off
% eth1: bpdu-guard default - Current bpdu-guard off
% eth1: bpdu-filter default - Current bpdu-filter off
% eth1: no root guard configured - Current root guard off
% eth1: Configured Link Type point-to-point - Current point-to-point
% eth1: No auto-edge configured - Current port Auto Edge off
%
% eth2: Port Number 4 - Ifindex 4 - Port Id 0x8004 - Role Alternate - State
Discarding
% eth2: Designated External Path Cost 0 -Internal Path Cost 20000
% eth2: Configured Path Cost 20000 - Add type Explicit ref count 5
% eth2: Designated Port Id 0x8004 - CIST Priority 128 -
% eth2: CIST Root 1000525400d15789
% eth2: Regional Root 1000525400d15789
% eth2: Designated Bridge 1000525400d15789
```

## MSTP Configuration

---

```
% eth2: Message Age 0 - Max Age 20
% eth2: CIST Hello Time 2 - Forward Delay 15
% eth2: CIST Forward Timer 0 - Msg Age Timer 5 - Hello Timer 0 - topo change
timer 0
% eth2: forward-transitions 2
% eth2: Version Multiple Spanning Tree Protocol - Received MSTP - Send MSTP
% eth2: No portfast configured - Current portfast off
% eth2: bpdu-guard default - Current bpdu-guard off
% eth2: bpdu-filter default - Current bpdu-filter off
% eth2: no root guard configured - Current root guard off
% eth2: Configured Link Type point-to-point - Current point-to-point
% eth2: No auto-edge configured - Current port Auto Edge off
%
% eth3: Port Number 5 - Ifindex 5 - Port Id 0x8005 - Role Designated - State
Forwarding
% eth3: Designated External Path Cost 0 -Internal Path Cost 20000
% eth3: Configured Path Cost 20000 - Add type Explicit ref count 5
% eth3: Designated Port Id 0x8005 - CIST Priority 128 -
% eth3: CIST Root 1000525400d15789
% eth3: Regional Root 1000525400d15789
% eth3: Designated Bridge 8000525400244323
% eth3: Message Age 0 - Max Age 20
% eth3: CIST Hello Time 2 - Forward Delay 15
% eth3: CIST Forward Timer 0 - Msg Age Timer 0 - Hello Timer 1 - topo change
timer 0
% eth3: forward-transitions 3
% eth3: Version Multiple Spanning Tree Protocol - Received None - Send MSTP
% eth3: No portfast configured - Current portfast off
% eth3: bpdu-guard default - Current bpdu-guard off
% eth3: bpdu-filter default - Current bpdu-filter off
% eth3: no root guard configured - Current root guard off
% eth3: Configured Link Type point-to-point - Current point-to-point
% eth3: No auto-edge configured - Current port Auto Edge off
%
% eth4: Port Number 6 - Ifindex 6 - Port Id 0x8006 - Role Designated - State
Forwarding
% eth4: Designated External Path Cost 0 -Internal Path Cost 20000
% eth4: Configured Path Cost 20000 - Add type Explicit ref count 5
% eth4: Designated Port Id 0x8006 - CIST Priority 128 -
% eth4: CIST Root 1000525400d15789
% eth4: Regional Root 1000525400d15789
% eth4: Designated Bridge 8000525400244323
% eth4: Message Age 0 - Max Age 20
% eth4: CIST Hello Time 2 - Forward Delay 15
% eth4: CIST Forward Timer 0 - Msg Age Timer 0 - Hello Timer 0 - topo change
timer 0
% eth4: forward-transitions 3
% eth4: Version Multiple Spanning Tree Protocol - Received None - Send MSTP
% eth4: No portfast configured - Current portfast off
% eth4: bpdu-guard default - Current bpdu-guard off
% eth4: bpdu-filter default - Current bpdu-filter off
% eth4: no root guard configured - Current root guard off
% eth4: Configured Link Type point-to-point - Current point-to-point
% eth4: No auto-edge configured - Current port Auto Edge off%
#
```

## CHAPTER 6 Disable Spanning Tree Configuration

This chapter describes disabling spanning tree operation on a per Multiple Spanning Tree Instance (MSTI) basis.

### Topology

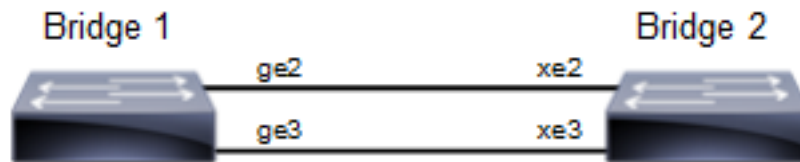

Figure 6-6: Disable Spanning Tree Topology

Note: Run the `switchport` command on each port to change to Layer-2 mode.

### Disabling MSTP Configuration

#### Bridge 1

##### Disabling MSTP per instance

<code>Bridge1(config-mst)#no bridge 1 instance 2</code>	Disable spanning tree for MSTP on instance 2
<code>Bridge1(config-mst)#no bridge 1 instance 3</code>	Disable spanning tree for MSTP on instance 3

##### Disabling MSTP globally

<code>Bridge1(config)#no bridge 1 multiple-spanning-tree enable bridge-forward</code>	Disable spanning tree globally for MSTP and keeping the ports in forwarding state.
---	--

##### Disabling MSTP per port

<code>Bridge1(config)#interface ge2</code>	Enter interface mode for ge2.
<code>Bridge1(config-if)#bridge-group 1 spanning-tree disable</code>	Disable spanning tree per port for MSTP and put port on forwarding state. This command disables any type of STP on the port.

#### Bridge 2

##### Disabling MSTP per instance

<code>Bridge2(config-mst)#no bridge 1 instance 2</code>	Disable spanning tree for MSTP on instance 2
<code>Bridge2(config-mst)#no bridge 1 instance 3</code>	Disable spanning tree for MSTP on instance 3

## Disabling MSTP globally

Bridge2(config)#no bridge 1 multiple-spanning-tree enable bridge-forward	Disable spanning tree globally for MSTP.
--	--

## Disabling MSTP per port

Bridge2(config)#interface xe2	Enter interface mode for xe2.
Bridge2(config-if)#bridge-group 1 spanning-tree disable	Disable spanning tree per port for MSTP and put port on forwarding state. This command disables any type of STP on the port.

---

## Validation

### Bridge 1

Verify MSTP details with the show spanning-tree mst detail command.

```
#show spanning-tree mst detail
% 1: Bridge up - Spanning Tree Enabled - topology change detected
% 1: CIST Root Path Cost 0 - CIST Root Port 905 - CIST Bridge Priority 32768
% 1: Forward Delay 15 - Hello Time 2 - Max Age 20 - Transmit Hold Count 6 -
Max-hops 20
% 1: CIST Root Id 80003417ebfbe9c4
% 1: CIST Reg Root Id 80003417ebfbe9c4
% 1: CIST Bridge Id 800064006ac779a0
% 1: 9 topology change(s) - last topology change Thu Nov 17 15:06:17 2016
% 1: portfast bpdu-filter disabled
% 1: portfast bpdu-guard disabled
% 1: portfast errdisable timeout disabled
% 1: portfast errdisable timeout interval 300 sec
% ge2: Port Number 905 - Ifindex 5001 - Port Id 0x8389 - Role Rootport -
State Forwarding
% ge2: Designated External Path Cost 0 -Internal Path Cost 20000
% ge2: Configured Path Cost 20000 - Add type Explicit ref count 2
% ge2: Designated Port Id 0x838a - CIST Priority 128 -
% ge2: CIST Root 80003417ebfbe9c4
% ge2: Regional Root 80003417ebfbe9c4
% ge2: Designated Bridge 80003417ebfbe9c4
% ge2: Message Age 0 - Max Age 20
% ge2: CIST Hello Time 2 - Forward Delay 15
% ge2: CIST Forward Timer 0 - Msg Age Timer 4 - Hello Timer 0 - topo change
timer 0
% ge2: forward-transitions 1
% ge2: Version Multiple Spanning Tree Protocol - Received MSTP - Send MSTP
% ge2: No portfast configured - Current portfast off
% ge2: bpdu-guard default - Current bpdu-guard off
% ge2: bpdu-filter default - Current bpdu-filter off
% ge2: no root guard configured - Current root guard off
% ge2: Configured Link Type point-to-point - Current point-to-point
% ge2: No auto-edge configured - Current port Auto Edge off
%
% ge3: Port Number 908 - Ifindex 5004 - Port Id 0x838c - Role Alternate -
State Discarding
% ge3: Designated External Path Cost 0 -Internal Path Cost 20000
```

```

% ge3: Configured Path Cost 20000 - Add type Explicit ref count 2
% ge3: Designated Port Id 0x838b - CIST Priority 128 -
% ge3: CIST Root 80003417ebfbe9c4
% ge3: Regional Root 80003417ebfbe9c4
% ge3: Designated Bridge 80003417ebfbe9c4
% ge3: Message Age 0 - Max Age 20
% ge3: CIST Hello Time 2 - Forward Delay 15
% ge3: CIST Forward Timer 0 - Msg Age Timer 5 - Hello Timer 1 - topo change
timer 0
% ge3: forward-transitions 2
% ge3: Version Multiple Spanning Tree Protocol - Received MSTP - Send MSTP
% ge3: No portfast configured - Current portfast off
% ge3: bpdu-guard default - Current bpdu-guard off
% ge3: bpdu-filter default - Current bpdu-filter off
% ge3: no root guard configured - Current root guard off
% ge3: Configured Link Type point-to-point - Current point-to-point
% ge3: No auto-edge configured - Current port Auto Edge off

% Instance 2: Vlans: 2

% 1: MSTI Root Path Cost 20000 -MSTI Root Port 5001 - MSTI Bridge Priority
32768
% 1: MSTI Root Id 80023417ebfbe9c4
% 1: MSTI Bridge Id 800264006ac779a0
% ge2: Port Number 905 - Ifindex 5001 - Port Id 0x8389 - Role Rootport -
State Forwarding
% ge2: Designated Internal Path Cost 0 - Designated Port Id 0x838a
% ge2: Configured Internal Path Cost 20000
% ge2: Configured CST External Path cost 20000
% ge2: CST Priority 128 - MSTI Priority 128
% ge2: Designated Root 80023417ebfbe9c4
% ge2: Designated Bridge 800264006ac779a0
% ge2: Message Age 0
% ge2: Hello Time 2 - Forward Delay 15
% ge2: Forward Timer 0 - Msg Age Timer 4 - Hello Timer 0

% Instance 3: Vlans: 3

% 1: MSTI Root Path Cost 0 -MSTI Root Port 0 - MSTI Bridge Priority 32768
% 1: MSTI Root Id 800364006ac779a0
% 1: MSTI Bridge Id 800364006ac779a0
% ge3: Port Number 908 - Ifindex 5004 - Port Id 0x838c - Role Designated -
State Forwarding
% ge3: Designated Internal Path Cost 0 - Designated Port Id 0x838c
% ge3: Configured Internal Path Cost 20000
% ge3: Configured CST External Path cost 20000
% ge3: CST Priority 128 - MSTI Priority 128
% ge3: Designated Root 800364006ac779a0
% ge3: Designated Bridge 800364006ac779a0
% ge3: Message Age 0
% ge3: Hello Time 2 - Forward Delay 15
% ge3: Forward Timer 0 - Msg Age Timer 0 - Hello Timer 1

```

Verify MSTP configurations when MSTP is enabled globally.

```

#show running-config
!
bridge 1 protocol mstp
!

```

Verify MSTP configurations when MSTP is disabled globally.

```
#show running-config
!  
bridge 1 protocol mstp  
no bridge 1 multiple-spanning-tree enable bridge-forward  
!
```

Verify MSTP configurations when MSTP instance 2 and 3 is enabled.

```
#show running-config spanning-tree  
!  
spanning-tree mst configuration  
bridge 1 instance 2  
bridge 1 instance 2 vlan 2  
bridge 1 instance 3  
bridge 1 instance 3 vlan 3  
!  
interface xe2  
bridge-group 1 instance 2  
!  
interface xe3  
bridge-group 1 instance 3  
!
```

- Verify MSTP configurations when MSTP instance 2 is disabled

```
#show running-config spanning-tree  
!  
spanning-tree mst configuration  
bridge 1 instance 3  
bridge 1 instance 3 vlan 3  
!  
interface ge3  
bridge-group 1 instance 3  
!
```

Verify MSTP configurations when spanning-tree is enabled on interface.

```
#show running-config interface ge2  
!  
interface ge2  
switchport  
bridge-group 1  
switchport mode access  
switchport access vlan 2  
bridge-group 1 instance 2  
!
```

Verify MSTP configurations when spanning-tree is disabled on interface.

```
#show running-config interface ge2  
!  
interface ge2  
switchport  
bridge-group 1 spanning-tree disable  
switchport mode access  
switchport access vlan 2  
bridge-group 1 instance 2
```

Verify MSTP details after disabling spanning-tree on interface ge2 with the show spanning-tree mst details command.

```
#show spanning-tree mst detail
% 1: Bridge up - Spanning Tree Enabled - topology change detected
% 1: CIST Root Path Cost 0 - CIST Root Port 908 - CIST Bridge Priority 32768
% 1: Forward Delay 15 - Hello Time 2 - Max Age 20 - Transmit Hold Count 6 -
Max-hops 20
% 1: CIST Root Id 80003417ebfbe9c4
% 1: CIST Reg Root Id 80003417ebfbe9c4
% 1: CIST Bridge Id 800064006ac779a0
% 1: 10 topology change(s) - last topology change Fri Nov 25 21:21:05 2016

% 1: portfast bpdu-filter disabled
% 1: portfast bpdu-guard disabled
% 1: portfast errdisable timeout disabled
% 1: portfast errdisable timeout interval 300 sec
% ge2: Port Number 905 - Ifindex 5001 - Port Id 0x8389 - Role Disabled -
State Forwarding
% ge2: Designated External Path Cost 0 -Internal Path Cost 20000
% ge2: Configured Path Cost 20000 - Add type Explicit ref count 2
% ge2: Designated Port Id 0x838a - CIST Priority 128 -
% ge2: Message Age 0 - Max Age 20
% ge2: CIST Hello Time 2 - Forward Delay 15
% ge2: CIST Forward Timer 0 - Msg Age Timer 4 - Hello Timer 0 - topo change
timer 0
% ge2: forward-transitions 2
% ge2: Version Multiple Spanning Tree Protocol - Received MSTP - Send MSTP
% ge2: No portfast configured - Current portfast off
% ge2: bpdu-guard default - Current bpdu-guard off
% ge2: bpdu-filter default - Current bpdu-filter off
% ge2: no root guard configured - Current root guard off
% ge2: Configured Link Type point-to-point - Current point-to-point
% ge2: No auto-edge configured - Current port Auto Edge off
% ge3: Port Number 908 - Ifindex 5004 - Port Id 0x838c - Role Rootport -
State Forwarding
% ge3: Designated External Path Cost 0 -Internal Path Cost 20000
% ge3: Configured Path Cost 20000 - Add type Explicit ref count 2
% ge3: Designated Port Id 0x838b - CIST Priority 128 -
% ge3: CIST Root 80003417ebfbe9c4
% ge3: Regional Root 80003417ebfbe9c4
% ge3: Designated Bridge 80003417ebfbe9c4
% ge3: Message Age 0 - Max Age 20
% ge3: CIST Hello Time 2 - Forward Delay 15
% ge3: CIST Forward Timer 0 - Msg Age Timer 4 - Hello Timer 1 - topo change
timer 0
% ge3: forward-transitions 3
% ge3: Version Multiple Spanning Tree Protocol - Received MSTP - Send MSTP
% ge3: No portfast configured - Current portfast off
% ge3: bpdu-guard default - Current bpdu-guard off
% ge3: bpdu-filter default - Current bpdu-filter off
% ge3: no root guard configured - Current root guard off
% ge3: Configured Link Type point-to-point - Current point-to-point
% ge3: No auto-edge configured - Current port Auto Edge off

% Instance 2: Vlans: 2

% 1: MSTI Root Path Cost 0 -MSTI Root Port 0 - MSTI Bridge Priority 32768
% 1: MSTI Root Id 800264006ac779a0
% 1: MSTI Bridge Id 800264006ac779a0
```

## Disable Spanning Tree Configuration

---

```
% ge2: Port Number 905 - Ifindex 5001 - Port Id 0x8389 - Role Disabled -
State Discarding
% ge2: Designated Internal Path Cost 0 - Designated Port Id 0x8389
% ge2: Configured Internal Path Cost 20000
% ge2: Configured CST External Path cost 20000
% ge2: CST Priority 128 - MSTI Priority 128
% ge2: Designated Root 800264006ac779a0
% ge2: Designated Bridge 800264006ac779a0
% ge2: Message Age 0
% ge2: Hello Time 2 - Forward Delay 15
% ge2: Forward Timer 0 - Msg Age Timer 0 - Hello Timer 0

% Instance 3: Vlans: 3

% 1: MSTI Root Path Cost 20000 -MSTI Root Port 5004 - MSTI Bridge Priority
32768
% 1: MSTI Root Id 80033417ebfbe9c4
% 1: MSTI Bridge Id 800364006ac779a0
% ge3: Port Number 908 - Ifindex 5004 - Port Id 0x838c - Role Rootport -
State Forwarding
% ge3: Designated Internal Path Cost 0 - Designated Port Id 0x838b
% ge3: Configured Internal Path Cost 20000
% ge3: Configured CST External Path cost 20000
% ge3: CST Priority 128 - MSTI Priority 128
% ge3: Designated Root 80033417ebfbe9c4
% ge3: Designated Bridge 800364006ac779a0
% ge3: Message Age 0
% ge3: Hello Time 2 - Forward Delay 15
% ge3: Forward Timer 0 - Msg Age Timer 4 - Hello Timer 1
```

---

## STP Configuration

### Bridge 1

#### Disabling STP globally

Bridge1(config)#no bridge 1 spanning-tree enable bridge-forward	Disable spanning tree globally for STP.
--	---

#### Disabling STP per port

Bridge1(config)#interface ge2	Enter interface mode for ge2.
Bridge1(config-if)#bridge-group 1 spanning-tree disable	Disable spanning tree per port for STP and put port on forwarding state. This command disables any type of STP on the port.

### Bridge 2

#### Disabling STP globally

Bridge2(config)#no bridge 1 spanning-tree enable bridge-forward	Disable spanning tree globally for STP.
--	---



## Disabling STP per port

Bridge2(config)#interface xe2	Enter interface mode for xe2.
Bridge2(config-if)#bridge-group 1 spanning-tree disable	Disable spanning tree per port for STP and put port on forwarding state. This command disables any type of STP on the port.

## Validation

### Bridge 1

Verify STP details when stp is enabled globally and ge2 and ge3 are part of the bridge using the `show spanning-tree` command.

```
#show spanning-tree
% 1: Bridge up - Spanning Tree Enabled - topology change
% 1: Root Path Cost 4 - Priority 32768
% 1: Forward Delay 15 - Hello Time 2 - Max Age 20 - Transmit Hold Count 6 -
Root port 905
% 1: Root Id 80003417ebfbe9c4
% 1: Bridge Id 800064006ac779a0
% 1: 3 topology changes - last topology change Tue Nov 15 21:33:53 2016
% 1: portfast bpdu-filter disabled
% 1: portfast bpdu-guard disabled
% 1: portfast errdisable timeout disabled
% 1: portfast errdisable timeout interval 300 sec

%ge2: Port Number 905 - Ifindex 5001 - Port Id 0x8389 - path cost 4 -
designated cost 0
%ge2: Designated Port Id 0x838a - state Forwarding -Priority 128
%ge2: Designated root 80003417ebfbe9c4
%ge2: Designated Bridge 80003417ebfbe9c4
%ge2: Message Age 0 - Max Age 20
%ge2: Hello Time 2 - Forward Delay 15
%ge2: Forward Timer 0 - Msg Age Timer 18 - Hello Timer 1 - topo change timer0
%ge2: forward-transitions 1
%ge2: No portfast configured - Current portfast
%ge2: bpdu-guard default- Current bpdu-guard off
%ge2: bpdu-filter default- Current bpdu-filter off
%ge2: no root guard configured- Current root guard off
%ge3: Port Number 908 - Ifindex 5004 - Port Id 0x838c - path cost 4 -
designated cost 0
%ge3: Designated Port Id 0x838b - state Blocked -Priority 128
%ge3: Designated root 80003417ebfbe9c4
%ge3: Designated Bridge 80003417ebfbe9c4
%ge3: Message Age 0 - Max Age 20
%ge3: Hello Time 2 - Forward Delay 15
%ge3: Forward Timer 0 - Msg Age Timer 19 - Hello Timer 1 - topo change timer0
%ge3: forward-transitions 0
%ge3: No portfast configured - Currentportfast off
%ge3: bpdu-guarddefault- Current bpdu-guard off
%ge3: bpdu-filter default- Current bpdu-filter off
%ge3: no root guard configured- Current root guard off
%
```

Verify STP configurations when STP is enabled globally.

## Disable Spanning Tree Configuration

---

```
#show running-config
!  
bridge 1 protocol ieee vlan-bridge
!
```

Verify STP configurations when STP is disabled globally.

```
#show running-config
!  
bridge 1 protocol ieee vlan-bridge  
no bridge 1 spanning-tree enable bridge-forward
!
```

Verify STP configurations when spanning-tree is enabled on interface.

```
#show running-config interface ge2
!  
interface ge2  
switchport  
bridge-group 1  
switchport mode trunk  
switchport trunk allowed vlan all
!
```

Verify STP configurations when spanning-tree is disabled on interface.

```
#show running-config interface ge2
!  
interface ge2  
switchport  
bridge-group 1 spanning-tree disable  
switchport mode trunk  
switchport trunk allowed vlan all
!
```

Verify STP details after disabling spanning-tree on interface ge2 with the `show spanning-tree` command.

```
#show spanning-tree
% 1: Bridge up - Spanning Tree Enabled
% 1: Root Path Cost 4 - Priority 32768
% 1: Forward Delay 15 - Hello Time 2 - Max Age 20 - Transmit Hold Count 6 -  
Root port 908
% 1: Root Id 80003417ebfbe9c4
% 1: Bridge Id 800064006ac779a0
% 1: 5 topology changes - last topology change Fri Nov 25 21:15:35 2016
% 1: portfast bpdu-filter disabled
% 1: portfast bpdu-guard disabled
% 1: portfast errdisable timeout disabled
% 1: portfast errdisable timeout interval 300 sec
% ge2: Port Number 905 - Ifindex 5001 - Port Id 0x8389 - path cost 4 -  
designated cost 0
% ge2: Designated Port Id 0x838a - state Disabled -Priority 128
% ge2: Message Age 0 - Max Age 20
% ge2: Hello Time 2 - Forward Delay 15
% ge2: Forward Timer 0 - Msg Age Timer 18 - Hello Timer 0 - topo change  
timer 23
% ge2: forward-transitions 2
% ge2: No portfast configured - Current portfast off
% ge2: bpdu-guard default - Current bpdu-guard off
% ge2: bpdu-filter default - Current bpdu-filter off
% ge2: no root guard configured - Current root guard off
%
```

```
% ge3: Port Number 908 - Ifindex 5004 - Port Id 0x838c - path cost 4 -
designated cost 0
% ge3: Designated Port Id 0x838b - state Forwarding -Priority 128
% ge3: Designated root 80003417ebfbe9c4
% ge3: Designated Bridge 80003417ebfbe9c4
% ge3: Message Age 0 - Max Age 20
% ge3: Hello Time 2 - Forward Delay 15
% ge3: Forward Timer 0 - Msg Age Timer 19 - Hello Timer 1 - topo change
timer 23
% ge3: forward-transitions 2
% ge3: No portfast configured - Current portfast off
% ge3: bpdu-guard default - Current bpdu-guard off
% ge3: bpdu-filter default - Current bpdu-filter off
% ge3: no root guard configured - Current root guard off
```

---

## RSTP Configuration

### Bridge 1

#### Disabling RSTP globally

Bridge1(config)#no bridge 1 rapid-spanning-tree enable bridge-forward	Disable spanning tree globally for RSTP.
---	--

#### Disabling RSTP per port

Bridge1(config)#interface ge2	Enter interface mode for ge2.
Bridge1(config-if)#bridge-group 1 spanning-tree disable	Disable spanning tree per port for RSTP and put port on forwarding state. This command disables any type of STP on the port.

### Bridge 2

#### Disabling RSTP globally

Bridge2(config)#no bridge 1 rapid-spanning-tree enable bridge-forward	Disable spanning tree globally for RSTP.
---	--

#### Disabling RSTP per port

Bridge2(config)#interface xe2	Enter interface mode for xe2.
Bridge2(config-if)#bridge-group 1 spanning-tree disable	Disable spanning tree per port for RSTP and put port on forwarding state. This command disables any type of STP on the port.

## Validation

### Bridge 1

Verify RSTP details when rstp is enabled globally and ge2 and ge3 are part of the bridge using the show spanning-tree command.

```
#show spanning-tree
% 1: Bridge up - Spanning Tree Enabled- topology change detected
% 1: Root Path Cost 20000 - Root Port 905 -Bridge Priority 32768
% 1: Forward Delay 15 - Hello Time 2 - Max Age 20 - Transmit Hold Count 6
% 1: Root Id 80003417ebfbe9c4
% 1: Bridge Id 800064006ac779a0
% 1: last topology change Tue Nov 15 21:44:31 2016
% 1: 7 topology change(s)- last topology change Tue Nov 15 21:44:31 2016
% 1: portfast bpdu-filter disabled
% 1: portfast bpdu-guard disabled
% 1: portfast errdisable timeout disabled
% 1: portfast errdisable timeout interval 300 sec
% ge2: Port Number 905 - Ifindex 5001 - Port Id 0x8389 - Role Rootport - State
Forwarding
% ge2: Designated Path Cost 0
% ge2: Configured Path Cost 20000- Add type Explicit ref count 1
% ge2: Designated Port Id 0x838a - Priority 128-
% ge2: Root 80003417ebfbe9c4
% ge2: Designated Bridge 80003417ebfbe9c4
% ge2: Message Age 0 - Max Age 20
% ge2: Hello Time 2 - Forward Delay 15
% ge2: Forward Timer 0 - Msg Age Timer 4 - Hello Timer 1 - topo change timer
0
% ge2: forward-transitions 1
% ge2: Version Rapid Spanning Tree Protocol - Received RSTP - Send RSTP
% ge2: No portfast configured - Currentportfast off
% ge2: bpdu-guarddefault- Current bpdu-guard off
% ge2: bpdu-filter default- Current bpdu-filter off
% ge2: no root guard configured- Current root guard off
% ge2: Configured Link Type point-to-point - Current point-to-point
% ge2: No auto-edge configured - Current port Auto Edge off
% ge3: Port Number 908 - Ifindex 5004 - Port Id 0x838c - Role Alternate -
State Discarding
% ge3: Designated Path Cost 0
% ge3: Configured Path Cost 20000- Add type Explicit ref count 1
% ge3: Designated Port Id 0x838b - Priority 128-
% ge3: Root 80003417ebfbe9c4
% ge3: Designated Bridge 80003417ebfbe9c4
% ge3: Message Age 0 - Max Age 20
% ge3: Hello Time 2 - Forward Delay 15
% ge3: Forward Timer 0 - Msg Age Timer 5 - Hello Timer 0 - topo change timer
0
% ge3: forward-transitions 2
% ge3: Version Rapid Spanning Tree Protocol - Received RSTP - Send RSTP
% ge3: No portfast configured - Currentportfast off
% ge3: bpdu-guarddefault- Current bpdu-guard off
% ge3: bpdu-filter default- Current bpdu-filter off
% ge3: no root guard configured- Current root guard off
% ge3: Configured Link Type point-to-point - Current point-to-point
% ge3: No auto-edge configured - Current port Auto Edge off
```

---

```
%
```

Verify RSTP configurations when RSTP is enabled globally.

```
#show running-config
!
bridge 1 protocol rstp vlan-bridge
!
```

- Verify RSTP configurations when RSTP is disabled globally

```
#show running-config
!
bridge 1 protocol rstp vlan-bridge
no bridge 1 rapid-spanning-tree enable bridge-forward
!
```

Verify RSTP configurations when spanning-tree is enabled on interface.

```
#show running-config interface ge2
!
interface ge2
switchport
bridge-group 1
switchport mode trunk
switchport trunk allowed vlan all
!
```

Verify RSTP configurations when spanning-tree is disabled on interface.

```
#show running-config interface ge2
!
interface ge2
switchport
bridge-group 1 spanning-tree disable
switchport mode trunk
switchport trunk allowed vlan all
```

Verify RSTP details after disabling spanning-tree on interface ge2 with the show spanning-tree command.

```
#sh spanning-tree
% 1: Bridge up - Spanning Tree Enabled - topology change detected
% 1: Root Path Cost 20000 - Root Port 908 - Bridge Priority 32768
% 1: Forward Delay 15 - Hello Time 2 - Max Age 20 - Transmit Hold Count 6
% 1: Root Id 80003417ebf9c4
% 1: Bridge Id 800064006ac779a0
% 1: last topology change Fri Nov 25 21:08:56 2016
% 1: 11 topology change(s) - last topology change Fri Nov 25 21:08:56 2016
% 1: portfast bpdu-filter disabled
% 1: portfast bpdu-guard disabled
% 1: portfast errdisable timeout disabled
% 1: portfast errdisable timeout interval 300 sec
% ge2: Port Number 905 - Ifindex 5001 - Port Id 0x8389 - Role Disabled -
State Forwarding
% ge2: Designated Path Cost 0
% ge2: Configured Path Cost 20000 - Add type Explicit ref count 1
% ge2: Designated Port Id 0x838a - Priority 128 -
% ge2: Message Age 0 - Max Age 20
% ge2: Hello Time 2 - Forward Delay 15
% ge2: Forward Timer 0 - Msg Age Timer 5 - Hello Timer 0 - topo change timer
0
% ge2: forward-transitions 2
```

## Disable Spanning Tree Configuration

---

```
% ge2: Version Rapid Spanning Tree Protocol - Received RSTP - Send RSTP
% ge2: No portfast configured - Current portfast off
% ge2: bpdu-guard default - Current bpdu-guard off
% ge2: bpdu-filter default - Current bpdu-filter off
% ge2: no root guard configured - Current root guard off
% ge2: Configured Link Type point-to-point - Current point-to-point
% ge2: No auto-edge configured - Current port Auto Edge off
%
% ge3: Port Number 908 - Ifindex 5004 - Port Id 0x838c - Role Rootport -
State Forwarding
% ge3: Designated Path Cost 0
% ge3: Configured Path Cost 20000 - Add type Explicit ref count 1
% ge3: Designated Port Id 0x838b - Priority 128 -
% ge3: Root 80003417ebfbe9c4
% ge3: Designated Bridge 80003417ebfbe9c4
% ge3: Message Age 0 - Max Age 20
% ge3: Hello Time 2 - Forward Delay 15
% ge3: Forward Timer 0 - Msg Age Timer 5 - Hello Timer 1 - topo change timer
0
% ge3: forward-transitions 3
% ge3: Version Rapid Spanning Tree Protocol - Received RSTP - Send RSTP
% ge3: No portfast configured - Current portfast off
% ge3: bpdu-guard default - Current bpdu-guard off
% ge3: bpdu-filter default - Current bpdu-filter off
% ge3: no root guard configured - Current root guard off
% ge3: Configured Link Type point-to-point - Current point-to-point
% ge3: No auto-edge configured - Current port Auto Edge off
```

## CHAPTER 7 RPVST+ Configuration

This chapter contains a complete example of an RPVST+ configuration.

### Topology



Figure 7-7: RPVST+ configuration

### Configuration

#### Switch 2

#configure terminal	Enter configure mode for the switch.
(config)#bridge 1 protocol rpvst+	Configure bridge 1 as an RPVST+ bridge.
(config)#vlan 2-3 bridge 1	Configure VLAN 2 and 3 and associate it to bridge 1.
(config)#spanning-tree rpvst+ configuration	Enter Rapid Per-VLAN Spanning Tree configuration mode.
(config-rpvst+)#bridge 1 vlan 2	Associate a configured VLAN with bridge 1.
(config-rpvst+)#bridge 1 vlan 3	Associate a configured VLAN with bridge 1,.
(config-rvpst+)#exit	Exit RPVST+ configuration mode.
(config)#interface eth1	Enter interface mode for eth1
(config-if)#switchport	Configure eth1 as a Layer 2 port.
(config-if)#bridge-group 1	Associate bridge to interface.
(config-if)#switchport mode trunk	Configure port as trunk.
(config-if)#switchport trunk allowed vlan add 2,3	Configure VLAN 2 and VLAN 3 on interface.
(config-if)#bridge-group 1 vlan 2	Configure bridge group to interface with VLAN 2.
(config-if)#bridge-group 1 vlan 3	Configure bridge group to interface with VLAN 3.
(config-if)#exit	Exit interface mode.
(config)#interface eth2	Enter interface mode for eth2.
(config-if)#switchport	Configure eth2 as a Layer 2 port.
(config-if)#bridge-group 1	Associate bridge to interface/
(config-if)#switchport mode trunk	Configure port as trunk
(config-if)#switchport trunk allowed vlan add 2,3	Configure VLAN 2 and VLAN 3 on interface.
(config-if)#bridge-group 1 vlan 2	Configure bridge group to interface with VLAN 2.
(config-if)#bridge-group 1 vlan 3	Configure bridge group to interface with VLAN3.
(config-if)#exit	Exit interface mode.

### Switch 1

#configure terminal	Enter configure mode for the switch.
(config)#bridge 1 protocol rpvst+	Configure bridge 1 as an rpvst+ bridge.
(config)#vlan 2-3 bridge 1	Configure VLAN 2 and 3 and associate it to bridge 1.
(config)#spanning-tree rpvst+ configuration	Enter Rapid Per-VLAN Spanning Tree configuration mode.
(config-rpvst+)#bridge 1 vlan 2	Associate a configured VLAN with bridge 1.
(config-rpvst+)#bridge 1 vlan 3	Associate a configured VLAN with bridge 1.
(config-rvpst+)#exit	Exit RPVST+ configuration mode.
(config)#interface eth1	Enter interface mode for eth1.
(config-if)#switchport	Configure eth1 as a Layer 2 port.
(config-if)#bridge-group 1	Associate bridge to interface.
(config-if)#switchport mode trunk	Configure port as trunk.
(config-if)#switchport trunk allowed vlan add 2,3	Configure VLAN 2 and VLAN 3 on interface.
(config-if)#bridge-group 1 vlan 2	Configure bridge group to interface with VLAN 2.
(config-if)#bridge-group 1 vlan 3	Configure bridge group to interface with VLAN3.
(config-if)#exit	Exit interface mode.

### Switch 3

#configure terminal	Enter configure mode for the switch.
(config)#bridge 1 protocol rpvst+	Configure bridge 1 as an rpvst+ bridge
(config)#vlan 2-3 bridge 1	Configure VLAN 2 and 3 and associate it to bridge 1.
(config)#interface eth1	Enter interface mode for eth1.
(config-if)#switchport	Configure eth1 as a Layer 2 port.
(config-if)#bridge-group 1	Associate bridge to interface.
(config-if)#switchport mode trunk	Configure port as trunk.
(config-if)#switchport trunk allowed vlan add 2,3	Configure VLAN 2 and VLAN 3 on interface.
(config-if)#exit	Exit interface mode.

## Validation

### Switch2

```
#show spanning-tree rpvst+ vlan 2
% vlan 2 Instance 1 configured
% 1: Root Path Cost 0 - Root Port 0 - Bridge Priority 32768
% 1: Root Id 8002525400b7bfa7
% 1: Bridge Id 8002525400b7bfa7
% eth1: Port Number 3 - Ifindex 3 - Port Id 0x8003 - Role Designated - State Forwarding
```



```
% eth1: Designated Internal Path Cost 0 - Designated Port Id 0x8003
% eth1: Configured Internal Path Cost 200000
% eth1: Configured External Path cost 200000
% eth1: Configured Internal Priority 128
% eth1: Configured External Priority 128
% eth1: Designated Root 8002525400b7bfa7
% eth1: Designated Bridge 8002525400b7bfa7
% eth1: Message Age 0 - Max Age 20
% eth1: Hello Time 2 - Forward Delay 15
% eth1: Forward Timer 0 - Msg Age Timer 0 - Hello Timer 0
%
% eth2: Port Number 4 - Ifindex 4 - Port Id 0x8004 - Role Designated - State
Forwarding
% eth2: Designated Internal Path Cost 0 - Designated Port Id 0x8004
% eth2: Configured Internal Path Cost 200000
% eth2: Configured External Path cost 200000
% eth2: Configured Internal Priority 128
% eth2: Configured External Priority 128
% eth2: Designated Root 8002525400b7bfa7
% eth2: Designated Bridge 8002525400b7bfa7
% eth2: Message Age 0 - Max Age 20
% eth2: Hello Time 2 - Forward Delay 15
% eth2: Forward Timer 0 - Msg Age Timer 0 - Hello Timer 1
%

#show spanning-tree rpvst+ interface eth1
% 1: Bridge up - Spanning Tree Enabled - topology change detected
% 1: Root Path Cost 0 - Root Port 0 - Bridge Priority 32768
% 1: Forward Delay 15 - Hello Time 2 - Max Age 20 - Transmit Hold Count 6
% 1: Root Id 8001525400b7bfa7
% 1: Bridge Id 8001525400b7bfa7
% 1: last topology change Wed Mar 28 15:33:06 2018
% 1: 2 topology change(s) - last topology change Wed Mar 28 15:33:06 2018

% 1: portfast bpdu-filter disabled
% 1: portfast bpdu-guard disabled
% 1: portfast errdisable timeout disabled
% 1: portfast errdisable timeout interval 300 sec
% eth1: Port Number 3 - Ifindex 3 - Port Id 0x8003 - Role Designated - State
Forwarding
% eth1: Designated External Path Cost 0 -Internal Path Cost 0
% eth1: Configured Path Cost 200000 - Add type Explicit ref count 3
% eth1: Designated Port Id 0x8003 - Priority 128 -
% eth1: Root 8001525400b7bfa7
% eth1: Designated Bridge 8001525400b7bfa7
% eth1: Message Age 0 - Max Age 20
% eth1: Hello Time 2 - Forward Delay 15
% eth1: Forward Timer 0 - Msg Age Timer 0 - Hello Timer 2 - topo change timer 0
% eth1: forward-transitions 1
% eth1: Version Rapid Spanning Tree Protocol - Received None - Send RSTP
% eth1: No portfast configured - Current portfast off
```

## RPVST+ Configuration

---

```
% eth1: bpdu-guard default - Current bpdu-guard off
% eth1: bpdu-filter default - Current bpdu-filter off
% eth1: no root guard configured - Current root guard off
% eth1: Configured Link Type point-to-point - Current point-to-point
% eth1: No auto-edge configured - Current port Auto Edge off
%
%
% Instance          VLAN
% 0:                1
% 1:                2
% 2:                3

#show spanning-tree rpvst+ detail
% 1: Bridge up - Spanning Tree Enabled - topology change detected
% 1: Root Path Cost 0 - Root Port 0 - Bridge Priority 32768
% 1: Forward Delay 15 - Hello Time 2 - Max Age 20 - Transmit Hold Count 6
% 1: Root Id 8001525400b7bfa7
% 1: Bridge Id 8001525400b7bfa7
% 1: last topology change Wed Mar 28 15:33:06 2018
% 1: 2 topology change(s) - last topology change Wed Mar 28 15:33:06 2018

% 1: portfast bpdu-filter disabled
% 1: portfast bpdu-guard disabled
% 1: portfast errdisable timeout disabled
% 1: portfast errdisable timeout interval 300 sec
% eth1: Port Number 3 - Ifindex 3 - Port Id 0x8003 - Role Designated - State
Forwarding
% eth1: Designated External Path Cost 0 -Internal Path Cost 0
% eth1: Configured Path Cost 200000 - Add type Explicit ref count 3
% eth1: Designated Port Id 0x8003 - Priority 128 -
% eth1: Root 8001525400b7bfa7
% eth1: Designated Bridge 8001525400b7bfa7
% eth1: Message Age 0 - Max Age 20
% eth1: Hello Time 2 - Forward Delay 15
% eth1: Forward Timer 0 - Msg Age Timer 0 - Hello Timer 0 - topo change timer 0
% eth1: forward-transitions 1
% eth1: Version Rapid Spanning Tree Protocol - Received None - Send RSTP
% eth1: No portfast configured - Current portfast off
% eth1: bpdu-guard default - Current bpdu-guard off
% eth1: bpdu-filter default - Current bpdu-filter off
% eth1: no root guard configured - Current root guard off
% eth1: Configured Link Type point-to-point - Current point-to-point
% eth1: No auto-edge configured - Current port Auto Edge off
%
% eth2: Port Number 4 - Ifindex 4 - Port Id 0x8004 - Role Designated - State
Forwarding
% eth2: Designated External Path Cost 0 -Internal Path Cost 0
% eth2: Configured Path Cost 200000 - Add type Explicit ref count 3
% eth2: Designated Port Id 0x8004 - Priority 128 -
```

---

```
% eth2: Root 8001525400b7bfa7
% eth2: Designated Bridge 8001525400b7bfa7
% eth2: Message Age 0 - Max Age 20
% eth2: Hello Time 2 - Forward Delay 15
% eth2: Forward Timer 0 - Msg Age Timer 0 - Hello Timer 1 - topo change timer 0
% eth2: forward-transitions 1
% eth2: Version Rapid Spanning Tree Protocol - Received None - Send RSTP
% eth2: No portfast configured - Current portfast off
% eth2: bpdu-guard default - Current bpdu-guard off
% eth2: bpdu-filter default - Current bpdu-filter off
% eth2: no root guard configured - Current root guard off
% eth2: Configured Link Type point-to-point - Current point-to-point
% eth2: No auto-edge configured - Current port Auto Edge off
%
```

```
% Instance 1: Vlans: 2
% eth1: Port Number 3 - Ifindex 3 - Port Id 0x8003 - Role Designated - State
Forwarding
% eth1: Designated Internal Path Cost 0 - Designated Port Id 0x8003
% eth1: Configured Internal Path Cost 200000
% eth1: Configured External Path cost 200000
% eth1: Configured Internal Priority 128
% eth1: Configured External Priority 128
% eth1: Designated Root 8002525400b7bfa7
% eth1: Designated Bridge 8002525400b7bfa7
% eth1: Message Age 0 - Max Age 20
% eth1: Hello Time 2 - Forward Delay 15
% eth1: Forward Timer 0 - Msg Age Timer 0 - Hello Timer 0
```

```
% Instance 1: Vlans: 2
% eth2: Port Number 4 - Ifindex 4 - Port Id 0x8004 - Role Designated - State
Forwarding
% eth2: Designated Internal Path Cost 0 - Designated Port Id 0x8004
% eth2: Configured Internal Path Cost 200000
% eth2: Configured External Path cost 200000
% eth2: Configured Internal Priority 128
% eth2: Configured External Priority 128
% eth2: Designated Root 8002525400b7bfa7
% eth2: Designated Bridge 8002525400b7bfa7
% eth2: Message Age 0 - Max Age 20
% eth2: Hello Time 2 - Forward Delay 15
% eth2: Forward Timer 0 - Msg Age Timer 0 - Hello Timer 1
```

```
% Instance 2: Vlans: 3
% eth1: Port Number 3 - Ifindex 3 - Port Id 0x8003 - Role Designated - State
Forwarding
% eth1: Designated Internal Path Cost 0 - Designated Port Id 0x8003
% eth1: Configured Internal Path Cost 200000
% eth1: Configured External Path cost 200000
```

## RPVST+ Configuration

---

```
% eth1: Configured Internal Priority 128
% eth1: Configured External Priority 128
% eth1: Designated Root 8003525400b7bfa7
% eth1: Designated Bridge 8003525400b7bfa7
% eth1: Message Age 0 - Max Age 20
% eth1: Hello Time 2 - Forward Delay 15
% eth1: Forward Timer 0 - Msg Age Timer 0 - Hello Timer 0

% Instance 2: Vlans: 3
% eth2: Port Number 4 - Ifindex 4 - Port Id 0x8004 - Role Designated - State
Forwarding
% eth2: Designated Internal Path Cost 0 - Designated Port Id 0x8004
% eth2: Configured Internal Path Cost 200000
% eth2: Configured External Path cost 200000
% eth2: Configured Internal Priority 128
% eth2: Configured External Priority 128
% eth2: Designated Root 8003525400b7bfa7
% eth2: Designated Bridge 8003525400b7bfa7
% eth2: Message Age 0 - Max Age 20
% eth2: Hello Time 2 - Forward Delay 15
% eth2: Forward Timer 0 - Msg Age Timer 0 - Hello Timer 1
```

## CHAPTER 8 Link Aggregation Configuration

This chapter contains a complete sample Link Aggregation Group configuration.

LACP is based on the 802.3ad IEEE specification. It allows bundling of several physical interfaces to form a single logical channel providing enhanced performance and redundancy. The aggregated interface is viewed as a single link to each switch. The spanning tree views it as one interface and not as two or three interfaces. When there is a failure in one physical interface, the other interfaces stay up and there is no disruption. Traffic can be load balanced within an LACP trunk group in a controlled manner using the hashing algorithm. The maximum number of physical Ethernet links in a single logical channel depends upon the hardware support.

Note:

- Physical interfaces will inherit the properties of LAG port once it is attached to be part of LAG, irrespective of the configuration present on the physical interface.
- In case of Dynamic LAG and Static LAG, member ports could be moved from one LAG to another LAG, without unconfiguring the member port.
- LAG port should be configured as a switch or router port, before adding member ports into it.

### Topology

In [Figure 8-8](#), 3 links are configured between the two switches S1 and S2. These three links are assigned the same administrative key (1) so that they aggregate to form a single channel 1. They are viewed by the STP as one interface.

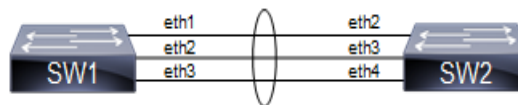

Figure 8-8: LACP Topology

### Dynamic LAG Configuration

#### SW1

SW1#configure terminal	Enter configure mode.
SW1(config)# bridge 1 protocol mstp	Configure bridge 1 as MSTP bridge
SW1(config)#lacp system-priority 20000	Set the system priority of this switch. This priority is used for determining the system that is responsible for resolving conflicts in the choice of aggregation groups. A lower numerical value has a higher priority.
SW1(config)#interface po10	Enter into port channel interface po10.
SW1(config-if)#switchport	Configure po10 as a layer 2 port.
SW1(config-if)#bridge-group 1	Associate bridge to an interface.
SW1(config-if)#switchport mode trunk	Configure port as a trunk.
SW1(config-if)#switchport trunk allowed vlan all	Allow all the VLANs on the po10 interface.
SW1(config-if)#exit	Exit interface mode.
SW1(config)#interface eth1	Enter interface mode.

## Link Aggregation Configuration

SW1(config-if)#channel-group 10 mode active	Add this interface to channel group 10 and enable link aggregation so that it can be selected for aggregation by the local system.
SW1(config-if)#exit	Exit interface mode.
SW1(config)#interface eth2	Enter interface mode.
SW1(config-if)#channel-group 10 mode active	Add this interface to channel group 10 and enable link aggregation so that it can be selected for aggregation by the local system.
SW1(config-if)#exit	Exit interface mode.
SW1(config)#interface eth3	Enter interface mode.
SW1(config-if)#channel-group 10 mode active	Add this interface to channel group 10 and enable link aggregation so that it can be selected for aggregation by the local system.

## SW2

SW2#configure terminal	Enter configure mode.
SW2(config)# bridge 1 protocol mstp	Configure bridge 1 as MSTP bridge
SW2(config)#lacp system-priority 20000	Set the system priority of this switch. This priority is used for determining the system that is responsible for resolving conflicts in the choice of aggregation groups. A lower numerical value has a higher priority.
SW2(config)#interface po10	Enter into port channel interface po10.
SW2(config-if)#switchport	Configure po10 as a layer 2 port.
SW2(config-if)#bridge-group 1	Associate bridge to an interface.
SW2(config-if)#switchport mode trunk	Configure port as a trunk.
SW2(config-if)#switchport trunk allowed vlan all	Allow all the VLANs on the po10 interface.
SW2(config-if)#exit	Exit interface mode.
SW2(config)#interface eth2	Enter interface mode.
SW2(config-if)#channel-group 10 mode active	Add this interface to channel group 10 and enable link aggregation so that it can be selected for aggregation by the local system.
SW2(config-if)#exit	Exit interface mode.
SW2(config)#interface eth3	Enter interface mode.
SW2(config-if)#channel-group 10 mode active	Add this interface to channel group 10 and enable link aggregation so that it can be selected for aggregation by the local system.
SW2(config-if)#exit	Exit interface mode.
SW2(config)#interface eth4	Enter interface mode.
SW2(config-if)#channel-group 10 mode active	Add this interface to channel group 10 and enable link aggregation so that it can be selected for aggregation by the local system.

---

## Validation

show etherchannel detail, show etherchannel summary, show running-config interface po10, show running-config interface eth1

```
#show etherchannel detail
% Aggregator po10 7
% Aggregator Type: Layer2
% Mac address: 08:00:27:50:6a:9b
% Admin Key: 0010 - Oper Key 0010
% Actor LAG ID- 0x4e20,08-00-27-ab-ea-38,0x000a
% Receive link count: 3 - Transmit link count: 3
% Individual: 0 - Ready: 1
% Partner LAG ID- 0x4e20,08-00-27-f8-3c-30,0x000a
% Link: eth1 (3) sync: 1
% Link: eth2 (4) sync: 1
% Link: eth3 (5) sync: 1
% Collector max delay: 5

#show etherchannel summary
% Aggregator po10 7
% Aggregator Type: Layer2
% Admin Key: 0010 - Oper Key 0010
% Aggregator Type: Layer2
% Link: eth1 (3) sync: 1
% Link: eth2 (4) sync: 1
% Link: eth3 (5) sync: 1

#show running-config interface po10
!
interface po10
  switchport
  bridge-group 1
  switchport mode trunk
  switchport trunk allowed vlan all

#show running-config interface eth1
!
interface eth1
  channel-group 10 mode active
```

---

## Static LAG Configuration

### SW1

SW1#configure terminal	Enter configure mode.
SW1(config)# bridge 1 protocol mstp	Configure bridge 1 as MSTP bridge
SW1(config)#lacp system-priority 20000	Set the system priority of this switch. This priority is used for determining the system that is responsible for resolving conflicts in the choice of aggregation groups. A lower numerical value has a higher priority.
SW1(config)#interface sa10	Enter into port channel interface sa10.

## Link Aggregation Configuration

SW1 (config-if) #switchport	Configure sa10 as a layer 2 port.
SW1 (config-if) #bridge-group 1	Associate bridge to an interface.
SW1 (config-if) #switchport mode trunk	Configure port as a trunk.
SW1 (config-if) #switchport trunk allowed vlan all	Allow all the VLANs on the po10 interface.
SW1 (config-if) #exit	Exit interface mode.
SW1 (config) #interface eth1	Enter interface mode.
SW1 (config-if) #static-channel-group 10	Add this interface to channel group 10 and enable link aggregation so that it can be selected for aggregation by the local system.
SW1 (config-if) #exit	Exit interface mode.
SW1 (config) #interface eth2	Enter interface mode.
SW1 (config-if) #static-channel-group 10	Add this interface to channel group 10 and enable link aggregation so that it can be selected for aggregation by the local system.
SW1 (config-if) #exit	Exit interface mode.
SW1 (config) #interface eth3	Enter interface mode.
SW1 (config-if) #static-channel-group 10	Add this interface to channel group 10 and enable link aggregation so that it can be selected for aggregation by the local system.
SW1 (config-if) #exit	Exit interface mode.

## SW2

SW2#configure terminal	Enter configure mode.
SW2 (config) # bridge 1 protocol mstp	Configure bridge 1 as MSTP bridge
SW2 (config) #lacp system-priority 20000	Set the system priority of this switch. This priority is used for determining the system that is responsible for resolving conflicts in the choice of aggregation groups. A lower numerical value has a higher priority.
SW2 (config) #interface sa10	Enter into port channel interface sa10.
SW2 (config-if) #switchport	Configure sa10 as a layer 2 port.
SW2 (config-if) #bridge-group 1	Associate bridge to an interface.
SW2 (config-if) #switchport mode trunk	Configure port as a trunk.
SW2 (config-if) #switchport trunk allowed vlan all	Allow all the VLANs on the po10 interface.
SW2 (config-if) #exit	Exit interface mode.
SW2 (config) #interface eth2	Enter interface mode.
SW2 (config-if) #static-channel-group 10	Add this interface to channel group 10 and enable link aggregation so that it can be selected for aggregation by the local system.
SW2 (config-if) #exit	Exit interface mode.
SW2 (config) #interface eth3	Enter interface mode.
SW2 (config-if) #static-channel-group 10	Add this interface to channel group 10 and enable link aggregation so that it can be selected for aggregation by the local system.



---

SW2(config-if)#exit	Exit interface mode.
SW2(config)#interface eth4	Enter interface mode.
SW2(config-if)#static-channel-group 10	Add this interface to channel group 10 and enable link aggregation so that it can be selected for aggregation by the local system.
SW2(config-if)#exit	Exit interface mode.

---

## Validation

```
#show static-channel-group
% Static Aggregator: sa10
% Member status:
  eth1    up
  eth2    up
  eth3    up

#show running-config interface sa10
!
interface sa10
  switchport
  bridge-group 1
  switchport mode trunk
  switchport trunk allowed vlan all

#show running-config interface eth1
!
interface eth1
  static-channel-group 10
```

## Static LAG Minimum Link Configuration

Configure the minimum number of ports that must be linked up and bundled in the LACP port channel. We can configure the minimum links range from 2 to 32. If the number of ports aggregated to the port channel is less than the minimum number of links configured, then the port channel enters the Protocol Down because of the minimum link state.

Note: Minimum links should be configured the same on both sides for optimal performance.

### Topology

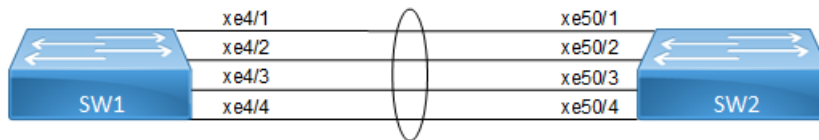

Figure 8-9: LAG Minimum Link

#### SW1

#configure terminal	Enter configure mode.
(config)#interface sa10	Creating interface static-lag sa10
(config-if)#port-channel min-links 4	Configuring port channel minimum links as 4(range is 2-32)
(config-if)#end	Exit the configure mode

### Validation

#### SW1

```
#show static-channel-group 10
% Static Aggregator: sa10
% Minimum-Links 4
% Member status:
    xe4/1      up
    xe4/2      up
    xe4/3      up
    xe4/4      up

#show running-config interface sa10
!
interface sa10
  switchport
  bridge-group 1
  switchport mode trunk
  switchport trunk allowed vlan all
  port-channel min-links 4
```

**SW2**

#configure terminal	Enter configure mode.
(config)#interface sa10	Creating interface port-channel sa10
(config-if)#port-channel min-links 4	Configuring port channel minimum links as 4 (range is 2-32)
(config-if)#exit	Exit the configure mode

**Validation****SW2**

```
#show running-config interface sa10
!
interface sa10
  switchport
  bridge-group 1
  switchport mode trunk
  switchport trunk allowed vlan all
  port-channel min-links 4
!
```

```
#show static-channel-group 10
% Static Aggregator: sa10
% Minimum-Links 4
% Member status:
    Xe50/1      up
    Xe50/2      up
    Xe50/3      up
    Xe50/4      up
```

Note:When a sa goes down due to the minimum links configured (number of minimum links is greater than the links aggregated to the sa).

```
Rtrl:
=====
```

```
#sh int brief sa10
```

```
Codes: ETH - Ethernet, LB - Loopback, AGG - Aggregate, MLAG - MLAG Aggregate
Port    FR - Frame Relay, TUN -Tunnel, PBB - PBB Logical Port, VP - Virtual
        CVP - Channelised Virtual Port, METH - Management Ethernet, UNK-
Unknown
        ED - ErrDisabled, PD - Protocol Down, AD - Admin Down,
IA - InActive
        PD(Min L/B) - Protocol Down Min-Links/Bandwidth
        DV - DDM Violation, NA - Not Applicable
        NOM - No operational members, PVID - Port Vlan-id
        Ctl - Control Port (Br-Breakout/Bu-Bundle)
        HD - ESI Hold Timer Down
```

```
-----
--
Port-channel  Type  PVID  Mode                Status  Reason  Speed
```

```

Interface
-----
--
sa10          AGG   1    trunk          down      PD (Min L/B)  0
#

Rtr2:
=====

#sh int brief sa10

Codes: ETH - Ethernet, LB - Loopback, AGG - Aggregate, MLAG - MLAG Aggregate
      FR - Frame Relay, TUN -Tunnel, PBB - PBB Logical Port, VP - Virtual
Port
      CVP - Channelised Virtual Port, METH - Management Ethernet, UNK-
Unknown
      ED - ErrDisabled, PD - Protocol Down, AD - Admin Down,
      IA - InActive
      PD (Min L/B) - Protocol Down Min-Links/Bandwidth
      DV - DDM Violation, NA - Not Applicable
      NOM - No operational members, PVID - Port Vlan-id
      Ctl - Control Port (Br-Breakout/Bu-Bundle)
      HD - ESI Hold Timer Down

-----
--
Port-channel  Type  PVID  Mode          Status  Reason  Speed
Interface
-----
--
sa10          AGG   1    trunk          down    PD (Min L/B)  0
#
  
```

## Static-LAG Minimum Bandwidth Configuration

Configure the minimum bandwidth allowed for ports that must be linked up and bundled in the LACP port channel. We can configure the minimum bandwidth range from BANDWIDTH <1-999>k|m for 1 to 999 kilo bits or mega bits <1-1000>g for 1 to 1000 giga bits. If the Total bandwidth of ports aggregated to the port channel is less than the minimum Bandwidth value configured, then the port channel enters the Protocol Down because of the minimum Bandwidth state.

Note: Minimum Bandwidth should be configured the same on both sides for optimal performance.

### Topology

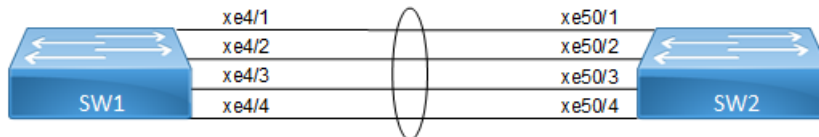

Figure 8-10: LAG Minimum Bandwidth

**SW1**

#configure terminal	Enter configure mode.
(config)#interface sa10	Creating interface static-lag sa10
(config-if)#port-channel min-bandwidth 40g	Configuring port channel minimum bandwidth as 40g (range from BANDWIDTH <1-999>k m for 1 to 999 kilo bits or mega bits <1-1000>g for 1 to 1000 giga bits.)
(config-if)#end	Exit the configure mode

**Validation****SW1**

```
#show static-channel-group 10
% Static Aggregator: sa10
% Minimum- 4
% Member status:
    xe4/1      up
    xe4/2      up
    xe4/3      up
    xe4/4      up
```

```
#show running-config interface sa10
!
interface sa10
  switchport
  bridge-group 1
  switchport mode trunk
  switchport trunk allowed vlan all
  port-channel min-bandwidth 40g
```

**SW2**

#configure terminal	Enter configure mode.
(config)#interface sa10	Creating interface port-channel sa10
(config-if)#port-channel min-bandwidth 40g	Configuring port channel minimum bandwidth as 40g (range from BANDWIDTH <1-999>k m for 1 to 999 kilo bits or mega bits <1-1000>g for 1 to 1000 giga bits.)
(config-if)#exit	Exit the configure mode

**Validation****SW2**

```
#show running-config interface sa10
!
interface sa10
  switchport
```

## Link Aggregation Configuration

---

```
bridge-group 1
switchport mode trunk
switchport trunk allowed vlan all
port-channel min-bandwidth 40g
!

#show static-channel-group 10
% Static Aggregator: sa10
% Minimum-bandwidth 40g
% Member status:
    Xe50/1      up
    Xe50/2      up
    Xe50/3      up
    Xe50/4      up
```

Note: When sa goes down due to [Total Bandwidth of sa] < [ Minimum Bandwidth value Configured]

SW1:

=====

```
#sh int brief sa10
```

Codes: ETH - Ethernet, LB - Loopback, AGG - Aggregate, MLAG - MLAG Aggregate  
FR - Frame Relay, TUN -Tunnel, PBB - PBB Logical Port, VP - Virtual

Port

Unknown CVP - Channelised Virtual Port, METH - Management Ethernet, UNK-

ED - ErrDisabled, PD - Protocol Down, AD - Admin Down,  
IA - InActive

PD(Min L/B) - Protocol Down Min-Links/Bandwidth

DV - DDM Violation, NA - Not Applicable

NOM - No operational members, PVID - Port Vlan-id

Ctl - Control Port (Br-Breakout/Bu-Bundle)

HD - ESI Hold Timer Down

```
-----
--
Port-channel Type PVID Mode          Status   Reason Speed
Interface
-----
--
sa10          AGG    1    trunk          down     PD(Min L/B)  0
#
```

SW2:

=====

```
#sh int brief sa10
```

Codes: ETH - Ethernet, LB - Loopback, AGG - Aggregate, MLAG - MLAG Aggregate  
FR - Frame Relay, TUN -Tunnel, PBB - PBB Logical Port, VP - Virtual

Port

Unknown CVP - Channelised Virtual Port, METH - Management Ethernet, UNK-

ED - ErrDisabled, PD - Protocol Down, AD - Admin Down,  
IA - InActive

PD(Min L/B) - Protocol Down Min-Links/Bandwidth  
 DV - DDM Violation, NA - Not Applicable  
 NOM - No operational members, PVID - Port Vlan-id  
 Ctl - Control Port (Br-Breakout/Bu-Bundle)  
 HD - ESI Hold Timer Down

```

-----
--
Port-channel  Type  PVID  Mode                Status  Reason  Speed
Interface
-----
--
sa10          AGG   1     trunk               down    PD(Min L/B)  0
#
    
```

## Dynamic-LAG Minimum Link Configuration

Configure the minimum number of ports that must be linked up and bundled in the LACP port channel. We can configure the minimum links range from 2 to 32. If the number of ports aggregated to the port channel is less than the minimum number of links configured, then the port channel enters the Protocol Down because of the minimum link state.

Note: Minimum links should be configured the same on both sides for optimal performance.

### Topology

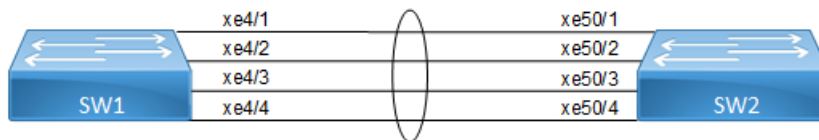

Figure 8-11: LAG Minimum Link

### SW1

#configure terminal	Enter configure mode.
(config)#interface po10	Creating interface port-channel po10
(config-if)#port-channel min-links 4	Configuring port channel minimum links as 4 (range is 2-32)
(config-if)#end	Exit the configure mode

### Validation

#### SW1

```

#sh running-config interface po10

interface po10
 switchport
 bridge-group 1
 switchport mode trunk
    
```

```
switchport trunk allowed vlan all
port-channel min-links 4
!
```

```
!
```

```
#show etherchannel
```

```
-----
% LACP Aggregator: po10
% Min-links : 4
% Member:
  xe4/1
  xe4/2
  xe4/3
  xe4/4
-----
```

```
#show etherchannel summary
```

```
-----
% Aggregator po10 100010
% Aggregator Type: Layer2
% Admin Key: 0010 - Oper Key 0010
% Link: xe4/4 (10072) sync: 1
% Link: xe4/1 (10069) sync: 1
% Link: xe4/2 (10070) sync: 1
% Link: xe4/3 (10071) sync: 1
-----
```

## SW2

#configure terminal	Enter configure mode.
(config)#interface po10	Creating interface port-channel po10
(config-if)#port-channel min-links 4	Configuring port channel minimum links as 4 (range is 2-32)
(config-if)#exit	Exit the configure mode

---

## Validation

### SW2

```
#show running-config interface po10
!
interface po10
switchport
bridge-group 1
switchport mode trunk
switchport trunk allowed vlan all
port-channel min-links 4
!
```

```
#show etherchannel
```

```
% Aggregator Type: Layer2
% LACP Aggregator: po10
```



```

% Min-links: 4
% Member:
  xe50/1
  xe50/2
  xe50/3
  xe50/4

#show etherchannel summary

% Aggregator po10 100010
% Aggregator Type: Layer2
% Admin Key: 0010 - Oper Key 0010
% Link: xe50/4 (10072) sync: 1
% Link: xe50/1 (10069) sync: 1
% Link: xe50/2 (10070) sync: 1
% Link: xe50/3 (10071) sync: 1

```

**Note:** When a PO goes down due to the minimum links configured (number of minimum links is greater than the links aggregated to the PO).

```

RTR1:
#sh int brief po10

Codes: ETH - Ethernet, LB - Loopback, AGG - Aggregate, MLAG - MLAG Aggregate
      FR - Frame Relay, TUN -Tunnel, PBB - PBB Logical Port, VP - Virtual
Port
      CVP - Channelised Virtual Port, METH - Management Ethernet, UNK-
Unknown
      ED - ErrDisabled, PD - Protocol Down, AD - Admin Down,
      IA - InActive
      PD(Min L/B) - Protocol Down Min-Links/Bandwidth
      DV - DDM Violation, NA - Not Applicable
      NOM - No operational members, PVID - Port Vlan-id
      Ctl - Control Port (Br-Breakout/Bu-Bundle)
      HD - ESI Hold Timer Down

```

```

-----
--
Port-channel  Type  PVID  Mode                Status  Reason  Speed
Interface
-----
--
po10          AGG   1     trunk              down    PD(Min L/B)  0
#

```

```

#sh etherchannel
% LACP Aggregator: po10
% Min-links: 4
% Protocol Down (Min L/B): True
% Member:
  xe4/1
  xe4/2
  xe4/3

```

## Link Aggregation Configuration

---

xe4/4

SW2:

```
#sh etherchannel
```

```
% LACP Aggregator: po10
```

```
% Min-links: 4
```

```
% Protocol Down (Min L/B): True
```

```
% Member:
```

```
  Xe50/1
```

```
  Xe50/2
```

```
  Xe50/3
```

```
  xe50/4
```

```
#sh int brief po100
```

```
Codes: ETH - Ethernet, LB - Loopback, AGG - Aggregate, MLAG - MLAG Aggregate  
FR - Frame Relay, TUN - Tunnel, PBB - PBB Logical Port, VP - Virtual
```

```
Port
```

```
  CVP - Channelised Virtual Port, METH - Management Ethernet, UNK-
```

```
Unknown
```

```
  ED - ErrDisabled, PD - Protocol Down, AD - Admin Down,
```

```
  IA - InActive
```

```
  PD(Min L/B) - Protocol Down Min-Links/Bandwidth
```

```
  DV - DDM Violation, NA - Not Applicable
```

```
  NOM - No operational members, PVID - Port Vlan-id
```

```
  Ctl - Control Port (Br-Breakout/Bu-Bundle)
```

```
  HD - ESI Hold Timer Down
```

```
-----  
--  
Port-channel  Type  PVID  Mode                Status  Reason  Speed  
Interface  
-----  
--  
po10          AGG   1     trunk              down    PD(Min L/B)  0  
#
```

## Dynamic LAG Minimum Bandwidth Configuration

Configure the minimum bandwidth allowed for ports that must be linked up and bundled in the LACP port channel. We can configure the minimum bandwidth range from BANDWIDTH <1-999>k|m for 1 to 999 kilo bits or mega bits <1-1000>g for 1 to 1000 giga bits. If the Total bandwidth of ports aggregated to the port channel is less than the minimum Bandwidth value configured, then the port channel enters the Protocol Down because of the minimum Bandwidth state.

Note: Minimum Bandwidth should be configured the same on both sides for optimal performance.

### Topology

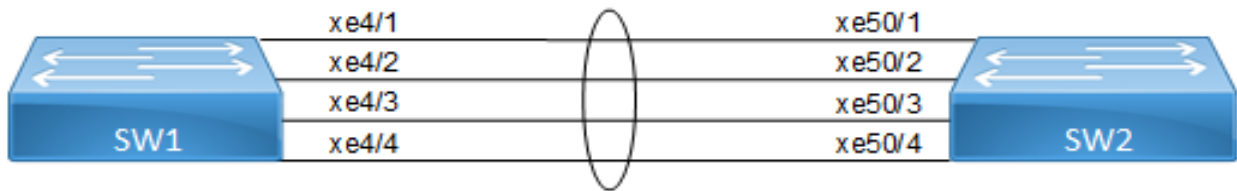

Figure 8-12: LAG Minimum Bandwidth

### SW1

#configure terminal	Enter configure mode.
(config)#interface po10	Creating interface port-channel po10
(config-if)#port-channel min-bandwidth 40g	Configuring port channel minimum bandwidth as 40g (range from BANDWIDTH <1-999>k m for 1 to 999 kilo bits or mega bits <1-1000>g for 1 to 1000 giga bits.)
(config-if)#end	Exit the configure mode

### Validation

#### SW1

```
#sh running-config interface po10
```

```
interface po10
  switchport
  bridge-group 1
  switchport mode trunk
  switchport trunk allowed vlan all
  port-channel min-bandwidth 40g
  !
```

```
!
```

```
#show etherchannel
```

```
-----
% LACP Aggregator: po10
% Min-Bandwidth : 40g
% Member:
  xe4/1
  xe4/2
```

## Link Aggregation Configuration

---

```
xe4/3
xe4/4
-----
```

```
#show etherchannel summary
```

```
% Aggregator po10 100010
% Aggregator Type: Layer3
% Admin Key: 0010 - Oper Key 0010
% Link: xe4/4 (10072) sync: 1
% Link: xe4/1 (10069) sync: 1
% Link: xe4/2 (10070) sync: 1
% Link: xe4/3 (10071) sync: 1
-----
```

## SW2

#configure terminal	Enter configure mode.
(config)#interface po10	Creating interface port-channel po10
(config-if)#port-channel min-bandwidth 40g	Configuring port channel minimum bandwidth as 40g (range from BANDWIDTH <1-999>k m for 1 to 999 kilo bits or mega bits <1-1000>g for 1 to 1000 giga bits.)
(config-if)#exit	Exit the configure mode

---

## Validation

### SW2

```
#show running-config interface po10
!
interface po10
  switchport
  bridge-group 1
  switchport mode trunk
  switchport trunk allowed vlan all
  port-channel min-bandwidth 40g
!
```

```
#show etherchannel
```

```
% LACP Aggregator: po10
% Min-Bandwidth : 40g
% Member:
  xe50/1
  xe50/2
  xe50/3
  xe50/4
```

```
#show etherchannel summary
```

```
% Aggregator po10 100010
% Aggregator Type: Layer2
% Admin Key: 0010 - Oper Key 0010
```

```
% Link: xe50/4 (10072) sync: 1
% Link: xe50/1 (10069) sync: 1
% Link: xe50/2 (10070) sync: 1
% Link: xe50/3 (10071) sync: 1
```

Note: When a PO goes down due to the [Total bandwidth] < [minimum bandwidth configured]

SW1:

=====

```
#sh int brief po10
```

```
Codes: ETH - Ethernet, LB - Loopback, AGG - Aggregate, MLAG - MLAG Aggregate
       FR - Frame Relay, TUN -Tunnel, PBB - PBB Logical Port, VP - Virtual
Port
       CVP - Channelised Virtual Port, METH - Management Ethernet, UNK-
Unknown
       ED - ErrDisabled, PD - Protocol Down, AD - Admin Down,
       IA - InActive
       PD(Min L/B) - Protocol Down Min-Links/Bandwidth
       DV - DDM Violation, NA - Not Applicable
       NOM - No operational members, PVID - Port Vlan-id
       Ctl - Control Port (Br-Breakout/Bu-Bundle)
       HD - ESI Hold Timer Down
```

```
-----
--
Port-channel Type  PVID  Mode                Status  Reason  Speed
Interface
-----
--
po10             AGG   1      trunk              down    PD(Min L/B)  0
#
```

```
#sh etherchannel
```

```
% LACP Aggregator: po10
% Min-Bandwidth : 40g
% Protocol Down (Min L/B): True
% Member:
   xe4/1
   xe4/2
   xe4/3
   xe4/4
```

SW2:

=====

```
#sh etherchannel
```

```
% LACP Aggregator: po10
% Min-Bandwidth : 40g
% Protocol Down (Min L/B): True
% Member:
   Xe50/1
   Xe50/2
   Xe50/3
   xe50/4
```

```
#sh int brief po10
```

```
Codes: ETH - Ethernet, LB - Loopback, AGG - Aggregate, MLAG - MLAG Aggregate  
FR - Frame Relay, TUN -Tunnel, PBB - PBB Logical Port, VP - Virtual
```

```
Port
```

```
Unknown CVP - Channelised Virtual Port, METH - Management Ethernet, UNK-
```

```
Unknown
```

```
ED - ErrDisabled, PD - Protocol Down, AD - Admin Down,
```

```
IA - InActive
```

```
PD(Min L/B) - Protocol Down Min-Links/Bandwidth
```

```
DV - DDM Violation, NA - Not Applicable
```

```
NOM - No operational members, PVID - Port Vlan-id
```

```
Ctl - Control Port (Br-Breakout/Bu-Bundle)
```

```
HD - ESI Hold Timer Down
```

```
-----  
--  
Port-channel Type PVID Mode Status Reason Speed  
Interface  
-----  
--  
po10 AGG 1 trunk down PD(Min L/B) 0  
#
```

---

## LACP Minimum-Link, Minimum-Bandwidth on Dynamic and Static Channel-Groups with MC-LAG

---

### Overview

OcNOS allows the configuration of minimum number of the LAG members per LAG group. Both these configurations are meaningful in case the LAG is used for incremental-BW mode. The minimum configuration controls the minimum number of members /bandwidth that must be operationally up / bandwidth available to declare their LAG as operationally UP.

When static/dynamic LAG interface configured with minimum links / minimum bandwidth, the following conditions are to be met:

- Ports which are admin and operational up are considered for min-link.
- The specified minimum number of links should be up.
- Min-link and min-bandwidth cannot co-exist.
- When ports are down due to min-link/min-bandwidth, in show interface brief command output, port down with the corresponding reason code for the failure due to min-link/min-bandwidth.

---

### Minimum Active Members/Bandwidth

The user can specify the minimum number of members that must be operationally up to declare their LAG as operationally UP. Note that this parameter applies to static/dynamic LAG.

```
port-channel min-links <2 - 32>
```

The minimum active member configuration will be allowed to be modified to be greater than the current number of active members. In such configuration, the LAG operational status will become operationally down.

The user can specify the minimum bandwidth, based on the configured value and the ports that satisfy the conditions LAG will be operationally UP. This parameter is applied for static/dynamic LAG.

```
port-channel min-bandwidth BANDWIDTH
```

BANDWIDTH <1-999>k|m for 1 to 999 kilo bits or mega bits <1-1000>g for 1 to 1000 giga bits.

When condition fails, the operational state changes to DOWN.

Note: Do not configure minimum-link, Minimum Bandwidth both on TORS and switches at the same time to avoid flaps of MLAG.

## Topology

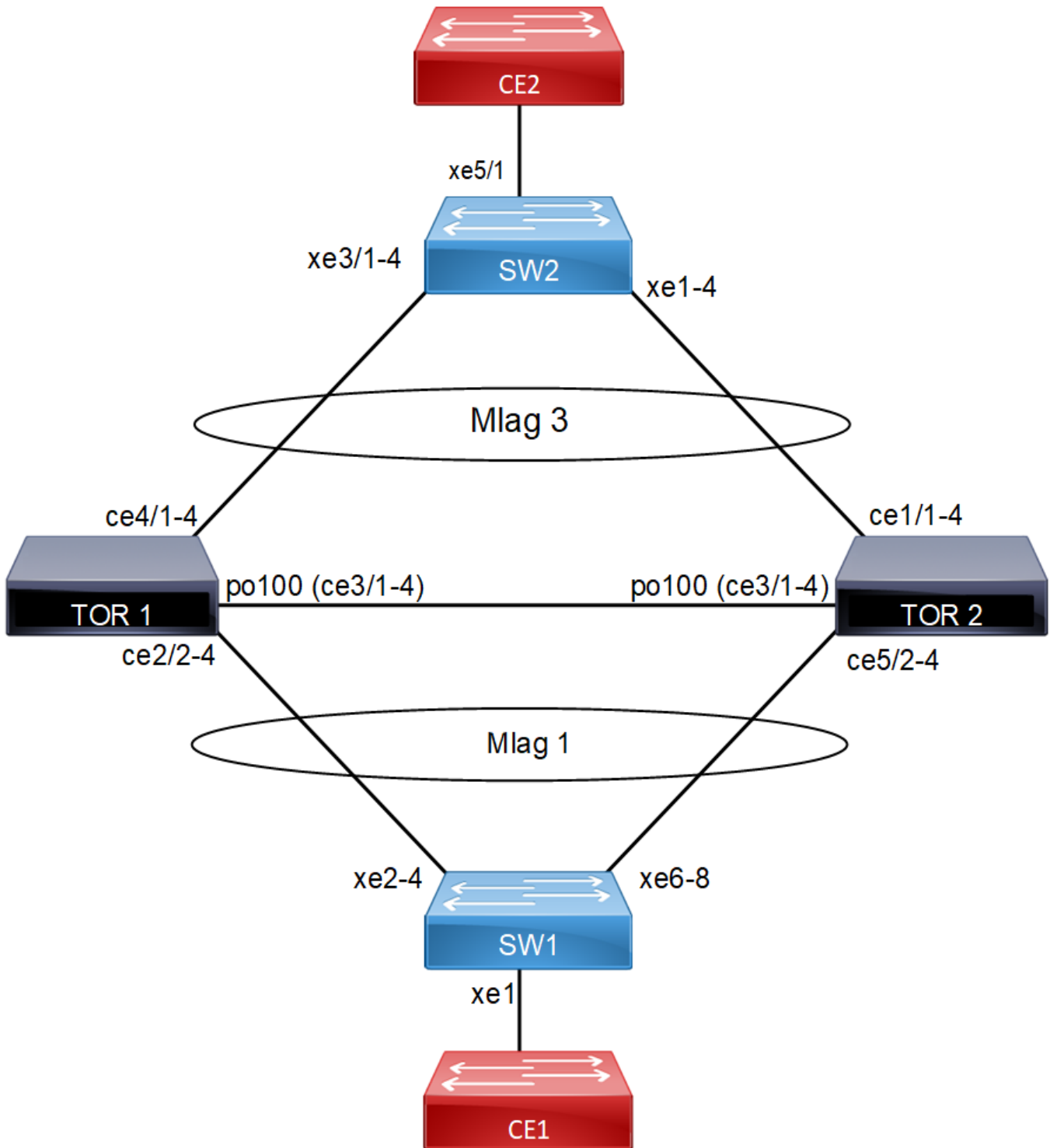

Figure 8-13: MC - LAG Topology

## Configuration

TOR1:



#configure terminal	Enter configure mode.
(config)# bridge 1 protocol rstp vlan-bridge end	Configure bridge type
configure terminal	Enter Configure mode
(config)# vlan database	Enter vlan database
(config-vlan)# vlan 600 bridge 1 state enable (config-if)#end	Configure vlans
#configure terminal	Enter Configure mode.
(config)#interface mlag1	Enter Interface mode
(config-if)# switchport	Make mlag as layer2 port
(config-if)# bridge-group 1	Attach interface to bridge
(config-if)# switchport mode trunk	Configure trunk port
(config-if)# switchport trunk allowed vlan add 600,601,502	Add interface to vlans
(config-if)# spanning-tree edgeport	Configure port as edge port to avoid loops
(config-if)# spanning-tree bpdu-filter enable	Enable bpdu filter to avoid loops
(config-if)#end	Return to privilege mode
#configure terminal	Enter Configure mode.
(config)#interface mlag3	Enter Interface mode
(config-if)# switchport	Make mlag as layer2 port
(config-if)# bridge-group 1	Attach interface to bridge
(config-if)# switchport mode trunk	Configure trunk port
(config-if)# switchport trunk allowed vlan add 600,502	Add interface to vlans
(config-if)# spanning-tree edgeport	Configure port as edge port to avoid loops
(config-if)# spanning-tree bpdu-filter enable	Enable bpdu filter to avoid loops
(config-if)#end	Return to privilege mode
#configure terminal	Enter Configure mode.
(config)#interface po100	Enter Interface mode
(config-if)# switchport	Make po as layer2 port
(config-if)# bridge-group 1	Associate the interface with bridge group 1.
(config-if)# switchport mode trunk	Set the switching characteristics of this interface to trunk mode.
(config-if)# switchport trunk allowed vlan all	Enable all VLAN identifiers on this interface.
(config-if)# mtu 9216	Configure mtu
(config-if)#end	
#configure terminal	Enter Configure mode.
(config)#interface sa1	Enter Interface mode
(config-if)# switchport	Make sa1 as layer2 port
(config-if)# bridge-group 1	Associate the interface with bridge group 1.

## Link Aggregation Configuration

(config-if)# switchport mode trunk	Set the switching characteristics of this interface to trunk mode.
(config-if)# switchport trunk allowed all	Enable all VLAN identifiers on this interface.
(config-if)#end	Return to privilege mode
#configure terminal	Enter Configure mode.
(config)#interface ce2/1	Enter Interface mode
(config-if)#port breakout enable	Port breakout enabled
(config-if)#end	Return to privilege mode
#configure terminal	Enter Configure mode.
(config)#interface ce2/2	Enter Interface mode
(config-if)# static-channel-group 1	Add interface to sa1
(config-if)#end	Return to privilege mode
#configure terminal	Enter Configure mode.
(config)#interface ce2/3	Enter Interface mode
(config-if)# static-channel-group 1	Add interface to sa1
(config-if)#end	Return to privilege mode
#configure terminal	Enter Configure mode.
(config)#interface ce2/4	Enter Interface mode
(config-if)# static-channel-group 1	Add interface to sa1
(config-if)#end	Return to privilege mode
#configure terminal	Enter Configure mode.
(config)#interface ce3/1	Enter Interface mode
(config-if)#port breakout enable	Port breakout enabled
(config-if)# channel-group 100 mode active	Add interface to po100
(config-if)#end	Return to privilege mode
#configure terminal	Enter Configure mode.
(config)#interface ce3/2	Enter Interface mode
(config-if)# channel-group 100 mode active	Add interface to po100
(config-if)#end	Return to privilege mode
#configure terminal	Enter Configure mode.
(config)#interface ce3/3	Enter Interface mode
(config-if)# channel-group 100 mode active	Add interface to po100
(config-if)#end	Return to privilege mode
#configure terminal	Enter Configure mode.
(config)#interface ce3/4	Enter Interface mode
(config-if)# channel-group 100 mode active	Add interface to po100
(config-if)#end	Return to privilege mode
#configure terminal	Enter Configure mode.
(config)#interface ce4/1	Enter Interface mode
(config-if)#port breakout enable	Port breakout enabled
(config-if)# static-channel-group 3	Add interface to sa3

(config-if)#end	Return to privilege mode
#configure terminal	Enter Configure mode.
(config)#interface ce4/2	Enter Interface mode
(config-if)# static-channel-group 3	Add interface to sa3
(config-if)#end	Return to privilege mode
#configure terminal	Enter Configure mode.
(config)#interface ce4/3	Enter Interface mode
(config-if)# static-channel-group 3	Add interface to sa3
(config-if)#end	Return to privilege mode
#configure terminal	Enter Configure mode.
(config)#mcec domain configuration	Enter Multichassis Etherchannel domain configuration mode.
(config-mcec-domain)# domain-address 1111.2222.3333	Configure the domain address.
(config-mcec-domain)# domain-system-number 1	Configure the domain system number
(config-mcec-domain)# intra-domain-link po100	Specify the intra domain link for MLAG communication
(config-mcec-domain)#end	Return to privilege mode
#configure terminal	Enter Configure mode.
(config)#int mlag1	Enter Interface mode
(config-if)#mode active-standby	Configure mlag mode for mlag1
(config-if)#switchover type revertive 10	Configure revertive timer
(config-if)#end	Return to privilege mode
#configure terminal	Enter Configure mode.
(config)#interface sa1	Enter Interface mode
(config-if)#mlag 1	Map sa1 to mlag1
(config-if)#end	Return to privilege mode
#configure terminal	Enter Configure mode.
(config)#int mlag3	Enter Interface mode
(config-if)#mode active-standby	Configure mlag mode for mlag3
(config-if)#switchover type revertive 10	Configure revertive timer
(config-if)#end	Return to privilege mode
#configure terminal	Enter Configure mode.
(config)#interface sa3	Enter Interface mode
(config-if)#mlag 3	Map sa3 to mlag3
(config-if)#end	Return to privilege mode
#configure terminal	Enter Configure mode.
(config-if)# interface sa1	Enter sa interface mode
(config-if)#port-channel min-links 3	Configure min-link value on sa interface
(config-if)#end	Return to privilege mode
#configure terminal	Enter Configure mode.
(config)#interface sa3	Enter sa Interface mode
(config-if)#port-channel min-bandwidth 30g	Configure min-bandwidth value on sa/po interface

**TOR2**

#configure terminal	Enter configure mode.
bridge 1 protocol rstp vlan-bridge end	Configure bridge type
configure terminal	Enter Configure mode.
(config)# vlan database	Enter vlan database
(config-vlan)# vlan 600 bridge 1 state enable	Configure vlans
#configure terminal	Enter Configure mode.
(config)#interface mlag1	Enter Interface mode
(config-if)# switchport	Make mlag as layer2 port
(config-if)# bridge-group 1	Attach interface to bridge
(config-if)# switchport mode trunk	Configure trunk port
(config-if)# switchport trunk allowed vlan add 600,601,502	Add interface to vlans
(config-if)# spanning-tree edgeport	Configure port as edge port to avoid loops
(config-if)# spanning-tree bpdu-filter enable	Enable bpdu filter to avoid loops
(config-if)#end	Return to privilege mode
#configure terminal	Enter Configure mode.
(config)#interface mlag3	Enter Interface mode
(config-if)# switchport	Make mlag as layer2 port
(config-if)# bridge-group 1	Attach interface to bridge
(config-if)# switchport mode trunk	Configure trunk port
(config-if)# switchport trunk allowed vlan add 600,502	Add interface to vlans
(config-if)# spanning-tree edgeport	Configure port as edge port to avoid loops
(config-if)# spanning-tree bpdu-filter enable	Enable bpdu filter to avoid loops
(config-if)#end	Return to privilege mode
#configure terminal	Enter Configure mode.
(config)#interface po100	Enter Interface mode
(config-if)# switchport	Make po(IDL) as layer2 port
(config-if)# bridge-group 1	Associate the interface with bridge group 1.
(config-if)# switchport mode trunk	Set the switching characteristics of this interface to trunk mode.
(config-if)# switchport trunk allowed vlan all	Enable all VLAN identifiers on this interface.
(config-if)# port-channel load-balance src-dst-mac	Enable load balance
(config-if)# mtu 9216	Configure mtu
(config-if)#end	Return to privilege mode
#configure terminal	Enter Configure mode.
(config)#interface sa1	Enter Interface mode
(config-if)# switchport	Make sa1 as layer2 port
(config-if)# bridge-group 1	Associate the interface with bridge group 1.

(config-if)# switchport mode trunk	Set the switching characteristics of this interface to trunk mode.
(config-if)# switchport trunk allowed all	Enable all VLAN identifiers on this interface.
(config-if)#end	Return to privilege mode
#configure terminal	Enter Configure mode.
(config)#interface sa3	Enter Interface mode
(config-if)# switchport	Make sa3 as layer2 port
(config-if)# bridge-group 1	Associate the interface with bridge group 1.
(config-if)# switchport mode trunk	Set the switching characteristics of this interface to trunk mode.
(config-if)# switchport trunk allowed all	Enable all VLAN identifiers on this interface.
(config-if)#end	Return to privilege mode
#configure terminal	Enter Configure mode.
(config)#interface ce1/1	Enter Interface mode
(config-if)#port breakout enable	Port breakout enabled
(config-if)# static-channel-group 3	Add interface to sa3
(config-if)#end	Return to privilege mode
#configure terminal	Enter Configure mode.
(config)#interface ce1/2	Enter Interface mode
(config-if)# static-channel-group 3	Add interface to sa3
(config-if)#end	Return to privilege mode
#configure terminal	Enter Configure mode.
(config)#interface ce1/3	Enter Interface mode
(config-if)# static-channel-group 3	Add interface to sa3
(config-if)#end	Return to privilege mode
#configure terminal	Enter Configure mode.
(config)#interface ce3/1	Enter Interface mode
(config-if)# channel-group 100 mode active	Add interface to po100
(config-if)#end	Return to privilege mode
#configure terminal	Enter Configure mode.
(config)#interface ce3/2	Enter Interface mode
(config-if)# channel-group 100 mode active	Add interface to po100
(config-if)#end	Return to privilege mode
#configure terminal	Enter Configure mode.
(config)#interface ce3/3	Enter Interface mode
(config-if)# channel-group 100 mode active	Add interface to po100
(config-if)#end	Return to privilege mode
#configure terminal	Enter Configure mode.
(config)#interface ce3/4	Enter Interface mode
(config-if)# channel-group 100 mode active	Add interface to po100
(config-if)#end	Return to privilege mode

## Link Aggregation Configuration

#configure terminal	Enter Configure mode.
(config)#interface ce5/1	Enter Interface mode
(config-if)#port breakout enable	Port breakout enabled
(config-if)# static-channel-group 1	Add interface to sa1
(config-if)#end	Return to privilege mode
#configure terminal	Enter Configure mode.
(config)#interface ce5/2	Enter Interface mode
(config-if)# static-channel-group 1	Add interface to sa1
(config-if)#end	Return to privilege mode
#configure terminal	Enter Configure mode.
(config)#interface ce5/3	Enter Interface mode
(config-if)# static-channel-group 1	Add interface to sa1
(config-if)#end	Return to privilege mode
#configure terminal	Enter Configure mode.
(config)#mcec domain configuration	Enter Multichassis Etherchannel domain configuration mode.
(config-mcec-domain)# domain-address 1111.2222.3333	Configure the domain address.
(config-mcec-domain)# domain-system-number 2	Configure the domain system number
(config-mcec-domain)# intra-domain-link po100	Specify the intra domain link for MLAG communication
(config-mcec-domain)#end	Return to privilege mode
#configure terminal	Enter Configure mode.
(config)#int mlag1	Enter Interface mode
(config-if)#mode active-standby	Configure mlag mode for mlag1
(config-if)#switchover type revertive 10	Configure revertive timer
(config-if)#end	Return to privilege mode
#configure terminal	Enter Configure mode.
(config)#interface sa1	Enter Interface mode
(config-if)#mlag 1	Map sa1 to mlag1
(config-if)#end	Return to privilege mode
#configure terminal	Enter Configure mode.
(config)#int mlag3	Enter Interface mode
(config-if)#mode active-standby	Configure mlag mode for mlag3
(config-if)#switchover type revertive 10	Configure revertive timer
(config-if)#end	Return to privilege mode
#configure terminal	Enter Configure mode.
(config)#interface sa3	Enter Interface mode
(config-if)#mlag 3	Map sa3 to mlag3
(config-if)#end	Return to privilege mode
#configure terminal	Enter Configure mode.
(config-if)# interface sa1	Enter sa interface mode
(config-if)#port-channel min-links 3	Configure min-link value on sa interface

(config)#interface sa3	Enter sa Interface mode
(config-if)#port-channel min-bandwidth 30g	Configure min-bandwidth value on sa interface.

**SW1**

configure terminal	Enter Configure mode.
bridge 1 protocol rstp vlan-bridge	Configure bridge type
(config)#vlan database	Create vlan database
(config-vlan)#vlan 600,601,502,101,100 bridge 1 state enable	Create Vlans
(config-vlan)#end	Return to privilege mode
configure terminal	Enter Configure mode.
(config)#interface xe1	Enter Interface mode
(config-if)# switchport	Make xe1 as layer2 port
(config-if)# bridge-group 1	Associate the interface with bridge group 1.
(config-if)# switchport mode trunk	Set the switching characteristics of this interface to trunk mode.
(config-if)# switchport trunk allowed vlan all	Enable all VLAN identifiers on this interface.
(config-if)#spanning-tree edgeport	Configure port as edgeport
(config-if)#spanning-tree bpdu-filter enable	Enable spanning tree bpdu filter
(config-if)# mtu 9216	Configure mtu
(config-if)#end	Return to privilege mode
configure terminal	Enter Configure mode.
(config)#interface sa1	Enter Interface mode
(config-if)# switchport	Make xe1 as layer2 port
(config-if)# bridge-group 1	Associate the interface with bridge group 1.
(config-if)# switchport mode trunk	Set the switching characteristics of this interface to trunk mode.
(config-if)# switchport trunk allowed vlan add 100,101,300,401,402	Enable all VLAN identifiers on this interface.
(config-if)#spanning-tree edgeport	Configure port as edgeport
(config-if)#spanning-tree bpdu-filter enable	Enable spanning tree bpdu filter
(config-if)# mtu 9216	Configure mtu
(config-if)#end	Return to privilege mode
#configure terminal	Enter Configure mode.
(config)#interface xe2	Enter Interface mode
(config-if)# static-channel-group 1	Add interface to sa1
(config-if)#end	Return to privilege mode
#configure terminal	Enter Configure mode.
(config)#interface xe3	Enter Interface mode
(config-if)# static-channel-group 1	Add interface to sa1
(config-if)#end	Return to privilege mode
#configure terminal	Enter Configure mode.

## Link Aggregation Configuration

(config)#interface xe4	Enter Interface mode
(config-if)# static-channel-group 1	Add interface to sa1
(config-if)#end	Return to privilege mode
#configure terminal	Enter Configure mode.
(config)#interface xe6	Enter Interface mode
(config-if)# static-channel-group 1	Add interface to sa3
(config-if)#end	Return to privilege mode
#configure terminal	Enter Configure mode.
(config)#interface xe7	Enter Interface mode
(config-if)# static-channel-group 1	Add interface to sa3
(config-if)#end	Return to privilege mode
#configure terminal	Enter Configure mode.
(config)#interface xe8	Enter Interface mode
(config-if)# static-channel-group 1	Add interface to sa3
(config-if)#end	Return to privilege mode

### SW2

configure terminal	Enter Configure mode.
bridge 1 protocol rstp vlan-bridge	Configure bridge type
(config)#vlan database	Create vlan database
(config-vlan)#vlan 600,601,502,101,100 bridge 1 state enable	Create vlans
(config-vlan)#end	Return to privilege mode
configure terminal	Enter Configure mode.
(config)#interface xe5/1	Enter Interface mode
(config-if)# switchport	Make xe1 as layer2 port
(config-if)# bridge-group 1	Associate the interface with bridge group 1.
(config-if)# switchport mode trunk	Set the switching characteristics of this interface to trunk mode.
(config-if)# switchport trunk allowed vlan all	Enable all VLAN identifiers on this interface.
(config-if)#spanning-tree edgeport	Configure port as edge port
(config-if)#spanning-tree bpdu-filter enable	Enable spanning tree bpdu filter
(config-if)# mtu 9216	Configure mtu
(config-if)#end	Return to privilege mode
configure terminal	Enter Configure mode.
(config)#interface sa3	Enter Interface mode
(config-if)# switchport	Make sa3 as layer2 port
(config-if)# bridge-group 1	Associate the interface with bridge group 1.
(config-if)# switchport mode trunk	Set the switching characteristics of this interface to trunk mode.
(config-if)# switchport trunk allowed vlan add 100,101,401,402,600,502	Enable all VLAN identifiers on this interface.



(config-if)#spanning-tree edgeport	Configure port as edge port
(config-if)#spanning-tree bpdu-filter enable	Enable spanning tree bpdu filter
(config-if)# mtu 9216	Configure mtu
(config-if)#end	Return to privilege mode
#configure terminal	Enter Configure mode.
(config)#interface xe3/1	Enter Interface mode
(config-if)# static-channel-group 3	Add interface to sa3
(config-if)#end	Return to privilege mode
#configure terminal	Enter Configure mode.
(config)#interface xe3/2	Enter Interface mode
(config-if)# static-channel-group 3	Add interface to sa3
(config-if)#end	Return to privilege mode
#configure terminal	Enter Configure mode.
(config)#interface xe3/3	Enter Interface mode
(config-if)# static-channel-group 3	Add interface to sa3
(config-if)#end	Return to privilege mode
#configure terminal	Enter Configure mode.
(config)#interface xe1/1	Enter Interface mode
(config-if)# static-channel-group 3	Add interface to sa3
(config-if)#end	Return to privilege mode
#configure terminal	Enter Configure mode.
(config)#interface xe1/2	Enter Interface mode
(config-if)# static-channel-group 3	Add interface to sa3
(config-if)#end	Return to privilege mode
#configure terminal	Enter Configure mode.
(config)#interface xe1/3	Enter Interface mode
(config-if)# static-channel-group 3	Add interface to sa3
(config-if)#end	Return to privilege mode

This configuration is applicable for the dynamic LAG with MC-LAG topology except dynamic LAG interface creations, which needs to be referred from the dynamic LAG configurations given above.

## Validation Commands

sh int brief sa [id], sh int brief po [id], sh mlag-domain summary, sh static-channel-group <sa id>, <sh etherchannel>, sh running-config interface sa [id], <sh etherchannel summary>.

When sa or po goes down due to min-link or min-bandwidth not satisfied, below validations to be done:

### SW2

```
#sh int brief sa1
Codes: ETH - Ethernet, LB - Loopback, AGG - Aggregate, MLAG - MLAG Aggregate
      FR - Frame Relay, TUN -Tunnel, PBB - PBB Logical Port, VP - Virtual
Port
      CVP - Channelised Virtual Port, METH - Management Ethernet, UNK-
Unknown
```

## Link Aggregation Configuration

---

ED - ErrDisabled, PD - Protocol Down, AD - Admin Down,  
IA - InActive  
PD(Min L/B) - Protocol Down Min-Links/Bandwidth  
DV - DDM Violation, NA - Not Applicable  
NOM - No operational members, PVID - Port Vlan-id  
Ctl - Control Port (Br-Breakout/Bu-Bundle)  
HD - ESI Hold Timer Down

```
-----  
Port-channel Type  PVID  Mode                Status  Reason  Speed  
Interface  
-----
```

```
--  
sa1             AGG    1      trunk                down    PD(Min L/B)  0
```

```
#  
#sh int brief po100
```

Codes: ETH - Ethernet, LB - Loopback, AGG - Aggregate, MLAG - MLAG Aggregate  
FR - Frame Relay, TUN -Tunnel, PBB - PBB Logical Port, VP - Virtual

Port

CVP - Channelised Virtual Port, METH - Management Ethernet, UNK-  
Unknown

ED - ErrDisabled, PD - Protocol Down, AD - Admin Down,  
IA - InActive

PD(Min L/B) - Protocol Down Min-Links/Bandwidth

DV - DDM Violation, NA - Not Applicable

NOM - No operational members, PVID - Port Vlan-id

Ctl - Control Port (Br-Breakout/Bu-Bundle)

HD - ESI Hold Timer Down

```
-----  
--  
Port-channel  Type  PVID  Mode                Status  Reason  Speed  
Interface  
-----
```

```
--  
po100         AGG    1      trunk                down    PD(Min L/B)  0
```

```
#  
#sh etherchannel  
% LACP Aggregator: po100  
% Min-Bandwidth : 40g  
% Protocol Down (Min L/B) : True  
% Member:  
  ce3/1  
  ce3/2  
  ce3/3  
  ce3/4
```

```
-----  
% LACP Aggregator: po200  
% Member:  
  ce29/1  
  ce29/2
```

```
-----  
% LACP Aggregator: sa1  
% Min-links : 3
```

```
% Protocol Down (Min L/B): True
% Member:
  ce2/2
  ce2/3
  ce2/4
-----
% LACP Aggregator: sa3
% Member:
  ce4/1
  ce4/2
  ce4/3
#
#sh running-config interface sa1
!
interface sa1
  switchport
  port-channel load-balance src-dst-mac
  port-channel min-links 3
  mlag 1
!

#sh static-channel-group 1
Static Aggregator: sa1
Minimum-Links 3
Member Status
  ce2/2          down
  ce2/3          down
  ce2/4          down
#
#sh etherchannel summary
Aggregator po100 100100
Aggregator Type: Layer2
Admin Key: 0100 - Oper Key 0100
  Link: ce3/1 (5057) sync: 0
  Link: ce3/2 (5058) sync: 0
  Link: ce3/3 (5059) sync: 0
  Link: ce3/4 (5060) sync: 0
-----
```

---

## LACP Force-Up

In an aggregated environment, there are some parameters that are set for member ports in lag. Whenever the parameters are set and conditions are satisfied, the port channel will be in SYNC. If force-up mode is enabled for the member port, the port channel will always be in SYNC even if the parameters are not set i.e. the traffic will not be affected and the port channel will never go down.

## LACP force-up with Dynamic LAG

### Topology

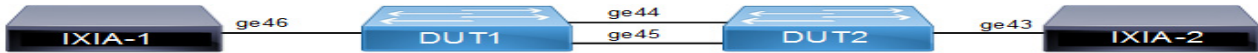

Figure 8-14: LACP force-up with Dynamic LAG

### CE1

#configure terminal	Enter configure mode.
(config)#hostname CE1	Configure host name
(config)#bridge 1 protocol rstp vlan-bridge	Create a RSTP VLAN bridge on customer side
(config)#vlan 2-100 bridge 1 state enable	Configure VLAN for the bridge
(config)#interface ge46	Enter interface mode
(config-if)#switchport	Make interface as Switchport
(config-if)#bridge-group 1	Associate the interface to bridge
(config-if)#switchport mode hybrid	Configure the mode as hybrid
(config-if)#switchport hybrid allowed vlan all	Configure allowed VLAN all on the interface
(config-if)#load-interval 30	Configure load period in multiple of 30 seconds
(config)#interface po1	Enter the interface mode
(config-if)#switchport	Make the interface as switch port
(config-if)#bridge-group 1	Associate the interface to bridge
(config-if)#switchport mode hybrid	Configure the mode as hybrid
(config-if)#switchport hybrid allowed vlan all	Configure allowed vlan all for the hybrid mode
(config-if)#load-interval 30	Configure load period in multiple of 30 seconds
(config)#interface ge44	Enter interface mode
(config-if)#channel-group 1 mode active	Adding interface to channel-group 1
(config)#interface ge45	Enter interface mode
(config-if)#channel-group 1 mode active	Adding interface to channel-group 1

### CE2

#configure terminal	Enter configure mode.
(config)#hostname CE2	Configure host name
(config)#bridge 1 protocol provider-rstp edge	Create provider rstp edge bridge
(config)#vlan database	Enter vlan database mode
(config-vlan)#vlan 2-100 type customer bridge 1 state enable	Configure customer VLAN for the bridge
(config-vlan)#vlan 100 type service point-point bridge 1 state enable	Configure service VLAN for the bridge

(config)#exit	Exit vlan database mode
(config)#cvlan registration table map1 bridge 1	Creating registration table
(config)#cvlan 2-100 svlan 100	Mapping cvlan to svlan
(config)#interface ge43	Enter interface mode
(config-if)#switchport	Make interface as Switchport
(config-if)#bridge-group 1	Associate the interface to bridge
(config-if)#switchport mode provider-network	Configure the mode as provider-network
(config-if)# switchport provider-network allowed vlan all	Configure allowed VLAN all on the interface
(config-if)#load-interval 30	Configure load period in multiple of 30 seconds
(config)#interface po1	Enter the interface mode
(config-if)#switchport	Make the interface as switch port
(config-if)#bridge-group 1	Associate the interface with bridge group 1
(config-if)#switchport mode customer-edge hybrid	Set the switching characteristics of this interface to customer-edge hybrid
(config-if)#switchport customer-edge hybrid allowed vlan all	Set the switching characteristics of this interface to customer-edge hybrid and allow vlan all
(config-if)#switchport customer-edge vlan registration map1	Configuring the registration table mapping on lag interface
(config-if)#load-interval 30	Configure load period in multiple of 30 seconds
(config)#interface ge44	Enter interface mode
(config-if)#channel-group 1 mode active	Adding interface to channel-group 1
(config-if)#lacp force-up	Enable lacp force-up for the member port interface
(config)#interface ge45	Enter interface mode
(config-if)#channel-group 1 mode active	Adding interface to channel-group 1

Send L2 traffic with incremental source mac of 1000 and with VLAN 100 from CE1 and with incremental source mac of 1000 and with SVLAN 100(TPID 0x88a8), CVLAN 100 from CE2.

## Validation

### CE1

```
CE1#show mac address-table count bridge 1
MAC Entries for all vlans:
Dynamic Address Count: 2001
Static (User-defined) Unicast MAC Address Count: 0
Static (User-defined) Multicast MAC Address Count: 0
Total MAC Addresses in Use: 2001
```

```
CE1#show etherchannel summary
  Aggregator po1 100001
  Aggregator Type: Layer2
  Admin Key: 0001 - Oper Key 0001
  Link: ge44 (5043) sync: 1
```

## Link Aggregation Configuration

Link: ge45 (5046) sync: 1

CE1#show interface counters rate mbps

Interface	Rx mbps	Rx pps	Tx mbps	Tx pps
ge44	363.65	710252	772.76	1420506
ge45	363.63	710222	0.00	0
ge46	772.77	1420525	727.31	1420526
po1	728.56	1422971	774.09	1422966

CE2#show mac address-table count bridge 1

MAC Entries for all vlans:

Dynamic Address Count: 2001

Static (User-defined) Unicast MAC Address Count: 0

Static (User-defined) Multicast MAC Address Count: 0

Total MAC Addresses in Use: 2001

CE2#show interface counters rate mbps

Interface	Rx mbps	Rx pps	Tx mbps	Tx pps
ge43	774.26	1423267	784.17	1361411
ge44	774.26	1423268	364.36	711634
ge45	0.00	0	364.36	711634
po1	774.26	1423267	728.71	1423267

CE2#show etherchannel summary

Aggregator po1 100001

Aggregator Type: Layer2

Admin Key: 0001 - Oper Key 0001

Link: ge44 (5020) sync: 1

Link: ge45 (5022) sync: 1

On server side (PE1) to make LAG down you can unconfigure the channel-group 1 configurations and verify force-up is getting enabled in PE2.

To simulate the force-up

PE1(config)#interface ge44	Enter interface mode.
PE1(config-if)#no channel-group	Removing channel-group configurations from interface.
PE1(config)#interface ge45	Enter interface mode.
PE1(config-if)#no channel-group	Removing channel-group configurations from interface.

## PE2

PE2#show interface brief | include po1

po1 AGG 1 customer-edge up none 1g

PE2#show etherchannel summary

Aggregator po1 100001

Aggregator Type: Layer2

```
Admin Key: 0001 - Oper Key 0001
  Link: ge44 (5020) sync: 0 (force-up)
  Link: ge45 (5022) sync: 0
```

```
PE2#show etherchannel detail
Aggregator po1 100001
Aggregator Type: Layer2
Mac address: b8:6a:97:4d:65:d5
Admin Key: 0001 - Oper Key 0001
  Actor LAG ID- 0x8000,b8-6a-97-28-a5-c0,0x0001
  Receive link count: 0 - Transmit link count: 0
  Individual: 0 - Ready: 1
  Partner LAG ID- 0x0000,00-00-00-00-00-00,0x0000
  Link: ge44 (5020) sync: 0 (force-up)
  Link: ge45 (5022) sync: 0
Collector max delay: 5
```

To forward traffic from ge44 of PE1

PE1(config)#interface ge44	Enter interface mode.
PE1(config-if)#switchport	Make the interface as switch port.
PE1(config-if)#bridge-group 1	Associate the interface to bridge.
PE1(config-if)#switchport mode hybrid	Configure the mode as hybrid.
PE1(config-if)#switchport hybrid allowed vlan all	Configure allowed vlan all for the hybrid mode.
PE1(config-if)#load-interval 30	Configure load period in multiple of 30 seconds.

```
PE2#show interface counters rate mbps
+-----+-----+-----+-----+
| Interface | Rx mbps | Rx pps | Tx mbps | Tx pps |
+-----+-----+-----+-----+
ge43        774.25   1423257   784.17   1361400
ge44        774.25   1423258   728.71   1423257
ge45         0.00     0         0.00     0
po1         774.25   1423247   728.70   1423245
CE2#
```

```
PE1#show interface counters rate mbps
+-----+-----+-----+-----+
| Interface | Rx mbps | Rx pps | Tx mbps | Tx pps |
+-----+-----+-----+-----+
ge44        657.67   1284505   640.77   1177884
ge45         0.00     0         0.00     0
ge46        772.71   1420426   603.08   1177886
```





## CHAPTER 9 MLAG Configuration

This chapter contains a complete example of Multi-Chassis Link Aggregation (MLAG) configuration.

MLAG (also called DRNI, Distributed Resilient Network Interconnect) expands the concept of link aggregation so that it provides node-level redundancy by allowing two or more nodes to share a common LAG endpoint. MLAG emulates multiple nodes to represent as a single logical node to the remote node running link aggregation. As a result even if one of the nodes is down there exists a path to reach the destination through the other nodes.

Note: MLAG is compatible only with a RSTP VLAN-aware bridge or a spanning tree disabled bridge.

Note: All MLAG nodes must have the same MAC table size as specified by each node's switching ASIC forwarding profile limit.

Note: More than one IDL is not supported in single node under mcec configuration.

### Dynamic Configuration

#### Topology

As shown in [Figure 9-15](#), switches 3 and 4 form an MLAG domain. Switches 3 and 4 are a single logical switch to switches 1 and 2. Even if either switch 3 or 4 is down, there exists a path to reach other destinations.

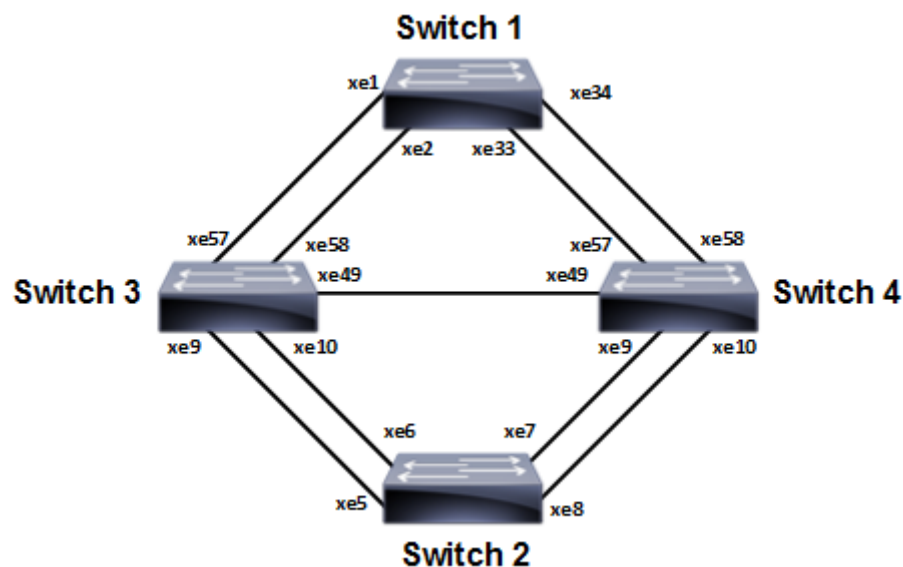

Figure 9-15: MLAG Topology

#### Switch 1

#configure terminal	Enter configure mode.
(config)#bridge 1 protocol rstp vlan-bridge	Create RSTP bridge 1.
(config)#vlan 2 bridge 1 state enable	Create VLAN 2.
(config)#interface po2	Enter interface mode.
(config-if)#switchport	Configure the interface as Layer 2

## MLAG Configuration

<code>(config-if)#bridge-group 1</code>	Associate the interface with bridge group 1.
<code>(config-if)#switchport mode trunk</code>	Set the switching characteristics of this interface to trunk mode.
<code>(config-if)#switchport trunk allowed vlan all</code>	Enable all VLAN identifiers on this interface.
<code>(config-if)#exit</code>	Exit interface mode.
<code>(config)#interface xe1</code>	Enter interface mode.
<code>(config-if)#channel-group 2 mode active</code>	Add this interface to channel group 2 and enable link aggregation so that it can be selected for aggregation by the local system.
<code>(config-if)#exit</code>	Exit interface mode.
<code>(config)#interface xe2</code>	Enter interface mode.
<code>(config-if)#channel-group 2 mode active</code>	Add this interface to channel group 2 and enable link aggregation so that it can be selected for aggregation by the local system.
<code>(config-if)#exit</code>	Exit interface mode.
<code>(config)#interface xe33</code>	Enter interface mode.
<code>(config-if)#channel-group 2 mode active</code>	Add this interface to channel group 2 and enable link aggregation so that it can be selected for aggregation by the local system.
<code>(config-if)#exit</code>	Exit interface mode.
<code>(config)#interface xe34</code>	Enter interface mode.
<code>(config-if)#channel-group 2 mode active</code>	Add this interface to channel group 2 and enable link aggregation so that it can be selected for aggregation by the local system.
<code>(config-if)#exit</code>	Exit interface mode.

## Switch 2

<code>#configure terminal</code>	Enter configure mode.
<code>(config)#bridge 1 protocol rstp vlan-bridge</code>	Create RSTP bridge 1.
<code>(config)#vlan 2 bridge 1 state enable</code>	Create VLAN 2.
<code>(config)#interface po1</code>	Enter interface mode.
<code>(config-if)#switchport</code>	Configure the interface as Layer 2
<code>(config-if)#bridge-group 1</code>	Associate the interface with bridge group 1.
<code>(config-if)#switchport mode trunk</code>	Set the switching characteristics of this interface to trunk mode.
<code>(config-if)#switchport trunk allowed vlan all</code>	Enable all VLAN identifiers on this interface.
<code>(config-if)#exit</code>	Exit interface mode.
<code>(config)#interface xe5</code>	Enter interface mode.
<code>(config-if)#channel-group 1 mode active</code>	Add this interface to channel group 1 and enable link aggregation so that it can be selected for aggregation by the local system.
<code>(config-if)#exit</code>	Exit interface mode.
<code>(config)#interface xe6</code>	Enter interface mode.

(config-if)#channel-group 1 mode active	Add this interface to channel group 1 and enable link aggregation so that it can be selected for aggregation by the local system.
(config-if)#exit	Exit interface mode.
(config)#interface xe7	Enter interface mode.
(config-if)#channel-group 1 mode active	Add this interface to channel group 1 and enable link aggregation so that it can be selected for aggregation by the local system.
(config-if)#exit	Exit interface mode.
(config)#interface xe8	Enter interface mode.
(config-if)#channel-group 1 mode active	Add this interface to channel group 1 and enable link aggregation so that it can be selected for aggregation by the local system.
(config-if)#exit	Exit interface mode.

### Switch 3

#configure terminal	Enter configure mode.
(config)#bridge 1 protocol rstp vlan-bridge	Create RSTP bridge 1.
(config)#vlan 2 bridge 1 state enable	Create VLAN 2.
(config)#interface mlag1	Enter interface mode.
(config-if)#switchport	Configure the interface as Layer 2
(config-if)#bridge-group 1	Associate the interface with bridge group 1.
(config-if)#switchport mode trunk	Set the switching characteristics of this interface to trunk mode.
(config-if)#switchport trunk allowed vlan all	Enable all VLAN identifiers on this interface.
(config-if)#exit	Exit interface mode.
(config)#interface mlag2	Enter interface mode.
(config-if)#switchport	Configure the interface as Layer 2
(config-if)#bridge-group 1	Associate the interface with bridge group 1.
(config-if)#switchport mode trunk	Set the switching characteristics of this interface to trunk mode.
(config-if)#switchport trunk allowed vlan all	Enable all VLAN identifiers on this interface.
(config-if)#exit	Exit interface mode.
(config)#interface po1	Enter interface mode.
(config-if)#switchport	Configure the interface as Layer 2
(config-if)#mlag 1	Enabling Mlag group number
(config-if)#exit	Exit interface mode.
(config)#interface po2	Enter interface mode.
(config-if)#switchport	Configure the interface as Layer 2
(config-if)#mlag 2	enabling Mlag group number
(config-if)#exit	Exit interface mode.
(config)#interface xe9	Enter interface mode.

## MLAG Configuration

<code>(config-if)#channel-group 1 mode active</code>	Add this interface to channel group 1 and enable link aggregation so that it can be selected for aggregation by the local system.
<code>(config-if)#exit</code>	Exit interface mode.
<code>(config)#interface xe57</code>	Enter interface mode.
<code>(config-if)#channel-group 2 mode active</code>	Add this interface to channel group 2 and enable link aggregation so that it can be selected for aggregation by the local system.
<code>(config-if)#exit</code>	Exit interface mode.
<code>(config)#interface xe58</code>	Enter interface mode.
<code>(config-if)#channel-group 2 mode active</code>	Add this interface to channel group 2 and enable link aggregation so that it can be selected for aggregation by the local system.
<code>(config-if)#exit</code>	Exit interface mode.
<code>(config)#interface xe10</code>	Enter interface mode.
<code>(config-if)#channel-group 1 mode active</code>	Add this interface to channel group 1 and enable link aggregation so that it can be selected for aggregation by the local system.
<code>(config-if)#exit</code>	Exit interface mode.
<code>(config)#mcec domain configuration</code>	Entering MCEC mode
<code>(config-mcec-domain)#domain-address 1111.2222.3333</code>	Domain address for the mlag domain
<code>(config-mcec-domain)#intra-domain link xe49</code>	Intra domain line between mlag domain
<code>(config-mcec-domain)#domain-system-number 1</code>	Number to identify the node in a domain
<code>(config-mcec-domain)#exit</code>	Exit MCEC mode

## Switch 4

<code>#configure terminal</code>	Enter configure mode.
<code>(config)#bridge 1 protocol rstp vlan-bridge</code>	Create RSTP bridge 1.
<code>(config)#vlan 2 bridge 1 state enable</code>	Create VLAN 2.
<code>(config)#interface mlag1</code>	Enter interface mode.
<code>(config-if)#switchport</code>	Configure the interface as Layer 2
<code>(config-if)#bridge-group 1</code>	Associate the interface with bridge group 1.
<code>(config-if)#switchport mode trunk</code>	Set the switching characteristics of this interface to trunk mode.
<code>(config-if)#switchport trunk allowed vlan all</code>	Enable all VLAN identifiers on this interface.
<code>(config-if)#exit</code>	Exit interface mode.
<code>(config)#interface mlag2</code>	Enter interface mode.
<code>(config-if)#switchport</code>	Configure the interface as Layer 2
<code>(config-if)#bridge-group 1</code>	Associate the interface with bridge group 1.
<code>(config-if)#switchport mode trunk</code>	Set the switching characteristics of this interface to trunk mode.
<code>(config-if)#switchport trunk allowed vlan all</code>	Enable all VLAN identifiers on this interface.

(config-if)#exit	Exit interface mode.
(config)#interface po1	Enter interface mode.
(config-if)#switchport	Configure the interface as Layer 2
(config-if)#mlag 1	Enabling Mlag group number
(config-if)#exit	Exit interface mode.
(config)#interface po2	Enter interface mode.
(config-if)#switchport	Configure the interface as Layer 2
(config-if)#mlag 2	enabling Mlag group number
(config-if)#exit	Exit interface mode.
(config)#interface xe9	Enter interface mode.
(config-if)#channel-group 1 mode active	Add this interface to channel group 1 and enable link aggregation so that it can be selected for aggregation by the local system.
(config-if)#exit	Exit interface mode.
(config)#interface xe10	Enter interface mode.
(config-if)#channel-group 1 mode active	Add this interface to channel group 1 and enable link aggregation so that it can be selected for aggregation by the local system.
(config-if)#exit	Exit interface mode.
(config)#interface xe57	Enter interface mode.
(config-if)#channel-group 2 mode active	Add this interface to channel group 2 and enable link aggregation so that it can be selected for aggregation by the local system.
(config-if)#exit	Exit interface mode.
(config)#interface xe58	Enter interface mode.
(config-if)#channel-group 2 mode active	Add this interface to channel group 2 and enable link aggregation so that it can be selected for aggregation by the local system.
(config-if)#exit	Exit interface mode.
(config)#mcec domain configuration	Entering MCEC mode
(config-mcec-domain)#domain-address 1111.2222.3333	Domain address for the Mlag domain
(config-mcec-domain)#intra-domain link xe49	Intra domain Link between Mlag domains
(config-mcec-domain)#domain-system-number 2	Number to identify the node in domain
(config-mcec-domain)#exit	Exit MCEC mode

## Validation

### Switch 3

```
#sh mlag domain details
```

```
-----  
Domain Configuration  
-----
```

## MLAG Configuration

---

Domain System Number : 1  
Domain Address : 1111.2222.3333  
Domain Priority : 1000  
Intra Domain Interface : xe49

Hello RCV State : Current  
Hello Periodic Timer State : Fast Periodic  
Domain Sync : IN\_SYNC  
Neigh Domain Sync : IN\_SYNC  
Domain Adjacency : UP

-----  
MLAG Configuration  
-----

### MLAG-1

Mapped Aggregator : po1  
Admin Key : 16385  
Oper Key : 16385  
Physical properties Digest : dd 9c f 76 dd b6 5f 2f eb a1 d3 bb 8d 96 fc 82

Neigh Admin Key : 32769  
Neigh Physical Digest : dd 9c f 76 dd b6 5f 2f eb a1 d3 bb 8d 96 fc 82  
Info RCV State : Current  
Info Periodic Time State : Standby  
Mlag Sync : IN\_SYNC  
Mode : Active

### MLAG-2

Mapped Aggregator : po2  
Admin Key : 16386  
Oper Key : 16386  
Physical properties Digest : dd 9c f 76 dd b6 5f 2f eb a1 d3 bb 8d 96 fc 82

Neigh Admin Key : 32770  
Neigh Physical Digest : dd 9c f 76 dd b6 5f 2f eb a1 d3 bb 8d 96 fc 82  
Info RCV State : Current  
Info Periodic Time State : Standby  
Mlag Sync : IN\_SYNC  
Mode : Active

### #sh etherchannel summary

% Aggregator po1 0  
% Aggregator Type: Layer2  
% Admin Key: 16385 - Oper Key 16385  
% Link: xe57 (5057) sync: 1  
% Link: xe58 (5058) sync: 1  
% Aggregator po2 0  
% Aggregator Type: Layer2

---

% Admin Key: 16386 - Oper Key 16386

% Link: xe9 (5009) sync: 1

% Link: xe10 (5010) sync: 1

#sh mlag 1 detail

MLAG-1

Mapped Aggregator : po1  
Admin Key : 16385  
Oper Key : 16385  
Physical properties Digest : dd 9c f 76 dd b6 5f 2f eb a1 d3 bb 8d 96 fc 82

Neigh Admin Key : 32769  
Neigh Physical Digest : dd 9c f 76 dd b6 5f 2f eb a1 d3 bb 8d 96 fc 82  
Info RCV State : Current  
Info Periodic Time State : Standby  
Total Bandwidth : 20g  
Mlag Sync : IN\_SYNC  
Mode : Active

sh mcec statistics

Unknown MCCPDU received on the system : 0

-----  
IDP xe49  
-----

Valid RX Hello PDUs : 398  
Valid TX Hello PDUs : 417  
Valid RX Info PDUs : 16  
Valid TX Info PDUs : 6

Valid RX Mac Sync PDUs : 3  
Valid TX Mac Sync PDUs : 4

MLAG 1

Valid RX Info PDUs : 8  
Valid TX Info PDUs : 3

MLAG 2

Valid RX Info PDUs : 8  
Valid TX Info PDUs : 3

sh mlag domain summary

-----  
Domain Configuration  
-----

Domain System Number : 1  
Domain Address : 1111.2222.3333

## MLAG Configuration

---

Domain Priority : 1000  
Intra Domain Interface : xe49  
Domain Adjacency : UP

-----  
MLAG Configuration  
-----

### MLAG-1

Mapped Aggregator : po1  
Physical properties Digest : dd 9c f 76 dd b6 5f 2f eb a1 d3 bb 8d 96 fc 82  
Total Bandwidth : 40g  
Mlag Sync : IN\_SYNC  
Mode : Active

### MLAG-2

Mapped Aggregator : po2  
Physical properties Digest : dd 9c f 76 dd b6 5f 2f eb a1 d3 bb 8d 96 fc 82  
Total Bandwidth : 40g  
Mlag Sync : IN\_SYNC  
Mode : Active



## Static Configuration

Static MLAG provides node-level redundancy by allowing two or more nodes in the network to share a common static-LAG endpoint. It emulates multiple nodes to represent as a single logical node to the remote node having static Link aggregation. As a result, even if one of the nodes is down there exists a path to reach the destination via other nodes.

## Topology

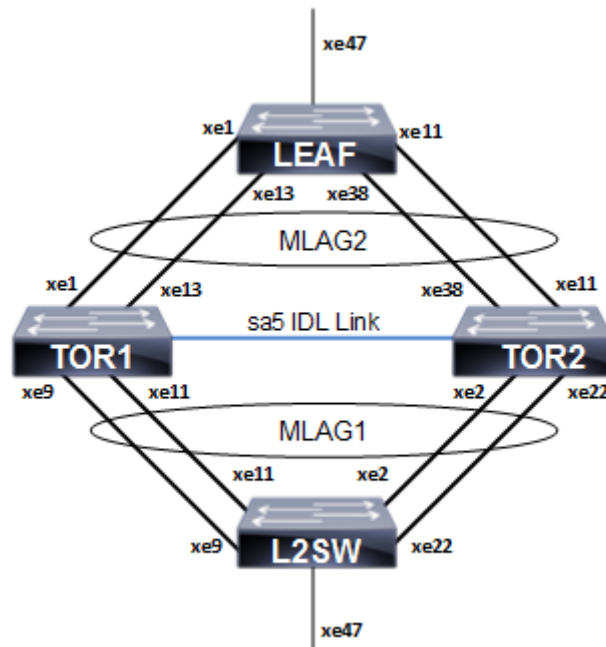

Figure 9-16: Static MLAG topology

## L2SW

#configure terminal	Enter configure mode.
(config)#hostname L2SW	Configuring host name
(config)#bridge 1 protocol rstp vlan-bridge	Create a RSTP VLAN bridge on customer side
(config)#vlan 2 bridge 1 state enable	Configure VLAN for the bridge
(config)#interface sa1	Enter the interface mode
(config-if)#bridge-group 1 spanning-tree disable	Disable the spanning-tree for the interface
(config-if)#switchport mode hybrid	Configure the mode as hybrid
(config-if)#switchport hybrid allowed vlan all	Configure allowed VLAN all on the interface
(config-if)#exit	Exit the interface mode
(config)#interface xe2	Enter the interface mode
(config-if)#static-channel-group 1	Map static channel to the interface
(config-if)#exit	Exit the interface mode
(config)#interface xe9	Enter the interface mode

## MLAG Configuration

(config-if)#static-channel-group 1	Map static channel to the interface
(config-if)#exit	Exit the interface mode
(config)#interface xe11	Enter the interface mode
(config-if)#static-channel-group 1	Map static channel to the interface
(config-if)#exit	Exit the interface mode
(config)#interface xe22	Enter the interface mode
(config-if)#static-channel-group 1	Map static channel to the interface
(config-if)#exit	Exit the interface mode
(config)#interface xe47	Enter the interface mode
(config-if)#switchport	Make the interface as switch port
(config-if)#bridge-group 1 spanning-tree disable	Disable the spanning-tree for the interface
(config-if)#switchport mode hybrid	Configure the mode as hybrid
(config-if)#switchport hybrid allowed vlan all	Configure allowed VLAN all on the interface
(config-if)#exit	Exit the interface mode

## TOR1

#configure terminal	Enter configure mode.
(config)#hostname TOR1	Configuring host name
(config)#bridge 1 protocol provider-rstp edge	Create a PROVIDER-RSTP EDGE bridge
(config)#vlan 2 bridge 1 state enable	Configure VLAN for the bridge
(config)#vlan 200 type service point-point bridge 1 state enable	Configure SVLAN for the bridge
(config)#cvlan registration table map1 bridge 1	Configure cvlan-svlan mapping registration table for the bridge
(config-cvlan-registration)#cvlan 2 svlan 200	Map CVLAN to SVLAN
(config-cvlan-registration)#exit	Exit the config-cvlan-registration mode
(config)#interface mlag1	Enter the interface mode
(config-if)#switchport	Make the interface as switch port
(config-if)#bridge-group 1	Associate the interface to bridge
(config-if)#switchport mode customer-edge hybrid	Configure the mode as customer-edge hybrid
(config-if)#switchport customer-edge hybrid allowed vlan all	Configure allowed VLAN all on the interface
(config-if)#switchport customer-edge vlan registration map1	Map the cvlan registration table into the MLAG interface
(config-if)#exit	Exit the interface mode
(config)#interface mlag2	Enter the interface mode
(config-if)#switchport	Make the interface as switch port
(config-if)#bridge-group 1	Associate the interface to bridge
(config-if)#switchport mode provider-network	Configure the mode as provider-network

(config-if)#switchport provider-network allowed vlan all	Configure allowed VLAN all on the interface
(config)#interface sa1	Enter the interface mode
(config-if)#switchport	Make the interface as switch port
(config-if)#mlag 1	Map MLAG on SA interface
(config-if)#exit	Exit the interface mode
(config)#interface sa2	Enter the interface mode
(config-if)#switchport	Make the interface as switch port
(config-if)#mlag 2	Map MLAG on SA interface
(config-if)#exit	Exit the interface mode
(config)#interface xe1	Enter the interface mode
(config-if)#static-channel-group 2	Map static channel-group to the interface
(config-if)#exit	Exit the interface mode
(config)#interface xe13	Enter the interface mode
(config-if)#static-channel-group 2	Map static channel-group to the interface
(config-if)#exit	Exit the interface mode
(config)#interface xe9	Enter the interface mode
(config-if)#static-channel-group 1	Map static channel-group to the interface
(config-if)#exit	Exit the interface mode
(config)#interface xe11	Enter the interface mode
(config-if)#static-channel-group 1	Map static channel to the interface
(config-if)#exit	Exit the interface mode
(config)#interface sa5	Enter the interface mode
(config-if)#switchport	Make the interface as switch port
(config-if)#bridge-group 1	Associate the interface to bridge
(config-if)#switchport mode provider-network	Configure the mode as provider network
(config-if)#switchport provider-network allowed vlan all	Configure allowed VLAN all on the interface
(config)#interface xe3	Enter the interface mode
(config-if)#static-channel-group 5	Map static channel-group to the interface
(config)#interface xe5	Enter the interface mode
(config-if)#static-channel-group 5	Map static channel-group to the interface
(config-if)#exit	Exit the interface mode
(config)#mcec domain configuration	Enter the MLAG domain configuration mode
(config-mcec-domain)#domain-address 1111.2222.3333	Configure the MLAG domain address
(config-mcec-domain)#domain-system-number 1	Configure MLAG domain system number
(config-mcec-domain)#intra-domain-link sa5	Configure the intra domain link

**TOR2**

#configure terminal	Enter configure mode.
(config)#hostname TOR2	Configuring host name
(config)#bridge 1 protocol provider-rstp edge	Create a PROVIDER-RSTP EDGE bridge
(config)#vlan 2 bridge 1 state enable	Configure VLAN for the bridge
(config)#vlan 200 type service point-point bridge 1 state enable	Configure SVLAN for the bridge
(config)#cvlan registration table map1 bridge 1	Configure cvlan-svlan mapping registration table for the bridge
(config-cvlan-registration)#cvlan 2 svlan 200	Map CVLAN to SVLAN
(config-cvlan-registration)#exit	Exit the config-cvlan-registration mode
(config)#interface mlag1	Enter the interface mode
(config-if)#switchport	Make the interface as switch port
(config-if)#bridge-group 1	Associate the interface to bridge
(config-if)#switchport mode customer-edge hybrid	Configure the mode as customer-edge hybrid
(config-if)#switchport customer-edge hybrid allowed vlan all	Configure allowed VLAN all on the interface
(config-if)#switchport customer-edge vlan registration map1	Map the cvlan registration table into the MLAG interface
(config-if)#exit	Exit the interface mode
(config)#interface mlag2	Enter the interface mode
(config-if)#switchport	Make the interface as switch port
(config-if)#bridge-group 1	Associate the interface to bridge
(config-if)#switchport mode provider-network	Configure the mode as provider-network
(config-if)#switchport provider-network allowed vlan all	Configure allowed VLAN all on the interface
(config)#interface sa1	Enter the interface mode
(config-if)#switchport	Make the interface as switch port
(config-if)#mlag 1	Map MLAG on SA interface
(config-if)#exit	Exit the interface mode
(config)#interface sa2	Enter the interface mode
(config-if)#switchport	Make the interface as switch port
(config-if)#mlag 2	Map MLAG on SA interface
(config-if)#exit	Exit the interface mode
(config)#interface xe11	Enter the interface mode
(config-if)#static-channel-group 2	Map static channel to the interface
(config-if)#exit	Exit the interface mode
(config)#interface xe38	Enter the interface mode
(config-if)#static-channel-group 2	Map static channel to the interface
(config-if)#exit	Exit the interface mode

(config)#interface xe2	Enter the interface mode
(config-if)#static-channel-group 1	Create static channel group
(config-if)#exit	Exit the interface mode
(config)#interface xe22	Enter the interface mode
(config-if)#static-channel-group 1	Create static channel group
(config-if)#exit	Exit the interface mode
(config)#interface sa5	Enter the interface mode
(config-if)#switchport	Make the interface as switch port
(config-if)#bridge-group 1	Associate the interface to bridge
(config-if)#switchport mode provider-network	Configure the mode as provider network
(config-if)#switchport provider-network allowed vlan all	Configure allowed VLAN all on the interface
(config)#interface xe3	Enter the interface mode
(config-if)#static-channel-group 5	Map static channel-group to the interface
(config)#interface xe5	Enter the interface mode
(config-if)#static-channel-group 5	Map static channel-group to the interface
(config-if)#exit	Exit the interface mode
(config)#mcec domain configuration	Enter the MLAG domain configuration mode
(config-mcec-domain)#domain-address 1111.2222.3333	Configure the MLAG domain address
(config-mcec-domain)#domain-system-number 2	Configure MLAG domain system number
(config-mcec-domain)#intra-domain-link sa5	Configure the intera domain link
(config-if)#exit	Exit the interface mode

## LEAF

#configure terminal	Enter configure mode.
(config)#hostname LEAF	Configuring host name
(config)#bridge 1 protocol provider-rstp edge	Create a PROVIDER-RSTP EDGE bridge
(config)#vlan 2 bridge 1 state enable	Configure VLAN for the bridge
(config)#vlan 200 type service point-point bridge 1 state enable	Configure SVLAN for the bridge
(config)#cvlan registration table map1 bridge 1	Configure cvlan-svlan mapping registration table for the bridge
(config-cvlan-registration)#cvlan 2 svlan 200	Map CVLAN to SVLAN
(config-cvlan-registration)#exit	Exit the config-cvlan-registration mode
(config)#interface sa2	Enter the interface mode
(config-if)#swtichport	Make the interface a switch port
(config-if)#bridge-group 1 spanning-tree disable	Disable the spanning-tree for the interface
(config-if)#switchport mode provider-network	Configure the mode as provider-network

## MLAG Configuration

(config-if)#)#switchport provider-network allowed vlan all	Configure allowed VLAN all on the interface
(config-if)#exit	Exit the interface mode
(config)#interface xe1	Enter the interface mode
(config-if)#static-channel-group 2	Map the interface to the static channel-group
(config-if)#exit	Exit the interface mode
(config)#interface xe13	Enter the interface mode
(config-if)#static-channel-group 2	Create static channel group
(config-if)#exit	Exit the interface mode
(config)#interface xe11	Enter the interface mode
(config-if)#static-channel-group 2	Map the interface to the static channel-group
(config-if)#exit	Exit the interface mode
(config)#interface xe38	Enter the interface mode
(config-if)#static-channel-group 2	Create static channel group
(config-if)#exit	Exit the interface mode
(config)#interface xe47	Enter the interface mode
(config-if)#switchport	Make the interface as switch port
(config-if)#bridge-group 1 spanning-tree disable	Disable the spanning-tree for the interface
(config-if)#switchport mode customer-edge hybrid	Configure the mode as customer-edge hybrid
(config-if)#switchport customer-edge hybrid allowed vlan all	Configure allowed VLAN all on the interface
(config-if)#switchport customer-edge vlan registration map1	Map the cvlan registration table into the MLAG interface
(config-if)#exit	Exit the interface mode

## Validation

```
TOR1#show mlag 1 detail
```

```
MLAG-1
```

```
 Mapped Aggregator           : sa1
 Admin Key                   : 16385
 Oper Key                    : 16385
 Physical properties Digest   : d a6 26 2d fa 9a 5c 7b e6 15 79 c2 d5 9c 57 cc
```

```
 Neigh Admin Key             : 32769
 Neigh Physical Digest       : d a6 26 2d fa 9a 5c 7b e6 15 79 c2 d5 9c 57 cc
 Info RCV State              : Current
 Info Periodic Time State    : Standby
 Total Bandwidth             : 40g
 Mlag Sync                   : IN_SYNC
 Mode                        : Active
```

```
TOR1#
```

---

TOR1#show mlag domain summary

-----  
Domain Configuration  
-----

Domain System Number : 1  
Domain Address : 1111.2222.3333  
Domain Priority : 32768  
Intra Domain Interface : sa5  
Domain Adjacency : UP

-----  
MLAG Configuration  
-----

MLAG-1

Mapped Aggregator : sa1  
Physical properties Digest : d a6 26 2d fa 9a 5c 7b e6 15 79 c2 d5 9c 57 cc  
Total Bandwidth : 40g  
Mlag Sync : IN\_SYNC  
Mode : Active

MLAG-2

Mapped Aggregator : sa2  
Physical properties Digest : ae 56 a1 c5 b9 dc 46 a4 5d 97 dc 79 9c 6f a5 c8  
  
Total Bandwidth : 40g  
Mlag Sync : IN\_SYNC  
Mode : Active

TOR1#

TOR1#show mlag domain detail

-----  
Domain Configuration  
-----

Domain System Number : 1  
Domain Address : 1111.2222.3333  
Domain Priority : 32768  
Intra Domain Interface : sa5  
  
Hello RCV State : Current  
Hello Periodic Timer State : Slow Periodic  
Domain Sync : IN\_SYNC  
Neigh Domain Sync : IN\_SYNC  
Domain Adjacency : UP

## MLAG Configuration

---

-----  
MLAG Configuration  
-----

### MLAG-1

Mapped Aggregator : sa1  
Admin Key : 16385  
Oper Key : 16385  
Physical properties Digest : d a6 26 2d fa 9a 5c 7b e6 15 79 c2 d5 9c 57 cc  
  
Neigh Admin Key : 32769  
Neigh Physical Digest : d a6 26 2d fa 9a 5c 7b e6 15 79 c2 d5 9c 57 cc  
Info RCV State : Current  
Info Periodic Time State : Standby  
Total Bandwidth : 40g  
Mlag Sync : IN\_SYNC  
Mode : Active

### MLAG-2

Mapped Aggregator : sa2  
Admin Key : 16386  
Oper Key : 16386  
Physical properties Digest : ae 56 a1 c5 b9 dc 46 a4 5d 97 dc 79 9c 6f a5 c8  
  
Neigh Admin Key : 32770  
Neigh Physical Digest : ae 56 a1 c5 b9 dc 46 a4 5d 97 dc 79 9c 6f a5 c8  
  
Info RCV State : Current  
Info Periodic Time State : Standby  
Total Bandwidth : 40g  
Mlag Sync : IN\_SYNC  
Mode : Active

TOR1#



## ARP ACL Configuration

### Topology

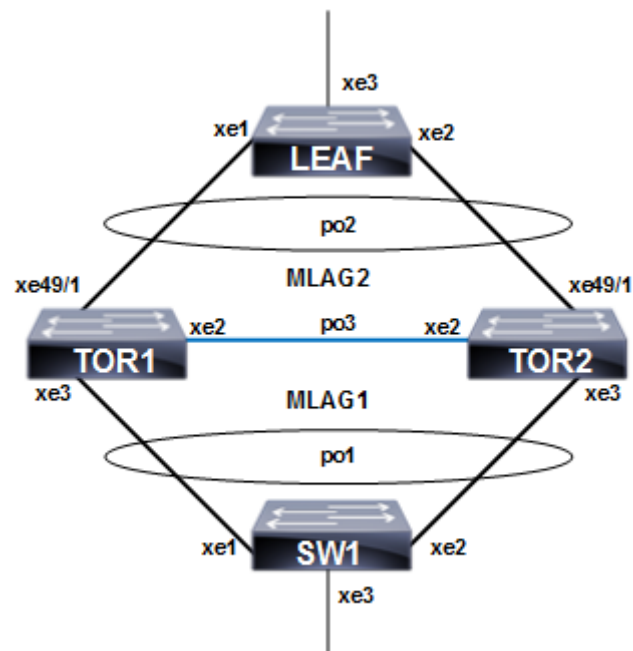

Figure 9-17: ARP ACL configuration with MC LAG

### TOR1

TOR1(config)#bridge 1 protocol provider-rstp edge	Create provider rstp bridge
TOR1(config)#vlan 2-3990 type customer bridge 1 state enable	Enable customer vlan for bridge
TOR1(config)#vlan 2-3990 type service point-point bridge 1 state enable	Enable service vlan for bridge
TOR1(config)#cvlan registration table map1 bridge 1	Create registration table
TOR1(config-cvlan-registration)#cvlan 2-3990 svlan 3990	Map cvlan to svlan
TOR1(config-cvlan-registration)#exit	Exit the cvlan registration table mode
TOR1(config-if)#interface mlag1	Enter mlag interface
TOR1(config-if)#switchport	Configure interface as switchport
TOR1(config-if)#bridge-group 1 spanning-tree disable	Associate the interface with bridge group 1 and disabling spanning-tree
TOR1(config-if)#switchport mode customer-edge hybrid	Set the switching characteristics of this interface to customer-edge hybrid
TOR1(config-if)#switchport customer-edge hybrid allowed vlan all	Set the switching characteristics of this interface to customer-edge hybrid and allow vlan all

## MLAG Configuration

TOR1(config-if)#switchport customer-edge vlan registration map1	Configure the registration table mapping on mlag interface
TOR1(config-if)#exit	Exit the interface mode
TOR1(config)#interface mlag2	Enter mlag interface
TOR1(config-if)#switchport	Configure interface as switchport
TOR1(config-if)#bridge-group 1	Associate the interface with bridge group 1
TOR1(config-if)#switchport mode provider- network	Set the switching characteristics of this interface to provider network
TOR1(config-if)#switchport provider-network allowed vlan all	Set the switching characteristics of this interface to provider network and allow all vlan
TOR1(config-if)#exit	Exit the interface mode
TOR1(config)#interface po1	Enter dynamic lag interface
TOR1(config-if)#switchport	Configure interface as switchport
TOR1(config-if)#mlag 1	Enable mlag group number
TOR1(config-if)#exit	Exit the interface mode
TOR1(config-if)#interface po2	Enter dynamic lag interface
TOR1(config-if)#switchport	Configure interface as switchport
TOR1(config-if)#mlag 2	Enable mlag group number
TOR1(config-if)#exit	Exit the interface mode
TOR1(config)#interface po3	Enter dynamic lag interface
TOR1(config-if)#switchport	Configure interface as switchport
TOR1(config-if)#bridge-group 1	Associate the interface with bridge group 1
TOR1(config-if)#switchport mode provider- network	Set the switching characteristics of this interface to provider network
TOR1(config-if)#switchport provider-network allowed vlan all	Set the switching characteristics of this interface to provider network and allow all vlan
TOR1(config)#interface xe2	Enter interface mode
TOR1(config-if)#channel-group 3 mode active	Make part of channel group 3
TOR1(config-if)#exit	Exit the interface mode
TOR1(config)#interface xe3	Enter interface mode
TOR1(config-if)#channel-group 1 mode active	Add this interface to channel group 1 and enable link aggregation so that it can be selected for aggregation by the local system
TOR1(config-if)#exit	Exit the interface mode
TOR1(config-if)#interface xe49/1	Enter interface mode
TOR1(config-if)#channel-group 2 mode active	Enable channel-group 2
TOR1(config-if)#exit	Exit the interface mode
TOR1(config)#mcec domain configuration	Enter MCEC mode
TOR1(config-mcec-domain)#domain-address 2222.3333.4444	Domain address for the mlag domain
TOR1(config-mcec-domain)#domain-system- number 1	Number to identify the node in a domain
TOR1(config-mcec-domain)#intra-domain-link po3	Intra domain line between mlag domain

TOR1(config)#hardware-profile filter ingress-arp enable	Enable globally hardware profile for arp
TOR1(config)#arp access-list cep	Create access list with name as cep
TOR1(config-arp-acl)#30 permit request ip any mac host 0000.2A6C.668D vlan 3990 inner-vlan 2	Create permit rule for particular arp request
TOR1(config-arp-acl)#40 permit response ip any any mac host 0000.2A6C.668D host 0000.2A6C.7202 vlan 3990 inner-vlan 2	Create permit rule for particular arp response
TOR1(config)#arp access-list pnp	Create access list with name as pnp
TOR1(config-arp-acl)#20 permit request ip any mac host 0000.2A6C.7202 vlan 3990 inner-vlan 2	Create permit rule for particular arp request
TOR1(config-arp-acl)#30 permit response ip any any mac host 0000.2A6C.7202 host 0000.2A6C.668D vlan 3990 inner-vlan 2	Create permit rule for particular arp response
TOR1(config-if)#interface mlag1	Enter mlag1 interface
TOR1(config-if)#arp access-group cep in	Attach rule with access-group cep
TOR1(config-if)#interface mlag2	Enter mlag2 interface
TOR1(config-if)#arp access-group pnp in	Attach rule with access-group pnp

## TOR2

TOR2(config)#bridge 1 protocol provider-rstp edge	Create provider rstp bridge
TOR2(config)#vlan 2-3990 type customer bridge 1 state enable	Enable customer vlan for bridge
TOR2(config)#vlan 2-3990 type service point-point bridge 1 state enable	Enable service vlan for bridge
TOR2(config)#cvlan registration table map1 bridge 1	Create registration table
TOR2(config-cvlan-registration)#cvlan 2-3990 svlan 3990	Map cvlan to svlan
TOR2(config-cvlan-registration)#exit	Exit the cvlan registration table mode
TOR2(config)#interface mlag1	Enter mlag interface
TOR2(config-if)#switchport	Configure interface as switchport
TOR2(config-if)#bridge-group 1 spanning-tree disable	Associate the interface with bridge group 1 and disabling spanning-tree
TOR2(config-if)#switchport mode customer-edge hybrid	Set the switching characteristics of this interface to customer-edge hybrid
TOR2(config-if)#switchport customer-edge hybrid allowed vlan all	Set the switching characteristics of this interface to customer-edge hybrid and allow vlan all
TOR2(config-if)#switchport customer-edge vlan registration map1	Configure the registration table mapping on mlag interface
TOR2(config-if)#exit	Exit the interface mode
TOR2(config)#interface mlag2	Enter mlag interface
TOR2(config-if)#switchport	Configure interface as switchport
TOR2(config-if)#bridge-group 1	Associate the interface with bridge group 1

## MLAG Configuration

TOR2 (config-if) #switchport mode provider-network	Set the switching characteristics of this interface to provider network
TOR2 (config-if) #switchport provider-network allowed vlan all	Set the switching characteristics of this interface to provider network and allow all vlan
TOR2 (config-if) #exit	Exit the interface mode
TOR2 (config) #interface po1	Enter dynamic lag interface
TOR2 (config-if) #switchport	Configure interface as switchport
TOR2 (config-if) #mlag 1	Enable mlag group number
TOR2 (config-if) #exit	Exit the interface mode
TOR2 (config) #interface po2	Enter dynamic lag interface
TOR2 (config-if) #switchport	Configure interface as switchport
TOR2 (config-if) #mlag 2	Enable mlag group number
TOR2 (config-if) #exit	Exit the interface mode
TOR2 (config) #interface po3	Enter dynamic lag interface
TOR2 (config-if) #switchport	Configure interface as switchport
TOR2 (config-if) #bridge-group 1	Associate the interface with bridge group 1
TOR2 (config-if) #switchport mode provider-network	Set the switching characteristics of this interface to provider network
TOR2 (config-if) #switchport provider-network allowed vlan all	Set the switching characteristics of this interface to provider network and allow all vlan
TOR2 (config-if) #exit	Exit the interface mode
TOR2 (config) #interface xe2	Enter interface mode
TOR2 (config-if) #channel-group 3 mode active	Make part of channel group 3
TOR2 (config-if) #interface xe3	Enter interface mode
TOR2 (config-if) #channel-group 1 mode active	Add this interface to channel group 1 and enable link aggregation so that it can be selected for aggregation by the local system
TOR2 (config-if) #exit	Exit the interface mode
TOR2 (config) #Interface xe49/1	Enter interface mode
TOR2 (config-if) #channel-group 2 mode active	Enable channel-group 2
TOR2 (config) #mcec domain configuration	Configure mcec domain information
TOR2 (config-mcec-domain) #domain-address 2222.3333.4444	Domain address for the mlag domain
TOR2 (config-mcec-domain) #domain-system-number 2	Number to identify the node in a domain
TOR2 (config-mcec-domain) #intra-domain-link po3	Intra domain line between mlag domain
TOR2 (config) #hardware-profile filter ingress-arp enable	Enable globally hardware profile for arp
TOR2 (config) #arp access-list cep	Create access list with name as cep
TOR2 (config-arp-acl) #30 permit request ip any mac host 0000.2A6C.668D vlan 3990 inner-vlan 2	Create permit rule for particular arp request
TOR2 (config-arp-acl) #40 permit response ip any mac host 0000.2A6C.668D host 0000.2A6C.7202 vlan 3990 inner-vlan 2	Create permit rule for particular arp response

TOR2(config)#arp access-list pnp	Create access list with name as pnp
TOR2(config-arp-acl)#20 permit request ip any any mac host 0000.2A6C.7202 vlan 3990 inner-vlan 2	Create permit rule for particular arp request
TOR2(config-arp-acl)#30 permit response ip any any mac host 0000.2A6C.7202 host 0000.2A6C.668D vlan 3990 inner-vlan 2	Create permit rule for particular arp response
TOR2(config-if)#interface mlag1	Enter mlag1 interface
TOR2(config-if)#arp access-group cep in	Attach rule with access-group cep
TOR2(config-if)#interface mlag2	Enter mlag2 interface
TOR2(config-if)#arp access-group pnp in	Attach rule with access-group pnp

**SW1**

SW1(config)#bridge 1 protocol rstp vlan-bridge	Configure the rstp vlan bridge
SW1(config)#vlan 2-3990 type customer bridge 1 state enable	Enable customer vlan for bridge
SW1(config-if)#interface po1	Enter dynamic lag interface
SW1(config-if)#switchport	Configure interface as switchport
SW1(config-if)#bridge-group 1 spanning-tree disable	Associate the interface with bridge group 1and disabling spanning-tree
SW1(config-if)#switchport mode hybrid	Set the switching characteristics of this interface hybrid
SW1(config-if)#switchport hybrid allowed vlan all	Set the switching characteristics of this interface hybrid and allowing all vlan
SW1(config-if)#exit	Exit the interface mode
SW1(config)#interface xe1	Enter interface mode
SW1(config-if)#channel-group 1 mode active	Add this interface to channel group 1 and enable link aggregation so that it can be selected for aggregation by the local system.
SW1(config-if)#exit	Exit the interface mode
SW1(config)#interface xe2	Enter interface mode
SW1(config-if)#channel-group 1 mode active	Add this interface to channel group 1 and enable link aggregation so that it can be selected for aggregation by the local system.
SW1(config-if)#exit	Exit the interface mode
SW1(config)#interface xe3	Enter interface mode
SW1(config-if)#switchport	Configure interface as switchport
SW1(config-if)#bridge-group 1 spanning-tree disable	Associate the interface with bridge group 1and disabling spanning-tree
SW1(config-if)#switchport mode hybrid	Set the switching characteristics of this interface hybrid
SW1(config-if)#switchport hybrid allowed vlan all	Set the switching characteristics of this interface hybrid and allowing all vlan
SW1(config-if)#exit	Exit the interface mode

### LEAF

Leaf(config)#bridge 1 protocol provider-rstp edge	Configure the rstp vlan bridge
Leaf(config)#vlan 2-3990 type customer bridge 1 state enable	Enable customer vlan for bridge
Leaf(config)#vlan 2-3990 type service point-point bridge 1 state enable	Enable service vlan for bridge
Leaf(config)#cvlan registration table map1 bridge 1	Create registration table
Leaf(config-cvlan-registration)#cvlan 2-3990 svlan 3990	Map cvlan to svlan
Leaf(config-if)#exit	Exit the cvlan registration table mode
Leaf(config)#interface po2	Enter interface mode
Leaf(config-if)#switchport	Configure interface as switchport
Leaf(config-if)#bridge-group 1 spanning-tree disable	Associate the interface with bridge group 1and disabling spanning-tree
Leaf(config-if)#switchport mode provider-network	Set the switching characteristics of this interface provider network
Leaf(config-if)#switchport provider-network allowed vlan all	Set the switching characteristics of this interface provider and allowing all vlan
Leaf(config-if)#exit	Exit the interface mode
Leaf(config)#interface xe1	Enter interface mode
Leaf(config-if)#channel-group 2 mode active	Add this interface to channel group 2 and enable link aggregation so that it can be selected for aggregation by the local system.
Leaf(config-if)#exit	Exit the interface mode
Leaf(config)#interface xe2	Enter interface mode
Leaf(config-if)#channel-group 2 mode active	Add this interface to channel group 2 and enable link aggregation so that it can be selected for aggregation by the local system.
Leaf(config-if)#exit	Exit the interface mode
Leaf(config)#Interface xe3	Enter interface mode
Leaf(config-if)#switchport	Configure interface as switchport
Leaf(config-if)#bridge-group 1 spanning-tree disable	Associate the interface with bridge group 1and disabling spanning-tree
Leaf(config-if)#switchport mode customer-edge hybrid	Set the switching characteristics of this interface to customer-edge hybrid
Leaf(config-if)#switchport customer-edge hybrid allowed vlan all	Set the switching characteristics of this interface to customer-edge hybrid and allow vlan all
Leaf(config-if)#switchport customer-edge vlan registration map1	Configure the registration table mapping on mlag interface
Leaf(config-if)#exit	Exit the interface mode

### Validation

```
TOR1#show access-lists
ARP access list cep
```

```

    30 permit request ip any mac host 0000.2A6C.668D vlan 3990 inner-vlan 2
    40 permit response ip any any mac host 0000.2A6C.668D host 0000.2A6C.7202 vlan
3990 inner-vlan 2
    default deny-all
ARP access list pnp
    20 permit request ip any mac host 0000.2A6C.7202 vlan 3990 inner-vlan 2 [match=1]
    30 permit response ip any any mac host 0000.2A6C.7202 host 0000.2A6C.668D vlan
3990 inner-vlan 2 [match=1]
    default deny-all log

TOR2#show access-lists
ARP access list cep
    30 permit request ip any mac host 0000.2A6C.668D vlan 3990 inner-vlan 2 [match=1]
    40 permit response ip any any mac host 0000.2A6C.668D host 0000.2A6C.7202 vlan
3990 inner-vlan 2 [match=1]
    default deny-all log
ARP access list pnp
    20 permit request ip any mac host 0000.2A6C.7202 vlan 3990 inner-vlan 2
    30 permit response ip any any mac host 0000.2A6C.7202 host 0000.2A6C.668D vlan
3990 inner-vlan 2
    default deny-all

```

---

## Disabling STP for MLAG

The command `no bridge 1 provider-rstp enable bridge-forward` is used to disable the spanning tree globally.

---

## Enabling Provider RSTP

OcNOS#configure terminal	Enter Configure mode.
OcNOS(config)#bridge 1 protocol provider-rstp edge	Configure Provider-rstp edge bridge.
OcNOS(config)#interface xe13/2	Configure interface xe13/2\
OcNOS(config-if)#switchport	Configure the interface as switchport
OcNOS(config-if)#bridge-group 1	Assign the above created bridge to this port.
OcNOS(config-vrf)#exit	Exit from interface mode to config mode
OcNOS(config)#interface po1	Configure interface po1
OcNOS(config-if)#switchport	Configure the interface as switchport
OcNOS(config-if)#bridge-group 1	Assign the above created bridge to this port.
OcNOS(config-vrf)#exit	Exit from interface mode to config mode
OcNOS(config)#interface mlag2	Configure interface mlag1
OcNOS(config-if)#switchport	Configure the interface as switchport
OcNOS(config-if)#bridge-group 1 spanning-tree disable	Assign the above created bridge to this port and disable the spanning tree.
OcNOS(config-vrf)#exit	Exit from interface mode to config mode

---

## Validation

```
OcNOS#show spanning-tree
% 1: Bridge up - Spanning Tree Enabled - topology change detected
% 1: Root Path Cost 0 - Root Port 0 - Bridge Priority 32768
% 1: Forward Delay 15 - Hello Time 2 - Max Age 20 - Transmit Hold Count 6
% 1: Root Id 8000ecf4bbfc6928
% 1: Bridge Id 8000ecf4bbfc6928
% 1: last topology change Tue Jul 30 06:47:37 2019
% 1: 2 topology change(s) - last topology change Tue Jul 30 06:47:37 2019

% 1: portfast bpdu-filter disabled
% 1: portfast bpdu-guard disabled
% xe13/2: Port Number 942 - Ifindex 5038 - Port Id 0x83ae - Role Designated - State Forwarding
% xe13/2: Designated Path Cost 0
% xe13/2: Configured Path Cost 2000 - Add type Explicit ref count 1
% xe13/2: Designated Port Id 0x83ae - Priority 128 -
% xe13/2: Root 8000ecf4bbfc6928
% xe13/2: Designated Bridge 8000ecf4bbfc6928
% xe13/2: Message Age 0 - Max Age 20
% xe13/2: Hello Time 2 - Forward Delay 15
% xe13/2: Forward Timer 0 - Msg Age Timer 0 - Hello Timer 0 - topo change timer 0
% xe13/2: forward-transitions 3
% xe13/2: Version Rapid Spanning Tree Protocol - Receive None - Send RSTP
% xe13/2: No portfast configured - Current portfast off
% xe13/2: bpdu-guard default - Current bpdu-guard off
% xe13/2: bpdu-filter default - Current bpdu-filter off
% xe13/2: no root guard configured - Current root guard off
% xe13/2: Configured Link Type point-to-point - Current point-to-point
% xe13/2: No auto-edge configured - Current port Auto Edge off
%
% pol: Port Number 1697 - Ifindex 100001 - Port Id 0x86a1 - Role Designated - State Forwarding
% pol: Designated Path Cost 0
% pol: Configured Path Cost 2000 - Add type Explicit ref count 1
% pol: Designated Port Id 0x86a1 - Priority 128 -
% pol: Root 8000ecf4bbfc6928
% pol: Designated Bridge 8000ecf4bbfc6928
% pol: Message Age 0 - Max Age 20
% pol: Hello Time 2 - Forward Delay 15
% pol: Forward Timer 0 - Msg Age Timer 0 - Hello Timer 0 - topo change timer 0
% pol: forward-transitions 1
% pol: Version Rapid Spanning Tree Protocol - Receive None - Send RSTP
% pol: No portfast configured - Current portfast off
% pol: bpdu-guard default - Current bpdu-guard off
% pol: bpdu-filter default - Current bpdu-filter off
% pol: no root guard configured - Current root guard off
% pol: Configured Link Type point-to-point - Current point-to-point
% pol: No auto-edge configured - Current port Auto Edge off
%
```



```

% mlag2: Port Number 2690 - Ifindex 400002 - Port Id 0x8a82 - Role Disabled - State
Forwarding
% mlag2: Designated Path Cost 0
% mlag2: Configured Path Cost 20000000 - Add type Explicit ref count 1
% mlag2: Designated Port Id 0x0 - Priority 128 -
% mlag2: Message Age 0 - Max Age 0
% mlag2: Hello Time 0 - Forward Delay 0
% mlag2: Forward Timer 0 - Msg Age Timer 0 - Hello Timer 0 - topo change timer 0
% mlag2: forward-transitions 1
% mlag2: Version Rapid Spanning Tree Protocol - Receive None - Send RSTP
% mlag2: No portfast configured - Current portfast off
% mlag2: bpdu-guard default - Current bpdu-guard off
% mlag2: bpdu-filter default - Current bpdu-filter off
% mlag2: no root guard configured - Current root guard off
% mlag2: Configured Link Type point-to-point - Current point-to-point
% mlag2: No auto-edge configured - Current port Auto Edge off
%

```

---

## Disabling RSTP Globally

OcNOS#configure terminal	Enter Configure mode.
OcNOS(config)#no bridge 1 provider-rstp enable bridge-forward	Disable spanning tree globally for Provider-RSTP and keeping the ports in Forwarding state.
OcNOS(config)#interface mlag1	Configure interface mlag1
OcNOS(config-if)#switchport	Configure the interface as switchport
OcNOS(config-if)#bridge-group 1	Assign the above created bridge to this port.
OcNOS(config-vrf)#exit	Exit from interface mode to config mode

---

## Validation

```

OcNOS#sh run int mlag2
!
interface mlag2
  switchport
  bridge-group 1 spanning-tree disable
  switchport mode provider-network
!
OcNOS#sh run int mlag1
!
interface mlag1
  switchport
  bridge-group 1
  switchport mode provider-network
!
OcNOS#
OcNOS#sh spanning-tree
% 1: Bridge up - Spanning Tree Disabled - topology change detected
% 1: Root Path Cost 0 - Root Port 0 - Bridge Priority 32768
% 1: Forward Delay 15 - Hello Time 2 - Max Age 20 - Transmit Hold Count 6

```

## MLAG Configuration

---

```
% 1: Root Id 800000000000000000
% 1: Bridge Id 800000000000000000
% 1: 2 topology change(s) - last topology change Tue Jul 30 06:47:37 2019

% 1: portfast bpdu-filter disabled
% 1: portfast bpdu-guard disabled
% xe13/2: Port Number 942 - Ifindex 5038 - Port Id 0x83ae - Role Disabled - State Forwarding
% xe13/2: Designated Path Cost 0
% xe13/2: Configured Path Cost 2000 - Add type Explicit ref count 1
% xe13/2: Designated Port Id 0x83ae - Priority 128 -
% xe13/2: Message Age 0 - Max Age 20
% xe13/2: Hello Time 2 - Forward Delay 15
% xe13/2: Forward Timer 0 - Msg Age Timer 0 - Hello Timer 0 - topo change timer 0
% xe13/2: forward-transitions 4
% xe13/2: Version Rapid Spanning Tree Protocol - Receive None - Send RSTP
% xe13/2: No portfast configured - Current portfast off
% xe13/2: bpdu-guard default - Current bpdu-guard off
% xe13/2: bpdu-filter default - Current bpdu-filter off
% xe13/2: no root guard configured - Current root guard off
% xe13/2: Configured Link Type point-to-point - Current point-to-point
% xe13/2: No auto-edge configured - Current port Auto Edge off
%
% pol: Port Number 1697 - Ifindex 100001 - Port Id 0x86a1 - Role Disabled - State Forwarding
% pol: Designated Path Cost 0
% pol: Configured Path Cost 2000 - Add type Explicit ref count 1
% pol: Designated Port Id 0x86a1 - Priority 128 -
% pol: Message Age 0 - Max Age 20
% pol: Hello Time 2 - Forward Delay 15
% pol: Forward Timer 0 - Msg Age Timer 0 - Hello Timer 0 - topo change timer 0
% pol: forward-transitions 2
% pol: Version Rapid Spanning Tree Protocol - Receive None - Send RSTP
% pol: No portfast configured - Current portfast off
% pol: bpdu-guard default - Current bpdu-guard off
% pol: bpdu-filter default - Current bpdu-filter off
% pol: no root guard configured - Current root guard off
% pol: Configured Link Type point-to-point - Current point-to-point
% pol: No auto-edge configured - Current port Auto Edge off
%
% mlag1: Port Number 2689 - Ifindex 400001 - Port Id 0x8a81 - Role Disabled - State Forwarding
% mlag1: Designated Path Cost 0
% mlag1: Configured Path Cost 20000000 - Add type Explicit ref count 1
% mlag1: Designated Port Id 0x0 - Priority 128 -
% mlag1: Message Age 0 - Max Age 0
% mlag1: Hello Time 0 - Forward Delay 0
% mlag1: Forward Timer 0 - Msg Age Timer 0 - Hello Timer 0 - topo change timer 0
% mlag1: forward-transitions 2
% mlag1: Version Rapid Spanning Tree Protocol - Receive None - Send RSTP
% mlag1: No portfast configured - Current portfast off
```

---

```
% mlag1: bpdu-guard default - Current bpdu-guard off
% mlag1: bpdu-filter default - Current bpdu-filter off
% mlag1: no root guard configured - Current root guard off
% mlag1: Configured Link Type point-to-point - Current point-to-point
% mlag1: No auto-edge configured - Current port Auto Edge off
%
% mlag2: Port Number 2690 - Ifindex 400002 - Port Id 0x8a82 - Role Disabled - State
Forwarding
% mlag2: Designated Path Cost 0
% mlag2: Configured Path Cost 20000000 - Add type Explicit ref count 1
% mlag2: Designated Port Id 0x0 - Priority 128 -
% mlag2: Message Age 0 - Max Age 0
% mlag2: Hello Time 0 - Forward Delay 0
% mlag2: Forward Timer 0 - Msg Age Timer 0 - Hello Timer 0 - topo change timer 0
% mlag2: forward-transitions 2
% mlag2: Version Rapid Spanning Tree Protocol - Receive None - Send RSTP
% mlag2: No portfast configured - Current portfast off
% mlag2: bpdu-guard default - Current bpdu-guard off
% mlag2: bpdu-filter default - Current bpdu-filter off
% mlag2: no root guard configured - Current root guard off
% mlag2: Configured Link Type point-to-point - Current point-to-point
% mlag2: No auto-edge configured - Current port Auto Edge off
%
```



## CHAPTER 10 802.1X Configuration

IEEE 802.1x restricts unauthenticated devices from connecting to a switch. Only after authentication is successful, traffic is allowed through the switch.

### Topology

In this example, a radius server keeps the client information, validating the identity of the client and updating the switch about the authentication status of the client. The switch is the physical access between the two clients and the server. It requests information from the client, relays information to the server and then back to the client. To configure 802.1x authentication, enable authentication on ports eth1 and eth2 and specify the radius server IP address and port.

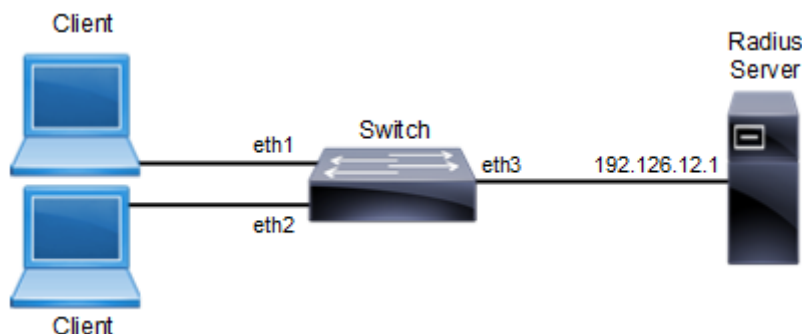

Figure 10-18: 802.1x Topology

### Switch Configuration

Switch#configure terminal	Enter configure mode.
Switch(config)#port-security disable	Disable the port-security.
Switch(config)#dot1x system-auth-ctrl	Enable authentication globally.
Switch(config)#interface eth2	Enter interface mode.
Switch(config-if)#switchport	Enable switch port on interface.
Switch(config-if)#dot1x port-control auto	Enable authentication (via Radius) on port (eth2).
Switch(config-if)#exit	Exit interface mode.
Switch(config)#interface eth1	Enter interface mode.
Switch(config-if)#switchport	Enable switch port on interface.
Switch(config-if)#dot1x port-control auto	Enable authentication (via Radius) on port (eth1).
Switch(config-if)#exit	Exit interface mode.
Switch(config)#radius-server dot1x key-string test123	Specify key with string name between radius server and client
Switch(config)#radius-server dot1x host 192.126.12.1	Specify the Radius Server address (192.126.12.1)
Switch(config-radius-server)#exit	Exit from radius server mode.
Switch(config)#interface eth3	Enter interface mode.
Switch(config-if)#ip address 192.126.12.2/24	Set the IP address on interface eth3.
Switch(config-if)#commit	Commit the transaction.
Switch(config-if)#exit	Exit interface mode.

## Validation

```
#show dot1x all
802.1X Port-Based Authentication Enabled
  RADIUS server address: 192.168.1.1:60000
  Next radius message id: 147
  RADIUS client address: not configured

802.1X info for interface eth1
  portEnabled: true - portControl: Auto
  portStatus: Unauthorized - currentId: 29
  protocol version: 2
  reAuthenticate: disabled
  reAuthPeriod: 3600
  abort:F fail:F start:F timeout:F success:F
  PAE: state: Connecting - portMode: Auto
  PAE: reAuthCount: 1 - rxRespId: 0
  PAE: quietPeriod: 60 - reauthMax: 2 - txPeriod: 30
  BE: state: Idle - reqCount: 0 - idFromServer: 0
  BE: suppTimeout: 30 - serverTimeout: 30
  CD: adminControlledDirections: in - operControlledDirections: in
  CD: bridgeDetected: false
  KR: rxKey: false
  KT: keyAvailable: false - keyTxEnabled: false

802.1X info for interface eth2
  portEnabled: true - portControl: Auto
  portStatus: Unauthorized - currentId: 29
  protocol version: 2
  reAuthenticate: disabled
  reAuthPeriod: 3600
  abort:F fail:F start:F timeout:F success:F
  PAE: state: Connecting - portMode: Auto
  PAE: reAuthCount: 1 - rxRespId: 0
  PAE: quietPeriod: 60 - reauthMax: 2 - txPeriod: 30
  BE: state: Idle - reqCount: 0 - idFromServer: 0
  BE: suppTimeout: 30 - serverTimeout: 30
  CD: adminControlledDirections: in - operControlledDirections: in
  CD: bridgeDetected: false
  KR: rxKey: false
  KT: keyAvailable: false - keyTxEnabled: false

#show dot1x
802.1X Port-Based Authentication Enabled
  RADIUS server address: 192.168.1.1:60000
  Next radius message id: 147
  RADIUS client address: not configured
```

## CHAPTER 11 Port Security Configuration

The Port Security feature allows network administrators to block unauthorized access to the network. Network administrators can configure each port of the switch to allow network access from only secured MACs, so that the switch forwards traffic from only secured MACs.

Users can limit each port's ingress traffic by limiting MAC addresses (source MACs) that are used to send traffic into ports. Port Security enables users to configure the maximum number of secured MACs for each port. Switches learn secured MAC dynamically (learned by switch during traffic inflow) or statically (User configured MACs). Dynamically Learned or statically programmed MAC addresses cannot exceed the maximum number of secured MACs configured for a particular port. Once the switch reaches the maximum limit for secured MACs, traffic from all other MAC addresses are dropped.

The violated MACs are logged in syslog messages. Refer to `cpu queue portsec-drop` using the command `show interface cpu counter queue-stats` for information on the number of violated MACs.

### Secured MACs Learned Dynamically



Figure 11-19: Secured MACs learned dynamically

Send Layer-2 traffic with incremental source MAC of 100 and with VLAN 100 from IXIA1 and since max limit is configured as 3 – only 3 secure MAC addresses will be learned by SW1.

#### SW1

<code>#configure terminal</code>	Enter configure mode.
<code>(config)#hostname SW1</code>	Set the host name
<code>(config)#bridge 1 protocol rstp vlan-bridge</code>	Create a RSTP VLAN bridge on customer side
<code>(config)#vlan 2-200 bridge 1 state enable</code>	Configure VLAN for the bridge
<code>(config)#interface ge1</code>	Enter interface mode
<code>(config-if)#switchport</code>	Make the interface Layer 2
<code>(config-if)#bridge-group 1</code>	Associate the interface to bridge
<code>(config-if)#switchport mode hybrid</code>	Configure the mode as trunk
<code>(config-if)#switchport hybrid allowed vlan all</code>	Configure allowed VLAN all on the interface
<code>(config-if)#switchport port-security</code>	Enable port security mode dynamic
<code>(config-if)#switchport port-security maximum 3</code>	Limit secure MAC to 3 mac addresses.
<code>(config-if)#exit</code>	Exit interface mode
<code>(config)#interface ge2</code>	Enter interface mode
<code>(config-if)#switchport</code>	Make the interface Layer 2
<code>(config-if)#bridge-group 1</code>	Associate the interface to bridge

## Port Security Configuration

(config-if)#switchport mode hybrid	Configure the mode as trunk
(config-if)#switchport hybrid allowed vlan all	Configure allowed VLAN all on the interface
(config-if)#exit	Exit interface mode
(config)#logging monitor 7	Enable logging level as 7 for debugging

## Validation

Validation commands are “show port-security,” “show port-security interface <ifname>,” “show mac address-table count bridge 1,” “show bridge,” and “show mac address-table bridge 1.”

```
SW1#show port-security
```

```
Port      port-security mode  MAC limit  CVLAN  SVLAN  static secure MAC
-----+-----+-----+-----+-----+-----
gel      dynamic              3
```

```
SW1#show port-security interface gel
```

```
Port Security Mode      : Dynamic
Secure MAC limit       : 3
Static Secure MAC list :
CVLAN  SVLAN  MAC Address
-----+-----+-----
```

```
SW1#show mac address-table count bridge 1
```

```
MAC Entries for all vlans:
Dynamic Address Count: 3
Static (User-defined) Unicast MAC Address Count: 0
Static (User-defined) Multicast MAC Address Count: 0
Total MAC Addresses in Use: 3
```

```
SW1#show bridge
```

Ageout time is global and if something is configured for vxlan then it will be affected here also

```
Bridge      CVLAN  SVLAN  BVLAN  Port      MAC Address      FWD  Time-out
-----+-----+-----+-----+-----+-----+-----+-----+
1           100           gel      0000.0300.0500  1      100
1           100           gel      0000.0300.055b  1      100
1           100           gel      0000.0300.055c  1      100
```

```
SW1#show mac address-table bridge 1
```

```
VLAN  MAC Address      Type      Ports      Port-security
-----+-----+-----+-----+-----+
100   0000.0300.0500  dynamic  gel      Enable
100   0000.0300.055b  dynamic  gel      Enable
100   0000.0300.055c  dynamic  gel      Enable
```

```
SW1#
```



## Secured MAC Addresses Learned Statically

1. Stop the traffic from IXIA1 and do “clear mac address-table dynamic bridge 1” on SW1.
2. Verify all dynamic secured MAC addresses are cleared.
3. Configure 3 static secure MAC addresses using the commands below in port security configured interface.
4. Try to add a fourth static secure MAC address.
5. Verify operator log message is displayed, saying “port security mac limit reached.”

(config)#interface gel	Enter interface mode
(config-if)#switchport port-security mac-address 0000.0000.aaaa vlanId 100	Add static secure MAC address for VLAN 100 in interface mode
(config-if)#switchport port-security mac-address 0000.0000.aaab vlanId 100	Add static secure MAC address for VLAN 100 in interface mode
(config-if)#switchport port-security mac-address 0000.0000.aaac vlanId 100	Add static secure MAC address for VLAN 100 in interface mode

## Validation

```
SW1#show port-security
Port    port-security mode  MAC limit  CVLAN   SVLAN   static secure MAC
-----+-----+-----+-----+-----+-----
gel     dynamic             3          100    100    0000.0000.aaaa
              100    0000.0000.aaab
              100    0000.0000.aaac
```

```
SW1#show port-security interface gel
Port Security Mode      : Dynamic
Secure MAC limit       : 3
Static Secure MAC list :
CVLAN  SVLAN  MAC Address
-----+-----+-----
100    0000.0000.aaaa
100    0000.0000.aaab
100    0000.0000.aaac
```

```
SW1#show mac address-table count bridge 1
MAC Entries for all vlans:
Dynamic Address Count: 0
Static (User-defined) Unicast MAC Address Count: 3
Static (User-defined) Multicast MAC Address Count: 0
Total MAC Addresses in Use: 3
```

```
SW1#show bridge
Ageout time is global and if something is configured for vxlan then it will be affected here also
Bridge    CVLAN  SVLAN  BVLAN  Port    MAC Address    FWD    Time-out
```

## Port Security Configuration

```
-----+-----+-----+-----+-----+-----+-----+
1          100                gel          0000.0000.aaaa    1    -
1          100                gel          0000.0000.aaab    1    -
1          100                gel          0000.0000.aaac    1    -
```

```
SW1#show mac address-table bridge 1
VLAN    MAC Address      Type      Ports      Port-security
-----+-----+-----+-----+-----+
100     0000.0000.aaaa   static    gel        Enable
100     0000.0000.aaab   static    gel        Enable
100     0000.0000.aaac   static    gel        Enable
```

SW1#

Remove the port-security configuration method using the two commands below:

(

<code>(config)#interface gel</code>	Enter interface mode
<code>(config-if)#no switchport port-security</code>	Set the port-security method to static.

---

## Static Mode

Use the below command to configure the port-security method to static and configure static secure MAC addresses using the commands the in static port-security method, below.

<code>(config)#interface gel</code>	Enter interface mode
<code>(config-if)#switchport port-security static</code>	Set the port-security method as static.
<code>(config-if)#switchport port-security max 3</code>	Limit static secure MAC to 3 mac addresses.
<code>(config-if)#switchport port-security mac-address 0000.0000.aaaa vlanId 100</code>	Add static secure MAC address for VLAN 100 in interface mode.
<code>(config-if)#switchport port-security mac-address 0000.0000.aaab vlanId 100</code>	Add static secure MAC address for VLAN 100 in interface mode.
<code>(config-if)#switchport port-security mac-address 0000.0000.aaac vlanId 100</code>	Add static secure MAC address for VLAN 100 in interface mode .

Verify the 3 secure static MAC addresses are added in interface ge1 using show running-config and also verify the port-security method should be static using below show commands.

---

## Validation

```
SW1#show running-config interface gel
interface gel
  switchport
bridge-group 1
  switchport mode hybrid
  switchport hybrid allowed vlan all
  switchport port-security static
  switchport port-security maximum 3
  switchport port-security mac-address 0000.0000.aaaa vlanId 100
  switchport port-security mac-address 0000.0000.aaab vlanId 100
  switchport port-security mac-address 0000.0000.aaac vlanId 100
```

```
SW1#show port-security
Port    port-security mode  MAC limit  CVLAN  SVLAN  static secure MAC
-----+-----+-----+-----+-----+-----
ge1     static              3          100    100    0000.0000.aaaa
                100          0000.0000.aaab
                100          0000.0000.aaac
```

```
SW1#show port-security interface ge1
Port Security Mode      : Static
Secure MAC limit       : 3
Static Secure MAC list :
CVLAN  SVLAN  MAC Address
-----+-----+-----
100    100    0000.0000.aaaa
100    100    0000.0000.aaab
100    100    0000.0000.aaac
```

```
SW1#show mac address-table count bridge 1
MAC Entries for all vlans:
Dynamic Address Count: 0
Static (User-defined) Unicast MAC Address Count: 3
Static (User-defined) Multicast MAC Address Count: 0
Total MAC Addresses in Use: 3
```

```
SW1#show bridge
Ageout time is global and if something is configured for vxlan then it will be affected here also
```

Bridge	CVLAN	SVLAN	BVLAN	Port	MAC Address	FWD	Time-out
1	100			ge1	0000.0000.aaaa	1	-
1	100			ge1	0000.0000.aaab	1	-
1	100			ge1	0000.0000.aaac	1	-

```
SW1#show mac address-table bridge 1
VLAN  MAC Address      Type      Ports      Port-security
-----+-----+-----+-----+-----
100   0000.0000.aaaa   static   ge1        Enable
100   0000.0000.aaab   static   ge1        Enable
100   0000.0000.aaac   static   ge1        Enable
```

SW1#

Configure one more static secure MAC address on interface ge1 and try to verify “port security mac limit reached” operator log message is displayed.

Start sending Layer-2 traffic with incremental source MAC of 100 and with VLAN 100 from IXIA1, and verify no dynamic secure MAC addresses are being learned using all the validation commands used.

## Port Security using MC-LAG

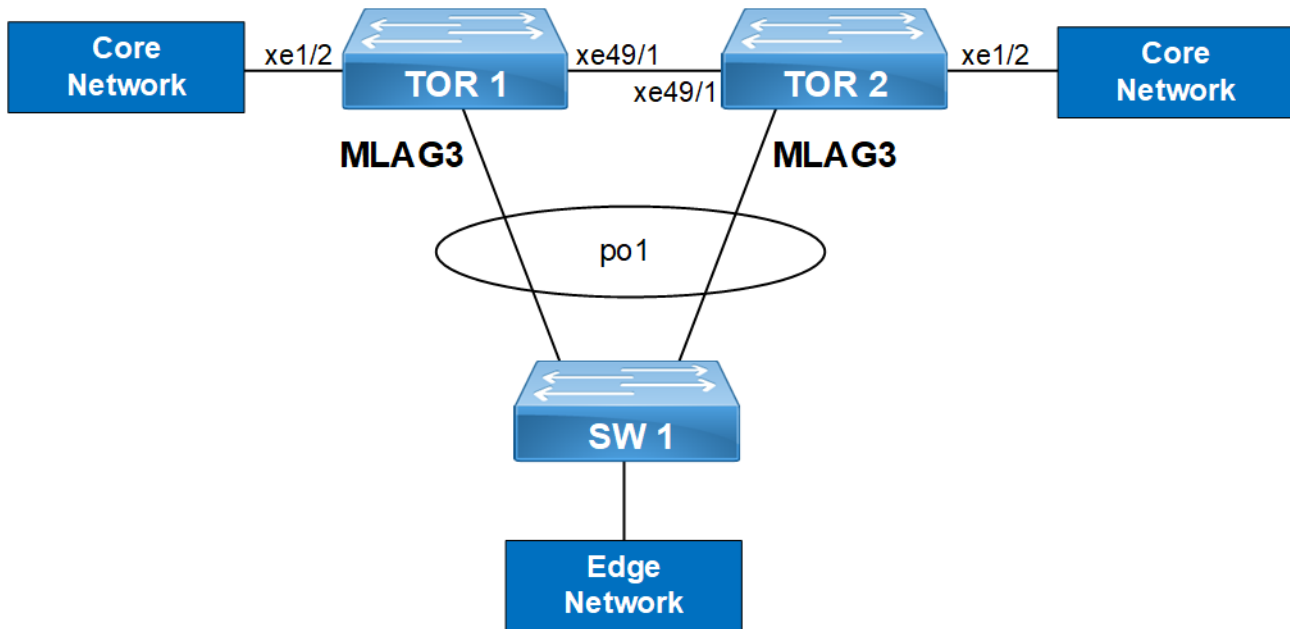

Figure 11-20: Port security with MC-LAG

### TOR1

#configure terminal	Enter configure mode
(config)#bridge 1 protocol provider-rstp edge	Create provider RSTP bridge
(config)#vlan 2-10 type customer bridge 1 state enable	Enabling customer vlan for bridge
(config)#vlan 2-10 type service point-point bridge 1 state enable	Enabling service vlan for bridge
(config)#cvlan registration table map1 bridge 1	Creating registration table
(config-cvlan-registation)#cvlan 2 svlan 2	Mapping CVLAN to SVLAN
(config-cvlan-registation)#cvlan 10 svlan 2	Mapping CVLAN to SVLAN
(config-cvlan-registation)#exit	Exit registration table mode
(config)#interface mlag3	Entering MLAG interface
(config-if)#switchport	Configuring interface as switchport
(config-if)#exit	Exit interface mode
(config)#interface po1	Entering dynamic lag interface
(config-if)#switchport	Configuring interface as switchport
(config-if)#bridge-group 1 spanning-tree disable	Associate the interface with bridge group 1 and disabling spanning-tree
(config-if)#switchport mode customer-edge hybrid	Set the switching characteristics of this interface to customer edge hybrid

(config-if)#switchport customer-edge hybrid vlan 2	Set the switching characteristics of this interface to customer edge hybrid and allow VLAN 2
(config-if)#switchport customer-edge hybrid allowed vlan all	Set the switching characteristics of this interface to customer edge hybrid and allow VLAN all
(config-if)#mlag 3	Enabling mlag group number
(config-if)#exit	Exit interface mode
(config)#interface xe49/1	Entering interface mode
(config-if)#switchport	Configuring interface as switchport
(config-if)#bridge-group 1	Associate the interface with bridge group 1.
(config-if)#switchport mode provider-network	Set the switching characteristics of this interface to provider network
(config-if)#switchport provider-network allowed vlan all	Set the switching characteristics of this interface to provider network and allow all VLAN
(config-if)#exit	Enter interface mode
(config)#interface xe3	Entering interface mode
(config-if)#switchport	Configuring interface as switchport
(config-if)#bridge-group 1	Associate the interface with bridge group 1.
(config-if)#switchport mode customer-edge hybrid	Set the switching characteristics of this interface to customer edge hybrid
(config-if)#switchport customer-edge hybrid vlan 2	Set the switching characteristics of this interface to customer edge hybrid and allow vlan 2
(config-if)#switchport customer-edge hybrid allowed vlan all	Set the switching characteristics of this interface to customer edge hybrid and allow VLAN all
(config-if)#channel-group 1 mode active	Add this interface to channel group 1 and enable link aggregation so that it can be selected for aggregation by the local system
(config-if)#exit	Exit interface mode
(config)#interface mlag3	Entering MLAG interface
(config-if)#bridge-group 1 spanning-tree disable	Associate the interface with bridge group 1and disabling spanning-tree
(config-if)#switchport mode customer-edge hybrid	Set the switching characteristics of this interface to customer edge hybrid
(config-if)#switchport customer-edge hybrid vlan 2	Set the switching characteristics of this interface to customer edge hybrid and allow VLAN 2
(config-if)#switchport customer-edge hybrid allowed vlan all	Set the switching characteristics of this interface to customer edge hybrid and allow VLAN all
(config-if)#switchport customer-edge vlan registration map1	Configuring the registration table mapping on MLAG interface
(config-if)#switchport port-security	Enabling port security
(config-if)#switchport port-security maximum 10	Limiting the maximum mac to 10
(config-if)#exit	Exit interface mode
(config)#mcec domain configuration	Entering MCEC mode
(config-mcec-domain)#domain-address 2222.2222.2222	Domain address for the MLAG domain
(config-mcec-domain)#domain-system-number 1	Number to identify the node in a domain
(config-mcec-domain)#exit	Exit MCEC mode

## Port Security Configuration

(config)#intra-domain-link xe49/1	Intra domain line between MLAG domain
(config-if)#domain-priority 333	Domain priority for MCEC

### TOR2

(config-if)#	
#configure terminal	Enter configure mode
(config)#bridge 1 protocol provider-rstp edge	Create provider RSTP bridge
(config)#vlan 2-10 type customer bridge 1 state enable	Enabling customer VLAN for bridge
(config)#vlan 2-10 type service point-point bridge 1 state enable	Enabling service VLAN for bridge
(config)#cvlan registration table map1 bridge 1	Creating registration table
(config-cvlan-registation)#cvlan 2 svlan 2	Mapping CVLAN to SVLAN
(config-cvlan-registation)#cvlan 10 svlan 2	Mapping CVLAN to SVLAN
(config-cvlan-registation)#exit	Exit registration table mode
(config)#interface mlag3	Entering MLAG interface
(config-if)#switchport	Configuring interface as switchport
(config-if)#exit	Exit interface mode
(config)#interface po1	Entering dynamic lag interface
(config-if)#Switchport	Configuring interface as switchport
(config-if)#bridge-group 1 spanning-tree disable	Associate the interface with bridge group 1and disabling spanning-tree
(config-if)#switchport mode customer-edge hybrid	Set the switching characteristics of this interface to customer edge hybrid
(config-if)#switchport customer-edge hybrid vlan 2	Set the switching characteristics of this interface to customer edge hybrid and allow VLAN 2
(config-if)#switchport customer-edge hybrid allowed vlan all	Set the switching characteristics of this interface to customer edge hybrid and allow VLAN all
(config-if)#mlag 3	Enabling MLAG group number
(config-if)#exit	Exit interface mode
(config)#interface xe49/1	Entering interface mode
(config-if)#switchport	Configuring interface as switchport
(config-if)#bridge-group 1	Associate the interface with bridge group 1.
(config-if)#switchport mode provider-network	Set the switching characteristics of this interface to provider network
(config-if)#switchport provider-network allowed vlan all	Set the switching characteristics of this interface to provider network and allow all VLAN
(config-if)#exit	Exit interface mode
(config)#interface xe3	Entering interface mode
(config-if)#switchport	Configuring interface as switchport
bridge-group 1	Associate the interface with bridge group 1
(config-if)#switchport mode customer-edge hybrid	Set the switching characteristics of this interface to customer edge hybrid

(config-if)#switchport customer-edge hybrid vlan 2	Set the switching characteristics of this interface to customer edge hybrid and allow VLAN 2
(config-if)#switchport customer-edge hybrid allowed vlan all	Set the switching characteristics of this interface to customer edge hybrid and allow VLAN all
(config-if)#channel-group 1 mode active	Add this interface to channel group 1 and enable link aggregation so that it can be selected for aggregation by the local system
(config-if)#exit	Exit interface mode
(config)#interface mlag3	Entering MLAG interface
(config-if)#bridge-group 1 spanning-tree disable	Associate the interface with bridge group 1 and disabling spanning-tree
(config-if)#switchport mode customer-edge hybrid	Set the switching characteristics of this interface to customer edge hybrid
(config-if)#switchport customer-edge hybrid vlan 2	Set the switching characteristics of this interface to customer edge hybrid and allow VLAN 2
(config-if)#switchport customer-edge hybrid allowed vlanall	Set the switching characteristics of this interface to customer edge hybrid and allow VLAN all
(config-if)#switchport customer-edge vlan registration map1	Configuring the registration table mapping on MLAG interface
(config-if)#exit	Exit interface mode
mcec domain configuration	Entering MCEC mode
(config-mcec-domain)#domain-address 2222.2222.2222	Domain address for the MLAG domain
(config-mcec-domain)#domain-system-number 2	Number to identify the node in a domain
(config-mcec-domain)#intra-domain-link xe49/1	Intra domain line between MLAG domain
(config-mcec-domain)#domain-priority 333	Domain priority for MCEC

**SW1**

configure terminal	Enter configuration mode
(config)#bridge 1 protocol rstp vlan-bridge	Configuring the RSTP vlan bridge
(config)#interface po1	Entering interface mode
(config-if)#switchport	Configuring interface as switchport
(config-if)#bridge-group 1 spanning-tree disable	Associate the interface with bridge group 1 and disabling spanning-tree
(config-if)#switchport mode hybrid	Set the switching characteristics of this interface hybrid
(config-if)#switchport hybrid allowed vlan all	Set the switching characteristics of this interface hybrid and allowing all vlan
(config-if)#exit	Exit interface mode
(config)#interface xe1/3	Entering interface mode
(config-if)#switchport	Configuring interface as switchport
(config-if)#bridge-group 1 spanning-tree disable	Associate the interface with bridge group 1 and disabling spanning-tree
(config-if)#switchport mode hybrid	Set the switching characteristics of this interface hybrid
(config-if)#switchport hybrid allowed vlan all	Set the switching characteristics of this interface hybrid and allowing all vlan

## Port Security Configuration

(config-if)#channel-group 1 mode active	Add this interface to channel group 1 and enable link aggregation so that it can be selected for aggregation by the local system.
(config-if)#exit	Exit interface mode
(config)#interface xe1/1	Entering interface mode
(config-if)#switchport	Configuring interface as switchport
(config-if)#bridge-group 1 spanning-tree disable	Associate the interface with bridge group 1 and disabling spanning-tree
(config-if)#switchport mode hybrid	Set the switching characteristics of this interface hybrid
(config-if)#switchport hybrid allowed vlan all	Set the switching characteristics of this interface hybrid and allowing all vlan
(config-if)#channel-group 1 mode active	Add this interface to channel group 1 and enable link aggregation so that it can be selected for aggregation by the local system.
(config-if)#exit	Exit interface mode
(config)#interface xe3/3	Entering interface mode
(config-if)#switchport	Configuring interface as switchport
(config-if)#bridge-group 1	Associate the interface with bridge group 1 and disabling spanning-tree
(config-if)#switchport mode hybrid	Set the switching characteristics of this interface hybrid
(config-if)#switchport hybrid allowed vlan all	Set the switching characteristics of this interface hybrid and allowing all VLAN

## Validation

TOR1#show bridge

Ageout time is global and if something is configured for vxlan then it will be affected here also

Bridge	CVLAN	SVLAN	BVLAN	Port	MAC Address	FWD	Time-out
1		2		m1ag3	0000.0500.0200	1	54
1		2		m1ag3	0000.0500.0201	1	60
1		2		m1ag3	0000.0500.0202	1	54
1		2		m1ag3	0000.0500.0203	1	60
1		2		m1ag3	0000.0500.0204	1	54
1		2		m1ag3	0000.0500.0205	1	60
1		2		m1ag3	0000.0500.0207	1	60
1		2		m1ag3	0000.0500.0208	1	54
1		2		m1ag3	0000.0500.0209	1	60
1		2		m1ag3	0000.0500.020a	1	54
1		2		m1ag3	0000.0500.020b	1	60
1		2		m1ag3	0000.0500.020c	1	54
1		2		m1ag3	0000.0500.020d	1	60
1		2		m1ag3	0000.0500.020e	1	54
1		2		m1ag3	0000.0500.020f	1	60
1		2		m1ag3	0000.0500.0210	1	54
1		2		m1ag3	0000.0500.0211	1	60
1		2		m1ag3	0000.0500.0212	1	54
1		2		m1ag3	cc37.abbb.ed9b	1	40



---

```
TOR1#sh port-security
Port      port-security mode  MAC limit CVLAN  SVLAN  static secure MAC
-----+-----+-----+-----+-----+-----
Mlag3    dynamic              10
TOR1#
TOR1#show mac address-table count bridge 1 interface mlag3
MAC Entries for all vlans:
Dynamic Address Count: 20
Static (User-defined) Unicast MAC Address Count: 0
Static (User-defined) Multicast MAC Address Count: 0
Total MAC Addresses in Use: 20
TOR1#
```



---

## CHAPTER 12 Port Breakout Configuration

---

This chapter contains an overview of splitting single 100G port to 4x10G ports.

---

### Overview

Port Breakout system enables numerous 100GbE ports to be broken out into 4x10GbE, 4x25GbE, 2x50GbE ports through a secure, highly reliable breakout cabling solution. Today's large-scale virtualized datacenter networks require a mix of 10Gb, 25Gb, 40Gb and 100Gb Ethernet interface speeds able to utilize the widest range of flexible connectivity options. These same networks require a variety of cost-effective cabling options for both addressing connectivity and allowing for simple migrations as network speeds and density requirements evolve. As data centers scale and bandwidth demands increase, the networking infrastructure must be capable of scaling with it. Port Breakout feature provides flexibility in splitting 100G to 4x10G, 4x25G, 2x50G cabling and vice-versa whenever requires, and hence provide Administrator a great flexibility in choosing the port speed as per their requirement. A Port Breakout group consists of 4 ports, first port will be control port and the rest 3 are subsidiary ports. Naming of Control port and its subsidiary port is as below

xe50/1, xe50/2, xe50/3, xe50/4

In xe50, numeral 50 indicates the slot of the port on a board and numerals after "/" indicates port numbers on that slot. First port (interface 50/1 in above example) is always control port whereas the rest 3 ports (ports 50/2, 50/3 and 50/4) are subsidiary ports. Only Control port can become 100G port.

Currently below breakout options are available

- 100G ports
  - 100G to 4x10G breakout ports
  - 100G to 4x25G breakout ports (due to HW limitation Autoneg isn't supported)
  - 100G to 2x50G breakout ports (due to HW limitation Autoneg isn't supported).

Note: There are some configuration restrictions for Subsidiary ports such as:

1. Port breakout enable/disable is not allowed on Subsidiary ports.
2. Speed, Duplex configurations are not allowed on InActive Subsidiary ports.
3. One control port and subsidiary ports will be supported in 100g to 2x50G breakout

For Example: Port XE1/1(control port) and XE1/3(subsidiary port) will be active out of 4 ports.

---

### Terminology

Following is a brief description of terms and concepts used to describe port breakout.

#### **Ctl: Control port**

A 100G splitable port is called Control port.

#### **Brk: Port Breakout**

A control port which is split into 4x10G 4x25G or 2x50 ports.

## Subsidiary ports

Ports which are members of Control Port, A subsidiary port can be Active or InActive

### IA: InActive Ports

Subsidiary ports whose control port is not configured for “Port Breakout”

---

## Pre-Requisite

From OcNOS version 5.1 onwards, before doing the Port breakout we need to reserve the VLANs using the CLI `vlan-reservation vlan-id/vlan-range`.

The main purpose of this vlan-reservation is when port breakout is not required, then Maximum vlans upto 4062 can be used for bridge configuration.

Note: Once VLANs are reserved, those vlans cannot be used for bridge configuration.

Note: We can release the reserved vlans by unconfiguring the `no port breakout enable` and `no vlan-reservation vlan-id/vlan-range`.

Note: Released VLANs can be used for bridge configuration.

---

## Configuring vlan-reservation

Configuring Port Breakout (40G to 4x10G) is provided in below section.

<code>#configure terminal</code>	Enter configure mode.
<code>(config)# vlan database</code>	Enter vlan database
<code>(config-if)# vlan-reservation 4050-4058</code>	Specify the vlan-range that should be reserved for interface port Breakout.
<code>(config-if)#exit</code>	Exit vlan database.

---

## Unconfiguring vlan-reservation

Configuring Port Breakout (40G to 4x10G) is provided in below section.

<code>#configure terminal</code>	Enter configure mode.
<code>(config)# vlan database</code>	Enter vlan database
<code>(config-if)# no vlan-reservation 4050-4058</code>	Specify the vlan-range/id that should be released
<code>(config-if)#exit</code>	Exit vlan database.

---

## Validation

Below output before applying port-breakout config on xe50/1:

```
#show vlan-reservation
VLAN ID      Status
=====
4050         free
4051         free
4052         free
4053         free
4054         free
4055         free
4056         free
4057         free
4058         free
```

---

## Configuring Port Breakout 40G to 4x10G

Configuring Port Breakout (40G to 4x10G) is provided in below section.

#configure terminal	Enter configure mode.
(config)#interface xe50/1	Specify the interface (xe50/1) to be configured for port Breakout.
(config-if)#port breakout enable 4X10g	Configure port breakout on interface
(config-if)#exit	Exit interface mode.

---

## Removing Port Breakout

Removing Port Breakout is provided in below section.

Note: Interface xe50/1 is back to back connected and interfaces are up.

#configure terminal	Enter configure mode.
(config)#interface xe50/1	Specify the interface (xe50/1) to be configured for port Breakout.
(config-if)#no port breakout	Unconfigure port breakout on interface
(config-if)#exit	Exit interface mode.

---

## Validation

```
#show interface brief
```

```
Codes: ETH - Ethernet, LB - Loopback, AGG - Aggregate, MLAG - MLAG Aggregate
Port   FR - Frame Relay, TUN -Tunnel, PBB - PBB Logical Port, VP - Virtual
Unknown CVP - Channelised Virtual Port, METH - Management Ethernet, UNK-
        ED - ErrDisabled, PD - Protocol Down, AD - Admin Down, IA - InActive
        PD(Min-links) - Protocol Down Min-links
        DV - DDM Violation, NA - Not Applicable
```

## Port Breakout Configuration

NOM - No operational members, PVID - Port Vlan-id  
 Ctl - Control Port (Br-Breakout/Bu-Bundle)

```

-----
--
Interface      Type              Status Reason Speed
Interface
-----
--
eth0           METH              up    --    1g

-----
--
Interface      Status      Description
-----
--
lo             up          --
lo.management up          --

-----
--
Ethernet      Type  PVID  Mode              Status Reason Speed Port    Ctl Br/
Bu
Interface
-----
--
xe1           ETH   --    routed            up    none  1g   --     Bu  No
xe2           ETH   --    routed            down  PD    10g  --     No  No
xe3           ETH   --    routed            down  PD    10g  --     No  No
xe4           ETH   --    routed            down  PD    10g  --     No  No
xe5           ETH   --    routed            down  PD    10g  --     Bu  No
xe6           ETH   --    routed            down  PD    10g  --     No  No
xe7           ETH   --    routed            down  PD    10g  --     No  No
xe8           ETH   --    routed            down  PD    10g  --     No  No
xe9           ETH   --    routed            down  PD    10g  --     Bu  No
xe10          ETH   --    routed            down  PD    10g  --     No  No
xe11          ETH   --    routed            down  PD    10g  --     No  No
xe12          ETH   --    routed            down  PD    10g  --     No  No
xe13          ETH   --    routed            down  PD    10g  --     Bu  No
xe14          ETH   --    routed            down  PD    10g  --     No  No
xe15          ETH   --    routed            down  PD    10g  --     No  No
xe16          ETH   --    routed            down  PD    10g  --     No  No
xe17          ETH   --    routed            down  PD    10g  --     Bu  No
xe18          ETH   --    routed            down  PD    10g  --     No  No
xe19          ETH   --    routed            down  PD    10g  --     No  No
xe20          ETH   --    routed            down  PD    10g  --     No  No
xe21          ETH   --    routed            down  PD    10g  --     Bu  No
xe22          ETH   --    routed            down  PD    10g  --     No  No
xe23          ETH   --    routed            down  PD    10g  --     No  No
xe24          ETH   --    routed            down  PD    10g  --     No  No
xe25          ETH   --    routed            up    none  10g  --     Bu  No
xe26          ETH   --    routed            down  PD    10g  --     No  No
xe27          ETH   --    routed            up    none  10g  --     No  No
xe28          ETH   --    routed            down  PD    10g  --     No  No
xe29          ETH   --    routed            down  PD    10g  --     Bu  No
  
```

xe30	ETH	--	routed	down	PD	10g	--	No	No
xe31	ETH	--	routed	down	PD	10g	--	No	No
xe32	ETH	--	routed	down	PD	10g	--	No	No
xe33	ETH	--	routed	down	PD	10g	--	Bu	No
xe34	ETH	--	routed	down	PD	10g	--	No	No
xe35	ETH	--	routed	down	PD	10g	--	No	No
xe36	ETH	--	routed	down	PD	10g	--	No	No
xe37	ETH	--	routed	down	PD	10g	--	Bu	No
xe38	ETH	--	routed	down	PD	10g	--	No	No
xe39	ETH	--	routed	down	PD	10g	--	No	No
xe40	ETH	--	routed	down	PD	10g	--	No	No
xe41	ETH	--	routed	down	PD	10g	--	Bu	No
xe42	ETH	--	routed	down	PD	10g	--	No	No
xe43	ETH	--	routed	down	PD	10g	--	No	No
xe44	ETH	--	routed	down	PD	10g	--	No	No
xe45	ETH	--	routed	down	PD	10g	--	Bu	No
xe46	ETH	--	routed	down	PD	10g	--	No	No
xe47	ETH	--	routed	down	PD	10g	--	No	No
xe48	ETH	--	routed	down	PD	10g	--	No	No
xe49/1	ETH	--	routed	down	PD	40g	--	Br	No
xe49/2	ETH	--	routed	down	IA	--	--	No	No
xe49/3	ETH	--	routed	down	IA	--	--	No	No
xe49/4	ETH	--	routed	down	IA	--	--	No	No
xe50/1	ETH	--	routed	up	none	40g	--	Br	No
xe50/2	ETH	--	routed	down	IA	--	--	No	No
xe50/3	ETH	--	routed	down	IA	--	--	No	No
xe50/4	ETH	--	routed	down	IA	--	--	No	No

#show interface xe50/1

Interface xe50/1

Flexport: Breakout Control Port (Active): Break Out disabled

Hardware is ETH Current HW addr: a82b.b5ad.db6f

Physical:a82b.b5ad.dba4 Logical:(not set)

Port Mode is Router

Interface index: 10053

Metric 1 mtu 1500 duplex-full link-speed 40g

<UP,BROADCAST,RUNNING,MULTICAST>

VRF Binding: Not bound

DHCP client is disabled.

Last Flapped: 2001 Feb 13 18:42:15 (00:03:20 ago)

Statistics last cleared: Never

inet6 fe80::aa2b:b5ff:fead:db6f/64

5 minute input rate 20 bits/sec, 0 packets/sec

5 minute output rate 20 bits/sec, 0 packets/sec

RX

unicast packets 0 multicast packets 7 broadcast packets 0

input packets 7 bytes 766

jumbo packets 0

runts 0 giants 0 CRC 0 fragments 0 jabbers 0

input error 0

input with dribble 0 input discard 0

Rx pause 0

TX

unicast packets 0 multicast packets 7 broadcast packets 0

output packets 7 bytes 766

jumbo packets 0

output errors 0 collision 0 deferred 0 late collision 0

## Port Breakout Configuration

---

```
output discard 0
Tx pause 0
```

```
#show interface xe50/2
```

```
Interface xe50/2
```

```
Flexport: Non Control Port (InActive)
Hardware is ETH Current HW addr: a82b.b5ad.db6f
Physical:a82b.b5ad.dba5 Logical:(not set)
Port Mode is Router
Interface index: 10054
Metric 1 mtu 1500
<UP,BROADCAST,MULTICAST>
VRF Binding: Not bound
DHCP client is disabled.
Last Flapped: 2001 Feb 13 18:42:15 (00:03:46 ago)
Statistics last cleared: Never
inet6 fe80::aa2b:b5ff:fead:db6f/64
5 minute input rate 0 bits/sec, 0 packets/sec
5 minute output rate 0 bits/sec, 0 packets/sec
```

```
RX
```

```
unicast packets 0 multicast packets 0 broadcast packets 0
input packets 0 bytes 0
jumbo packets 0
runts 0 giants 0 CRC 0 fragments 0 jabbers 0
input error 0
input with dribble 0 input discard 0
Rx pause 0
```

```
TX
```

```
unicast packets 0 multicast packets 0 broadcast packets 0
output packets 0 bytes 0
jumbo packets 0
output errors 0 collision 0 deferred 0 late collision 0
output discard 0
Tx pause 0
```

```
#show interface xe50/3
```

```
Interface xe50/3
```

```
Flexport: Non Control Port (InActive)
Hardware is ETH Current HW addr: a82b.b5ad.db6f
Physical:a82b.b5ad.dba6 Logical:(not set)
Port Mode is Router
Interface index: 10055
Metric 1 mtu 1500
<UP,BROADCAST,MULTICAST>
VRF Binding: Not bound
DHCP client is disabled.
Last Flapped: 2001 Feb 13 18:42:15 (00:07:30 ago)
Statistics last cleared: Never
inet6 fe80::aa2b:b5ff:fead:db6f/64
5 minute input rate 0 bits/sec, 0 packets/sec
5 minute output rate 0 bits/sec, 0 packets/sec
```

```
RX
```

```
unicast packets 0 multicast packets 0 broadcast packets 0
input packets 0 bytes 0
jumbo packets 0
runts 0 giants 0 CRC 0 fragments 0 jabbers 0
input error 0
```



```

    input with dribble 0 input discard 0
    Rx pause 0
TX
    unicast packets 0 multicast packets 0 broadcast packets 0
    output packets 0 bytes 0
    jumbo packets 0
    output errors 0 collision 0 deferred 0 late collision 0
    output discard 0
    Tx pause 0

#show interface xe50/4
Interface xe50/4
  Flexport: Non Control Port (InActive)
  Hardware is ETH Current HW addr: a82b.b5ad.db6f
  Physical:a82b.b5ad.dba7 Logical:(not set)
  Port Mode is Router
  Interface index: 10056
  Metric 1 mtu 1500
  <UP,BROADCAST,MULTICAST>
  VRF Binding: Not bound
  DHCP client is disabled.
  Last Flapped: 2001 Feb 13 18:42:15 (00:07:36 ago)
  Statistics last cleared: Never
  inet6 fe80::aa2b:b5ff:fead:db6f/64
  5 minute input rate 0 bits/sec, 0 packets/sec
  5 minute output rate 0 bits/sec, 0 packets/sec
RX
  unicast packets 0 multicast packets 0 broadcast packets 0
  input packets 0 bytes 0
  jumbo packets 0
  runts 0 giants 0 CRC 0 fragments 0 jabbers 0
  input error 0
  input with dribble 0 input discard 0
  Rx pause 0
TX
  unicast packets 0 multicast packets 0 broadcast packets 0
  output packets 0 bytes 0
  jumbo packets 0
  output errors 0 collision 0 deferred 0 late collision 0
  output discard 0
  Tx pause 0

```

Here xe50/1 is a control Port whereas xe50/2, xe50/3 and xe50/4 are their subsidiary ports. The out-put shows only xe50/1 is active (interface up and running) whereas other ports are inactive (interface up but not running).

Below Outputs after applying port-breakout configured on xe50/1:

#### VLAN-reservation validation:

```

#show vlan-reservation
VLAN ID      Status
=====
4050         allocated
4051         allocated
4052         allocated
4053         free
4054         free

```

## Port Breakout Configuration

```
4055          free
4056          free
4057          free
4058          free
```

```
#show interface brief
```

```
Codes: ETH - Ethernet, LB - Loopback, AGG - Aggregate, MLAG - MLAG Aggregate
Port    FR - Frame Relay, TUN -Tunnel, PBB - PBB Logical Port, VP - Virtual
Unknown CVP - Channelised Virtual Port, METH - Management Ethernet, UNK-
        ED - ErrDisabled, PD - Protocol Down, AD - Admin Down, IA - InActive
        PD(Min-links) - Protocol Down Min-links
        DV - DDM Violation, NA - Not Applicable
        NOM - No operational members, PVID - Port Vlan-id
        Ctl - Control Port (Br-Breakout/Bu-Bundle)
```

```
-----
--
Interface      Type              Status Reason Speed
Interface
-----
--
eth0           METH              up    --    1g
```

```
-----
--
Interface      Status      Description
-----
--
lo              up          --
lo.management  up          --
```

```
-----
--
Ethernet      Type  PVID  Mode              Status Reason Speed Port    Ctl Br/
Bu
Interface                                  Ch #
-----
--
xe1           ETH   --    routed            up    none  1g   --     Bu  No
xe2           ETH   --    routed            down  PD    10g  --     No  No
xe3           ETH   --    routed            down  PD    10g  --     No  No
xe4           ETH   --    routed            down  PD    10g  --     No  No
xe5           ETH   --    routed            down  PD    10g  --     Bu  No
xe6           ETH   --    routed            down  PD    10g  --     No  No
xe7           ETH   --    routed            down  PD    10g  --     No  No
xe8           ETH   --    routed            down  PD    10g  --     No  No
xe9           ETH   --    routed            down  PD    10g  --     Bu  No
xe10          ETH   --    routed            down  PD    10g  --     No  No
xe11          ETH   --    routed            down  PD    10g  --     No  No
xe12          ETH   --    routed            down  PD    10g  --     No  No
xe13          ETH   --    routed            down  PD    10g  --     Bu  No
xe14          ETH   --    routed            down  PD    10g  --     No  No
```

xe15	ETH	--	routed	down	PD	10g	--	No	No
xe16	ETH	--	routed	down	PD	10g	--	No	No
xe17	ETH	--	routed	down	PD	10g	--	Bu	No
xe18	ETH	--	routed	down	PD	10g	--	No	No
xe19	ETH	--	routed	down	PD	10g	--	No	No
xe20	ETH	--	routed	down	PD	10g	--	No	No
xe21	ETH	--	routed	down	PD	10g	--	Bu	No
xe22	ETH	--	routed	down	PD	10g	--	No	No
xe23	ETH	--	routed	down	PD	10g	--	No	No
xe24	ETH	--	routed	down	PD	10g	--	No	No
xe25	ETH	--	routed	up	none	10g	--	Bu	No
xe26	ETH	--	routed	down	PD	10g	--	No	No
xe27	ETH	--	routed	up	none	10g	--	No	No
xe28	ETH	--	routed	down	PD	10g	--	No	No
xe29	ETH	--	routed	down	PD	10g	--	Bu	No
xe30	ETH	--	routed	down	PD	10g	--	No	No
xe31	ETH	--	routed	down	PD	10g	--	No	No
xe32	ETH	--	routed	down	PD	10g	--	No	No
xe33	ETH	--	routed	down	PD	10g	--	Bu	No
xe34	ETH	--	routed	down	PD	10g	--	No	No
xe35	ETH	--	routed	down	PD	10g	--	No	No
xe36	ETH	--	routed	down	PD	10g	--	No	No
xe37	ETH	--	routed	down	PD	10g	--	Bu	No
xe38	ETH	--	routed	down	PD	10g	--	No	No
xe39	ETH	--	routed	down	PD	10g	--	No	No
xe40	ETH	--	routed	down	PD	10g	--	No	No
xe41	ETH	--	routed	down	PD	10g	--	Bu	No
xe42	ETH	--	routed	down	PD	10g	--	No	No
xe43	ETH	--	routed	down	PD	10g	--	No	No
xe44	ETH	--	routed	down	PD	10g	--	No	No
xe45	ETH	--	routed	down	PD	10g	--	Bu	No
xe46	ETH	--	routed	down	PD	10g	--	No	No
xe47	ETH	--	routed	down	PD	10g	--	No	No
xe48	ETH	--	routed	down	PD	10g	--	No	No
xe49/1	ETH	--	routed	down	PD	40g	--	Br	No
xe49/2	ETH	--	routed	down	IA	--	--	No	No
xe49/3	ETH	--	routed	down	IA	--	--	No	No
xe49/4	ETH	--	routed	down	IA	--	--	No	No
xe50/1	ETH	--	routed	up	none	10g	--	Br	Yes
xe50/2	ETH	--	routed	up	none	10g	--	No	No
xe50/3	ETH	--	routed	up	none	10g	--	No	No
xe50/4	ETH	--	routed	up	none	10g	--	No	

#show interface xe50/1

Interface xe50/1

Flexport: Breakout Control Port (Active): Break Out Enabled

Hardware is ETH Current HW addr: a82b.b5ad.db6f

Physical:a82b.b5ad.dba4 Logical:(not set)

Port Mode is Router

Interface index: 10053

Metric 1 mtu 1500 duplex-full link-speed 10g

<UP,BROADCAST,RUNNING,MULTICAST>

VRF Binding: Not bound

DHCP client is disabled.

Last Flapped: 2001 Feb 13 18:54:58 (00:32:03 ago)

Statistics last cleared: Never

inet6 fe80::aa2b:b5ff:fead:db6f/64

## Port Breakout Configuration

---

```
5 minute input rate 0 bits/sec, 0 packets/sec
5 minute output rate 0 bits/sec, 0 packets/sec
RX
  unicast packets 0 multicast packets 7 broadcast packets 0
  input packets 23 bytes 801
  jumbo packets 0
  runts 0 giants 0 CRC 0 fragments 0 jabbers 0
  input error 16
  input with dribble 0 input discard 0
  Rx pause 0
TX
  unicast packets 0 multicast packets 14 broadcast packets 0
  output packets 14 bytes 1532
  jumbo packets 0
  output errors 0 collision 0 deferred 0 late collision 0
  output discard 0
  Tx pause 0
```

```
#show interface xe50/2
```

```
Interface xe50/2
  Flexport: Non Control Port (Active)
  Hardware is ETH Current HW addr: a82b.b5ad.db6f
  Physical:a82b.b5ad.dba5 Logical:(not set)
  Port Mode is Router
  Interface index: 10054
  Metric 1 mtu 1500 duplex-full link-speed 10g
  <UP,BROADCAST,RUNNING,MULTICAST>
  VRF Binding: Not bound
  DHCP client is disabled.
  Last Flapped: 2001 Feb 13 18:42:15 (00:45:16 ago)
  Statistics last cleared: Never
  inet6 fe80::aa2b:b5ff:fead:db6f/64
  5 minute input rate 0 bits/sec, 0 packets/sec
  5 minute output rate 0 bits/sec, 0 packets/sec
RX
  unicast packets 0 multicast packets 7 broadcast packets 0
  input packets 23 bytes 790
  jumbo packets 0
  runts 0 giants 0 CRC 0 fragments 0 jabbers 0
  input error 16
  input with dribble 0 input discard 0
  Rx pause 0
TX
  unicast packets 0 multicast packets 7 broadcast packets 0
  output packets 7 bytes 766
  jumbo packets 0
  output errors 0 collision 0 deferred 0 late collision 0
  output discard 0
  Tx pause 0
```

```
#show interface xe50/3
```

```
Interface xe50/3
  Flexport: Non Control Port (Active)
  Hardware is ETH Current HW addr: a82b.b5ad.db6f
  Physical:a82b.b5ad.dba6 Logical:(not set)
  Port Mode is Router
```

```
Interface index: 10055
Metric 1 mtu 1500 duplex-full link-speed 10g
<UP,BROADCAST,RUNNING,MULTICAST>
VRF Binding: Not bound
DHCP client is disabled.
Last Flapped: 2001 Feb 13 18:42:15 (00:45:31 ago)
Statistics last cleared: Never
inet6 fe80::aa2b:b5ff:fead:db6f/64
5 minute input rate 0 bits/sec, 0 packets/sec
5 minute output rate 0 bits/sec, 0 packets/sec
RX
  unicast packets 0 multicast packets 7 broadcast packets 0
  input packets 26 bytes 801
  jumbo packets 0
  runs 0 giants 0 CRC 0 fragments 0 jabbers 0
  input error 19
  input with dribble 0 input discard 0
  Rx pause 0
TX
  unicast packets 0 multicast packets 7 broadcast packets 0
  output packets 7 bytes 766
  jumbo packets 0
  output errors 0 collision 0 deferred 0 late collision 0
  output discard 0
  Tx pause 0

#show interface xe50/4
Interface xe50/4
  Flexport: Non Control Port (Active)
  Hardware is ETH Current HW addr: a82b.b5ad.db6f
  Physical:a82b.b5ad.dba7 Logical:(not set)
  Port Mode is Router
  Interface index: 10056
  Metric 1 mtu 1500 duplex-full link-speed 10g
  <UP,BROADCAST,RUNNING,MULTICAST>
  VRF Binding: Not bound
  DHCP client is disabled.
  Last Flapped: 2001 Feb 13 18:54:58 (00:33:07 ago)
  Statistics last cleared: Never
  inet6 fe80::aa2b:b5ff:fead:db6f/64
  5 minute input rate 0 bits/sec, 0 packets/sec
  5 minute output rate 0 bits/sec, 0 packets/sec
RX
  unicast packets 0 multicast packets 7 broadcast packets 0
  input packets 22 bytes 792
  jumbo packets 0
  runs 0 giants 0 CRC 0 fragments 0 jabbers 0
  input error 15
  input with dribble 0 input discard 0
  Rx pause 0
TX
  unicast packets 0 multicast packets 14 broadcast packets 0
  output packets 14 bytes 1532
  jumbo packets 0
  output errors 0 collision 0 deferred 0 late collision 0
  output discard 0
  Tx pause 0
```

## Configuring Port Breakout (100G to 4x10G)

Configuring Port Breakout (100G to 4x10G) is provided in below section.

#configure terminal	Enter configure mode.
(config)#interface ce1/1	Specify the interface (ce1/1) to be configured for port Breakout.
(config-if)#port breakout enable 4x10g	Configure port breakout on interface
(config-if)#exit	Exit interface mode.

Note: Interface ce1/1 is back to back connected and interfaces are up.

---

## Validation

### VLAN-reservation validation

```
#show vlan-reservation
VLAN ID      Status
=====
4050         allocated
4051         allocated
4052         allocated
4053         allocated
4054         allocated
4055         allocated
4056         free
4057         free
4058         free
```

```
#show interface brief
```

```
Codes: ETH - Ethernet, LB - Loopback, AGG - Aggregate, MLAG - MLAG Aggregate
FR - Frame Relay, TUN -Tunnel, PBB - PBB Logical Port, VP - Virtual
Port
CVP - Channelised Virtual Port, METH - Management Ethernet, UNK-
Unknown
ED - ErrDisabled, PD - Protocol Down, AD - Admin Down, IA - InActive
PD(Min-links) - Protocol Down Min-links
DV - DDM Violation, NA - Not Applicable
NOM - No operational members, PVID - Port Vlan-id
Ctl - Control Port (Br-Breakout/Bu-Bundle)
```

```
-----
--
Ethernet  Type  PVID  Mode                Status  Reason  Speed  Port    Ctl Br/
Bu
Interface                                     Ch #
-----
--
```

ce1/1	ETH	--	routed	up	none	10g	--	Br	Yes
ce1/2	ETH	--	routed	up	none	10g	--	No	No
ce1/3	ETH	--	routed	up	none	10g	--	No	No
ce1/4	ETH	--	routed	up	none	10g	--	No	No

## Configuring Port Breakout (100G to 4x25G)

Configuring Port Breakout (100G to 4x25G) is provided in below section.

#configure terminal	Enter configure mode.
(config)#interface ce1/1	Specify the interface (ce1/1) to be configured for port Breakout.
(config-if)#port breakout enable 4x25g	Configure port breakout on interface
(config-if)#exit	Exit interface mode.

Note: Interface ce1/1 is back to back connected and interfaces are up.

## Validation

### VLAN-reservation validation

```
#show vlan-reservation
VLAN ID      Status
=====
4050         allocated
4051         allocated
4052         allocated
4053         allocated
4054         allocated
4055         allocated
4056         free
4057         free
4058         free
```

```
#show interface brief
```

```
Codes: ETH - Ethernet, LB - Loopback, AGG - Aggregate, MLAG - MLAG Aggregate
FR - Frame Relay, TUN -Tunnel, PBB - PBB Logical Port, VP - Virtual
Port
CVP - Channelised Virtual Port, METH - Management Ethernet, UNK-
Unknown
ED - ErrDisabled, PD - Protocol Down, AD - Admin Down, IA - InActive
PD(Min-links) - Protocol Down Min-links
DV - DDM Violation, NA - Not Applicable
NOM - No operational members, PVID - Port Vlan-id
Ctl - Control Port (Br-Breakout/Bu-Bundle)
```

```
-----
--
Ethernet  Type  PVID  Mode                Status  Reason  Speed Port      Ctl Br/Bu
Interface                                Ch #
```

```

-----
--
cel/1      ETH   --   routed   up      none   25g   --      Br
Yes
cel/2      ETH   --   routed   up      none   25g   --      No  No
cel/3      ETH   --   routed   up      none   25g   --      No  No
cel/4      ETH   --   routed   up      none   25g   --      No  No
    
```

## Configuring Port Breakout (100G to 2x50G)

Configuring Port Breakout (100G to 2x50G) is provided in below section.

#configure terminal	Enter configure mode.
(config)#interface ce1/1	Specify the interface (ce1/1) to be configured for port Breakout.
(config-if)#port breakout enable 2x50g	Configure port breakout on interface
(config-if)#exit	Exit interface mode.

Note: Interface ce1/1 is back to back connected and interfaces are up.

## Validation

### VLAN-reservation validation

```

#show vlan-reservation
VLAN ID      Status
=====
4050         allocated
4051         allocated
4052         allocated
4053         allocated
4054         allocated
4055         allocated
4056         free
4057         free
4058         free
    
```

```
#show interface brief
```

```

Codes: ETH - Ethernet, LB - Loopback, AGG - Aggregate, MLAG - MLAG Aggregate
Port      FR - Frame Relay, TUN -Tunnel, PBB - PBB Logical Port, VP - Virtual
Unknown  CVP - Channelised Virtual Port, METH - Management Ethernet, UNK-
ED - ErrDisabled, PD - Protocol Down, AD - Admin Down, IA - InActive
PD(Min-links) - Protocol Down Min-links
DV - DDM Violation, NA - Not Applicable
NOM - No operational members, PVID - Port Vlan-id
Ctl - Control Port (Br-Breakout/Bu-Bundle)
    
```



---

```
-----  
--  
Ethernet      Type  PVID  Mode          Status  Reason  Speed  Port  Ctl  Br/  
Bu  
Interface                                Ch #  
-----  
--  
ce1/1         ETH   --    routed        up      none    50g    --    Br  
Yes  
ce1/2         ETH   --    routed        down    IA      --     --    No   No  
ce1/3         ETH   --    routed        up      none    50g    --    No   No  
ce1/4         ETH   --    routed        down    IA      --     --    No   No
```



# CHAPTER 13 Layer 2 Control Protocols Tunneling

## Overview

The Layer 2 Control Protocols (L2CP) processing specified here is based largely on the IEEE 802.1Q specification for handling L2CP Frames, i.e. if they should be forwarded, peered, or discarded.

IEEE 802.1Q provides a mechanism for separating the Layer2 control plane into multiple customer and provider control planes. It allows a certain layer 2 control protocol to operate only within a provider network, or to allow interaction between the customer and the provider network, or to pass transparently through a provider network with complete isolation from other customer networks.

In case of non-PB case, packet is forwarded without changing any MAC.

## L2CP Tunneling for Provider Bridging

L2CP tunneling provides support for tunneling control plane frames between CE nodes.

In the context of PB, a L2CP frame is defined as any frame containing a destination MAC address as 01:00:0C:CD:CD:D0 or 01:04:DF:CD:CD:D0 (which can be changed via CLI)

When control frames received at CEP port of a PE bridge, predefined multicast address (01-00-C2-CD-CD-D0) is replaced as destination for tunneling the packets across service provider network. If control packets are customer vlan tagged or untagged, then PE bridge will append corresponding service vlan tag to the control packet as per registration table / vlan translation table mapped to the port and send it across the service provider as a data packet.

When tunneled control packet with multicast address (01-00-C2-CD-CD-D0) received on PNP port, the multicast address is replaced with corresponding control packet multicast address and cvlan/svlan removal or update is done as per registration table / vlan translation table.

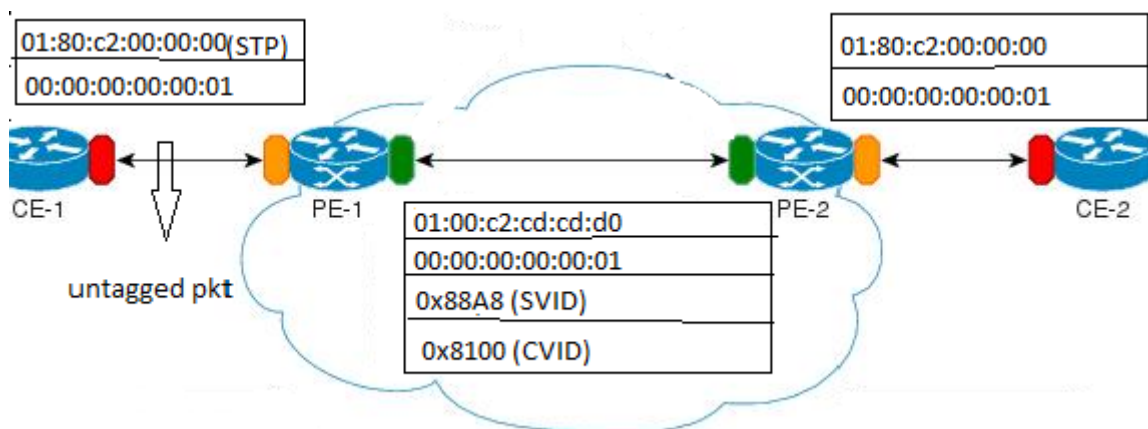

Figure 13-21: L2CP tunneling for provider bridging

## L2CP Tunneling for VPLS/VPWS/Hybrid (Bridge+VPWS)

L2CP tunneling provides support for tunneling Control plane frames across L2VPN.

## L2CP Tunneling for VXLAN

L2CP tunneling provides support for tunneling Control plane frames across VxLAN/MH.

### Topology

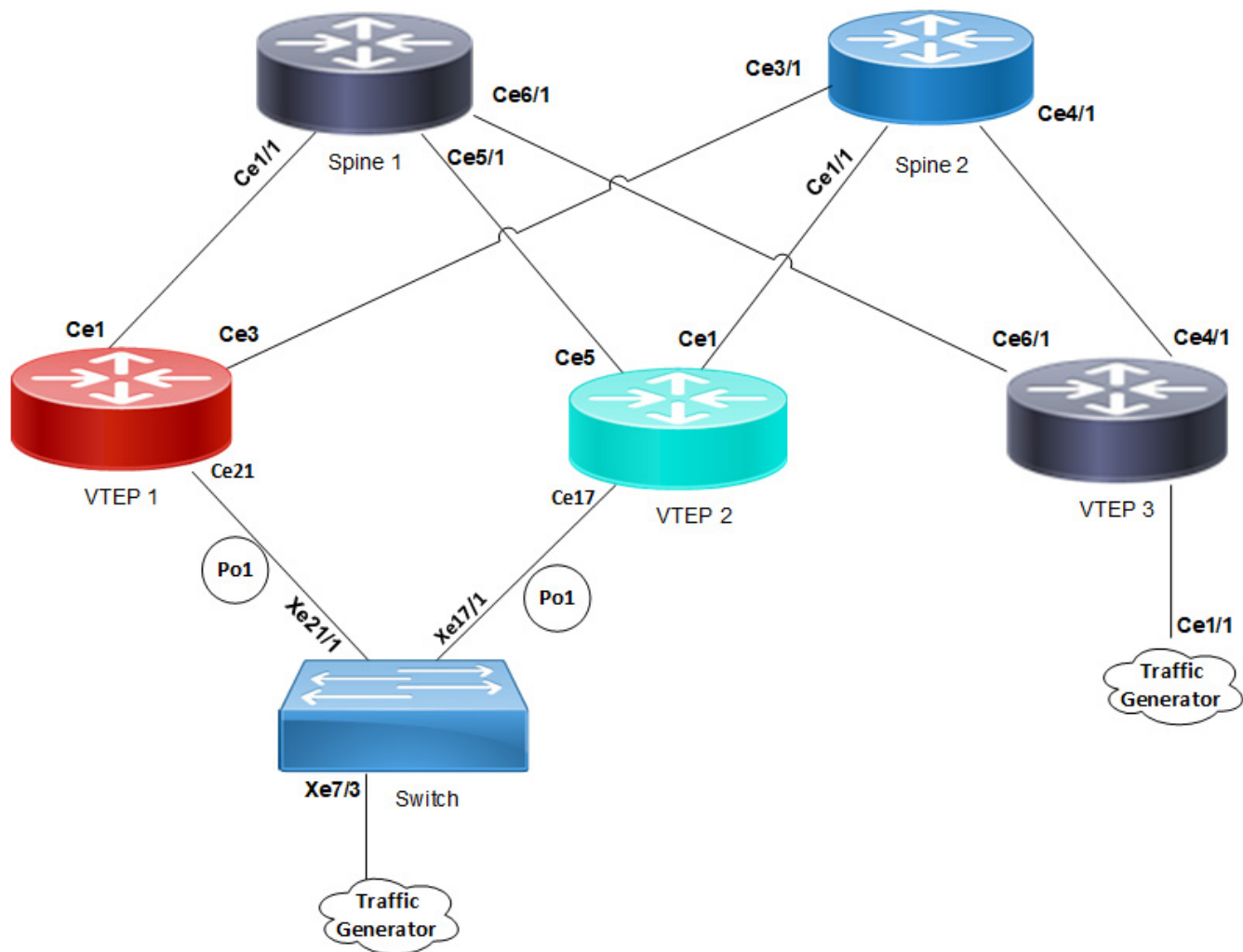

**Figure 13-22: L2CP tunneling for VXLAN**

VXLAN creates LAN segments using a MAC in IP encapsulation. The encapsulation carries the original L2 frame received from a host to the destination in another server using IP tunnels. The endpoints of the virtualized tunnel formed using VXLAN are called VTEPs (VXLAN Tunnel EndPoints).

L2CP tunneling provides support for tunneling control plane frames across VXLAN with MH/SH combination.

Any L2CP frame that is destined towards other end with a multicast destination MAC Address for L2 protocol is decided by looking at the frame and upon the configured values of the L2CP Service Attributes.

As and when Control packets with default destination MAC address for any L2 protocol is generated, it will be forwarded by VTEPs that are part of MH towards the VTEP that is part of SH and vice versa.

During this operation, the default destination MAC address for any L2 protocol is replaced with predefined multicast address as destination for tunneling the packets across SPINE nodes. When tunneled control packet with pre-defined multicast address received on ingress port on the other end of the VTEP, the multicast address is replaced with corresponding control packet multicast address.

## Default Behavior

If control packets are received at the PE router on AC port (vlan tagged/untagged), corresponding AC port properties will take care of forwarding to peer PE node. These packets are encapsulated with MPLS headers and sent across the network to the remote PE router. The egress PE router receives the packet and performs MPLS decapsulation and forwards to the CE. Except for LACP, all other control packets are tunnels across the MPLS circuit.

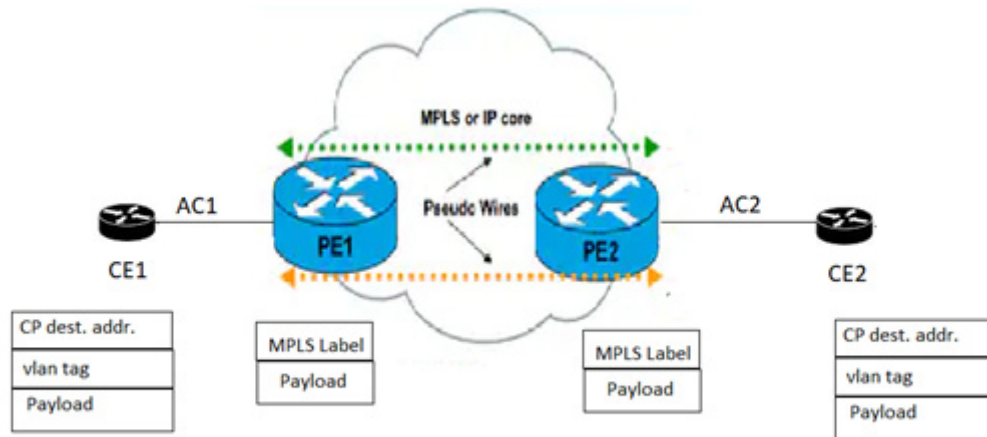

Figure 13-23: L2CP tunneling for VPLS/VPWS/Hybrid (bridge+VPWS)

## Hybrid Port

When the incoming port is configured as Hybrid (Bridge+L2VPN), L2CP switches to peering mode. You can override this behavior with the help of L2CP configurations.

## L2CP Behavior

The action taken for a given L2CP Frame at a given L2CP Decision Point depends upon the Destination Address within the frame, and upon the configured values of the L2CP Service Attributes.

The three possible actions at an L2CP Decision Points are: Discard, Peer, or Pass/Tunnel.

Discard	The L2CP frame is neither peered nor forwarded.
Peer	The L2CP frame will be processed.
Pass/Tunnel	Pass (or forwarded) means that the frame will be passed transparently in the same way as normal data frames.

## Default L2CP configuration

Default L2CP decision in Provider Bridging case:

**Table 13-1: Default L2CP decision for Provider Bridging**

Protocol Type	L2CP destination address	Ethertype/subtype	Default L2CP action
STP (Spanning Tree Protocols)	01-80-c2-00-00-00	N/A	PEER
LACP (Link Aggregation Control Protocol)	01-80-c2-00-00-02	ethertype 0x8809 and subtype 0x1 or 0x2	PEER
DOT1X (Port Authentication (802.1 X))	01-80-c2-00-00-03	N/A	PEER
LLDP (Link layer discovery protocol)	01-80-c2-00-00-0e	ethertype 0x88CC	PEER
EFM (Ethernet first mile (Link OAM))	01-80-c2-00-00-02	ethertype 0x8809 and subtype 0x3	PEER
ELMI (Ethernet Local Management Interface)	01-80-c2-00-00-07	ethertype 0x88EE	PEER

Default L2CP Decision in VPLS/VPWS/Hybrid case:

- For bridged packets in case of hybrid port:

**Table 13-2: Default L2CP decision for hybrid port**

Protocol Type	L2CP destination address	Default L2CP action
STP(Spanning Tree Protocols)	01-80-c2-00-00-00	PEER
LACP (Link Aggregation Control Protocol)	01-80-c2-00-00-02	PEER
DOT1X (Port Authentication (802.1 X))	01-80-c2-00-00-03	PEER
LLDP (Link layer discovery protocol)	01-80-c2-00-00-0e	PEER
EFM (Ethernet first mile (Link OAM))	01-80-c2-00-00-02	PEER
ELMI (Ethernet Local Management Interface)	01-80-c2-00-00-07	PEER

- For VPLS/VPWS:

**Table 13-3: Default L2CP decision for VPLS/VPWS**

Protocol Type	L2CP destination address	Default L2CP action
STP(Spanning Tree Protocols)	01-80-c2-00-00-00	TUNEEL
LACP (Link Aggregation Control Protocol)	01-80-c2-00-00-02	PEER

**Table 13-3: Default L2CP decision for VPLS/VPWS (Continued)**

Protocol Type	L2CP destination address	Default L2CP action
DOT1X (Port Authentication (802.1 X))	01-80-c2-00-00-03	TUNNEL
LLDP (Link layer discovery protocol)	01-80-c2-00-00-0e	TUNNEL
EFM (Ethernet first mile (Link OAM))	01-80-c2-00-00-02	TUNNEL
ELMI (Ethernet Local Management Interface)	01-80-c2-00-00-07	TUNNEL

## Operational Concepts and Scenarios

### Basic Configuration for L2CP for Hybrid+VPLS

Enabling tunneling at bridged interface:

```
(config-if)#show run in xel1
!
interface xel1
 speed 1g
 switchport
 bridge-group 1
 switchport mode trunk
 switchport trunk allowed vlan all
 mpls-l2-circuit vc1 service-template svc1

#config ter
#(config)interface xel1
(config-if)# l2protocol stp tunnel
(config-if)#commit
(config-if)#end
```

To display L2CP information:

```
#show l2protocol processing interface xel1
Bridge      Interface Name  Protocol      Processing Status      Hardware Status
=====      =====
-           xel1           stp           Tunnel                 Tunnel
-           xel1           lacp          None                   Peer
-           xel1           dot1x        None                   Peer
-           xel1           lldp         None                   Peer
-           xel1           efm          None                   Peer
-           xel1           elmi         None                   Peer
```

```
(config)#in xel1
(config-if)#no l2protocol stp
(config-if)#end
```

```
#show l2protocol processing interface xe11
```

Bridge	Interface Name	Protocol	Processing Status	Hardware Status
-	xe11	stp	None	Peer
-	xe11	lacp	None	Peer
-	xe11	dot1x	None	Peer
-	xe11	lldp	None	Peer
-	xe11	efm	None	Peer
-	xe11	elmi	None	Peer

Note: If the configuration is not done, hardware status shows the default values while the configured will be none. On configuring L2CP on interface, configured and hardware status will be same.

---

## Basic Configuration for L2CP in VPLS

Enabling tunneling at ingress VPLS interface:

```
#show run in xe12
!
interface xe12
 speed 1g
 mpls-l2-circuit vc1 service-template svcl
!
#config ter
#(config)interface xe12
(config-if)#commit
```

To display L2CP information:

```
#show l2protocol processing interface xe12
```

Bridge	Interface Name	Protocol	Processing Status	Hardware Status
-	xe12	stp	Discard	Discard
-	xe12	lacp	None	Peer
-	xe12	dot1x	None	Tunnel
-	xe12	lldp	None	Tunnel
-	xe12	efm	None	Tunnel
-	xe12	elmi	None	Tunnel

---

## Basic Configuration for L2CP on Provider Bridging

Enabling tunneling at interface:

```
(config)#bridge 1 protocol provider-rstp edge
(config)#vlan database
(config-vlan)#vlan 2-10 bridge 1 state enable
(config-vlan)#vlan 11 type service point-point bridge 1 state enable
(config-vlan)#ex
(config)#cvlan registration table map1 bridge 1
(config-cvlan-registration)#cvlan 2 svlan 11
(config-cvlan-registration)#ex
```



```
(config)#interface xe1
(config-if)#switchport
(config-if)#bridge-group 1
(config-if)#switchport mode customer-edge hybrid
(config-if)#switchport customer-edge hybrid allowed vlan all
(config-if)#switchport customer-edge vlan registration map1
(config-if)#l2protocol stp tunnel
#show running-config interface xe1
!
interface xe1
speed 1g
switchport
bridge-group 1
switchport mode customer-edge hybrid
switchport customer-edge hybrid allowed vlan all
switchport customer-edge vlan registration map1
l2protocol stp tunnel
customer-spanning-tree provider-edge svlan 11 path-cost 128
(config-if)#commit
```

### Configuring egress interfaces”

```
(config)#interface xe2
(config-if)#switchport
(config-if)#bridge-group 1
(config-if)#switchport mode provider-network
(config-if)#switchport provider-network allowed vlan all
(config-if)#commit
```

### To display L2protocol information:

```
#show l2protocol processing interface xe1
```

Bridge	Interface Name	Protocol	Processing Status	Hardware Status
=====	=====	=====	=====	=====
1	xe1	stp	Tunnel	Tunnel
1	xe1	lacp	Peer	Peer
1	xe1	dot1x	Peer	Peer
1	xe1	lldp	Peer	Peer
1	xe1	efm	Peer	Peer
1	xe1	elmi	Peer	Peer

### To display L2protocol counters:

```
#show l2protocol interface counters
Interface xe1
Tunnel          : stp          : 45
```



# CHAPTER 14 Provider Bridging Configuration

This chapter contains sample provider bridging configurations.

A provider bridged network is a virtual bridged Local Area Network that comprises provider bridges (SVLAN bridges and provider edge bridges) and attached LANs, under the administrative control of a single service provider. Provider bridges interconnect the separate MACs of the IEEE 802 LANs that compose a provider bridged network, relaying frames to provide connectivity between all the LANs that provide customer interfaces for each service instance.

## Single Provider Bridge Configuration

### Topology



Figure 14-24: Single provider bridge configuration

### Configuration

#### SW1 (PEB)

SW1#configure terminal	Enter configuration mode
SW1(config)#bridge 1 protocol provider-rstp edge	Create bridge
SW1(config)#vlan database	Enter VLAN configuration mode
SW1(config-vlan)#vlan 2 type customer bridge 1 state enable	Create customer vlan VLAN 2
SW1(config-vlan)#vlan 200 type service point-point bridge 1 state enable	Create service vlan VLAN200
SW1(config-vlan)#exit	Exit VLAN configuration mode
SW1(config)#cvlan registration table map1 bridge 1	Create cvlan registration table map1
SW1(config-cvlan-registration)#cvlan 2 svlan 200	Map cvlan2 with svlan 200
SW1(config-cvlan-registration)#exit	Exit registration table
SW1(config)#interface eth1	Enter interface configuration mode for eth1
SW1(config-if)#switchport	Configure switchport
SW1(config-if)#bridge-group 1	Associate interface with bridge-group 1
SW1(config-if)#switchport mode customer-edge access	Configure switchport mode customer edge
SW1(config-if)#switchport customer-edge access vlan 2	Associate customer vlan2 with interface

## Provider Bridging Configuration

SW1(config-if)#switchport customer-edge vlan registration map1	Attach registration table map1 with interface
SW1(config-if)#exit	Exit interface mode
SW1(config-if)#interface eth2	Enter interface configuration mode for eth2
SW1(config-if)#switchport	Make interface as switchport
SW1(config-if)#bridge-group 1	Associate interface with bridge-group 1
SW1(config-if)#switchport mode provider-network	Configure switchport pnp port
SW1(config-if)#switchport provider-network allowed vlan all	Associate all svlan to the port
SW1(config-if)#exit	Exit interface configuration mode

### SW2 (PB)

SW2#configure terminal	Enter configuration mode
SW2(config)#bridge 1 protocol provider-rstp	Create provider bridge
SW2(config)#vlan database	Enter VLAN configuration mode
SW2(config-vlan)#vlan 200 type service point-point bridge 1 state enable	Create service vlan VLAN200
SW2(config-vlan)#exit	Exit VLAN configuration mode
SW2(config)#interface eth1	Enter interface configuration mode for eth1
SW2(config-if)#switchport	Make interface as switchport
SW2(config-if)#bridge-group 1	Associate interface with bridge-group 1
SW2(config-if)#switchport mode provider-network	Configure switchport pnp port
SW2(config-if)#switchport provider-network allowed vlan all	Associate all svlan to the port
SW2(config-if)#exit	Exit interface configuration mode
SW2(config-if)#interface eth2	Enter interface configuration mode for eth2
SW2(config-if)#switchport	Make interface as switchport
SW2(config-if)#bridge-group 1	Associate interface with bridge-group 1
SW2(config-if)#switchport mode provider-network	Configure switchport pnp port
SW2(config-if)#switchport provider-network allowed vlan all	Associate all svlan to the port
SW2(config-if)#exit	Exit interface configuration mode

### SW3 (PEB)

SW3#configure terminal	Enter configuration mode
SW3(config)#bridge 1 protocol provider-rstp edge	Create bridge
SW3(config)#vlan database	Enter VLAN configuration mode
SW3(config-vlan)#vlan 2 type customer bridge 1 state enable	Create customer vlan VLAN 2

SW3(config-vlan)#vlan 200 type service point-point bridge 1 state enable	Create service vlan VLAN200
SW3(config-vlan)#exit	Exit VLAN configuration mode
SW3(config)#cvlan registration table map1 bridge 1	Create cvlan registration table map1
SW3(config-cvlan-registration)#cvlan 2 svlan 200	Map cvlan2 with svlan 200
SW3(config-cvlan-registration)#exit	Exit registration table
SW3(config)#interface eth1	Enter interface configuration mode for eth1
SW3(config-if)#switchport	Configure switchport
SW3(config-if)#bridge-group 1	Associate interface with bridge-group 1
SW3(config-if)#switchport mode customer-edge access	Configure switchport mode customer edge
SW3(config-if)#switchport customer-edge access vlan 2	Associate customer vlan2 with interface
SW3(config-if)#switchport customer-edge vlan registration map1	Attach registration table map1 with interface
SW3(config-if)#exit	Exit interface mode
SW3(config-if)#interface eth2	Enter interface configuration mode for eth2
SW3(config-if)#switchport	Make interface as switchport
SW3(config-if)#bridge-group 1	Associate interface with bridge-group 1
SW3(config-if)#switchport mode provider-network	Configure switchport pnp port
SW3(config-if)#switchport provider-network allowed vlan all	Associate all svlan to the port
SW3(config-if)#exit	Exit interface configuration mode

## Validation

```
SW3#sh br
bridge 1 is running on provider-rstp edge
Ageout time is global and if something is configured for vxlan then it will be affected here also
```

Bridge	CVLAN	SVLAN	BVLAN	Port	MAC Address	FWD	Time-out
1		200		eth1	0000.0000.0f00	1	300
1		200		eth2	0001.0000.0800	1	300

```
SW1#sh br
bridge 1 is running on provider-rstp edge
Ageout time is global and if something is configured for vxlan then it will be affected here also
```

Bridge	CVLAN	SVLAN	BVLAN	Port	MAC Address	FWD	Time-out
1		200		eth2	0000.0000.0f00	1	300
1		200		eth1	0001.0000.0800	1	300

```
SW1#sh cvlan registration table
```

## Provider Bridging Configuration

---

Bridge	Table Name	Port List
=====	=====	=====
1	map1	eth1
CVLAN ID	SVLAN ID	
=====	=====	
2	200	

---

## Two Provider Bridge Configuration

---

### Topology

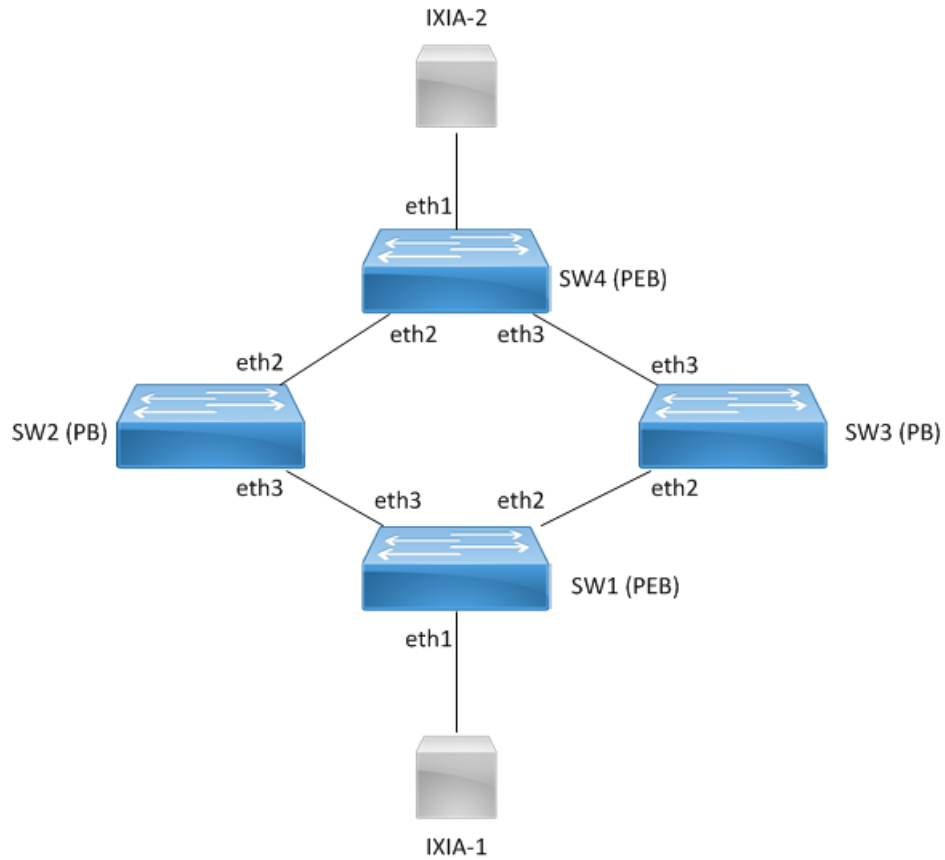

Figure 14-25: Two provider bridge configuration

## Configuration

### SW1 (PEB)

SW1#configure terminal	Enter configuration mode
SW1(config)#bridge 1 protocol provider-rstp edge	Create bridge
SW1(config)#vlan database	Enter VLAN configuration mode
SW1(config-vlan)#vlan 2 type customer bridge 1 state enable	Create customer vlan VLAN 2
SW1(config-vlan)#vlan 200 type service point-point bridge 1 state enable	Create service vlan VLAN200
SW1(config-vlan)#exit	Exit VLAN configuration mode
SW1(config)#cvlan registration table map1 bridge 1	Create cvlan registration table map1
SW1(config-cvlan-registration)#cvlan 2 svlan 200	Map cvlan2 with svlan 200
SW1(config-cvlan-registration)#exit	Exit registration table
SW1(config)#interface eth1	Enter interface configuration mode for eth1
SW1(config-if)#switchport	Configure switchport
SW1(config-if)#bridge-group 1	Associate interface with bridge-group 1
SW1(config-if)#switchport mode customer-edge access	Configure switchport mode customer edge
SW1(config-if)#switchport customer-edge access vlan 2	Associate customer vlan2 with interface
SW1(config-if)#switchport customer-edge vlan registration map1	Attach registration table map1 with interface
SW1(config-if)#exit	Exit interface mode
SW1(config-if)#interface eth2	Enter interface configuration mode for eth2
SW1(config-if)#switchport	Make interface as switchport
SW1(config-if)#bridge-group 1	Associate interface with bridge-group 1
SW1(config-if)#switchport mode provider-network	Configure switchport pnp port
SW1(config-if)#switchport provider-network allowed vlan all	Associate all svlan to the port
SW1(config-if)#interface eth3	Enter interface configuration mode for eth2
SW1(config-if)#switchport	Make interface as switchport
SW1(config-if)#bridge-group 1	Associate interface with bridge-group 1
SW1(config-if)#switchport mode provider-network	Configure switchport pnp port
SW1(config-if)#switchport provider-network allowed vlan all	Associate all svlan to the port
SW1(config-if)#exit	Exit interface configuration mode

## SW2 (PB)

SW2#configure terminal	Enter configuration mode
SW2(config)#bridge 1 protocol provider-rstp	Create provider bridge
SW2(config)#vlan database	Enter VLAN configuration mode
SW2(config-vlan)#vlan 200 type service point-point bridge 1 state enable	Create service vlan VLAN200
SW2(config-vlan)#exit	Exit VLAN configuration mode
SW2(config)#interface eth3	Enter interface configuration mode for eth1
SW2(config-if)#switchport	Make interface as switchport
SW2(config-if)#bridge-group 1	Associate interface with bridge-group 1
SW2(config-if)#switchport mode provider-network	Configure switchport pnp port
SW2(config-if)#switchport provider-network allowed vlan all	Associate all svlan to the port
SW2(config-if)#exit	Exit interface configuration mode
SW2(config-if)#interface eth2	Enter interface configuration mode for eth2
SW2(config-if)#switchport	Make interface as switchport
SW2(config-if)#bridge-group 1	Associate interface with bridge-group 1
SW2(config-if)#switchport mode provider-network	Configure switchport pnp port
SW2(config-if)#switchport provider-network allowed vlan all	Associate all svlan to the port
SW2(config-if)#exit	Exit interface configuration mode

## SW3 (PB)

SW3#configure terminal	Enter configuration mode
SW3(config)#bridge 1 protocol provider-rstp	Create provider bridge
SW3(config)#vlan database	Enter VLAN configuration mode
SW3(config-vlan)#vlan 200 type service point-point bridge 1 state enable	Create service vlan VLAN200
SW3(config-vlan)#exit	Exit VLAN configuration mode
SW3(config)#interface eth3	Enter interface configuration mode for eth1
SW3(config-if)#switchport	Make interface as switchport
SW3(config-if)#bridge-group 1	Associate interface with bridge-group 1
SW3(config-if)#switchport mode provider-network	Configure switchport pnp port
SW3(config-if)#switchport provider-network allowed vlan all	Associate all svlan to the port
SW3(config-if)#exit	Exit interface configuration mode
SW3(config-if)#interface eth2	Enter interface configuration mode for eth2
SW3(config-if)#switchport	Make interface as switchport
SW3(config-if)#bridge-group 1	Associate interface with bridge-group 1



SW3(config-if)#switchport mode provider-network	Configure switchport pnp port
SW3(config-if)#switchport provider-network allowed vlan all	Associate all svlan to the port
SW3(config-if)#exit	Exit interface configuration mode

**SW4 (PEB)**

SW4#configure terminal	Enter configuration mode
SW4(config)#bridge 1 protocol provider-rstp edge	Create bridge
SW4(config)#vlan database	Enter VLAN configuration mode
SW4(config-vlan)#vlan 2 type customer bridge 1 state enable	Create customer vlan VLAN 2
SW4(config-vlan)#vlan 200 type service point-point bridge 1 state enable	Create service vlan VLAN200
SW4(config-vlan)#exit	Exit VLAN configuration mode
SW4(config)#cvlan registration table map1 bridge 1	Create cvlan registration table map1
SW4(config-cvlan-registration)#cvlan 2 svlan 200	Map cvlan2 with svlan 200
SW4(config-cvlan-registration)#exit	Exit registration table
SW4(config)#interface eth1	Enter interface configuration mode for eth1
SW4(config-if)#switchport	Configure switchport
SW4(config-if)#bridge-group 1	Associate interface with bridge-group 1
SW4(config-if)#switchport mode customer-edge access	Configure switchport mode customer edge
SW4(config-if)#switchport customer-edge access vlan 2	Associate customer vlan2 with interface
SW4(config-if)#switchport customer-edge vlan registration map1	Attach registration table map1 with interface
SW4(config-if)#exit	Exit interface mode
SW4(config-if)#interface eth2	Enter interface configuration mode for eth2
SW4(config-if)#switchport	Make interface as switchport
SW4(config-if)#bridge-group 1	Associate interface with bridge-group 1
SW4(config-if)#switchport mode provider-network	Configure switchport pnp port
SW4(config-if)#switchport provider-network allowed vlan all	Associate all svlan to the port
SW4(config-if)#interface eth3	Enter interface configuration mode for eth2
SW4(config-if)#switchport	Make interface as switchport
SW4(config-if)#bridge-group 1	Associate interface with bridge-group 1
SW4(config-if)#switchport mode provider-network	Configure switchport pnp port

## Provider Bridging Configuration

---

SW4(config-if)#switchport provider-network allowed vlan all	Associate all svlan to the port
SW4(config-if)#exit	Exit interface configuration mode

---

## Validation

```
SW4#sh br
bridge 1 is running on provider-rstp edge
Ageout time is global and if something is configured for vxlan then it will be affected here also
```

Bridge	CVLAN	SVLAN	BVLAN	Port	MAC Address	FWD	Time-out
1		200		eth1	0000.0000.0a00	1	300
1	1	200		eth2	0001.0000.0b00	1	300

```
SW1#sh br
bridge 1 is running on provider-rstp edge
Ageout time is global and if something is configured for vxlan then it will be affected here also
```

Bridge	CVLAN	SVLAN	BVLAN	Port	MAC Address	FWD	Time-out
1		200		eth1	0000.0000.0b00	1	300
1	1	200		eth3	0001.0000.0a00	1	300

```
SW1#sh cvlan registration table
```

Bridge	Table Name	Port List
1	map1	eth1

CVLAN ID	SVLAN ID
2	200

## Layer 2 Protocol Tunneling (L2PT/L2CP Tunneling)

L2CP tunneling provides support for tunneling Control plane frames between CE nodes.

When control frames received at CEP port of PE bridge, predefined multicast address (01-00-C2-CD-CD-D0) is used for tunneling the packets across service provider network. If control packets are customer vlan tagged or untagged, then PE bridge will append corresponding service vlan tag to the control packet as per registration table / vlan translation table mapped to the port and send it across the service provider as a data packet.

When tunneled control packet with multicast address (01-00-C2-CD-CD-D0) received on PNP port, the multicast address is replaced with corresponding control packet multicast address and cvlan/svlan removal or updating is done as per registration table / vlan translation table.

## Topology

Figure 14-26 displays a sample Provider Bridged topology with customer equipment.

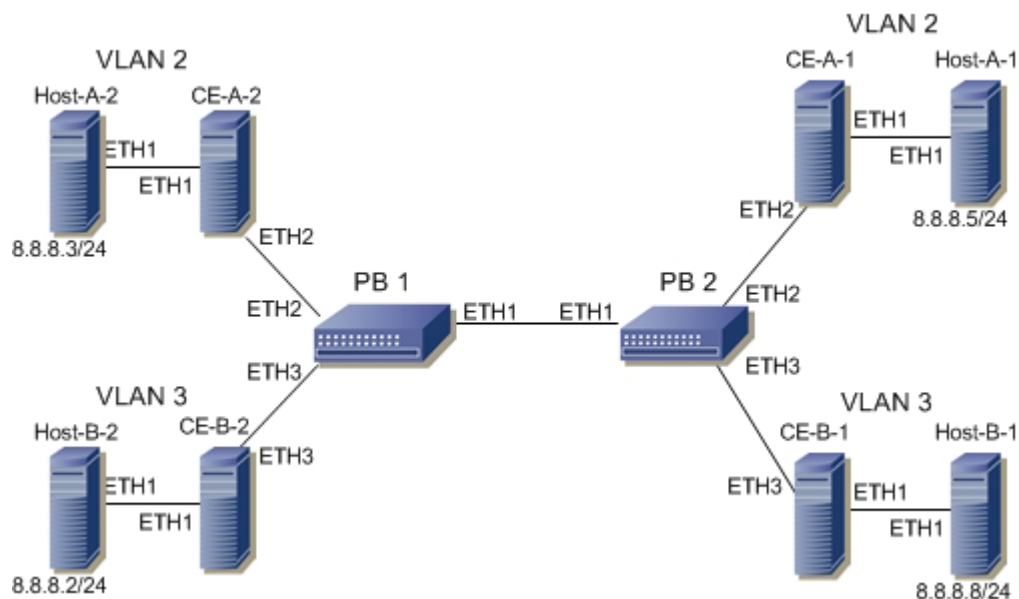

Figure 14-26: Provider Bridging with Customer Equipment Topology

## Configuring the L2PT Protocol on the Interface

The following L2PT protocols are supported:

- EFM: Ethernet first mile (Link OAM)
- ELMI: Ethernet Local Management Interface
- LACP: Link Aggregation Control Protocol
- LLDP: Link Layer Discovery Protocol
- STP: Spanning Tree Protocols

## PB1

PB1#configure terminal	Enter Configure mode.
PB1(config)#interface eth2	Enter Interface mode
PB1(config-if)#l2protocol stp peer	Configure STP protocol as peer
PB1(config-if)#l2protocol elmi tunnel	Configure Elmi protocol as tunnel
PB1(config-if)#l2protocol lldp tunnel	Configure LLDP protocol as tunnel
PB1(config-if)#l2protocol lacp discard	Configure LACP protocol as discard
PB1(config-if)#l2protocol efm discard	Configure EFM protocol as discard
PB1(config-if)#exit	Exit of the interface

## Validation

```
PB1#show l2protocol processing interface eth2
```

Bridge	Interface Name	Protocol	Processing Status
=====	=====	=====	=====
1	eth2	stp	Peer
1	eth2	gmrp	Peer
1	eth2	gvrp	Peer
1	eth2	mrrp	Peer
1	eth2	mvrp	Peer
1	eth2	lacp	Discard
1	eth2	lldp	Tunnel
1	eth2	efm	Discard
1	eth2	elmi	Tunnel
1	eth2	ptp	Peer

## Provider Bridging with VLAN Translation

This is a sample configurations to verify functionality to support provider-bridging feature with extended SVLAN translation as below:

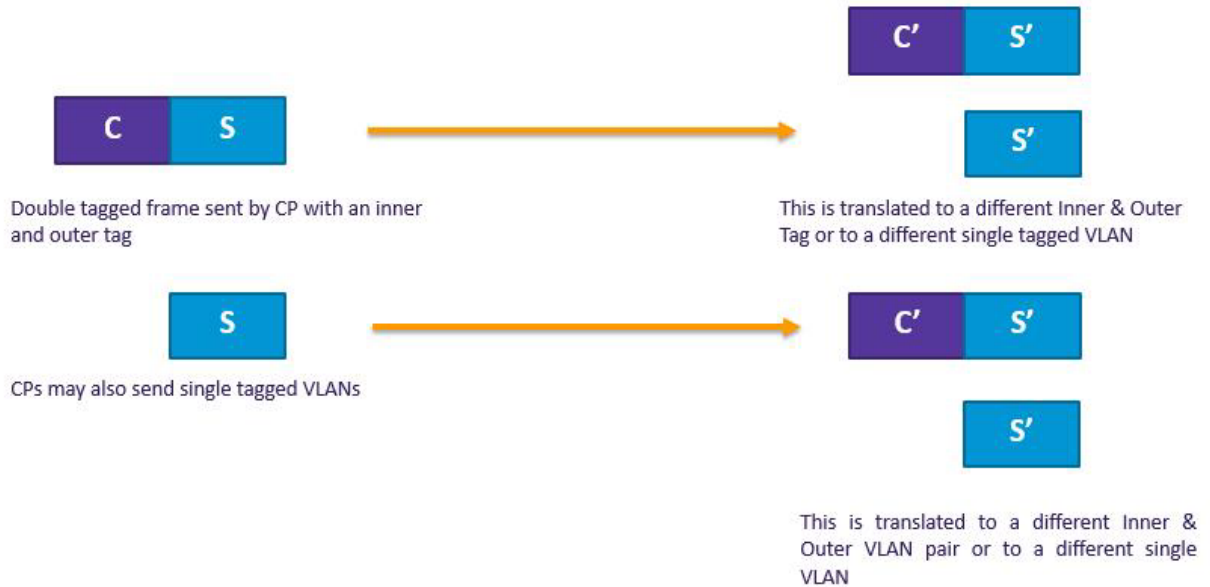

## Topology

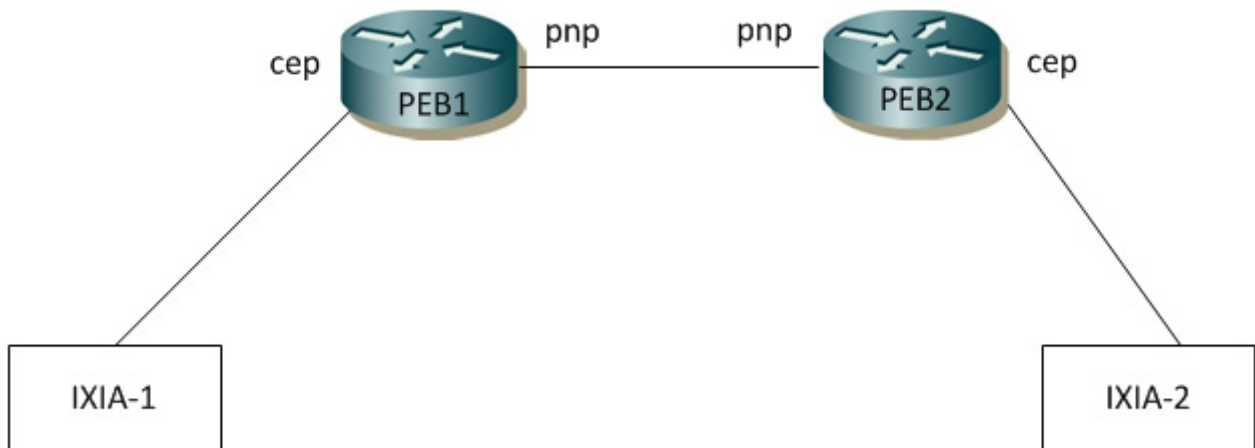

Figure 14-27: Provider Bridging with VLAN Translation Topology

## PEB1

### Bridge Configuration

#configure terminal	Enter configure mode.
(config)#bridge 1 protocol provider-rstp edge	Enter Configure bridge type as provider-RSTP edge bridge
(config)#exit	Exit configure mode.

### VLAN Configuration

#configure terminal	Enter configure mode.
(config)#vlan database	Enter VLAN database
(config-vlan)# vlan 2-500 type customer bridge 1 state enable	Configure customer VLANs on bridge 1
(config-vlan)#vlan 501-1005 type service point-point bridge 1 state enable	Configure service VLANs on bridge 1
(config-vlan)#end	Exit VLAN database and configure mode.

### CVLAN Registration Table Configuration

#configure terminal	Enter configure mode.
(config)#cvlan registration table map1 bridge 1	Configure CVLAN registration table as map1
(config-cvlan-registration)#cvlan 2 svlan 6	Map CVLAN to SVLAN
(config-cvlan-registration)#cvlan 3 svlan 7	Map CVLAN to SVLAN
(config-cvlan-registration)#end	End the CVLAN registration mode

### CEP Port Configuration

#configure terminal	Enter configure mode.
(config)#interface ge3	Enter the interface mode
(config-if)#switchport	Configure switchport
(config-if)#bridge-group 1	Attach port to bridge
(config-if)#switchport mode customer-edge hybrid	Configure port as customer-edge hybrid port
(config-if)#switchport customer-edge hybrid allowed vlan all	Add all VLANs configured above to this CEP port
(config-if)#switchport customer-edge vlan registration map1	Attach the Map1 to CEP port
(config-if)#end	Exit interface and configure mode.

### PNP Port Configuration

#configure terminal	Enter configure mode.
(config)#interface ge9	Enter the interface mode

(config-if)#switchport	Configure switchport
(config-if)#bridge-group 1	Attach port to bridge
(config-if)#switchport mode provider-network	Configure port as Provider Network Port (PNP)
(config-if)#switchport provider-network allowed vlan all	Add all VLANs configured above to this PNP port
(config-if)#end	Exit interface and configure mode.

## PEB2

### Bridge Configuration

#configure terminal	Enter configure mode.
(config)# bridge 1 protocol provider-rstp edge	Enter configure bridge type as provider-RSTP edge bridge
(config)#exit	Exit configure mode.

### VLAN Configuration

#configure terminal	Enter configure mode.
(config)#vlan database	Enter VLAN database
(config-vlan)#vlan 2-500 type customer bridge 1 state enable	Configure customer VLANs on bridge 1
(config-vlan)#vlan 501-1005 type service point-point bridge 1 state enable	Configure service VLANs on bridge 1
(config-vlan)#end	Exit VLAN database and configure mode.

### CVLAN Registration Table Configuration

#configure terminal	Enter configure mode.
(config)#cvlan registration table map1 bridge 1	Configure CVLAN registration table as map1
(config-cvlan-registration)#cvlan 2 svlan 6	Map CVLAN to SVLAN
(config-cvlan-registration)#cvlan 3 svlan 7	Map CVLAN to SVLAN
(config-cvlan-registration)#end	End the CVLAN registration mode

### CEP Port Configuration

#configure terminal	Enter configure mode.
(config)#interface ge3	Enter the interface mode
(config-if)#switchport	Configure switchport
(config-if)#bridge-group 1	Attach port to bridge
(config-if)#switchport mode customer-edge hybrid	Configure port as customer-edge hybrid port
(config-if)#switchport customer-edge hybrid allowed vlan all	Add all VLANs configured above to this CEP port

(config-if)#switchport customer-edge vlan registration map1	Attach the Map1 to CEP port
(config-if)#end	Exit interface and configure mode.

### PNP Port Configuration

#configure terminal	Enter configure mode.
(config)#interface ge9	Enter the interface mode
(config-if)#switchport	Configure switchport
(config-if)#bridge-group 1	Attach port to bridge
(config-if)#switchport mode provider-network	Configure port as Provider Network Port (PNP)
(config-if)#switchport provider-network allowed vlan all	Add all VLANs configured above to this PNP port
(config-if)#end	Exit interface and configure mode.

## Translation Cases

### Case1 - (C S - C' S')

#### Configuration on PEB2

#configure terminal	Enter configure mode.
(config)#interface ge9	Enter the interface mode
(config-if)#switchport provider-network vlan translation cvlan 2 svlan 6 cvlan 3 svlan 7	Translate CVLAN and SVLAN to new CVLAN and new SVLAN on PNP port

## Validation for Case 1

When tagged traffic with CVLAN 2 is sent from IXIA-1 to IXIA-2 with both CTAG and STAG entering provider network and gets translated to new CVLAN and SVLAN as per Case1.

```
PEB2#show bridge
```

Bridge	CVLAN	SVLAN	BVLAN	Port	MAC Address	FWD	Time-out
1		1		ge27	1402.ec1c.3144	1	300
1		6		ge9	6400.6a1e.d9a5	1	300
1		7		ge9	0000.0500.0400	1	300
1		7		ge9	6400.6a1e.d9a5	1	300

New SVLAN 7 is observed on PEB2 after translation. Also, captured packets on CEP show new CVLAN 3.

When tagged traffic for CVLAN 3 is sent from IXIA-2 to IXIA-1

```
PEB1#show bridge
```

Bridge	CVLAN	SVLAN	BVLAN	Port	MAC Address	FWD	Time-out
1		1		ge9	74e6.e2af.598b	1	300
1		6		ge3	0000.0500.0400	1	300
1		6		ge9	0000.0500.0700	1	300

When traffic is reversed and traffic has both new CVLAN 3 and SVLAN 7 on provider network from IXIA-2, translation to old CVLAN 2 and SVLAN 6 happens. Also, captured packets have CVLAN as 2.



## Case2 - (C S - S')

### Configuration on PEB2

#### CVLAN Registration Table Configuration

#configure terminal	Enter configure mode.
(config)#cvlan registration table map1 bridge 1	Configure CVLAN registration table as map1
(config-cvlan-registration)#cvlan 2 svlan 6	Map CVLAN to SVLAN
(config-cvlan-registration)#cvlan 3 svlan 7 untagged-pep	Map CVLAN to SVLAN
(config-cvlan-registration)#end	End the CVLAN registration mode

#### CEP Port Configuration

#configure terminal	Enter configure mode.
(config)#interface ge3	Enter the interface mode
(config-if)#switchport customer-edge hybrid vlan 3	Allow access VLAN 3 configured above to this CEP port
(config-if)#switchport customer-edge hybrid allowed vlan add 2-3	Allow other VLANs configured to this CEP port
(config-if)#switchport customer-edge vlan registration map1	Attach the Map1 to CEP port
(config-if)#end	Exit interface and configure mode.

#### PNP Port Configuration

#configure terminal	Enter configure mode.
(config)#interface ge9	Enter the interface mode
(config-if)#no switchport provider-network vlan translation cvlan 2 svlan 6	Unconfigure Translation Case1 from PNP port
(config-if)#switchport provider-network vlan translation cvlan 2 svlan 6 svlan 7	Configure Translation Case2 on PNP port
(config-if)#end	Exit interface and configure mode.

## Validation for Case 2

When tagged traffic with CVLAN 2 is sent from IXIA-1 to IXIA-2 with both CTAG and STAG entering provider network and translated to new SVLAN as per Case2.

```
PEB2#show bridge
```

Bridge	CVLAN	SVLAN	BVLAN	Port	MAC Address	FWD	Time-out
1		1		ge27	1402.ec1c.3144	1	300
1		7		ge9	0000.0500.0400	1	300

New SVLAN 7 is observed on PEB2 after translation. At CEP port connected to IXIA-2, untagged traffic should be received.

When tagged traffic for CVLAN 3 is sent from IXIA-2 to IXIA-1.

```
PEB1#show bridge
```

Bridge	CVLAN	SVLAN	BVLAN	Port	MAC Address	FWD	Time-out
1		1		ge9	74e6.e2af.598b	1	300
1		6		ge3	0000.0500.0400	1	300
1		6		ge9	0000.0500.0700	1	300

When traffic is reversed and traffic has both new CVLAN 3 and SVLAN 7 from IXIA-2, translation to old CVLAN 2 and SVLAN 6 happens. Also, captured packets have CVLAN as 2.

### Case3 - (S - S')

#### Configuration on PEB1

##### CVLAN Registration Table Configuration

#configure terminal	Enter configure mode.
(config)#cvlan registration table map1 bridge 1	Configure CVLAN registration table as map1
(config-cvlan-registration)#cvlan 2 svlan 6	Map CVLAN to SVLAN
(config-cvlan-registration)#cvlan 3 svlan 7	Map CVLAN to SVLAN
(config-cvlan-registration)#end	End the CVLAN registration mode

##### CEP Port Configuration

#configure terminal	Enter configure mode.
(config)#interface ge3	Enter the interface mode
(config-if)#switchport customer-edge hybrid vlan 2	Allow access VLAN 2 configured above to this CEP port
(config-if)#switchport customer-edge hybrid allowed vlan add 2-3	Allow other VLANs configured to this CEP port
(config-if)#switchport customer-edge vlan registration map1	Attach the Map1 to CEP port
(config-if)#end	Exit interface and configure mode.

#### Configuration on PEB2

##### CEP Port Configuration (should be configured as PNP in this case)

#configure terminal	Enter configure mode.
(config)#interface ge3	Enter the interface mode
(config-if)#switchport	Configure switchport
(config-if)#switchport mode provider-network	Configure port as Provider Network Port (PNP)
(config-if)#switchport provider-network allowed vlan all	Add all VLANs configured above to this PNP port
(config-if)#end	Exit interface and configure mode.

## PNP Port Configuration

#configure terminal	Enter configure mode.
(config)#interface ge9	Enter the interface mode
(config-if)#no switchport provider-network vlan translation cvlan 2 svlan 6	Unconfigure Translation Case2 from PNP port
(config-if)#switchport provider-network vlan translation svlan 6 svlan 7	Configure Translation Case3 on PNP port
(config-if)#end	Exit interface and configure mode.

## Validation for Case 3

When tagged traffic with CVLAN 2 is sent from IXIA-1 to IXIA-2 with only STAG entering provider network and translation happens to new SVLAN as per Case3.

```
PEB2#show bridge
```

Bridge	CVLAN	SVLAN	BVLAN	Port	MAC Address	FWD	Time-out
1		1		ge27	1402.ec1c.3144	1	300
1		6		ge9	0000.0500.0400	1	300
1		6		ge9	6400.6a1e.d9a5	1	300

New SVLAN 7 is observed on PEB2 At PNP port connected to IXIA-2.

When double tagged traffic of CVLAN 2 and SVLAN 7 is sent from IXIA-2 to IXIA-1:

```
PEB1#show bridge
```

Bridge	CVLAN	SVLAN	BVLAN	Port	MAC Address	FWD	Time-out
1		1		ge9	74e6.e2af.598b	1	300
1		7		ge3	0000.0500.0400	1	300
1		6		ge9	0000.0500.0700	1	300

Here we get a tagged traffic of CVALN 2 when the captured at IXIA-1.

## Case4 - (S - C' S')

### Configuration on PEB1

#### CVLAN Registration Table Configuration

#configure terminal	Enter configure mode.
(config)#cvlan registration table map1 bridge 1	Configure CVLAN registration table as map1
(config-cvlan-registration)#cvlan 2 svlan 6 untagged-pep	Map CVLAN to SVLAN
(config-cvlan-registration)#cvlan 3 svlan 7	Map CVLAN to SVLAN
(config-cvlan-registration)#end	End the CVLAN registration mode

## CEP Port Configuration

#configure terminal	Enter configure mode.
(config)#interface ge3	Enter the interface mode

## Provider Bridging Configuration

(config-if)#switchport customer-edge hybrid vlan 2	Allow access VLAN 2 configured above to this CEP port
(config-if)#switchport customer-edge hybrid allowed vlan add 2-3	Allow other VLANs configured to this CEP port
(config-if)#switchport customer-edge vlan registration map1	Attach the Map1 to CEP port
(config-if)#end	Exit interface and configure mode.

## Configuration on PEB2

### CEP Port Configuration (should be configured as PNP in this case)

#configure terminal	Enter configure mode.
(config)#interface ge3	Enter the interface mode
(config-if)#switchport	Configure switchport
(config-if)#bridge-group 1	Attach port to bridge
(config-if)#switchport mode provider-network	Configure port as Provider Network Port (PNP)
(config-if)#switchport provider-network allowed vlan all	Add all VLANs configured above to this PNP port
(config-if)#end	Exit interface and configure mode.

### PNP Port Configuration

#configure terminal	Enter configure mode.
(config)#interface ge9	Enter the interface mode
(config-if)#no switchport provider-network vlan translation svlan 6 svlan 7	Unconfigure Translation Case2 from PNP port
(config-if)#switchport provider-network vlan translation svlan 6 cvlan 3 svlan 7	Configure Translation Case3 on PNP port
(config-if)#end	Exit interface and configure mode.

## Validation for Case 4

When tagged traffic with CVLAN 2 is sent from IXIA-1 to IXIA-2 enters provider network and translation happens to new CVLAN and new SVLAN as per Case4.

```
PEB2#show bridge
Bridge    CVLAN   SVLAN   BVLAN   Port          MAC Address      FWD   Time-out
-----+-----+-----+-----+-----+-----+-----+-----+
1         1       1       ge27    1402.ec1c.3144 1       300
1         6       6       ge9     0000.0500.0400 1       300
1         6       6       ge9     6400.6a1e.d9a5 1       300
```

When you observe the traffic received in IXIA-2, you can observe that new CVLAN 3 and SVLAN 7 tags can be seen. Here the VLAN 2 will be a data packet.

When tagged traffic for CVLAN 3 and SVLAN 7 is sent from IXIA-2 to IXIA-1:

```
PEB1#show bridge
Bridge    CVLAN   SVLAN   BVLAN   Port          MAC Address      FWD   Time-out
-----+-----+-----+-----+-----+-----+-----+-----+
1         3       7       ge9     6400.6a1e.d9a5 1       300
```

1	6	ge3	0000.0500.0400	1	300
1	7	ge9	0000.0500.0700	1	300

When you observe, in PEB1 the packets will be dropped at the CEP port since only a single S tagged packets is obtained in the PNP.

### Case5 - (C - C' S')

#### Configuration on PEB1

##### CVLAN Registration Table Configuration

#configure terminal	Enter configure mode.
(config)#cvlan registration table map1 bridge 1	Configure CVLAN registration table as map1
(config-cvlan-registration)#cvlan 2 cvlan3 svlan 4	Map CVLAN to C'VLAN and SVLAN
(config-cvlan-registration)#cvlan 5 cvlan 6 svlan 7	Map CVLAN to C'VLAN and SVLAN
(config-cvlan-registration)#end	End the CVLAN registration mode

##### CEP Port Configuration

#configure terminal	Enter configure mode.
(config)#interface ge3	Enter the interface mode
(config-if)#switchport	Configure switchport
(config-if)#bridge-group 1	Attach port to bridge
(config-if)#switchport mode customer-edge hybrid	Configure port as customer-edge hybrid port
(config-if)#switchport customer-edge hybrid allowed vlan all	Allow other VLANs configured to this CEP port
(config-if)#switchport customer-edge vlan registration map1	Attach the Map1 to CEP port
(config-if)#end	Exit interface and configure mode.

#### Configuration on PEB2

##### CEP Port Configuration (should be configured as PNP in this case)

#configure terminal	Enter configure mode.
(config)#interface ge3	Enter the interface mode
(config-if)#switchport	Configure switchport
(config-if)#bridge-group 1	Attach port to bridge
(config-if)#switchport mode provider-network	Configure port as Provider Network Port (PNP)
(config-if)#switchport provider-network allowed vlan all	Add all VLANs configured above to this PNP port
(config-if)#end	Exit interface and configure mode.

## PNP Port Configuration

#configure terminal	Enter configure mode.
(config)#interface ge9	Enter the interface mode
(config-if)#switchport	Configure switchport
(config-if)#bridge-group 1	Attach port to bridge
(config-if)#switchport mode provider-network	Configure port as Provider Network Port (PNP)
(config-if)#switchport provider-network allowed vlan all	Add all VLANs configured above to this PNP port
(config-if)#end	Exit interface and configure mode.

## Validation for Case 5

When tagged traffic with CVLAN 2 is sent from IXIA-1 to IXIA-2 with both CTAG and STAG entering provider network and gets translated to new CVLAN and SVLAN as per Case1.

```
PEB2#show bridge
```

Bridge	CVLAN	SVLAN	BVLAN	Port	MAC Address	FWD	Time-out
1		1		ge27	1402.ec1c.3144	1	300
1		6		ge9	0000.0500.0400	1	300
1		6		ge9	6400.6a1e.d9a5	1	300

When the packet is captured at PNP port of PEB2 CVLAN of 3 and SVLAN of 4 is seen.

When tagged traffic for CVLAN 6 and SVLAN 7 is sent from IXIA-2 to IXIA-1:

```
PEB1#show bridge
```

Bridge	CVLAN	SVLAN	BVLAN	Port	MAC Address	FWD	Time-out
1		1		ge9	74e6.e2af.598b	1	300
1		4		ge3	0000.0500.0400	1	300
1		7		ge9	0000.0500.0700	1	300

When traffic is reversed and traffic has both new CVLAN 6 and SVLAN 7 on provider network from IXIA-2, translation to CVLAN 5 and SVLAN 7 happens. Also, captured packets have CVLAN as 2 based on the entry in the cvlan registration table.

## Switchport ethertype

### Bridge Configuration (for 0x88a8)

#### Configuration on PEB1

#### CVLAN Registration Table Configuration

#configure terminal	Enter configure mode.
(config)#cvlan registration table map1 bridge 1	Configure CVLAN registration table as map1
(config-cvlan-registration)#cvlan 2 svlan 4	Map CVLAN to SVLAN

---

<code>(config-cvlan-registration)#cvlan 3 svlan 6</code>	Map CVLAN to SVLAN
<code>(config-cvlan-registration)#end</code>	End the CVLAN registration mode

---

## Configuration on PEB2

### CEP Port Configuration (should be configured as PNP in this case)

#### CEP Port Configuration

<code>#configure terminal</code>	Enter configure mode.
<code>(config)#interface ge3</code>	Enter the interface mode
<code>(config-if)#switchport</code>	Configure switchport
<code>(config-if)#bridge-group 1</code>	Attach port to bridge
<code>(config-if)#switchport mode provider-network</code>	Configure port as Provider Network Port (PNP)
<code>(config-if)#switchport provider-network allowed vlan all</code>	Add all VLANs configured above to this PNP port
<code>(config-if)#end</code>	Exit interface and configure mode.

#### PNP Port Configuration

<code>#configure terminal</code>	Enter configure mode.
<code>(config)#interface ge9</code>	Enter the interface mode
<code>(config-if)#switchport</code>	Configure switchport
<code>(config-if)#bridge-group 1</code>	Attach port to bridge
<code>(config-if)#switchport mode provider-network</code>	Configure port as Provider Network Port (PNP)
<code>(config-if)#switchport provider-network vlan allowed vlan all</code>	Add all VLANs configured above to this PNP port
<code>(config-if)#switchport dot1q ethertype 0x88a8</code>	Change the TPID of the SVLAN to 0x88a8
<code>(config-if)#end</code>	Exit interface and configure mode.

---

## Validation for Switchport ethertype

To validate, send tagged traffic of VLAN 2 from IXIA-1.

Now at eth9 of PB2, capture the packets through IXIA-2 and verify that the traffic is received with double tag.

If the 2 tags CVLAN tag 2 will have the TPID of 0x8100 and SVLAN tag 4 will have a TPID of 0x88a8.

---

## Provider Bridging QoS Configuration

This chapter contains sample provider bridging configurations for QoS.

## Scenario: 1 Traffic flow from CEP to PNP

### Topology



Figure 14-28: Provider Bridging with QoS Topology

### Bridge Configuration

#configure terminal	Enter configure mode.
(config)# bridge 1 protocol provider-rstp edge	Enter configure bridge type as provider-RSTP edge bridge
(config)#exit	Exit configure mode.

### VLAN Configuration

#configure terminal	Enter configure mode.
(config)#vlan database	Enter VLAN database
(config-vlan)#vlan 2-500 type customer bridge 1 state enable	Configure customer VLANs on bridge 1
(config-vlan)#vlan 501-1005 type service point-point bridge 1 state enable	Configure service VLANs on bridge 1
(config-vlan)#end	Exit VLAN database and configure mode.

### CVLAN Registration Table Configuration

#configure terminal	Enter configure mode.
(config)#cvlan registration table map1 bridge 1	Configure CVLAN registration table as map1
(config-cvlan-registration)#cvlan 2 svlan 501	Map CVLAN to SVLAN
(config-cvlan-registration)#end	End the CVLAN registration mode

### CEP Port Configuration

#configure terminal	Enter configure mode.
(config)#interface xe2	Enter the interface mode



(config-if)#switchport	Configure switchport
(config-if)#bridge-group 1	Attach port to bridge
(config-if)#switchport mode customer-edge hybrid	Configure port as customer-edge hybrid port
(config-if)#switchport customer-edge hybrid allowed vlan all	Add all VLANs configured above to this CEP port
(config-if)#switchport customer-edge vlan registration map1	Attach the Map1 to CEP port
(config-if)#end	Exit interface and configure mode.

## PNP Port Configuration

#configure terminal	Enter configure mode.
(config)#interface xe3	Enter the interface mode
(config-if)#switchport	Configure switchport
(config-if)#bridge-group 1	Attach port to bridge
(config-if)#switchport mode provider-network	Configure port as Provider Network Port (PNP)
(config-if)#switchport provider-network allowed vlan add 501	Add all VLANs configured above to this PNP port
(config-if)#end	Exit interface and configure mode.

## QoS Configurations

#configure terminal	Enter configure mode.
(config)#hardware-profile filter qos-ext enable	Enabling Ingress extended QoS group for QoS support with statistics
(config-if)#qos enable	Enabling QoS
(config-if)#qos statistics	Enabling QoS statistics
(config-if)#qos profile cos-to-queue cosq-cust1	Configure QoS map profile
config-ingress-cos-map)#cos 0 queue 1	Configuring the cos value to be mapped to queue
(config-ingress-cos-map)#exit	Exit configure mode.
(config)#qos profile queue-color-to-cos cosq-service1	Configuring profile for queue color to cos map
(config-egress-cos-map)#queue 1 cos 3	Configuring the queue value to be cos remarked.
(config-egress-cos-map)#exit	Exit configure mode
(config)#cvlan registration table map1bridge 1	Enter CVLAN registration mode
(config-cvlan-registration)#cvlan 2 svlan 501 cos-to-queue cosq-cust1	Map CVLAN to SVLAN with QoS map profile. Eg: when vlan 2 customer traffic with cos 0 value is received, queue will be assigned to 1 based on mapping.
(config-cvlan-registration)#end	End the CVLAN registration mode
(config)#interface xe3	Enter the interface mode
(config-if)#qos map-profile queue-color-to-cos cosq-service1	Map the profile to the PNP port. Eg: when traffic goes out of queue 1, cos value on service vlan header will be modified to 3 as remarking is enabled on the interface.

(config-if)#qos remark cos enable	Enabling Cos Remark on the Network Interface.
(config-if)#end	Exit interface and configure mode.

### Validation for Scenario 1

```
#show cvlan registration table map1
Bridge          Table Name      Port List
=====
1               map1           xe2

CVLAN ID       T-CVLAN ID     SVLAN ID       Profile Name    Egress remark-
Cos
=====
2               -              501            cosq-cust1     No
```

```
#show qos-profile interface xe2
profile name: default
profile type: cos-to-queue (Ingress)
mapping:
```

INPUT				OUTPUT			
COS	DEI	Queue	Color	COS	DEI	Queue	Color
0	0	0	green	0	1	0	yellow
1	0	1	green	1	1	1	yellow
2	0	2	green	2	1	2	yellow
3	0	3	green	3	1	3	yellow
4	0	4	green	4	1	4	yellow
5	0	5	green	5	1	5	yellow
6	0	6	green	6	1	6	yellow
7	0	7	green	7	1	7	yellow

```
profile name: default
profile type: queue-color-to-cos (Egress)
Status: Inactive
mapping:
```

INPUT			OUTPUT			INPUT			OUTPUT		
Queue	Color	COS	Queue	Color	COS	Queue	Color	COS	Queue	Color	COS
0	green	0	0	yellow	0	0	red	0	0	red	0
1	green	1	1	yellow	1	1	red	1	1	red	1
2	green	2	2	yellow	2	2	red	2	2	red	2
3	green	3	3	yellow	3	3	red	3	3	red	3
4	green	4	4	yellow	4	4	red	4	4	red	4
5	green	5	5	yellow	5	5	red	5	5	red	5
6	green	6	6	yellow	6	6	red	6	6	red	6
7	green	7	7	yellow	7	7	red	7	7	red	7

```
#show qos-profile interface xe3
profile name: default
profile type: cos-to-queue (Ingress)
mapping:
```

INPUT				OUTPUT				INPUT				OUTPUT			
COS	DEI	Queue	Color	COS	DEI	Queue	Color	COS	DEI	Queue	Color	COS	DEI	Queue	Color
0	0	0	green	0	1	0	yellow	0	1	0	yellow	0	1	0	yellow
1	0	1	green	1	1	1	yellow	1	1	1	yellow	1	1	1	yellow
2	0	2	green	2	1	2	yellow	2	1	2	yellow	2	1	2	yellow
3	0	3	green	3	1	3	yellow	3	1	3	yellow	3	1	3	yellow
4	0	4	green	4	1	4	yellow	4	1	4	yellow	4	1	4	yellow
5	0	5	green	5	1	5	yellow	5	1	5	yellow	5	1	5	yellow
6	0	6	green	6	1	6	yellow	6	1	6	yellow	6	1	6	yellow
7	0	7	green	7	1	7	yellow	7	1	7	yellow	7	1	7	yellow

```
profile name: cosq-servicel
profile type: queue-color-to-cos (Egress)
Status: Active
mapping:
```

INPUT			OUTPUT			INPUT			OUTPUT			INPUT			OUTPUT		
Queue	Color	COS	Queue	Color	COS	Queue	Color	COS	Queue	Color	COS	Queue	Color	COS	Queue	Color	COS
0	green	0	0	yellow	0	0	yellow	0	0	red	0	0	red	0	0	red	0
1	green	3	1	yellow	3	1	yellow	3	1	red	3	1	red	3	1	red	3
2	green	2	2	yellow	2	2	yellow	2	2	red	2	2	red	2	2	red	2
3	green	3	3	yellow	3	3	yellow	3	3	red	3	3	red	3	3	red	3
4	green	4	4	yellow	4	4	yellow	4	4	red	4	4	red	4	4	red	4
5	green	5	5	yellow	5	5	yellow	5	5	red	5	5	red	5	5	red	5
6	green	6	6	yellow	6	6	yellow	6	6	red	6	6	red	6	6	red	6
7	green	7	7	yellow	7	7	yellow	7	7	red	7	7	red	7	7	red	7

## Scenario: 2 Traffic flow from PNP to CEP

### Topology



Figure 14-29: Provider Bridging with QoS Topology

### Bridge Configuration

#configure terminal	Enter configure mode.
(config)# bridge 1 protocol provider-rstp edge	Enter configure bridge type as provider-RSTP edge bridge
(config)#exit	Exit configure mode.

### VLAN Configuration

#configure terminal	Enter configure mode.
(config)#vlan database	Enter VLAN database
(config-vlan)#vlan 2-500 type customer bridge 1 state enable	Configure customer VLANs on bridge 1
(config-vlan)#vlan 501-1005 type service point-point bridge 1 state enable	Configure service VLANs on bridge 1
(config-vlan)#end	Exit VLAN database and configure mode.

### CVLAN Registration Table Configuration

#configure terminal	Enter configure mode.
(config)#cvlan registration table map1 bridge 1	Configure CVLAN registration table as map1
(config-cvlan-registration)#end	End the CVLAN registration mode

### CEP Port Configuration

#configure terminal	Enter configure mode.
(config)#interface xe2	Enter the interface mode

(config-if)#switchport	Configure switchport
(config-if)#bridge-group 1	Attach port to bridge
(config-if)#switchport mode customer-edge hybrid	Configure port as customer-edge hybrid port
(config-if)#switchport customer-edge hybrid allowed vlan all	Add all VLANs configured above to this CEP port
(config-if)#switchport customer-edge vlan registration map1	Attach the Map1 to CEP port
(config-if)#end	Exit interface and configure mode.

## PNP Port Configuration

#configure terminal	Enter configure mode.
(config)#interface xe3	Enter the interface mode
(config-if)#switchport	Configure switchport
(config-if)#bridge-group 1	Attach port to bridge
(config-if)#switchport mode provider-network	Configure port as Provider Network Port (PNP)
(config-if)#switchport provider-network allowed vlan add 501	Add all VLANs configured above to this PNP port
(config-if)#end	Exit interface and configure mode.

## QoS Configurations

#configure terminal	Enter configure mode.
(config)#hardware-profile filter qos-ext enable	Enabling Ingress extended QoS group for QoS support with statistics
(config-if)#qos enable	Enabling QoS
(config-if)#qos statistics	Enabling QoS statistics
(config-if)#qos profile cos-to-queue cosq-cust1	Configure QoS map profile
config-ingress-cos-map)#cos 2 queue 5	Configuring the cos value to be mapped to queue. Eg: when double tagged traffic with cos 2 for outer vlan is received, queue will be assigned to 5 based on mapping.
(config-ingress-cos-map)#exit	Exit configure mode.
(config)#cvlan registration table map1bridge 1	Enter CVLAN registration mode
(config-cvlan-registration)#cvlan 2 svlan 501 remark-cos	Map CVLAN to SVLAN with remark cos enabled. Eg: when double tagged traffic with cos 2 for outer vlan is received, queue will be assigned to 5 based on mapping and cos value will be changed to 5 when it goes out of cep port since remark cos is enabled.
(config-cvlan-registration)#cvlan 3 svlan 501 remark-cos	Map CVLAN to SVLAN without remark cos. Eg: when double tagged traffic with cos 2 for outer vlan is received, and cos value will be forwarded as it is when it goes out of cep port since remark cos is not enabled for customer2.
(config-cvlan-registration)#end	End the CVLAN registration mode
(config)#configure terminal	Enter configure mode

(config)#interface xe3	Enter the interface mode
(config-if)#qos map-profile cos-to-queue cosq-service	Map the profile to the PNP port
(config-if)#end	Exit interface and configure mode

## Validation for Scenario 2

```
#show cvlan registration table map1
```

Bridge	Table Name	Port List
1	map1	xe2

CVLAN ID	T-CVLAN ID	SVLAN ID	Profile Name	Egress remark-
Cos				
2	-	501	N/A	Yes
3	-	501	N/A	No

```
#show qos-profile interface xe2
profile name: default
profile type: cos-to-queue (Ingress)
mapping:
```

INPUT				OUTPUT			
COS	DEI	Queue	Color	COS	DEI	Queue	Color
0	0	0	green	0	1	0	yellow
1	0	1	green	1	1	1	yellow
2	0	2	green	2	1	2	yellow
3	0	3	green	3	1	3	yellow
4	0	4	green	4	1	4	yellow
5	0	5	green	5	1	5	yellow
6	0	6	green	6	1	6	yellow
7	0	7	green	7	1	7	yellow

```
profile name: default
profile type: queue-color-to-cos (Egress)
Status: Inactive
mapping:
```

INPUT			OUTPUT			INPUT			OUTPUT		
Queue	Color	COS	Queue	Color	COS	Queue	Color	COS	Queue	Color	COS
0	green	0	0	yellow	0	0	red	0	0	red	0
1	green	1	1	yellow	1	1	red	1	1	red	1
2	green	2	2	yellow	2	2	red	2	2	red	2
3	green	3	3	yellow	3	3	red	3	3	red	3
4	green	4	4	yellow	4	4	red	4	4	red	4
5	green	5	5	yellow	5	5	red	5	5	red	5

```

6      green  6      | 6      yellow 6      | 6      red    6
7      green  7      | 7      yellow 7      | 7      red    7

```

```

#show qos-profile interface xe3
profile name: cosq-service
profile type: cos-to-queue (Ingress)
mapping:

```

INPUT				OUTPUT			
COS	DEI	Queue	Color	COS	DEI	Queue	Color
0	0	0	green	0	1	0	yellow
1	0	1	green	1	1	1	yellow
2	0	5	green	2	1	5	yellow
3	0	3	green	3	1	3	yellow
4	0	4	green	4	1	4	yellow
5	0	5	green	5	1	5	yellow
6	0	6	green	6	1	6	yellow
7	0	7	green	7	1	7	yellow

```

profile name: default
profile type: queue-color-to-cos (Egress)
Status: Inactive
mapping:

```

INPUT			OUTPUT			INPUT			OUTPUT		
Queue	Color	COS	Queue	Color	COS	Queue	Color	COS	Queue	Color	COS
0	green	0	0	yellow	0	0	red	0	0	red	0
1	green	1	1	yellow	1	1	red	1	1	red	1
2	green	2	2	yellow	2	2	red	2	2	red	2
3	green	3	3	yellow	3	3	red	3	3	red	3
4	green	4	4	yellow	4	4	red	4	4	red	4
5	green	5	5	yellow	5	5	red	5	5	red	5
6	green	6	6	yellow	6	6	red	6	6	red	6
7	green	7	7	yellow	7	7	red	7	7	red	7

---

## Provider Bridging Untagged-pep Configuration

This is a sample configuration to verify functionality to support provider-bridging with untagged-pep feature.

For the below topology configuration,

1. While sending tagged traffic untagged-pep CVLAN 2, it should drop in provider edge bridge.
2. And while sending tagged traffic CVLAN 3 to the provider network, will egress with CVLAN 3 and SVLAN 12 tag and the same CVLAN and SVLAN tag from provider network, will egress with only CVLAN tag
3. And also for untagged traffic to the provider network, will egress with SVLAN 11 tag

---

### Topology

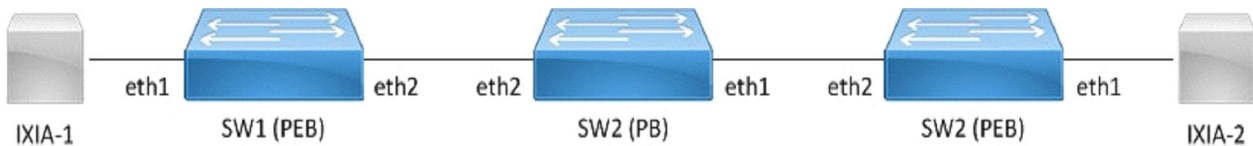

**Figure 14-30: provider bridge untagged-pep configuration**



---

## Configuration

### SW1 (PEB)

SW1#configure terminal	Enter configuration mode
SW1(config)#bridge 1 protocol provider-rstp edge	Create bridge
SW1(config)#vlan database	Enter VLAN configuration mode
SW1(config-vlan)#vlan 2-10 type customer bridge 1 state enable	Create customer vlan VLAN 2-10
SW1(config-vlan)#vlan 11-15 type service point-point bridge 1 state enable	Create service vlan VLAN 11-15
SW1(config-vlan)#exit	Exit VLAN configuration mode
SW1(config)#cvlan registration table map1 bridge 1	Create cvlan registration table map1
SW1(config-cvlan-registration)#cvlan 2 svlan 11 untagged-pep	Map cvlan2 with svlan 11
SW1(config-cvlan-registration)#cvlan 3 svlan 12	Map cvlan3 with svlan 12
SW1(config-cvlan-registration)#cvlan 4 svlan 14	Map cvlan4 with svlan 14
SW1(config-cvlan-registration)#exit	Exit registration table
SW1(config)#interface eth1	Enter interface configuration mode for eth1
SW1(config-if)#switchport	Configure switchport
SW1(config-if)#bridge-group 1	Associate interface with bridge-group 1
SW1(config-if)#switchport mode customer-edge access	Configure switchport mode customer edge
SW1(config-if)#switchport customer-edge hybrid vlan 2	Associate customer vlan2 with interface
SW1(config-if)#switchport customer-edge hybrid allowed vlan all	Associate all customer vlan with interface
SW1(config-if)#switchport customer-edge vlan registration map1	Attach registration table map1 with interface
SW1(config-if)#exit	Exit interface mode
SW1(config-if)#interface eth2	Enter interface configuration mode for eth2
SW1(config-if)#switchport	Make interface as switchport
SW1(config-if)#bridge-group 1	Associate interface with bridge-group 1
SW1(config-if)#switchport mode provider-network	Configure switchport pnp port
SW1(config-if)#switchport provider-network allowed vlan all	Associate all svlan to the port
SW1(config-if)#exit	Exit interface configuration mode
SW1(config)#commit	Apply the commit
SW1(config)#end	Exit configuration mode

## SW2 (PB)

SW2#configure terminal	Enter configuration mode
SW2(config)#bridge 1 protocol provider-rstp	Create provider bridge
SW2(config)#vlan database	Enter VLAN configuration mode
SW2(config-vlan)# vlan 2-15 type service point-point bridge 1 state enable	Create service vlan VLAN2-15
SW2(config-vlan)#exit	Exit VLAN configuration mode
SW2(config)#interface eth1	Enter interface configuration mode for eth1
SW2(config-if)#switchport	Make interface as switchport
SW2(config-if)#bridge-group 1	Associate interface with bridge-group 1
SW2(config-if)#switchport mode provider-network	Configure switchport pnp port
SW2(config-if)#switchport provider-network allowed vlan all	Associate all svlan to the port
SW2(config-if)#exit	Exit interface configuration mode
SW2(config-if)#interface eth2	Enter interface configuration mode for eth2
SW2(config-if)#switchport	Make interface as switchport
SW2(config-if)#bridge-group 1	Associate interface with bridge-group 1
SW2(config-if)#switchport mode provider-network	Configure switchport pnp port
SW2(config-if)#switchport provider-network allowed vlan all	Associate all svlan to the port
SW2(config-if)#exit	Exit interface configuration mode
SW2(config)#commit	Apply the commit
SW2(config)#end	Exit configuration mode

## SW3 (PEB)

SW3#configure terminal	Enter configuration mode
SW3(config)#bridge 1 protocol provider-rstp edge	Create bridge
SW3(config)#vlan database	Enter VLAN configuration mode
SW3(config-vlan)#vlan 2-10 type customer bridge 1 state enable	Create customer vlan VLAN 2-10
SW3(config-vlan)#vlan 11-15 type service point-point bridge 1 state enable	Create service vlan VLAN11-15
SW3(config-vlan)#exit	Exit VLAN configuration mode
SW3(config)#cvlan registration table map1 bridge 1	Create cvlan registration table map1
SW3(config-cvlan-registration)#cvlan 2 svlan 11 untagged-pep	Map cvlan2 with svlan 200
SW3(config-cvlan-registration)#cvlan 3 svlan 12	Map cvlan3 with svlan 12
SW3(config-cvlan-registration)#cvlan 4 svlan 14	Map cvlan4 with svlan 14

SW3(config-cvlan-registration)#exit	Exit registration table
SW3(config)#interface eth1	Enter interface configuration mode for eth1
SW3(config-if)#switchport	Configure switchport
SW3(config-if)#bridge-group 1	Associate interface with bridge-group 1
SW3(config-if)#switchport mode customer-edge access	Configure switchport mode customer edge
SW3(config-if)#switchport customer-edge hybrid vlan 2	Associate customer vlan2 with interface
SW3(config-if)#switchport customer-edge hybrid allowed vlan all	Associate all customer vlan with interface
SW3(config-if)#switchport customer-edge vlan registration map1	Attach registration table map1 with interface
SW3(config-if)#exit	Exit interface mode
SW3(config-if)#interface eth2	Enter interface configuration mode for eth2
SW3(config-if)#switchport	Make interface as switchport
SW3(config-if)#bridge-group 1	Associate interface with bridge-group 1
SW3(config-if)#switchport mode provider-network	Configure switchport pnp port
SW3(config-if)#switchport provider-network allowed vlan all	Associate all svlan to the port
SW3(config-if)#exit	Exit interface configuration mode
SW3(config)#commit	Apply the commit
SW3(config)#end	Exit configuration mode

## Validation

SW3#sh bridge

bridge 1 is running on provider-rstp edge

Ageout time is global and if something is configured for vxlan then it will be affected here also

Bridge	CVLAN	SVLAN	BVLAN	Port	MAC Address	FWD	Time-out
1	4	14		eth2	0000.0100.0007	1	300

SW1#sh bridge

bridge 1 is running on provider-rstp edge

Ageout time is global and if something is configured for vxlan then it will be affected here also

Bridge	CVLAN	SVLAN	BVLAN	Port	MAC Address	FWD	Time-out
1		14		eth1	0000.0100.0007	1	300

## Provider Bridging Configuration

---

```
SW1#sh cvlan registration table map1
```

```
Bridge          Table Name      Port List
```

```
=====
```

```
1              map1          eth1
```

```
CVLAN ID      T-CVLAN ID      SVLAN ID      CCOS  SCOS  CCFI  SCFI
```

```
=====
```

```
3             -          12
```

```
2             -          11
```

```
4             -          14
```

## CHAPTER 15 Provider Bridging Configuration (SVLAN)

---

This chapter contains sample provider bridging configurations for Customer-Network Port (CNP).

A provider bridged network is a virtual bridged Local Area Network that comprises provider bridges (SVLAN bridges and provider edge bridges) and attached LANs, under the administrative control of a single service provider. Provider bridges interconnect the separate MACs of the IEEE 802 LANs that compose a provider bridged network, relaying frames to provide connectivity between all the LANs that provide customer interfaces for each service instance.

---

### Customer-Network Port (CNP)

In Q-in-Q, the customer network port is similar to provider network port, which can be present in provider-edge bridge (PEB) or provider bridge core (PB), where it can be directly connected to a dedicated customer network. Only SVLAN ids are configurable on Customer network port and learning and forwarding occurs based on SVLAN.

---

### STAG-based Interface

In this case, the customer will be sending traffic with SVLAN, which will be learnt and forwarded via provider network.

In this example, the xe1 interface allows S-TAG 100-200 and 400 traffic from customer.

```
(config)#interface xe1
(config-if)#switchport
(config-if)#dot1ad ethertype 0x88a8
(config-if)#bridge-group 1
(config-if)#switchport mode customer-network
(config-if)#switchport customer-network allowed vlan add 100-200,400
```

---

### Port-based Interface

In this case, the customer traffic with C-VLAN/untagged, received on interface will be stacked with a customer-network SVLAN ID and will be forwarded via provider network. While egressing out of customer-network port for the default SVLAN, the outer SVLAN id will be stripped and the packet will be sent as C-TAG or untagged to customer device.

In this example, the xe1 interface allows C-TAG/untagged traffic from customers, adding an SVLAN ID 100 before forwarding to the provider network. While egressing out, the SVLAN ID100 will be stripped.

```
(config)#interface xe1
(config-if)#switchport
(config-if)#dot1ad ethertype 0x88a8
(config-if)#bridge-group 1
(config-if)#switchport mode customer-network
(config-if)#switchport customer-network allowed vlan add 100
(config-if)#switchport customer-network vlan 100
```

## Topology



Figure 15-31: Single provider bridge configuration

## Configuration

### SW1 (PEB)

SW1#configure terminal	Enter configuration mode
SW1(config)#bridge 1 protocol provider-rstp edge	Create bridge
SW1(config)#vlan database	Enter VLAN configuration mode
SW1(config-vlan)#vlan 100,200 type service point-point bridge 1 state enable	Create service vlan VLAN 100, 200
SW1(config-vlan)#exit	Exit VLAN configuration mode
SW1(config)#interface eth1	Enter interface configuration mode for eth1
SW1(config-if)#switchport	Configure switchport
SW1(config-if)#dot1ad ethertype 0x88a8	Add Provider Bridging Service VLAN tag identifier
SW1(config-if)#switchport mode customer-network	Configure switchport mode for CNP(customer network port)
SW1(config-if)#switchport customer-network allowed vlan add 200	Associate vlan 200 with interface
SW1(config-if)#switchport customer-network vlan 200	Add vlan 200 as default SVLAN-ID for traffic with CVLAN/untagged
SW1(config-if)#exit	Exit interface mode
SW1(config-if)#interface eth2	Enter interface configuration mode for eth2
SW1(config-if)#switchport	Make interface as switchport
SW1(config-if)#bridge-group 1	Associate interface with bridge-group 1
SW1(config-if)#switchport mode provider-network	Configure switchport pnp port
SW1(config-if)#switchport provider-network allowed vlan all	Associate all svlan to the port
SW1(config-if)#commit	Commit the configuration.
SW1(config-if)#exit	Exit interface configuration mode

**SW2 (PB)**

SW2#configure terminal	Enter configuration mode
SW2(config)#bridge 1 protocol provider-rstp	Create provider bridge
SW2(config)#vlan database	Enter VLAN configuration mode
SW2(config-vlan)#vlan 200 type service point-point bridge 1 state enable	Create service vlan VLAN200
SW2(config-vlan)#exit	Exit VLAN configuration mode
SW2(config)#interface eth1	Enter interface configuration mode for eth1
SW2(config-if)#switchport	Make interface as switchport
SW2(config-if)#bridge-group 1	Associate interface with bridge-group 1
SW2(config-if)#switchport mode provider-network	Configure switchport pnp port
SW2(config-if)#switchport provider-network allowed vlan all	Associate all svlan to the port
SW2(config-if)#exit	Exit interface configuration mode
SW2(config-if)#interface eth2	Enter interface configuration mode for eth2
SW2(config-if)#switchport	Make interface as switchport
SW2(config-if)#bridge-group 1	Associate interface with bridge-group 1
SW2(config-if)#switchport mode provider-network	Configure switchport pnp port
SW2(config-if)#switchport provider-network allowed vlan all	Associate all svlan to the port
SW2(config-if)#commit	Commit the configuration.
SW2(config-if)#exit	Exit interface configuration mode

**SW3 (PEB)**

SW3#configure terminal	Enter configuration mode
SW3(config)#bridge 1 protocol provider-rstp edge	Create bridge
SW3(config)#vlan database	Enter VLAN configuration mode
SW3(config-vlan)#vlan 200 type service point-point bridge 1 state enable	Create service vlan VLAN200
SW3(config-vlan)#exit	Exit VLAN configuration mode
SW3(config)#interface eth1	Enter interface configuration mode for eth1
SW3(config-if)#switchport	Configure switchport
SW3(config-if)#dot1ad ethertype 0x88a8	Add Provider Bridging Service VLAN tag identifier
SW3(config-if)#bridge-group 1	Associate interface with bridge-group 1
SW3(config-if)#switchport mode customer-network	Configure switchport CNP port
SW3(config-if)#switchport customer-network allowed vlan add 200	Associate vlan 200 with interface
SW3(config-if)#switchport customer-network vlan 200	Add vlan 200 as default SVLAN-ID for traffic with CVLAN/untagged

## Provider Bridging Configuration (SVLAN)

---

SW3(config-if)#exit	Exit interface mode
SW3(config-if)#interface eth2	Enter interface configuration mode for eth2
SW3(config-if)#switchport	Make interface as switchport
SW3(config-if)#bridge-group 1	Associate interface with bridge-group 1
SW3(config-if)#switchport mode provider-network	Configure switchport pnp port
SW3(config-if)#switchport provider-network allowed vlan all	Associate all svlan to the port
SW3(config-if)#commit	Commit the configuration.
SW3(config-if)#exit	Exit interface configuration mode

---

## Validation

SW3#show bridge

bridge 1 is running on provider-rstp edge

Ageout time is global and if something is configured for vxlan then it will be affected here also

Bridge	CVLAN	SVLAN	BVLAN	Port	MAC Address	FWD	Time-out
1		200		eth1	0000.0000.0f00	1	300
1		200		eth2	0001.0000.0800	1	300

SW1#show bridge

bridge 1 is running on provider-rstp edge

Ageout time is global and if something is configured for vxlan then it will be affected here also

Bridge	CVLAN	SVLAN	BVLAN	Port	MAC Address	FWD	Time-out
1		200		eth2	0000.0000.0f00	1	300
1		200		eth1	0001.0000.0800	1	300



## CHAPTER 16 Link Layer Discovery Protocol Configuration

This chapter contains a complete sample Link Layer Discovery Protocol (LLDP) configuration.

LLDP is a neighbor discovery protocol that defines a method for network access devices using Ethernet connectivity to advertise themselves to other devices on the same physical LAN, and then to store information about the network. It allows a device to learn higher-layer management reachability and connection endpoint information from adjacent devices. Using LLDP, a network device is able to advertise its identity, its capabilities and its media-specific configuration, as well as learn the same information from other connected devices.

Note: The `lldp-agent` command is not supported for SVLAN, VLAN, and loop-back interfaces.

### Topology

Figure 16-32 displays a sample LLDP topology.

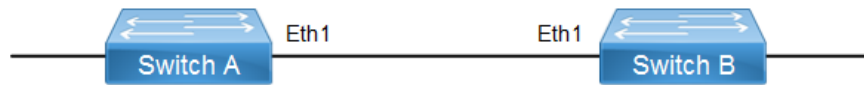

Figure 16-32: LLDP Topology

### Interface Mode TLV

#### Default Agent

All configuration commands in the table below should be followed for each switch.

<code>#configure terminal</code>	Enter configure mode.
<code>(config)#bridge 1 protocol ieee vlan-bridge</code>	Configure an IEEE VLAN-aware bridge.
<code>(config)#vlan database</code>	Enter VLAN configure mode.
<code>(config-vlan)#vlan 2 bridge 1 state enable</code>	Configure a VLAN and add it to the bridge.
<code>(config-vlan)#exit</code>	Exit the VLAN configuration mode.
<code>(config)#interface eth1</code>	Enter interface mode.
<code>(config-if)#switchport</code>	Set switching characteristics on the port.
<code>(config-if)#bridge-group 1</code>	Associate the interface to the bridge.
<code>(config-if)#lldp-agent</code>	Enter into the default agent
<code>(if-lldp-agent)#set lldp enable txrx</code>	Enable an LLDP agent on the port.
<code>(if-lldp-agent)#set lldp chassis-id-tlv ip-address</code>	Configure the subtype for chassis-id TLV
<code>(if-lldp-agent)#set lldp port-id-tlv mac-address</code>	Configure the subtype for port-id TLV
<code>(if-lldp-agent)#lldp tlv basic-mgmt port-description select</code>	Enable the port-description TLV to be transmitted on the port
<code>(if-lldp-agent)#lldp tlv basic-mgmt system-name select</code>	Enable the system-name TLV to be transmitted on the port

## Link Layer Discovery Protocol Configuration

<code>(if-lldp-agent)#lldp tlv basic-mgmt system-capabilities select</code>	Enable the system-capabilities TLV to be transmitted on the port
<code>(if-lldp-agent)#lldp tlv basic-mgmt system-description select</code>	Enable the system-description TLV to be transmitted on the port
<code>(if-lldp-agent)#lldp tlv basic-mgmt management-address select</code>	Enable the management-address TLV to be transmitted on the port
<code>(if-lldp-agent)#lldp tlv ieee-8021-org-specific port-vlanid select</code>	Enable the VLAN-id TLV to be transmitted on the port
<code>(if-lldp-agent)#lldp tlv ieee-8021-org-specific vlan-name select</code>	Enable the VLAN-NAME TLV to be transmitted on the port
<code>(if-lldp-agent)#lldp tlv ieee-8021-org-specific port-ptcl-vlanid select</code>	Enable the Port and Protocol VLAN id TLV to be transmitted on the port
<code>(if-lldp-agent)#lldp tlv ieee-8021-org-specific ptcl-identity select</code>	Enable the Protocol Identity TLV to be transmitted on the port
<code>(if-lldp-agent)#lldp tlv ieee-8021-org-specific vid-digest select</code>	Enable the VID Usage Digest TLV to be transmitted on the port
<code>(if-lldp-agent)#lldp tlv ieee-8021-org-specific mgmt-vid select</code>	Enable the Management VID TLV to be transmitted on the port
<code>(if-lldp-agent)#lldp tlv ieee-8021-org-specific link-agg select</code>	Enable the Link Aggregation TLV to be transmitted on the port
<code>(if-lldp-agent)#lldp tlv ieee-8023-org-specific mac-phy select</code>	Enable the MAC/PHY Configuration/Status TLV to be transmitted on the port
<code>(if-lldp-agent)#lldp tlv ieee-8023-org-specific max-mtu-size select</code>	Enable the Maximum Frame Size TLV to be transmitted on the port
<code>(if-lldp-agent)#set lldp timer msg-fast-tx 5</code>	Defines the time interval during fast transmission periods
<code>(if-lldp-agent)#set lldp tx-fast-init 6</code>	Defines the number of LLDPDUs that are transmitted during a fast transmission period
<code>(if-lldp-agent)#exit</code>	Exit the lldp agent mode
<code>(config-if)#exit</code>	Exit interface mode.

## Validation

### 1. Verify the LLDP configurations in the local switch

```
#show running-config lldp
!
interface eth1
lldp-agent
  set lldp enable txrx
  set lldp chassis-id-tlv ip-address
  set lldp port-id-tlv mac-address
  lldp tlv basic-mgmt port-description select
  lldp tlv basic-mgmt system-name select
  lldp tlv basic-mgmt system-description select
  lldp tlv basic-mgmt system-capabilities select
  lldp tlv basic-mgmt management-address select
  lldp tlv ieee-8021-org-specific port-vlanid select
  lldp tlv ieee-8021-org-specific port-ptcl-vlanid select
  lldp tlv ieee-8021-org-specific vlan-name select
  lldp tlv ieee-8021-org-specific ptcl-identity select
  lldp tlv ieee-8021-org-specific vid-digest select
```

```

lldp tlv ieee-8021-org-specific mgmt-vid select
lldp tlv ieee-8021-org-specific link-agg select
lldp tlv ieee-8023-org-specific mac-phy select
lldp tlv ieee-8023-org-specific max-mtu-size select
set lldp timer msg-fast-tx 5
set lldp tx-fast-init 6
!
```

## 2. Verify the LLDP port statistics

```
#show lldp interface eth1 nearest-bridge
```

```

Agent Mode                : Nearest bridge
Enable (tx/rx)            : Y/Y
Message fast transmit time : 5
Message transmit interval : 30
Reinitialisation delay    : 2
MED Enabled               : N
Device Type               : Not Defined
Traffic statistics        :
Total frames transmitted   : 4
Total entries aged        : 0
Total frames received     : 3
Total error frames received: 0
Total frames discarded    : 0
Total discarded TLVs      : 0
Total unrecognised TLVs  : 0
```

## Customer Bridge

All configuration commands in the table below should be followed for each switch.

#configure terminal	Enter configure mode.
(config)#bridge 1 protocol ieee vlan-bridge	Configure an IEEE VLAN-aware bridge.
(config)#vlan database	Enter VLAN configure mode.
(config-vlan)#vlan 2 bridge 1 state enable	Configure a VLAN and add it to the bridge.
(config-vlan)#exit	Exit the VLAN configuration mode.
(config)#interface eth1	Enter interface mode.
(config-if)#switchport	Set switching characteristics on the port.
(config-if)#bridge-group 1	Associate the interface to the bridge.
(config-if)#lldp-agent customer-bridge	Enter into the Customer Bridge agent
(if-lldp-agent)#set lldp enable txrx	Enable an LLDP agent on the port.
(if-lldp-agent)#set lldp chassis-id-tlv ip-address	Configure the subtype for chassis-id TLV
(if-lldp-agent)#set lldp port-id-tlv mac-address	Configure the subtype for port-id TLV
(if-lldp-agent)#lldp tlv basic-mgmt port-description select	Enable the port-description TLV to be transmitted on the port.
(if-lldp-agent)#lldp tlv basic-mgmt system-name select	Enable the system-name TLV to be transmitted on the port.

## Link Layer Discovery Protocol Configuration

<code>(if-lldp-agent)#lldp tlv basic-mgmt system-capabilities select</code>	Enable the system-capabilities TLV to be transmitted on the port.
<code>(if-lldp-agent)#lldp tlv basic-mgmt system-description select</code>	Enable the system-description TLV to be transmitted on the port.
<code>(if-lldp-agent)#lldp tlv basic-mgmt management-address select</code>	Enable the management-address TLV to be transmitted on the port.
<code>(if-lldp-agent)#lldp tlv ieee-8021-org-specific port-vlanid select</code>	Enable the VLAN-id TLV to be transmitted on the port.
<code>(if-lldp-agent)#lldp tlv ieee-8021-org-specific vlan-name select</code>	Enable the VLAN-NAME TLV to be transmitted on the port.
<code>(if-lldp-agent)#lldp tlv ieee-8021-org-specific port-ptcl-vlanid select</code>	Enable the Port and Protocol VLAN id TLV to be transmitted on the port.
<code>(if-lldp-agent)#lldp tlv ieee-8021-org-specific ptcl-identity select</code>	Enable the Protocol Identity TLV to be transmitted on the port.
<code>(if-lldp-agent)#lldp tlv ieee-8021-org-specific vid-digest select</code>	Enable the VID Usage Digest TLV to be transmitted on the port
<code>(if-lldp-agent)#lldp tlv ieee-8021-org-specific mgmt-vid select</code>	Enable the Management VID TLV to be transmitted on the port.
<code>(if-lldp-agent)#lldp tlv ieee-8021-org-specific link-agg select</code>	Enable the Link Aggregation TLV to be transmitted on the port.
<code>(if-lldp-agent)#lldp tlv ieee-8023-org-specific mac-phy select</code>	Enable the MAC/PHY Configuration/Status TLV to be transmitted on the port
<code>(if-lldp-agent)#lldp tlv ieee-8023-org-specific max-mtu-size select</code>	Enable the Maximum Frame Size TLV to be transmitted on the port.
<code>(if-lldp-agent)#set lldp timer msg-fast-tx 5</code>	Defines the time interval during fast transmission periods.
<code>(if-lldp-agent)#set lldp tx-fast-init 6</code>	Defines the number of LLD PDUs that are transmitted during a fast transmission period.
<code>(if-lldp-agent)#exit</code>	Exit the lldp agent mode
<code>(config-if)#exit</code>	Exit interface mode.

## Validation

### 1. Verify the LLDP configurations in the local switch:

```
#show #show running-config lldp
!
interface eth1
lldp-agent customer-bridge
  set lldp enable txrx
  set lldp chassis-id-tlv ip-address
  set lldp port-id-tlv mac-address
  lldp tlv basic-mgmt port-description select
  lldp tlv basic-mgmt system-name select
  lldp tlv basic-mgmt system-description select
  lldp tlv basic-mgmt system-capabilities select
  lldp tlv basic-mgmt management-address select
  lldp tlv ieee-8021-org-specific port-vlanid select
  lldp tlv ieee-8021-org-specific port-ptcl-vlanid select
  lldp tlv ieee-8021-org-specific vlan-name select
  lldp tlv ieee-8021-org-specific ptcl-identity select
  lldp tlv ieee-8021-org-specific vid-digest select
  lldp tlv ieee-8021-org-specific mgmt-vid select
```

```

lldp tlv ieee-8021-org-specific link-agg select
lldp tlv ieee-8023-org-specific mac-phy select
lldp tlv ieee-8023-org-specific max-mtu-size select
set lldp timer msg-fast-tx 5
set lldp tx-fast-init 6
!
```

## 2. Verify the LLDP port statistics

```
#show lldp interface eth1 customer-bridge
```

```

Agent Mode                : Customer-bridge
Enable (tx/rx)            : Y/Y
Message fast transmit time : 5
Message transmit interval : 30
Reinitialisation delay    : 2
MED Enabled               : N
Device Type               : Not Defined
Traffic statistics        :
Total frames transmitted   : 8
Total entries aged        : 0
Total frames received     : 7
Total error frames received : 0
Total frames discarded    : 0
Total discarded TLVs      : 0
Total unrecognised TLVs   : 0
```

## Non-Tpnr-Bridge

The below configurations should be followed for each switch.

#configure terminal	Enter configure mode.
(config)#bridge 1 protocol ieee vlan-bridge	Configure an IEEE VLAN-aware bridge.
(config)#vlan database	Enter VLAN configure mode.
(config-vlan)#vlan 2 bridge 1 state enable	Configure a VLAN and add it to the bridge.
(config-vlan)#exit	Exit the VLAN configuration mode.
(config)#interface eth1	Enter interface mode.
(config-if)#switchport	Set switching characteristics on the port.
(config-if)#bridge-group 1	Associate the interface to the bridge.
(config-if)#lldp-agent non-tpnr-bridge	Enter into the Non tpmr Bridge agent
(if-lldp-agent)#set lldp enable txrx	Enable an LLDP agent on the port.
(if-lldp-agent)#set lldp chassis-id-tlv ip-address	Configure the subtype for chassis-id TLV
(if-lldp-agent)#set lldp port-id-tlv mac-address	Configure the subtype for port-id TLV
(if-lldp-agent)#lldp tlv basic-mgmt port-description select	Enable the port-description TLV to be transmitted on the port
(if-lldp-agent)#lldp tlv basic-mgmt system-name select	Enable the system-name TLV to be transmitted on the port

## Link Layer Discovery Protocol Configuration

<code>(if-lldp-agent)#lldp tlv basic-mgmt system-capabilities select</code>	Enable the system-capabilities TLV to be transmitted on the port
<code>(if-lldp-agent)#lldp tlv basic-mgmt system-description select</code>	Enable the system-description TLV to be transmitted on the port
<code>(if-lldp-agent)#lldp tlv basic-mgmt management-address select</code>	Enable the management-address TLV to be transmitted on the port
<code>(if-lldp-agent)#lldp tlv ieee-8021-org-specific port-vlanid select</code>	Enable the VLAN-id TLV to be transmitted on the port
<code>(if-lldp-agent)#lldp tlv ieee-8021-org-specific vlan-name select</code>	Enable the VLAN-NAME TLV to be transmitted on the port
<code>(if-lldp-agent)#lldp tlv ieee-8021-org-specific port-ptcl-vlanid select</code>	Enable the Port and Protocol VLAN id TLV to be transmitted on the port
<code>(if-lldp-agent)#lldp tlv ieee-8021-org-specific ptcl-identity select</code>	Enable the Protocol Identity TLV to be transmitted on the port
<code>(if-lldp-agent)#lldp tlv ieee-8021-org-specific vid-digest select</code>	Enable the VID Usage Digest TLV to be transmitted on the port
<code>(if-lldp-agent)#lldp tlv ieee-8021-org-specific mgmt-vid select</code>	Enable the Management VID TLV to be transmitted on the port
<code>(if-lldp-agent)#lldp tlv ieee-8021-org-specific link-agg select</code>	Enable the Link Aggregation TLV to be transmitted on the port
<code>(if-lldp-agent)#lldp tlv ieee-8023-org-specific mac-phy select</code>	Enable the MAC/PHY Configuration/Status TLV to be transmitted on the port
<code>(if-lldp-agent)#lldp tlv ieee-8023-org-specific max-mtu-size select</code>	Enable the Maximum Frame Size TLV to be transmitted on the port
<code>(if-lldp-agent)#set lldp timer msg-fast-tx 5</code>	Defines the time interval during fast transmission periods
<code>(if-lldp-agent)#set lldp tx-fast-init 6</code>	Defines the number of LLD PDUs that are transmitted during a fast transmission period
<code>(if-lldp-agent)#exit</code>	Exit the lldp agent mode
<code>(config-if)#exit</code>	Exit interface mode.

## Validation

### 1. Verify the LLDP configurations in the local switch:

```
#show running-config lldp
lldp-agent non-tpmr-bridge
  set lldp enable txrx
  set lldp chassis-id-tlv ip-address
  set lldp port-id-tlv mac-address
  lldp tlv basic-mgmt port-description select
  lldp tlv basic-mgmt system-name select
  lldp tlv basic-mgmt system-description select
  lldp tlv basic-mgmt system-capabilities select
  lldp tlv basic-mgmt management-address select
  lldp tlv ieee-8021-org-specific port-vlanid select
  lldp tlv ieee-8021-org-specific port-ptcl-vlanid select
  lldp tlv ieee-8021-org-specific vlan-name select
  lldp tlv ieee-8021-org-specific ptcl-identity select
  lldp tlv ieee-8021-org-specific vid-digest select
  lldp tlv ieee-8021-org-specific mgmt-vid select
  lldp tlv ieee-8021-org-specific link-agg select
  lldp tlv ieee-8023-org-specific mac-phy select
```

```
lldp tlv ieee-8023-org-specific max-mtu-size select
set lldp timer msg-fast-tx 5
set lldp tx-fast-init 6
```

!

## 2. Verify the LLDP port statistics

```
#show lldp interface eth1 non-tpmr-bridge

Agent Mode                : Non-TPMR-bridge
Enable (tx/rx)           : Y/Y
Message fast transmit time : 5
Message transmit interval : 30
Reinitialisation delay   : 2
MED Enabled               : Y
Device Type               : Not Defined
Traffic statistics       :
Total frames transmitted  : 17
Total entries aged        : 0
Total frames received     : 6
Total error frames received : 0
Total frames discarded    : 0
Total discarded TLVs      : 0
Total unrecognised TLVs  : 0
```

---

## Media Endpoint Devices TLV

### Switch A

(config)#interface eth1	Enter interface mode.
(config-if)#lldp-agent	Enter the default agent.
(if-lldp-agent)#set lldp enable txrx	Set the admin status of the LLDP agent.
(if-lldp-agent)#exit	Exit agent mode.
(config-if)#lldp-agent customer-bridge	Enter the customer-bridge agent.
(if-lldp-agent)#set lldp enable txrx	Set the admin status of the LLDP agent.
(if-lldp-agent)#exit	Exit agent mode.
(config-if)#lldp-agent non-tpmr-bridge	Enter the non-tpmr-bridge agent.
(if-lldp-agent)#set lldp enable txrx	Set the admin status of the LLDP agent.
(if-lldp-agent)#exit	Exit agent mode.
(config-if)#set lldp med-devtype net-connect	Enter the med-devtype agent and set the device type to network connectivity.
(config-if)#exit	Exit agent mode.

### Validation

```
#show run lldp
!
!
interface eth1
 lldp-agent
```

## Link Layer Discovery Protocol Configuration

---

```
set lldp enable txrx
set lldp med-devtype net-connect
lldp-agent non-tpmr-bridge
set lldp enable txrx
lldp-agent customer-bridge
set lldp enable txrx
!
#

#show lldp interface eth1
Agent Mode           : Customer-bridge
  Enable (tx/rx)     : Y/Y
  Message fast transmit time : 1
  Message transmit interval : 30
  Reinitialisation delay : 2
  MED Enabled        : Y
  Device Type        : Network Connectivity
Traffic statistics   :
  Total frames transmitted : 97
  Total entries aged      : 1
  Total frames received   : 92
  Total error frames received: 0
  Total frames discarded  : 0
  Total discarded TLVs    : 0
  Total unrecognised TLVs : 0
Agent Mode           : Non-TPMR-bridge
  Enable (tx/rx)     : Y/Y
  Message fast transmit time : 1
  Message transmit interval : 30
  Reinitialisation delay : 2
  MED Enabled        : N
  Device Type        : Network Connectivity
Traffic statistics   :
  Total frames transmitted : 89
  Total entries aged      : 0
  Total frames received   : 0
  Total error frames received: 0
  Total frames discarded  : 0
  Total discarded TLVs    : 0
  Total unrecognised TLVs : 0
Agent Mode           : Nearest bridge
  Enable (tx/rx)     : Y/Y
  Message fast transmit time : 1
  Message transmit interval : 30
  Reinitialisation delay : 2
  MED Enabled        : N
  Device Type        : Network Connectivity
Traffic statistics   :
  Total frames transmitted : 90
  Total entries aged      : 0
```



```
Total frames received      : 0
Total error frames received: 0
Total frames discarded     : 0
Total discarded TLVs       : 0
Total unrecognised TLVs   : 0
#
```

## Switch B

(config)#interface eth1	Enter interface mode.
(config-if)#lldp-agent	Enter the default agent.
(if-lldp-agent)#set lldp enable txrx	Set the admin status of the LLDP agent.
(if-lldp-agent)#exit	Exit agent mode.
(config-if)#lldp-agent customer-bridge	Enter the customer-bridge agent.
(if-lldp-agent)#set lldp enable txrx	Set the admin status of the LLDP agent.
(if-lldp-agent)#exit	Exit agent mode.
(config-if)#lldp-agent non-tpmr-bridge	Enter the non-tpmr-bridge agent.
(if-lldp-agent)#set lldp enable txrx	Set the admin status of the LLDP agent.
(if-lldp-agent)#exit	Exit agent mode.
(config-if)#set lldp med-devtype ep-class3	Enter the med-devtype agent and set the device type to endpoint class 3.
(config-if)#exit	Exit agent mode.

## Validation

```
#show running-config lldp
!
!
interface eth1
 lldp-agent
  set lldp enable txrx
  set lldp chassis-id-tlv ip-address
set lldp med-devtype ep-class3
lldp-agent non-tpmr-bridge
  set lldp enable txrx
  set lldp chassis-id-tlv ip-address
lldp-agent customer-bridge
  set lldp enable txrx
  set lldp chassis-id-tlv ip-address
!
#

#show lldp interface eth1
Agent Mode           : Customer-bridge
Enable (tx/rx)       : Y/Y
Message fast transmit time : 1
Message transmit interval : 30
Reinitialisation delay : 2
MED Enabled          : Y
```

## Link Layer Discovery Protocol Configuration

---

```
Device Type           : End Point Class-3
Traffic statistics    :
Total frames transmitted : 11
Total entries aged     : 0
Total frames received  : 12
Total error frames received: 0
Total frames discarded : 0
Total discarded TLVs   : 0
Total unrecognised TLVs : 0
Agent Mode            : Non-TPMR-bridge
Enable (tx/rx)       : Y/Y
Message fast transmit time : 1
Message transmit interval : 30
Reinitialisation delay : 2
MED Enabled          : Y
Device Type           : End Point Class-3
Traffic statistics    :
Total frames transmitted : 7
Total entries aged     : 0
Total frames received  : 0
Total error frames received: 0
Total frames discarded : 0
Total discarded TLVs   : 0
Total unrecognised TLVs : 0
Agent Mode            : Nearest bridge
Enable (tx/rx)       : Y/Y
Message fast transmit time : 1
Message transmit interval : 30
Reinitialisation delay : 2
MED Enabled          : Y
Device Type           : End Point Class-3
Traffic statistics    :
Total frames transmitted : 8
Total entries aged     : 0
Total frames received  : 0
Total error frames received: 0
Total frames discarded : 0
Total discarded TLVs   : 0
Total unrecognised TLVs : 0
#
```

---

## Global Mode TLV

LLDPv2 TLVs can be configured globally, making it applicable for all interfaces where LLDP is enabled.

## Topology

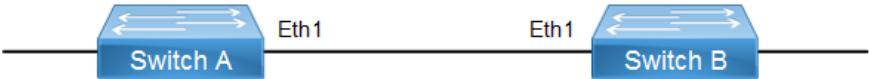

Figure 16-33: LLDP topology

### SW1

SW1#configure terminal	Enter Configure mode
SW1(config)#lldp tlv-select basic-mgmt port-description	Enable LLDP port description TLV in global mode
SW1(config)#lldp tlv-select basic-mgmt system-name	Enable LLDP system name TLV in global mode
SW1(config)#lldp tlv-select basic-mgmt system-capabilities	Enable LLDP system capabilities TLV in global mode
SW1(config)#lldp tlv-select basic-mgmt system-description	Enable LLDP system description TLV in global mode
SW1(config)#lldp tlv-select basic-mgmt management-address	Enable LLDP management address TLV in global mode
SW1(config)#interface eth1	Enter interface mode
SW1(config-if)#lldp-agent	Enter LLDP interface mode
SW1(if-lldp-agent)#set lldp enable txrx	Enable LLDP TLV transmit and receive for the nearest bridge
SW1(if-lldp-agent)#exit	Exit LLDP mode
SW1(config-if)#exit	Exit interface mode
SW1(config)#end	Exit the configure mode

### SW2

SW2#configure terminal	Enter Configure mode
SW2(config)#lldp tlv-select basic-mgmt port-description	Enable LLDP port description TLV in global mode
SW2(config)#lldp tlv-select basic-mgmt system-name	Enable LLDP system name TLV in global mode
SW2(config)#lldp tlv-select basic-mgmt system-capabilities	Enable LLDP system capabilities TLV in global mode
SW2(config)#lldp tlv-select basic-mgmt system-description	Enable LLDP system description TLV in global mode
SW2(config)#lldp tlv-select basic-mgmt management-address	Enable LLDP management address TLV in global mode
SW2(config)#interface eth1	Enter interface mode
SW2(config-if)#lldp-agent	Enter LLDP interface mode
SW2(if-lldp-agent)#set lldp enable txrx	Enable LLDP TLV transmit and receive for the nearest bridge
SW2(if-lldp-agent)#exit	Exit LLDP mode
SW2(config-if)#exit	Exit interface mode
SW2(config)#end	Exit the configure mode

## Validation

```
SW1#show running-config lldp
!
lldp tlv-select basic-mgmt port-description
lldp tlv-select basic-mgmt system-name
lldp tlv-select basic-mgmt system-capabilities
lldp tlv-select basic-mgmt system-description
lldp tlv-select basic-mgmt management-address
!
interface eth1
 lldp-agent
  set lldp enable txrx
```

```
SW1#show lldp neighbors
```

Loc PortID	Rem Host Name	Rem Chassis Id	Rem Port Id	Agent Mode
Eth1	OcNOS	cc37.ab56.6d80	cc37.abbb.ed81	Nearest bridge

```
SW1#show lldp neighbors detail
```

```
-----
Nearest bridge Neighbors
Interface Name           : eth1
Mandatory TLVs
Chassis id type         : MAC address [cc37.ab56.6d80]
Port id type            : MAC address [cc37.abbb.ed81]
Time to live            : 121
Basic Management TLVs
System Name             : SW2
System Description      : Hardware Model:EC_AS4610-54, Software version: Oc
NOS,1.3.6.241a
Port Description        : eth1
Remote System Capabilities : Bridge
                        Router
Capabilities Enabled     : Router
Management Address      : MAC Address [cc37.abbb.ed81]
Interface Number subtype : ifindex
Interface Number        : 10046
OID Number              : 0
802.1 Org specific TLVs
Port vlan id            : 0
Port & Protocol vlan id : 0
Remote Configured VLANs : None
Remote Protocols Advertised: None
```

```
Remote VID Usage Digest    : 0
Remote Management Vlan     : 0
Link Aggregation Capability: not capable of being aggregated
Link Aggregation Status    : not currently in aggregation
Link Aggregation Port ID   :
802.3 Org specific TLVs
AutoNego Support           : Not-Supported
AutoNego Status           : Disabled
AutoNego Capability        : 0
Operational MAU Type       : 0 [unknown]
Max Frame Size             :
SW1#
```

---

## LLDP-MED

LLDP extensions and behavior requirements are described specifically in the areas of network Configuration and policy, device location (including for Emergency Call Service / E911), Power over Ethernet management, and inventory management.

Based on the device type, different TLVs are advertised by the Station.

---

### LLDP-MED Network Connectivity Device

LLDP-MED Network Connectivity Devices, as defined in this Standard, provide access to the IEEE 802 based LAN infrastructure for LLDP-MED Endpoint Devices. An LLDP-MED Network Connectivity Device is a LAN access device based on any of the following technologies:

- LAN Switch/Router
- IEEE 802.1 Bridge
- IEEE 802.3 Repeater (included for historical reasons)
- IEEE 802.11 Wireless Access Point
- Any device that supports the IEEE 802.1AB and MED extensions defined by this Standard and can relay IEEE 802 frames via any method.

#### Configuration Command

```
set lldp med-devtype net-connect
```

---

### LLDP-MED Generic Endpoint (Class I)

The LLDP-MED Generic Endpoint (Class I) definition is applicable to all endpoint products that require the base LLDP discovery services, however do not support IP media or act as an end-user communication appliance. Such devices may include (but are not limited to) IP Communication Controllers, other communication related servers, or any device requiring basic services.

#### Configuration command:

```
set lldp med-devtype ep-class1
```

---

## LLDP-MED Generic Endpoint (Class 2)

The LLDP-MED Media Endpoint (Class II) definition is applicable to all endpoint products that have IP media capabilities however may or may not be associated with a particular end user. Capabilities include all of the capabilities defined for the previous Generic Endpoint Class (Class I), and are extended to include aspects related to media streaming. Example product categories expected to adhere to this class include (but are not limited to) Voice / Media Gateways, Conference Bridges, Media Servers, and similar

Configuration command:

```
set lldp med-devtype ep-class2
```

---

## LLDP-MED Generic Endpoint (Class 3)

The LLDP-MED Communication Endpoint (Class III) definition is applicable to all endpoint products that act as end user communication appliances supporting IP media. Capabilities include all of the capabilities defined for the previous Generic Endpoint (Class I) and Media Endpoint (Class II) classes, and are extended to include aspects related to end user devices. Example product categories expected to adhere to this class include (but are not limited to) end user communication appliances, such as IP Phones, PC-based softphones, or other communication appliances that directly support the end user.

Configuration command:

```
set lldp med-devtype ep-class3
```

---

## Switch A

#configure terminal	Enter configure mode.
(config)#bridge 1 protocol ieee vlan-bridge	Configure an IEEE VLAN-aware bridge.
(config)#vlan database	Enter VLAN configure mode.
(config-vlan)#vlan 2 bridge 1 state enable	Configure a VLAN and add it to the bridge.
(config-vlan)#exit	Exit the VLAN configuration mode.
(config)#interface eth1	Enter interface mode.
(config-if)#switchport	Set switching characteristics on the port.
(config-if)#bridge-group 1	Associate the interface to the bridge.
(config-if)#lldp-agent	Enter into the default agent
(if-lldp-agent)#set lldp enable txrx	Enable an LLDP agent on the port.
(if-lldp-agent)#exit	Exit the lldp agent mode
(if-config-if)#lldp-agent customer-bridge	Enter into the customer-bridge agent.
(if-lldp-agent)#set lldp enable txrx	Enable an LLDP agent on the port.
(if-lldp-agent)#exit	Exit the lldp agent mode
(config-if)#lldp-agent non-tpmr-bridge	Enter into the non-tpmr-bridge agent
(if-lldp-agent)#set lldp enable txrx	Enable an LLDP agent on the port.

(if-lldp-agent)#exit	Exit the lldp agent mode
(config-if)#set lldp med-devtype net-connect	Configure the med device type
(config-if)#exit	Exit interface mode.

## Switch B

#configure terminal	Enter configure mode.
(config)#bridge 1 protocol ieee vlan-bridge	Configure an IEEE VLAN-aware bridge.
(config)#vlan database	Enter VLAN configure mode.
(config-vlan)#vlan 2 bridge 1 state enable	Configure a VLAN and add it to the bridge.
(config-vlan)#exit	Exit the VLAN configuration mode.
(config)#interface eth1	Enter interface mode.
(config-if)#switchport	Set switching characteristics on the port.
(config-if)#bridge-group 1	Associate the interface to the bridge.
(config-if)#lldp-agent	Enter into the default agent
(if-lldp-agent)#set lldp enable txrx	Enable an LLDP agent on the port.
(if-lldp-agent)#exit	Exit the lldp agent mode
(config-if)#lldp-agent customer-bridge	Enter into the customer-bridge agent
(if-lldp-agent)#set lldp enable txrx	Enable an LLDP agent on the port.
(if-lldp-agent)#exit	Exit the lldp agent mode
(config-if)#lldp-agent non-tpmr-bridge	Enter into the non-tpmr-bridge agent
(if-lldp-agent)#set lldp enable txrx	Enable an LLDP agent on the port.
(if-lldp-agent)#exit	Exit the lldp agent mode
(config-if)#set lldp med-devtype ep-class3	Configure the med device type
(config-if)#exit	Exit interface mode.

## Validation

1. Verify the LLDP configurations on Switch A:

```
#show running-config lldp
!
!
interface eth1
 lldp-agent
  set lldp enable txrx
 set lldp med-devtype net-connect
 lldp-agent non-tpmr-bridge
  set lldp enable txrx
 lldp-agent customer-bridge
  set lldp enable txrx
!
```

2. Verify the LLDP port statistics on Switch A:

## Link Layer Discovery Protocol Configuration

---

```
#show lldp interface eth1
Agent Mode                : Customer-bridge
  Enable (tx/rx)          : Y/Y
  Message fast transmit time : 1
  Message transmit interval : 30
  Reinitialisation delay   : 2
  MED Enabled              : Y
  Device Type              : Network Connectivity
  Traffic statistics       :
    Total frames transmitted : 11
    Total entries aged       : 0
    Total frames received    : 10
    Total error frames received: 0
    Total frames discarded   : 0
    Total discarded TLVs     : 0
    Total unrecognised TLVs  : 0
Agent Mode                : Non-TPMR-bridge
  Enable (tx/rx)          : Y/Y
  Message fast transmit time : 1
  Message transmit interval : 30
  Reinitialisation delay   : 2
  MED Enabled              : N
  Device Type              : Network Connectivity
  Traffic statistics       :
    Total frames transmitted : 7
    Total entries aged       : 0
    Total frames received    : 0
    Total error frames received: 0
    Total frames discarded   : 0
    Total discarded TLVs     : 0
    Total unrecognised TLVs  : 0
Agent Mode                : Nearest bridge
  Enable (tx/rx)          : Y/Y
  Message fast transmit time : 1
  Message transmit interval : 30
  Reinitialisation delay   : 2
  MED Enabled              : N
  Device Type              : Network Connectivity
  Traffic statistics       :
    Total frames transmitted : 7
    Total entries aged       : 0
    Total frames received    : 0
    Total error frames received: 0
    Total frames discarded   : 0
    Total discarded TLVs     : 0
    Total unrecognised TLVs  : 0

#show lldp interface eth1 non-tpmr-bridge
Agent Mode                : Non-TPMR-bridge
  Enable (tx/rx)          : Y/Y
  Message fast transmit time : 5
  Message transmit interval : 30
  Reinitialisation delay   : 2
  MED Enabled              : N
  Device Type              : Not Defined
  Traffic statistics       :
    Total frames transmitted : 4
```



```

Total entries aged      : 0
Total frames received   : 0
Total error frames received: 0
Total frames discarded  : 0
Total discarded TLVs    : 0
Total unrecognised TLVs : 0

```

### 3. Verify the LLDP configurations for end device ep-class3 on Switch B:

```

#show running-config lldp
!
interface eth1
  set lldp med-devtype ep-class3
  lldp-agent
  set lldp enable txrx
  lldp tlv med network-policy select
lldp-agent non-TPMR-bridge
  set lldp enable txrx
  lldp tlv med network-policy select
lldp-agent customer-bridge
  set lldp enable txrx
  lldp tlv med network-policy select
!

```

### 4. Verify the LLDP port statistics on Switch B:

```

#show lldp interface eth1
Agent Mode      : Customer-bridge
Enable (tx/rx) : Y/Y
Message fast transmit time : 1
Message transmit interval : 30
Reinitialisation delay : 2
MED Enabled    : Y
Device Type    : End Point Class-3
Traffic statistics :
Total frames transmitted : 124
Total entries aged      : 0
Total frames received   : 125
Total error frames received: 0
Total frames discarded  : 0
Total discarded TLVs    : 0
Total unrecognised TLVs : 0
Agent Mode      : Non-TPMR-bridge
Enable (tx/rx) : Y/Y
Message fast transmit time : 1
Message transmit interval : 30
Reinitialisation delay : 2
MED Enabled    : Y
Device Type    : End Point Class-3
Traffic statistics :
Total frames transmitted : 120
Total entries aged      : 0
Total frames received   : 0
Total error frames received: 0
Total frames discarded  : 0
Total discarded TLVs    : 0
Total unrecognised TLVs : 0
Agent Mode      : Nearest bridge

```

## Link Layer Discovery Protocol Configuration

---

```
Enable (tx/rx)           : Y/Y
Message fast transmit time : 1
Message transmit interval : 30
Reinitialisation delay   : 2
MED Enabled              : Y
  Device Type            : End Point Class-3
Traffic statistics       :
  Total frames transmitted : 120
  Total entries aged      : 0
  Total frames received   : 0
  Total error frames received: 0
  Total frames discarded  : 0
  Total discarded TLVs    : 0
  Total unrecognised TLVs : 0
```

#

# Data Center Bridging Configuration Guide



## CHAPTER 1 Priority-based Flow Control Configuration

This chapter shows how to:

- Enable PFC on a bridge and interface
- Configure priorities and link delay allowance for PFC

### Topology



SW1

Figure 1-34: PFC Enabled Bridge

### Configuring a Bridge and Interface for PFC

#configure terminal	Enter configure mode
(config)#bridge 1 protocol ieee vlan-bridge	Create bridge 1 as an IEEE VLAN-enabled bridge
(config)#data-center-bridging enable bridge 1	Enables DCB on the bridge
(config)#priority-flow-control enable bridge 1	Enables PFC on the bridge
(config)#interface eth1	Configure interface eth1
(config-if)#switchport	Configure eth1 as a layer 2 port
(config-if)#bridge-group 1	Configure eth1 in bridge group 1
(config-if)#lldp-agent	Enter into LLDP agent mode.
(lldp-agent)#set lldp enable txrx	Configure LLDP for transmit and receive mode on eth1
(lldp-agent)#lldp tlv ieee-8021-org-specific data-center-bridging select	Configure LLDP to send an IEEE 802.1 organizationally specific TLV set in the packet
(lldp-agent)#exit	Exit from LLDP mode.
(config-if)#priority-flow-control mode on	Configure the advertise flag and start sending DCBX TLVs in LLDP messages

### Configuring Priorities and Link Delay Allowance for PFC

#configure terminal	Enter Configure Mode.
(config)#bridge 1 protocol ieee vlan-bridge	Create bridge 1 as an IEEE VLAN-enabled bridge

## Priority-based Flow Control Configuration

(config)#data-center-bridging enable bridge 1	Enables DCB on the bridge
(config)#priority-flow-control enable bridge 1	Enables PFC on the bridge
(config)#interface eth1	Configure interface eth1
(config-if)#switchport	Configure eth1 as a layer 2 port
(config-if)#bridge-group 1	Configure eth1 in bridge group 1
(config-if)#lldp-agent	Enter into LLDP agent mode.
(lldp-agent)#set lldp enable txrx	Configure LLDP for transmit and receive mode on eth1
(lldp-agent)#llldp tlv ieee-8021-org-specific data-center-bridging select	Configure LLDP to send an IEEE 802.1 organizationally specific TLV set in the packet
(lldp-agent)#exit	Exit from LLDP mode.
(config-if)#priority-flow-control mode on	Configure the advertise flag and start sending DCBX TLVs in LLDP messages
(config-if)#priority-flow-control cap 4	Configure the maximum number of PFC priorities
(config-if)#priority-flow-control enable priority 2 4 5	Enable PFC on priorities 2, 4, and 5
(config-if)#priority-flow-control link-delay-allowance 34567	Configure the link delay allowance

## Validation

### 1. Verify the default data set.

```
#sh priority-flow-control statistics bridge 1
bridge : 1
interface pri pause sent      pause received
=====
eth1      0 00                00
eth1      1 00                00
eth1      2 00                00
eth1      3 00                00
eth1      4 00                00
eth1      5 00                00
eth1      6 00                00
eth1      7 00                00
```

```
#sh priority-flow-control details bridge 1
```

```
Admin Configuration
```

```
interface mode advertise willing cap link delay priorities allowance
=====
eth1      on    on    off    4    34567    2 4 5
```

```
Operational Configuration
```

```
-----
interface state cap link delay priorities allowance
=====
eth1      on    4    34567    2 4 5
```

## CHAPTER 2 DCBx Configuration

This chapter show how to configure PFC parameter exchange.

### Topology



Figure 2-35: DCBx Configuration

## Configuring ETS Parameter Exchange

### SW1

#configure terminal	Enter configure mode
(config)#bridge 1 protocol ieee vlan-bridge	Create bridge 1 as an IEEE VLAN-enabled bridge
(config)#data-center-bridging enable bridge 1	Enables DCB on the bridge
(config)#priority-flow-control enable bridge 1	Enables PFC on the bridge
(config)#interface eth1	Configure interface eth1
(config-if)#switchport	Configure eth1 as a layer 2 port
(config-if)#bridge-group 1	Configure eth1 in bridge group 1
(config-if)#lldp-agent	Enter into LLDP agent mode.
(lldp-agent)#set lldp enable txrx	Configure LLDP for transmit and receive mode on eth1
(lldp-agent)#lldp tlv ieee-8021-org- specific data-center-bridging select	Configure LLDP to send an IEEE 802.1 organizationally specific TLV set in the packet
(lldp-agent)#exit	Exit from LLDP mode.
(config-if)#priority-flow-control mode on	Configure the advertise flag and start sending DCBX TLVs in LLDP messages
(config-if)# priority-flow-control cap 4	Configure the maximum number of PFC priorities
(config-if)# priority-flow-control enable priority 2 3 4	Enables PFC on priorities 2,3, and 4
(config-if)# priority-flow-control linkdelay- allowance 34567	Configure the link delay allowance

**SW2**

#configure terminal	Enter configure mode
(config)#bridge 1 protocol ieee vlan-bridge	Create bridge 1 as an IEEE VLAN-enabled bridge
(config)#data-center-bridging enable bridge 1	Enables DCB on the bridge
(config)#priority-flow-control enable bridge 1	Enables PFC on the bridge
(config)#interface eth1	Configure interface eth1
(config-if)#switchport	Configure eth1 as a layer 2 port
(config-if)#bridge-group 1	Configure eth1 in bridge group 1
(config-if)#lldp-agent	Enter into LLDP agent mode.
(lldp-agent)#set lldp enable txrx	Configure LLDP for transmit and receive mode on eth1
(lldp-agent)#lldp tlv ieee-8021-org- specific data-center-bridging select	Configure LLDP to send an IEEE 802.1 organizationally specific TLV set in the packet
(lldp-agent)#exit	Exit from LLDP mode.
(config-if)#priority-flow-control mode auto	Configure the advertise flag and start sending DCBX TLVs in LLDP messages
(config-if)# priority-flow-control cap 4	Configure the maximum number of PFC priorities
(config-if)# priority-flow-control enable priority 2 3 4	Enables PFC on priorities 2,3, and 4
(config-if)# priority-flow-control linkdelay- allowance 34567	Configure the link delay allowance

**Validation**

**SW1**

Verify the data set.

```
OcNOS#sh priority-flow-control details interface xe31
```

```
bridge : 1
priority flow control : on
interface : eth1
```

Admin Configuration

```
-----
mode  advertise willing  cap  link delay  priorities
      allowance
=====
auto  on           on    4    34567      2 3 4
-----
```



## Operational Configuration

```
-----
state cap   link delay  priorities
           allowance
=====
```

```
off   4       34567           2 3 4
```

**SW2**

Verify the data set.

```
OcNOS#sh priority-flow-control details interface xe31
```

```
bridge : 1
priority flow control : on
interface : eth1
```

## Admin Configuration

```
-----
mode  advertise willing  cap   link delay  priorities
           allowance
=====
```

```
on    on           off    4    34567           2 3 4
```

## Operational Configuration

```
-----
state cap   link delay  priorities
           allowance
=====
```

```
on    4       34567           2 3 4
```

## Configuring PFC Parameter Exchange

**SW2**

#configure terminal	Enter configure mode
(config)#bridge 1 protocol ieee vlan-bridge	Create bridge 1 as an IEEE VLAN-enabled bridge
(config)#data-center-bridging enable bridge 1	Enable DCB on the bridge
(config)#priority-flow-control enable bridge 1	Enable PFC on the bridge
(config)#interface eth1	Configure interface eth1
(config-if)#switchport	Configure eth1 as a layer 2 port
(config-if)#bridge-group 1	Configure eth1 in bridge group 1
(config-if)#lldp-agent	Enter into LLDP agent mode.
(lldp-agent)#set lldp enable txrx	Configure LLDP for transmit and receive mode on eth1

## DCBx Configuration

---

(lldp-agent)#lldp tlv-select ieee-8021-org-specific	Configure LLDP to send an IEEE 802.1 organizationally specific TLV set in the packet
(lldp-agent)#exit	Exit from LLDP mode.
(config-if)#priority-flow-control mode on	Configure the advertise flag and start sending DCBx TLVs in LLDP messages
(config-if)#priority-flow-control cap 4	Configure the maximum number of PFC priorities
(config-if)#priority-flow-control enable priority 2 4 5	Enables PFC on priorities 2,4, and 5
(config-if)#priority-flow-control link-delay-allowance 34567	Configure the link delay allowance

## SW1

#configure terminal	Enter configure mode
(config)#bridge 1 protocol ieee vlan-bridge	Create bridge 1 as an IEEE VLAN-enabled bridge
(config)#data-center-bridging enable bridge 1	Enable DCB on the bridge
(config)#priority-flow-control enable bridge 1	Enable PFC on the bridge
(config)#interface eth1	Configure interface eth1
(config-if)#switchport	Configure eth1 as a layer 2 port
(config-if)#bridge-group 1	Configure eth1 in bridge group 1
(config-if)#lldp-agent	Enter into LLDP agent mode.
(lldp-agent)#set lldp enable txrx	Configure LLDP for transmit and receive mode on eth1
(lldp-agent)#lldp tlv-select ieee-8021-org-specific	Configure LLDP to send an IEEE 802.1 organizationally specific TLV set in the packet
(lldp-agent)#exit	Exit from LLDP mode.
(config-if)#priority-flow-control mode on	Configure the advertise flag and start sending DCBx TLVs in LLDP messages
(config-if)#priority-flow-control cap 4	Configure the maximum number of PFC priorities
(config-if)#priority-flow-control enable priority 2 4 5	Enables PFC on priorities 2,4, and 5
(config-if)#priority-flow-control link-delay-allowance 34567	Configure the link delay allowance

---

## Validation

### SW1

Verify the data set.

```
#show priority-flow-control details interface eth1
bridge : 1
priority flow control : on
interface : eth1
```

```
Admin Configuration
mode advertise willing cap link priorities
delay
```

```

=====
                                allowance
=====
on    on          off          4    34567    2 4 5

Operational Configuration
state cap  link          priorities
          delay
          allowance
=====
on    4    34567    2 4 5

```

**SW2**

Verify the data set.

```

#show priority-flow-control details interface eth1
bridge : 1
priority flow control : on
interface : eth1

```

```

Admin Configuration
mode  advertise willing  cap  link          priorities
          delay
          allowance

```

```

=====
==
on    on          off          4    34567    2 4 5

Operational Configuration
state cap  link          priorities
          delay
          allowance
=====
==
on    4    34567    2 4 5

```



## CHAPTER 3 PFC with QoS Configuration

Priority-based Flow Control (PFC) is a way which provides a link-level flow control mechanism that can be controlled independently for each frame priority. The goal of this mechanism is to ensure zero loss(lossless) under congestion in DCB networks.

Quality of Service (QoS) works by default with lossy behaviour, which is required for proper functioning of minimum bandwidth, shaping and scheduling.

The requirement is to support PFC when QoS is enabled, ability to control lossy/lossless setting of port queues

### Topology

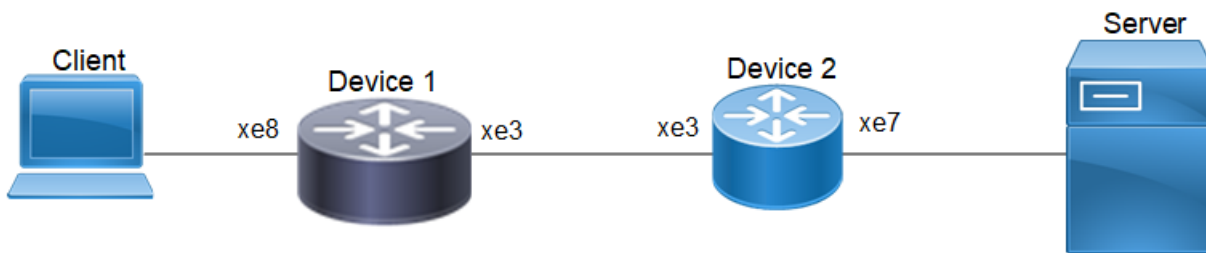

Figure 3-36: PFC with QoS

### PFC with QoS Configuration

PFC + QoS functionality : On setting lossless on queue, traffic should be not be dropped at egress queue and on setting PFC on ingress, pause frames will be generated in order to reduce excess ingress traffic.

### Configuration on Device-1

OcNOS#conf ter	Enter configure mode
OcNOS(config)#hostname Device-1	Configure host name
OcNOS(config)#commit	Commit
Device-1(config)#qos enable	Enable QoS
Device-1(config)#qos statistics	Enable QoS Statistics
Device-1(config)#bridge 1 protocol rstp vlan-bridge	Configure bridge group
Device-1(config)#data-center-bridging enable bridge 1	Enable data-center-bridging
Device-1(config)#priority-flow-control enable bridge 1	Enable priority-flow-control
Device-1(config)#commit	Commit
Device-1(config)#class-map type qos match- all CLASS1	Configure QoS Class-map

Device-1(config-cmap-qos)#match layer4 udp source-port 4791	Define a classification criteria
Device-1(config-cmap-qos)#exit	Exit
Device-1(config)#commit	Commit
Device-1(config)#policy-map type qos POLICY1	Configure QoS Policy-map
Device-1(config-pmap-qos)#class type qos CLASS1	Configure class type and specify the class-map type
Device-1(config-pmap-c-qos)#set queue 4	Setting a new value in the packet Egress queue for matched traffic
Device-1(config-pmap-c-qos)#exit	Exit
Device-1(config-pmap-qos)#commit	Commit
Device-1(config-pmap-qos)#policy-map type queuing default DEFAULTPOLICY	Configure QoS Policy-map
Device-1(config-pmap-que-def)# class type queuing default q0	Configure class type and specify the class-map type
Device-1(config-pmap-c-que-def)# priority	Priority value of class-map attached to this policy-map
Device-1(config-pmap-c-que-def)# exit	Exit
Device-1(config-pmap-que-def)# class type queuing default q4	Configure class type and specify the class-map type
Device-1(config-pmap-c-que-def)# priority	Priority value of class-map attached to this policy-map
Device-1(config-pmap-c-que-def)# lossless	enable lossless settings on egress queue
Device-1(config-pmap-c-que-def)# exit	Exit
Device-1(config-pmap-que-def)#commit	Commit
Device-1(config-pmap-que-def)#exit	Exit
Device-1(config)#interface xe3	Configure Interface
Device-1(config-if)# switchport	Set the switching characteristics of interface
Device-1(config-if)# bridge-group 1	Bridge-group
Device-1(config-if)# switchport mode trunk	Set the mode of L2 interface as trunk
Device-1(config-if)# switchport trunk allowed vlan all	Set the VLAN's to be allowed
Device-1(config-if)# shape rate 100 mbps burst 1000	Configure QoS egress traffic shape
Device-1(config-if)#exit	Exit
Device-1(config)#commit	Commit
Device-1(config)#interface xe8	Configure Interface
Device-1(config-if)# switchport	Set the switching characteristics of interface
Device-1(config-if)# bridge-group 1	Bridge-group
Device-1(config-if)# switchport mode trunk	Set the mode of L2 interface as trunk

Device-1(config-if)# switchport trunk allowed vlan all	Set the VLAN's to be allowed
Device-1(config-if)# priority-flow-control mode on	Set priority-flow-control mode as on
Device-1(config-if)# priority-flow-control enable priority 0 4	Set priority-flow-control mode's priority
Device-1(config-if)#service-policy type qos input POLICY1	Configure QoS service policy
Device-1(config-if)# shape rate 100 mbps burst 1000	Configure QoS egress traffic shape
Device-1(config-if)#exit	Exit
Device-1(config)#commit	Commit

## Configuration on Device-2

OcNOS#conf ter	Enter configure mode
OcNOS(config)#hostname Device-2	Configure host name
OcNOS(config)#commit	Commit
Device-2(config)#qos enable	Enable QOS
Device-2(config)#qos statistics	Enable QOS Statistics
Device-2(config)#bridge 1 protocol rstp vlan-bridge	Configure bridge group
Device-2(config)#data-center-bridging enable bridge 1	Enable data-center-bridging
Device-2(config)#priority-flow-control enable bridge 1	Enable priority-flow-control
Device-2(config)#commit	Commit
Device-2(config)#class-map type qos match-all CLASS1	Configure QOS Class-map
Device-2(config-cmap-qos)#match layer4 udp source-port 4791	Define a classification criteria
Device-2(config-cmap-qos)#exit	Exit
Device-2(config)#commit	Commit
Device-2(config)#policy-map type qos POLICY1	Configure QOS Policy-map
Device-2(config-pmap-qos)#class type qos CLASS1	Configure class type and specify the class-map type
Device-2(config-pmap-c-qos)#set queue 4	Setting a new value in the packet Egress queue for matched traffic

Device-2(config-pmap-c-qos)#exit	Exit
Device-2(config-pmap-qos)#commit	Commit
Device-2(config-pmap-qos)#policy-map type queuing default DEFAULTPOLICY	Configure QoS Policy-map
Device-2(config-pmap-que-def)# class type queuing default q0	Configure class type and specify the class-map type
Device-2(config-pmap-c-que-def)# priority	Priority value of class-map attached to this policy-map
Device-2(config-pmap-c-que-def)# exit	Exit
Device-2(config-pmap-que-def)# class type queuing default q4	Configure class type and specify the class-map type
Device-2(config-pmap-c-que-def)# priority	Priority value of class-map attached to this policy-map
Device-2(config-pmap-c-que-def)# lossless	enable lossless settings on egress queue
Device-2(config-pmap-c-que-def)# exit	Exit
Device-2(config-pmap-que-def)#commit	Commit
Device-2(config)#interface xe3	Configure Interface
Device-2(config-if)# switchport	Set the switching characteristics of interface
Device-2(config-if)# bridge-group 1	Bridge-group
Device-2(config-if)# switchport mode trunk	Set the mode of L2 interface as trunk
Device-2(config-if)# switchport trunk allowed vlan all	Set the VLAN's to be allowed
Device-2(config-if)# shape rate 100 mbps burst 1000	Configure QoS egress traffic shape
Device-2(config-if)#exit	Exit
Device-2(config)#commit	Commit
Device-2(config)#interface xe7	Configure Interface
Device-2(config-if)# switchport	Set the switching characteristics of interface
Device-2(config-if)# bridge-group 1	Bridge-group
Device-2(config-if)# switchport mode trunk	Set the mode of L2 interface as trunk
Device-2(config-if)# switchport trunk allowed vlan all	Set the VLAN's to be allowed
Device-2(config-if)# priority-flow-control mode on	Set priority-flow-control mode as on
Device-2(config-if)# priority-flow-control enable priority 0 4	Set priority-flow-control mode's priority
Device-2(config-if)#service-policy type qos input POLICY1	Configure QoS service policy
Device-2(config-if)# shape rate 100 mbps burst 1000	Configure QoS egress traffic shape
Device-2(config-if)#exit	Exit
Device-2(config)#commit	Commit



---

## Validation

Verify Pause frames Sent

```
Device-2#show priority-flow-control statistics bridge 1  
bridge : 1
```

```
interface pri pause sent      pause received  
=====
```

xe7	0	0	0
xe7	1	0	0
xe7	2	0	0
xe7	3	0	0
xe7	4	100265	0
xe7	5	0	0
xe7	6	0	0
xe7	7	0	0

Verify Pause frames Sent

```
Device-2#show priority-flow-control statistics bridge 1  
bridge : 1
```

```
interface pri pause sent      pause received  
=====
```

xe3	0	0	94731
xe3	1	0	0
xe3	2	0	0
xe3	3	0	0
xe3	4	0	0
xe3	5	0	0
xe3	6	0	0
xe3	7	0	0
xe8	0	181682	0
xe8	1	0	0
xe8	2	0	0
xe8	3	0	0
xe8	4	0	0
xe8	5	0	0
xe8	6	0	0
xe8	7	0	0



# Layer 2 Command Reference



## CHAPTER 1 Fundamental Layer 2 Commands

---

This chapter describes fundamental Layer 2 commands.

- [errdisable cause](#)
- [errdisable link-flap-setting](#)
- [errdisable timeout](#)
- [show errdisable details](#)
- [show interface errdisable status](#)
- [show running-config switch](#)
- [show tcp](#)
- [watch static-mac-movement](#)

---

## errdisable cause

Use this command to globally shut down a port when certain errors happen:

- BPDU guard puts an interface configured for Spanning Tree Protocol (STP) Port Fast into the ErrDisable state upon receipt of a STP BPDU to avoid a potential bridging loop.
- If one side of a link-access group (LAG) is configured as a static LAG and the other side as a dynamic LAG, the ports on the side receiving LACP BPDUs go into the ErrDisable state

Note: When link-flap ErrDisable is enabled globally, then all interfaces are enabled. Link-flap ErrDisable can be enabled globally, but disabled for a specific interface with the `no link-flap errdisable` command.

Use `no` form of this command to not shut down a port when certain errors happen.

### Command Syntax

```
errdisable cause stp-bpdu-guard
no errdisable cause stp-bpdu-guard
errdisable cause {lag-mismatch|link-flap}
no errdisable cause {lag-mismatch|link-flap}
```

### Parameters

<code>stp-bpdu-guard</code>	ErrDisable on stp-bpdu-guard
<code>lag-mismatch</code>	ErrDisable on lag-mismatch
<code>link-flap</code>	ErrDisable on link-flap

### Default

STP-BPDU-Guard is enabled by default on the global level configuration.

### Command Mode

Configure mode

### Applicability

This command was introduced before OcNOS version 1.3.

### Examples

```
#configure terminal
(config)#errdisable cause lag-mismatch
```

---

## errdisable link-flap-setting

Use this command to configure the link-flap errdisable feature:

- An interface should change state as up-down to complete one cycle of a link flap.
- The LED does not glow when an interface is in the errdisable state.
- Errdisable is supported only on physical interfaces.
- A LAG interface does not go into the errdisable state when all of its member ports are in the errdisable state
- The error disable computation is based on a sliding window of time. The window size is configurable in seconds. This window is taken as the current time to the last <t> second, where <t> is the configured window size. If the accumulated link flap count reaches the maximum flap count for a particular sliding window, a link flap error disable fault is triggered.

Note: Any previous flapping accumulated is flushed when you execute this command.

### Command Syntax

```
errdisable link-flap-setting max-flaps <1-100> time <1-1800>
no errdisable link-flap-setting
```

### Parameters

<1-100>	Maximum flap count
<1-1800>	Sliding window size in seconds

### Default

Five flaps in ten seconds:

Maximum flap count: 5

Sliding window size: 10 seconds

### Command Mode

Configure mode

### Applicability

This command was introduced before OcNOS version 1.3.

### Examples

```
#configure terminal
(config)#errdisable link-flap-setting max-flaps 5 time 20
```

---

## errdisable timeout

Use this command to set the ErrDisable auto-recovery timeout interval.

### Command Syntax

```
errdisable timeout interval <10-1000000>  
no errdisable timeout interval
```

### Parameters

<10-1000000> Timeout interval in seconds

### Default

By default, zero: timer is disabled

### Command Mode

Configure mode

### Applicability

This command was introduced before OcNOS version 1.3.

### Examples

```
#configure terminal  
(config)#errdisable timeout interval 1000
```



---

## show errdisable details

Use this command to display ErrDisable settings.

### Command Syntax

```
show errdisable details
```

### Parameters

None

### Default

None

### Command Mode

Exec mode and Privileged Exec mode

### Applicability

This command was introduced before OcNOS version 1.3.

### Example

```
#show errdisable details
```

---

## show interface errdisable status

Use this command to display ErrDisable conditions for an interface.

### Command Syntax

```
show interface errdisable status
```

### Parameters

None

### Default

None

### Command Mode

Exec mode and Privileged Exec mode

### Applicability

This command was introduced before OcNOS version 1.3.

### Example

```
#show interface errdisable status
ge1 lag-mismatch-errdisable
ge2 stp-bpdu-guard-errdisable
```

---

## show running-config switch

Use this command to display the running system switch configuration.

### Command Syntax

```
show running-config switch bridge
show running-config switch dot1x
show running-config switch gmrp
show running-config switch gvrp
show running-config switch lacp
show running-config switch lmi
show running-config switch mstp
show running-config switch radius-server
show running-config switch rpvst+
show running-config switch rstp
show running-config switch ptp
show running-config switch stp
show running-config switch synce
show running-config switch vlan
```

### Parameters

bridge	Display Bridge group information.
dot1x	Display 802.1x port-based authentication information.
gmrp	Display GARP Multicast Registration Protocol (GMRP) information.
gvrp	Display GARP VLAN Registration Protocol (GVRP) information.
lacp	Display Link Aggregation Control Protocol (LACP) information.
lmi	Display Ethernet Local Management Interface Protocol (LMI) information.
mstp	Display Multiple Spanning Tree Protocol (MSTP) information.
radius-server	Display RADIUS server information.
rpvst+	Display Rapid Per-VLAN Spanning Tree (rpvst+) information.
rstp	Display Rapid Spanning Tree Protocol (RSTP) information.
ptp	Display Precision time Protocol (PTP)
stp	Display Spanning Tree Protocol (STP) information.
synce	Display synce information.
vlan	Display values associated with a single VLAN.

### Default

None

## Command Mode

Privileged exec mode, configure mode, router-map mode

## Applicability

This command was introduced before OcNOS version 1.3.

## Example

```
(config)#show running-config switch stp
!  
bridge 6 ageing-time 45  
bridge 6 priority 4096  
bridge 6 max-age 7
```

---

## show tcp

Use this command to display the Transmission Control Protocol (TCP) connections details.

### Command Syntax

```
show tcp
```

### Parameters

None

### Command Mode

Exec mode and privileged exec mode

### Applicability

This command was introduced before OcNOS version 1.3.

### Example

```
#show tcp
Proto Recv-Q Send-Q Local Address          Foreign Address         State
tcp      0      0 0.0.0.0:22            0.0.0.0:*              LISTEN
tcp      0      0 127.0.0.1:25          0.0.0.0:*              LISTEN
tcp      0      1 10.12.44.1:57740      127.0.0.1:705         CLOSE_WAIT
tcp     52      0 10.12.44.21:22        10.12.7.89:705        ESTABLISHED
tcp     85      0 10.12.44.21:57742     10.12.44.21:57738     ESTABLISHED
```

**Table 1: Show tcp output**

Entry	Description
Proto	Protocol – TCP
Recv-Q	Number of TCP packets in the Receive Queue.
Send-Q	Number of TCP packets in the Send-Q.
Local Address and port number	Local IP address and the port number.

**Table 1: Show tcp output (Continued)**

Entry	Description
Foreign Address and port number	Foreign (received) IP address and the port number.
State	Current state of TCP connections: ESTABLISHED SYN_SENT SYN_RECV FIN_WAIT1 FIN_WAIT2 TIME_WAIT CLOSE CLOSE_WAIT LAST_ACK LISTEN CLOSING UNKNOWN

---

## watch static-mac-movement

Use this command to watch if any MAC movement is detected over static MAC entries for a time period. Notification will be displaying if static MAC movement happens before the timer expires.

The counters can be validated with [show interface counters queue-stats](#) for the L2 movement queue (Tx pkts and Dropped pkts columns).

Without enabling `watch static-mac-movement`, the statistics are reflected in the Rx EGR Port Unavail of [show interface counters queue-drop-stats](#).

For VXLAN, `watch static-mac-movement` applies to all the MAC entries learned from the remote peer (remote dynamic or static remote), as these learned MACs are installed as static MAC entries in the hardware.

### Command Syntax

```
watch static-mac-movement (<1-300>|)
```

### Parameters

<1-300>                   Timer value in seconds.

Default

By default, the timer is 10 seconds

### Command Mode

Exec mode

### Applicability

This command was introduced before OcNOS version 1.3.

### Examples

```
#watch static-mac-movement
```





---

## CHAPTER 2 Bridge Commands

---

This chapter provides a description, syntax, and examples of the bridge commands. It includes the following commands:

- `bridge acquire`
- `bridge address`
- `bridge ageing`
- `bridge forward-time`
- `bridge hello-time`
- `bridge mac-priority-override`
- `bridge max-age`
- `bridge max-hops`
- `bridge priority`
- `bridge shutdown`
- `bridge transmit-holdcount`
- `bridge-group`
- `bridge-group path-cost`
- `bridge-group priority`
- `clear allowed-ethertype`
- `clear mac address-table`
- `mac ageing display`
- `show allowed-ethertype`
- `show bridge`
- `show interface switchport`
- `show mac address-table count bridge`
- `show mac address-table bridge`
- `switchport`
- `switchport allowed ethertype`

---

## bridge acquire

Use this command to enable a bridge to learn station location information for an instance. This helps in making forwarding decisions.

Use the `no` parameter with this command to disable learning.

### Command Syntax

```
bridge <1-32> acquire
no bridge <1-32> acquire
```

### Parameter

<1-32>                   Specify the bridge group ID.

### Default

By default, learning is enabled for all instances.

### Command Mode

Configure mode

### Applicability

This command was introduced before OcnOS version 1.3.

### Example

```
#configure terminal
(config)#bridge 3 acquire
(config)#no bridge 3 acquire
```

---

## bridge address

Use this command to add a static forwarding table entry for the bridge.

Use the no parameter with this command to remove the entry for the bridge

### Command Syntax

```
bridge <1-32> address XXXX.XXXX.XXXX (forward|discard) IFNAME
bridge <1-32> address XXXX.XXXX.XXXX (forward|discard) IFNAME vlan <2-4094>
bridge <1-32> address XXXX.XXXX.XXXX (forward|discard) IFNAME vlan <2-4094> svlan
<2-4094>
no bridge <1-32> address XXXX.XXXX.XXXX
no bridge <1-32> address XXXX.XXXX.XXXX vlan <2-4094>
no bridge <1-32> address XXXX.XXXX.XXXX vlan <2-4094> svlan <2-4094>
```

### Parameters

<1-32>	Bridge identifier
XXXX.XXXX.XXXX	Media Access Control (MAC) address in HHHH.HHHH.HHHH format.
forward	Forward matching frames.
discard	Discard matching frames.
IFNAME	Interface on which the frame comes out.
vlan	Identity of the VLAN in the range of <2-4094>.
svlan	Identity of the SVLAN in the range of <2-4094>.

### Default

By default, bridge address is disabled

### Command Mode

Configure mode

### Applicability

This command was introduced before OcNOS version 1.3.

### Example

```
#configure terminal
(config)#bridge 1 address 0000.000a.0021 forward eth0
(config)#no bridge 1 address 0000.000a.0021
```

---

## bridge ageing

Use this command to specify the aging time for a learned MAC address. A learned MAC address persists until this specified time.

Note: The bridge aging time affects the ARP entries which are dependent upon the MAC addresses in hardware. If a MAC address ages out, it causes the corresponding ARP entry to refresh.

Note: On Qumran, the MAC aging time can vary by up to 16%. For example, if the MAC aging time is set to 60 seconds, the aging time can happen anywhere between 50-60 seconds.

Use the `no` form of this command to set the MAC address aging time to its default (300).

### Command Syntax

```
bridge <1-32> ageing-time (0|<10-572>)
bridge <1-32> ageing disable
no bridge <1-32> ageing-time
```

### Parameters

0	Disable Ageing Time
<1-32>	Bridge group ID.
<10-572>	Aging time in seconds.
disable	Turn off MAC address aging completely.

### Default

By default, the aging time is 300 seconds.

### Command Mode

Configure mode

### Applicability

This command was introduced before OcNOS version 1.3.

### Example

```
#configure terminal
(config)#bridge 3 ageing-time 100
(config)#no bridge 3 ageing-time
```

---

## bridge forward-time

Use this command to set the time (in seconds) after which (if this bridge is the root bridge) each port changes states to learning and forwarding. This value is used by all instances.

Use the `no` parameter with this command to restore the default value of 15 seconds.

### Command Syntax

```
bridge <1-32> forward-time <4-30>
no bridge <1-32> forward-time
```

### Parameters

<1-32>                Specify the bridge group ID.  
<4-30>                Specify the forwarding time delay in seconds.

Note: Care should be exercised if the value is to be made below 7 seconds.

### Default

By default, value is 15 seconds

### Command Mode

Configure mode

### Applicability

This command was introduced before OcnOS version 1.3.

### Example

```
#configure terminal
(config)#bridge 3 forward-time 6
(config)#no bridge 3 forward-time
```

---

## bridge hello-time

Use this command to set the hello-time, the time in seconds after which (if this bridge is the root bridge) all the bridges in a bridged LAN exchange Bridge Protocol Data Units (BPDUs). A very low value of this parameter leads to excessive traffic on the network, while a higher value delays the detection of topology change. This value is used by all instances.

Configure the bridge instance name before using this command. The allowable range of values is 1-10 seconds. However, make sure that the value of hello time is always greater than the value of hold time (2 seconds by default).

Use the `no` parameter to restore the default value of the hello time.

Note: A Bridge shall enforce the following relationships for Hello-time, Max-age and Forward-delay.

- $2 \times (\text{Bridge\_Forward\_Delay} - 1.0 \text{ seconds}) \geq \text{Bridge\_Max\_Age}$
- $\text{Bridge\_Max\_Age} \geq 2 \times (\text{Bridge\_Hello\_Time} + 1.0 \text{ seconds})$

Note: Hello-time is allowed only on RSTP, IEEE and Provider-RSTP types of bridges. For MSTP and Provider-MSTP hello timer is restricted.

### Command Syntax

```
bridge <1-32> hello-time <1-10>
no bridge <1-32> hello-time
```

### Parameters

- |        |   |
|--------|---|
| <1-32> | Specify the bridge group ID.                |
| <1-10> | Specify the hello BPDU interval in seconds. |

### Default

By default, value is 2 seconds

### Command Mode

Configure mode

### Applicability

This command was introduced before OcnOS version 1.3.

### Examples

```
#configure terminal
(config)#bridge 3 hello-time 3

(config)#no bridge 3 hello-time
```

---

## bridge mac-priority-override

Use this command to set a MAC priority override.

Use the `no` parameter with this command to unset a MAC priority override.

### Command Syntax

```
bridge <1-32> mac-priority-override mac-address MAC interface IFNAME vlan VLANID
  (static|static-priority-override|static-mgmt|static-mgmt-priority-override)
  priority <0-7>
no bridge <1-32> mac-priority-override mac-address MAC interface IFNAME vlan VLANID
```

### Parameters

<code>&lt;1-32&gt;</code>	Specify the bridge group ID.
<code>mac-address</code>	Enter a MAC address in HHHH.HHHH.HHHH format.
<code>interface</code>	Interface information
<code>vlan</code>	Add the values associated with a single VLAN
<code>static</code>	The MAC is a static entry
<code>static-mgmt</code>	The MAC is a Static Management
<code>static-mgmt-priority-override</code>	The MAC is a Static Management with priority override
<code>static-priority-override</code>	The MAC is a static with priority override
<code>priority</code>	priority <0-7> priority value

### Default

No default address is specified

### Command Mode

Configuration Mode

### Applicability

This command was introduced before OcNOS version 1.3.

### Examples

```
#configure terminal
(config)#bridge 1 mac-priority-override mac-address 1111.1111.1111 interface
eth1 vlan 2 static priority 2

(config)#no bridge 1 mac-priority-override mac-address 1111.1111.1111
interface eth1 vlan 2
```

---

## bridge max-age

Use this command to set the maximum age for a bridge. This value is used by all instances.

Maximum age is the maximum time in seconds for which (if a bridge is the root bridge) a message is considered valid. This prevents the frames from looping indefinitely. The value of maximum age should be greater than twice the value of hello time plus 1, but less than twice the value of forward delay minus 1. The allowable range for max-age is 6-40 seconds. Configure this value sufficiently high, so that a frame generated by root can be propagated to the leaf nodes without exceeding the maximum age.

Use the `no` parameter with this command to restore the default value of the maximum age.

Note: A Bridge shall enforce the following relationships for Hello-time, Max-age and Forward-delay.

- $2 \times (\text{Bridge\_Forward\_Delay} - 1.0 \text{ seconds}) \geq \text{Bridge\_Max\_Age}$
- $\text{Bridge\_Max\_Age} \geq 2 \times (\text{Bridge\_Hello\_Time} + 1.0 \text{ seconds})$

### Command Syntax

```
bridge <1-32> max-age <6-40>
no bridge <1-32> max-age
```

### Parameters

- |        |   |
|--------|---|
| <1-32> | Specify the bridge group ID.  |
| <6-40> | Specify the maximum time, in seconds, to listen for the root bridge <6-40>. |

### Default

By default, bridge maximum age is 20 seconds

### Command Mode

Configure Mode

### Applicability

This command was introduced before OcnOS version 1.3.

### Examples

```
#configure terminal
(config)#bridge 2 max-age 12

(config)#no bridge 2 max-age
```



## bridge max-hops

Use this command to specify the maximum allowed hops for a BPDU in an MST region. This parameter is used by all the instances of the MST. Specifying the maximum hops for a BPDU prevents the messages from looping indefinitely in the network. When a bridge receives an MST BPDU that has exceeded the allowed maximum hops, it discards the BPDU.

Use the `no` parameter with this command to restore the default value.

### Command Syntax

```
bridge <1-32> max-hops <1-40>
no bridge <1-32> max-hops
```

### Parameters

<1-32>	Specify the bridge-group ID.
<1-40>	Specify the maximum hops for which the BPDU will be valid <1-40>.

### Default

By default, maximum hops in an MST region are 20

### Command Mode

Configure mode

### Applicability

This command was introduced before OcnOS version 1.3.

### Examples

```
#configure terminal
(config)#bridge 3 max-hops 25

#configure terminal
(config)#no bridge 3 max-hops
```

---

## bridge priority

Use this command to set the bridge priority for the common instance. Using a lower priority indicates a greater likelihood of the bridge becoming root. The priority values can be set only in increments of 4096.

Use the `no` form of the command to reset it to the default value.

### Command Syntax

```
bridge (<1-32> | ) priority <0-61440>
no bridge (<1-32> | )priority
```

### Parameters

<1-32>	Specify the bridge group ID.
<0-61440>	Specify the bridge priority in the range of <0-61440>.

### Default

By default, priority is 32768 (or hex 0x8000).

### Command Mode

Configure mode

### Applicability

This command was introduced before OcnOS version 1.3.

### Examples

```
#configure terminal
(config)#bridge 2 priority 4096

(config)#no bridge 2 priority
```

---

## bridge shutdown

Use this command to disable a bridge.

Use the `no` parameter to reset the bridge.

### Command Syntax

```
bridge shutdown <1-32>
bridge shutdown <1-32> ((bridge-blocked|bridge-forward) |)
no bridge shutdown <1-32>
```

### Parameters

<1-32>	Specify the bridge group ID.
bridge-forward	Put all ports of the bridge into forwarding state
bridge-blocked	Put all ports of the bridge into blocked state

### Default

No default value is specified

### Command Mode

Configure mode

### Applicability

This command was introduced before OcnOS version 1.3.

### Example

```
#configure terminal
(config)#bridge shutdown 4
(config)#no bridge shutdown 4
```

---

## bridge transmit-holdcount

Use this command to set the maximum number of transmissions of BPDUs by the transmit state machine.

Use the `no` parameter with this command to restore the default transmit hold-count value.

### Command Syntax

```
bridge <1-32> transmit-holdcount <1-10>
no bridge <1-32> transmit-holdcount
```

### Parameters

<1-32>	Specify the bridge group ID.
<1-10>	Transmit hold-count value.

### Default

By default, transmit hold-count is 6

### Command Mode

Configure mode

### Applicability

This command was introduced before OcNOS version 1.3.

### Examples

```
#configure terminal
(config)#bridge 1 transmit-holdcount 5

(config)#no bridge 1 transmit-holdcount
```

## bridge-group

Use this command to bind an interface with a bridge specified by the parameter.

Use the `no` parameter with this command to disable this command.

### Command Syntax

```
bridge-group (<1-32>)  
no bridge-group (<1-32>)
```

### Parameters

<1-32>                    Specify the bridge group ID.

### Default

By default, `bridge-group` is disabled

### Command Mode

Interface mode

### Applicability

This command was introduced before OcnOS version 1.3.

### Examples

```
#configure terminal  
(config)#interface eth1  
(config-if)#bridge-group 2  
  
(config)#interface eth1  
(config-if)#no bridge-group 2
```

---

## bridge-group path-cost

Use this command to set the cost of a path associated with a bridge group. The lower the path cost, the greater the likelihood of the bridge becoming root.

Use the `no` parameter with this command to restore the default priority value.

### Command Syntax

```
bridge-group <1-32> path-cost <1-200000000>
no bridge-group <1-32> path-cost
```

### Parameters

<1-32>	Specify the bridge group ID.
path-cost	Specify the path-cost of a port.
<1-200000000>	Specify the cost to be assigned to the group.

### Default

By default, bridge-group is disabled

### Command Mode

Interface mode

### Applicability

This command was introduced before OcnOS version 1.3.

### Example

```
#configure terminal
(config)#interface eth1
(config-if)#bridge-group 3 path-cost 123

(config-if)#no bridge-group 3 path-cost
```

---

## bridge-group priority

Use this command to set the port priority for a bridge. A lower priority indicates a greater likelihood of the bridge becoming root.

### Command Syntax

```
bridge-group <1-32> priority <0-240>
no bridge-group <1-32> priority
```

### Parameters

<1-32>	Specify the bridge group ID.
<0-240>	Specify the port priority range (a lower priority indicates greater likelihood of the interface becoming a root). The priority values can only be set in increments of 16.

### Default

By default, priority is 1

### Command Mode

Interface mode

### Applicability

This command was introduced before OcnOS version 1.3.

### Example

```
#configure terminal
(config)#interface eth1
(config-if)#bridge-group 4 priority 96

(config)#interface eth1
(config-if)#no bridge-group 4 priority
```

---

## clear allowed-ethertype

Use this command to clear statistics for each ethertype per interfaces.

```
clear allowed-ethertype statistics (IFNAME|)
```

### Parameters

IFNAME                    Interface name.

### Command Mode

Exec mode

### Applicability

This command was introduced before OcNOS version 1.3.

### Example

```
#clear allowed-ethertype statistics xe54/1

#show allowed-ethertype statistics xe54/1
Interface xe54/1
arp: 0 Packets, 0 Bytes
ipv4: 0 Packets, 0 Bytes
ipv6: 0 Packets, 0 Bytes
dropped: 0 Packets, 0 Bytes
```



---

## clear mac address-table

Use this command to clear the filtering database for the bridge. This command can be issued to do the following:

- clear the filtering database
- clear all filtering database entries configured through CLI (static)
- clear all multicast filtering database entries
- clear all multicast filtering database entries for a given VLAN or interface
- clear all dynamic or multicast database entries based on a mac address

### Command Syntax

```
clear mac address-table (dynamic|multicast) bridge <1-32>
clear mac address-table (dynamic|multicast) (address MACADDR | interface IFNAME |
vlan VID ) bridge <1-32>
clear mac address-table (dynamic|multicast) (address MACADDR | interface IFNAME |
vlan VID ) (instance INST) bridge <1-32>
```

### Parameters

dynamic	Clears all dynamic entries.
multicast	Clears all multicast filtering database entries.
address	Clear the specified MAC Address.
MACADDR	When filtering database, entries are cleared based on the MAC address.
bridge	Clears the bridge group ID. Value range is 1-32.
bridge	Clears the bridge group ID. Value range is 1-32.
cvlan	Clears all MAC address for the specified CVLAN. Value range is 1-4094.
svlan	Clears all mac address for the specified SVLAN. Value range is 1-4094.
interface	Clears all MAC address for the specified interface.
bridge	Clears the bridge group ID. Value range is 1-32.
instance	Clears MSTP instance ID. Value range is <1-63>.
vlan	Clears all MAC address for the specified VLAN. Value range is 1-4094.
bridge	Clears the bridge group ID. Value range is 1-32.

### Command Mode

Privileged Exec mode

### Applicability

This command was introduced before OcNOS version 1.3.

### Examples

This example shows how to clear multicast filtering database entries:

```
#clear mac address-table multicast bridge 1
```

This example shows how to clear multicast filtering database entries for a given VLAN.

```
#clear mac address-table multicast vlan 2 bridge 1
```

This example shows how to clear all filtering database entries learned through bridge operation for a given MAC address.

```
#clear mac address-table dynamic address 0202.0202.0202 bridge 1
```

---

## mac ageing display

Use this command to enable the display of remaining age-time value for dynamically learnt mac address.

Note: When the mac ageing display is enabled the following points are applicable .

- a. The mac ageing display should be enabled in non-scaled case (i.e less than 25% of table size) .
- b. High cpu usage will occurs if mac-ageing-display is enabled in scaled case.
- c. When enabled ,the appropriate ageing time for each entry will only be displayed after the first iteration of the ageing thread is complete which starts after 10 seconds of the cli commit .
- d. For mac entries with no active traffic, the age of the entries will be displayed based on the timestamp when the entries were first learnt. if the entries learnt time is greater than the bridge-mac-age-time (default 300secs), the age of the mac entries will be displayed as zero.

Use the `no` form of this command to disable the display of MAC address aging timeout. When disabled the mac-address age will be the bridge-mac-age-time default 300secs.

### Command Syntax

```
mac-ageing-display
no mac-ageing-display
```

### Parameters

None

### Default

By default, mac ageing display is disabled.

### Command Mode

Configure mode

### Applicability

This command was introduced before OcNOS DC Version 5.0.

### Example

```
#configure terminal
(config)#mac-ageing-display
(config)#no mac-ageing-display
```

---

## show allowed-ethertype

Use this command to show allowed and denied traffic statistics.

Note: Dropped slow protocol packets provides the count of slow protocol packets among the total dropped count. Total drop count is fetched from hardware and slow protocol packet count is fetched from software. Hence there can be one or two packet difference.

### Command Syntax

```
show allowed-ethertype statistics (IFNAME|)
```

### Parameters

IFNAME                    Interface name.

### Command Mode

Exec mode

### Applicability

This command was introduced before OcNOS version 1.3.

### Examples

```
#show allowed-ethertype statistics
Interface po1
arp : 0 Packets, 0 Bytes
ipv4 : 511016709 Packets, 184897169366 Bytes
ipv6 : 0 Packets, 0 Bytes
dropped : 220 Packets, 28160 Bytes
dropped slow protocol pkts : lacp 220, efm 0, others 0
Interface xe47
arp : 0 Packets, 0 Bytes
ipv4 : 169763534 Packets, 61427990740 Bytes
ipv6 : 0 Packets, 0 Bytes
dropped : 0 Packets, 0 Bytes
Interface xe48
arp : 0 Packets, 0 Bytes
ipv4 : 0 Packets, 0 Bytes
ipv6 : 0 Packets, 0 Bytes
dropped : 0 Packets, 0 Bytes
```

## show bridge

Use this command to display the filtering database for the bridge. The filtering database is used by a switch to store the MAC addresses that have been learned and which ports that MAC address was learned on.

### Command Syntax

```
show bridge (ieee|rpvst+|mstp|)
```

### Parameters

ieee	STP bridges.
rpvst+	RPVST+ bridges.
mstp	MSTP bridges.

### Command Mode

Exec mode and Privileged Exec mode

### Applicability

This command was introduced before OcnOS version 1.3.

### Example

```
#show bridge
```

Ageout time is global and if something is configured for vxlan then it will be affected here also

Bridge	CVLAN	SVLAN	BVLAN	Port	MAC Address	FWD	Time-out
1	1			eth1	5254.0029.929c	1	0
1	2			eth1	5254.004c.dcc6	1	297
1	1			eth1	5254.004c.dcc6	1	291

[Table 2-1](#) explains the show command output fields.

**Table 2-1: show bridge output fields**

Field	Description
Bridge	Bridge identifier.
VLAN, SVLAN, BVLAN	CVLAN, SVLAN, and BVLAN identifiers.
Port	Interface name.
MAC Address	Learned MAC address.
FWD	Whether frames for the MAC addresses are forwarded.
Time-out	How long the learned MAC address persists.

## show interface switchport

Use this command to display the characteristics of the interface with the current VLAN.

### Command Syntax

```
show interface switchport bridge <1-32>
```

### Parameter

bridge                      Bridge name.

### Command Mode

Exec mode and Privileged Exec mode

### Applicability

This command was introduced before OcNOS version 1.3.

### Example

The following is an output of this command displaying the characteristics of this interface on bridge 2.

```
#show interface switchport bridge 2
Interface name       : eth5
Switchport mode     : access
Ingress filter       : disable
Acceptable frame types : all
Vid swap             : disable
Default vlan         : 2
Configured vlans    :    2
Interface name       : eth4
Switchport mode     : access
Ingress filter       : disable
Acceptable frame types : all
Vid swap             : disable
Default vlan         : 1
Configured vlans    :    1
```

[Table 2-2](#) explains the show command output fields.

**Table 2-2: show interface switchport output fields**

Field	Description
Interface name	Display the name of interface.
Switchport mode	Port that used to connect between switches and access port.
Ingress filter	Ingress filtering examines all inbound packets and then permits or denies entry to the network.
Acceptable frame types	Type of acceptable frame in the interface.
VID swap	Displays the status of the VID swap.

---

**Table 2-2: show interface switchport output fields (Continued)**

<b>Field</b>	<b>Description</b>
Default vlan	Default value for the VLAN.
Configured vlans	Displays the information on configured VLANs.

## show mac address-table count bridge

Use this command to display a count of MAC entries from the filtering database.

### Command Syntax

```
show mac address-table (local|remote) bridge <1-32> ({address MAC | interface
  IFNAME | vlan <1-4094> }|)
```

### Parameter

local	MAC entries learned locally
remote	MAC entries learned from MLAG MAC sync
<1-32>	Bridge group
MAC	MAC address in HHHH.HHHH.HHHH format
IFNAME	Name of the interface
<1-4094>	VLAN identifier

### Command Mode

Exec mode

### Applicability

This command was introduced before OcNOS version 1.3.

### Example

```
#show mac address-table count bridge 1
MAC Entries for all vlans:
Total MAC Addresses in Use: 3
```

[Table 2-3](#) explains the show command output fields.

**Table 2-3: show mac address-table count output fields**

Field	Description
Multicast MAC Address Count	Number of multicast addresses.
Total MAC Addresses	Total number of addresses.



---

## show mac address-table bridge

Use this command to display MAC entries from the filtering database.

### Command Syntax

```
show mac address-table (local|remote) bridge <1-32>({address MAC|interface
  FNAME|vlan <1-4094>}|)
```

```
show mac address-table count bridge <1-32>({(dynamic|multicast|static)|address
  MAC|interface IFNAME|vlan <1-4094>}|)
```

### Parameter

local	MAC entries learned locally
remote	MAC entries learned from MLAG MAC sync
<1-32>	Bridge group
dynamic	Dynamic entries
multicast	Multicast entries
static	Static entries
MAC	MAC address in HHHH.HHHH.HHHH format
IFNAME	Name of the interface
<1-4094>	VLAN identifier

### Command Mode

Exec mode

### Applicability

This command was introduced before OcnOS version 1.3.

### Example

```
#show mac address-table bridge 1 static interface gel4
```

VLAN	MAC Address	Type	Ports
1	3333.3333.3333	static	gel4

```
#show mac address-table bridge 1
```

VLAN	MAC Address	Type	Ports
1	3417.ebf6.0ace	dynamic	po1
1	6400.6a8e.48ab	dynamic	po1
1	a82b.b5b5.c37b	dynamic	po1
200	0000.5e00.0101	dynamic	po1
200	3417.ebf6.0ac5	dynamic	po1
200	3417.ebf6.0ace	dynamic	po1
200	6400.6a8e.48ab	dynamic	po1
200	a82b.b5b5.c375	dynamic	po1
200	a82b.b5b5.c37b	dynamic	po1
800	0000.5e00.0102	dynamic	po1
800	3417.ebf6.0ac5	dynamic	po1

```
800    3417.ebf6.0ace    dynamic    po1
800    6400.6a8e.48ab    dynamic    po1
800    a82b.b5b5.c375    dynamic    po1
800    a82b.b5b5.c37b    dynamic    po1
```

Table 2-4 explains the show command output fields.

**Table 2-4: show mac address-table output fields**

Field	Description
VLAN	VLAN identifier.
MAC Address	Media Access Control address.
Type	Dynamic, multicast, or static.
Ports	Interface name.

---

## switchport

Use this command to set the mode of an interface to switched.

All interfaces are configured routed by default. To change the behavior of an interface from switched to routed, you must explicitly give the `no switchport` command.

Note: When you change the mode of an interface from switched to routed and vice-versa, all configurations for that interface are erased.

Use the `no` form of this command to set the mode to routed.

### Command Syntax

```
switchport
no switchport
```

### Parameters

None

### Default

All interfaces are configured routed by default. To change the behavior of an interface from switched to routed, you must explicitly give the `no switchport` command.

### Command Mode

Interface mode

### Applicability

This command was introduced before OcNOS version 1.3.

### Examples

```
#configure terminal
(config)#interface eth0
(config-if)#switchport

(config)#interface eth0
(config-if)#no switchport
```

---

## switchport allowed ethertype

Use this command to allow a set of ethertype on the access port and deny remaining traffic.

Use the no command to remove ethertype configuration.

### Command Syntax

```
switchport allowed ethertype {arp|ipv4|ipv6|mpls|WORD|log}
no switchport allowed ethertype ({arp|ipv4|ipv6|mpls|WORD|log}|)
```

### Parameters

arp	Ethertype 0x0806.
ipv4	Ethertype 0x0800.
ipv6	Ethertype 0x086dd.
mpls	Ethertype 0x8847.
WORD	Any Ethertype value (0x600 - 0xFFFF).
log	Log unwanted ethertype packets.

### Default

No default value is specified

### Command Mode

Interface mode

### Applicability

This command was introduced before OcNOS version 1.3.

### Examples

```
#configure terminal
(config)#interface xe1
(config-if)#switchport allowed ethertype arp ipv4 ipv6 log

(config-if)#no switchport allowed ethertype ipv4
```

---

## CHAPTER 3 Spanning Tree Protocol Commands

---

This chapter provides a description, syntax, and examples of the Spanning Tree Protocol (STP), Rapid Spanning Tree Protocol (RSTP), Multiple Spanning Tree Protocol (MSTP), and Provider RSTP commands.

- [bridge cisco-interoperability](#)
- [bridge instance](#)
- [bridge instance priority](#)
- [bridge instance vlan](#)
- [bridge multiple-spanning-tree](#)
- [bridge protocol ieee](#)
- [bridge protocol mstp](#)
- [bridge protocol rstp](#)
- [bridge provider-rstp](#)
- [bridge rapid-spanning-tree](#)
- [bridge region](#)
- [bridge revision](#)
- [bridge spanning-tree](#)
- [bridge spanning-tree errdisable-timeout](#)
- [bridge spanning-tree force-version](#)
- [bridge spanning-tree pathcost](#)
- [bridge spanning-tree portfast](#)
- [bridge te-msti](#)
- [bridge te-msti vlan](#)
- [bridge-group instance](#)
- [bridge-group instance path-cost](#)
- [bridge-group instance priority](#)
- [bridge-group path-cost](#)
- [bridge-group priority](#)
- [bridge-group spanning-tree](#)
- [clear spanning-tree detected protocols](#)
- [clear spanning-tree statistics](#)
- [customer-spanning-tree customer-edge path-cost](#)
- [customer-spanning-tree customer-edge priority](#)
- [customer-spanning-tree forward-time](#)
- [customer-spanning-tree hello-time](#)
- [customer-spanning-tree max-age](#)
- [customer-spanning-tree priority](#)
- [customer-spanning-tree provider-edge path-cost](#)
- [customer-spanning-tree provider-edge priority](#)

- `customer-spanning-tree transmit-holdcount`
- `debug mstp`
- `show debugging mstp`
- `show debugging mstp`
- `show debugging mstp`
- `show spanning-tree`
- `show spanning-tree mst`
- `show spanning-tree statistics`
- `snmp restart mstp`
- `spanning-tree autoedge`
- `spanning-tree edgeport`
- `spanning-tree edgeport`
- `spanning-tree guard`
- `spanning-tree instance restricted-role`
- `spanning-tree instance restricted-tcn`
- `spanning-tree link-type`
- `spanning-tree mst configuration`
- `spanning-tree restricted-domain-role`
- `spanning-tree restricted-role`
- `spanning-tree restricted-tcn`
- `spanning-tree te-msti configuration`
- `storm-control`
- `show storm-control`

---

## bridge cisco-interoperability

Use this command to enable/disable Cisco interoperability for MSTP (Multiple Spanning Tree Protocol).

If Cisco interoperability is required, all OcnOS devices in the switched LAN must be Cisco-interoperability enabled. When OcnOS inter operates with Cisco, the only criteria used to classify a region are the region name and revision level. VLAN-to-instance mapping is not used to classify regions when interoperating with Cisco.

### Command Syntax

```
bridge <1-32> cisco-interoperability (enable | disable)
```

### Parameters

<1-32>	Specify the bridge group ID
enable	Enable Cisco interoperability for MSTP bridge
disable	Disable Cisco interoperability for MSTP bridge

### Default

By default, cisco interoperability is disabled.

### Command Mode

Configure mode

### Applicability

This command was introduced before OcnOS version 1.3.

### Examples

To enable Cisco interoperability on a switch for a bridge:

```
#configure terminal
(config)#bridge 2 cisco-interoperability enable
```

To disable Cisco interoperability on a switch for a particular bridge:

```
#configure terminal
(config)#bridge 2 cisco-interoperability disable
```

---

## bridge instance

Use this command to add an MST instance to a bridge.

Use the `no` form of this command to delete an MST instance identifier from a bridge.

### Command Syntax

```
bridge (<1-32>) instance (<1-63>)
no bridge (<1-32>) instance (<1-63>)
```

### Parameters

<1-32>	Bridge identifier.
<1-63>	MST instance identifier.

### Default

The bridge instance default is 1.

### Command Mode

MST configure mode

### Applicability

This command was introduced before OcNOS version 1.3.

### Examples

```
#configure terminal
(config)#bridge 4 protocol mstp
(config)#spanning-tree mst configuration
(config-mst)#bridge 4 instance 3
...
(config-mst)#no bridge 4 instance 3
```



---

## bridge instance priority

Use this command to set the bridge instance priority.

Use the `no` form of this command to reset the priority to its default.

### Command Syntax

```
bridge (<1-32>) instance <1-63> priority <0-61440>
no bridge (<1-32>) instance <1-63> priority
```

### Parameters

<code>&lt;1-32&gt;</code>	Specify the bridge identifier.
<code>&lt;1-63&gt;</code>	Specify the instance identifier.
<code>priority</code>	Specify the bridge priority for the instance. The lower the priority of the bridge, the better the chances is of the bridge becoming a root bridge or a designated bridge for the LAN. The priority values can be set only in increments of 4096. The default value is 32768.
<code>&lt;0-61440&gt;</code>	Specify the bridge priority.

### Default

By default, bridge instance priority is 32768

### Command Mode

Configure mode

### Applicability

This command was introduced before OcnOS version 1.3.

### Examples

```
(config)#bridge 4 instance 3 priority 1
```

## bridge instance vlan

Use this command to simultaneously add multiple VLANs for the corresponding instance of a bridge. The VLANs must be created before being associated with an MST instance (MSTI). If the VLAN range is not specified, the MSTI will not be created.

Use the `no` form of this command to simultaneously remove multiple VLANs for the corresponding instance of a bridge.

### Command Syntax

```
bridge (<1-32>) instance (<1-63>) vlan VLANID
no bridge (<1-32>) instance (<1-63>) vlan VLANID
```

### Parameters

<1-32>	Bridge identifier.
<1-63>	MST instance identifier.
VLANID	VLAN identifier(s) <2-4094>. You can specify a single VLAN, a VLAN range, or a VLAN list.  For a VLAN range, specify two VLAN identifiers: the lowest and then the highest separated by a hyphen. For a VLAN list, specify the VLAN identifiers separated by commas. Do not enter spaces between the hyphens or commas.

### Default

The bridge instance VLAN ID Interfaces default-switch is VLAN100 100 ae0.0 ae1.0 ae2.0.

### Command Mode

MST configure mode

### Applicability

This command was introduced before OcnOS version 1.3.

### Examples

To associate multiple VLANs, in this case VLANs 10 and 20 to instance 1 of bridge 1:

```
#configure terminal
(config)#bridge 1 protocol mstp
(config)#spanning-tree mst configuration
(config-mst)#bridge 1 instance 1 vlan 10,20
```

To associate multiple VLANs, in this case, VLANs 10, 11, 12, 13, 14, and 15 to instance 1 of bridge 1:

```
#configure terminal
(config)#bridge 1 protocol mstp
(config)#spanning-tree mst configuration
(config-mst)#bridge 1 instance 1 vlan 10-15
```

To delete multiple VLANs, in this case, VLANs 10 and 11 from instance 1 of bridge 1:

```
#configure terminal
(config)#bridge 1 protocol mstp
(config)#spanning-tree mst configuration
(config-mst)#no bridge 1 instance 1 vlan 10,11
```

---

## bridge multiple-spanning-tree

Use this command to enable MSTP globally on a bridge.

Use the `no` form of this command to disable MSTP globally on a bridge.

### Command Syntax

```
bridge <1-32> multiple-spanning-tree enable
no bridge <1-32> multiple-spanning-tree enable (bridge-blocked|bridge-forward|)
```

### Parameters

<1-32>	Bridge-group ID.
bridge-blocked	Put ports of the bridge in the blocked state (default).
bridge-forward	Put ports of the bridge in the forwarding state.

### Default

By default, this feature is enabled.

For the `no` form of this command, `bridge-blocked` is the default.

### Command Mode

Configure mode

### Applicability

This command was introduced before OcnOS version 1.3.

### Examples

```
#configure terminal
(config)#bridge 2 multiple-spanning-tree enable

#configure terminal
(config)#no bridge 2 multiple-spanning-tree enable bridge-forward
```

---

## bridge protocol ieee

Use this command to add a IEEE 802.1d Spanning Tree Protocol bridge.

After creating a bridge instance, add interfaces to the bridge using the `bridge-group` command. Bring the bridge instance into operation with the `no shutdown` command in interface mode.

Use the `no` parameter with this command to remove the bridge.

### Command Syntax

```
bridge <1-32> protocol ieee (vlan-bridge|)
no bridge <1-32>
```

### Parameters

<code>&lt;1-32&gt;</code>	Specify the bridge group ID.
<code>vlan-bridge</code>	Specify this as a VLAN-aware bridge.

### Default

The bridge protocol default value is 2 seconds.

### Command Mode

Configure mode

### Applicability

This command was introduced before OcNOS version 1.3.

### Example

```
#configure terminal
(config)#bridge 3 protocol ieee

(config)#bridge 4 protocol ieee vlan-bridge
```

---

## bridge protocol mstp

Use this command to create a multiple spanning-tree protocol (MSTP) bridge of a specified parameter. This command creates an instance of the spanning tree and associates the VLANs specified with that instance.

The MSTP bridges can have different spanning-tree topologies for different VLANs inside a region of “similar” MSTP bridges. The multiple spanning tree protocol, like the rapid spanning tree protocol, provides rapid reconfiguration capability, while providing load balancing ability. A bridge created with this command forms its own separate region unless it is added explicitly to a region using the `region name` command.

Use the `no` parameter with this command to remove the bridge.

### Command Syntax

```
bridge <1-32> protocol mstp
no bridge <1-32>
```

### Parameters

<1-32>                      Specify the bridge group ID.

### Default

The bridge protocol mstp default value is 50 seconds

### Command Mode

Configure mode

### Applicability

This command was introduced before OcnOS version 1.3.

### Examples

```
#configure terminal
(config)#bridge 2 protocol mstp
```

---

## bridge protocol rstp

Use this command to add an IEEE 802.1w Rapid Spanning Tree Protocol (RSTP) bridge.

After creating a bridge instance, add interfaces to the bridge using the `bridge-group` command. Bring the bridge instance into operation with the `no shutdown` command in Interface mode.

Use the `no` parameter with this command to remove the bridge.

### Command Syntax

```
bridge <1-32> protocol rstp
bridge <1-32> protocol rstp (vlan-bridge|)
no bridge <1-32>
```

### Parameters

<code>&lt;1-32&gt;</code>	Specify the bridge group ID.
<code>vlan-bridge</code>	(Optional) Adds a VLAN-aware bridge.

### Default

By default, bridge protocol rstp is enabled

### Command Mode

Configure mode

### Applicability

This command was introduced before OcnOS version 1.3.

### Examples

```
#configure terminal
(config)#bridge 2 protocol rstp

#configure terminal
(config)#bridge 3 protocol rstp vlan-bridge
```

---

## bridge provider-rstp

Use this command to enable Provider Rapid Spanning Tree Protocol (Provider RSTP) globally on a bridge.

Use the `no` form of this command to disable Provider RSTP globally on a bridge.

### Command Syntax

```
bridge <1-32> provider-rstp enable
no bridge <1-32> provider-rstp enable (bridge-blocked|bridge-forward|)
```

### Parameters

<1-32>	Bridge group ID.
bridge-blocked	Put ports of the bridge in the blocked state (default).
bridge-forward	Put ports of the bridge in the forwarding state.

### Default

By default, this feature is enabled.

For the `no` form of this command, `bridge-blocked` is the default.

### Command Mode

Configure mode

### Applicability

This command was introduced in OcNOS version 1.3.

### Examples

```
#configure terminal
(config)#bridge 2 provider-rstp enable

#configure terminal
(config)#no bridge 1 provider-rstp enable bridge-block
```

---

## bridge rapid-spanning-tree

Use this command to enable Rapid Spanning Tree Protocol (RSTP) globally on a bridge.

Use the `no` form of the command to disable RSTP globally on a bridge.

### Command Syntax

```
bridge <1-32> rapid-spanning-tree enable
no bridge <1-32> rapid-spanning-tree enable (bridge-blocked|bridge-forward|)
```

### Parameters

`<1-32>` Bridge group ID.

`bridge-blocked` Put ports of the bridge in the blocked state (default).

`bridge-forward` Put ports of the bridge in the forwarding state.

### Default

By default, this feature is enabled.

For the `no` form of this command, `bridge-blocked` is the default.

### Command Mode

Configure mode

### Applicability

This command was introduced before OcnOS version 1.3.

### Examples

```
#configure terminal
(config)#bridge 2 rapid-spanning-tree enable

#configure terminal
(config)#no bridge 2 rapid-spanning-tree enable bridge-forward
```



---

## bridge region

Use this command to create an MST region and specify its name. MST bridges of a region form different spanning trees for different VLANs.

Use the `no` form of the command to disable the Rapid Spanning Tree protocol on a region.

### Command Syntax

```
bridge <1-32> region REGION_NAME
no bridge <1-32> region
```

### Parameters

<1-32>	Specify the bridge group ID.
REGION_NAME	Specify the name of the region.

### Default

By default, each MST bridge starts with the region name as its bridge address. This means each MST bridge is a region by itself, unless specifically added to one.

### Command Mode

MST configure mode

### Applicability

This command was introduced before OcnOS version 1.3.

### Examples

```
#configure terminal
(config)#spanning-tree mst configuration
(config-mst)#bridge 3 region myRegion

(config)#spanning-tree mst configuration
(config-mst)#no bridge 3 region
```

---

## bridge revision

Use this command to specify the number for configuration information.

### Command Syntax

```
bridge <1-32> revision <0-65535>
```

### Parameters

<1-32>	Specify the bridge group ID in the range of <1-32>.
<0-65535>	Specify a revision number in the range of <0-65535>.

### Default

By default, revision number is 0

### Command Mode

MST configure mode

### Applicability

This command was introduced before OcNOS version 1.3.

### Example

```
#configure terminal
(config)#spanning-tree mst configuration
(config-mst)#bridge 3 revision 25
```

---

## bridge spanning-tree

Use this command to enable Spanning Tree Protocol (STP) globally on a bridge.

Use the `no` form of this command to disable STP globally on the bridge.

### Command Syntax

```
bridge <1-32> spanning-tree enable
no bridge <1-32> spanning-tree enable (bridge-blocked|bridge-forward|)
```

### Parameters

<code>&lt;1-32&gt;</code>	Bridge group ID.
<code>bridge-blocked</code>	Put ports of the bridge in the blocked state (default).
<code>bridge-forward</code>	Put ports of the bridge in the forwarding state.

### Default

By default, this feature is enabled.

For the `no` form of this command, `bridge-blocked` is the default.

### Command Mode

Configure mode

### Applicability

This command was introduced before OcnOS version 1.3.

### Examples

```
#configure terminal
(config)#bridge 2 spanning-tree enable

#configure terminal
(config)#no bridge 2 spanning-tree enable bridge-forward
```

---

## bridge spanning-tree errdisable-timeout

Use this command to enable the error-disable-timeout facility, which sets a timeout for ports that are disabled due to the BPDU guard feature.

The BPDU guard feature shuts down the port on receiving a BPDU on a BPDU-guard enabled port. This command associates a timer with the feature such that the port gets enabled back without manual intervention after a set interval.

Use the `no` parameter to disable the error-disable-timeout facility.

### Command Syntax

```
bridge <1-32> spanning-tree errdisable-timeout enable
bridge <1-32> spanning-tree errdisable-timeout interval <10-1000000>
no bridge <1-32> spanning-tree errdisable-timeout enable
no bridge <1-32> spanning-tree errdisable-timeout interval
```

### Parameters

<code>&lt;1-32&gt;</code>	Specify the bridge group ID.
<code>enable</code>	Enable the timeout mechanism for the port to be enabled back
<code>interval</code>	Specify the interval after which port shall be enabled.
<code>&lt;10-1000000&gt;</code>	Specify the error-disable-timeout interval in seconds.

### Default

By default, the port is enabled after 300 seconds

### Command Mode

Configure mode

### Applicability

This command was introduced before OcNOS version 1.3.

### Examples

```
#configure terminal
(config)#bridge 1 spanning-tree errdisable-timeout enable

#configure terminal
(config)#bridge 4 spanning-tree errdisable-timeout interval 34
```

---

## bridge spanning-tree force-version

Use this command to set the version for the bridge. A version identifier of less than a value of 2 enforces the spanning tree protocol. Although the command supports an input range of 0-4, for RSTP, the valid range is 0-2. When the force-version is set for a bridge, all ports of the bridge have the same spanning tree version set.

Use the `show spanning tree` command to display administratively configured and currently running values of the BPDU filter parameter for the bridge and port (see [show spanning-tree](#)).

Use the `no` parameter with this command to disable the version for the bridge.

### Command Syntax

```
bridge <1-32> spanning-tree force-version <0-4>
no bridge <1-32> spanning-tree force-version
```

### Parameters

<1-32>	Specify the bridge group ID.
force-version	Specify a force version identifier:
0	STP
1	Not supported
2	RSTP
3	MSTP

### Default

By default, spanning tree force version is 0

### Command Mode

Configure mode

### Applicability

This command was introduced before OcNOS version 1.3.

### Examples

Set the value to enforce the spanning tree protocol:

```
#configure terminal
(config)#bridge 1 spanning-tree force-version 0

(config)#no bridge 1 spanning-tree force-version
```

---

## bridge spanning-tree pathcost

Use this command to set a spanning-tree path cost method.

If the short parameter is used, the switch uses a value for the default path cost a number in the range 1 through 65,535. If the long parameter is used, the switch uses a value for the default path cost a number in the range 1 through 200,000,000. Refer to the [show spanning-tree](#) to view the administratively configured and current running pathcost method running on a bridge.

Use the no option with this command to return the path cost method to the default setting.

### Command Syntax

```
bridge <1-32> spanning-tree pathcost method (short|long)
no bridge <1-32> spanning-tree pathcost method
```

### Parameters

<1-32>	Specify the bridge group ID.
method	Method used to calculate default port path cost.
long	Use 16-bit based values for default port path costs.
short	Use 32-bit based values for default port path costs.

### Default

By default, path cost method for STP is short and for MSTP/RSTP is long.

### Command Mode

Configure mode

### Applicability

This command was introduced before OcNOS version 1.3.

### Examples

```
#configure terminal
(config)#bridge 1 spanning-tree pathcost method short

(config)#no bridge 1 spanning-tree pathcost method
```

---

## bridge spanning-tree portfast

Use this command to set the portfast BPDU (Bridge Protocol Data Unit) guard or filter for the bridge.

Use the `show spanning tree` command to display administratively configured and currently running values of the BPDU filter parameter for the bridge and port (see [show spanning-tree](#)).

Use the `no` parameter with this command to disable the BPDU filter for the bridge.

### BPDU Filter

All ports that have their BPDU filter set to default take the same value of BPDU filter as that of the bridge. The Spanning Tree Protocol sends BPDUs from all ports. Enabling the BPDU Filter feature ensures that PortFast-enabled ports do not transmit or receive any BPDUs.

### BPDU Guard

When the BPDU guard feature is set for a bridge, all portfast-enabled ports of the bridge that have the BPDU guard set to default shut down the port on receiving a BPDU. In this case, the BPDU is not processed. You can either bring the port back up manually by using the `no shutdown` command, or configure the `errdisable-timeout` feature to enable the port after the specified time interval.

### Command Syntax

```
bridge <1-32> spanning-tree portfast bpdu-guard
bridge <1-32> spanning-tree portfast bpdu-filter
no bridge <1-32> spanning-tree portfast bpdu-guard
no bridge <1-32> spanning-tree portfast bpdu-filter
```

### Parameters

<1-32>	Specify the bridge group ID.
bpdu-filter	Specify to filter the BPDUs on portfast enabled ports.
bpdu-guard	Specify to guard the portfast ports against BPDU receive.

### Default

By default, portfast for STP is enabled

### Command Mode

Configure mode

### Applicability

This command was introduced before OcnOS version 1.3.

### Example

```
#configure terminal
(config)#bridge 3 spanning-tree portfast bpdu-filter

#configure terminal
(config)#bridge 1 spanning-tree portfast bpdu-guard
```

---

## bridge te-msti

Use this command to enable or disable a Multiple Spanning Tree Instance (MSTI).

The `te-msti` always refers to the MST instance indexed by the pre-defined macro constant `MSTP_TE_MSTID` internally. This is the only MST instance which supports the disabling of spanning trees.

Use the `no` form of this command to remove the configuration.

### Command Syntax

```
bridge (<1-32>) te-msti
no bridge (<1-32>) te-msti
```

### Parameters

<code>&lt;1-32&gt;</code>	Specify the bridge group ID.
<code>te-msti</code>	MSTI to be the traffic engineering MSTI instance.

### Default

By default, bridge `te-msti` is disabled

### Command Mode

TE-MSTI Configure mode

### Applicability

This command was introduced before OcNOS version 1.3.

### Examples

```
#configure terminal
(config)#spanning-tree te-msti configuration
(config-te-msti)#bridge 2 te-msti

(config-te-msti)#no bridge 2 te-msti
```



---

## bridge te-msti vlan

Use this command to enable or disable a Multiple Spanning Tree Instance (MSTI). When an MSTI is shutdown (disabled) each VLAN in the MSTI is set to the forwarding state on all bridge ports which the VLAN as a member of. When and MSTI is enabled (no shutdown), normal MSTP operation is started for the MSTI.

The `te-msti` always refers to the MST instance indexed by the pre-defined macro constant `MSTP_TE_MSTID` internally. This is the only MST instance which supports the disabling of spanning trees. All VLANs that do not want spanning tree topology computation need to be assigned to this `te-msti` instance.

This command is intended for supporting Traffic Engineering (TE) Ethernet tunnels. All VLANs allocated for traffic engineering should be assigned to one MSTI. That MSTI can in turn shutdown the spanning tree operation so that each VLAN path through the network can be manually provisioned.

Use the `no` form of this command to remove the configuration.

### Command Syntax

```
bridge (<1-32>) te-msti vlan <1-4094>
no bridge (<1-32>) te-msti vlan <1-4094>
```

### Parameters

<code>&lt;1-32&gt;</code>	Specify the bridge group ID.
<code>vlan</code>	Specify a VLAN.
<code>&lt;1-4094&gt;</code>	Specify a VLAN identifier to be associated.

Note: This designated instance is defined in 802.1Qay clause 8.9 to be 0xFFE.

### Default

By default, `te-msti vlan` is `vlan1`.

### Command Mode

TE-MSTI Configure mode

### Applicability

This command was introduced before OcnOS version 1.3.

### Examples

```
#configure terminal
(config)#spanning-tree te-msti configuration
(config-te-msti)#bridge 2 te-msti vlan 10
(config-te-msti)#no bridge 2 te-msti vlan 10
```

---

## bridge-group instance

Use this command to assign a Multiple Spanning Tree (MST) instance to a port.

Use the `no` form of this command to remove the interface from the MST instance.

### Command Syntax

```
bridge-group (<1-32>) instance (<1-63> | te-msti)
no bridge-group (<1-32>) instance (<1-63> | te-msti)
```

### Parameters

<1-32>	Bridge identifier.
<1-63>	Multiple spanning tree instance identifier.
spbm	spbm
spbv	spbv
te-msti	Traffic engineering MSTI instance.

### Default

By default, the bridge port remains in the listening and learning states for 15 seconds before transitional to the forwarding state.

### Command Mode

Interface mode

### Applicability

This command was introduced before OcNOS version 1.3.

### Examples

```
#configure terminal
(config)#interface eth0
(config-if)#bridge-group 1
(config-if)#bridge-group 1 instance te-msti
```

---

## bridge-group instance path-cost

Use this command to set a path cost for a multiple spanning tree instance.

Before you can give this command, you must explicitly add an MST instance to a port using the `bridge-group instance` command.

Use the `no` form of this command to set the path cost to its default which varies depending on bandwidth.

### Command Syntax

```
bridge-group (<1-32>) instance <1-63> path-cost <1-200000000>
no bridge-group (<1-32>) instance <1-63> path-cost
```

### Parameters

<1-32>	Bridge identifier.
<1-63>	Set the MST instance identifier.
<1-200000000>	Path cost for a port (a lower path cost means greater likelihood of becoming root).

### Default

Assuming a 10 Mb/s link speed, the default value is 200,000.

### Command Mode

Interface mode

### Applicability

This command was introduced before OcnOS version 1.3.

### Example

```
#configure terminal
(config)#spanning-tree mst configuration
(config-mst)#bridge 4 instance 3 vlan 3
(config-mst)#exit
(config)#interface eth1
(config-if)#bridge-group 4 instance 3
(config-if)#bridge-group 4 instance 3 path-cost 1000
```

---

## bridge-group instance priority

Use this command to set the priority of a multiple spanning tree instance.

The Multiple Spanning Tree Protocol uses port priority as a tiebreaker to determine which port should forward frames for a particular instance on a LAN, or which port should be the root port for an instance. A lower value implies a better priority. In the case of the same priority, the interface index will serve as the tiebreaker, with the lower-numbered interface being preferred over others.

### Command Syntax

```
bridge-group (<1-32>) instance (<1-63>) priority <0-240>
no bridge-group (<1-32>) instance (<1-63>) priority
```

### Parameters

<1-32>	Bridge identifier.
<1-63>	Multiple spanning tree instance identifier.
<0-240>	Port priority. A lower value means greater likelihood of becoming root. Set the port priority in increments of 16.

### Default

By default, the port priority is 128

### Command Mode

Interface mode

### Applicability

This command was introduced before OcNOS version 1.3.

### Example

```
(config)#interface eth2
(config-if)#bridge-group 2
(config-if)#bridge-group 2 instance 4
(config-if)#bridge-group 2 instance 4 priority 64
```

---

## bridge-group path-cost

Use this command to set the cost of a path. Before you can use this command to set a path-cost in a VLAN configuration, you must explicitly add an MST instance to a port using the `bridge-group instance` command.

Use the `no` parameter with this command to restore the default cost value of the path which varies depending on the bandwidth.

### Command Syntax

```
bridge-group <1-32> path-cost <1-200000000>
no bridge-group <1-32> path-cost
```

### Parameters

<code>&lt;1-32&gt;</code>	Specify the bridge group ID.
<code>path-cost</code> <code>&lt;1-200000000&gt;</code>	Specify the cost of path for a port. Specify the cost of the path (a lower cost means a greater likelihood of the interface becoming root).

### Default

Assuming a 10 Mb/s link speed, the default value is 200,000.

### Command Mode

Interface mode

### Applicability

This command was introduced before OcnOS version 1.3.

### Examples

```
#configure terminal
(config)#spanning-tree mst configuration
(config-mst)#bridge 4 instance 3 vlan 3
(config-mst)#exit
(config)#interface eth1
(config-if)#bridge-group 4
(config-if)#bridge-group 4 path-cost 1000
```

---

## bridge-group priority

Use this command to set the port priority for a bridge group.

The Multiple Spanning Tree Protocol uses port priority as a tiebreaker to determine which port should forward frames for a particular instance on a LAN, or which port should be the root port for an instance. A lower value implies a better priority. In the case of the same priority, the interface index will serve as the tiebreaker, with the lower-numbered interface being preferred over others.

### Command Syntax

```
bridge-group (<1-32>) priority <0-240>
no bridge-group (<1-32>) priority
```

### Parameters

<1-32>	Specify the bridge group ID.
<0-240>	Specify the port priority (a lower priority indicates greater likelihood of the interface becoming a root). The priority values can only be set in increments of 16.

### Default

By default, port priority for each instance is 128

### Command Mode

Interface mode

### Applicability

This command was introduced before OcNOS version 1.3.

### Example

```
#configure terminal
(config)#interface eth0
(config-if)#bridge-group 4 priority 80
```

---

## bridge-group spanning-tree

Use this command to enable or disable spanning-tree on an interface.

### Command Syntax

```
bridge-group <1-32> spanning-tree (disable|enable)
```

### Parameters

<1-32>	Bridge group ID.
disable	Disable spanning tree on the interface.
enable	Enable spanning tree on the interface.

### Default

By default, spanning-tree is enabled

### Command Mode

Interface mode

### Applicability

This command was introduced before OcnOS version 1.3.

### Example

```
(config)#interface eth1  
(config-if)#bridge-group 1 spanning-tree enable
```

---

## clear spanning-tree detected protocols

Use this command to clear the detected protocols for a specific bridge or interface. This command begins the port migration as per IEEE 802.1w-2001, Section 17.26. After issuing this command, the migration timer is started on the port, only if the force version is RSTP or MSTP (greater versions of RSTP).

### Command Syntax

```
clear spanning-tree detected protocols bridge <1-32>
```

### Parameters

<1-32>                      Specify the bridge group ID.

### Command Mode

Exec mode and Privileged Exec mode

### Applicability

This command was introduced before OcNOS version 1.3.

### Example

```
#clear spanning-tree detected protocols bridge 2
```



---

## clear spanning-tree statistics

Use this command to clear all STP BPDU statistics.

### Command Syntax

```
clear spanning-tree statistics bridge <1-32>
clear spanning-tree statistics interface IFNAME (instance (<1-63>)| vlan <1-4094>)
  bridge <1-32>
clear spanning-tree statistics (interface IFNAME| (instance (<1-63>)| vlan <2-
  4094>)) bridge <1-32>
```

### Parameters

<1-32>	Specify the bridge identifier.
IFNAME	Specify the name of the interface on which protocols have to be cleared.
<1-63>	MST instance ID.
<1-4094>	VLAN identifier where spanning tree is located <2-4094>

### Command Mode

Exec mode and Privileged Exec mode

### Applicability

This command was introduced before OcNOS version 1.3.

### Example

```
#clear spanning-tree statistics bridge 32
```

---

## customer-spanning-tree customer-edge path-cost

Use this command to set the cost of a path associated with a customer edge port on a customer edge spanning tree.

Use the `no` form of this command to remove the cost of a path associated with a customer edge port on a customer edge spanning tree.

### Command Syntax

```
customer-spanning-tree customer-edge path-cost <1-200000000>
no customer-spanning-tree customer-edge path-cost
```

### Parameters

<code>path-cost</code>	Specify the path-cost of a port.
<code>&lt;1-200000000&gt;</code>	Specify the cost to be assigned to the group.

### Default

Assuming a 10 Mb/s link speed, the default value is 200,000

### Command Mode

Interface mode

### Applicability

This command was introduced before OcNOS version 1.3.

### Example

```
#configure terminal
(config)#interface eth1
(config-if)#customer-spanning-tree customer-edge path-cost 1000
```

---

## customer-spanning-tree customer-edge priority

Use this command to set the port priority for a customer-edge port in the customer spanning tree.

### Command Syntax

```
customer-spanning-tree customer-edge priority <0-240>
```

### Parameters

priority	Specify the port priority.
<0-240>	Specify the port priority range (a lower priority indicates greater likelihood of the interface becoming a root). The priority values can only be set in increments of 16.

### Default

By default, priority is 1

### Command Mode

Interface mode

### Applicability

This command was introduced before OcnOS version 1.3.

### Example

```
#configure terminal
(config)#interface eth1
(config-if)#customer-spanning-tree customer-edge priority 100
```

---

## customer-spanning-tree forward-time

Use this command to set the time (in seconds) after which (if this bridge is the root bridge) each port changes states to learning and forwarding. This value is used by all instances.

Use the `no` form of this command to restore the default value of 15 seconds.

### Command Syntax

```
customer-spanning-tree forward-time <4-30>
no customer-spanning-tree forward-time
```

### Parameters

<4-30> Specify the forwarding time delay in seconds.

Note: Care should be exercised if the value is set to less than 7 seconds.

### Default

By default, priority is 15 seconds

### Command Mode

Interface mode

### Applicability

This command was introduced before OcnOS version 1.3.

### Examples

```
#configure terminal
(config)#interface eth1
(config-if)#customer-spanning-tree forward-time 6

(config-if)#no customer-spanning-tree forward-time
```

---

## customer-spanning-tree hello-time

Use this command to set the hello-time, the time in seconds after which (if this bridge is the root bridge) all the bridges in a bridged LAN exchange Bridge Protocol Data Units (BPDUs). Avoid a very low value of this parameter as this can lead to excessive traffic on the network; a higher value delays the detection of topology change. This value is used by all instances.

Use the `no` option with this command to restore the default value of the hello-time.

### Command Syntax

```
customer-spanning-tree hello-time <1-10>
no customer-spanning-tree hello-time
```

### Parameters

<1-10>                      Specify the hello BPDU interval in seconds.

### Default

By default, level is 2 seconds

### Command Mode

Interface mode

### Applicability

This command was introduced before OcnOS version 1.3.

### Examples

```
#configure terminal
(config)#interface eth1
(config-if)#customer-spanning-tree hello-time 3

(config-if)#no customer-spanning-tree hello-time
```

---

## customer-spanning-tree max-age

Use this command to set the max-age for a bridge.

Max-age is the maximum time in seconds for which (if a bridge is the root bridge) a message is considered valid. This prevents the frames from looping indefinitely. The value of max-age should be greater than twice the value of hello-time plus one, but less than twice the value of forward delay minus one. The allowable range for max-age is 6-40 seconds. Configure this value sufficiently high, so that a frame generated by a root can be propagated to the leaf nodes without exceeding the max-age.

Use the `no` parameter with this command to restore the default value of max-age.

### Command Syntax

```
customer-spanning-tree max-age <6-40>
no customer-spanning-tree max-age
```

### Parameters

<6-40>                    Specify the maximum time in seconds to listen for the root bridge.

### Default

By default, bridge max-age is 20 seconds

### Command Mode

Interface mode

### Applicability

This command was introduced before OcnOS version 1.3.

### Examples

```
#configure terminal
(config)#interface eth1
(config-if)#customer-spanning-tree max-age 12

(config-if)#no customer-spanning-tree max-age
```

---

## customer-spanning-tree priority

Use this command to set the bridge priority for the spanning tree on a customer edge port. Using a lower priority indicates a greater likelihood of the bridge becoming root. This command must be used to set the priority of the customer spanning tree running on the customer edge port.

Use the `no` form of the command to reset it to the default value.

### Command Syntax

```
customer-spanning-tree priority <0-61440>
no customer-spanning-tree priority
```

### Parameters

<0-61440> Specify the bridge priority in the range <0-61440>. Priority values can be set only in increments of 4096.

### Default

By default, priority is 61440

### Command Mode

Interface mode

### Applicability

This command was introduced before OcnOS version 1.3.

### Examples

```
#configure terminal
(config)#interface eth1
(config-if)#customer-spanning-tree priority 4096

(config-if)#no customer-spanning-tree priority
```

---

## customer-spanning-tree provider-edge path-cost

Use this command to set the cost of a path associated with a provider edge port on a customer edge spanning tree.

Use the `no` form of this command to remove the cost of a path associated with a provider edge port on a customer edge spanning tree.

### Command Syntax

```
customer-spanning-tree provider-edge svlan <1-4094> path-cost <1-200000000>
no customer-spanning-tree provider-edge svlan <1-4094> path-cost
```

### Parameters

<1-4094> Specify the SVLAN identifier of provider edge port.  
<1-200000000> Specify the cost to be assigned to the group.

### Default

Assuming a 10 Mb/s link speed, the default value is 200,000

### Command Mode

Interface mode

### Applicability

This command was introduced before OcnOS version 1.3.

### Examples

```
#configure terminal
(config)#interface eth1
(config-if)#customer-spanning-tree provider-edge svlan 2 path-cost 1000

(config-if)#no customer-spanning-tree provider-edge svlan 2 path-cost
```



---

## customer-spanning-tree provider-edge priority

Use this command to set the port priority for a provider-edge port in the customer spanning tree.

### Command Syntax

```
customer-spanning-tree provider-edge svlan <1-4094> priority <0-240>
```

### Parameters

<1-4094>	Specify the SVLAN identifier of provider edge port.
<0-240>	Specify the port priority (a lower priority means greater likelihood of the interface becoming root). The priority values can only be set in increments of 16.

### Default

By default, priority is 1

### Command Mode

Interface mode

### Applicability

This command was introduced before OcnOS version 1.3.

### Example

```
#configure terminal
(config)#interface eth1
(config-if)#customer-spanning-tree provider-edge svlan 2 priority 0
```

---

## customer-spanning-tree transmit-holdcount

Use this command to set the transmit-holdcount for a bridge.

Use the `no` parameter with this command to restore the default value of `transmit-holdcount`.

### Command Syntax

```
customer-spanning-tree transmit-holdcount <1-10>
no customer-spanning-tree transmit-holdcount
```

### Parameters

`<1-10>` Specify the maximum number that can be transmitted per second.

### Default

By default, bridge transmit hold count is 6

### Command Mode

Interface mode

### Applicability

This command was introduced before OcNOS version 1.3.

### Examples

```
#configure terminal
(config)#interface eth1
(config-if)#customer-spanning-tree transmit-holdcount 3

(config-if)#no customer-spanning-tree transmit-holdcount
```

---

## debug mstp

Use this command to turn on, and turn off, debugging and echoing data to the console, at various levels.

Note: This command enables MSTP, RSTP, and STP debugging.

Use the `no` parameter with this command to turn off debugging.

### Command Syntax

```
debug mstp all
debug mstp cli
debug mstp packet rx
debug mstp packet tx
debug mstp protocol
debug mstp protocol detail
debug mstp timer
debug mstp timer detail
no debug mstp all
no debug mstp cli
no debug mstp packet rx
no debug mstp packet tx
no debug mstp protocol
no debug mstp protocol detail
no debug mstp timer
no debug mstp timer detail
```

### Parameters

<code>all</code>	Echoes all spanning-tree debugging levels to the console.
<code>cli</code>	Echoes spanning-tree commands to the console.
<code>packet</code>	Echoes spanning-tree packets to the console.
<code>rx</code>	Received packets.
<code>tx</code>	Transmitted packets.
<code>protocol</code>	Echoes protocol changes to the console.
<code>detail</code>	Detailed output.
<code>timer</code>	Echoes timer start to the console.
<code>detail</code>	Detailed output.

### Command Mode

Exec, Privileged Exec, and Configure modes

### Applicability

This command was introduced before OcNOS version 1.3.

### Examples

```
#configure terminal
(config)#debug mstp all
(config)#debug mstp cli
(config)#debug mstp packet rx
(config)#debug mstp protocol detail
(config)#debug mstp timer
```

---

## show debugging mstp

Use this command to display the status of debugging of the MSTP system.

### Command Syntax

```
show debugging mstp
```

### Parameters

None

### Command Mode

Exec mode and Privileged Exec mode

### Applicability

This command was introduced before OcNOS version 1.3.

### Examples

```
#show debugging mstp
MSTP debugging status:
MSTP debugging status:
MSTP timer debugging is on
MSTP protocol debugging is on
MSTP detailed protocol debugging is on
MSTP cli echo debugging is on
MSTP transmitting packet debugging is on
MSTP receiving packet debugging is on
#
```

---

## show spanning-tree

Use this command to show the state of the spanning tree for all STP or RSTP bridge-groups, including named interface and VLANs.

### Command Syntax

```
show spanning-tree
show spanning-tree interface IFNAME
show spanning-tree mst
show spanning-tree mst config
show spanning-tree mst interface IFNAME
show spanning-tree mst detail
show spanning-tree mst detail interface IFNAME
show spanning-tree mst instance (<1-63>) interface IFNAME
show spanning-tree mst instance (<1-63> | te-msti)
show spanning-tree statistics bridge <1-32>
show spanning-tree statistics interface IFNAME (instance (<1-63>) | vlan <2-4094>)
  bridge <1-32>
show spanning-tree statistics (interface IFNAME | (instance (<1-63>) | vlan <1-
  4094>)) bridge <1-32>
show spanning-tree vlan range-index
```

### Parameters

interface	Display interface information
mst	Display MST information
statistics	Display statistics of the BPDUs
vlan range-index	Display a VLAN range-index value
config	Display configuration information
detail	Display detailed information
instance	Display instance information
<1-63>	Specify the instance identifier
te-msti	Display Traffic Engineering MSTI instance
<1-32>	Specify the bridge identifier
IFNAME	Display the interface name
<2-4094>	Specify a VLAN identifier, associated with the instance

### Command Mode

Exec mode and Privileged Exec mode

## Applicability

This command was introduced before OcnOS version 1.3.

## Example

The following is a sample output of this command displaying spanning tree information.

```
#show spanning-tree
% 1: Bridge up - Spanning Tree Enabled
% 1: Root Path Cost 0 - Root Port 0 - Bridge Priority 32768
% 1: Forward Delay 15 - Hello Time 2 - Max Age 20
% 1: Root Id 80000002b328530a
% 1: Bridge Id 80000002b328530a
% 1: last topology change Wed Nov 19 22:39:18 2008
% 1: 11 topology change(s) - last topology change Wed Nov 19 22:39:18 2008
% 1: portfast bpdu-filter disabled
% 1: portfast bpdu-guard disabled
% 1: portfast errdisable timeout disabled
% 1: portfast errdisable timeout interval 300 sec
%eth2: Ifindex 5 - Port Id 8005 - Role Designated - State Forwarding
%eth2: Designated Path Cost 0
%eth2: Configured Path Cost 200000 - Add type Explicit ref count 1
%eth2: Designated Port Id 8005 - Priority 128 -
%eth2: Root 80000002b328530a
%eth2: Designated Bridge 80000002b328530a
%eth2: Message Age 0 - Max Age 20
%eth2: Hello Time 2 - Forward Delay 15
%eth2: Forward Timer 0 - Msg Age Timer 0 - Hello Timer 1 - topo change timer 0
%eth2: forward-transitions 4
%eth2: Version Rapid Spanning Tree Protocol - Received RSTP - Send RSTP
%eth2: No portfast configured - Current portfast off
%eth2: portfast bpdu-guard default - Current portfast bpdu-guard off
%eth2: portfast bpdu-filter default - Current portfast bpdu-filter off
%eth2: no root guard configured- Current root guard off
%eth2: Configured Link Type point-to-point - Current point-to-point
%eth1: Ifindex 4 - Port Id 8004 - Role Designated - State Forwarding
%eth1: Designated Path Cost 0
%eth1: Configured Path Cost 200000 - Add type Explicit ref count 1
%eth1: Designated Port Id 8004 - Priority 128 -
%eth1: Root 80000002b328530a
%eth1: Designated Bridge 80000002b328530a
%eth1: Message Age 0 - Max Age 20
%eth1: Hello Time 2 - Forward Delay 15
%eth1: Forward Timer 0 - Msg Age Timer 0 - Hello Timer 1 - topo change timer 0
%eth1: forward-transitions 4
%eth1: Version Rapid Spanning Tree Protocol - Received None - Send RSTP
%eth1: No portfast configured - Current portfast off
%eth1: portfast bpdu-guard default - Current portfast bpdu-guard off
%eth1: portfast bpdu-filter default - Current portfast bpdu-filter off
%eth1: no root guard configured- Current root guard off
%eth1: Configured Link Type point-to-point - Current point-to-point
%
%
```

The following is a sample output of this command displaying the state of the spanning tree for interface eth1.

```
#show spanning-tree interface eth1
```

```

% 1: Bridge up - Spanning Tree Enabled
% 1: Root Path Cost 0 - Root Port 0 - Bridge Priority 32768
% 1: Forward Delay 15 - Hello Time 2 - Max Age 20
% 1: Root Id 80000002b328530a
% 1: Bridge Id 80000002b328530a
% 1: last topology change Wed Nov 19 22:39:18 2008
% 1: 11 topology change(s) - last topology change Wed Nov 19 22:39:18 2008
% 1: portfast bpdu-filter disabled
% 1: portfast bpdu-guard disabled
% 1: portfast errdisable timeout disabled
% 1: portfast errdisable timeout interval 300 sec
% eth1: Ifindex 4 - Port Id 8004 - Role Designated - State Forwarding
% eth1: Designated Path Cost 0
% eth1: Configured Path Cost 200000 - Add type Explicit ref count 1
% eth1: Designated Port Id 8004 - Priority 128 -
% eth1: Root 80000002b328530a
% eth1: Designated Bridge 80000002b328530a
% eth1: Message Age 0 - Max Age 20
% eth1: Hello Time 2 - Forward Delay 15
% eth1: forward-transitions 4
% eth1: Version Rapid Spanning Tree Protocol - Received None - Send RSTP
% eth1: No portfast configured - Current portfast off
% eth1: portfast bpdu-guard default - Current portfast bpdu-guard off
% eth1: portfast bpdu-filter default - Current portfast bpdu-filter off
% eth1: no root guard configured- Current root guard off

```

[Table 3-5](#) Explains the show command output fields.

**Table 3-5: show spanning-tree interface output fields**

**Table 3-6:**

Field	Description
Bridge up	A network bridge is a computer networking device that creates a single aggregate network from multiple communication networks or network segments.
Root Path Cost	Root cost for the interface.
Root Port	Interface that is the current elected root port for this bridge.
Bridge Priority	Used for the common instance.
Forward Delay	Configured time an STP bridge port remains in the listening and learning states before transitioning to the forwarding state.
Hello Time	Configured number of seconds between transmissions of configuration BPDUs.
Max Age	Maximum age of received protocol BPDUs.
Port Id	Logical interface identifier configured to participate in the MSTP instance.
Role Designated	Designated role for the packets in the interface.
State Forwarding	State of the forwarding packets in the interface.
Designated Path Cost	Designated cost for the interface.



**Table 3-6:**

<b>Field</b>	<b>Description</b>
Configured Path Cost	Configured cost for the interface.
Designated Port Id	Port ID of the designated port for the LAN segment this interface is attached to.
Priority	Specify the port priority.
Message Age	Number of seconds elapsed since the most recent BPDU was received.
Forward Timer	The forward delay timer is the time interval that is spent in the listening and learning state.
Msg Age Timer	The message age contains the length of time that has passed since the root bridge initially originated the BPDU.
Received RSTP	Number of times the received the RSTP.
Send RSTP	Number of times transmitted the RSTP.

---

## show spanning-tree mst

Use this command to display the filtering database values. This command displays the number of instances created, and VLANs associated with it.

### Command Syntax

```
show spanning-tree mst
show spanning-tree mst config
show spanning-tree mst detail
show spanning-tree mst detail interface IFNAME
show spanning-tree mst instance (<1-63>) interface IFNAME
show spanning-tree mst instance (<1-63> | te-msti)
show spanning-tree mst interface IFNAME
```

### Parameters

config	Display configuration information.
detail	Display detailed information.
interface	Display interface information.
instance	Display instance information.
<1-63>	Specify the instance identifier.
te-msti	Traffic Engineering MSTI instance.

### Command Mode

Exec mode and Privileged Exec mode

### Applicability

This command was introduced before OcNOS version 1.3.

### Examples

```
#show spanning-tree mst
% 1: Bridge up - Spanning Tree Enabled
% 1: CIST Root Path Cost 0 - CIST Root Port 0 - CIST Bridge
Priority 32768
% 1: Forward Delay 15 - Hello Time 2 - Max Age 20 - Max-hops 20
% 1: CIST Root Id 80000002b328530a
% 1: CIST Reg Root Id 80000002b328530a
% 1: CIST Bridge Id 80000002b328530a
% 1: 2 topology change(s) - last topology change Wed Nov 19 22:43:21 2008
% 1: portfast bpdu-filter disabled
% 1: portfast bpdu-guard disabled
% 1: portfast errdisable timeout disabled
% 1: portfast errdisable timeout interval 300 sec%
% Instance VLAN
% 0:      1
% 2:      3-4
```

Table 3-7 Explains the show command output fields.

**Table 3-7: show spanning-tree mst output fields**

**Table 3-8:**

Field	Description
Bridge up	A network bridge is networking process that creates a single aggregate network from multiple communication networks or network segments.
CIST Root Path Cost	Calculated cost to reach the regional root bridge from the bridge where the command is entered.
CIST Root Port	Interface that is the current elected CIST root port for this bridge.
CIST Bridge	A CIST bridge is networking process that creates a single aggregate network from multiple communication networks.
Priority	Specify the port priority.
Forward Delay	Configured time an STP bridge port remains in the listening and learning states before transitioning to the forwarding state.
Hello Time	Configured number of seconds between transmissions of configuration BPDUs.
Max Age	Maximum age of received protocol BPDUs.
Max-hops	Configured maximum number of hops a BPDU can be forwarded in the MSTP region.

---

## show spanning-tree statistics

Use this command to display detailed BPDU statistics for a spanning tree instance.

### Command Syntax

```
show spanning-tree statistics bridge <1-32>
show spanning-tree statistics interface IFNAME (instance (<1-63>)| vlan <2-4094>)
  bridge <1-32>
show spanning-tree statistics (interface IFNAME | (instance (<1-63>) | vlan <1-
  4094>)) bridge <1-32>
```

### Parameters

<1-32>	Bridge identifier.
<1-63>	MST instance identifier.
IFNAME	Displays the interface name.
<2-4094>	Specify a VLAN identifier, associated with the instance.

### Command Mode

Exec mode and Privileged Exec mode

### Applicability

This command was introduced before OcNOS version 1.3.

### Example

In the following example, bridge-group 1 is configured for IEEE on the eth2 interface.

```
#show spanning-tree statistics interface eth2 bridge 1

% BPDU Related Parameters
% -----
% Port Spanning Tree           : Enable
% Spanning Tree Type           : Spanning Tree Protocol
% Current Port State           : Learning
% Port ID                       : 8004
% Port Number                   : 4
% Path Cost                     : 200000
% Message Age                   : 0
% Designated Root               : 00:02:b3:d5:91:ec
% Designated Cost               : 0
% Designated Bridge             : 00:02:b3:d5:91:ec
% Designated Port Id            : 8005
% Top Change Ack                : FALSE
% Configure Pending              : FALSE

% PORT Based Information & Statistics
% -----
% Configure Bpdu's xmitted      : 0
% Configure Bpdu's received     : 22
% TCN Bpdu's xmitted            : 0
```

```

% TCN Bpdu's received          : 8
% Forward Trans Count         : 0

% STATUS of Port Timers
% -----
% Hello Time Configured       : 2
% Hello timer                 : ACTIVE
% Hello Time Value           : 1
% Forward Delay Timer        : ACTIVE
% Forward Delay Timer Value   : 1
% Message Age Timer          : ACTIVE
% Message Age Timer Value    : 19
% Topology Change Timer      : INACTIVE
% Topology Change Timer Value : 0
% Hold Timer                 : INACTIVE
% Hold Timer Value           : 0

% Other Port-Specific Info
% -----
% Max Age Transitions         : 1
% Msg Age Expiry             : 0
% Similar BPDUS Rcvd        : 14
% Src Mac Count              : 0
% Total Src Mac Rcvd        : 15
% Next State                 : Blocked
% Topology Change Time       : 0

% Other Bridge information & Statistics
% -----
% STP Multicast Address      : 01:80:c2:00:00:00
% Bridge Priority            : 32768
% Bridge Mac Address         : 00:02:b3:d5:98:3f
% Bridge Hello Time         : 2
% Bridge Forward Delay      : 15
% Topology Change Initiator  : 0
% Last Topology Change Occurred : Wed Dec 31 16:00:00 1969
% Topology Change           : FALSE
% Topology Change Detected   : FALSE
% Topology Change Count     : 0
% Topology Change Last Recvd from : 00:00:00:00:00:00

```

Table 3-9 Explains the show command output fields.

**Table 3-9: show spanning-tree statistics output fields**

**Table 3-10:**

Field	Description
BPDU Related Parameters	Details of the BPDU related parameters.
PORT Based Information & Statistics	Information of the port and interface for which the statistics are being displayed.

**Table 3-10:**

<b>Field</b>	<b>Description</b>
STATUS of Port Timers	Status of the port timers.
Other Port-Specific Info	Specific information about the port.
Other Bridge information & Statistics	Information about bridge and statistics being displayed.

---

## snmp restart mstp

Use this command to restart SNMP in Multiple Spanning Tree Protocol (MSTP).

### Command Syntax

```
snmp restart mstp
```

### Parameters

None

### Default

No default value is specified

### Command Mode

Configure mode

### Applicability

This command was introduced before OcNOS version 1.3.

### Examples

```
#snmp restart mstp
```

---

## spanning-tree autoedge

Use this command to assist in automatic identification of the edge port.

Use the `no` parameter with this command to disable this feature.

### Command Syntax

```
spanning-tree autoedge
no spanning-tree autoedge
```

### Default

By default, spanning-tree autoedge is disabled

### Parameters

None

### Command Mode

Interface mode

### Applicability

This command was introduced before OcNOS version 1.3.

### Example

```
#configure terminal
(config)#interface eth0
(config-if)#spanning-tree autoedge
```



---

## spanning-tree edgeport

Use this command to set a port as an edge-port and to enable rapid transitions.

Use the `no` parameter with this command to set a port to its default state (not an edge-port) and to disable rapid transitions.

**Note:** This command is an alias to the `spanning-tree portfast` command. Both commands can be used interchangeably.

### Command Syntax

```
spanning-tree edgeport
no spanning-tree edgeport
```

### Default

By default, spanning-tree edgeport is disabled

### Parameters

None

### Command Mode

Interface mode

### Applicability

This command was introduced before OcNOS version 1.3.

### Example

```
#configure terminal
(config)#interface eth0
(config-if)#spanning-tree edgeport
```

---

## spanning-tree guard

Use this command to enable the root guard feature for the port. This feature disables reception of superior BPDUs.

The root guard feature makes sure that the port on which it is enabled is a designated port. If the root guard enabled port receives a superior BPDU, it goes to a Listening state (for STP) or discarding state (for RSTP and MSTP).

Use the `no` parameter with this command to disable the root guard feature for the port.

### Command Syntax

```
spanning-tree guard root
no spanning-tree guard root
```

### Parameters

<code>root</code>	Set to disable reception of superior BPDUs
-------------------	--

### Default

By default, spanning-tree guard root is enabled

### Command Mode

Interface mode

### Applicability

This command was introduced before OcnOS version 1.3.

### Example

```
#configure terminal
(config)#interface eth0
(config-if)#spanning-tree guard root
```

---

## spanning-tree instance restricted-role

Use this command to set the restricted role value for the instance to TRUE.

Use the `no` parameter with this command to set the restricted role value for the instance to FALSE.

### Command Syntax

```
spanning-tree instance <1-63> restricted-role
no spanning-tree instance <1-63> restricted-role
```

### Parameters

<1-63> Specify the instance ID range.

### Default

By default, restricted-role value is FALSE

### Command Mode

Interface mode

### Applicability

This command was introduced before OcnOS version 1.3.

### Example

```
#configure terminal
(config)#interface eth0
(config-if)#spanning-tree instance 2 restricted-role
```

---

## spanning-tree instance restricted-tcn

Use this command to set the restricted TCN value for the instance to TRUE.

### Command Syntax

```
spanning-tree instance <1-63> restricted-tcn
no spanning-tree instance <1-63> restricted
```

### Parameters

<1-63>                    Specify the instance ID range.

### Default

By default, restricted TCN value is FALSE

### Command Mode

Interface mode

### Applicability

This command was introduced before OcnOS version 1.3.

### Example

```
#configure terminal
(config)#interface eth0
(config-if)#spanning-tree instance 2 restricted-tcn
```

---

## spanning-tree link-type

Use this command to enable or disable point-to-point or shared link types.

RSTP has a backward-compatible STP mode, `spanning-tree link-type shared`. An alternative is the `spanning-tree force-version 0`.

Use the `no` parameter with this command to disable rapid transition.

### Command Syntax

```
spanning-tree link-type auto
spanning-tree link-type point-to-point
spanning-tree link-type shared
no spanning-tree link-type
```

### Parameters

<code>auto</code>	Sets to either point-to-point or shared based on duplex state.
<code>point-to-point</code>	Enables rapid transition.
<code>shared</code>	Disables rapid transition.

### Default

By default, `spanning-tree link-type` is enabled.

### Command Mode

Interface mode

### Applicability

This command was introduced before OcNOS version 1.3.

### Examples

```
#configure terminal
(config)#interface eth0
(config-if)#spanning-tree link-type point-to-point

(config-if)#no spanning-tree link-type
```

---

## spanning-tree mst configuration

Use this command to enter the Multiple Spanning Tree Configuration mode.

### Command Syntax

```
spanning-tree mst configuration
```

### Parameters

None

### Default

No default value is specified.

### Command Mode

Configure mode

### Applicability

This command was introduced before OcNOS version 1.3.

### Examples

```
#configure terminal  
(config)#spanning-tree mst configuration  
(config-mst)#
```

---

## spanning-tree bpdu-filter

Use this command to set the BPDU filter value for individual ports. When the `enable` or `disable` parameter is used with this command, this configuration takes precedence over bridge configuration. However, when the `default` parameter is used with this command, the bridge level BPDU filter configuration takes effect for the port.

Use the `show spanning tree` command to display administratively configured and currently running values of the BPDU filter parameter for the bridge and port (see [show spanning-tree](#)).

Use the `no` parameter with this command to revert the port BPDU filter value to default.

### Command Syntax

```
spanning-tree bpdu-filter (enable|disable|default)
no spanning-tree bpdu-filter
```

### Parameters

<code>default</code>	Sets the bpdu-filter to the default level.
<code>disable</code>	Disables the BPDU-filter.
<code>enable</code>	Enables the BPDU-filter.

### Default

By default, `spanning-tree bpdu-filter` is default option

### Command Mode

Interface mode

### Applicability

This command was introduced before OcnOS version 1.3.

### Example

```
#configure terminal
(config)#interface eth0
(config-if)#spanning-tree bpdu-filter enable

(config-if)#no spanning-tree bpdu-filter
```

---

## spanning-tree bpdu-guard

Use this command to enable or disable the BPDU Guard feature on a port.

This command supersedes the bridge level configuration for the BPDU Guard feature. When the `enable` or `disable` parameter is used with this command, this configuration takes precedence over bridge configuration. However, when the `default` parameter is used with this command, the bridge-level BPDU Guard configuration takes effect.

Use the `show spanning tree` command to display administratively configured and currently running values of the BPDU filter parameter for the bridge and port (see [show spanning-tree](#)).

Use the `no` parameter with this command to set the BPDU Guard feature on a port to default.

### Command Syntax

```
spanning-tree bpdu-guard (enable|disable|default)
no spanning-tree bpdu-guard
```

### Parameters

<code>default</code>	Sets the BPDU-guard to the default level.
<code>disable</code>	Disables the BPDU-guard.
<code>enable</code>	Enables the BPDU-guard.

### Default

By default, `spanning-tree bpdu-guard` is default

### Command Mode

Interface mode

### Applicability

This command was introduced before OcnOS version 1.3.

### Example

```
#configure terminal
(config)#interface eth0
(config-if)#spanning-tree bpdu-guard enable

(config-if)#no spanning-tree bpdu-guard
```



---

## spanning-tree restricted-domain-role

Use this command to set the restricted-domain-role value of the port to TRUE.

Use the `no` parameter with this command to set the restricted-domain-role value of the port to FALSE.

### Command Syntax

```
spanning-tree restricted-domain-role
no spanning-tree restricted-domain-role
```

### Parameters

None

### Default

By default, restricted-role value is FALSE

### Command Mode

Interface mode

### Applicability

This command was introduced before OcnOS version 1.3.

### Example

```
#configure terminal
(config)#interface eth0
(config-if)#spanning-tree restricted-domain-role
```

---

## spanning-tree restricted-role

Use this command to set the restricted-role value of the port to TRUE.

Use the `no` parameter with this command to set the restricted-role value of the port to FALSE.

### Command Syntax

```
spanning-tree restricted-role
no spanning-tree restricted-role
```

### Parameters

None

### Default

By default, restricted-role value is FALSE

### Command Mode

Interface mode

### Applicability

This command was introduced before OcNOS version 1.3.

### Example

```
#configure terminal
(config)#interface eth0
(config-if)#spanning-tree restricted-role
```

---

## spanning-tree restricted-tcn

Use this command to set the restricted TCN value of the port to TRUE.

Use the `no` parameter with this command to set the restricted TCN value of the port to FALSE.

### Command Syntax

```
spanning-tree restricted-tcn
no spanning-tree restricted-tcn
```

### Parameters

None

### Default

By default, restricted TCN value is FALSE

### Command Mode

Interface mode

### Applicability

This command was introduced before OcnOS version 1.3.

### Example

```
#configure terminal
(config)#interface eth0
(config-if)#spanning-tree restricted-tcn
```

---

## spanning-tree te-msti configuration

This command is used to put the terminal into the `te-msti` configuration mode.

After creating a bridge instance and adding VLAN to that bridge instance, use this command to enter `te-msti` configuration mode.

### Command Syntax

```
spanning-tree te-msti configuration
```

### Parameters

None

### Default

No default value is specified

### Command Mode

Configure mode

### Applicability

This command was introduced before OcNOS version 1.3.

### Examples

```
#configure terminal
(config)#spanning-tree te-msti configuration
(config-te-msti)#
```

---

## storm-control

Use this command to set the rising threshold level for broadcast, multicast, or destination lookup failure traffic. The storm control action occurs when traffic utilization reaches this level.

Storm control is used to block the forwarding of unnecessary flooded traffic. A packet storm occurs when a large number of broadcast packets are received on a port. Forwarding these packets can cause the network to slow down or time out.

Storm-control is a physical interface property and when configured on port-channel storm-control is applied on each physical member port and therefore the actual value is the configured value multiplied by the number of active member interfaces.

Use the `no` form of this command to disable storm control.

Note: Minimum granularity for storm-control is 64kbps.

Note: Storm Discard notification is sent in case of packet discards but not based on configuration.

### Command Syntax

```
storm-control (broadcast|multicast|dlf) (level LEVEL | <0-4294967294>
(kbps|mbps|gbps))
no storm-control (broadcast|multicast|dlf)
```

### Parameters

<code>broadcast</code>	Broadcast rate limiting.
<code>multicast</code>	Multicast rate limiting.
<code>dlf</code>	Destination lookup failure limiting.
<code>level</code>	Sets the percentage of the threshold.
LEVEL	The percentage of the threshold.
<0-4294967294>	Sets absolute threshold value <0-1000000000>
kbps	specifies the units of Kilobits per second.
mbps	specifies the units of Megabits per second.
gbps	specifies the units of Gigabits per second.
fps	specifies the units of Frames per second.

Note: Use value for absolute threshold value parameter in multiples of 64 kbps. Whether the unit of measure is kbps, mbps, or gbps, the value must be divisible by 64 (such as "99.968 mbps").

### Default

By default, storm control is disabled

### Limitations

Burst option is not supported with rate type "FPS" and FPS cannot be configured along with other types (KBPS,MBPS,GBPS).

### Command Mode

Interface mode

## Applicability

This command was introduced before OcnOS version 1.3.

## Examples

```
#configure terminal
(config)#interface eth0
(config-if)#storm-control broadcast level 30

(config)#interface eth0
(config-if)#storm-control multicast level 30

(config)#interface eth0
(config-if)#storm-control multicast 64 mbps

(config)#interface eth0
(config-if)#no storm-control multicast

OcnOS(config-if)#storm-control multicast 50 kbps
%% Value applicable in hardware is 64.000 kbps

OcnOS(config-if)#storm-control multicast 0 kbps

OcnOS(config-if)#storm-control multicast 64 kbps

OcnOS(config-if)#storm-control multicast 100 kbps
%% Value applicable in hardware is 64.000 kbps

OcnOS(config-if)#storm-control multicast 130 kbps
%% Value applicable in hardware is 128.000 kbps

OcnOS(config-if)#storm-control multicast 130 mbps
%% Value applicable in hardware is 129.984 mbps
(config)#int xe1/1
(config-if)#switchport
(config-if)#storm-control multicast 100 mbps
%% Value applicable in hardware is 99.968 mbps

#show storm-control xe1/1
*The hardware applicable value is displayed
Port          BcastLevel    McastLevel    DlfLevel      Discards
xe1/1         100.0000%     99.968 mbps   100.0000%     0

#show run int xe1/1
!
interface xe1/1
  switchport
  storm-control multicast 100 mbps

(config-if)#int po4
(config-if)#switchport
#show storm-control po4
*The hardware applicable value is displayed
Port          BcastLevel    McastLevel    DlfLevel      Discards
po4           219.968 mbps  100.0000%     100.0000%     0
#
OcnOS#con t
```

```
Enter configuration commands, one per line.  End with CNTL/Z.
OcNOS(config)#int xe64/2
OcNOS(config-if)#switchport
OcNOS(config-if)#bridge-group 1
OcNOS(config-if)#switchport mode trunk
OcNOS(config-if)#switchport trunk allowed vlan add 2
OcNOS(config-if)#storm-control broadcast 1000 fps
OcNOS(config-if)#storm-control multicast 2000 fps
OcNOS(config-if)#storm-control dlf 5000 fps
OcNOS(config-if)#comm
%% Value applicable in hardware is 1000.000 fps

%% Value applicable in hardware is 2000.000 fps

%% Value applicable in hardware is 5000.000 fps

OcNOS(config-if)#end

OcNOS#show runn int xe64/2
!
interface xe64/2
  switchport
  bridge-group 1
  switchport mode trunk
  switchport trunk allowed vlan add 2
  storm-control broadcast 1000 fps
  storm-control multicast 2000 fps
  storm-control dlf 5000 fps
  load-interval 30
!
```

**Note:**

- The warning message appears only for the applicable value in multiples of 64 kbps.
- show running-config command displays the value that was entered by user.
- show storm-control displays the actual configured value. If the configured value is from 1-64 kbps, the configured value is treated as 64, similarly from 100-127 value the configured value is dropped to 64 kbps.
- For example, values configured from
  - 1-64 kbps becomes 64 kbps,
  - 100 kbps becomes 64 kbps,
  - 130 kbps becomes 128 kbps,
  - 200 kbps becomes 192 kbps so on.

---

## show storm-control

Use the command to verify the BUM rate limit configured.

Note: Drop statistics for BUM rate limiting is not supported on Qumran.

### Command Syntax

```
show storm-control (INTERFACE-NAME|)
```

### Example

```
OcNOS#sh storm-control xe2
*The hardware applicable value is displayed
Port          BcastLevel    McastLevel    DlfLevel      Discards
xe2           100.0000%    100.0000%    100.0000%    0
```

```
OcNOS#show storm-control
*The hardware applicable value is displayed
Port  BcastLevel (burst)    McastLevel (burst)    DlfLevel (burst)    Discards
xe64/2 1000.000 fps      2000.000 fps          5000.000 fps        7144132
```







---

## CHAPTER 4 RPVST+ Commands

---

This chapter contains the commands used for Rapid Per VLAN Spanning Tree (RPVST+). RPVST+ enables a bridge to inter-operate with Cisco RPVST+ switches.

RPVST+ uses the Multiple Spanning Tree Protocol (MSTP) with a single VLAN for each Multiple Spanning Tree instance (MSTI). The MST bridges can have different spanning-tree topologies for different VLANs inside a region of similar MST bridges. MSTP, like the Rapid Spanning Tree Protocol (RSTP), provides rapid reconfiguration capabilities and supports load balancing.

This chapter includes the following commands:

- [bridge vlan](#)
- [bridge vlan priority](#)
- [bridge-group vlan](#)
- [bridge protocol rpvst+](#)
- [bridge rapid-pervlan-spanning-tree](#)
- [show spanning-tree rpvst+](#)
- [spanning-tree rpvst+ configuration](#)
- [spanning-tree vlan restricted-role](#)
- [spanning-tree vlan restricted-tcn](#)

---

## bridge vlan

This command creates or deletes a mapping between an MSTI (Multiple Spanning Tree Instance) and a VLAN for RPVST+ operation. There can be only one VLAN per MST instance if the bridge is configured to run in RPVST+ mode.

The VLAN must have already been created. Spanning tree is enabled on each configured VLAN, and one instance of spanning-tree runs on each configured VLAN.

Use the `no` form of the command to disable this functionality.

### Command Syntax

```
bridge <1-32> vlan <2-4094>
no bridge <1-32> vlan <2-4094>
```

### Parameters

<1-32>	Bridge identifier.
<2-4094>	VLAN identifier.

### Command Mode

RPVST+ configure mode

### Applicability

This command was introduced before OcnOS version 1.3.

### Examples

```
#configure terminal
(config)#spanning-tree rpvst+ configuration
(config-rpvst+)#bridge 1 vlan 2
(config-rpvst+)#no bridge 1 vlan 2
```

---

## bridge vlan priority

This command sets the priority value for the spanning-tree on the bridge. The lower the priority of the VLAN on a bridge, the better the chances of the bridge becoming a root bridge, or a designated bridge for the VLAN.

Use the `no` form of this command to set the priority to its default (32,768).

### Command Syntax

```
bridge <1-32> vlan <2-4094> priority <0-61440>
no bridge <1-32> vlan <2-4094> priority
```

### Parameters

<1-32>	Bridge identifier.
<2-4094>	VLAN identifier.
<0-61440>	Bridge priority for the common instance. Set the priority in increments of 4096. A lower priority indicates greater likelihood of becoming root.

### Default

By default, priority for each VLAN is 32,768

### Command Mode

Configure mode

### Applicability

This command was introduced before OcnOS version 1.3.

### Examples

```
#configure terminal
(config)#bridge 1 vlan 2 priority 80
(config)#no bridge 1 vlan 10 priority
```

## bridge-group vlan

Use this command to assign a Rapid Per-VLAN Spanning Tree (RPVST+) instance to a port.

RPVST+ uses port priority as a tiebreaker to determine which port should forward frames for a particular LAN, or which port should be the root port for a VLAN. A lower value implies a better priority. In the case of the same priority, the interface index serves as the tiebreaker, with a lower-numbered interface being preferred over others.

Use the `no` parameter with this command to remove an RPVST+ instance from this port.

### Command Syntax

```
bridge-group <1-32> vlan <2-4094>
bridge-group <1-32> vlan <2-4094> path-cost <1-200000000>
bridge-group <1-32> vlan <2-4094> priority <0-240>
no bridge-group <1-32> vlan <2-4094>
no bridge-group <1-32> vlan <2-4094> path-cost
no bridge-group <1-32> vlan <2-4094> priority
```

### Parameters

<1-32>	Bridge group identifier.
<2-4094>	VLAN identifier.
<1-200000000>	Cost of a path associated with the interface.
<0-240>	Port priority. A lower priority indicates greater likelihood of the interface becoming a root. Set the priority only in increments of 16.

### Command Mode

Interface mode

### Applicability

This command was introduced before OcnOS version 1.3.

### Examples

```
#configure terminal
(config)#interface eth1
(config-if)#bridge-group 1 vlan 10

(config)#interface eth1
(config-if)#bridge-group 1 vlan 10 path-cost 1000

(config-if)#no bridge-group 1 vlan 10 path-cost

(config)#interface eth1
(config-if)#bridge-group 1 vlan 10 priority 240

(config-if)#no bridge-group 1 vlan 10 priority
```

---

## bridge protocol rpvst+

Use this command to enable Rapid Per-VLAN Spanning Tree on a bridge.

### Command Syntax

```
bridge <1-32> protocol rpvst+
```

### Parameter

<1-32>                    Bridge identifier.

### Command Mode

Configure mode

### Applicability

This command was introduced before OcnOS version 1.3.

### Example

```
#configure terminal  
(config)#bridge 1 protocol rpvst+
```

---

## bridge rapid-pervlan-spanning-tree

Use this command to enable Rapid Per-VLAN Spanning Tree (RPVST+) globally on a bridge.

Use the `no` form of this command to disable RPVST+ globally on a bridge.

### Command Syntax

```
bridge <1-32> rapid-pervlan-spanning-tree enable
no bridge <1-32> rapid-pervlan-spanning-tree enable (bridge-blocked|bridge-
forward|)
```

### Parameters

`<1-32>` Bridge identifier.

`bridge-blocked` Put ports of the bridge in the blocked state (default).

`bridge-forward` Put ports of the bridge in the forwarding state.

### Default

By default, this feature is enabled.

For the `no` form of this command, `bridge-blocked` is the default.

### Command Mode

Configure mode

### Applicability

This command was introduced before OcnOS version 1.3.

### Examples

```
#configure terminal
(config)#bridge 1 rapid-pervlan-spanning-tree enable

(config)#no bridge 1 rapid-pervlan-spanning-tree enable bridge-forward
```



---

## show spanning-tree rpvst+

Use this command to display RPVST information.

### Command Syntax

```
show spanning-tree rpvst+
show spanning-tree rpvst+ config
show spanning-tree rpvst+ detail
show spanning-tree rpvst+ detail interface IFNAME
show spanning-tree rpvst+ interface IFNAME
show spanning-tree rpvst+ vlan <1-4094>
show spanning-tree rpvst+ vlan <1-4094> interface IFNAME
```

### Parameters

config	Display configuration information.
detail	Display detailed information.
IFNAME	Display interface information.
<1-4094>	Display VLAN information

### Command Mode

Exec mode and Privileged Exec mode

### Applicability

This command was introduced before OcnOS version 1.3.

### Example

The following displays output of this command without any parameters.

```
#show spanning-tree rpvst+
% 1: Bridge up - Spanning Tree Enabled - topology change detected
% 1: Root Path Cost 0 - Root Port 0 - Bridge Priority 32768
% 1: Forward Delay 15 - Hello Time 2 - Max Age 20 - Transmit Hold Count 6
% 1: Root Id 8001525400b092de
% 1: Bridge Id 8001525400b092de
% 1: last topology change Wed Mar 28 02:31:50 2018
% 1: 1 topology change(s) - last topology change Wed Mar 28 02:31:50 2018

% 1: portfast bpdu-filter disabled
% 1: portfast bpdu-guard disabled
% 1: portfast errdisable timeout disabled
% 1: portfast errdisable timeout interval 300 sec
% eth1: Port Number 3 - Ifindex 3 - Port Id 0x8003 - Role Designated - State Forwarding
% eth1: Designated External Path Cost 0 -Internal Path Cost 0
% eth1: Configured Path Cost 200000 - Add type Explicit ref count 2
% eth1: Designated Port Id 0x8003 - Priority 128 -
```

## RPVST+ Commands

---

```
% eth1: Root 8001525400b092de
% eth1: Designated Bridge 8001525400b092de
% eth1: Message Age 0 - Max Age 20
% eth1: Hello Time 2 - Forward Delay 15
% eth1: Forward Timer 0 - Msg Age Timer 0 - Hello Timer 3 - topo change timer 0
% eth1: forward-transitions 1
% eth1: Version Rapid Spanning Tree Protocol - Received None - Send RSTP
% eth1: No portfast configured - Current portfast off
% eth1: bpdu-guard default - Current bpdu-guard off
% eth1: bpdu-filter default - Current bpdu-filter off
% eth1: no root guard configured - Current root guard off
% eth1: Configured Link Type point-to-point - Current point-to-point
% eth1: No auto-edge configured - Current port Auto Edge off
%
%
% Instance          VLAN
% 0:                1, 4-10
% 1:                2
% 2:                3
```

The following displays output of this command with the `config` parameter.

```
#show spanning-tree rpvst+ config
```

```
%
% RPVST Configuration Information for bridge 1 :
%-----
% Format Id          : 0
% Name              : Default
% Revision Level    : 0
% Digest            : 0xB41829F9030A054FB74EF7A8587FF58D
%-----
```

```
#show spanning-tree rpvst+ detail
```

```
% 1: Bridge up - Spanning Tree Enabled - topology change detected
% 1: Root Path Cost 0 - Root Port 0 - Bridge Priority 32768
% 1: Forward Delay 15 - Hello Time 2 - Max Age 20 - Transmit Hold Count 6
% 1: Root Id 8001525400b092de
% 1: Bridge Id 8001525400b092de
% 1: last topology change Wed Mar 28 02:31:50 2018
% 1: 1 topology change(s) - last topology change Wed Mar 28 02:31:50 2018

% 1: portfast bpdu-filter disabled
% 1: portfast bpdu-guard disabled
% 1: portfast errdisable timeout disabled
% 1: portfast errdisable timeout interval 300 sec
% eth1: Port Number 3 - Ifindex 3 - Port Id 0x8003 - Role Designated - State Forwarding
% eth1: Designated External Path Cost 0 -Internal Path Cost 0
% eth1: Configured Path Cost 200000 - Add type Explicit ref count 2
% eth1: Designated Port Id 0x8003 - Priority 128 -
% eth1: Root 8001525400b092de
```

```
% eth1: Designated Bridge 8001525400b092de
% eth1: Message Age 0 - Max Age 20
% eth1: Hello Time 2 - Forward Delay 15
% eth1: Forward Timer 0 - Msg Age Timer 0 - Hello Timer 1 - topo change timer 0
% eth1: forward-transitions 1
% eth1: Version Rapid Spanning Tree Protocol - Received None - Send RSTP
% eth1: No portfast configured - Current portfast off
% eth1: bpdu-guard default - Current bpdu-guard off
% eth1: bpdu-filter default - Current bpdu-filter off
% eth1: no root guard configured - Current root guard off
% eth1: Configured Link Type point-to-point - Current point-to-point
% eth1: No auto-edge configured - Current port Auto Edge off
%

% Instance 1: Vlans: 2
% eth1: Port Number 3 - Ifindex 3 - Port Id 0x8003 - Role Designated - State Forwarding
% eth1: Designated Internal Path Cost 0 - Designated Port Id 0x8003
% eth1: Configured Internal Path Cost 200000
% eth1: Configured External Path cost 200000
% eth1: Configured Internal Priority 128
% eth1: Configured External Priority 128
% eth1: Designated Root 8002525400b092de
% eth1: Designated Bridge 8002525400b092de
% eth1: Message Age 0 - Max Age 20
% eth1: Hello Time 2 - Forward Delay 15
% eth1: Forward Timer 0 - Msg Age Timer 0 - Hello Timer 1

#show spanning-tree rpvst+ vlan 2
% vlan 2 Instance 1 configured
% 1: Root Path Cost 0 - Root Port 0 - Bridge Priority 32768
% 1: Root Id 8002525400b092de
% 1: Bridge Id 8002525400b092de
% eth1: Port Number 3 - Ifindex 3 - Port Id 0x8003 - Role Designated - State Forwarding
% eth1: Designated Internal Path Cost 0 - Designated Port Id 0x8003
% eth1: Configured Internal Path Cost 200000
% eth1: Configured External Path cost 200000
% eth1: Configured Internal Priority 128
% eth1: Configured External Priority 128
% eth1: Designated Root 8002525400b092de
% eth1: Designated Bridge 8002525400b092de
% eth1: Message Age 0 - Max Age 20
% eth1: Hello Time 2 - Forward Delay 15
% eth1: Forward Timer 0 - Msg Age Timer 0 - Hello Timer 1
%

%

#show spanning-tree rpvst+ vlan 2 interface eth1
% 1: Root Path Cost 0 - Root Port 0 - Bridge Priority 32768
% 1: Root Id 8002525400b092de
```

## RPVST+ Commands

---

```
% 1: Bridge Id 8002525400b092de
% eth1: Port Number 3 - Ifindex 3 - Port Id 0x8003 - Role Designated - State
Forwarding
% eth1: Designated Internal Path Cost 0 - Designated Port Id 0x8003
% eth1: Configured Internal Path Cost 200000
% eth1: Configured External Path cost 200000
% eth1: Configured Internal Priority 128
% eth1: Configured External Priority 128
% eth1: Designated Root 8002525400b092de
% eth1: Designated Bridge 8002525400b092de
% eth1: Message Age 0 - Max Age 20
% eth1: Hello Time 2 - Forward Delay 15
% eth1: Forward Timer 0 - Msg Age Timer 0 - Hello Timer 0
%
```

---

## spanning-tree rpvst+ configuration

Use this command to enter RPVST+ configuration mode after creating a bridge and adding a VLAN to that bridge. Internally, an RSTP Instance is created for each configured VLAN.

### Command Syntax

```
spanning-tree rpvst+ configuration
```

### Parameters

None

### Command Mode

Configure mode

### Applicability

This command was introduced before OcNOS version 1.3.

### Example

```
#configure terminal  
(config)#spanning-tree rpvst+ configuration  
(config-rpvst+)#
```

---

## spanning-tree vlan restricted-role

Use this command to restrict the role of the interface.

Use the `no` form of this command to not restrict the role of the interface.

### Command Syntax

```
spanning-tree vlan <2-4094> restricted-role
no spanning-tree vlan <2-4094> restricted-role
```

### Parameters

<2-4094>            VLAN identifier.

### Default

The default is to not restrict the role of the interface

### Command Mode

Interface mode

### Applicability

This command was introduced before OcNOS version 1.3.

### Example

```
#configure terminal
(config)#interface eth0
(config-if)#spanning-tree vlan 10 restricted-role
```

---

## spanning-tree vlan restricted-tcn

Use this command to restrict propagating topology change notifications (TCNs) from the interface.

Use the `no` form of this command to not restrict propagating TCNs from the interface.

### Command Syntax

```
spanning-tree vlan <2-4094> restricted-tcn
no spanning-tree vlan <2-4094> restricted_tcn
```

### Parameters

<2-4094>            VLAN identifier.

### Default

The default is to not restrict propagating TCNs

### Command Mode

Interface mode

### Applicability

This command was introduced before OcnOS version 1.3.

### Example

```
#configure terminal
(config)#interface eth0
(config-if)#spanning-tree vlan 10 restricted-tcn
(config-if)#no spanning-tree vlan 10 restricted_tcn
```





---

## CHAPTER 5 Link Aggregation Commands

---

This chapter describes the link aggregation commands.

- `channel-group mode`
- `clear lacp`
- `debug lacp`
- `interface po`
- `interface sa`
- `lacp destination-mac`
- `lacp force-up`
- `lacp port-priority`
- `lacp system-priority`
- `lacp timeout`
- `port-channel load-balance`
- `port-channel min-bandwidth - dynamic LAG min-bandwidth`
- `port-channel min-links - dynamic LAG min-links`
- `port-channel min-bandwidth - static LAG min-bandwidth`
- `port-channel min-links - static LAG min-links`
- `show debugging lacp`
- `show etherchannel`
- `show lacp sys-id`
- `show lacp-counter`
- `show port etherchannel`
- `show static-channel-group`
- `show static-channel load-balance`
- `snmp restart lacp`
- `static-channel-group`

## channel-group mode

Use this command to add an interface to an existing link aggregation group.

After you execute this command, the interface loses its properties and takes the properties of the aggregated interface.

Use the `no` parameter with this command to remove an interface from a dynamic link aggregation group. When you remove an interface from a LAG, the interface acquires the default interface properties.

### Command Syntax

```
channel-group <1-16383> mode (active|passive)
channel-group <11-16383> mode (active|passive)
no channel-group
```

### Parameters

<1-16383>	Specify a channel group number (without DRNI).
<11-16383>	Specify a channel group number (with DRNI).
mode	Specify a channel mode.
active	Enable LACP negotiation.
passive	Disable LACP negotiation.

### Command Mode

Interface mode

### Applicability

This command was introduced before OcnOS version 1.3.

### Examples

```
#configure terminal
(config)#interface xe1 switchport
(config-if)#switchport
(config-if)#channel-group 1 mode active
(config-if)#exit

#sh run in pol
!
interface pol
switchport
port-channel load-balance src-dst-mac
```

The is an example of `no channel-group`:

```
#configure terminal
(config)#interface xe1
(config-if)#switchport
(config-if)#no channel-group
(config-if)#exit

#sh run in xe1
!
interface xe1
```

```
!  
#sh run in po1  
!  
interface po1  
  switchport  
  port-channel load-balance src-dst-mac  
!
```

---

## clear lacp

Use this command to clear the counters of all LACP aggregators or a given LACP aggregator.

### Command Syntax

```
clear lacp <1-65535> counters
clear lacp counters
```

### Parameters

<1-65535>            Clears a channel-group number.

### Command Mode

Exec mode and Privileged Exec mode

### Applicability

This command was introduced before OcNOS version 1.3.

### Example

```
#clear lacp 2 counters
```

## debug lacp

Use this command to enable LACP debugging.

Use the `no` parameter with this command to disable debugging.

### Command Syntax

```
debug lacp (event|cli|timer|packet|sync|ha|all|rx|tx)
no debug lacp (event|cli|timer|packet|sync|ha|allrx|tx)
undebug all
```

### Parameters

<code>all</code>	Enables all LACP debugging.
<code>cli</code>	Echo commands to console.
<code>event</code>	Sets the debug options for LACP events.
<code>ha</code>	Echo High availability events to console.
<code>packet</code>	Sets the debug option for LACP packets.
<code>sync</code>	Echo synchronization to console.
<code>timer</code>	Echo timer expiry to console.
<code>rx</code>	Echo receiving of lacpdus to console.
<code>tx</code>	Echo transmission of lacpdus to console.

### Command Mode

Exec mode and Privileged Exec mode

### Applicability

This command was introduced before OcNOS version 1.3.

### Example

```
#debug lacp all
```

---

## interface po

Use this command to create a dummy dynamic link aggregate interface (by default an L3 LAG interface).

Use the `no` form of this command to remove a dynamic link aggregate group and also it remove the properties of the `po` from all member ports.

Note: Switchport/routed mode needs to be set for the PO before adding member ports to it.

### Command Syntax

```
interface po<1-16383>
no interface po<1-16383>
```

### Parameters

<1-16383>            Channel group number

### Default

By default, interface `po` is L3 LAG interface

### Command Mode

Configuration mode

### Applicability

This command was introduced before OcnOS version 1.3.

### Example

```
#configure terminal
(config)#interface po1
(config-if)#switchport
(config-if)#exit
```

---

## interface sa

Use this command to create a dummy static link aggregate interface (by default an L3 LAG interface) and to add an interface to an existing static link aggregation group.

Use the `no` form of this command to remove a static link aggregate group and also remove the properties of the ports from all member ports.

### Command Syntax

```
interface sa<1-16383>
no interface sa<1-16383>
```

### Parameters

<1-16383>            Channel group number.

### Default

By default, interface sa is L3 LAG interface

### Command Mode

Configuration mode

### Applicability

This command was introduced before OcNOS version 1.3.

### Example

```
#configure terminal
(config)#interface sa1
(config-if)#switchport
(config-if)#exit
```

---

## lacp destination-mac

Use this command to set the address type to use for sending LACPDU (Link Aggregation Control Protocol Data Units).

Note: The interface must be an aggregation port.

Use the `no` form of this command to set the address type to its default (multicast group address).

### Command Syntax

```
lacp destination-mac (customer-bridge-group-address | multicast-group-address |
non-tmpr-group-address)
no lacp destination-mac
```

### Parameters

```
customer-bridge-group-address
    Customer bridge group address
multicast-group-address
    Multicast group address (default)
non-TPMR-group-address
    Non-Two-Port Media Access Control Relay (TPMR) group address
```

### Default

By default, `lacp destination-mac` is `multicast-group-address`

### Command Mode

Interface mode

### Applicability

This command was introduced before OcNOS version 1.3.

### Example

```
#config terminal
(config)#interface eth1
(config-if)#lacp destination-mac customer-bridge-group-address
```



## lacp force-up

Use this command to make a port immediately begin forwarding packets and not wait for an LACPDU. After you execute this command, the member port is forcefully up even if LACP is not in sync (only if no other member in the aggregator is in sync).

If a force-up port stops receiving LACPDUs, the port ignores the time-out and remains in operation.

This command can be configured on one member interface of a port channel.

Note: This command can only be given after executing the [channel-group mode](#) command on an interface. Force-up mode is not supported for LACP passive mode.

Note: For MLAG, only configure a force-up port on either on the master node or the slave node to prevent traffic drops/loops.

Use the `no` form of this command to disable force-up mode.

### Command Syntax:

```
lacp force-up
no lacp force-up
```

### Parameters

None

### Default

By default, LACP force-up mode is disabled.

### Command Mode

Interface mode

### Applicability

This command was introduced in OcNOS version 1.3.6.

### Example

```
#configure terminal
(config)#interface xe1
(config-if)#switchport
(config-if)#channel-group 1 mode active
(config-if)#lacp force-up
(config-if)#exit
```

---

## lacp port-priority

Use this command to set the priority of a channel. Channels are selected for aggregation based on their priority with the higher priority (numerically lower) channels selected first.

Use the `no` parameter with this command to set the priority of port to the default value (32768).

### Command Syntax

```
lacp port-priority <1-65535>
no lacp port-priority
```

### Parameters

<1-65535> Specify the LACP port priority.

### Default

By default, lacp port priority is 32768

### Command Mode

Interface mode

### Applicability

This command was introduced before OcnOS version 1.3.

### Example

```
#configure terminal
(config)#interface eth0
(config-if)#lacp port-priority 34
```

---

## lacp system-priority

Use this command to set the LACP system priority. This priority determines the system responsible for resolving conflicts in the choice of aggregation groups.

Note: A lower numerical value has a higher priority.

Use the `no` parameter with this command to set the system priority to its default value (32768).

### Command Syntax

```
lacp system-priority <1-65535>
no lacp system-priority
```

### Parameters

<1-65535>            System priority.

### Default

By default, system priority is 32768

### Command Mode

Configure mode

### Applicability

This command was introduced before OcnOS version 1.3.

### Example

```
#configure terminal
(config)#lacp system-priority 6700
```

---

## lacp timeout

Use this command to set either a short or long timeout value on a port. The timeout value is the number of seconds before invalidating a received LACP data unit (DU).

### Command Syntax

```
lacp timeout (short|long)
```

### Parameters

short                    LACP short timeout. 3 seconds.

long                    LACP long timeout. 90 seconds.

Note: **Short:** With this mode, BPDU will be sent at Fast\_Periodic\_Time of 1 second interval. It will timeout, before invalidating received LACPDU, after 3xFast\_Periodic\_Time(3seconds)

Note: **Long:** With this mode, BPDU will be sent at Slow\_Periodic\_Time of 30 seconds intervals. It will timeout, before invalidating received LACPDU, after 3xSlow\_Periodic\_Time(90seconds)

### Default

By default, lacp timeout is long

### Command Mode

Interface mode

### Applicability

This command was introduced before OcnOS version 1.3.

### Example

The following sets the LACP short timeout on a port.

```
#configure terminal
(config)#interface eth0
(config-if)#lacp timeout short
```

---

## port-channel load-balance

Use this command to configure LACP port-channel load-balancing and set port-selection criteria (PSC) for an interface. Use the `no` option with this command to remove the load-balancing configuration and unset PSC.

### Command Syntax

```
port-channel load-balance (dst-mac|src-mac|src-dst-mac|dst-ip|src-ip|src-dst-  
ip|dst-port|src-port|src-dst-port|rtag7)  
no port-channel load-balance
```

### Parameters

<code>dst-ip</code>	Destination IP address-based load balancing.
<code>dst-mac</code>	Destination MAC address-based load balancing.
<code>dst-port</code>	Destination TCP/UDP address-based load balancing.
<code>src-dst-ip</code>	Source and Destination IP address-based load balancing.
<code>src-dst-mac</code>	Source and Destination MAC address-based load balancing.
<code>src-dst-port</code>	Source and Destination TCP/UDP address-based load balancing.
<code>src-ip</code>	Source IP address-based load balancing.
<code>src-mac</code>	Source MAC address-based load balancing.
<code>src-port</code>	Source port address-based load balancing.
<code>rtag7</code>	Hashing based on packet type. IP - IP/Layer4 header, L2 - Layer2 header, TRILL - TRILL packet.

### Default

By default, load balance is `src-dst-port`

### Command Mode

Interface mode

### Applicability

This command was introduced before OcNOS version 1.3.

### Example

```
#configure terminal  
(config)#interface po1  
(config-if)#port-channel load-balance src-dst-mac
```

---

## port-channel min-bandwidth - dynamic LAG min-bandwidth

Use this command to set the minimum number of aggregated bandwidth that need to be up in the LAG(PO) interface. When the minimum number of bandwidth are configured for a LAG(PO), if the active links bandwidth for that interface become less than the configured value, then the whole LAG(PO) is brought down. When the number of active links bandwidth become the same or more than the configured value, then the whole LAG is restored.

Use the no form of this command to remove the minimum number of aggregated bandwidth that need to be up in the LAG interface.

Note: The minimum number of aggregated bandwidth should be same across both ends of an aggregation interface. If not configured, then on one of the nodes the LAG port will be treated as up and on the other as down and traffic will be discarded.

Note: When a LAG port is moved to the down state because it does not have the minimum number of required bandwidth up and running, then the traffic on the remaining interfaces in the LAG will be counted as port-block discards.

Note: The [port-channel min-links - dynamic LAG min-links](#) feature and this feature are mutually exclusive. Both configurations cannot exist at the same time.

### Command Syntax

```
port-channel min-bandwidth <1-1000>g
no port-channel min-bandwidth
```

### Parameters

<1-1000>g for 1 to 1000 gigabits/s

### Default

By default, port channel min- bandwidth is disabled.

### Command Mode

Interface mode

### Applicability

This command was introduced from OcNOS version 1.3.8

### Example

```
#configure terminal
(config)#interface po1
(config-if)#port-channel min-bandwidth 10g
```

---

## port-channel min-links - dynamic LAG min-links

Use this command to set the minimum number of aggregated links that need to be up in the LAG(PO) interface. When the minimum number of links are configured for a LAG(PO), if the active links for that interface become less than the configured value, then the whole LAG(PO) is brought down. When the number of active links become the same or more than the configured value, then the whole LAG is restored.

Use the no form of this command to remove the minimum number of aggregated links that need to be up in the LAG interface.

Note: The minimum number of aggregated links should be same across both ends of an aggregation interface. If not configured, then on one of the nodes the LAG port will be treated as up and on the other as down and traffic will be discarded.

Note: When a LAG port is moved to the down state because it does not have the minimum number of required links up and running, then the traffic on the remaining interfaces in the LAG will be counted as port-block discards.

Note: The [show debugging lacp](#) feature and this feature are mutually exclusive. Both configurations cannot exist at the same time.

### Command Syntax

```
port-channel min-links <2-32>
no port-channel min-links
```

### Parameters

<2-32>                    Minimum number of links

### Default

By default, port channel min-link is disabled.

### Command Mode

Interface mode

### Applicability

This command was introduced from OcNOS version 1.3.8

### Example

```
#configure terminal
(config)#interface po1
(config-if)#port-channel min-links 10
(config-if)#exit
```

---

## port-channel min-bandwidth - static LAG min-bandwidth

Use this command to set the minimum number of aggregated bandwidth that need to be up in the LAG(SA) interface. When the minimum number of bandwidth are configured for a LAG(SA), if the active links bandwidth for that interface become less than the configured value, then the whole LAG(SA) is brought down. When the number of active links bandwidth become the same or more than the configured value, then the whole LAG is restored.

Use the no form of this command to remove the minimum number of aggregated bandwidth that need to be up in the LAG interface.

Note: The minimum number of aggregated bandwidth should be same across both ends of an aggregation interface. If not configured, then on one of the nodes the LAG port will be treated as up and on the other as down and traffic will be discarded.

Note: When a LAG port is moved to the down state because it does not have the minimum number of required bandwidth up and running, then the traffic on the remaining interfaces in the LAG will be counted as port-block discards.

Note: The [port-channel min-links - static LAG min-links](#) feature and this feature are mutually exclusive. Both configurations cannot exist at the same time.

### Command Syntax

```
port-channel min-bandwidth <1-1000>g
no port-channel min-bandwidth
```

### Parameters

<1-1000>g            for 1 to 1000 gigabits/s

### Default

By default, port channel min- bandwidth is disabled.

### Command Mode

Interface mode

### Applicability

This command was introduced from OcNOS version 1.3.8

### Example

```
#configure terminal
(config)#interface sa1
(config-if)#port-channel min-bandwidth 10g
```



---

## port-channel min-links - static LAG min-links

Use this command to set the minimum number of aggregated links that need to be up in the LAG(SA) interface. When the minimum number of links are configured for a LAG(SA), if the active links for that interface become less than the configured value, then the whole LAG(SA) is brought down. When the number of active links become the same or more than the configured value, then the whole LAG is restored.

Use the no form of this command to remove the minimum number of aggregated links that need to be up in the LAG interface.

Note: The minimum number of aggregated links should be same across both ends of an aggregation interface. If not configured, then on one of the nodes the LAG port will be treated as up and on the other as down and traffic will be discarded.

Note: When a LAG port is moved to the down state because it does not have the minimum number of required links up and running, then the traffic on the remaining interfaces in the LAG will be counted as port-block discards.

Note: The [port-channel min-bandwidth - static LAG min-bandwidth](#) feature and this feature are mutually exclusive. Both configurations cannot exist at the same time.

### Command Syntax

```
port-channel min-links <2-32>
no port-channel min-links
```

### Parameters

<2-32>                    Minimum number of links

### Default

By default, port channel min-link is disabled.

### Command Mode

Interface mode

### Applicability

This command was introduced from OcNOS version 1.3.8

### Example

```
#configure terminal
(config)#interface sa1
(config-if)#port-channel min-links 10
(config-if)#exit
```

---

## show debugging lacp

Use this command to display the status of the debugging of the LACP system.

### Command Syntax

```
show debugging lacp
```

### Parameters

None

### Command Mode

Exec and Privileged Exec mode

### Applicability

This command was introduced before OcNOS version 1.3.

### Example

```
#show debugging lacp
```

```
LACP debugging status:  
LACP timer debugging is on
```

---

## show etherchannel

Use this command to display information about link aggregation groups.

### Command Syntax

```
show etherchannel
show etherchannel <1-65535>
```

With MLAG:

```
show etherchannel (<1-16383>|) detail
show etherchannel (<1-16383>|) load-balance
show etherchannel (<1-16383>|) summary
```

Without MLAG:

```
show etherchannel (<1-65535>|) detail
show etherchannel (<1-65535>|) load-balance
show etherchannel (<1-65535>|) summary
```

### Parameters

<1-65535>	Specify channel-group number.
<1-16383>	Specify channel-group number.
detail	Specify detailed etherchannel information.
load-balance	Specify load balancing.
summary	Specify Etherchannel summary information.

### Command Mode

Exec mode and Privileged Exec mode

### Applicability

This command was introduced before OcnOS version 1.3.

### Example

```
#show etherchannel summary
% Aggregator po1 185
% Aggregator Type: Layer3
% Admin Key: 0001 - Oper Key 0001
% Link: eth3 (5) sync: 0
-----
% Aggregator po4 186
% Admin Key: 0004 - Oper Key 0004
% Link: eth2 (4) sync: 0
-----
% Aggregator po5 187
% Admin Key: 0005 - Oper Key 0005
% Link: eth1 (3) sync: 0
```

```
#show etherchannel detail
% Aggregator po1 185
% Aggregator Type: Layer3
% Mac address: 08:00:27:36:f5:7d
% Admin Key: 0001 - Oper Key 0001
% Actor LAG ID- 0x8000,08-00-27-fa-4b-0e,0x0001
% Receive link count: 0 - Transmit link count: 0
% Individual: 0 - Ready: 0
% Partner LAG ID- 0x0000,00-00-00-00-00-00,0x0000
% Link: eth3 (5) sync: 0
% Collector max delay: 5
-----
% Aggregator po4 186
% Mac address: 08:00:27:76:0c:57
% Admin Key: 0004 - Oper Key 0004
% Actor LAG ID- 0x8000,08-00-27-fa-4b-0e,0x0004
% Receive link count: 0 - Transmit link count: 0
% Individual: 0 - Ready: 1
% Partner LAG ID- 0x0000,00-00-00-00-00-00,0x0000
% Link: eth2 (4) sync: 0
% Collector max delay: 5
-----
% Aggregator po5 187
% Mac address: 08:00:27:2f:d5:ae
% Admin Key: 0005 - Oper Key 0005
% Actor LAG ID- 0x8000,08-00-27-fa-4b-0e,0x0005
% Receive link count: 0 - Transmit link count: 0
% Individual: 0 - Ready: 0
% Partner LAG ID- 0x0000,00-00-00-00-00-00,0x0000
% Link: eth1 (3) sync: 0
% Collector max delay: 5
```

Table 5-11 explains the show command output fields.

**Table 5-11: show etherchannel detail output**

Field	Description
Aggregator	Link aggregators name and ID number.
Mac address	Unique MAC address for link identification.
Admin Key	LACP administrative key – automatically configured value on each port configured to use LACP.
Oper Key	LACP operator key on Partner – automatically configured value on each port configured to use LACP.
Actor LAG ID	LAG ID consisting of MAC address plus aggregator ID number for this Actor.
Receive link count	The number of link received from the peer LAG.
Transmit link count	The number of links contained transmitted to the peer LAG.
Individual	The individual physical network interfaces or ports contained in the LAG.
Ready	The number of links in the active state on this Actor.
Partner LAG ID	Partner LAG ID consisting of MAC address plus aggregator ID number.

**Table 5-11: show etherchannel detail output (Continued)**

<b>Field</b>	<b>Description</b>
Link	Interface and ID number of the link.
sync	MAC address synchronization enables a MLAG Partner to forward Layer 3 packets arriving on this interfaces with either its own MAC address or its Partner's.
Collector max delay	Maximum period of wait time between sending of two subsequent Ethernet frames on a link.

---

## show lacp sys-id

Use this command to display the LACP system identifier and priority.

### Command Syntax

```
show lacp sys-id
```

### Parameters

<code>sys-id</code>	Display LACP system ID and priority
---------------------	-------------------------------------

### Command Mode

Exec and Privileged Exec mode

### Applicability

This command was introduced before OcNOS version 1.3.

### Example

```
#show lacp sys-id
% System 8000,00-0e-0c-83-37-27
```

---

## show lacp-counter

Use this command to display the packet traffic on all ports of all present LACP aggregators, or a given LACP aggregator.

### Command Syntax

```
show lacp-counte
show lacp-counter <1-65535>
```

### Parameters

<1-65535>            Channel-group number

### Command Mode

Exec and Privileged Exec mode

### Applicability

This command was introduced before OcnOS version 1.3.

### Example

```
#show lacp-counter 555
```

Port	LACPDUs		Marker		Pckt err	
	Sent	Recv	Sent	Recv	Sent	Recv

---

## show port etherchannel

Use this command to display details about a PO and its members' interfaces or to display details of a single member interface of a PO.

### Command Syntax

```
show port etherchannel IFNAME
```

### Parameters

IFNAME                    Interface name

### Command Mode

Exec and Privileged Exec mode

### Applicability

This command was introduced before OcNOS version 1.3.

### Example

```
#show port etherchannel ce29/1
LAG ID                                 : 0x8000,cc-37-ab-a0-89-ca,0x0002
Partner oper LAG ID                   : 0x8000,a8-2b-b5-38-1e-48,0x0004
Aggregator ID                          : 100002
  LACP link info                       : ce29/1 - 10001
  Periodic Transmission
  machine state                         : Slow periodic
  Receive machine state                : Current
  Mux machine state                     : Collecting/Distributing
  Actor Info :
  =====
  Actor Port priority                   : 0x8000 (32768)
  Admin key                             : 0x0002 (2) Oper key: 0x0002 (2)
  Physical admin key                    : (2)
  Actor Oper state                      : ACT:1 TIM:0 AGG:1 SYN:1 COL:1 DIS:1 DEF:0 EXP:0
  Actor Admin state                     : ACT:1 TIM:0 AGG:1 SYN:0 COL:0 DIS:0 DEF:1 EXP:0
  Partner Info:
  =====
  Partner oper port                     : 10009
  Partner link info                     : admin port 0
  Partner admin LAG ID                  : 0x0000-00:00:00:00:0000
  Partner system priority               : admin:0x0000 - oper:0x8000
  Partner port priority                 : admin:0x0000 - oper:0x8000
  Partner oper state                    : ACT:1 TIM:0 AGG:1 SYN:1 COL:1 DIS:1 DEF:0 EXP:0
  Partner admin state                   : ACT:0 TIM:0 AGG:1 SYN:0 COL:0 DIS:0 DEF:1 EXP:0

#show port etherchannel po2
LAG ID                                 : 0x8000,cc-37-ab-a0-89-ca,0x0002
Partner oper LAG ID                   : 0x8000,a8-2b-b5-38-1e-48,0x0004
Aggregator ID                          : 100002
  LACP link info                       : ce29/1 - 10001
  Periodic Transmission
  machine state                         : Slow periodic
```



```

Receive machine state      : Current
Mux machine state        : Collecting/Distributing
Actor Info :
=====
Actor Port priority      : 0x8000 (32768)
Admin key                : 0x0002 (2) Oper key: 0x0002 (2)
Physical admin key      : (2)
Actor Oper state        : ACT:1 TIM:0 AGG:1 SYN:1 COL:1 DIS:1 DEF:0 EXP:0
Actor Admin state      : ACT:1 TIM:0 AGG:1 SYN:0 COL:0 DIS:0 DEF:1 EXP:0
Partner Info:
=====
Partner oper port       : 10009
Partner link info      : admin port 0
Partner admin LAG ID   : 0x0000-00:00:00:00:0000
Partner system priority : admin:0x0000 - oper:0x8000
Partner port priority  : admin:0x0000 - oper:0x8000
Partner oper state     : ACT:1 TIM:0 AGG:1 SYN:1 COL:1 DIS:1 DEF:0 EXP:0
Partner admin state    : ACT:0 TIM:0 AGG:1 SYN:0 COL:0 DIS:0 DEF:1 EXP:0

LACP link info         : ce30/1 - 10005
Periodic Transmission
machine state          : Slow periodic
Receive machine state  : Current
Mux machine state      : Collecting/Distributing
Actor Info :
=====
Actor Port priority    : 0x8000 (32768)
Admin key              : 0x0002 (2) Oper key: 0x0002 (2)
Physical admin key    : (2)
Actor Oper state      : ACT:1 TIM:0 AGG:1 SYN:1 COL:1 DIS:1 DEF:0 EXP:0
Actor Admin state     : ACT:1 TIM:0 AGG:1 SYN:0 COL:0 DIS:0 DEF:1 EXP:0
Partner Info:
=====
Partner oper port     : 10013
Partner link info    : admin port 0
Partner admin LAG ID : 0x0000-00:00:00:00:0000
Partner system priority : admin:0x0000 - oper:0x8000
Partner port priority : admin:0x0000 - oper:0x8000
Partner oper state   : ACT:1 TIM:0 AGG:1 SYN:1 COL:1 DIS:1 DEF:0 EXP:0
Partner admin state  : ACT:0 TIM:0 AGG:1 SYN:0 COL:0 DIS:0 DEF:1 EXP:0

```

Note: Most of the output of this command is duplicated in the [show etherchannel](#) command (see also the 802.3ad specification). The output of the `show port etherchannel` command is primarily a list of state machine values. An explanation of the state machine bits follows. See [Figure 5-1](#).

[Table 5-12](#) explains the show command output fields.

**Table 5-12: show port etherchannel detailed output**

Entry	Description
Actor/Partner state	The Actor's and Partner's state variables, encoded as individual bits within a single octet.
ACT	LACP_Activity is encoded in bit 0. Active LACP is encoded as a 1; Passive LACP as a 0.

**Table 5-12: show port etherchannel detailed output (Continued)**

Entry	Description
TIM	LACP_Timeout is encoded in bit 1. Short Timeout is encoded as a 1; Long Timeout as a 0.
AGG	Aggregability is encoded in bit 2. Aggregatable is encoded as a 1; Individual is encoded as a 0.
SYN	Synchronization is encoded in bit 3. In_Sync is encoded as a 1; Out_Of_Sync is encoded as a 0.
COL	Collecting is encoded in bit 4. True is encoded as a 1; False is encoded as a 0.
DIS	Distributing is encoded in bit 5. True is encoded as a 1; False is encoded as a 0.
DEF	Defaulted is encoded in bit 6.
EXP	Defaulted is encoded in bit 7.

Bits 7 and 8 are reserved; these are ignored on receipt and transmitted as zero. However, the received value of these bits is recorded on receipt to accurately reflect the actor's view of the partner's state in outgoing PDUs.

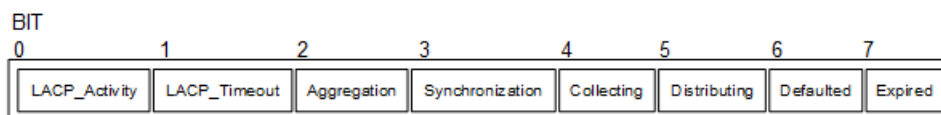
**Figure 5-1: Diagram of state machine octet**

---

## show static-channel-group

Use this command to display the types of load-balancing port selection criteria (PSC) used on configured static aggregators.

### Command Syntax

```
show static-channel-group (<1-16383>|)
```

### Parameters

<1-16383> Specify channel-group number.

### Command Mode

Privileged Exec mode

### Applicability

This command was introduced before OcNOS version 1.3.

### Examples

The following is an example of the output of this command:

```
#show static-channel-group 1
% Static Aggregator: sal
% Member:
  eth1
```

---

## show static-channel load-balance

Use this command to display information about static channel groups.

### Command Syntax

```
show static-channel (<1-16383>|) load-balance
```

### Parameters

<1-16383>            Specify static-channel-group number.

### Command Mode

Privileged Exec mode

### Applicability

This command was introduced before OcNOS version 1.3.

### Examples

The following is an example of the output of this command:

```
#show static-channel load-balance
% Static Aggregator: sa5
Source and Destination Mac address
-----
% Static Aggregator: sa3
Source and Destination Mac address
-----
% Static Aggregator: sa1
Source and Destination Mac address

#show static-channel 1 load-balance
% Static Aggregator: sa1
Source and Destination Mac address
```

---

## snmp restart lacp

Use this command to restart SNMP in LACP.

### Command Syntax

```
snmp restart lacp
```

### Parameters

None

### Default

By default, snmp restart lacp is disabled

### Command Mode

Configure mode

### Applicability

This command was introduced before OcNOS version 1.3.

### Examples

```
(config)#snmp restart lacp
```

---

## static-channel-group

Use this command to create a static link aggregation group or to add an interface to an existing link aggregation group.

Use the `no` form of this command to remove an interface from a static link aggregation group without removing the static link aggregation group itself.

### Command Syntax

```
static-channel-group <1-16383>
no static-channel-group
```

### Parameter

<1-16383>      Channel group number.

### Default

By default, static channel group is disabled

### Command Mode

Interface mode

### Applicability

This command was introduced before OcnOS version 1.3.

### Example

```
#configure terminal
(config)#interface xe1
(config-if)#switchport
(config-if)#static-channel-group 1
(config-if)#exit

#sh run in sa1
!
interface sa1
switchport
port-channel load-balance src-dst-mac
```

This is an example of `no static-channel-group`:

```
#configure terminal
(config)#interface xe1
(config-if)#switchport
(config-if)#no static-channel-group
(config-if)#exit

#sh run in xe1
!
interface xe1
!
#sh run in sa1
!
interface sa1
switchport
```

```
port-channel load-balance src-dst-mac  
!
```





## CHAPTER 6 Multi-Chassis Link Aggregation Commands

---

This chapter describes the Multi-Chassis Link Aggregation commands.

Multi-Chassis Link Aggregation is also called MC-LAG, MLAG, or Distributed Resilient Network Interconnect (DRNI). In this document, it is called MC-LAG.

- [clear mcec statistics](#)
- [debug mcec](#)
- [domain-address](#)
- [domain hello timeout](#)
- [domain priority](#)
- [domain-system-number](#)
- [intra-domain-link](#)
- [intra-domain-peer](#)
- [mcec domain configuration](#)
- [mlag](#)
- [mode](#)
- [show mcec statistics](#)
- [show mlag detail](#)
- [show mlag domain](#)
- [show spanning-tree mlag operational-config](#)
- [show spanning-tree mlag sync-detail](#)
- [switchover type](#)

---

## clear mcec statistics

Use this command to clear the statistics related to hello and information PDUs in the MCEC domain.

### Command Syntax

```
clear mcec statistics
```

### Parameters

None

### Command Mode

Privileged exec mode

### Applicability

This command was introduced in OcNOS version 1.3.6.

### Examples

```
#clear mcec statistics
```

## debug mcec

Use this command to view debugging logs for MC-LAG.

Use the `no` form of this command to remove debugging logs for MC-LAG.

### Command Syntax

```
debug mcec (timer|event|hello|info|cli|mac-sync|all)
no debug mcec (timer|event|hello|info|cli|mac-sync|all)
```

### Parameters

<code>all</code>	ALL
<code>cli</code>	CLI
<code>event</code>	Event
<code>hello</code>	Hello
<code>info</code>	Info
<code>mac-sync</code>	Mac Sync
<code>timer</code>	Timer

### Command Mode

Privileged Exec mode

### Applicability

This command was introduced before OcnOS version 1.3.

### Example

```
#debug mcec all
#no debug mcec all
```

---

## domain-address

Use this command to configure domain address, which helps to identify the mcec domain.

Use the `no` form of this command to remove the domain address.

### Command Syntax

```
domain-address <domain-id>
no domain-address
```

### Parameters

`domain-id` domain address in HHHH.HHHH.HHHH format

### Command Mode

MCEC mode

### Applicability

This command was introduced before OcNOS version 1.3.

### Examples

```
#config terminal
(config)#mcec domain configuration
(config-mcec-domain)#domain-address 1111.2222.3333
```

---

## domain hello timeout

Use this command to specify the domain hello-timeout value.

### Command Syntax

```
domain-hello-timeout (long|short)
```

### Parameters

long	Long Timeout
short	Short Timeout

### Command Mode

MCEC mode

### Applicability

This command was introduced before OcnOS version 1.3.

### Examples

```
#config terminal
(config)#mcec domain configuration
(config-mcec-domain)#domain-hello-timeout long
```

---

## domain priority

Use this command to specify the priority value associated with mcec domain.

Use the `no` form of this command to remove the priority value associated with mcec domain.

### Command Syntax

```
domain-priority <1-65535>
no domain-priority
```

### Parameters

<1-65535>      Priority Value

### Command Mode

MCEC mode

### Applicability

This command was introduced before OcNOS version 1.3.

### Example

```
#config terminal
(config)#mcec domain configuration
(config-mcec-domain)#domain-priority 2
```

---

## domain-system-number

Use this command to configure domain system number, which uniquely identifies domain system in mcec domain.

Use the `no` form of this command to configure domain system number.

### Command Syntax

```
domain-system-number <1-2>
no domain-system-number
```

### Parameters

<1-2>	Domain System Number
-------	----------------------

### Command Mode

MCEC mode

### Applicability

This command was introduced before OcNOS version 1.3.

### Example

```
#config terminal
(config)#mcec domain configuration
(config-mcec-domain)#domain-system-number 2
```

---

## intra-domain-link

Use this command to map an interface as intra domain link that connects the domain system with its neighbor in a mcec domain.

Use the no form of this command to unmap the interface configured as intra domain link that connects the domain system with its neighbor in a mcec domain.

### Command Syntax

```
intra-domain-link <IFNAME>
no intra-domain-link
```

### Parameters

IFNAME	Interface name
--------	----------------

### Command Mode

MCEC mode

### Applicability

This command was introduced before OcNOS version 1.3.

### Example

```
#config terminal
(config)#mcec domain configuration
(config-mcec-domain)#intra-domain-link eth2
```



---

## intra-domain-peer

Use this command to map an interface as intra domain peer that connects the domain system with its neighbor in a MCEC domain.

Use the no form of this command to unmap the interface configured as intra domain peer that connects the domain system with its neighbor in a MCEC domain.

### Command Syntax

```
intra-domain-peer A.B.C.D source-address A.B.C.D (vrf VRF_NAME|)
no intra-domain-peer
```

### Parameters

Peer	Address Peer/Target IPv4 address
A.B.C.D	IPv4 address.
source-address	Source IPv4 address
A.B.C.D	IPv4 address
VRF_NAME	VRF Interface name

### Command Mode

MCEC mode

### Applicability

This command was introduced in OcNOS-OTN version 4.2.

### Example

```
#config terminal
(config)#mcec domain configuration
(config-mcec-domain)#intra-domain-peer 1.1.1.1 source-address 2.2.2.2 vrf
myvrf
```

---

## mcec domain configuration

Use this command to enter MCEC Domain configuration mode to configure MCEC domain information.

### Command Syntax

```
mcec domain configuration
```

### Parameters

None

### Command Mode

Configure mode

### Applicability

This command was introduced before OcNOS version 1.3.

### Examples

```
#config terminal
(config)#mcec domain configuration
(config-mcec-domain)#
```

## m lag

Use this command to map a port-channel to an MC-LAG instance.

Note: The MC-LAG port-channel (interface) must be created before mapping.

Note: All MC-LAG nodes must use the same MAC table size.

Use the `no` form of this command to un-map the port channel from the MC-LAG instance.

### Command Syntax

```
m lag <1-255>
```

```
no m lag
```

### Parameters

<1-255>                    MC-LAG identifier

### Command Mode

Interface mode

### Applicability

This command was introduced before OcNOS version 1.3 and updated for static channel groups in OcNOS version 1.3.6.

### Example

```
#config terminal
(config)#interface mlag1
(config-if)#switchport
(config-if)#bridge-group 1
(config-if)#switchport mode trunk
(config-if)#switchport mode trunk allowed vlan all
(config-if)#exit
(config)#interface sa1
(config-if)#switchport
(config-if)#m lag 1
(config-if)#exit
```

```
#configure terminal
(config)#interface sa1
(config-if)#no m lag
```

---

## mode

Use this command to set the MC-LAG mode.

Use the no form of this command to turn off this feature.

### Command Syntax

```
mode (active-active | active-standby)
no mode (active-active | active-standby)
```

### Parameters

`active-active` The interface is the active interface that carries the traffic

`active-standby` The interface is ready to transition to the active state should a failure occur in the other node

### Default

`active-active`

### Command Mode

Interface mode

### Applicability

This command was introduced before OcNOS version 1.3.

### Examples

```
(config)#
(config)#interface mlag1
(config-if)#mode active-active
```

```
(config)#
(config)#interface mlag1
(config-if)#mode active-standby
```

## show mcec statistics

Use this command to display all the statistics related to hello and info pdu's in mcec domain.

### Command Syntax

```
show mcec statistics
```

### Parameters

None

### Command Mode

Privileged Exec mode

### Applicability

This command was introduced before OcNOS version 1.3.

### Examples

```
#sh mcec statistics
Unknown MCCPDU received on the system : 0

-----
IDP xe49
-----
Valid RX Hello PDUs : 109
Valid TX Hello PDUs : 201
Valid RX Info PDUs: 23
Valid TX Info PDUs : 28
Valid RX Mac Sync PDUs : 5
Valid TX Mac Sync PDUs : 4
Valid RX Dhcps Sync PDUs : 2
Valid TX Dhcps Sync PDUs : 1

MLAG 1
Valid RX Info PDUs : 5
Valid TX Info PDUs : 7
```

[Table 6-14](#) Shows the output details.

**Table 6-13: Show mcec statistics details**

Entry	Description
RX Hello PDUs	Total number of received hello PDUs.
TX Hello PDUs	Total number of transmitted hello PDUs.
RX Info PDUs	Total number of received Info PDUs.
TX Info PDUs	Total number of transmitted Info PDUs.

**Table 6-13: Show mcec statistics details**

<b>Entry</b>	<b>Description</b>
RX Mac Sync PDUs	Total number of received Mac Sync PDUs.
TX Mac Sync PDUs	Total number of transmitted Mac Sync PDUs.
RX Dhcps Sync PDUs	Total number of received Dhcps Sync PDUs
TX Dhcps Sync PDUs	Total number of transmitted Dhcps Sync PDUs

## show mlag detail

Use this command to display details about MC-LAG configuration and status.

### Command Syntax

```
show mlag <1-255> detail
```

### Parameters

<1-255>                    MC-LAG group number

### Command Mode

Privileged Exec mode

### Applicability

This command was introduced before OcNOS version 1.3 and updated for static channel groups in OcNOS version 1.3.6.

### Examples

```
#sh mlag 1 detail

MLAG-17
Mapped Aggregator : po1
Admin Key : 32769
Oper Key: 16385
Physical properties Digest : dd 9c f 76 dd b6 5f 2f eb a1 d3 bb 8d 96 fc 82

Neigh Admin Key: 16385
Neigh Physical Digest: dd 9c f 76 dd b6 5f 2f eb a1 d3 bb 8d 96 fc 82
Info RCV State : Current
Info Periodic Time State : Standby
Mlag Sync : IN_SYNC
Mode : Active
```

Table 6-14 Shows the output details.

**Table 6-14: Show mlag output details**

Entry	Description
Mapped Aggregator	Map the output of the aggregator in the interface which is active transformation.
Admin Key	Administrative key: automatically configured value on each port configured to use MC-LAG.
Oper Key	MLAG operator key on partner: automatically configured value on each port configured to use MC-LAG.
Physical properties Digest	Physical properties of the digest.
Neigh Admin Key	Neigh administrative key: automatically configured value on each port configured to use MC-LAG.

**Table 6-14: Show mlag output details**

Entry	Description
Neigh Physical Digest	Neighbor physical properties of the digest.
Info RCV State	Details of the RCV.
Info Periodic Time State	A simple state space formulation of a general digital periodic time series.
Mlag Sync	MAC address synchronization: enables a MC-LAG partner to forward Layer 3 packets arriving on this interfaces with either its own MAC address or its partner's.



---

## show mlag domain

Use this command to display MC-LAG configuration and status.

### Command Syntax

```
show mlag domain (summary|details)
```

### Parameters

summary	Summary
details	Details

### Command Mode

Privileged Exec mode

### Applicability

This command was introduced before OcNOS version 1.3 and updated for static channel groups in OcNOS version 1.3.6.

### Examples

```
#show mlag domain summary
```

```
-----
Domain Configuration
-----

Domain System Number      : 1
Domain Address            : 1111.2222.3333
Domain Priority           : 32768
Intra Domain Interface    : sa5
Domain Adjacency         : UP

-----
MLAG Configuration
-----

MLAG-1
  Mapped Aggregator       : sa1
  Physical properties Digest : d a6 26 2d fa 9a 5c 7b e6 15 79 c2 d5 9c 57
cc
  Total Bandwidth         : 40g
  Mlag Sync               : IN_SYNC
  Mode                    : Active

MLAG-2
  Mapped Aggregator       : sa2
  Physical properties Digest : ae 56 a1 c5 b9 dc 46 a4 5d 97 dc 79 9c 6f a5
c8

  Total Bandwidth         : 40g
  Mlag Sync               : IN_SYNC
  Mode                    : Active
```

```
#show mlag domain details
-----
Domain Configuration
-----
Domain System Number      : 1
Domain Address            : 1111.2222.3333
Domain Priority           : 32768
Intra Domain Interface    : sa5

Hello RCV State           : Current
Hello Periodic Timer State : Slow Periodic
Domain Sync               : IN_SYNC
Neigh Domain Sync         : IN_SYNC
Domain Adjacency          : UP
-----
MLAG Configuration
-----
MLAG-1
  Mapped Aggregator       : sa1
  Admin Key                : 16385
  Oper Key                 : 16385
  Physical properties Digest : d a6 26 2d fa 9a 5c 7b e6 15 79 c2 d5 9c 57
cc

  Neigh Admin Key         : 32769
  Neigh Physical Digest   : d a6 26 2d fa 9a 5c 7b e6 15 79 c2 d5 9c 57
cc

  Info RCV State          : Current
  Info Periodic Time State : Standby
  Total Bandwidth         : 40g
  Mlag Sync               : IN_SYNC

MLAG-2
  Mapped Aggregator       : sa2
  Admin Key                : 16386
  Oper Key                 : 16386
  Physical properties Digest : ae 56 a1 c5 b9 dc 46 a4 5d 97 dc 79 9c 6f a5
c8

  Neigh Admin Key         : 32770
  Neigh Physical Digest   : ae 56 a1 c5 b9 dc 46 a4 5d 97 dc 79 9c 6f a5
c8

  Info RCV State          : Current
  Info Periodic Time State : Standby
  Total Bandwidth         : 40g
  Mlag Sync               : IN_SYNC
```

Table 6-15 Shows the output details.

**Table 6-15: Show mlag summary details**

Entry	Description
Domain System Number	Number to identify the node in domain.
Domain Address	Domain address for the MC-LAG domain.

**Table 6-15: Show mlag summary details**

<b>Entry</b>	<b>Description</b>
Domain Priority	Domain priority for the MC-LAG domain.
Intra Domain Interface	Intra domain interface between MC-LAG domains.
Domain Adjacency	Domain adjacency details and configuration.
Physical properties Digest	physical properties of the digest algorithm.
Total Bandwidth	Total bandwidth available on the interface.
Domain System Number	Number of the domain system.
Domain Address	Domain address for the MC-LAG domain.
Domain Priority	Domain priority for the MC-LAG domain.
Intra Domain Interface	Details of the intra domain in the interface.
Hello RCV State	State of the hello RCV in the interface.
Hello Periodic Timer State	State of the hello periodic timer in the interface.
Domain Sync	Detail of the domain configuration synchronization.
Mapped Aggregator	Map the output of the aggregator in the interface which is active transformation.
Admin Key	Administrative key:automatically configured value on each port configured to use MC-LAG.
Oper Key	MLAG operator key on partner:automatically configured value on each port configured to use MC-LAG.
Physical properties Digest	Physical properties of the digest.
Neigh Admin Key	Neighbot administrative key: automatically configured value on each port configured to use MC-LAG.
Neigh Physical Digest	Neighbor physical properties of the digest.
Info RCV State	Details of the RCV.
Info Periodic Time State	A simple state space formulation of a general digital periodic time series.
Mlag Sync	MAC address synchronization: enables a MC-LAG partner to forward Layer 3 packets arriving on this interfaces with either its own MAC address or its partner's.

---

## show spanning-tree mlag operational-config

Use this command to display the operational information for MC-LAG.

### Command Syntax

```
show spanning-tree mlag operational-config
```

### Parameters

None

### Command Mode

Privilege exec mode

### Applicability

This command was introduced in OcNOS version 1.3.6.

### Examples

```
#show spanning-tree mlag operational-config  
Operational Configuration
```

```
-----  
Bridge Priority          : 32768  
Pathcost method        : Long  
  
Interface               : mlag1  
Pathcost                : 1000  
Priority                : 0
```

---

## show spanning-tree mlag sync-detail

Use this command to display the spanning-tree properties shared with the domain peer node.

### Command Syntax

```
show spanning-tree mlag sync-detail
```

### Parameters

None

### Command Mode

Privilege exec mode

### Applicability

This command was introduced in OcNOS version 1.3.6.

### Examples

```
#show spanning-tree mlag sync-detail
Domain Digest Parameters
```

```
-----
Max Age           : 20
BPDU Filter      : Disabled
BPDU Guard       : Disabled
Hello time       : 2
Forward Delay    : 15
Force Version    : 2
Err-disable status : Disabled
Err-disable timeout : 300
MSTP Enabled     : Enabled
MSTP Bridge Forward : Disabled
```

```
Interface Digest parameters
```

```
-----
Port Name          : mlag1
Admin Root Guard   : Disabled
Admin Edge port    : Disabled
Portfast configuration : Disabled
Restricted TCN     : Disabled
Admin BPDU filter  : Default
Admin BPDU guard   : Default
```

---

## switchover type

Use this command to set the MC-LAG switchover type.

Use the `no` form of this command to turn off switchover.

### Command Syntax

```
switchover type revertive <1-255>
switchover type non-revertive
no switchover type (revertive | non-revertive)
```

### Parameters

<code>revertive</code>	If a failure happens that triggers a switchover, after failure recovery the initially-active node becomes active again
<code>&lt;1-255&gt;</code>	Switch back to the initially-active node this many seconds after failure recovery
<code>non-revertive</code>	Do not switch back to the initially-active node after failure recovery

### Default

```
revertive      in 10 seconds
```

### Command Mode

Interface mode

### Applicability

This command was introduced before OcNOS version 1.3.

### Examples

```
(config)#
(config)#interface mlag1
(config-if)#switchover type revertive 20

(config)#
(config)#interface mlag1
(config-if)#switchover type non-revertive
```

---

## CHAPTER 7 VLAN and Private VLAN Commands

---

This chapter has the commands used to manage VLANs and private VLANs.

- `show dtag vlan`
- `show vlan access-map`
- `show vlan`
- `show vlan brief`
- `show vlan classifier`
- `show vlan-reservation`
- `switchport access`
- `switchport hybrid`
- `switchport mode`
- `switchport mode access ingress-filter`
- `switchport mode hybrid acceptable-frame-type`
- `switchport mode hybrid ingress-filter`
- `switchport mode trunk ingress-filter`
- `switchport trunk allowed`
- `switchport trunk allowed vlan dtag`
- `switchport trunk native`
- `vlan classifier activate`
- `vlan classifier group`
- `vlan classifier rule ipv4`
- `vlan classifier rule mac`
- `vlan classifier rule proto`
- `vlan database`
- `vlan dtag`
- `vlan-reservation`
- `vlan state`
- `vlan VLAN_RANGE bridge`

## show dtag vlan

Use this command to display information about VLAN double tagging.

### Command Syntax

```
show dtag vlan DTAG_VLAN_ID
```

### Parameters

`DTAG-VLAN-IDS` Outer-VLAN identifier and inner-VLAN identifier in the format 100.200, where 100 is the outer tag and 200 is the inner tag

### Command Mode

Exec mode and Privileged Exec mode

### Applicability

This command was introduced before OcnOS version 1.3.

### Example

```
#show dtag vlan 2000.3001
```

[Table 7-16](#) explains the output.

**Table 7-16: show dtag vlan output**

Field	Description
Bridge	Bridge number
VLAN ID	VLAN identifier
Name	Double tag-VLAN identifiers
State	VLAN state: ACTIVE, SUSPEND, or INVALID
H/W Status	Hardware status: UP or DOWN
Member ports	Interfaces that are part of the VLAN and whether untagged (u) or tagged (t)



---

## show vlan access-map

Use this command to display information for VLAN access maps.

### Command Syntax

```
show vlan access-map
```

### Parameters

None

### Command Mode

Exec mode and Privileged Exec mode

### Applicability

This command was introduced before OcNOS version 1.3.

### Example

```
#show vlan access-map
Vlan access-map myMap 10
    match ip: myMap
    action: drop
```

## show vlan

Use this command to display information about static, dynamic or all VLANs.

### Command Syntax

```
show vlan (all|static|dynamic|auto) bridge <1-32>
```

### Parameters

<1-32>	Displays the bridge group ID.
all	Displays all VLANs (static and dynamic).
static	Displays static VLANs.
dynamic	Displays dynamic VLANs.
auto	Displays auto configured VLANs.

### Command Mode

Exec mode and Privileged Exec mode

### Applicability

This command was introduced before OcNOS version 1.3.

### Example

```
#sh vlan all bridge 1
Bridge  VLAN ID      Name                State  H/W Status      Member ports
      (u)-Untagged, (t)-Tagged
=====
1       1       default            ACTIVE Up              xe2(u) xe10(u)
1       2       vlan2              ACTIVE Up              xe10(t)
1       10      VLAN0010           ACTIVE Up              xe2(t) xe10(t)
1       20      VLAN0020           ACTIVE Up              xe2(t) xe10(t)
1       30      VLAN0030           ACTIVE Up              xe10(t)
1       40      VLAN0040           ACTIVE Up              xe10(t)
1       50      VLAN0050           ACTIVE Up              xe10(t)
1       60      VLAN0060           ACTIVE Up              xe10(t)
#
```

Table 7-17 Explains the show command output fields.

**Table 7-17: show vlan output fields**

**Table 7-18:**

Field	Description
Bridge	Number of bridge in the interface.
VLAN ID	VLAN identifier of the VLAN listed.
Name	Name of the VLAN.
State	Indicates whether the physical link is operational and can pass packets.

**Table 7-18:**

---

<b>Field</b>	<b>Description</b>
H/W Status	Indicates that the hardware is operational.
Member ports	The tagged interfaces to which a VLAN is associated.

## show vlan brief

Use this command to display brief VLAN information for all bridges.

### Command Syntax

```
show vlan (brief | <2-4094>)
```

### Parameters

None

### Command Mode

Exec mode and Privileged Exec mode

### Applicability

This command was introduced before OcnOS version 1.3.

### Example

The following is a sample output from this command when using the `all` parameter.

```
#show vlan brief
```

```
Bridge          VLAN ID  Name          State  Member ports
=====
1              1      default      ACTIVE eth2 (u)
              1      default      ACTIVE
0              2      new          ACTIVE
```

[Table 7-19](#) Explains the show command output fields.

**Table 7-19: show vlan brief output fields**

**Table 7-20:**

Field	Description
Bridge	Number of bridge in the interface.
VLAN ID	VLAN identifier of the VLAN listed.
Name	Name of the VLAN.
State	Indicates whether the physical link is operational and can pass packets.
H/W Status	Indicates that the hardware is operational.
Member ports	The tagged interfaces to which a VLAN is associated.

---

## show vlan classifier

Use this command to display information on configured VLAN classifier groups, interfaces configured for a VLAN group or all the groups, or all configured VLAN classifier rules.

If either a group ID or rule ID is not specified, all configured VLAN classifier rules are shown. If either a group ID or rule ID is specified, a specific configured VLAN classifier rule is shown.

### Command Syntax

```
show vlan classifier group interface IFNAME
show vlan classifier group (<1-16>|)
show vlan classifier rule(<1-256>|)
```

### Parameters

group	Displays group activated information.
<1-16>	Displays the group ID
interface	Displays interface information.
interface	Displays interface group information.
group	Displays group activated information.
<1-16>	Displays the group ID.
rule	Displays VLAN classifier rule ID.
<1-256>	Displays rule ID information.

### Command Mode

Exec mode and Privileged Exec mode

### Applicability

This command was introduced before OcNOS version 1.3.

### Example

This example displays groups for VLAN classifier groups:

```
#show vlan classifier group 1
vlan classifier group 1 add rule 1
```

This example displays interfaces for all VLAN classifier groups:

```
#show vlan classifier interface group
vlan classifier group 1 interface fe2
vlan classifier group 1 interface fe3
vlan classifier group 2 interface fe5
vlan classifier group 3 interface fe7
```

This example displays interfaces for VLAN classifier group 1:

```
#show vlan classifier interface group 1
vlan classifier group 1 interface fe2
vlan classifier group 1 interface fe3
```

This example displays interfaces for VLAN classifier rule 1:

```
#show vlan classifier rule 1  
vlan classifier rule 1 mac 222.2222.2222 vlan 2
```

---

## show vlan-reservation

Use this command to display reserved vlans that are configured via vlan-reservation configuration on the switch.

### Command Syntax

```
show vlan-reservation
```

### Parameters

None

### Command Mode

Exec mode

### Applicability

This command was introduced before OcNOS version 5.1.

### Example

```
OcNOS#show vlan-reservation
VLAN ID      Status
=====      =====
500          free
501          free
502          free
503          free
504          free
505          free
506          free
507          free
508          free
509          free
510          free
OcNOS#
```

If user enables port breakout on any of the interface

```
OcNOS(config)#interface xe54/1
OcNOS(config-if)#port breakout enable
OcNOS(config-if)#commit
```

Each subsidiary ports 54/2, 54/3, 54/4 will get vlan-id from the vlan-reservation pool and the status of vlan-id changes to "allocated".

```
OcNOS#show vlan-reservation
VLAN ID      Status
=====      =====
500          allocated
501          allocated
502          allocated
503          free
504          free
505          free
```

## VLAN and Private VLAN Commands

---

```
506          free
507          free
508          free
509          free
510          free
OcNOS#
```

Note: From OcNOS version 5.1, it is mandatory to configure vlan-reservation prior to port breakout configuration.



---

## switchport access

Use this command to change the default VLAN on the current interface.

Note: IP Infusion Inc. does not recommend using VLAN identifier 1 because of interoperability issues with other vendors' equipment.

Use the `no` parameter to remove an existing VLAN.

### Command Syntax

```
switchport access vlan <2-4094>
no switchport access vlan
```

### Parameter

<2-4094>            Specify the VLAN identifier.

### Default

The switchport access vlan default value is 3968.

### Command Mode

Interface mode

### Applicability

This command was introduced before OcnOS version 1.3.

### Examples

This example shows the steps of a typical VLAN session, creating and destroying a VLAN.

```
#configure terminal
(config)#interface eth0
(config-if)#switchport access vlan 3

(config)#interface eth0
(config-if)#no switchport access vlan
```

## switchport hybrid

Use this command to set the switching characteristics of the interface to hybrid. Both tagged and untagged frames will be classified over hybrid interfaces.

For a VLAN range, specify two VLAN identifiers: the lowest and then the highest separated by a hyphen. For a VLAN list, specify the VLAN identifiers separated by commas. Do not enter spaces between the hyphens or commas.

Use the `no` parameter to turn off allowed hybrid switching.

### Command Syntax

```
switchport hybrid allowed vlan all
switchport hybrid vlan <2-4094>
switchport hybrid allowed vlan none
switchport hybrid allowed vlan except VLAN_ID
switchport hybrid allowed vlan remove VLAN_ID
switchport hybrid allowed vlan add VLAN_ID egress-tagged (enable|disable)
no switchport hybrid
no switchport hybrid vlan
```

### Parameters

<code>all</code>	Allow all VLANs to transmit and receive through the interface.
<code>none</code>	Allow no VLANs to transmit and receive through the interface.
<code>except</code>	Allow all VLANs except these VLANs to transmit and receive through the interface.
<code>VLAN_ID</code>	VLAN identifier(s) <2-4094>. You can specify a single VLAN, a VLAN range, or a VLAN list.
<code>remove</code>	Remove these VLANs from the member set.
<code>VLAN_ID</code>	VLAN identifier(s) <2-4094>. You can specify a single VLAN, a VLAN range, or a VLAN list.
<code>add</code>	Add these VLANs to the member set.
<code>VLAN_ID</code>	VLAN identifier(s) <2-4094>. You can specify a single VLAN, a VLAN range, or a VLAN list.
<code>egress-tagged</code>	Whether to tag outgoing frames.
<code>enable</code>	Enable egress tagging for outgoing frames.
<code>disable</code>	Disable egress tagging for outgoing frames.

### Default

By default, `switchport hybrid` is enabled.

### Command Mode

Interface mode

### Applicability

This command was introduced before OcNOS version 1.3.

**Examples**

The following shows adding a single VLAN to the member set.

```
(config-if)#switchport hybrid allowed vlan add eg  
switchport hybrid allowed vlan add 2 egress-tagged enable
```

The following shows adding a range of VLANs to the member set.

```
(config-if)#switchport hybrid allowed vlan add eg  
switchport hybrid allowed vlan add 2-4 egress-tagged enable
```

---

## switchport mode

Use this command to set the switching characteristics of the Layer 2 interface.

### Command Syntax

```
switchport mode (access|hybrid|trunk|provider-network|customer-edge  
|customer-network|private-vlan)
```

### Parameters

access	Access.
hybrid	Hybrid.
trunk	Trunk.
provider-network	Provider network.
customer-network	Customer network.

### Default

By default, switchport mode hybrid is enabled.

Configuring an interface to operate in trunk mode using the CLI command `switchport mode trunk` will automatically permit VLAN ID 1 on the trunk ports by default.

### Command Mode

Interface mode

### Applicability

This command was introduced before OcnOS version 1.3.

### Example

```
#configure terminal  
(config)#interface eth0  
(config-if)#switchport mode access
```

---

## switchport mode access ingress-filter

Use this command to set the switching characteristics of the interface to access mode, and classify untagged frames only. Received frames are classified based on the VLAN characteristics, then accepted or discarded based on the specified filtering criteria.

### Command Syntax

```
switchport mode access ingress-filter (enable|disable)
```

### Parameters

<code>ingress-filter</code>	Set the ingress filtering for the received frames.
<code>enable</code>	Set the ingress filtering for received frames. Received frames that cannot be classified in the previous step based on the acceptable frame type parameter (access/trunk) are discarded. This is the default value.
<code>disable</code>	Turn off ingress filtering to accept frames that do not meet the classification criteria.

### Default

Received frames that cannot be classified in the previous step based on the acceptable frame type parameter (access/trunk) are discarded.

### Command Mode

Interface mode

### Applicability

This command was introduced before OcnOS version 1.3.

### Example

```
#configure terminal
(config)#interface eth0
(config-if)#switchport mode access ingress-filter enable
```

---

## switchport mode hybrid acceptable-frame-type

Use this command to set the interface acceptable frame types. This processing occurs after VLAN classification.

Use `no` form of this command to unconfigure the interface acceptable frames.

### Command Syntax

```
switchport mode hybrid acceptable-frame-type (all|vlan-tagged)
no switchport hybrid
```

### Parameters

<code>all</code>	Set all frames can be received
<code>vlan-tagged</code>	Accept only classified frames that belong to the port's member set.

### Default

Received frames that cannot be classified in the previous step based on the acceptable frame type parameter (access/trunk) are discarded.

### Command Mode

Interface mode

### Applicability

This command was introduced before OcnOS version 1.3.

### Example

```
#configure terminal
(config)#interface eth0
(config-if)#switchport mode hybrid acceptable-frame-type vlan-tagged
```

---

## switchport mode hybrid ingress-filter

Use this command to set the switching characteristics of the interface as hybrid, and classify both tagged and untagged frames. Received frames are classified based on the VLAN characteristics, then accepted or discarded based on the specified filtering criteria.

### Command Syntax

```
switchport mode hybrid ingress-filter (enable|disable)
```

### Parameters

enable	Set the ingress filtering for received frames. Received frames that cannot be classified in the previous step based on the acceptable frame type parameter (access/trunk) are discarded. This is the default value.
disable	Turn off ingress filtering to accept frames that do not meet the classification criteria.

### Default

Received frames that cannot be classified in the previous step based on the acceptable frame type parameter (access/trunk) are discarded.

### Command Mode

Interface mode

### Applicability

This command was introduced before OcnOS version 1.3.

### Examples

```
#configure terminal
(config)#interface eth0
(config-if)#switchport mode hybrid ingress-filter enable
```

---

## switchport mode trunk ingress-filter

Use this command to set the switching characteristics of the interface as trunk, and specify only tagged frames. Received frames are classified based on the VLAN characteristics, then accepted or discarded based on the specified filtering criteria.

### Command Syntax

```
switchport mode trunk ingress-filter (enable|disable)
```

### Parameters

<code>ingress-filter</code>	Set the ingress filtering for the received frames.
<code>enable</code>	Set the ingress filtering for received frames. Received frames that cannot be classified in the previous step based on the acceptable frame type parameter (access/trunk) are discarded. This is the default value.
<code>disable</code>	Turn off ingress filtering to accept frames that do not meet the classification criteria.

### Default

Received frames that cannot be classified in the previous step based on the acceptable frame type parameter (access/trunk) are discarded.

### Command Mode

Interface mode

### Applicability

This command was introduced before OcNOS version 1.3.

### Examples

```
#configure terminal
(config)#interface eth0
(config-if)#switchport mode trunk ingress-filter enable
```



---

## switchport trunk allowed

Use this command to set the switching characteristics of the interface to trunk.

For a VLAN range, specify two VLAN identifiers: the lowest and then the highest separated by a hyphen. For a VLAN list, specify the VLAN identifiers separated by commas. Do not enter spaces between the hyphens or commas.

Use the `no` parameter to remove all VLAN identifiers configured on this port.

### Command Syntax

```
switchport trunk allowed vlan all
switchport trunk allowed vlan none
switchport trunk allowed vlan add VLAN_ID
switchport trunk allowed vlan except VLAN_ID
switchport trunk allowed vlan remove VLAN_ID
no switchport trunk
```

### Parameters

<code>all</code>	Allow all VLANs to transmit and receive through the interface.
<code>none</code>	Allow no VLANs to transmit and receive through the interface.
<code>add</code>	Add these VLANs to the member set.
<code>VLAN_ID</code>	VLAN identifier(s) <2-4094>. You can specify a single VLAN, a VLAN range, or a VLAN list.
<code>except</code>	All VLANs except these VLANs are part of the member set.
<code>VLAN_ID</code>	VLAN identifier(s) <2-4094>. You can specify a single VLAN, a VLAN range, or a VLAN list.
<code>remove</code>	Remove these VLANs from the member set.
<code>VLAN_ID</code>	VLAN identifier(s) <2-4094>. You can specify a single VLAN, a VLAN range, or a VLAN list.

### Default

Received frames that cannot be classified in the previous step based on the acceptable frame type parameter (access/trunk) are discarded.

### Command Mode

Interface mode

### Applicability

This command was introduced before OcnOS version 1.3.

### Examples

The following shows adding a single VLAN to the port's member set.

```
(config)#interface eth0
(config-if)#switchport trunk allowed vlan add 2
```

The following shows adding a range of VLANs to the port's member set.

```
(config)#interface eth0  
(config-if)#switchport trunk allowed vlan add 2-4
```

---

## switchport trunk allowed vlan dtag

Use this command to maintain a mapping between the double-tagged logical interfaces with the physical interfaces for the purpose of enabling VLAN-translation on the port alone.

An example of when to use this command is in a GPON application, where an S-tag uniquely identifies an OLT channel partition and a C-tag uniquely identifies a subscriber/service on that channel partition.

### Command Syntax

```
switchport trunk allowed vlan add dtag DTAG-VLAN-IDs
switchport trunk allowed vlan remove dtag DTAG-VLAN-IDs
```

### Parameters

add	Add a mapping
remove	Remove a mapping
DTAG-VLAN-IDs	Outer-VLAN identifier and inner-VLAN identifier in the format 100.200, where 100 is the outer tag and 200 is the inner tag

### Default

None

### Command Mode

Interface mode

### Applicability

This command was introduced before OcnOS version 1.3.

### Examples

```
(config)#int mlag1
(config-if)#switchport
(config-if)#bridge-group 1
(config-if)#switchport mode trunk
(config-if)#switchport trunk allowed vlan add 100,2000
(config-if)#switchport trunk allowed vlan add dtag 2000.3001
```

## switchport trunk native

Use this command to configure native VLANs for this port. The native VLAN is used for classifying the incoming untagged packets.

Use the `no` parameter to revert the native VLAN to the default VLAN identifier 1.

### Command Syntax

```
switchport trunk native vlan VLAN_ID
no switchport trunk native vlan
```

### Parameter

VLAN_ID	VLAN identifier(s) <1-4094>. You can specify a single VLAN, or a VLAN list. For a VLAN list, specify the VLAN identifiers separated by commas. Do not enter spaces in between the hyphens or commas.
---------	---

### Default

The default is that ingress filtering is off and all frame types are classified and accepted.

### Command Mode

Interface mode

### Applicability

This command was introduced before OcNOS version 1.3.

### Examples

```
#configure terminal
(config)#interface eth0
(config-if)#switchport trunk native vlan 2

(config)#interface eth0
(config-if)#no switchport trunk native vlan
```

---

## vlan classifier activate

Use this command to activate the VLAN classifier.

Use no form of this command to deactivate the VLAN classifier.

### Command Syntax

```
vlan classifier activate <1-16> vlan <2-4096>  
no vlan classifier activate <1-16>
```

### Parameters

<1-16>	Indicates the VLAN classifier activate identifier.
<2-4094>	VLAN identifier of the primary VLAN.

### Default

By default, vlan classifier activate value is 1

### Command Mode

Interface mode

### Applicability

This command was introduced before OcnOS version 1.3.

### Example

```
#configure terminal  
(config)#interface eth2  
(config-if)#vlan classifier activate 1 vlan 2  
  
(config-if)#no vlan classifier activate 1
```

---

## vlan classifier group

Use this command to create a subnet-based VLAN classifier group. A group indicates a VLAN classifier group ID.

### Command Syntax

```
vlan classifier group <1-16> (add | delete) rule <1-256>  
no vlan classifier group <1-16>
```

### Parameters

add	Adds a rule to a group.
delete	Deletes a rule from a group.
rule	Indicates the VLAN classifier rule identifier <1-256>.

### Default

By default, vlan classifier group value is 1

### Command Mode

Configure mode

### Applicability

This command was introduced before OcnOS version 1.3.

### Example

```
#configure terminal  
(config)#vlan classifier group 1 delete rule 1  
(config)#no vlan classifier group 2
```

---

## vlan classifier rule ipv4

Use this command to create a subnet-based VLAN classifier rule and map it to a specific VLAN. If the source IP address matches the IP subnet specified in the VLAN classifier rule, received packets are mapped to the designated VLAN.

### Command Syntax

```
vlan classifier rule <1-256> ipv4 A.B.C.D/M
no vlan classifier rule <1-256>
```

### Parameters

A.B.C.D/M                      Indicates the IPv4 address classification. Enter the address in A.B.C.D/M format.

### Default

By default, vlan classifier rule is VLAN1

### Command Mode

Configure mode

### Applicability

This command was introduced before OcnOS version 1.3.

### Example

```
#configure terminal
(config)#vlan classifier rule 2 ipv4 20.20.20.2/24
(config)#no vlan classifier rule 2
```

---

## vlan classifier rule mac

Use this command to create a subnet-based VLAN classifier rule and map it to a specific VLAN.

If the source IP address matches the IP subnet specified in the VLAN classifier rule, received packets are mapped to the designated VLAN.

### Command Syntax

```
vlan classifier rule <1-256> mac WORD
no vlan classifier rule <1-256>
```

### Parameters

WORD                      Indicate the Mac address classification. Enter the address in HHHH.HHHH.HHHH format.

### Default

By default, vlan classifier rule value is VLAN1

### Command Mode

Configure mode

### Applicability

This command was introduced before OcNOS version 1.3.

### Example

```
#configure terminal
(config)#vlan classifier rule 2 mac fe80::22e::b5ff:fee8:6/64
(config)#no vlan classifier rule 2
```



---

## vlan classifier rule proto

Use this command to create a subnet-based VLAN classifier rule for a protocol and map it to a specific VLAN. If the source IP address matches the IP subnet specified in the VLAN classifier rule, received packets are mapped to the designated VLAN.

### Command Syntax

```
vlan classifier rule <1-256> proto
  (ETHERTYPE|ip|x25|arp|g8bpqx25|ieeepup|ieeeaddrtrans|dec|decnadumpload|decnare
  moteconsole|decnارouting|declat|decdiagnostics|rarp|atalkddp|atalkaarp|ipx|ipv6
  |atmmulti|pppdiscovery|pppsession|atmtransport)
no vlan classifier rule <1-256>
```

### Parameters

ETHERTYPE	Ethernet type
ip	IP address
x25	CCITT X.25
arp	Address Resolution Protocol
g8bpqx25	G8BPQ AX.25
ieeepup	Xerox IEEE802.3 PUP
ieeeaddrtrans	Xerox IEEE802.3 PUP Address Translation
dec	DEC Assigned
decnadumpload	DEC DNA Dump/Load
decnaremoteconsole	DEC DNA Remote Console
decnارouting	DEC DNA Routing
declat	DEC LAT
decdiagnostics	EC Diagnostics
rarp	Reverse Address Resolution
atalkddp	Appletalk DDP
atalkaarp	Appletalk AARP
ipx	IPX address
ipv6	IPv6 address
atmmulti	MultiProtocol Over ATM
pppdiscovery	PPPoE discovery
pppsession	PPPoE session
atmtransport	Frame-based ATM Transport
deccustom	DEC Customer use
decsyscomm	DEC Systems Comms Arch
xeroxaddrtrans	Xerox PUP Address Translation

### **Default**

By default, VLAN classifier rule value is VLAN1

### **Command Mode**

Configure mode

### **Applicability**

This command was introduced before OcnOS version 1.3.

### **Example**

```
#configure terminal
(config)#vlan classifier rule 2 proto ip
(config)#no vlan classifier rule 2
```

---

## vlan database

Use this command to enter the VLAN configuration mode to add, delete, or modify values associated with a single VLAN.

### Command Syntax

```
vlan database
```

### Parameters

None

### Default

No default value is specified

### Command Mode

Configure mode

### Applicability

This command was introduced before OcNOS version 1.3.

### Example

In the following example, note the change to VLAN configuration mode from Configure mode:

```
#configure terminal
(config)#vlan database
(config-vlan)#
```

---

## vlan dtag

Use this command to enable or disable double tagging packets with an outer-VLAN identifier and an inner-VLAN identifier.

An example of when to use this command is in a GPON application, where an S-tag uniquely identifies an OLT channel partition and a C-tag uniquely identifies a subscriber/service on that channel partition.

Use the `no` form of this command to not double tag packets.

### Command Syntax

```
vlan dtag DTAG-VLAN-IDs bridge <1-32> state (enable|disable) subscriber
no vlan dtag DTAG-VLAN-IDs bridge <1-32>
```

### Parameters

DTAG-VLAN-IDs	Outer-VLAN identifier and inner-VLAN identifier in the format 100.200, where 100 is the outer tag and 200 is the inner tag
<1-32>	Bridge number
enable	Enable double tagging
disable	Suspend double tagging

### Default

No default value is specified

### Command Mode

VLAN database mode

### Applicability

This command was introduced before OcNOS version 1.3.

### Example

```
(config)#vlan database
(config-vlan)#vlan dtag 2000.3001 bridge 1 state enable subscriber
```

---

## vlan-reservation

Use this command to create/delete vlan reservation pool on the switch.

### Command Syntax

```
vlan-reservation VLAN_RANGE  
no vlan-reservation VLAN_RANGE
```

### Parameters

VLAN\_RANGE      VLAN ID 2-4094 or range(s): 2-5,10 or 2-5,7-19

### Default

No default value is specified

### Command Mode

Configure mode

### Applicability

This command was introduced before OcnOS version 5.1.

### Example

In the following example, note the change to VLAN configuration mode from Configure mode:

```
#configure terminal  
(config)#vlan database  
(config-vlan)#
```

---

## vlan state

This command enables or disables the state of a particular VLAN on the bridge.

### Command Syntax

```
vlan <2-4094> bridge <1-32> (state (enable|disable) |)
```

### Parameters

<1-32>	Specify bridge group ID
state	Indicates the operational state of the VLAN
enable	Sets VLAN into a enable state.
disable	Sets VLAN into a disable state.
name	The VLAN name
WORD	The name of the VLAN

### Default

By default, vlan bridge state is disabled.

### Command Mode

VLAN Configuration mode

### Applicability

This command was introduced before OcNOS version 1.3.

### Examples

```
#configure terminal
(config)#vlan database
(config-vlan)#vlan 45 bridge 1 state enable
```

---

## vlan VLAN\_RANGE bridge

.This command allows you to create a single/range of VLAN's on the VLAN aware bridges.

Use the no form of this command to delete the VLAN.

### Command Syntax

```
vlan VLAN_RANGE bridge <1-32>
vlan VLAN_RANGE bridge <1-32> (name WORD|) state (enable | disable)
no vlan VLAN_RANGE bridge <1-32>
```

### Parameters

VLAN_RANGE	The vlan-id or range of vlan-id's separated by ','&'-'
bridge	Specify the bridge group ID in the range <1-32>.
state	Indicates the operational state of the VLAN.
enable	Sets VLAN into an enable state.
disable	Sets VLAN into a disable state.

### Default

By default, vlan bridge state is disabled

### Command Mode

Configuration Mode

### Applicability

This command was introduced before OcnOS version 1.3.

### Examples

```
(config)#vlan 3-40,56 bridge 4
(config)#no vlan 2-5 bridge 2
```





---

## CHAPTER 8 802.1x Commands

---

This chapter provides a description, syntax, and examples of the 802.1X commands. It includes the following commands:

- `auth-mac auth-fail-action`
- `auth-mac disable`
- `auth-mac dynamic-vlan-creation`
- `auth-mac enable`
- `auth-mac mac-aging`
- `auth-mac system-auth-ctrl`
- `debug dot1x`
- `dot1x initialize`
- `dot1x keytxenabled`
- `dot1x port-control`
- `dot1x protocol-version`
- `dot1x quiet-period`
- `dot1x reauthMax`
- `dot1x reauthentication`
- `dot1x system-auth-ctrl`
- `dot1x timeout re-authperiod`
- `dot1x timeout server-timeout`
- `dot1x timeout supp-timeout`
- `dot1x timeout tx-period`
- `ip radius source-interface`
- `radius-server dot1x deadtime`
- `radius-server dot1x host`
- `radius-server dot1x key`
- `radius-server dot1x retransmit`
- `radius-server dot1x timeout`
- `show debugging dot1x`
- `show dot1x`
- `snmp restart auth`

---

## auth-mac auth-fail-action

Use this command to specify the required action after authentication fails for any source MAC (Media Access Control). If `drop-traffic` is specified, data destined to that MAC is dropped. The MAC will be added to the forwarding database in Discarded mode.

If `restrict-vlan` is specified, the unauthorized MAC is added to a restricted VLAN. The MAC will be added to the forwarding database in Forwarding mode.

### Command Syntax

```
auth-mac auth-fail-action (restrict-vlan <2-4094>|drop-traffic)
```

### Parameters

<code>drop-traffic</code>	Drops traffic destined to unauthorized source.
<code>restrict-vlan</code>	Adds unauthorized MAC address to restricted VLAN.
<code>&lt;2-4094&gt;</code>	Identity of the VLAN in the range of <code>&lt;2-4094&gt;</code> .

### Default

`drop-traffic`

### Command Mode

Interface mode

### Applicability

This command was introduced before OcnOS version 1.3.

### Example

```
#configure terminal
(config)#interface eth0
(config-if)#auth-mac auth-fail-action restrict-vlan 12
```

---

## auth-mac disable

Use this command to disable MAC authentication on an interface. See the [auth-mac enable](#) command to enable MAC authentication on a interface.

### Command Syntax

```
auth-mac disable
auth-mac disable mode (filter|shutdown)
```

### Parameters

mode	Use this parameter to disable the MAC authentication mode on an interface.
filter	Filter the frames for the MAC when in an unauthorized state.
shutdown	Shut down the interface when the MAC is unauthenticated.

### Default

No default value is specified.

### Command Mode

Interface mode

### Applicability

This command was introduced before OcnOS version 1.3.

### Example

```
#configure terminal
(config)#interface eth0
(config-if)#auth-mac disable

#configure terminal
(config)#interface eth0
(config-if)#auth-mac disable mode filter

(config)#interface eth0
(config-if)#auth-mac disable mode shutdown
```

---

## auth-mac dynamic-vlan-creation

Use this command to enable or disable dynamic VLAN creation after successful MAC authentication.

### Command Syntax

```
auth-mac dynamic-vlan-creation (enable|disable)
```

### Parameters

disable	Disables dynamic VLAN creation: after a successful authentication, the MAC will be added to the forwarding database with the default VLAN
enable	Enables dynamic VLAN creation: after a successful authentication, the MAC under authentication will be added to the VLAN identifier attribute in the radius server configuration file

### Default

Disabled

### Command Mode

Interface mode

### Applicability

This command was introduced before OcnOS version 1.3.

### Examples

```
#configure terminal
(config)#interface eth0
(config-if)#auth-mac dynamic-vlan-creation disable

#configure terminal
(config)#interface eth0
(config-if)#auth-mac dynamic-vlan-creation enable
```

---

## auth-mac enable

Use this command to enable MAC authentication on an interface. See the [auth-mac disable](#) command to disable MAC authentication on an interface.

### Command Syntax

```
auth-mac enable
auth-mac enable mode (filter|shutdown)
```

### Parameters

mode	Use this parameter to enable the MAC authentication mode on an interface.
filter	Filter the frames for the MAC when in an unauthorized state.
shutdown	Shut down the interface when the MAC is unauthenticated.

### Default

By default, MAC authentication is globally disabled on the device.

### Command Mode

Interface mode

### Applicability

This command was introduced before OcnOS version 1.3.

### Example

```
#configure terminal
(config)#interface eth0
(config-if)#auth-mac enable

#configure terminal
(config)#interface eth0
(config-if)#auth-mac enable mode filter

(config)#interface eth0
(config-if)#auth-mac enable mode shutdown
```

---

## auth-mac mac-aging

Use this command to either enable or disable MAC aging. When enabled, a MAC entry is added to the forwarding database, with aging time equal to the bridge aging time. Otherwise, the MAC entry will not be aged out. If MAC aging is disabled, the MAC entry will not be aged out.

### Command Syntax

```
auth-mac mac-aging (enable|disable)
```

### Parameters

disable	Disables MAC aging.
enable	Enables MAC aging.

### Default

Disabled.

### Command Mode

Interface mode

### Applicability

This command was introduced before OcnOS version 1.3.

### Example

```
#configure terminal
(config)#interface eth0
(config-if)#auth-mac mac-aging disable

#configure terminal
(config)#interface eth0
(config-if)#auth-mac mac-aging enable
```

---

## auth-mac system-auth-ctrl

Use this command to enable MAC authentication globally. If MAC authentication is not enabled, other MAC authentication related commands throw an error when issued.

Use the `no` parameter with this command to disable MAC authentication globally.

### Command Syntax

```
auth-mac system-auth-ctrl
no auth-mac system-auth-ctrl
```

### Parameters

None

### Default

Authentication system messages are not displayed.

### Command Mode

Configure mode

### Applicability

This command was introduced before OcNOS version 1.3.

### Examples

```
#configure terminal
(config)#auth-mac system-auth-ctrl

(config)#no auth-mac system-auth-ctrl
```

## debug dot1x

Use this command to turn on or turn off 802.1x debugging at various levels.

Use the `no` parameter with this command or the `undebug` command to turn off debugging.

### Command Syntax

```
debug dot1x (all|)
debug dot1x event
debug dot1x nsm
debug dot1x packet
debug dot1x timer
no debug dot1x (all|)
no debug dot1x event
no debug dot1x nsm
no debug dot1x packet
no debug dot1x timer
undebug dot1x (all|)
undebug dot1x event
undebug dot1x packet
undebug dot1x nsm
undebug dot1x timer
```

### Parameters

<code>all</code>	Sets debugging for all 802.1x levels.
<code>event</code>	Sets debugging for 802.1x events.
<code>nsm</code>	Sets debugging for 802.1x NSM information.
<code>packet</code>	Sets debugging for 802.1x packets.
<code>timer</code>	Sets debugging for 802.1x timer.

### Default

No default value is specified.

### Command Mode

Exec, Privileged Exec, and Configure modes

### Applicability

This command was introduced before OcNOS version 1.3.

### Examples

```
#configure terminal
(config)#debug dot1x all
(config)#debug dot1x event
```



---

## dot1x initialize

Use this command to unauthorize a port, and attempt reauthentication on the specified interface.

### Command Syntax

```
dot1x initialize interface IFNAME
```

### Parameters

interface      Interface name.

### Default

No default value is specified.

### Command Mode

Privileged Exec

### Applicability

This command was introduced before OcNOS version 1.3.

### Examples

```
#dot1x initialize interface eth0
```

---

## dot1x keytxenabled

Use this command to enable or disable key transmission over an Extensible Authentication Protocol (EAP) packet between the authenticator and supplicant.

### Command Syntax

```
dot1x keytxenabled (enable|disable)
```

### Parameters

disable	Disables the key transmission.
enable	Enables the key transmission.

### Default

The dot1x keytxenabled default is disabled.

### Command Mode

Interface mode

### Applicability

This command was introduced before OcNOS version 1.3.

### Example

```
#configure terminal
(config)#interface eth0
(config-if) #dot1x keytxenabled disable

#configure terminal
(config)#interface eth0
(config-if) #dot1x keytxenabled enable
```

---

## dot1x port-control

Use this command to force a port state.

Use the `no` parameter with this command to remove a port from the 802.1x management.

### Command Syntax

```
dot1x port-control dir (in|both)
dot1x port-control (force-unauthorized|force-authorized|auto)
no dot1x port-control
```

### Parameters

<code>auto</code>	Specify to enable authentication on port.
<code>dir</code>	Specify the packet control direction.
<code>both</code>	Discard receive and transmit packets from the supplicant
<code>in</code>	Discard receive packets from the supplicant
<code>force-authorized</code>	Specify to force a port to always be in an authorized state.
<code>force-unauthorized</code>	Specify to force a port to always be in an unauthorized state.

### Default

The dot1x port-control default is active.

### Command Mode

Interface mode

### Applicability

This command was introduced before OcnOS version 1.3.

### Examples

```
#configure terminal
(config)#interface eth0
(config-if)#dot1x port-control auto

(config)#interface eth0
(config-if)#no dot1x port-control
```

## dot1x protocol-version

Use this command to set the protocol version of dot1x to 1 or 2. The protocol version must be synchronized with the Xsupplicant being used in that interface.

Use the `no` parameter with this command to set the protocol version to the default value (2).

### Command Syntax

```
dot1x protocol-version <1-2>
no dot1x protocol-version
```

### Parameters

<1-2>                      Indicates the EAP Over LAN (EAPOL) version.

### Default

The default dot1x protocol version is 2.

### Command Mode

Interface mode

### Applicability

This command was introduced before OcNOS version 1.3.

### Example

```
#configure terminal
(config)#interface eth0
(config-if)#dot1x protocol-version 2

(config)#interface eth0
(config-if)#no dot1x protocol-version
```

---

## dot1x quiet-period

Use this command to set the quiet-period time interval.

When a switch cannot authenticate a client, the switch remains idle for a quiet-period interval of time, then tries again. By administratively changing the quiet-period interval, by entering a lower number than the default, a faster response time can be provided.

Use the `no` parameter with this command to set the configured quiet period to the default (60 seconds).

### Command Syntax

```
dot1x quiet-period <1-65535>
no dot1x quiet-period
```

### Parameter

<1-65535>           Seconds between the retrial of authentication.

### Default

The default dot1x protocol version is 2.

### Command Mode

Interface mode

### Applicability

This command was introduced before OcnOS version 1.3.

### Example

```
#configure terminal
(config)#interface eth0
(config-if)#dot1x quiet-period 200
```

## dot1x reauthMax

Use this command to set the maximum reauthentication value, which sets the maximum number of reauthentication attempts after which the port will be unauthorized.

Use the `no` parameter with this command to set the reauthentication maximum to the default value (2).

### Command Syntax

```
dot1x reauthMax <1-10>
no dot1x reauthMax
```

### Parameter

<1-10>	Indicates the maximum number of reauthentication attempts after which the port will be unauthorized.
--------	--

### Default

The default is 2.

### Command Mode

Interface mode

### Applicability

This command was introduced before OcNOS version 1.3.

### Examples

The following sets the maximum reauthentication value to 5.

```
#configure terminal
(config)#interface eth0
(config-if)#dot1x reauthMax 5
```

The following sets the reauthentication maximum to the default value.

```
#configure terminal
(config)#interface eth0
(config-if)#no dot1x reauthMax
```

---

## dot1x reauthentication

Use this command to enable reauthentication on a port.

Use the `no` parameter to disable reauthentication on a port.

### Command Syntax

```
dot1x reauthentication
no dot1x reauthentication
```

### Parameters

None

### Default

The dot1x reauthentication default is disabled.

### Command Mode

Interface mode

### Applicability

This command was introduced before OcNOS version 1.3.

### Examples

```
#configure terminal
(config)#interface eth0
(config-if)#dot1x reauthentication
```

---

## dot1x system-auth-ctrl

Use this command to enable globally authentication.

Use the `no` parameter to disable globally authentication.

### Command Syntax

```
dot1x system-auth-ctrl
no dot1x system-auth-ctrl
```

### Parameters

None

### Default

Authentication is off by default.

### Command Mode

Configure mode

### Applicability

This command was introduced before OcNOS version 1.3.

### Example

```
#configure terminal
(config)#dot1x system-auth-ctrl
```



---

## dot1x timeout re-authperiod

Use this command to set the interval between reauthorization attempts.

Use the `no` parameter to disable the interval between reauthorization attempts.

### Command Syntax

```
dot1x timeout re-authperiod <1-4294967295>
no dot1x timeout re-authperiod
```

### Parameter

<1-4294967295> Specify the seconds between reauthorization attempts.

### Default

Default time is 3600 seconds

### Command Mode

Interface mode

### Applicability

This command was introduced before OcNOS version 1.3.

### Example

```
#configure terminal
(config)#interface eth0
(config-if)#dot1x timeout re-authperiod 25
```

---

## dot1x timeout server-timeout

Use this command to set the authentication sever response timeout.

Use the `no` parameter to disable the authentication sever response timeout.

### Command Syntax

```
dot1x timeout server-timeout <1-65535>
no dot1x timeout server-timeout
```

### Parameter

<1-65535> Specify the authentication server response timeout.

### Default

Default timeout is 30 seconds.

### Command Mode

Interface mode

### Applicability

This command was introduced before OcnOS version 1.3.

### Examples

```
#configure terminal
(config)#interface eth0
(config-if)#dot1x timeout server-timeout 555

(config)#interface eth0
(config-if)#no dot1x timeout server-timeout
```

---

## dot1x timeout supp-timeout

Use this command to set the interval for a supplicant to respond.

Use the `no` parameter to disable the authentication sever response timeout.

### Command Syntax

```
dot1x timeout supp-timeout <1-65535>
no dot1x timeout supp-timeout
```

### Parameter

<1-65535> Specify the authentication server response timeout.

### Default

Default timeout is 30 seconds.

### Command Mode

Interface mode

### Applicability

This command was introduced before OcnOS version 1.3.

### Example

```
#configure terminal
(config)#interface eth0
(config-if)#dot1x timeout supp-timeout 40

(config)#interface eth0
(config-if)#no dot1x timeout supp-timeout
```

## dot1x timeout tx-period

Use this command to set the interval between successive attempts to request an ID.

Use the `no` parameter to disable the interval between successive attempts to request an ID.

### Command Syntax

```
dot1x timeout tx-period <1-65535>
no dot1x timeout tx-period
```

### Parameter

<1-65535> Specify the authentication server response timeout.

### Default

Default timeout is 30 seconds.

### Command Mode

Interface mode

### Applicability

This command was introduced before OcnOS version 1.3.

### Examples

```
#configure terminal
(config)#interface eth0
(config-if)#dot1x timeout tx-period 34

(config)#interface eth0
(config-if)#no dot1x timeout tx-period
```

---

## ip radius source-interface

Use this command to set the local address sent in packets to the radius server.

Use the `no` parameter to clear the local address.

### Command Syntax

```
ip radius source-interface HOSTNAME PORT
no ip radius source-interface
```

### Parameters

HOSTNAME	Specify the radius client in the dotted IP address, or in the hostname format.
PORT	Specify the radius client port number. The default port number is 1812.

### Default

The default port number is 1812.

### Command Mode

Configure mode

### Applicability

This command was introduced before OcnOS version 1.3.

### Examples

```
#configure terminal
(config)#ip radius source-interface myhost 1812

(config)#no ip radius source-interface
```

---

## radius-server dot1x deadtime

Use this command to specify the number of minutes a radius server, which is not responding to authentication requests, is passed over by requests for radius authentication. To improve radius response times when some servers might be unavailable, use this command to cause the unavailable servers to be skipped immediately.

Use the `no` form of this command to set deadtime to the default value of 0.

### Command Syntax

```
radius-server dot1x deadtime MIN
no radius-server dot1x deadtime
```

### Parameter

<code>dot1x</code>	IEEE 802.1X Port-Based Access Control.
<code>MIN</code>	Length of time (in minutes) that a radius server is skipped over by transaction requests, up to a maximum of 1440 minutes (24 hours). Enter a value in the range 1 to 1440.

### Default

Deadtime is set to 0

### Command Mode

Configure mode

### Applicability

This command was introduced before OcNOS version 1.3.

### Examples

```
#configure terminal
(config)#radius-server dot1x deadtime 10

(config)#no radius-server dot1x deadtime
```

---

## radius-server dot1x host

Use this command to specify the IP address or host name of the remote radius server host and assign authentication and accounting destination port numbers. Multiple radius-server host commands can be used to specify multiple hosts. The software searches for hosts in the order they are specified. If no host-specific timeout, retransmit, or key values are specified, the global values apply to that host.

If the auth-port parameter is not specified, it will take the default value of the auth-port. If you do not specify the auth-port to unconfigure, and the default value of the auth-port does not match the port you are trying to unconfigure, the specified radius-server host will not be unconfigured.

Use the `no` form of the command to unconfigure a specified radius-server.

### Command Syntax

```
radius-server dot1x host (A.B.C.D|HOSTNAME|X:X::X:X) (| (key ((0 WORD) | (7 WORD) |
(WORD)) (| (auth-port <0-65535> (| (timeout <1-60> (| (retransmit <1-100>)))))))
no radius-server dot1x host (A.B.C.D|HOSTNAME|X:X::X:X) (| (key ((0 WORD) | (7 WORD)
| (WORD)) (| (auth-port <0-65535> (| (timeout (| (retransmit <1-100>)))))))
```

### Parameters

<code>dot1x</code>	IEEE 802.1X Port-Based Access Control.
<code>A.B.C.D</code>	IPv4 address of the RADIUS server.
<code>HOSTNAME</code>	Host name or DNS name of the RADIUS server.
<code>X:X::X:X</code>	IPv6 address of the RADIUS server.
<code>auth-port</code>	RADIUS server's port for authentication.
<code>key</code>	Specify the global shared key.
<code>retransmit</code>	Global RADIUS server retransmit count.
<code>timeout</code>	Specify the RADIUS server timeout(default: 5 seconds).
<code>0</code>	To specify shared key in clear-text form.
<code>7</code>	To specify shared key in encrypted form.
<code>WORD</code>	RADIUS shared secret(clear text) (Max Size 63).
<code>&lt;0-65535&gt;</code>	Port number.
<code>&lt;0-100&gt;</code>	Global RADIUS server retransmit count.
<code>&lt;1-60&gt;</code>	RADIUS server timeout period in seconds.

### Default

The default value of auth-port is 1645.

### Command Mode

Configure mode

### Applicability

This command was introduced before OcnOS version 1.3.

### Examples

```
#configure terminal
(config)#radius-server dot1x host hostname auth-port 1233 timeout 1 retransmit
2

(config)#no radius-server dot1x host hostname auth-port 1233
```



## radius-server dot1x key

Use this command to set the shared secret key between a Radius server and a client.

Use the `no` form of the command to undo this configuration.

### Command Syntax

```
radius-server dot1x key ((0 WORD) | (7 WORD) | (WORD))  
no radius-server dot1x key ((0 WORD) | (7 WORD) | (WORD))
```

### Parameter

<code>dot1x</code>	IEEE 802.1X Port-Based Access Control.
<code>0</code>	To specify shared key in clear-text form.
<code>7</code>	To specify shared key in encrypted form.
<code>WORD</code>	Shared secret among radius server and 802.1X client (Max Size 63).

### Default

No default value is specified.

### Command Mode

Configure mode

### Applicability

This command was introduced before OcnOS version 1.3.

### Examples

```
#configure terminal  
(config)#radius-server dot1x key 0 abcd  
  
#configure terminal  
(config)#no radius-server dot1x 0 abcd
```

---

## radius-server dot1x retransmit

Use this command to specify the number of times the router transmits each radius request to the server before giving up.

Use the `no` form of this command to disable retransmission.

### Command Syntax

```
radius-server dot1x retransmit RETRIES
no radius-server dot1x retransmit
```

### Parameter

<code>dot1x</code>	IEEE 802.1X Port-Based Access Control.
<code>RETRIES</code>	Specify the retransmit value. Enter a value in the range 1 to 100. If no retransmit value is specified, the global value is used.

### Default

The default value is 3.

### Command Mode

Configure mode

### Applicability

This command was introduced before OcNOS version 1.3.

### Examples

```
#configure terminal
(config)#radius-server dot1x retransmit 12

(config)#no radius-server dot1x retransmit
```

---

## radius-server dot1x timeout

Use this command to specify the number of seconds a router waits for a reply to a radius request before retransmitting the request.

Use the `no` parameter to use the default value.

### Command Syntax

```
radius-server dot1x timeout <1-60>
no radius-server dot1x timeout
```

### Parameter

<code>dot1x</code>	IEEE 802.1X Port-Based Access Control.
<code>&lt;1-60&gt;</code>	RADIUS server timeout period in seconds.

### Default

The default value is 5 seconds.

### Command Mode

Configure mode

### Applicability

This command was introduced before OcNOS version 1.3.

### Examples

```
#configure terminal
(config)#radius-server dot1x timeout 20

#configure terminal
(config)#no radius-server dot1x timeout
```

---

## show debugging dot1x

Use this command to display the status of the debugging of the 802.1x system.

### Command Syntax

```
show debugging dot1x
```

### Parameters

None

### Command Mode

Privileged Exec mode

### Applicability

This command was introduced before OcNOS version 1.3.

### Example

```
#show debugging dot1x
802.1X debugging status:
```

---

## show dot1x

Use this command to display IEEE 802.1x port-based access control information.

### Command Syntax

```
show dot1x
show dot1x all
show dot1x diagnostics interface IFNAME
show dot1x interface IFNAME
show dot1x sessionstatistics interface IFNAME
show dot1x statistics interface IFNAME
```

### Parameters

all	Display all IEEE 802.1x port-based access control information.
diagnostics	Display diagnostics information.
IFNAME	Interface name.
sessionstatistics	Display the statistics for a session.
statistics	Display the statistics.

### Command Mode

Exec mode and Privileged Exec mode

### Applicability

This command was introduced before OcNOS version 1.3.

### Example

The following is an output of this command displaying the state of the system.

```
#show dot1x
% 802.1x authentication enabled
% Radius server address: 192.168.1.1.1812
% Radius client address: dhcp128.mySite.com.12103
% Next radius message id: 0
```

The following is an output of this command displaying detailed information for all ports.

```
#show dot1x all
% 802.1x authentication enabled
% Radius server address: 192.168.1.1.1812
% Radius client address: dhcp128.mySite.com.12103
% Next radius message id: 0
% Dot1x info for interface eth1 - 3
% portEnabled: true - portControl: auto
% portStatus: unauthorized - currentId: 11
% reAuthenticate: disabled
% abort:F fail:F start:F timeout:F success:F
% PAE: state: connecting - portMode: auto
% PAE: reAuthCount: 2 - rxRespId: 0
```

```

% PAE: quietPeriod: 60 - reauthMax: 2 - txPeriod: 30
% BE: state: idle - reqCount: 0 - idFromServer: 0
% BE: suppTimeout: 30 - serverTimeout: 30 - maxReq: 2
% CD: adminControlledDirections: in - operControlledDirections: in
% CD: bridgeDetected: false
% KR: rxKey: false
% KT: keyAvailable: false - keyTxEnabled: false

```

The following tables describes the output of the `show dot1x` command.

**Table 8-21: Port variables**

Entry	Description
portEnabled	Interface operational status (Up-true/down-false)
portControl	Current control status of the port for 802.1x control
portStatus	802.1x status of the port (authorized/unauthorized)
reAuthenticate	Reauthentication enabled/disabled status on port
reAuthPeriod	Reauthentication period

**Table 8-22: Supplicant PAE related global variables**

Entry	Description
abort	Abort authentication when true
fail	Failed authentication attempt when false
start	Start authentication when true
timeout	Authentication attempt timed out when true
success	Authentication successful when true

**Table 8-23: 802.1x Operational state of interface**

Entry	Description
mode	Configured 802.1x mode
reAuthCount	Reauthentication count
quietperiod	Time between reauthentication attempts
reAuthMax	Maximum reauthentication attempts

**Table 8-24: Backend authentication state machine variables and constants**

Entry	Description
state	State of the port.
reqCount	Number of requests sent to server
suppTimeout	Number of seconds the port waits for a response when relaying a request from the authentication server to the supplicant before resending the request.
serverTimeout	Number of seconds the port waits for a reply when relaying a response from the supplicant to the authentication server before timing out.
maxReq	Maximum number of times a request packet is retransmitted to the supplicant before the authentication session times out.

**Table 8-25: Controlled directions state machine**

Entry	Description
adminControlledDirections	Administrative value (Both/In)
operControlledDirections	Operational Value (Both/In)

**Table 8-26: KR -- Key receive state machine**

Entry	Description
rxKey	True when EAPOL-Key message is received by supplicant or authenticator. false when key is transmitted

**Table 8-27: Key Transmit state machine**

Entry	Description
keyAvailable	False when key has been transmitted by authenticator, true when new key is available for key exchange
keyTxEnabled	Key transmission enabled/disabled status

---

## snmp restart auth

Use this command to restart SNMP in Authentication

### Command Syntax

```
snmp restart auth
```

### Parameters

None

### Default

No default value is specified.

### Default

The default port is UDP 162.

### Command Mode

Configure mode

### Applicability

This command was introduced before OcnOS version 1.3.

### Examples

```
#configure terminal  
(config)#snmp restart auth
```



## CHAPTER 9 Port Security Commands

---

This chapter describes the Port Security commands.

- `show port-security`
- `switchport port-security`
- `switchport port-security logging enable`
- `switchport port-security mac-address`
- `switchport port-security maximum`

---

## show port-security

Use this command to display Port Security configuration for all ports or for a particular interface.

### Command Syntax

```
show port-security
show port-security (interface IFNAME |)
```

### Parameters

IFNAME                    Interface name

### Default

None

### Command Mode

Exec mode

### Applicability

This command was introduced in OcNOS version 1.3.6.

### Examples

```
#show port-security
Port port-security mode MAC limit CVLAN SVLAN static secure MAC
-----
gel  dynamic           3           2           0000.0000.1112
                                10          0000.0000.3333
```

```
#show port-security interface gel
```

```
Port Security Mode : Dynamic
Secure MAC limit : 3
Static Secure MAC list :
CVLAN SVLAN MAC Address
-----
2           0000.0000.1112
10          0000.0000.3333
```

---

## switchport port-security

Use this command to enable Port Security on an interface.

Use the no parameter with this command to disable Port Security on an interface. This command removes configured secured MAC, if any, on this interface.

Note: This command is supported for physical, LAG, and MLAG (active) interfaces only. Enabling port security on an interface removes learned MAC addresses of interfaces (whether learned by static or dynamic means), and then relearns the secure MAC addresses. Multicast MAC addresses are not considered as part of the MAC learning limit.

Note: This command is ignored when port security is already enabled on an interface.

### Command Syntax

```
switchport port-security (static |)
no switchport port-security
```

### Parameters

static                      Static mode of Port Security.

### Default

By default this feature is disabled, the default mode of Port Security is to dynamically learn. In dynamic mode, devices learn MAC addresses dynamically. Users can program static MACs, however, dynamic MAC learning will not be allowed in static mode for port security.

### Command Mode

Interface mode

### Applicability

This command was introduced in OcNOS version 1.3.6.

### Examples

```
#configure terminal
(config)#interface ge1
(config-if)#switchport
(config-if)#bridge-group 1
(config-if)#switchport mode hybrid
(config-if)#switchport hybrid allowed vlan all
(config-if)#switchport port-security
```

---

## switchport port-security logging enable

Use this command to enable violated MAC logging on a port security enabled interface.

Use the `no` parameter with this command to disable violated mac logging on a port security enabled interface.

### Command Syntax

```
switchport port-security logging enable
no switchport port-security logging
```

### Parameters

None

### Default

By default logging is disabled.

### Command Mode

Interface mode

### Applicability

This command was introduced in OcNOS version 1.3.6.

### Examples

```
#configure terminal
(config)#interface gel
(config-if)#switchport port-security logging enable
```

---

## switchport port-security mac-address

Use this command to add static secure MAC addresses.

Use the `no` parameter to remove static secure MAC addresses.

### Command Syntax

```
switchport port-security mac-address XXXX.XXXX.XXXX
no switchport port-security mac-address XXXX.XXXX.XXXX
switchport port-security mac-address XXXX.XXXX.XXXX vlanId <2-4094>
no switchport port-security mac-address XXXX.XXXX.XXXX vlanId <2-4094>
```

### Parameters

XXXX.XXXX.XXXX	Static secure MAC
<2-4094>	VLAN identifier

### Default

NA

### Command Mode

Interface mode

### Applicability

This command was introduced in OcNOS version 1.3.6.

### Examples

```
#configure terminal
(config)#interface ge1
(config-if)#switchport port-security mac-address 0000.0000.1112 vlan 2
```

---

## switchport port-security maximum

Use this command to configure MAC learn limit for an interface.

Note: When a newly configured max learn limit is less than the previous value, the user must remove/flush-out the unwanted MACs to stop traffic forwarding from the unwanted Source MAC addresses. MAC addresses can be removed using “clear mac address-table”

### Command Syntax

```
switchport port-security maximum <1-1000>
```

### Parameters

<1-1000>	Port security maximum learn limit
----------	-----------------------------------

### Default

Default learn limit is 1.

### Command Mode

Interface mode

### Applicability

This command was introduced in OcNOS version 1.3.6.

### Examples

```
#configure terminal
(config)#interface ge1
(config-if)#switchport port-security maximum 3
```

## CHAPTER 10 Layer 2 Control Protocols Tunneling Commands

This chapter is a reference for the Layer 2 Control Protocols (L2CP) tunneling commands:

- [clear l2protocol interface counters](#)
- [l2protocol](#)
- [l2protocol encapsulation dest-mac](#)
- [show l2protocol interface counters](#)
- [show l2protocol processing interface](#)

---

## clear l2protocol interface counters

This command allows you to clear the counters for numbers of packets peered, discarded and tunneled.

### Command Syntax

```
clear l2protocol interface (IFNAME|) counters (peer|discard|tunnel|tunnel-discard|)
```

### Parameters

peer	Clear stats for Peer protocol packets.
discard	Clear stats for Tunnel protocol packets.
tunnel	Clear stats for Tunnel protocol packets.
tunnel-discard	Clear stats for Tunnel discard protocol packets.

### Command Mode

Exec mode

### Applicability

This command was introduced before OcNOS-SP version 1.0.

### Examples

```
# clear l2protocol interface xel counters peer
```



---

## I2protocol

This command allows you to change the process of protocol to peer/discard/tunnel.

### Command Syntax

```
l2protocol (stp|lacp|efm|elmi|lldp|synce) (peer|discard|tunnel)
```

### Parameters

stp	Spanning Tree Protocols.
lacp	Link Aggregation (LACP).
efm	Ethernet first mile (Link OAM).
elmi	Ethernet local management interface.
lldp	Link layer discovery protocol.
synce	Link layer discovery protocol.
peer	Act as peer to the customer Device instance of the protocol.
discard	Discard the protocol data unit.
tunnel	Tunnel the Protocol data unit into the SVLAN.

### Default

Default process value is peer.

### Command Mode

Interface mode

### Applicability

This command was introduced before OcNOS-SP version 1.0.

### Examples

```
#configure terminal
(config)#interface xe1
(config-if)#switchport
(config-if)#bridge-group 1
(config-if)#switchport mode customer-edge access
(config-if)#l2protocol stp tunnel
(config-if)#l2protocol stp peer
(config-if)#l2protocol stp discard
```

## I2protocol encapsulation dest-mac

Use this command to change destination mac of tunneled I2 protocol packet. Allowed mac are 0100.C2CD.CDD0 or 0104.DFCD.CDD0.

Use the `no` parameter with this command to set default mac 0100.C2CD.CDD0.

Note: This command only applies to provider bridging. For more information, see [Chapter 14, Provider Bridging Configuration](#).

### Command Syntax

```
bridge <1-32> l2protocol encapsulation dest-mac XXXX.XXXX.XXXX
no bridge <1-32> l2protocol encapsulation dest-mac
```

### Parameters

bridge	Bridge group for bridging.
<1-32>	<1-32>
l2protocol	Configure Layer2 Protocol Tunneling.
encapsulation	Encapsulation of L2PT packet.
dest-mac	Encapsulation with destination mac.
XXXX.XXXX.XXXX	Destination Mac-address of L2PT tunneling (0100.C2CD.CDD0 or 0104.DFCD.CDD0).

### Command Mode

Configuration mode

### Applicability

This command is introduced in OcnOS-SP version 1.0.

### Examples

```
(config)#bridge 1 l2protocol encapsulation dest-mac ?
XXXX.XXXX.XXXX Destination Mac-address of L2PT tunneling (0100.C2CD.CDD0 or
0104.DFCD.CDD0)
(config)#bridge 1 l2protocol encapsulation dest-mac 0104.DFCD.CDD1
L2PT destination mac should be 0100.C2CD.CDD0 or 0104.DFCD.CDD0
(config)#bridge 1 l2protocol encapsulation dest-mac 0104.DFCD.CDD0
(config)#bridge 1 l2protocol encapsulation dest-mac 0100.C2CD.CDD0
(config)#bridge 1 l2protocol encapsulation dest-mac 0100.C2CD.CDD1
L2PT destination mac should be 0100.C2CD.CDD0 or 0104.DFCD.CDD0
(config)#

(config)#no bridge 1 l2protocol encapsulation dest-mac
(config)#show running-config | in bridge
bridge 1 protocol provider-rstp edge
vlan 2-10 type customer bridge 1 state enable
vlan 11-12 type service point-point bridge 1 state enable
cvlan registration table map1 bridge 1
bridge-group 1
bridge-group 1
(config)#
```

---

## show l2protocol interface counters

This command allows you to display the counters for numbers of packets peered, discarded and tunneled.

### Command Syntax

```
show l2protocol interface (IFNAME|) counters (peer|discard|tunnel|tunnel-discard|)
```

### Parameters

peer	Display stats for Peer protocol packets.
discard	Display stats for Tunnel protocol packets.
tunnel	Display stats for Tunnel protocol packets.
tunnel-discard	Display stats for Tunnel discard protocol packets.

### Command Mode

Exec mode

### Applicability

This command was introduced before OcNOS-SP version 1.0.

### Examples

```
# show l2protocol interface xe1 counters peer
Interface xe1
Peer:      stp:      1

# show l2protocol interface xe1 counters
Interface xe1
Peer:      stp:      1
Discard:   stp:     10
Tunnel:    stp:      5
```

## show l2protocol processing interface

This command allows you to display the processing information on Layer 2 protocol interface.

### Command Syntax

```
show l2protocol processing interface IFNAME
```

### Parameters

IFNAME                      Interface name

### Command Mode

Exec mode and Privileged Exec mode

### Applicability

This command is introduced was before OcNOS-SP version 1.0.

### Examples

```
#show l2protocol processing interface xe1/1
```

Bridge	Interface Name	Protocol	Processing Status
=====	=====	=====	=====
1	xe1/1	stp	Tunnel
1	xe1/1	gmrp	Peer
1	xe1/1	gvrp	Peer
1	xe1/1	mrrp	Peer
1	xe1/1	mvrp	Peer
1	xe1/1	lacp	Peer
1	xe1/1	lldp	Peer
1	xe1/1	efm	Peer
1	xe1/1	elmi	Peer
1	xe1/1	ptp	Peer
1	xe1/1	synce	Peer

---

## CHAPTER 11 Provider Bridging Commands

---

This chapter describes the Provider Bridging (PB) commands.

IEEE 802.1ad standardizes the architecture and bridged protocols to allow Ethernet frames with multiple VLAN tags. Packets through a provider network are doubly tagged with both an:

- Inner (C-VLAN) tag which is the customer network VLAN identifier
- Outer (S-VLAN) tag which is the service provider network VLAN identifier
  - [bridge protocol provider-mstp](#)
  - [bridge protocol provider-rstp](#)
  - [cvlan registration table](#)
  - [cvlan svlan](#)
  - [dotad](#)
  - [show cvlan registration table](#)
  - [switchport customer-edge](#)
  - [switchport customer-edge hybrid](#)
  - [switchport customer-edge trunk](#)
  - [switchport customer-edge vlan registration](#)
  - [switchport customer-network allowed vlan](#)
  - [switchport customer-network vlan](#)
  - [switchport mode](#)
  - [switchport mode customer-edge](#)
  - [switchport mode customer-edge hybrid acceptable-frame-type](#)
  - [switchport provider-network](#)
  - [switchport provider-network isolated-vlan](#)
  - [vlan type](#)
  - [vlan type customer](#)

---

## bridge protocol provider-mstp

Use this command to create a provider multiple spanning-tree protocol (MSTP) bridge. MSTP bridges can have different spanning-tree topologies for different VLANs inside a region of similar MSTP bridges.

Using this command creates an instance of the spanning tree, and associates the VLANs specified with that instance. A bridge created by this command forms its own separate region.

The multiple spanning tree protocol, like the rapid spanning tree protocol, provides rapid reconfiguration features, while providing load-balancing capability.

### Command Syntax

```
bridge <1-32> protocol provider-mstp (edge|)
```

### Parameters

<1-32>	Bridge identifier.
edge	Configure as an edge bridge.

### Command Mode

Configure mode

### Applicability

This command was introduced before OcNOS version 1.3.

### Example

```
#configure terminal  
(config)#bridge 2 protocol provider-mstp edge
```

---

## bridge protocol provider-rstp

Use this command to add an IEEE 802.1D-2004 Rapid Spanning Tree Protocol (RSTP) bridge.

After creating a bridge instance, add interfaces to the bridge using the `bridge-group` command. Bring the bridge instance into operation with the `no shutdown` command in interface mode.

### Command Syntax

```
bridge <1-32> protocol provider-rstp (edge|)
```

### Parameters

<code>&lt;1-32&gt;</code>	Bridge identifier.
<code>edge</code>	Configure as an edge bridge.

### Command Mode

Configure mode

### Applicability

This command was introduced before OcnOS version 1.3.

### Example

```
#configure terminal
(config)#bridge 2 protocol provider-rstp edge
```

---

## cvlan registration table

Use this command to create a customer VLAN (CVLAN) registration table that maps between CVLANs and service provider VLANs (SVLANs).

Use the `no` parameter with this command to delete the CVLAN registration table.

### Command Syntax

```
cvlan registration table WORD bridge <1-32>
no cvlan registration table WORD bridge <1-32>
```

### Parameters

WORD	Name of the CVLAN registration table.
<1-32>	Specify a bridge ID.

### Command Mode

Configure mode

### Applicability

This command was introduced before OcNOS version 1.3.

### Example

```
#configure terminal
(config)#cvlan registration table customer1
(config-cvlan-registration)#
```



## cvlan svlan

Use this command to map one or more customer VLANs (CVLANs) to a service provider VLAN (SVLAN).

To update the optional QoS parameters `cos-to-queue` and `remark-cos`, execute the complete command along with the optional parameters. To remove these options, execute the same command by removing the optional parameters.

Refer `qos profile` commands from configuration guide for more details about qos profiles.

Use the `no` forms of this command to delete a mapping.

### Command Syntax

```
cvlan VLAN_RANGE2 (cvlan VLAN_ID|) svlan VLAN_ID ({untagged-pep|untagged-
  cep|}) ({cos-to-queue NAME | remark-cos|})
no cvlan VLAN_RANGE2  svlan VLAN_ID
```

### Parameters

<code>cvlan</code>	CVLAN
<code>VLAN_RANGE2</code>	VLAN identifier <1-4094> or range such as 2-5,10 or 2-5,7-19
<code>cvlan</code>	Translation of CVID
<code>VLAN_ID</code>	Translated CVID <1-4095>
<code>svlan</code>	SVLAN corresponding to the C-VLAN
<code>VLAN_ID</code>	VLAN identifier 1-4094>
<code>untagged-pep</code>	Provider edge port is untagged for this CVLAN
<code>untagged-cep</code>	Customer edge port is untagged for this CVLAN
<code>cos-to-queue</code>	Configure cos-to-queue map for cvlan
<code>NAME</code>	Ingress profile to modify queue/color on basis of c-cos
<code>remark-cos</code>	Remark Egress COS

### Command Mode

CVLAN Registration mode

### Applicability

This command was introduced before OcNOS version 1.3 and updated in OcNOS-SP version 1.0.

### Example

```
#configure terminal
(config)#cvlan registration table customer1 bridge 1
(config-cvlan-registration)#cvlan 2 svlan 3
(config-cvlan-registration)#cvlan 3 svlan 3 cos-to-queue c1 remark-cos
(config-cvlan-registration)#cvlan 100 cvlan 101 svlan 200 cos-to-queue p1
remark-cos
(config-cvlanregistration)#cvlan 3 svlan 3 remark-cos
(config-cvlan-registration)#cvlan 4 svlan 5 untagged-pep
(config-cvlan-registration)#cvlan 5 svlan 6 untagged-cep
(config-cvlan-registration)#no cvlan 3 svlan 3
```

## Provider Bridging Commands

---

```
(config-cvlan-registration)#cvlan 23 svlan 31 untagged-pep untagged-cep cos-  
to-queue pl remark-cos  
(config-cvlan-registration)#cvlan 15-16 svlan 18 untagged-cep remark-cos
```

## dotad

This command allows you to change the TPID for a port.

Use the no form of this command to unset the TPID to default value.

### Command Syntax

```
dotad ethertype ETHERTYPE
no dotad ethertype
```

### Parameters

dotad	Set the switching characteristics of the Layer2 dot1q header.
ETHERTYPE	Ethertype value for outer tag (Allowed ethertype values are 0x8100 (default) or 0x88a8 Or 0x9100 or 0x9200)

### Default

The default TPID value is 8100.

### Command Mode

Interface Mode

### Applicability

This command was introduced before OcnOS-SP version 1.0.

### Examples

```
#configure terminal
(config)#interface xe1
(config-if)# dotad ethertype 0x88a8
(config-if)# no dotad ethertype
```

## show cvlan registration table

Use this command to display the CVLAN registration table.

### Command Syntax

```
show cvlan registration table (WORD|bridge <1-32>|WORD bridge <1-32>|)
```

### Parameters

WORD CVLAN registration table name.  
 <1-32> Bridge identifier

### Command Mode

Exec mode

### Applicability

This command was introduced before OcNOS version 1.3.

### Example

```
#sh cvlan registration table bridge 1
Bridge          Table Name      Port List
=====
1              map             xe17

CVLAN ID       T-CVLAN ID     SVLAN ID       Profile Name    Egress remark-Cos
=====
100            101            200            p1              Yes
```

[Table 11-28](#) explains the output fields.

**Table 11-28: show cvlan registration table output**

Entry	Description
Bridge	ID number of the bridge associated with the Customer VLAN (CVLAN).
Table Name	ID of the CVLAN registration table.
Port List	List of ports used by this CVLAN (including Link aggregators).
CVLAN ID	ID number of the CVLAN.
T-CVLAN ID	Translation CVLAN ID.
SVLAN ID	ID number of the Service VLAN (SVLAN) associated with the CVLAN.
Profile Name	cos-to-queue profile name.
Egress remark-Cos	Remark Egress Cos

---

## switchport customer-edge

Use this command to set the switching characteristics of the layer 2 interface and the default customer VLAN.

Use the `no` form of this command to remove a customer VLAN.

### Command Syntax

```
switchport customer-edge (access|hybrid) vlan <2-4094>
no switchport customer-edge (access|hybrid) vlan
```

### Parameters

<code>access</code>	Set the layer 2 interface as access.
<code>hybrid</code>	Set the layer 2 interface as hybrid.
<code>&lt;2-4094&gt;</code>	Set the default VID for the interface.

### Command Mode

Interface mode

### Applicability

This command was introduced before OcnOS version 1.3.

### Examples

```
#configure terminal
(config)#interface eth0
(config-if)#switchport customer-edge access vlan 3

(config)#interface eth0
(config-if)#no switchport customer-edge access vlan
```

---

## switchport customer-edge hybrid

Use this command to set the switching characteristics of the Layer 2 customer-facing interface to hybrid. Both tagged and untagged frames will be classified over hybrid interfaces.

### Command Syntax

```
switchport customer-edge hybrid allowed vlan add VLAN_ID
switchport customer-edge hybrid allowed vlan remove VLAN_ID
switchport customer-edge hybrid allowed vlan all
switchport customer-edge hybrid allowed vlan none
```

### Parameters

add	Add a VLAN to transmit and receive through the Layer 2 interface.
VLAN_ID	ID of the VLAN <2-4094>.
remove	Remove a VLAN from the member set.
VLAN_ID	ID of the VLAN <2-4094>.
all	Allow all VLANs to transmit and receive through the Layer 2 interface.
none	Allow no VLANs to transmit and receive through the Layer 2 interface.

### Command Mode

Interface mode

### Applicability

This command was introduced before OcnOS version 1.3.

### Examples

```
(config)#interface eth0
(config-if)#switchport customer-edge hybrid allowed vlan add 2
```

---

## switchport customer-edge trunk

Use this command to set the Layer2 interface as trunk.

### Command Syntax

```
switchport customer-edge trunk allowed vlan add VLAN_ID
switchport customer-edge trunk allowed vlan remove VLAN_ID
switchport customer-edge trunk allowed vlan all
switchport customer-edge trunk allowed vlan none
```

### Parameters

add	Add a VLAN to the member set.
VLAN_ID	Specify a VLAN ID <2-4094>
remove	Remove a VLAN from the member set.
all	Allow all VLANs to transmit and receive through the Layer 2 interface.
none	Allow no VLANs to transmit and receive through the Layer 2 interface.

### Command Mode

Interface mode

### Applicability

This command was introduced before OcnOS version 1.3.

### Examples

```
#configure terminal
(config)#interface eth1
(config-if)#switchport customer-edge trunk allowed vlan add 12
```

---

## switchport customer-edge vlan registration

Use this command to configure the VLAN registration parameters.

Use the `no` parameter with this command to delete the mapping from the interface.

### Command Syntax

```
switchport customer-edge vlan registration WORD
no switchport customer-edge vlan registration
```

### Parameters

`WORD`                      Name of the CVLAN registration table.

### Command Mode

Interface mode

### Applicability

This command was introduced before OcNOS version 1.3.

### Example

```
#configure terminal
(config)#interface eth1
(config-if)#switchport customer-edge vlan registration customer1
```



---

## switchport customer-network allowed vlan

Use this command to add SVLAN IDs to the Customer Network Port.

### Command Syntax

```
switchport customer-network allowed vlan add VLAN_RANGE
```

### Parameters

VLAN\_RANGE          VLAN identifier <1-4094> or range such as 2-5,10 or 2-5,7-19.

### Command Mode

Interface mode

### Applicability

This command was introduced before OcnOS version 6.2.0.

### Examples

In this example, the xe1 interface allows S-TAG 100-200 and 400 traffic from customer.

```
(config)#interface xe1
(config-if)#switchport
(config-if)#dot1ad ethertype 0x88a8
(config-if)#bridge-group 1
(config-if)#switchport mode customer-network
      (config-if)#switchport customer-network allowed vlan add 100-200,400
```

---

## switchport customer-network vlan

Use this command to set the default SVLAN ID for the Customer Network Port.

### Command Syntax

```
switchport customer-network vlan <2-4094>
no switchport customer-network vlan
```

### Parameters

<2-4094>            Set the default VLAN ID for the interface.

### Default

Default Customer Network VLAN is 1.

### Command Mode

Interface mode

### Applicability

This command was introduced before OcNOS version 6.2.0

### Examples

In this example, the xe1 interface allows C-TAG/untagged traffic from customers, adding SVLAN ID 100 before forwarding to the provider network. While egressing out, the SVLAN ID 100 will be stripped out.

```
(config)#interface xe1
(config-if)#switchport
(config-if)#dot1ad ethertype 0x88a8
(config-if)#bridge-group 1
(config-if)#switchport mode customer-network
(config-if)#switchport customer-network allowed vlan add 100
(config-if)#switchport customer-network vlan 100
```

## switchport mode

Use this command to set the switching characteristics of the Layer 2 interface.

### Command Syntax

```
switchport mode (provider-network|customer-edge|customer-network)
```

### Parameters

```
provider-network  Provider network.  
customer-edge    Customer edge.  
customer-network Customer network.
```

### Command Mode

Interface mode

### Applicability

This command was introduced before OcnOS version 1.3.

### Example

```
#configure terminal  
(config)#interface eth0  
(config-if)#switchport mode provider-network
```

---

## switchport mode customer-edge

Use this command to set the switching characteristics of the Layer 2 customer facing interface and classify only untagged frames. Received frames are classified based on the VLAN characteristics, then accepted or discarded based on the specified filtering criteria.

### Command Syntax

```
switchport mode customer-edge (access|hybrid|trunk)
switchport mode customer-edge (access|hybrid|trunk)
```

### Parameters

access	Set the layer 2 interface as access.
hybrid	Set the layer 2 interface as hybrid.
trunk	Set the layer 2 interface as trunk.

### Command Mode

Interface mode

### Applicability

This command was introduced before OcnOS version 1.3.

### Example

```
#configure terminal
(config)#interface eth0
(config-if)#switchport mode customer-edge access
```

---

## switchport mode customer-edge hybrid acceptable-frame-type

Use this command to set the layer 2 interface acceptable frames types. This processing occurs after VLAN classification.

### Command Syntax

```
switchport mode customer-edge hybrid acceptable-frame-type (all|vlan-tagged)
```

### Parameters

all	Set all frames can be received.
vlan-tagged	Set only VLAN-tagged frames can be received.

### Command Mode

Interface mode

### Applicability

This command was introduced before OcnOS version 1.3.

### Example

```
#configure terminal
(config)#interface eth0
(config-if)#switchport mode customer-edge hybrid acceptable-frame-type vlan-
tagged
```

---

## switchport provider-network

Use this command to set the switching characteristics of the provider-network interface.

### Command Syntax

```
switchport provider-network allowed vlan add VLAN_RANGE2
switchport provider-network allowed vlan remove VLAN_RANGE2
switchport provider-network allowed vlan except VLAN_RANGE2
switchport provider-network allowed vlan all
switchport provider-network allowed vlan none
```

### Parameters

add	Add a VLAN to transmit and receive through the Layer 2 interface.
VLAN_RANGE2	VLAN ID 1-4094 or range(s): 2-5 10 or 2-5 7-20.
remove	Remove a VLAN from the member set.
VLAN_RANGE2	VLAN ID 1-4094 or range(s): 2-5 10 or 2-5 7-20.
Except	All VLANs except these VLANs are part of the member set.
VLAN_RANGE2	VLAN ID 1-4094 or range(s): 2-5 10 or 2-5 7-20.
all	Allow all VLANs to transmit and receive through the Layer 2 interface.
none	Allow no VLANs to transmit and receive through the Layer 2 interface.

### Command Mode

Interface mode

### Applicability

This command was introduced before OcNOS version 1.3.

### Examples

```
(config)#interface eth0
(config-if)#switchport provider-network allowed vlan add 2
```

---

## switchport provider-network isolated-vlan

Use this command to attach a VLAN as an isolated VLAN for a provider network port.

Using an isolated VLAN for PNP ports on a switch can forward all frames received from the PNP port to all other PNP ports. However, if VLANs are configured to be isolated, they can traverse PNP port without sharing any of their frames.

Use the `no` form of this command to remove an isolated VLAN for a provider network port.

### Command Syntax

```
switchport provider-network isolated-vlan VLAN_RANGE
no switchport provider-network isolated-vlan VLAN_RANGE
```

### Parameters

VLAN\_RANGE            VLAN identifier <2-4094> or range such as 2-5,10 or 2-5,7-19

### Command Mode

Interface mode

### Applicability

This command was introduced in OcNOS-SP version 1.0.

### Example

```
#configure terminal
(config)#bridge 1 protocol provider-rstp
(config)#vlan database
(config-vlan)#vlan 2-10 type service point-point bridge 1 state enable
(config-vlan)#exit
(config)#interface xe0
(config-if)#switchport
(config-if)#bridge-group 1
(config-if)#switchport provider-network allowed vlan all
(config-if)#switchport provider-network isolated-vlan 2-10
```

---

## switchport provider-network vlan translation

Use this command to add a translation table entry for CVLAN and SVLAN on a provider network port.

Use the `no` form of this command to delete a translation table entry for CVLAN and SVLAN on a provider network port.

### Command Syntax

```
switchport provider-network vlan translation (cvlan <2-4094>| ) svlan <2-4094>
  (cvlan <2-4094> | ) svlan <2-4094>
no switchport (provider-network) vlan translation svlan VLAN_ID svlan VLAN_ID
no switchport (provider-network) vlan translation cvlan <1-4095> svlan <1-4095>
```

### Parameters

<code>cvlan</code>	CVLAN to translate
<code>&lt;2-4094&gt;</code>	CVLAN identifier to translate
<code>svlan</code>	SVLAN to translate
<code>&lt;2-4094&gt;</code>	SVLAN identifier to translate
<code>cvlan</code>	Translated CVLAN
<code>&lt;2-4094&gt;</code>	Translated CVLAN identifier
<code>svlan</code>	Translated SVLAN
<code>&lt;2-4094&gt;</code>	Translated SVLAN identifier
<code>scos</code>	Class of Service in the Priority Code Point (PCP) field of the service provider tag (STAG)
<code>&lt;0-7&gt;</code>	Class-of-service value
<code>scfi</code>	Canonical Format Indicator in the Drop Eligible Indicator (DEI) field of the STAG
<code>&lt;0-1&gt;</code>	Canonical Format Indicator value
<code>ccos</code>	Class of Service in the PCP field of the customer tag (CTAG)
<code>&lt;0-7&gt;</code>	Class-of-service value
<code>ccfi</code>	Canonical Format Indicator in the DEI field of the CTAG
<code>&lt;0-1&gt;</code>	Canonical Format Indicator value

### Command Mode

Interface mode

### Applicability

This command was introduced before OcNOS version 1.3.

### Example

```
#configure terminal
(config)#interface eth1
(config-if)#switchport
(config-if)#bridge-group 1
(config-if)#switchport mode provider-network
(config-if)#switchport provider-network allowed vlan all
```



```
(config-if)#switchport provider-network vlan translation cvlan 2 svlan 3 cvlan  
4 svlan 5
```

## vlan type

This command allows you to create a single/range of VLAN's on provide/edge bridge.

Use the no form of this command to delete the VLAN.

### Command Syntax

```
vlan VLAN_RANGE type customer bridge <1-32>
vlan VLAN_RANGE type customer bridge <1-32> name WORD
vlan VLAN_RANGE type customer bridge <1-32> state (enable | disable)
vlan VLAN_RANGE type service point-point bridge <1-32>
vlan VLAN_RANGE type service point-point bridge <1-32> name WORD
vlan VLAN_RANGE type service point-point bridge <1-32> state (enable | disable)

no vlan VLAN_RANGE type customer bridge <1-32>
no vlan VLAN_RANGE type service bridge <1-32>
```

### Parameters

VLAN_RANGE	VLAN identifier <2-4094> or range such as 2-5,10 or 2-5,7-19
customer	Identifies the Customer VLAN
bridge	Specify the bridge group ID in the range <1-32>.
name	The ASCII name of the VLAN. Maximum length allowed is 16 characters.
point-point	Sets the VLAN connectivity mode to point-to-point
WORD	ASCII name of the VLAN.
state	Indicates the operational state of the VLAN.
enable	Sets VLAN into an enable state.
disable	Sets VLAN into a disable state.

### Command Mode

Configuration Mode

### Applicability

This command was introduced before OcNOS version 1.3.

### Examples

```
(config)vlan 2,4,5-6 customer bridge 2
(config)vlan 10-12 service type point-point bridge 3
```

---

## vlan type customer

Use this command to configure VLANs of type customer, to enable or disable the state of the VLANs, and to configure the name for VLANs.

Use the `no` form of this command to remove the VLAN type.

### Command Syntax

```
vlan <2-4094> type customer bridge <1-32>
vlan <2-4094> type customer bridge <1-32> state (enable|disable)
vlan <2-4094> type customer bridge <1-32> name WORD
no vlan <2-4094> type customer bridge <1-32>
```

### Parameters

<2-4094>	The VID of the VLAN that will be enabled or disabled on the bridge <2-4094>.
type	Identifies the VLAN as a customer, service, or VLAN.
customer	Identifies the Customer VLAN
bridge	Indicates a Service VLAN <1-32>.
name	The ASCII name of the VLAN. Maximum length allowed is 16 characters.
state	Indicates the operational state of the VLAN.
enable	Sets VLAN into an enable state.
disable	Sets VLAN into a disable state.
WORD	ASCII name of the VLAN.

### Command Mode

VLAN Configuration mode

### Applicability

This command was introduced before OcNOS version 1.3.

### Examples

```
#configure terminal
(config)#vlan database
(config-vlan)#vlan 12 type customer bridge 1 name new state enable
```



---

## CHAPTER 12 Link Layer Discovery Protocol v2 Commands

---

The commands in this chapter support:

- Link Layer Discovery Protocol (LLDP) version 2 as described in IEEE 802.1AB 2009
- LLDP-MED protocol extension as per ANSI/TIA-1057 April 2006.

Note: To enable LLDPv2, LLDP (previous version) should be disabled or vice versa.

- `clear lldp counters`
- `lldp-agent`
- `debug lldp`
- `lldp run`
- `lldp tlv basic-mgmt`
- `lldp tlv med`
- `lldp tlv ieee-8021-org-specific`
- `lldp tlv ieee-8023-org-specific`
- `lldp tlv-select basic-mgmt`
- `lldp tlv-select ieee-8021-org-specific`
- `lldp tlv-select ieee-8023-org-specific`
- `set lldp agt-circuit-id`
- `set lldp chassis-id-tlv`
- `set lldp chassis locally-assigned`
- `set lldp disable`
- `set lldp enable`
- `set lldp locally-assigned`
- `set lldp management-address-tlv`
- `set lldp med-devtype`
- `set lldp msg-tx-hold`
- `set lldp port-id-tlv`
- `set lldp timer`
- `set lldp too-many-neighbors`
- `set lldp tx-fast-init`
- `set lldp tx-max-credit`
- `show debugging lldp`
- `show lldp neighbors`
- `show lldp interface`
- `snmp restart lldp`

---

## clear lldp counters

Use this command to clear the LLDP statistics on all the interfaces.

### Command Syntax

```
clear lldp counters
```

### Parameters

`counters`          Reset the LLDP traffic counters to zero.

### Command Mode

Exec Mode and Privileged Exec mode

### Applicability

This command was introduced before OcnOS version 1.3.

### Examples

```
#clear lldp counters
```

## lldp-agent

Use this command to create an LLDP agent mode.

Note: This command is not supported in SVLAN, VLAN, and loopback interfaces.

Use the `no` parameter to remove configured lldp agent mode.

### Command Syntax

```
lldp-agent (non-tpmr-bridge |customer-bridge| )
no lldp-agent (non-tpmr-bridge |customer-bridge| )
```

### Parameters

```
non-tpmr-bridge
                    non-tpmr-bridge
customer-bridge
                    customer-bridge
```

### Default

By default LLDP agent is disabled.

### Command Mode

Interface Mode

### Applicability

This command was introduced before OcNOS version 1.3.

### Examples

```
#configure terminal
(config)#interface eth0
(config-if)#lldp-agent customer-bridge
(if-lldp-agent)#

(if-lldp-agent)#no lldp-agent customer-bridge
(if-lldp-agent)#exit
(config-if)#
```

---

## debug lldp

Use this command to set the debugging functions for LLDP.

Use the no form of this command to turn off LLDP debugging functions

### Command Syntax

```
debug lldp (event|ha|rx|tx|message)
no debug lldp (event|ha|rx|tx|message)
```

### Parameters

event	Enable or disable event debugging
ha	Enable or disable high availability debugging
rx	Enable or disable RX debugging
tx	Enable or disable TX debugging
message	Enable or disable NSM message debugging

### Command Mode

Exec mode

### Applicability

This command was introduced before OcNOS version 1.3.

### Examples

```
#debug lldp event
#debug lldp message
```



## lldp run

Use this command to start the Link Layer Discovery Protocol (LLDP)

Use the no form of this command to stop LLDP

### Command Syntax

```
lldp run
no lldp run
```

### Parameters

None

### Command Mode

Configure mode

### Applicability

This command was introduced before OcnOS version 1.3.

### Example

```
#configure terminal
(config)#lldp run

(config)#no lldp run
```

## lldp tlv basic-mgmt

Use this command to select and unselect basic management TLVs in LLDP frames at the interface agent level. This command has precedence over the global configurations for inclusion of TLVs in LLDP frames.

Use the `no` parameter to remove the basic management TLV select/unselect configuration from the interface agent level.

### Command Syntax

```
lldp tlv basic-mgmt (management-address|port-description|system-
capabilities|system-description|system-name) (select|unselect)
no lldp tlv basic-mgmt (management-address|port-description|system-
capabilities|system-description|system-name)
```

### Parameters

<code>management-address</code>	Management address TLV
<code>port-description</code>	Port description TLV
<code>system-capabilities</code>	System capabilities TLV
<code>system-description</code>	System Description TLV
<code>system-name</code>	System name TLV
<code>select</code>	Select the LLDP TLV to send
<code>unselect</code>	Unselect the LLDP TLV to send

### Default Value

None

### Command Mode

LLDP agent mode

### Applicability

This command was introduced in OcNOS-SP version 3.0.

### Examples

```
#configure terminal
(config)#interface eth0
(config-if)lldp-agent
(if-lldp-agent)#lldp tlv basic-mgmt system-name select
(if-lldp-agent)#exit
```

---

## lldp tlv med

Use this command to select and unselect Media Endpoint Devices (MED) TLVs in LLDP frames at the interface agent level. This command has precedence over the global configurations for inclusion of TLVs in LLDP frames.

LLDP MED TLVs determine the capabilities the connected device supports and the capabilities the device has enabled.

Use the `no` parameter to remove the MED TLV select/unselect configuration from the interface agent level.

### Command Syntax

```
lldp tlv med (network-policy|location|inventory|media-capabilities|extended-power-  
via-mdi) (select|unselect)
```

```
no lldp tlv med (network-policy|location|inventory|media-capabilities|extended-  
power-via-mdi)
```

### Parameters

<code>network-policy</code>	Network-policy TLV
<code>location</code>	Location TLV
<code>inventory</code>	Inventory TLV
<code>media-capabilities</code>	Media-capabilities TLV
<code>extended-power-via-mdi</code>	Extended-power-via-mdi TLV (when PoE is available)
<code>select</code>	Select the LLDP TLV to send
<code>unselect</code>	Unselect the LLDP TLV to send

### Default Value

None

### Command Mode

LLDP agent mode

### Applicability

This command was introduced in OcNOS-SP version 3.0.

### Examples

```
#configure terminal  
(config)#interface eth0  
(config-if)lldp-agent  
(if-lldp-agent)#lldp tlv med network-policy select  
(if-lldp-agent)#exit
```

## lldp tlv ieee-8021-org-specific

Use this command to select and unselect ieee-8021-org-specific TLVs in LLDP frames at the interface agent level. This command has precedence over the global configurations for inclusion of TLVs in LLDP frames.

Use the `no` parameter to remove the ieee-8021-org-specific TLV select/unselect configuration from the interface agent level.

### Command Syntax

```
lldp tlv ieee-8021-org-specific (link-agg|mgmt-vid|port-ptcl-vlanid|port-  
vlanid|ptcl-identity|vid-digest|vlan-name) (select|unselect)  
no lldp tlv ieee-8021-org-specific {port-vlanid| port-ptcl-vlanid| vlan-name|ptcl-  
identity|vid-digest|mgmt-vid|link-agg}
```

### Parameters

link-agg	Link-aggregation TLV
mgmt-vid	Management VLAN identifier TLV
port-ptcl-vlanid	Port protocol VLAN identifier TLV
port-vlanid	Port VLAN identifier TLV
ptcl-identity	Protocol-identifier TLV
vid-digest	VLAN identifier digest TLV
vlan-name	VLAN name TLV
select	Select the LLDP TLV to send
unselect	Unselect the LLDP TLV to send

### Default Value

None

### Command Mode

LLDP agent mode

### Applicability

This command was introduced in OcNOS-SP version 3.0.

### Examples

```
#configure terminal  
(config)#interface eth0  
(config-if)lldp-agent  
(if-lldp-agent)#lldp tlv ieee-8021-org-specific port-vlanid select  
(if-lldp-agent)#exit
```

---

## lldp tlv ieee-8023-org-specific

Use this command to select and unselect ieee-8023-org-specific TLVs in LLDP frames at the interface agent level. This command has precedence over the global configurations for inclusion of TLVs in LLDP frames.

Use the `no` parameter to remove the ieee-8023-org-specific TLV select/unselect configuration from the interface agent level.

### Command Syntax

```
lldp tlv ieee-8023-org-specific (mac-phy| power-via-mdi| max-mtu-size)
(select|unselect)
no lldp tlv ieee-8023-org-specific (mac-phy| power-via-mdi| max-mtu-size)
```

### Parameters

<code>mac-phy</code>	Provider edge port VLAN ID TLV
<code>power-via-mdi</code>	Power-via-MDI TLV (when PoE is available)
<code>max-mtu-size</code>	Maximum MTU size TLV
<code>select</code>	Select the LLDP TLV to send
<code>unselect</code>	Unselect the LLDP TLV to send

### Default Value

None

### Command Mode

LLDP agent mode

### Applicability

This command was introduced in OcNOS-SP version 3.0.

### Examples

```
#configure terminal
(config)#interface eth0
(config-if)lldp-agent
(if-lldp-agent)#lldp tlv ieee-8023-org-specific mac-phy select
(if-lldp-agent)#exit
```

---

## lldp tlv-select basic-mgmt

Use this command to select basic management TLVs to be include in the LLDP frames.

Use the `no` parameter to disable basic management TLVs.

### Command Syntax

```
lldp tlv-select basic-mgmt (management-address|port-description|system-  
capabilities|system-description|system-name)
```

```
no lldp tlv-select basic-mgmt (management-address|port-description|system-  
capabilities|system-description|system-name)
```

### Parameters

<code>management-address</code>	Management address specific TLV
<code>port-description</code>	Port description specific TLV
<code>system-capabilities</code>	System capabilities specific TLV
<code>system-description</code>	System Description specific TLV
<code>system-name</code>	System name specific TLV

### Default Value

None

### Command Mode

Configuration mode

### Applicability

This command was introduced in OcNOS-SP version 3.0.

### Examples

```
#configure terminal  
(config)#lldp tlv-select basic-mgmt system-name
```

---

## lldp tlv-select ieee-8021-org-specific

Use this command to select ieee-8021-org-specific TLVs to include in the LLDP frames.

Use the `no` parameter to disable ieee-8021-org-specific TLVs.

### Command Syntax

```
lldp tlv-select ieee-8021-org-specific (link-agg|mgmt-vid|port-ptcl-vlanid|port-  
vlanid|ptcl-identity|vid-digest|vlan-name)  
no lldp tlv-select ieee-8021-org-specific {port-vlanid| port-ptcl-vlanid| vlan-  
name|ptcl-identity| vid-digest|mgmt-vid|link-agg}
```

### Parameters

<code>link-agg</code>	Link-aggregation TLV
<code>mgmt-vid</code>	Management VLAN identifier TLV
<code>port-ptcl-vlanid</code>	Port protocol VLAN identifier TLV
<code>port-vlanid</code>	Port VLAN identifier TLV
<code>ptcl-identity</code>	Protocol-identifier TLV
<code>vid-digest</code>	VLAN identifier digest TLV
<code>vlan-name</code>	VLAN name TLV

### Default Value

None

### Command Mode

Configuration mode

### Applicability

This command was introduced in OcNOS-SP version 3.0.

### Examples

```
#configure terminal  
(config)#lldp tlv-select ieee-8021-org-specific port-vlanid
```

---

## lldp tlv-select ieee-8023-org-specific

Use this command to select ieee-8023-org-specific TLVs to be include in LLDP frames.

Use the `no` parameter to disable ieee-8023-org-specific TLVs.

### Command Syntax

```
lldp tlv-select ieee-8023-org-specific (mac-phy| power-via-mdi| max-mtu-size)
no lldp tlv-select ieee-8023-org-specific (mac-phy| power-via-mdi| max-mtu-size)
```

### Parameters

<code>mac-phy</code>	VLAN ID Of the provider edge port <2-4094>.
<code>power-via-mdi</code>	Power-via-MDI (only when PoE feature is available)
<code>max-mtu-size</code>	Maximum MTU size TLV

### Default Value

None

### Command Mode

Configure mode

### Applicability

This command was introduced in OcNOS-SP version 3.0.

### Examples

```
#configure terminal
(config)#lldp tlv-select ieee-8023-org-specific mac-phy
```



---

## set lldp agt-circuit-id

Use this command to configure LLDP agt-circuit-id.

### Command Syntax

```
set lldp agt-circuit-id VALUE
```

### Parameters

VALUE Specify LLDP global agt-circuit ID.

### Command Mode

Interface mode

### Applicability

This command was introduced before OcnOS version 1.3.

### Examples

```
(config)#interface eth0  
(config-if)#set lldp agt-circuit-id sample
```

---

## set lldp chassis-id-tlv

Use this command to set the chassis ID subtype for the LLDP agent on a port.

Use no form of this command to unset the chassis ID subtype.

### Command Syntax

```
set lldp chassis-id-tlv (if-alias | ip-address | mac-address | if-name | locally-
assigned)
no set lldp chassis-id-tlv
```

### Parameters

mac-address	Use the MAC address as the chassis ID
ip-address	Use the management IP address as the chassis ID
if-alias	Use the IP address as the chassis ID
if-name	Use the interface name as the chassis ID
locally-assigned	Use the locally assigned value as the chassis ID

### Command Mode

LLDP Agent mode

### Applicability

This command was introduced before OcNOS version 1.3.

### Examples

```
#configure terminal
(config)#interface eth0
(config-if)#lldp-agent
(if-lldp-agent)#set lldp chassis-id-tlv ip-address
(if-lldp-agent)#no set lldp chassis-id-tlv
```

---

## set lldp chassis locally-assigned

Use this command to set the locally assigned chassis name for the LLDP interface.

### Command Syntax

```
set lldp chassis locally-assigned NAME
```

### Parameters

NAME                      Name assigned to the chassis.

### Command Mode

Configure mode

### Applicability

This command was introduced before OcnOS version 1.3.

### Examples

```
#configure terminal  
(config)#set lldp chassis locally-assigned box1
```

---

## set lldp disable

Use this command to disable the admin status of a LLDP agent on a port.

### Command Syntax

```
set lldp disable
```

### Parameters

None

### Command Mode

LLDP Agent mode

### Applicability

This command was introduced before OcNOS version 1.3.

### Examples

```
#configure terminal
(config)#interface eth0
(config-if)#lldp-agent
(if-lldp-agent)#set lldp disable
(if-lldp-agent)#exit
```

---

## set lldp enable

Use this command to set the admin status of a LLDP agent on a port.

### Command Syntax

```
set lldp enable (txonly|txrx|rxonly)
```

### Parameters

rxonly	Receive-only
txonly	Transmit-only
txrx	Transmit and receive

### Default

By default, no LLDP agent is enabled for a port.

### Command Mode

LLDP Agent mode

### Applicability

This command was introduced before OcnOS version 1.3.

### Examples

```
#configure terminal
(config)#interface eth0
(config-if)#lldp-agent
(if-lldp-agent)#set lldp enable txrx
(if-lldp-agent)#exit
```

---

## set lldp locally-assigned

Use this command to set the locally assigned name for LLDP interface.

Use no form of this command to remove the locally assigned name for LLDP interface.

### Command Syntax

```
set lldp locally-assigned NAME
no set lldp locally-assigned NAME
```

### Parameters

NAME	Name assigned to the port.
------	----------------------------

### Command Mode

Interface Mode

### Applicability

This command was introduced before OcNOS version 1.3.

### Examples

```
#configure terminal
(config)#interface eth0
(config-if)#set lldp locally-assigned port1
(config-if)#no set lldp locally-assigned
```

---

## set lldp management-address-tlv

Use this command to set the sub type of the Management Address TLV.

Use `no` form of this command to unset the sub type of the Management Address TLV.

### Command Syntax

```
set lldp management-address-tlv (mac-address | ip-address)
no set lldp management-address-tlv
```

### Parameters

<code>mac-address</code>	Use the MAC address as the Management Address.
<code>ip-address</code>	Use the management IP address as the Management Address.

### Command Mode

LLDP Agent mode

### Applicability

This command was introduced before OcnOS version 1.3.

### Examples

```
#configure terminal
(config)#interface eth0
(config-if)#lldp-agent
(if-lldp-agent)#set lldp management-address-tlv ip-address
(if-lldp-agent)#no set lldp management-address-tlv
```

---

## set lldp med-devtype

Use this command to configure the LLDP device type as Network-Connectivity/ End-Point Class1/ End-Point Class2/ End-Point Class3 device.

Use the `no` parameter to un set the configured LLDP device type.

### Command Syntax

```
set lldp med-devtype (net-connect| ep-class1| ep-class2| ep-class3)
no lldp med-devtype (net-connect| ep-class1| ep-class2| ep-class3)
```

### Parameters

<code>net-connect</code>	Set device type as Network-Connectivity
<code>ep-class1</code>	Set device type as End-Point Class1
<code>ep-class2</code>	Set device type as End-Point Class2
<code>ep-class3</code>	Set device type as End-Point Class3

### Default

None

### Command Mode

Interface mode

### Applicability

This command was introduced before OcnOS version 1.3.

### Examples

```
#configure terminal
(config)#interface eth0
(config-if)#set lldp med-devtype ep-class1
(config-if)#exit
```

```
#configure terminal
(config)#interface eth0
(config-if)#no set lldp med-devtype
(config-if)#exit
```



---

## set lldp msg-tx-hold

Use this command to set the `msg-tx-hold` parameter that determines the Time To Live (TTL) value for LLDPDUs to be transmitted by the port. The value set with this command is multiplied by the `lldp timer msg-tx-interval` value, which determines the final TTL value.

Use `no` form of this command to set the default value of message transmit hold.

### Command Syntax

```
set lldp msg-tx-hold <1-100>
no set lldp msg-tx-hold
```

### Parameters

<1-100>                      Time in seconds to set message transmit hold.

### Default

The default value of message transmit hold is 4 seconds.

### Command Mode

LLDP agent mode

### Applicability

This command was introduced before OcnOS version 1.3.

### Examples

```
(config)#interface eth0
(config-if)#lldp-agent
(if-lldp-agent)#set lldp msg-tx-hold 3
(if-lldp-agent)#no set lldp msg-tx-hold
```

---

## set lldp port-id-tlv

Use this command to set the sub type of the Port ID.

Use `no` form of this command to unset the sub type of the Port ID.

### Command Syntax

```
set lldp port-id-tlv (if-alias | ip-address | mac-address | if-name | agt-circuit-id | locally-assigned)
no set lldp port-id-tlv
```

### Parameters

<code>mac-address</code>	Use the MAC address as the port-id-tlv.
<code>ip-address</code>	Use the management IP address as the port-id-tlv
<code>if-alias</code>	Use the IP alias as the port-id-tlv
<code>if-name</code>	Use the interface name as the port-id-tlv
<code>agt-circuit-id</code>	Use the agt-circuit-id name as the port-id-tlv
<code>locally-assigned</code>	Use the locally assigned value as the port-id-tlv

### Command Mode

LLDP Agent mode

### Applicability

This command was introduced before OcnOS version 1.3.

### Examples

```
(config)#interface eth0
(config-if)#lldp-agent
(if-lldp-agent)#set lldp port-id-tlv ip-address
(if-lldp-agent)#no set lldp port-id-tlv
```

## set lldp timer

Use this command to set the interval at which LLDP frames are transmitted.

Use `no` form of this command to set the default value for timer.

### Command Syntax

```
set lldp timer msg-fast-tx <1-3600>
set lldp timer msg-tx-interval <5-3600>
set lldp timer reinit-delay <1-10>
no set lldp timer msg-fast-tx
no set lldp timer msg-tx-interval
no set lldp timer reinit-Delay
```

### Parameters

<code>msg-fast-tx</code>	Set the value in range <1-3600>
<code>msg-tx-interval</code>	Set the value in range <5-3600>
<code>reinit-delay</code>	Set the value in range <1-10>

### Default Values

The default value for `msg-fast-tx` is 1 second.

The default value for `msg-tx-interval` is 30 seconds.

The default value for `reinit-delay` is 2 seconds.

### Command Mode

LLDP Agent mode

### Applicability

This command was introduced before OcNOS version 1.3.

### Examples

```
#configure terminal
(config)#interface eth0
(config-if)#lldp-agent
(if-lldp-agent)#set lldp timer msg-fast-tx 40
(if-lldp-agent)#no set lldp timer msg-fast-tx
(if-lldp-agent)#exit

#configure terminal
(config)#interface eth0
(config-if)#lldp-agent
(if-lldp-agent)#set lldp timer msg-tx-interval 40
(if-lldp-agent)#no set lldp timer msg-tx-interval
(if-lldp-agent)#exit
```

```
#configure terminal
(config)#interface eth0
(config-if)#lldp-agent
(if-lldp-agent)#set lldp timer reinitDelay 3
(if-lldp-agent)#no set lldp timer reinitDelay
(if-lldp-agent)#exit
```

---

## set lldp too-many-neighbors

Use this command to set the action to take when the remote table is full.

Use no form of this command to unset too many neighbors parameters.

### Command Syntax

```
set lldp too-many-neighbors limit <1-65535> discard received-info timer <1-65535>
set lldp too-many-neighbors limit <1-65535> discard existing-info MAC timer <1-65535>
no set lldp too-many-neighbors limit
```

### Parameters

limit	The limit on the number of LLDP neighbors.
<1-65535>	Upper limit for the number of Remote LLDP Information.
received-info	The information received for this neighbor.
timer	The period after which received information is discarded.
<1-65535>	The period in seconds after which received information is discarded.
existing-info	The information for this neighbor.
MAC	Identifies the remote LLDP Agent for which information is discarded.
timer	The period in seconds after which existing information is discarded.
<1-65535>	The period in seconds after which existing information is discarded.

### Default Value

No upper limit is enforced for the number of remote LLDP agents.

### Command Mode

LLDP Agent mode

### Applicability

This command was introduced before OcNOS version 1.3.

### Examples

```
#configure terminal
(config)#interface eth1
(config-if)#lldp-agent
(if-lldp-agent)#set lldp too-many-neighbors limit 20 disc existing-info
1001.1001.1001 timer 1

(config)#interface eth1
(config-if)#lldp-agent
(if-lldp-agent)#set lldp too-many-neighbors limit 1 discard received-info
timer 1
```

---

## set lldp tx-fast-init

Use this command to determine the maximum value of LLDP frames that are transmitted during a fast transmission period.

Use `no` form of this command to set fast transmission period to default value.

### Command Syntax

```
set lldp tx-fast-init <1-8>
no set lldp tx-fast-init
```

### Parameters

`tx-fast-init` Set the message transmit interval value <1-8>.

### Default Value

Default value is 4.

### Command Mode

LLDP Agent mode

### Applicability

This command was introduced before OcnOS version 1.3.

### Examples

```
#configure terminal
(config)#interface eth0
(config-if)#lldp-agent
(if-lldp-agent)#set lldp tx-fast-init 4
(if-lldp-agent)#no set lldp tx-fast-init
(if-lldp-agent)#exit
```

---

## set lldp tx-max-credit

Use this command to set the maximum value of transmission credit, which signifies the number of consecutive LLDP frames transmitted.

Use `no` form of this command to set the maximum value of transmission credit to default value.

### Command Syntax

```
set lldp tx-max-credit <1-10>
no set lldp tx-max-credit
```

### Parameters

`tx-max-credit` The maximum value of transmission credit.

### Default Value

Default value is 5

### Command Mode

LLDP Agent mode

### Applicability

This command was introduced before OcnOS version 1.3.

### Examples

```
#configure terminal
(config)#interface eth0
(config-if)lldp-agent
(if-lldp-agent)#set lldp tx-max-credit <1-10>
(if-lldp-agent)#no set lldp tx-max-credit
(if-lldp-agent)#exit
```

---

## show debugging lldp

Use this command to display LLDP debugging information.

### Command Syntax

```
show debugging lldp
```

### Parameters

None

### Command Mode

Exec mode and Privileged Exec mode

### Applicability

This command was introduced before OcNOS version 1.3.

### Example

The following sample output displays information about an LLDP debugging.

```
#show debugging lldp
LLDP debugging status:
  LLDP message debugging is on
```



---

## show lldp neighbors

Use this command to display LLDP neighbors information.

### Command Syntax

```
show lldp (nearest-bridge| non-tpmr-bridge| customer-bridge|) neighbors
(brief|details)
```

### Parameters

nearest-bridge	Display LLDP nearest bridge information
non-tpmr-bridge	Display LLDP non-TPMR-bridge information
customer-bridge	Display LLDP customer-bridge information
neighbor	Neighbor
brief	Brief
details	Details

### Command Mode

Exec mode and Privileged Exec mode

### Applicability

This command was introduced before OcNOS version 1.3 and changed in OcNOS version 1.3.1.

### Example

The following sample output displays information about an LLDP neighbors

```
#sh lldp nearest-bridgr neighbors brief
Loc PortID  Rem Host Name  Rem Chassis Id  Rem Port Id  Agent Mode
-----
xe3/1      OcNOS          ecf4.bbfe.2864  ecf4.bbb2.4c65 Nearest bridge
```

```
#show lldp neighbors detail
```

```
-----
Nearest bridge Neighbors
Interface Name : xe11
Mandatory TLVs
Chassis id type : MAC address [8cea.1b67.236c]
Port id type : MAC address [8cea.1b28.4f6d]
Time to live : 121
Basic Management TLVs
System Name : OcNOS
System Description : Hardware Model:EC_AS5912-54X, Software version: OcNOS,1.3.1.122
Port Description : xe11
Remote System Capabilities : Bridge Router
Capabilities Enabled : Router
```

```

Management Address : MAC Address [8cea.1b67.236c]
Interface Number subtype : ifindex
Interface Number : 10011
OID Number : 0
802.1 Org specific TLVs
Port vlan id : 0
Port & Protocol vlan id : 0
Remote Configured VLANs : None
Remote Protocols Advertised: None
Remote VID Usage Digest : 0
Remote Management Vlan : 0
Link Aggregation Capability: capable of being aggregated
Link Aggregation Status : not currently in aggregation
Link Aggregation Port ID :
802.3 Org specific TLVs
AutoNego Support : Supported
AutoNego Status : Disabled
AutoNego Capability : 16
Operational MAU Type : 54 [Four-pair Category 6A or better, full duplex mode only]
Max Frame Size : 1518
    
```

Table 12-30 Shows the output details.

**Table 12-29: show lldp neighbor output details**

Entry	Description
Loc Port ID	Local interface SNMP index (appears when the interface option is used).
Rem Host Name	Name of the remote host.
Rem Chassis Id	Remote chassis identifier of the chassis type listed.
Rem Port Id	Remote port identifier of the port type listed.
Agent Mode	Agent mode enabled to the nearest bridge.
Time to live	Number of seconds for which this information is valid.
Interface Name	Name of the interface.
Chassis id type	Chassis identifier of the chassis type listed.
Port id type	Type of port identifier supplied, such as Locally assigned.
System Name	Name supplied by the system on the interface.
System Description	Description supplied by the system on the interface.
Port Description	The port description field uses the configured port description, the port name or the SNMP if Index (appears when the interface option is used).
Remote System Capabilities	Remote system capabilities (such as Bridge, Bridge Router, and Bridge Telephone) that are supported.

**Table 12-29: show lldp neighbor output details**

<b>Entry</b>	<b>Description</b>
Capabilities Enabled	Enabled by the system on the interface (appears when the interface option is used).
Management Address	Details of management address (such as 10.204.35.34).
Interface Number subtype	Interfaces subtype for which neighbor information is available.
Interface Number	Interfaces for which neighbor information is available.
OID Number	Number of identifier.
Port VLAN ID	Details of the port VLAN identifier.
Protocol VLAN ID	Details of the protocol VLAN identifier.
Remote Configured VLANs	Details of the remote configured VLAN.
Remote Protocols Advertised	Details of the remote protocols.
Remote VID usage Digest	Details of the VID usage.
Remote Management VLAN	Details of the management VLAN.
Link Aggregation Capability	Capabilities that supported by the link aggregation on the interface.
Link Aggregation Status	Status of the link aggregation.
Link Aggregation Port ID	Details of the link aggregation port identifier.
Auto Nego Support	Support of the auto nego on the interface.
Auto Nego Status	Status of the auto nego.
Auto Nego Capability	Capabilities that supported by the auto nego on the interface.
Operational MAU Type	Type of operational MAU on the interface.
Max Frame Size	Maximum frame size on the transit.

## show lldp interface

Use this command to display LLDP interface information.

### Command Syntax

```
show lldp interface IFNAME (nearest-bridge| non-tpmr-bridge| customer-bridge | )
(neighbor| )
```

### Parameters

IFNAME	
	Display LLDP interface information for all agent
nearest-bridge	
	Display LLDP nearest bridge information
non-TPMR-bridge	
	Display LLDP non-TPMR-bridge information
customer-bridge	
	Display LLDP customer-bridge information
neighbor	
	Display LLDP neighbor details.

### Command Mode

Exec mode and Privileged Exec mode

### Applicability

This command was introduced before OcNOS version 1.3.

### Example

```
#show lldp interface eth0
Agent Mode : Customer-bridge
Enable (tx/rx): N/N
MED Enabled :N
Device Type: NOT_DEFINED
LLDP Agent traffic statistics:
Total frames transmitted: 0
Total entries aged: 0
Total frames recieved: 0
Total frames received in error: 0
Total frames discarded: 0
Total discarded TLVs: 0
Total unrecognised TLVs: 0

Agent Mode : Non-TPMR-bridge
Enable (tx/rx): N/N
MED Enabled :N
Device Type: NOT_DEFINED
LLDP Agent traffic statistics:
Total frames transmitted: 0
```

```

Total entries aged: 0
Total frames recieved: 0
Total frames received in error: 0
Total frames discarded: 0
Total discarded TLVs: 0
Total unrecognised TLVs: 0

Agent Mode : Nearest bridge
Enable (tx/rx): Y/Y
MED Enabled :N
Device Type: NOT_DEFINED
LLDP Agent traffic statistics:
Total frames transmitted: 2495
Total entries aged: 0
Total frames recieved: 0
Total frames received in error: 0
Total frames discarded: 0
Total discarded TLVs: 0
Total unrecognised TLVs: 0

```

Table 12-30 Shows the output details.

**Table 12-30: show lldp interface output details**

Entry	Description
Agent Mode	Agent mode enabled to the customer-bridge, Non-TPMR-bridge, and nearest bridge.
Enable (tx/rx)	Enables the transmit and receive on the interface.
Device Type	Type of device in the networks.
LLDP Agent traffic statistics	Statistics on exchanged LLDP frames between a device and neighbors.
Total frames transmitted	Number of frames transmitted in network.
Total entries aged	Number of aged entries in a networks.
Total frames received	Number of frames received from the neighbor network.
Total frames received in error	Number of frames not received from the neighbor network.
Total discarded TLVs	Number of TLVs discarded in transit.
Total unrecognised TLVs	Number of unrecognised TLVs in transit.

---

## snmp restart lldp

Use this command to restart SNMP in Link Layer Discovery Protocol (LLDP)

### Command Syntax

```
snmp restart lldp
```

### Parameters

None

### Command Mode

Configure mode

### Applicability

This command was introduced before OcNOS version 1.3.

### Examples

```
(config)#snmp restart lldp
```

# Data Center Bridging Command Reference





## CHAPTER 1 Priority-based Flow Control Commands

---

This section lists and describes the commands that can be used to configure Priority-based Flow Control (PFC) in a Data Center Bridging (DCB) environment. It includes the following commands:

- [priority-flow-control accept-peer-config](#)
- [priority-flow-control advertise-local-config](#)
- [priority-flow-control enable](#)
- [priority-flow-control cap](#)
- [priority-flow-control enable priority](#)
- [priority-flow-control link-delay-allowance](#)
- [priority-flow-control mode](#)
- [show priority-flow-control details](#)
- [show priority-flow-control statistics](#)

---

## priority-flow-control accept-peer-config

Use this command to enable willing mode for PFC on the interface.  
If willing is enabled, then by default advertise mode is also enabled.  
Use the `no` form of this command to disable willing mode.

### Command Syntax

```
priority-flow-control accept-peer-config  
no priority-flow-control accept-peer-config
```

### Parameters

None

### Default

By default, willing mode for PFC on the interface is disabled. If willing is enabled, then by default advertise mode is also enabled.

### Command Mode

Interface mode

### Applicability

This command was introduced before OcNOS version 1.3.

### Examples

```
#configure terminal  
(config)#interface eth1  
(config-if)#priority-flow-control accept-peer-config
```

---

## priority-flow-control advertise-local-config

Use this command to enable advertising mode for PFC on the interface.

Use the `no` form of this command to disable advertising mode.

### Command Syntax

```
priority-flow-control advertise-local-config
no priority-flow-control advertise-local-config
```

### Parameters

None

### Default

By default, advertising mode for PFC on the interface is disabled. If `willing` is enabled, then by default advertise mode is also enabled.

### Command Mode

Interface mode

### Applicability

This command was introduced before OcNOS version 1.3.

### Examples

```
#configure terminal
(config)#interface eth1
(config-if)#priority-flow-control advertise-local-config
```

---

## priority-flow-control enable

Use this command to enable Priority-based Flow Control (PFC) on a switch (bridge).

Use the `no` form of this command to disable PFC.

### Command Syntax

```
priority-flow-control enable bridge <1-32>
no priority-flow-control bridge <1-32>
```

### Parameters

<1-32>                      Bridge ID.

### Default

By default, PFC is disabled.

### Command Mode

Configure mode

### Default

PFC is disabled by default.

### Applicability

This command was introduced before OcNOS version 1.3.

### Example

```
#configure terminal
(config)#priority-flow-control enable bridge 32

#configure terminal
(config)#no priority-flow-control bridge 32
```

---

## priority-flow-control cap

Use this command to configure a priority-flow-control cap for the number of priorities allowed on an interface.

Use the `no` parameter along with this command to return the value to its default level.

### Command Syntax

```
priority-flow-control cap <0-8>
no priority-flow-control cap
```

### Parameters

<0-8>                      Select a cap value. Zero indicates that there is no limitations.

### Default

By default, priority-flow-control cap value is 8.

### Command Mode

Interface mode

### Applicability

This command was introduced before OcNOS version 1.3.

### Examples

```
#configure terminal
(config)#interface eth2
(config-if)#priority-flow-control cap 7
```

---

## priority-flow-control enable priority

Use this command to enable the PFC at the interface level for a specific priority.

Use the `no` parameter along with this command to disable PFC for a priority.

### Command Syntax

```
priority-flow-control enable priority <0-7> (<0-7>(<0-7>(<0-7> (<0-7>(<0-7>(<0-7>(<0-7>|)|)|)|)|)|)
```

```
no priority-flow-control enable priority <0-7> (<0-7>(<0-7>(<0-7>(<0-7>(<0-7>(<0-7>(<0-7>|)|)|)|)|)|)
```

### Parameter

<0-7> Traffic-priority value. You can specify up to seven priorities.

### Default

None

### Command Mode

Interface mode

### Default

PFC is disabled by default.

### Applicability

This command was introduced before OcnOS version 1.3.

### Examples

```
(config)#interface eth1
(config-if)#priority-flow-control enable priority 1 2 3 4 5 6 7

(config)#interface eth1
(config-if)#no priority-flow-control enable priority 2 3 4
```

---

## priority-flow-control link-delay-allowance

Use this command to set PFC link delay allowance on an interface. This command provides allowance for round-trip propagation delay of the link in bits; moreover, it is one of the factors that determines when to trigger PAUSE.

Use the `no` parameter along with this command to unset PFC link delay allowance on an interface.

### Command Syntax

```
priority-flow-control link-delay-allowance <0-65535>
no priority-flow-control link-delay-allowance
```

### Parameter

<0-65535>            Link characteristics that affect the link delay (for example, link length).

### Command Mode

Interface mode

### Default

Default value is zero.

### Applicability

This command was introduced before OcnOS version 1.3.

### Example

```
#configure terminal
(config)#interface eth1
(config-if)#priority-flow-control link-delay-allowance 5

(config)#interface eth1
(config-if)#no priority-flow-control link-delay-allowance
```

---

## priority-flow-control mode

Use this command to enable Priority-based Flow Control (PFC) on an interface.

Use the `no` form of this command to disable PFC on an interface.

### Command Syntax

```
priority-flow-control mode (on | auto)
no priority-flow-control
```

### Parameters

<code>auto</code>	Negotiate PFC capabilities.
<code>on</code>	Force-enable PFC, overriding negotiation.

### Default

By default, PFC is disabled.

### Command Mode

Interface mode

### Default

PFC is disabled by default.

### Applicability

This command was introduced before OcnOS version 1.3.

### Example

```
#configure terminal
(config)#interface eth1
(config-if)#priority-flow-control mode auto
```



## show priority-flow-control details

Use this command to display the PFC details for a specified interface or bridge.

### Command Syntax

```
show priority-flow-control details ((interface IFNAME) | (bridge <1-32>))
```

### Parameters

IFNAME	Name of the input or output interface.
<1-32>	Specify a bridge ID.

### Default

None

### Command Mode

Exec mode

### Applicability

This command was introduced before OcNOS version 1.3.

### Example

```
#show priority-flow-control details interface eth1
bridge : 2
priority flow control : on
interface : eth1
```

Admin Configuration

```
mode  advertise willing  cap  link      priorities
      delay
      allowance
```

```
=====
on    on          off    5      128      2 3 4 5
```

Operational Configuration

```
state cap  link      priorities
      delay
      allowance
```

```
=====
on    5      128      2 3 4 5
```

**Table 1-31: Show priority-flow control details output**

Entry	Description
bridge	The bridge number to which this interface is associated (1-32).
priority flow control	Show whether priority flow control is either <code>on</code> or <code>off</code> .

**Table 1-31: Show priority-flow control details output (Continued)**

<b>Entry</b>	<b>Description</b>
interface	The interface name.
Admin Configuration	The configuration as entered on this device.
mode	The priority flow control operating mode – <i>on</i> , <i>off</i> , or <i>auto</i> .
advertise	Status of advertisement of the configuration to the peer device.
willing	The willingness of the local interface to learn the PFC configuration from the peer. Values are either <i>on</i> or <i>off</i> .
cap	Cap is a limit set that specifies the maximum number of PFC priorities.
link delay allowance	The allowance made for round-trip propagation delay of the link in bits.
Priorities	Shows the PFCs that have been to be used on the priorities.
Operational Configuration	The actual configuration that exists between this device and its PFC peer.
state	Shows whether PFC is functioning. Values are <i>on</i> , <i>off</i> , or <i>auto</i> .
cap	Cap is the limit that specifies the maximum number of PFC priorities.
link delay allowance	The allowance being used for round-trip propagation delay of the link in bits.
priorities	The PFCs actually being used by this device and its peer.

---

## show priority-flow-control statistics

Use this command to display statistics about the number of PFC Pause frames sent and received for a specified interface or bridge. If you do not specify a bridge or interface, this command shows statistics for the bridge.

### Command Syntax

```
show priority-flow-control statistics ((interface IFNAME) | (bridge <1-32>))
```

### Parameters

<1-32>	Specify bridge ID.
IFNAME	Name of the input or output interface.

### Default

None

### Command Mode

Exec mode

### Applicability

This command was introduced before OcnOS version 1.3.

### Example

```
#show priority-flow-control statistics interface eth1
bridge : 2
interface : eth1
pause sent      pause received
=====
59680614996248372055834574861
```



---

# Index

## Numerics

### 802.1x Commands

- auth-mac auth-fail-action 472
- auth-mac dynamic-vlan-creation disable 474
- auth-mac enable 475
- auth-mac system-auth-ctrl 477
- debug dot1x 478
- dot1x initialize interface 479
- dot1x port-control 481
- dot1x protocol-version 482
- dot1x quiet-period 483
- dot1x reauthentication 485
- dot1x reauthMax 484
- dot1x system-auth-ctrl 486
- dot1x timeout re-authperiod 487
- dot1x timeout server-timeout 488
- dot1x timeout supp-timeout 489
- dot1x timeout tx-period 490
- ip radius source-interface 491
- radius-server deadtime 492
- radius-server host 493
- radius-server key 495
- radius-server retransmit 496
- radius-server timeout 497
- show debugging dot1x 498
- show dot1x 499

## A

- authentication 27
- auth-mac auth-fail-action 472
- auth-mac dynamic-vlan-creation disable 474
- auth-mac enable 475
- auth-mac system-auth-ctrl 477

## B

- begin modifier 20
- BGP community value
  - command syntax 18
- braces
  - command syntax 17
- bridge acquire 272
- bridge address 273
- bridge ageing-time 274
- bridge cisco-interoperability 301
- Bridge commands
  - bridge acquire 272
  - bridge address 273
  - bridge ageing-time 274
  - bridge protocol mstp 307
  - bridge protocol rstp 308
  - clear mac address-table 287
  - show interface switchport bridge 292

- switchport 297
- bridge forward-time 275
- bridge instance priority 303
- bridge max-age 278
- bridge max-hops 279
- bridge multiple-spanning-tree enable 305
- bridge priority 280
- bridge protocol mstp 307
- bridge protocol provider-rstp 517
- bridge protocol rpvst+ 373
- bridge protocol rstp 308
- bridge rapid-spanning-tree enable 310
- bridge region 311
- bridge revision 312
- bridge shutdown 281
- bridge spanning-tree enable 313
- bridge spanning-tree errdisable-timeout enable 314
- bridge spanning-tree portfast bpdu-filter 317
- bridge te-msti 319
- bridge transmit-holdcount 282
- bridge-group instance 320
- bridge-group instance path-cost 321
- bridge-group path-cost 284
- bridge-group priority 285
- bridge-group vlan 372

## C

- clear mac address-table 287
- clear spanning-tree detected protocols 326
- command abbreviations 16
- command completion 16
- command line
  - errors 16
  - help 15
  - keyboard operations 19
- command modes 23
  - configure 23
  - exec 23
  - interface 23
  - privileged exec 23
  - router 23
- command negation 17
- command syntax
  - ? 18
  - . 18
  - () 17
  - { } 17
  - | 17
  - A.B.C.D/M 18
  - AA:NN 18
  - BGP community value 18
  - braces 17
  - conventions 17
  - curly brackets 17
  - HH:MM:SS 18
  - IFNAME 18
  - interface name 18
  - IPv4 address 18

---

- IPv6 address 18
- LINE 18
- lowercase 17
- MAC address 18
- monospaced font 17
- numeric range 18
- parentheses 17
- parenteses 17
- period 18
- question mark 18
- square brackets 18
- time 18
- uppercase 17
- variable placeholders 18
- vertical bars 17
- WORD 18
- X:X::X:X 18
- X:X::X:X/M 18
- XX:XX:XX:XX:XX:XX 18
- common commands
  - errdisable 260
  - errdisable timeout 262
- Common NSM Layer 2 commands
  - storm-control level 363
- configuration
  - disable spanning tree 27
- configure
  - 802.1x authentication 27
  - LACP 27
  - LLDP 27
  - MSTP 27
  - Provider Bridging 27
  - RSTP 27
  - STP 27
- configure mode 23
- Configuring port Breakout 38
- Configuring port Breakout(100G to 4x10G) 38
- curly brackets
  - command syntax 17
- customer-spanning-tree customer-edge path-cost 328
- customer-spanning-tree customer-edge priority 329
- customer-spanning-tree forward-time 330
- customer-spanning-tree hello-time 331
- customer-spanning-tree max-age 332
- customer-spanning-tree priority 333
- customer-spanning-tree provider-edge path-cost 334
- customer-spanning-tree provider-edge priority 335
- customer-spanning-tree transmit-holdcount 336
- cvlan registration table 518
- cvlan svlan 519

## D

- debug dot1x 478
- debug lacp command 387
- debug mcec 417
- debug mstp 337
- disable spanning tree
  - configuration 27

- spanning-tree te-msti configuration 362
- domain hello timeout 419
- domain priority 420
- domain system number 421
- domain-address 418
- dot1x initialize interface 479
- dot1x port-control 481
- dot1x protocol-version 482
- dot1x quiet-period 483
- dot1x reauthentication 485
- dot1x reauthMax 484
- dot1x system-auth-control 486
- dot1x timeout re-authperiod 487
- dot1x timeout server-timeout 488
- dot1x timeout supp-timeout 489
- dot1x timeout tx-period 490
- DRNI 27

## E

- errdisable 260
- errdisable timeout 262
- exec command mode 23

## I

- IEEE 802.1x 27
- IFNAME 18
- interface mode 23
- interface po 388
- interface sa 389
- intra-domain-link 422
- ip radius source-interface 491
- IPv4 address
  - command syntax 18
- IPv6 address
  - command syntax 18

## L

- LACP
  - configuring 27
- LACP Commands
  - debug lacp 387
  - lacp port-priority 392
  - lacp system-priority 393
  - lacp timeout 394
  - show debugging lacp 400
  - show lacp-counter 405
  - show port etherchannel 406
  - static-channel-group 412
- LACP commands
  - port-channel load-balance 395
- lacp destination-mac 390
- lacp port-priority command 392
- lacp system-priority command 393
- lacp timeout command 394
- LINE 18
- Link aggregation 27



---

**LLDP commands**

- lldp system-name 564
- set lldp disable 555
- set lldp enable 555
- set lldp locally-assigned 558
- set lldp msg-tx-hold 559
- set lldp msg-tx-interval 561, 564
- set lldp too-many-neighbors 565
- show lldp port 566
- lldp system-name 564

**M****MAC address**

- command syntax 18
- mcec domain configuration 424
- MC-LAG 27
- MC-LAG Configuration 27
- mlag 425
- MSTP
  - configuring 27

**N****NSM Commands**

- show router-id 263

**P****parentheses**

- command syntax 17

**parentheses**

- command syntax 17

**period**

- command syntax 18

**PFC commands**

- priority-flow-control accept-peer-config 576
- priority-flow-control link-delay-allowance 581
- priority-flow-control mode 582
- show priority-flow-control details 583
- PFC priority-flow-control advertise-local-config 577
- Policy Based Routing Configuration 27
- Port 27
- port 397, 399
- Port Breakout Configuration 27
- portal-system-number 429
- portal-topology 429
- port-channel load-balance 395
- port-channel min-links 397, 399
- port-conv-id 429
- privileged exec mode 23
- Provider Bridging commands
  - bridge protocol provider-rstp 517
  - cvlan registration table 518
  - cvlan svlan 519
  - switchport customer-edge 523
  - switchport customer-edge hybrid allowed vlan 524
  - switchport customer-edge vlan registration 526
  - switchport mode customer-edge access 530

vlan type 536

## Q

question mark  
command syntax 18

## R

radius-server deadtime 492  
radius-server host 493  
radius-server key 495  
radius-server retransmit 496  
radius-server timeout 497  
router mode 23  
RPVST+ commands  
bridge protocol rpvst+ 373  
bridge-group vlan 372  
spanning-tree rpvst+ configuration 379  
spanning-tree vlan path-cost 380  
spanning-tree vlan restricted-role 380  
spanning-tree vlan restricted-tcn 381

## S

set lldp disable 555  
set lldp enable 555  
set lldp locally-assigned 558  
set lldp msg-tx-hold 559  
set lldp msg-tx-interval 561, 564  
set lldp too-many-neighbors 565  
show commands 20  
exclude modifier 21  
include modifier 21  
redirect modifier 22  
show debugging dot1x 498  
show debugging lacp command 400  
show debugging mstp 339  
show dot1x 499  
show errdisable details 263  
show interface errdisable status 264  
show interface switchport bridge 292  
show lacp-counter command 405  
show lldp interface 570  
show lldp port 566  
show mac address-table count bridge 294  
show mcec statistics 427  
show mlag conversation-id 429  
show mlag detail 429  
show mlag summary 431  
show port etherchannel command 406  
show router-id 263  
show running-config switch 265  
show spanning-tree 340  
show spanning-tree mst 344  
show spanning-tree statistics 346  
show vlan access-map 439  
show vlan all 440  
show vlan auto 442

---

- show vlan brief 442
- show vlan classifier 443
- snmp restart mstp 349
- spanning-tree autoedge 350
- spanning-tree edgeport 351
- spanning-tree guard root 352
- spanning-tree hello-time 353
- spanning-tree instance restricted-role 353
- spanning-tree instance restricted-tcn 354
- spanning-tree link-type 355
- spanning-tree mst configuration 356
- spanning-tree restricted-role 360
- spanning-tree restricted-tcn 361
- spanning-tree spvts+ configuration 379
- spanning-tree te-msti configuration 362
- spanning-tree vlan path-cost 380
- spanning-tree vlan restricted-role 380
- spanning-tree vlan restricted-tcn 381
- square brackets
  - command syntax 18
- static-channel-group 412
- storm-control level 363
- STP
  - configuring 27
- STP commands
  - bridge cisco-interoperability 301
  - bridge forward-time 275
  - bridge instance priority 303
  - bridge max-age 278
  - bridge max-hops 279
  - bridge multiple-spanning-tree enable 305
  - bridge priority 280
  - bridge rapid-spanning-tree enable 310
  - bridge region 311
  - bridge revision 312
  - bridge shutdown 281
  - bridge spanning-tree enable 313
  - bridge spanning-tree errdisable-timeout enable 314
  - bridge spanning-tree portfast bpdu-filter 317
  - bridge transmit-holdcount 282
  - bridge-group path-cost 284
  - bridge-group priority 285
  - clear spanning-tree detected protocols 326
  - customer-spanning-tree customer-edge path-cost 328
  - customer-spanning-tree customer-edge priority 329
  - customer-spanning-tree forward-time 330
  - customer-spanning-tree hello-time 331
  - customer-spanning-tree max-age 332
  - customer-spanning-tree priority 333
  - customer-spanning-tree provider-edge path-cost 334
  - customer-spanning-tree provider-edge priority 335
  - customer-spanning-tree transmit-holdcount 336
  - debug mstp 337
  - show debugging mstp 339
  - show spanning-tree 340
  - show spanning-tree mst 344
  - show spanning-tree statistics 346
  - spanning-tree autoedge 350
  - spanning-tree edgeport 351

- spanning-tree guard root 352
- spanning-tree hello-time 353
- spanning-tree instance restricted-role 353
- spanning-tree instance restricted-tcn 354
- spanning-tree link-type 355
- spanning-tree mst configuration 356
- spanning-tree restricted-role 360
- spanning-tree restricted-tcn 361
- switchport 297
  - switchport access vlan 447
  - switchport customer-edge 523
  - switchport customer-edge hybrid allowed vlan 524
  - switchport customer-edge vlan registration 526
  - switchport hybrid allowed vlan 448
  - switchport mode access 451
  - switchport mode customer-edge access 530
  - switchport mode hybrid 452, 453
  - switchport mode trunk 454
  - switchport trunk allowed vlan 455
  - switchport trunk native vlan 458

## T

- time
  - command syntax 18
- Topology 27

## V

- vertical bars
  - command syntax 17
- vlan classifier ipv4 463
- VLAN commands
  - show vlan access-map 439
  - show vlan all 440
  - show vlan auto 442
  - show vlan brief 442
  - show vlan classifier 443
  - switchport access vlan 447
  - switchport hybrid allowed vlan 448
  - switchport mode access 451
  - switchport mode hybrid 452, 453
  - switchport mode trunk 454
  - switchport trunk allowed vlan 455
  - switchport trunk native vlan 458
  - vlan classifier ipv4 463
  - vlan database 465
  - vlan state 468
- vlan database command 465
- vlan state 468
- vlan type 536

## W

- WORD 18